

ITS Intertek Testing Services

Raytheon TI Systems

Testing
Performed
on the
Cellular Transceiver
Model No.: CELL-TRAC™ II

FCC Part 22 Type Acceptance

Date of Test: August 17, 1998 & September 16, 1998

LTO# J98023875

Date of Report: September 17, 1998

Total No. of Pages Contained in this Report: 21

All services undertaken are subject to the following general policy: Reports are submitted for exclusive use of the client to whom they are addressed. Their significance is subject to the adequacy and representative character of the samples and to the comprehensiveness of the tests, examinations or surveys made. No quotations from reports or use of Intertek Testing Services's name is permitted except as expressly authorized by Intertek Testing Services in writing.

FCC Part 22 Type Acceptance

i

Intertek Testing Services NA Inc.

1365 Adams Court, Menlo Park, CA 94025

Telephone 650-463-2900 Fax 650-463-2910 Home Page www.worldlab.com



ITS Intertek Testing Services

VERIFICATION OF COMPLIANCE

Report No. J98023875

Verification is hereby issued to the named APPLICANT and is VALID ONLY for the equipment tested hereon for use under the rules and regulations listed below

Equipment Under Test (EUT): Cellular Transceiver
Trade Name: Raytheon TI Systems
Model No.: CELL-TRAC™ II
Serial No.: Not Labelled
FCC ID:

Applicant: Raytheon TI Systems
Contact: Ron Cleveland/Curt Larsen
Address: 13532 N. Central Expwy.
Dallas, Texas 75243
Mail Stop 64

Tel. number: (972) 344-4350
Fax. number: (972) 344-3504

Applicable Regulation: FCC Part 22
Type Acceptance

SAR Exposure Class: N/A

Test Site Location: Intertek Testing Services
1365 Adams Court
Menlo Park, CA 94025, USA

Date of Test: August 17, 1998 & September 16, 1998

Based on the test results, the tested sample was found to be in compliance with FCC Part 22 requirements.

We attest to the accuracy of this report:

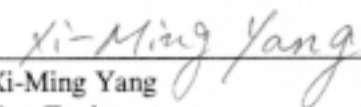

Xi-Ming Yang
Test Engineer

David Chernomordik
EMC Site Manager

Intertek Testing Services NA Inc.

1365 Adams Court, Menlo Park, CA 94025

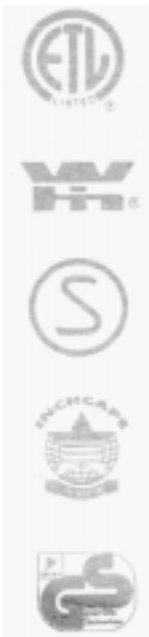
Telephone 650-463-2900 Fax 650-463-2910 Home Page www.worldlab.com



INTERTEK TESTING SERVICES

Raytheon TI Systems, Cellular Transceiver

Date of Test: Aug. 17, 1998 & Sept. 16, 1998

Table of Contents

1.0	Test Summary	1
1.2	Product Description	2
2.0	RF Power Output	3
2.1	Test Procedure	3
2.2	Test Equipment	3
2.3	Test Results	3
3.0	Effective Radiated Power	5
3.1	Test Procedure	5
3.2	Test Equipment	5
3.3	Test Results	5
4.0	Modulation Deviation Limiting	6
4.1	Test Procedure	6
4.2	Test Equipment	6
4.3	Test Results	6
5.0	Audio Filter Characteristics	9
5.1	Test Procedure	9
5.2	Test Equipment	10
5.3	Test Results	10
6.0	Emission Limitations, Occupied Bandwidth	12
6.1	Test Procedure	12
6.2	Test Equipment	13
6.3	Test Results	13
7.0	Out of Band Emissions at Antenna Terminals	15
7.1	Test Procedure	15
7.2	Test Equipment	15
7.3	Test Results	15
8.0	Field Strength of Spurious Radiation	17
8.1	Test Procedure	17
8.2	Test Equipment	17
8.3	Test Results	17
8.4	Test Configuration Setup	18
9.0	AC Line Conducted Emission	19
9.1	Test Procedure	19

INTERTEK TESTING SERVICES

Raytheon TI Systems, Cellular Transceiver

Date of Test: Aug. 17, 1998 & Sept. 16, 1998

9.2	Test Equipment	19
9.3	Test Results	19
10.0	Frequency Stability vs Temperature	20
10.1	Test Procedure	20
10.2	Test Equipment	20
10.3	Test Results	20
11.0	Frequency Stability vs Voltage	21
11.1	Test Procedure	21
11.2	Test Equipment	21
11.3	Test Results	21

INTERTEK TESTING SERVICES

Raytheon TI Systems, Cellular Transceiver

Date of Test: Aug. 17, 1998 & Sept. 16, 1998

1.0 Test Summary

FCC RULE	DESCRIPTION OF TEST	RESULT	PAGE
2.985	RF Power Output	Pass	3
22.913	Effective Radiated Power	Pass	4
2.987	Modulating Deviation Limiting	Pass	5
22.915(d)(1)	Audio Filter Characteristics	Pass	8
2.989(c) 22.917(b)(d)	Emission Limitations, Occupied Bandwidth	Pass	11
22.917(e) 22.917(f)	Out of Band Emissions at Antenna Terminals Mobile Emissions In Base Frequency Range	Pass	14
2.993	Field Strength of Spurious Radiation	Pass	16
15.109	AC Line Conducted Emission	N/A	-
2.995(a)	Frequency Stability vs. Temperature	Pass	19
2.995(d)(2)	Frequency Stability vs. Voltage	Pass	20

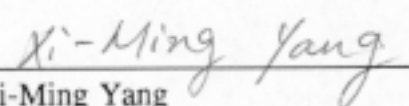
Xi-Ming Yang
Test Engineer

Date

INTERTEK TESTING SERVICES

Raytheon TI Systems, Cellular Transceiver

Date of Test: Aug. 17, 1998 & Sept. 16, 1998

1.2 Product Description

The Raytheon TI Systems Model No. CELL-TRACTM II is a cell phone with modem and GPS receiver for report vehicle position to data control center.

INTERTEK TESTING SERVICES

Raytheon TI Systems, Cellular Transceiver

Date of Test: Aug. 17, 1998 & Sept. 16, 1998

2.0 RF Power Output

Requirements: FCC Part 2.985(a)

2.1 Test Procedure

The antenna was removed and a TNC connector was connected to the transmitter output. The transmitter output was connected to a calibrated coaxial attenuator (50 ohm), the other end of which was connected to a spectrum analyzer. Transmitter output was read off the spectrum analyzer in dBm. The power output at the transmitter was determined by adding the value of the attenuator to the spectrum analyzer reading.

A power meter was connected to the transmitter output and its reading was compared to the spectrum analyzer data. The meter reading was 0.3 dB less than the spectrum analyzer reading.

The test was performed at three frequencies (low, middle, and high channels) and on all power levels which can be setup on the transmitter.

2.2 Test Equipment

Hewlett Packard HP8566B Spectrum Analyzer

Hewlett Packard HP 7470A Plotter

Hewlett Packard HP 435A Power Meter

2.3 Test Results

Refer to the attached plots: 2.3.a - 2.3.c and data sheet

INTERTEK TESTING SERVICES

Raytheon TI Systems, Cellular Transceiver

Date of Test: Aug. 17, 1998 & Sept. 16, 1998

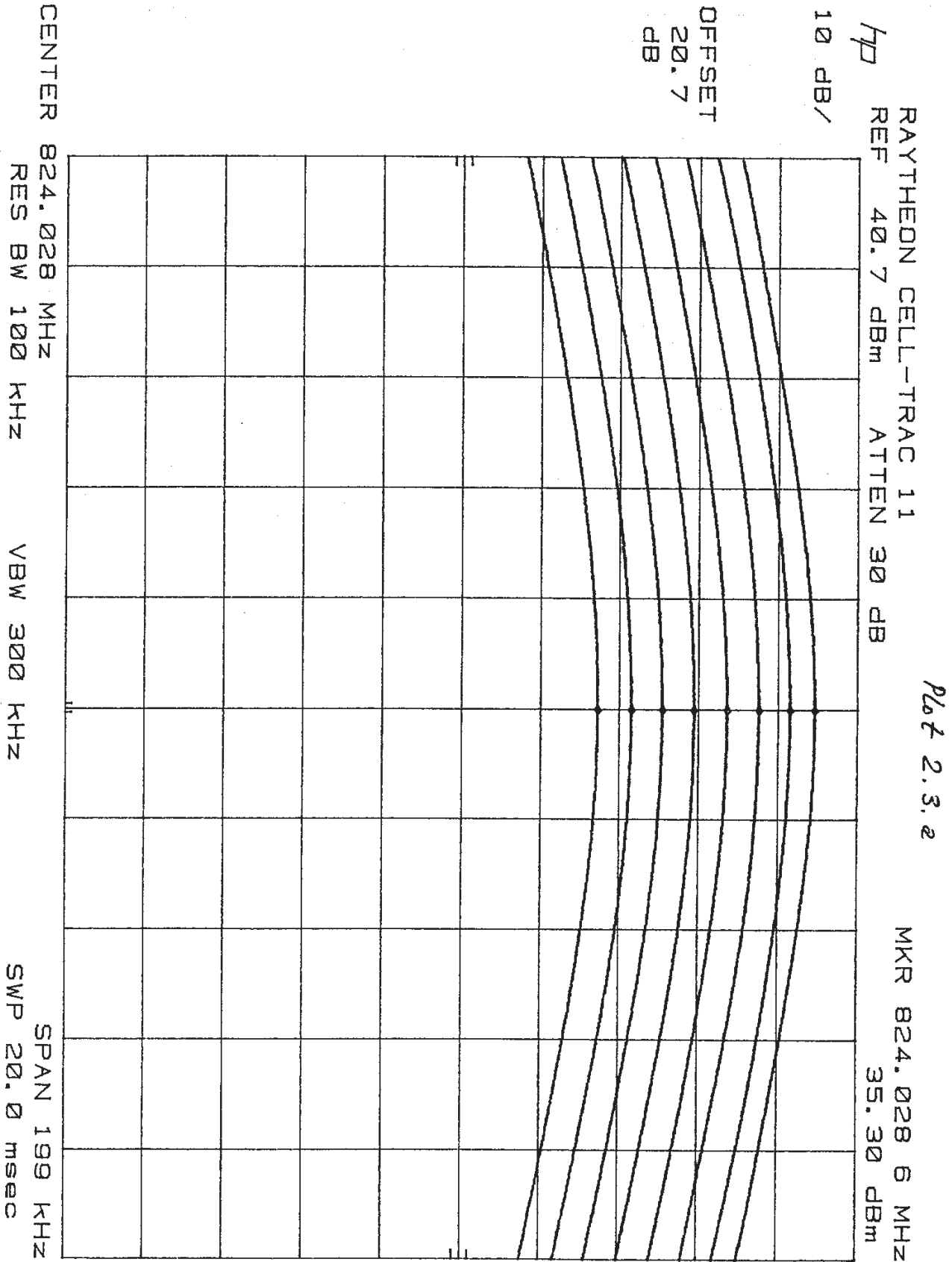

INTERTEK TESTING SERVICES

Raytheon TI Systems, Cellular Transceiver

Date of Test: Aug. 17, 1998 & Sept. 16, 1998

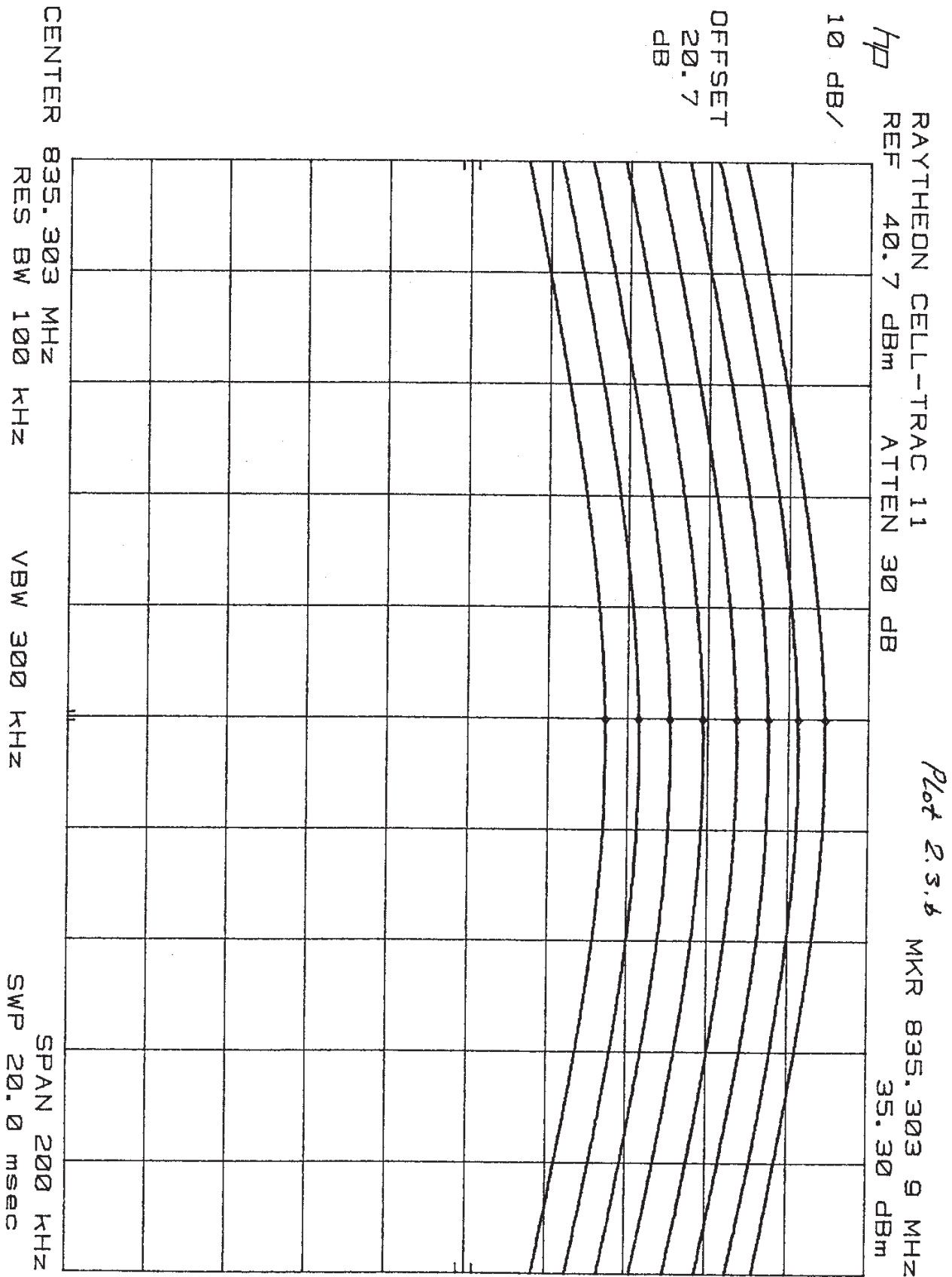

INTERTEK TESTING SERVICES

Raytheon TI Systems, Cellular Transceiver

Date of Test: Aug. 17, 1998 & Sept. 16, 1998

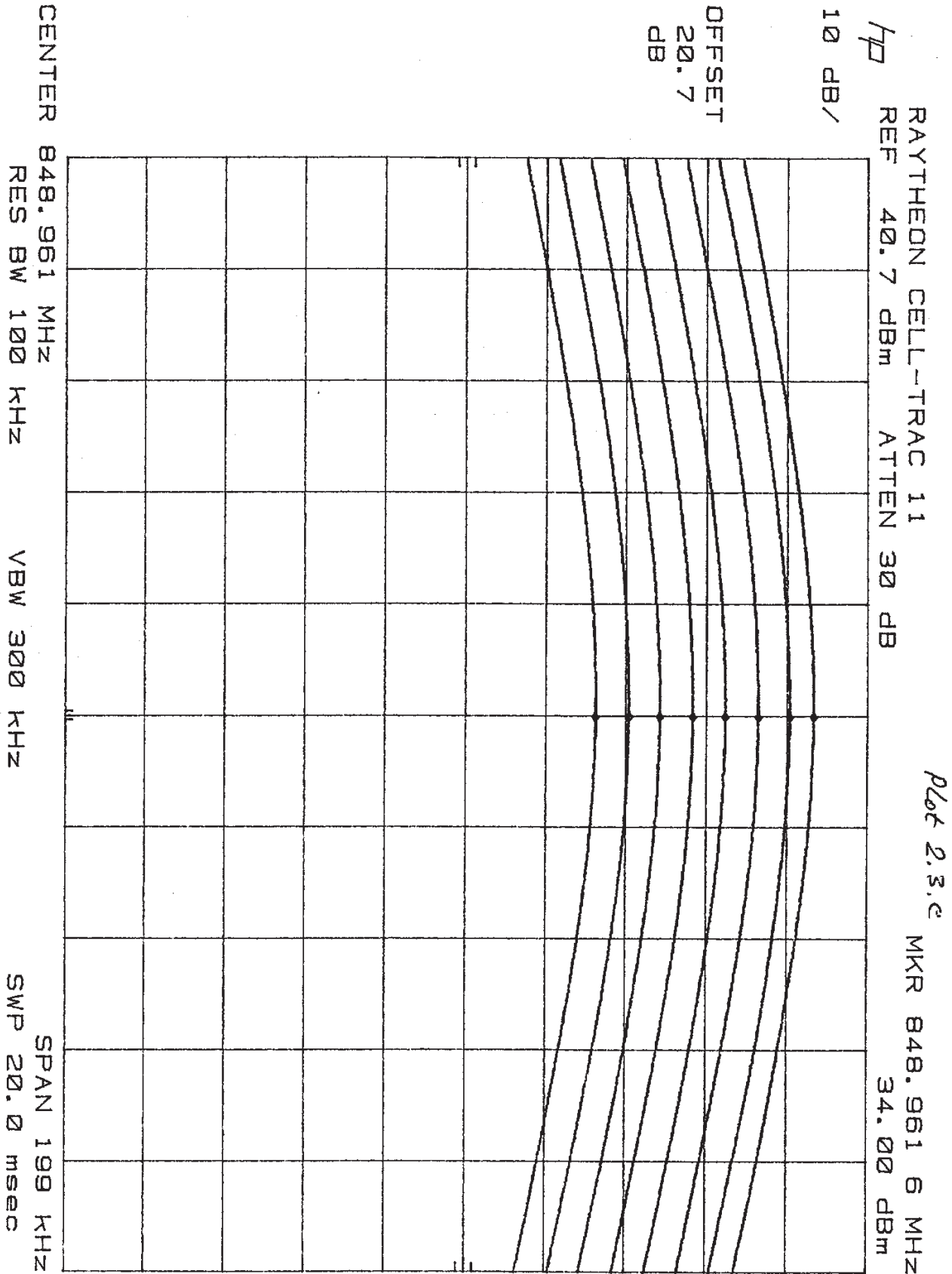

INTERTEK TESTING SERVICES

Raytheon TI Systems, Cellular Transceiver

Date of Test: Aug. 17, 1998 & Sept. 16, 1998

Level	Output Power, dBm		
	835.32 MHz Channel 344	824.04 MHz Channel 991	848.97 MHz Channel 799
0	35.3	35.3	34.0
1	31.9	32.2	31.0
2	28.2	28.3	27.1
3	24.3	24.3	23.0
4	20.1	20.2	19.0
5	16.0	16.1	14.9
6	12.1	12.2	11.1
7	7.9	7.9	6.9

INTERTEK TESTING SERVICES

Raytheon TI Systems, Cellular Transceiver

Date of Test: Aug. 17, 1998 & Sept. 16, 1998

3.0 Effective Radiated Power

Requirements: FCC 22.913

The Effective Radiated Power (ERP) of mobile transmitters and auxiliary test transmitters must not exceed 7 Watts.

3.1 Test Procedure

The EUT was positioned on a non-conductive turntable, 0.8m above the ground plane on an open test site.

The radiated emission at the fundamental frequency was measured at 3m distance with a test antenna and spectrum analyzer. During the measurement, the resolution and video bandwidths of the spectrum analyzer were set to 100 kHz. Worst case emission was recorded with the rotation of the turntable and the raising and lowering of the test antenna. The spectrum analyzer reading was recorded.

The ERP was calculated as follows:

$$\text{ERP(dBm)} = \text{E(dBuV/m)} + 20 \log D - 10 \log 30 - 10 \log G - 90$$

Where $G = 1.64$ is the gain of half-wave dipole

The test was performed at three frequencies (low, middle, and high channels).

In addition, the Equivalent Isotropic Radiated Power (EIRP) in dBpW was calculated as follows:

$$\text{EIRP(dBpW)} = \text{ERP(dBm)} + 90 + 10 \log 1.64$$

3.2 Test Equipment

Rhode & Schwartz SMH Signal Generator
Hewlett Packard HP8566B Spectrum Analyzer
CDI Roberts Antenna

3.3 Test Results

Refer to the attached data sheet. The EUT passed the test.

ITS Intertek Testing Services

Company: Raytheon Systems company

Project #:

Model:

Engineer: Xi-Ming Yang

Date of Text: August 17, 1998

FCC Part 22 Radiated Emissions

Frequency	Antenna Polarity	Reading	Antenna Factor	Pre-amp	Cable Loss	Corrected Reading	EIRP	ERP
MHz	H/V	dB(uV)	dB(1/m)	dB	dB	dB(uV/m)	dB(pW)	dBm
824.1	V	109.3	22.4	0.0	2.2	133.9	128.7	36.5
836.5	V	108.0	22.4	0.0	2.2	132.6	127.4	35.2
849.0	V	107.0	22.4	0.0	2.2	131.6	126.4	34.2

Note: 1. All measurement were made at 3 meters

INTERTEK TESTING SERVICES

Raytheon TI Systems, Cellular Transceiver

Date of Test: Aug. 17, 1998 & Sept. 16, 1998

4.0 Modulation Deviation Limiting

Requirements: FCC 2.987, 22.915(c)s

4.1 Test Procedure

The RF output of the transceiver was connected to the input of an FM deviation meter through sufficient attenuation so as not to overload the meter or distort the readings. An audio signal generator with a variable attenuator on the output connected to the pins 2 and 1 of the headphone connector pads.

At three different modulating frequencies, the output level of the audio generator was varied and the FM deviation level was recorded (Table 4.1.a).

The audio input was adjusted for 8 kHz deviation at 1 kHz tone with the 2:1 compressor enabled and the SAT disabled. The audio input was increased by 20 dB in one step. Both the initial and the subsequent steady state values of the peak frequency deviation, at and following the time of the 20 dB increase, were measured and recorded in the frequency range 300 Hz - 3 kHz (Table 4.1.b).

4.2 Test Equipment

Rhode & Schwartz ESVP (in FM deviation measurement mode)
Marconi 2955A Radio Communication Test Set
Leader LFG-1300S Function Generator
LMV-182 AC Millivoltmeter

4.3 Test Results

The EUT passed the test.

INTERTEK TESTING SERVICES

Raytheon TI Systems, Cellular Transceiver

Date of Test: Aug. 17, 1998 & Sept. 16, 1998

Table 4.1a
Modulation Limiting

Output Level (mV)	FM Deviation In kHz At Indicated Modulating Frequency		
	3000 Hz	1000 Hz	300 Hz
1	2.3	1.3	0.5
2	3.3	1.8	0.6
5	5.2	2.9	0.9
10	7.0	4.1	1.2
20	7.0	5.7	1.6
40	7.0	7.9	2.1
60	7.0	9.7	2.6
80	7.0	10.3	3.0
100	7.0	10.4	3.5
160	7.0	11.1	5.8
200	7.0	10.7	6.2
300	7.0	9.8	5.9
500	7.0	9.4	5.1
600	7.0	9.2	5.0
800	7.0	9.1	4.7
1000	7.0	9.1	4.6

INTERTEK TESTING SERVICES

Raytheon TI Systems, Cellular Transceiver

Date of Test: Aug. 17, 1998 & Sept. 16, 1998

Table 4.1b
Peak Frequency Deviation

Frequency kHz	Initial Deviation	Peak Deviation	Steady State Deviation
0.3	2.3	11.2	5.3
0.5	4.0	11.2	11.1
0.7	5.7	10.4	10.2
0.9	7.1	9.8	9.8
1.0	7.1	9.6	9.4
1.2	9.2	10.0	8.0
1.4	10.0	10.1	9.4
1.6	10.1	10.1	9.5
1.8	10.2	10.2	9.8
2.0	10.3	10.3	10.1
2.4	10.5	10.5	10.3
2.8	8.6	8.6	8.6
3.0	6.9	7.1	7.0

Test Conditions:

$V_{inp} = 45 \text{ mV}$

Deviation = 8 kHz at modulation frequency 1 kHz

Middle Channel $f = 835.32 \text{ MHz}$

INTERTEK TESTING SERVICES

Raytheon TI Systems, Cellular Transceiver

Date of Test: Aug. 17, 1998 & Sept. 16, 1998

5.0 Audio Filter Characteristics

Requirements: FCC 22.915(d)

For mobile stations, these signals must be attenuated, relative to the level at 1 kHz, as follows:

- (i) In the frequency ranges of 3.0 to 5.9 kHz and 6.1 to 15.0 kHz, signals must be attenuated by at least $40 \log(f/3)$ dB, where f is the frequency of the signal in kHz.
- (ii) In the frequency range of 5.9 to 6.1 kHz, signals must be attenuated at least 35 dB.
- (iii) In the frequency range above 15 kHz, signals must be attenuated at least 28 dB.

5.1 Test Procedure

The RF output of the transceiver was connected to the input of an FM deviation meter through sufficient attenuation so as not to overload the meter or distort the readings.

The measurements were performed using the block diagram of the test setup shown below.

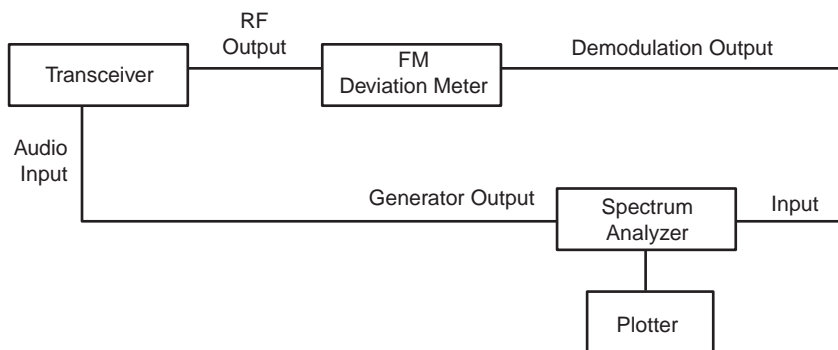

INTERTEK TESTING SERVICES

Raytheon TI Systems, Cellular Transceiver

Date of Test: Aug. 17, 1998 & Sept. 16, 1998

On that block diagram, the HP 3885A spectrum analyzer having the tracing generator, and the Marconi 2955A Radio Communication Test Set having an output of a demodulator, are used. After the calibration was made (the -20 dBm reading of the spectrum analyzer corresponds to the 9 kHz deviation) the spectrum analyzer was set to scan the frequency from 300 Hz to 30 kHz, with the same audio input level as described above.

The audio filter response was plotted directly from the spectrum analyzer (Refer to Plots # 5.1.a, 5.1.b, & 5.1.c).

The relative level was obtained from the plots and the attenuation was calculated with reference to the level at 1 kHz.

5.2 Test Equipment

Rohde & Schwartz ESVP (in FM deviation measurement mode)

Marconi Instruments 2955A Radio Communications Test Set

HP 3588A Spectrum Analyzer

HP 7470A Plotter

Leader LFG-1300S Function Generator

LMV-182 AC Millivoltmeter

5.3 Test Results

The EUT passed the test.

INTERTEK TESTING SERVICES

Raytheon TI Systems, Cellular Transceiver

Date of Test: Aug. 17, 1998 & Sept. 16, 1998

Table 5.1 Audio Filter Characteristics		
Modulation Frequency kHz	Relative Level dBm	Attenuation dB
0.3	-38.3	10.2
0.4	-35.5	7.4
0.5	-34.0	5.9
0.6	-32.3	4.2
0.7	-30.9	2.8
0.8	-29.7	1.6
0.9	-28.7	0.6
1.0	-28.1	0
1.2	-26.7	-1.4
1.4	-25.7	-2.4
1.6	-24.5	-3.6
1.8	-23.5	-4.6
2.0	-22.2	-5.9
2.5	-19.9	-8.2
2.6	-19.8	-8.3
3.0	-21.7	-6.4
3.2	-23.1	-5.0
3.5	-32.9	4.8
4.5	-67.7	39.6
5.0	-66.8	38.7
5.5	-65.0	36.9
5.9	-67.7	39.6
6.0	-67.0	38.9
6.1	-68.4	40.3
8.0	-73.7	45.6
10.0	-68.4	40.3
15.0	-78.6	50.5
20.0	-89.1	61.0
30.0	-96.2	68.1

Deviation 0.2 kHz is the noise floor.

INTERTEK TESTING SERVICES

Raytheon TI Systems, Cellular Transceiver

Date of Test: Aug. 17, 1998 & Sept. 16, 1998

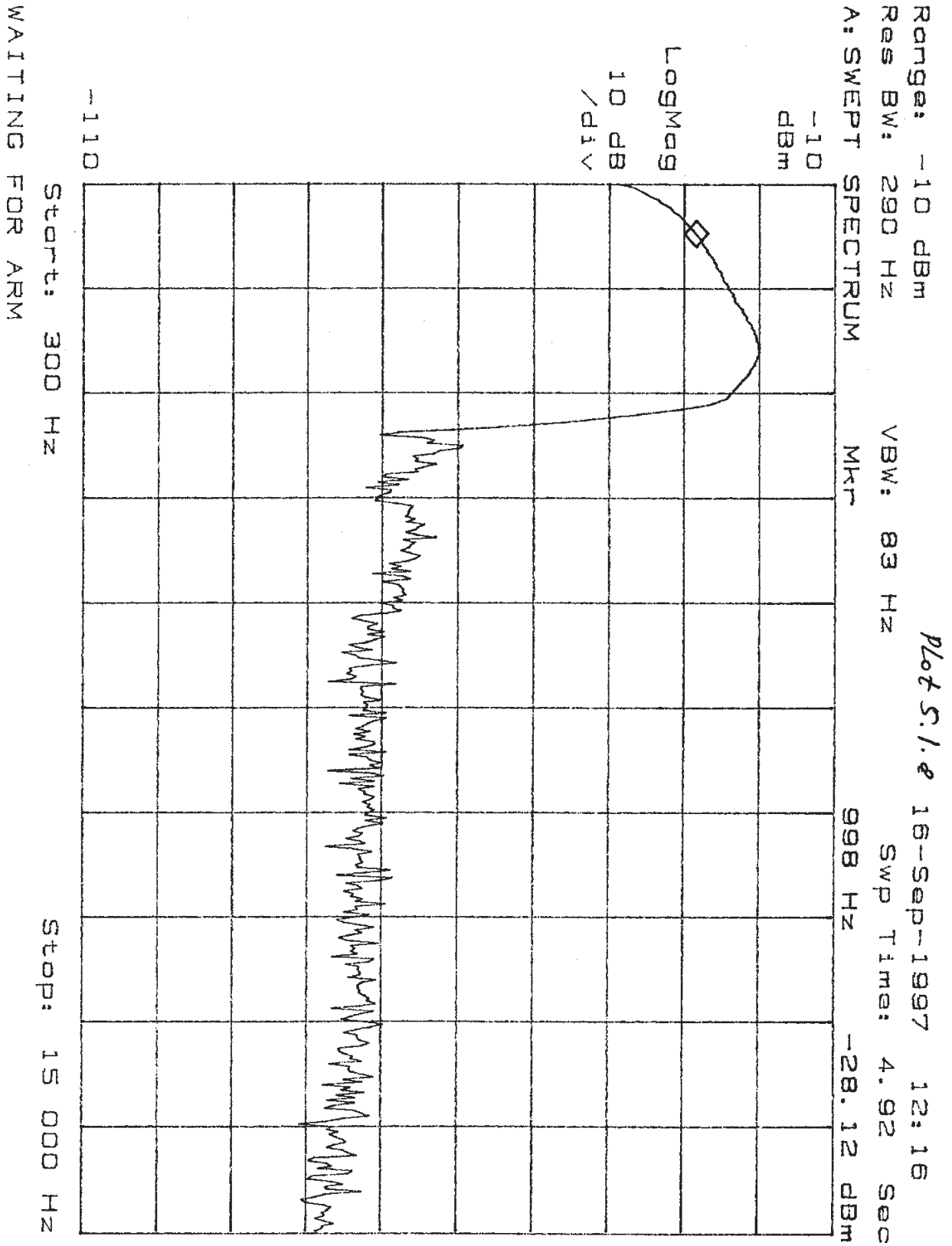

INTERTEK TESTING SERVICES

Raytheon TI Systems, Cellular Transceiver

Date of Test: Aug. 17, 1998 & Sept. 16, 1998

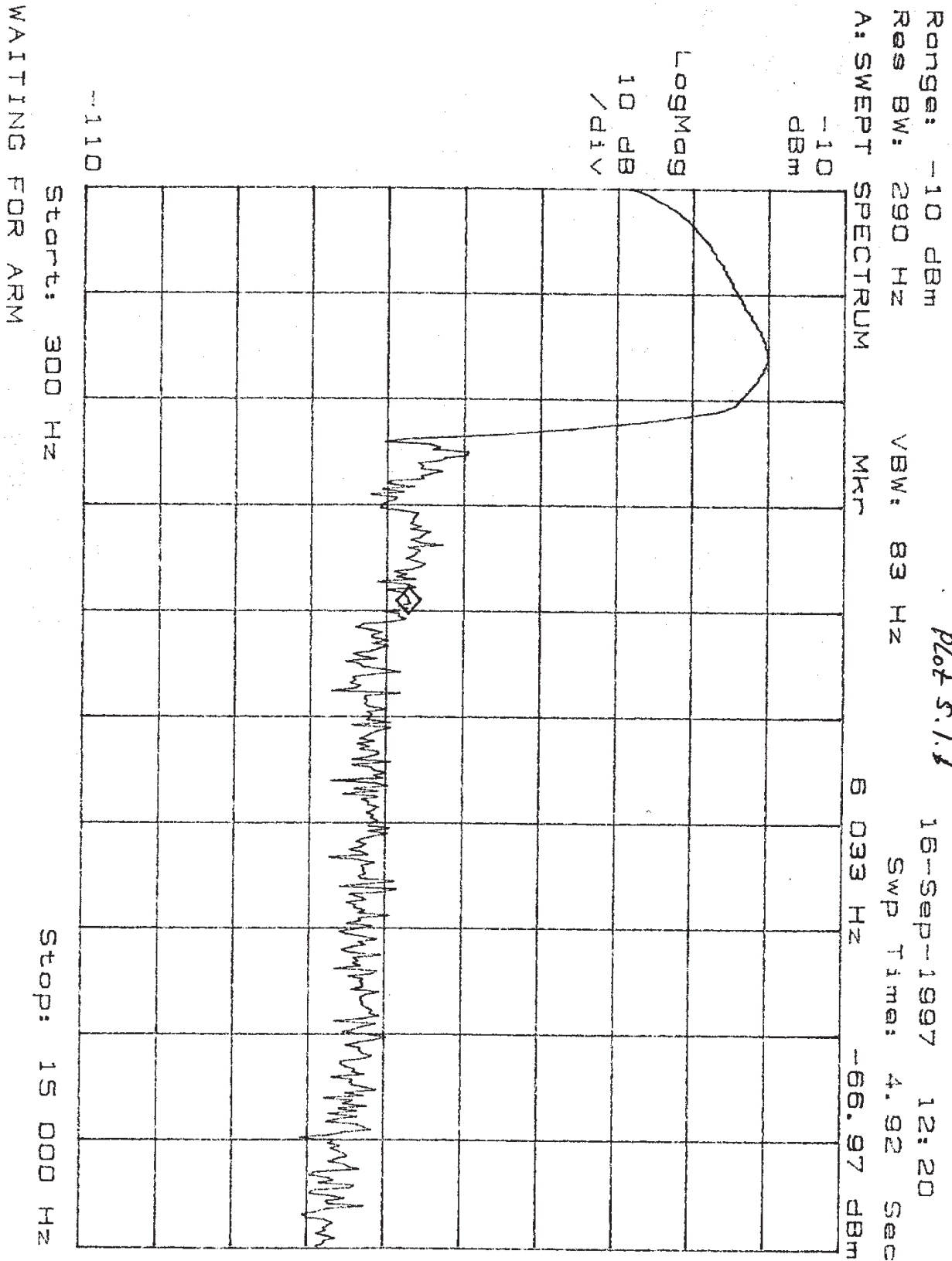

INTERTEK TESTING SERVICES

Raytheon TI Systems, Cellular Transceiver

Date of Test: Aug. 17, 1998 & Sept. 16, 1998

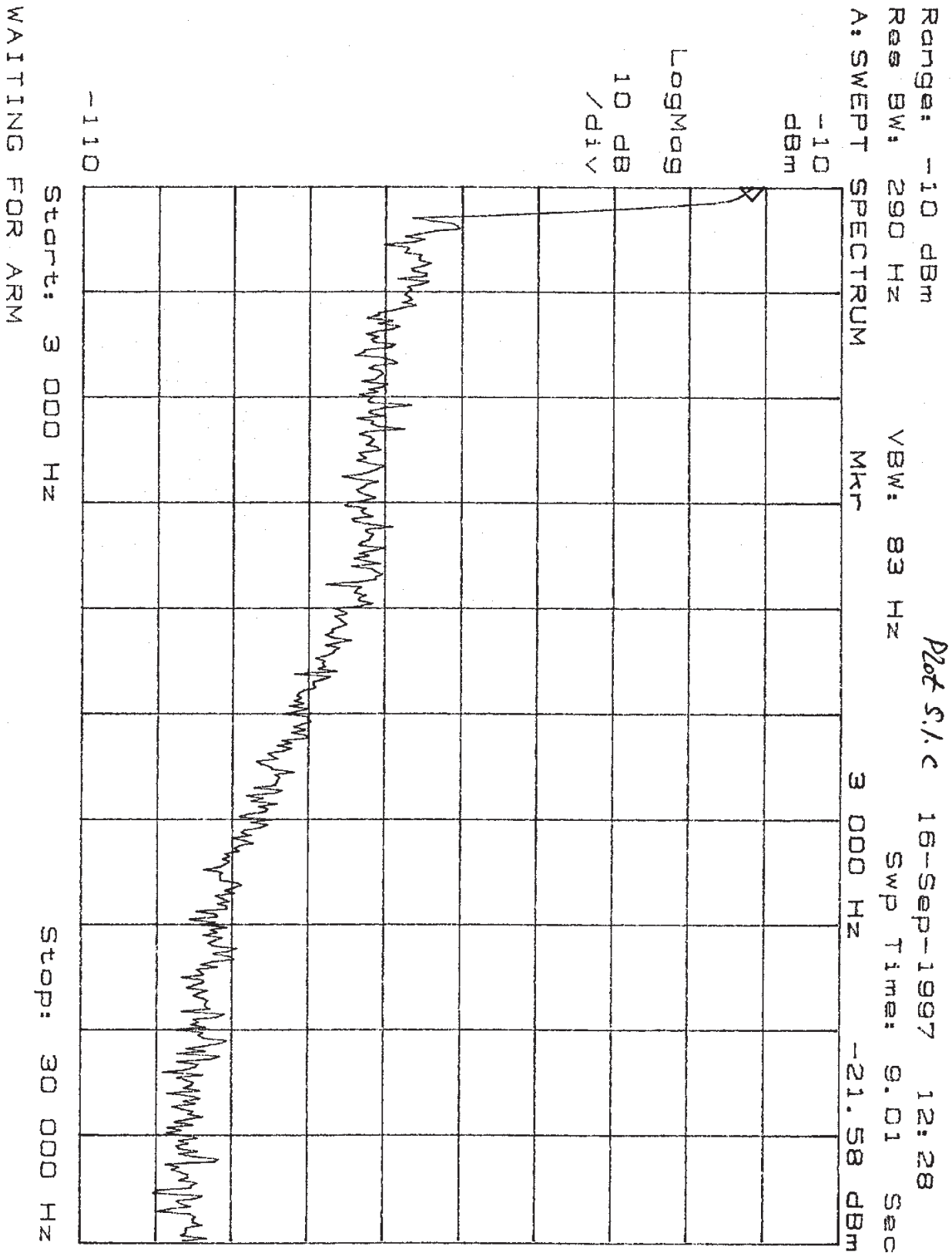

INTERTEK TESTING SERVICES

Raytheon TI Systems, Cellular Transceiver

Date of Test: Aug. 17, 1998 & Sept. 16, 1998

6.0 Emission Limitations, Occupied Bandwidth

Requirements: FCC 22.917(b)(d), FCC 2.989(b)(1)

F3E/F3D emission mask for use with audio filter. The mean power of emissions must be attenuated below the mean power of the unmodulated carrier wave (P) as follows:

- (1) On any frequency removed from the carrier frequency by more than 20 kHz but not more than 45 kHz: at least 26 dB;
- (2) On any frequency removed from the carrier frequency by more than 45 kHz, up to the first multiple of the carrier frequency: at least 60 dB or $43 + 10 \log P$ dB, whichever is the lesser attenuation.

F1D emission mask. The mean power of emissions must be attenuated below the mean power of the unmodulated carrier (P) as follows:

- (1) On any frequency removed from the carrier frequency by more than 20 kHz but no more than 45 kHz: at least 26 dB;
- (2) On any frequency removed from the carrier frequency by more than 45 kHz but not more than 90 kHz: at least 45 dB;
- (2) On any frequency removed from the carrier frequency by more than 90 kHz, up to the first multiple of the carrier frequency: at least 60 dB or $43 + 10 \log P$ db, whichever is the lesser attenuation.

6.1 Test Procedure

The RF output of the transceiver was connected to the input of the spectrum analyzer through sufficient attenuation. The audio generator was connected to the audio input of the transceiver.

The spectrum with no modulation was recorded. The audio input signal was adjusted to obtain the frequencies deviation equal 6 kHz at the audio frequency of maximum response which was determined measuring deviation versus frequency from 300 Hz to 3.5 kHz and was found 2.4 kHz. The audio input level was increased by 16 dB. The audio frequency was set to the frequency 2.5 kHz.

The resolution bandwidth of the spectrum analyzer was set at 300 Hz and the spectrum was recorded in the frequency band ± 50 kHz from the carrier frequency. The same plots has been done for wideband emissions, SAT, ST, DTMF9 and some of the combinations of these modulating signals.

INTERTEK TESTING SERVICES

Raytheon TI Systems, Cellular Transceiver

Date of Test: Aug. 17, 1998 & Sept. 16, 1998

6.2 Test Equipment

HP 8566B Spectrum Analyzer
Leader LFG-1300S Function Generator
Leader LMV-182 AC Millivoltmeter
Marconi 2955A Radio Communication Test Set
HP 7470A Plotter

6.3 Test Results

Refer to the attached plots.

The EUT passed the test.

INTERTEK TESTING SERVICES

Raytheon TI Systems, Cellular Transceiver

Date of Test: Aug. 17, 1998 & Sept. 16, 1998

Plot #	Description
6.3.a	Carrier frequency, no modulation
6.3.b	Wideband emissions (010101), scan 100 kHz
6.3.c	Wideband emissions (010101), scan 200 kHz
6.3.d	DTMF "9"
6.3.e	SAT (6 kHz, 2 kHz deviation), scan 100 kHz
6.3.f	DTMF + SAT, scan 100 kHz
6.3.g	DTMF + SAT, scan 200 kHz
6.3.h	ST (10 kHz, 8 kHz deviation), scan 50 kHz RBW = 300 Hz
6.3.i	ST (10 kHz, 8 kHz deviation), scan 50 kHz RBW = 100 Hz
6.3.j	ST (10 kHz, 8 kHz deviation), scan 200 kHz
6.3.k	ST & SAT, scan 200 kHz
6.3.l	Voice (2.5 kHz), scan 100 kHz
6.3.m	Voice (2.5 kHz), scan 200 kHz
6.3.n	Voice & SAT, scan 200 kHz
6.3.o	Voice & SAT, low power

INTERTEK TESTING SERVICES

Raytheon TI Systems, Cellular Transceiver

Date of Test: Aug. 17, 1998 & Sept. 16, 1998

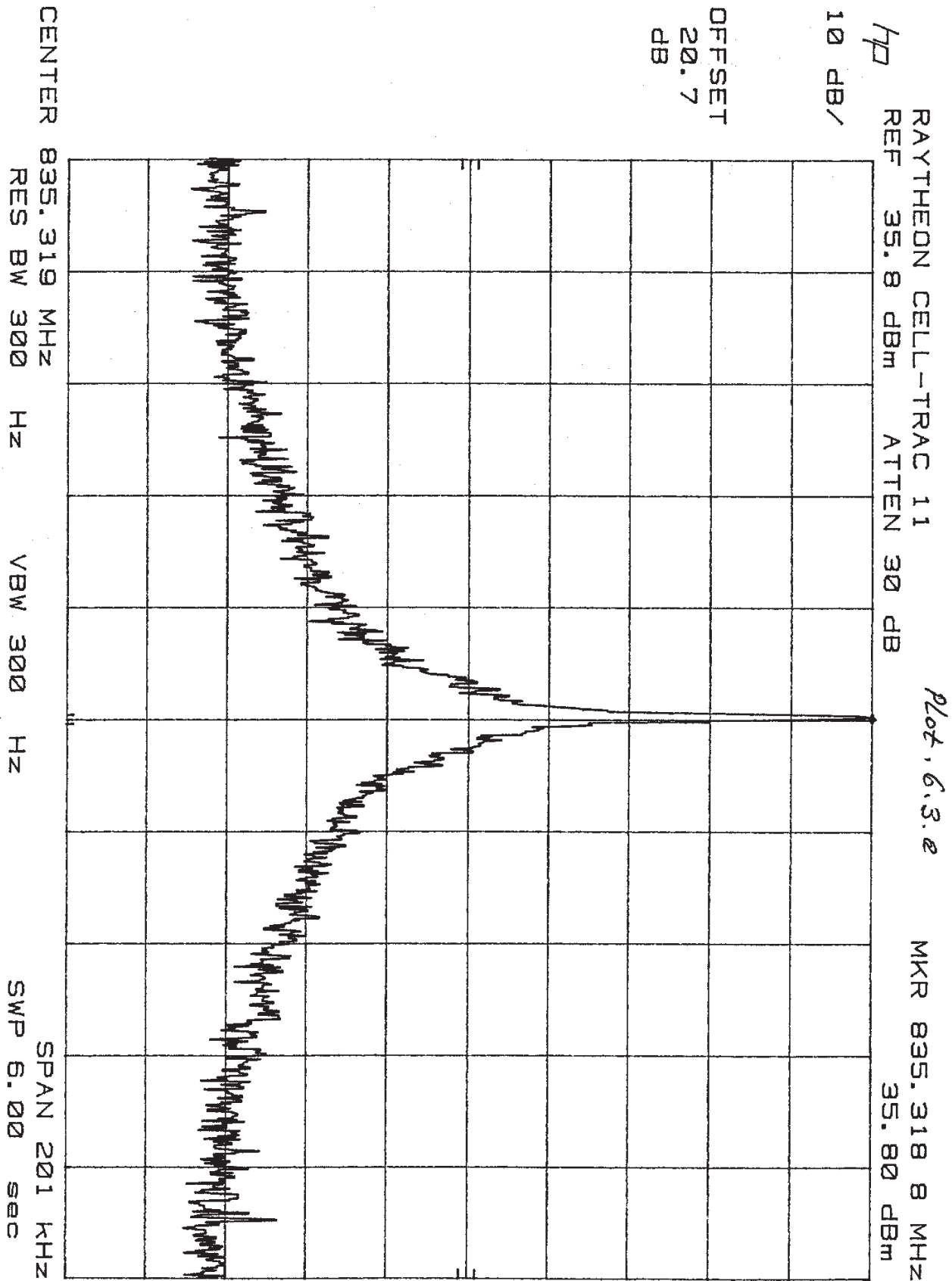

INTERTEK TESTING SERVICES

Raytheon TI Systems, Cellular Transceiver

Date of Test: Aug. 17, 1998 & Sept. 16, 1998

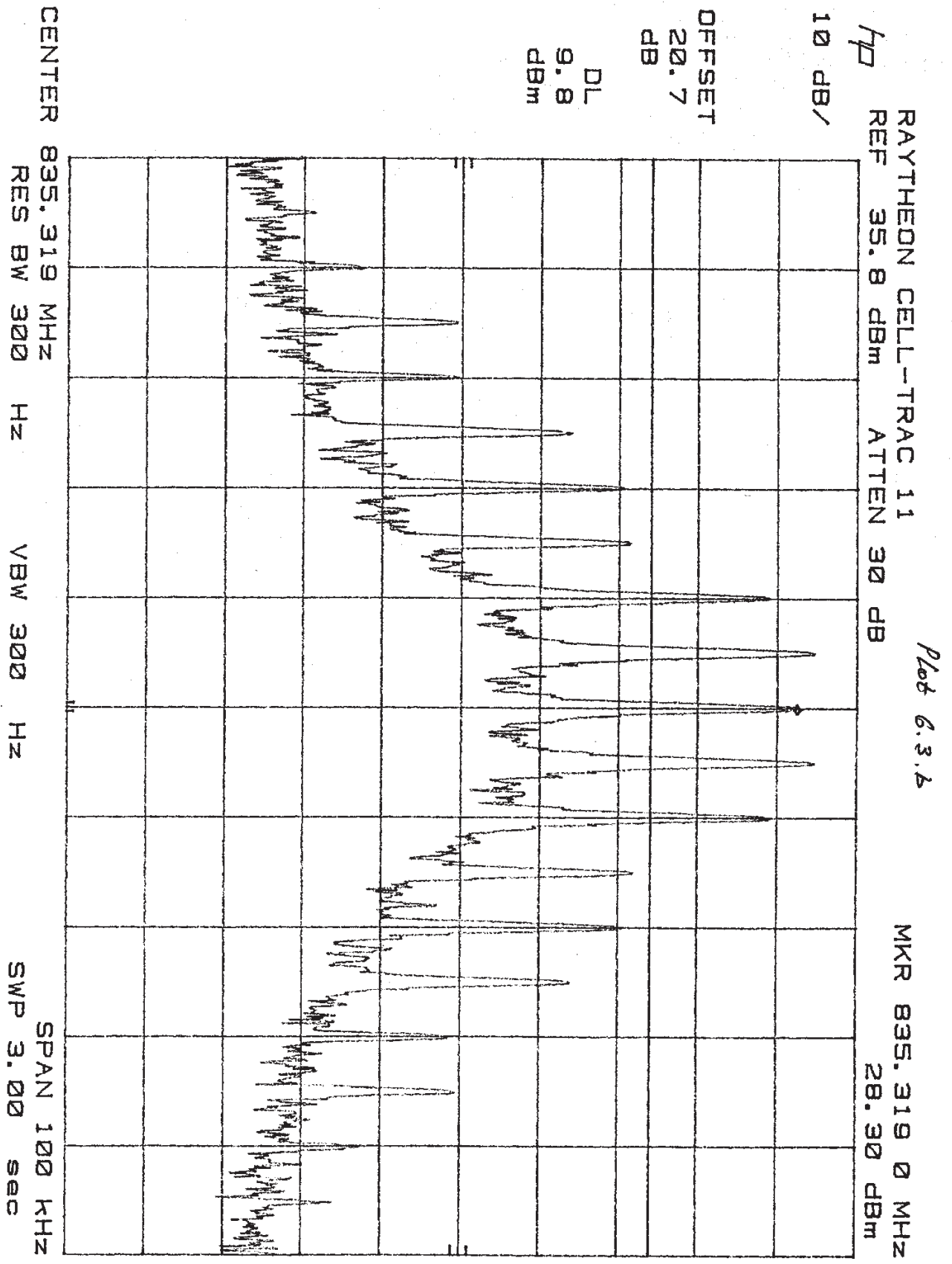

INTERTEK TESTING SERVICES

Raytheon TI Systems, Cellular Transceiver

Date of Test: Aug. 17, 1998 & Sept. 16, 1998

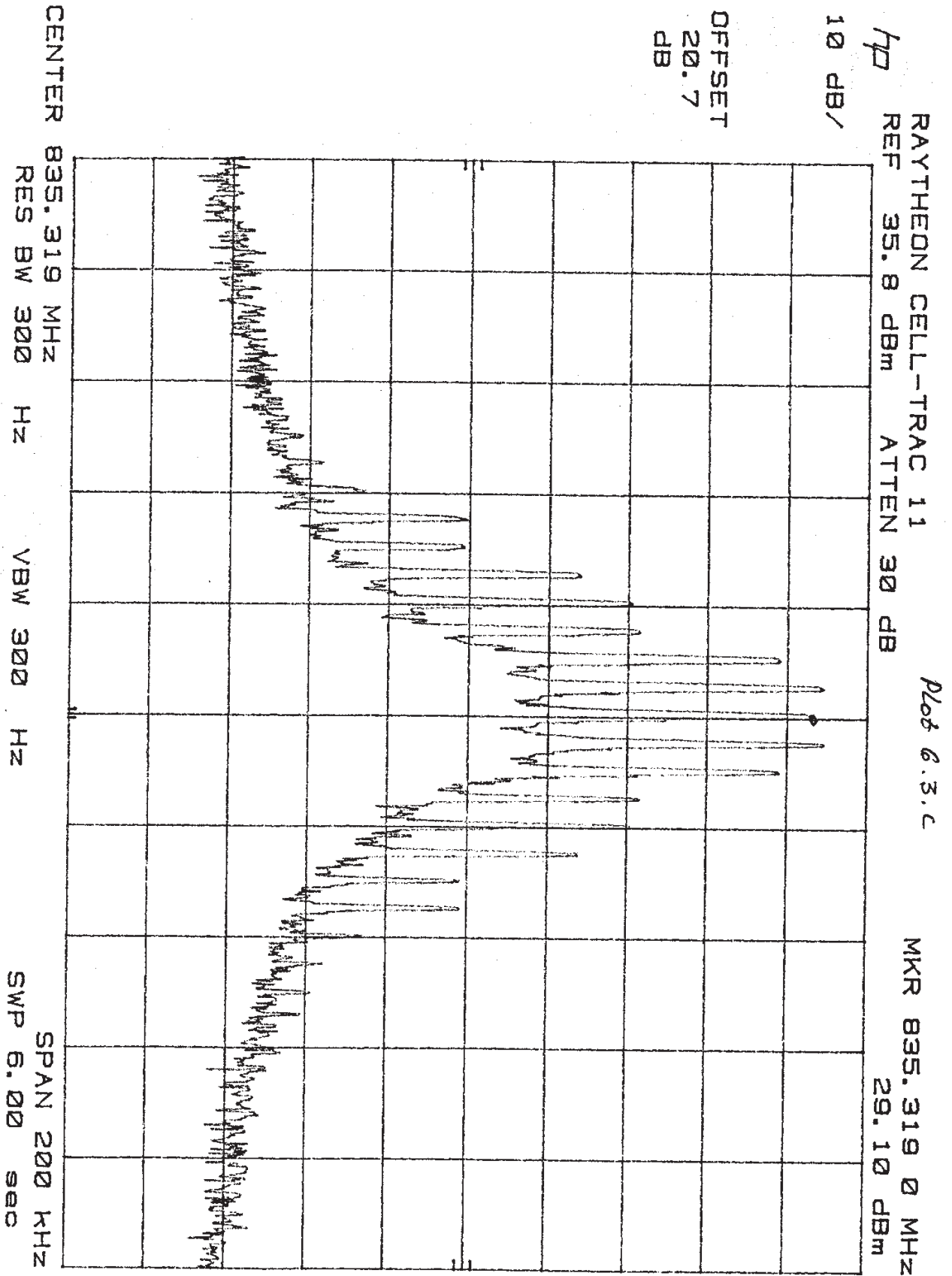

INTERTEK TESTING SERVICES

Raytheon TI Systems, Cellular Transceiver

Date of Test: Aug. 17, 1998 & Sept. 16, 1998

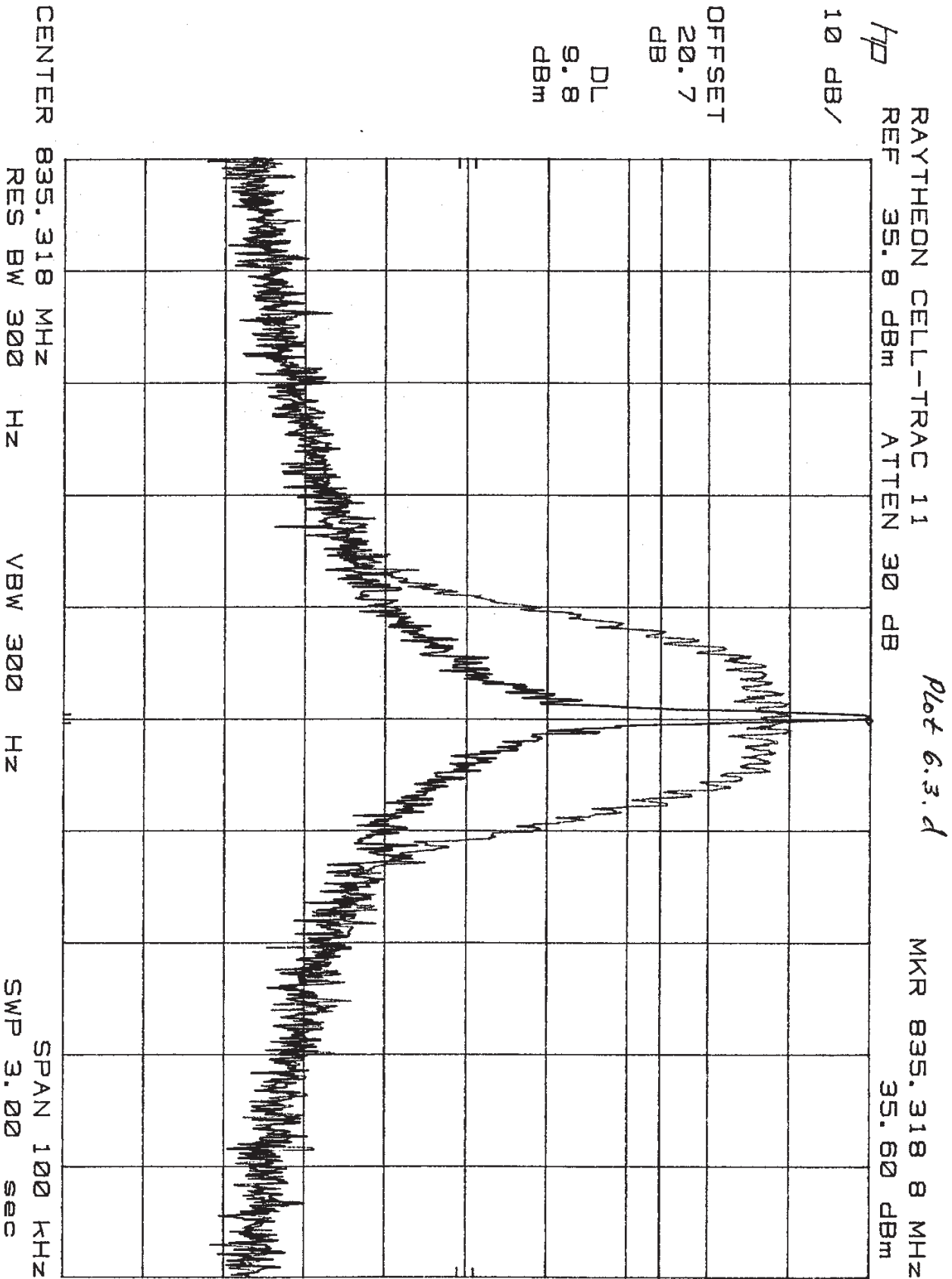

INTERTEK TESTING SERVICES

Raytheon TI Systems, Cellular Transceiver

Date of Test: Aug. 17, 1998 & Sept. 16, 1998

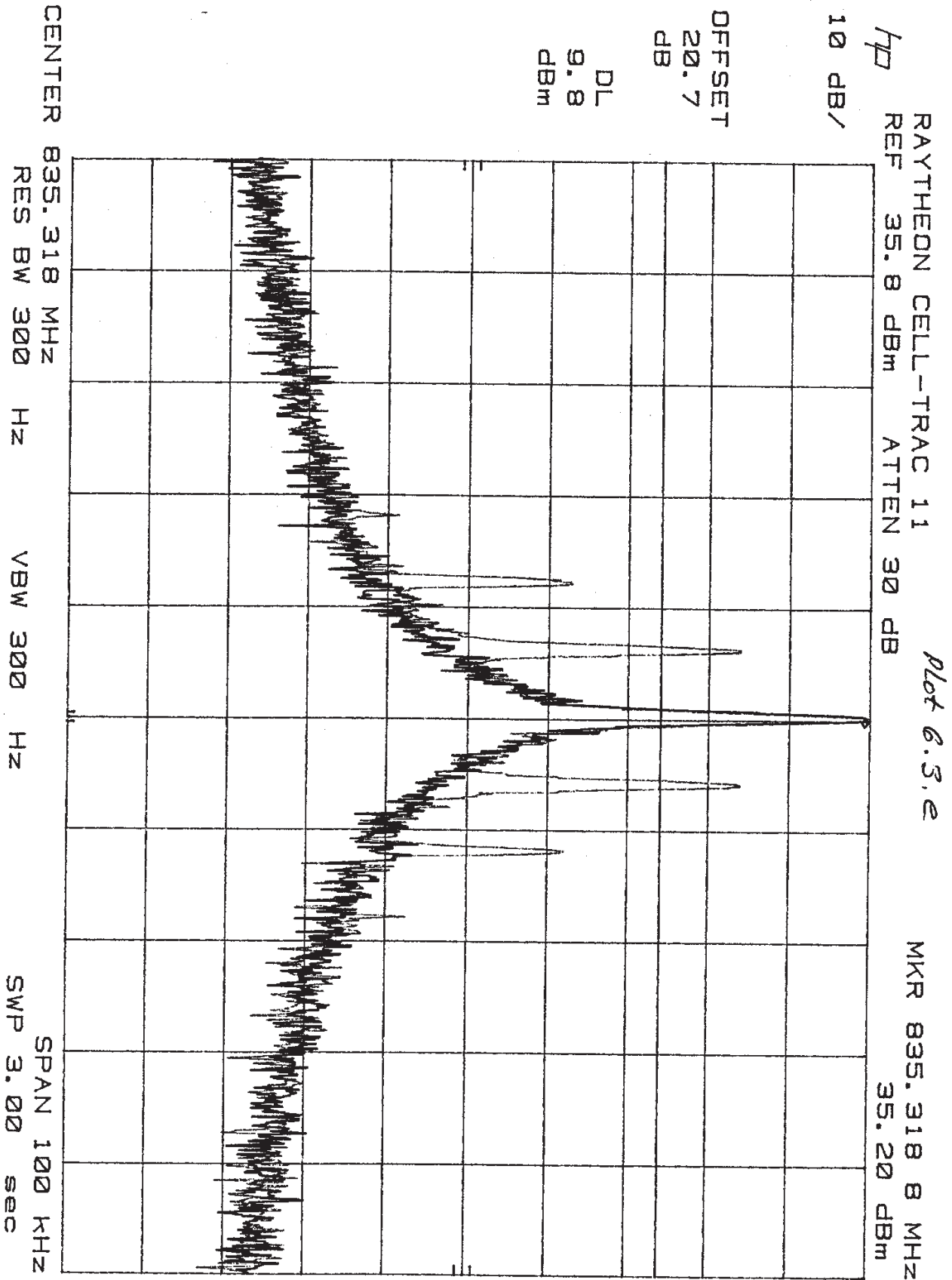

INTERTEK TESTING SERVICES

Raytheon TI Systems, Cellular Transceiver

Date of Test: Aug. 17, 1998 & Sept. 16, 1998

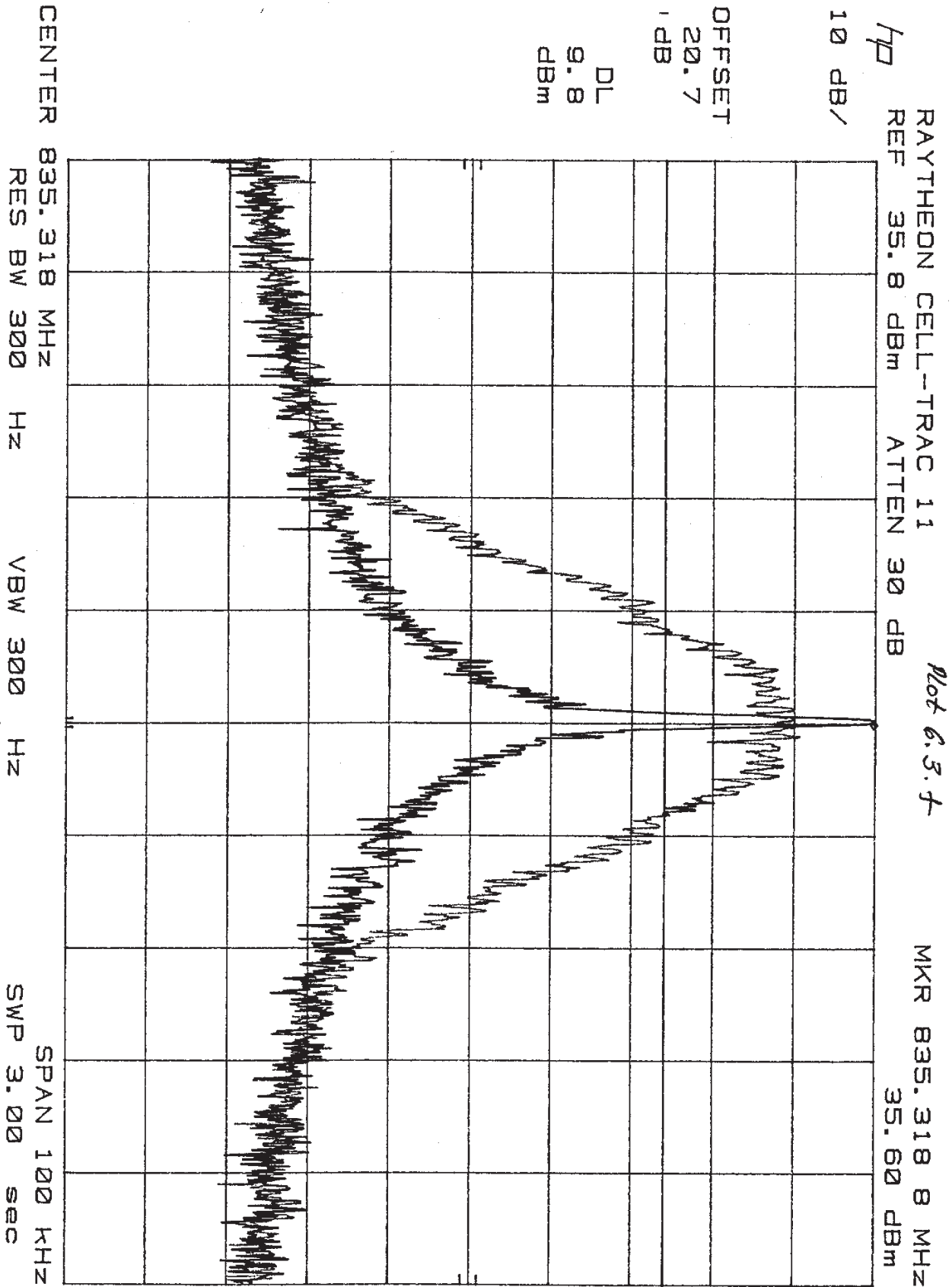

INTERTEK TESTING SERVICES

Raytheon TI Systems, Cellular Transceiver

Date of Test: Aug. 17, 1998 & Sept. 16, 1998

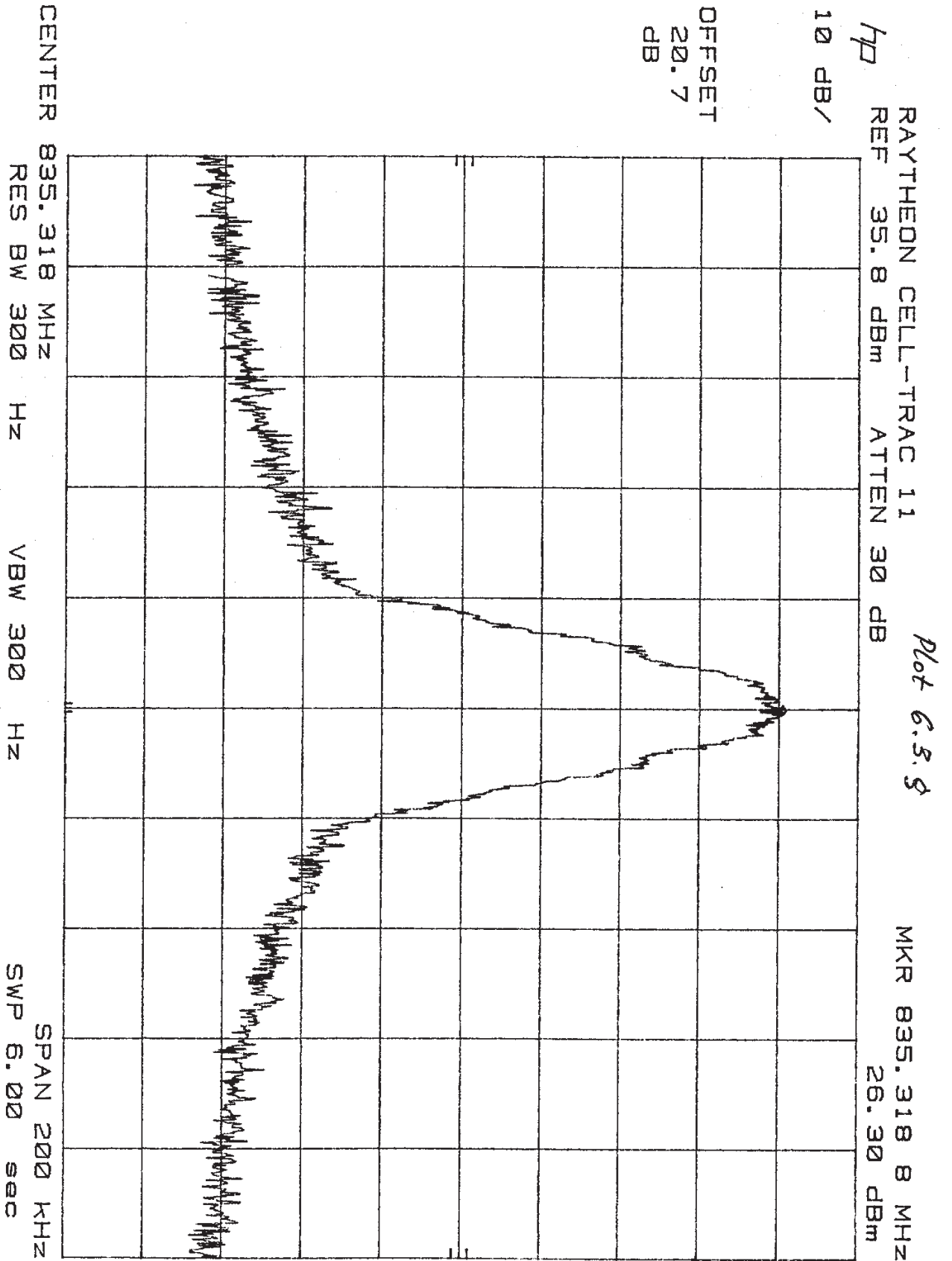

INTERTEK TESTING SERVICES

Raytheon TI Systems, Cellular Transceiver

Date of Test: Aug. 17, 1998 & Sept. 16, 1998

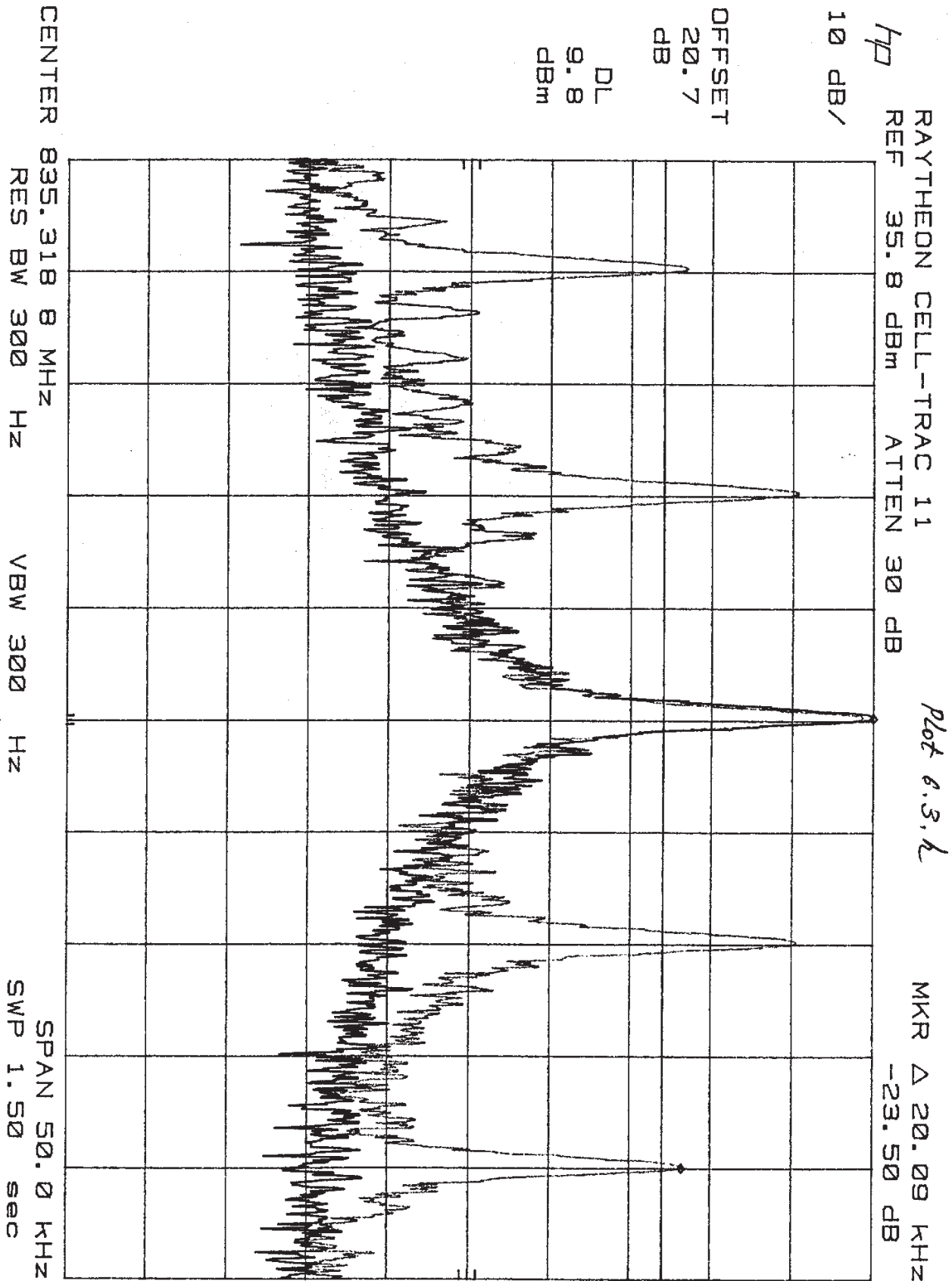

INTERTEK TESTING SERVICES

Raytheon TI Systems, Cellular Transceiver

Date of Test: Aug. 17, 1998 & Sept. 16, 1998

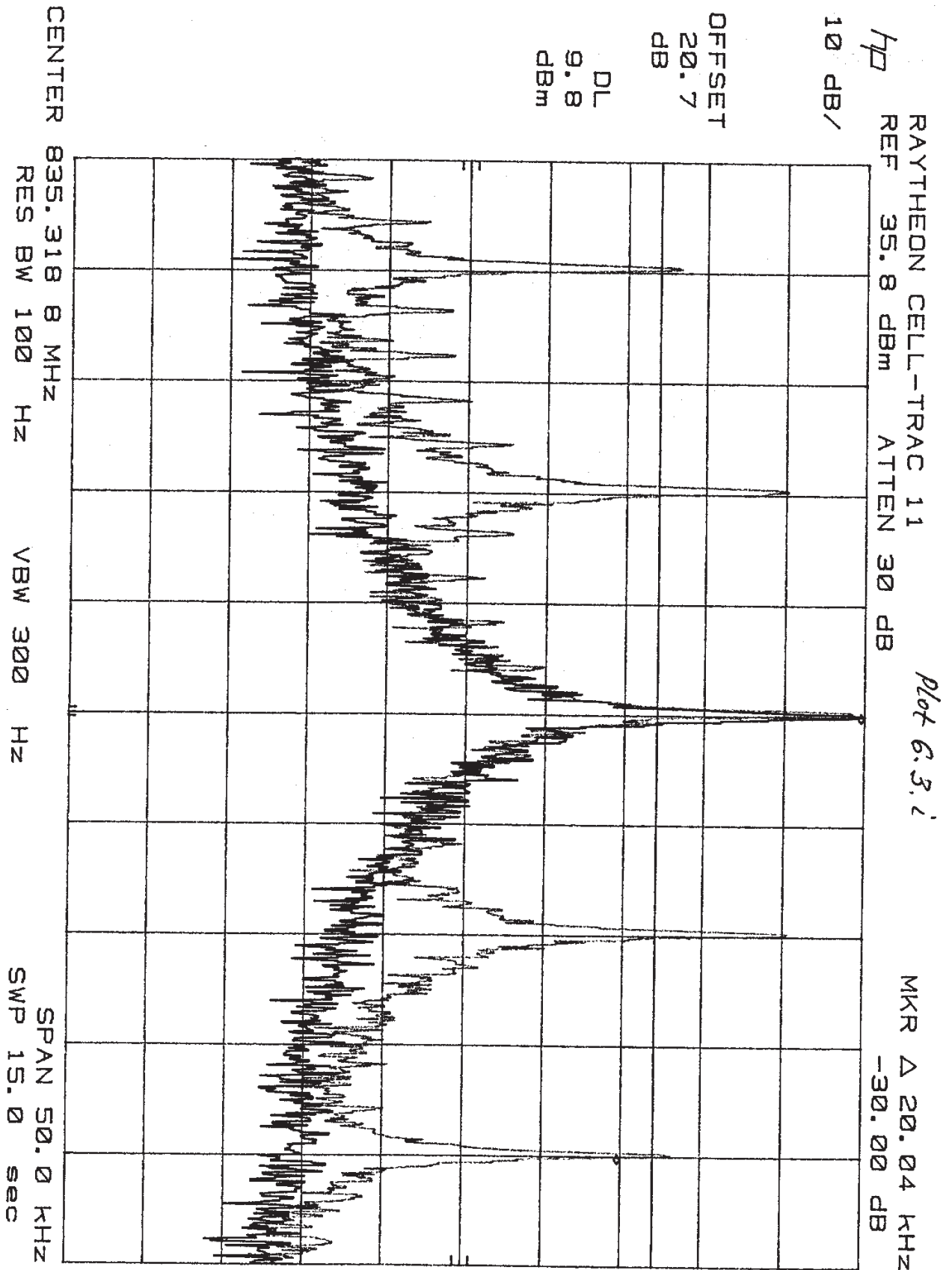

INTERTEK TESTING SERVICES

Raytheon TI Systems, Cellular Transceiver

Date of Test: Aug. 17, 1998 & Sept. 16, 1998

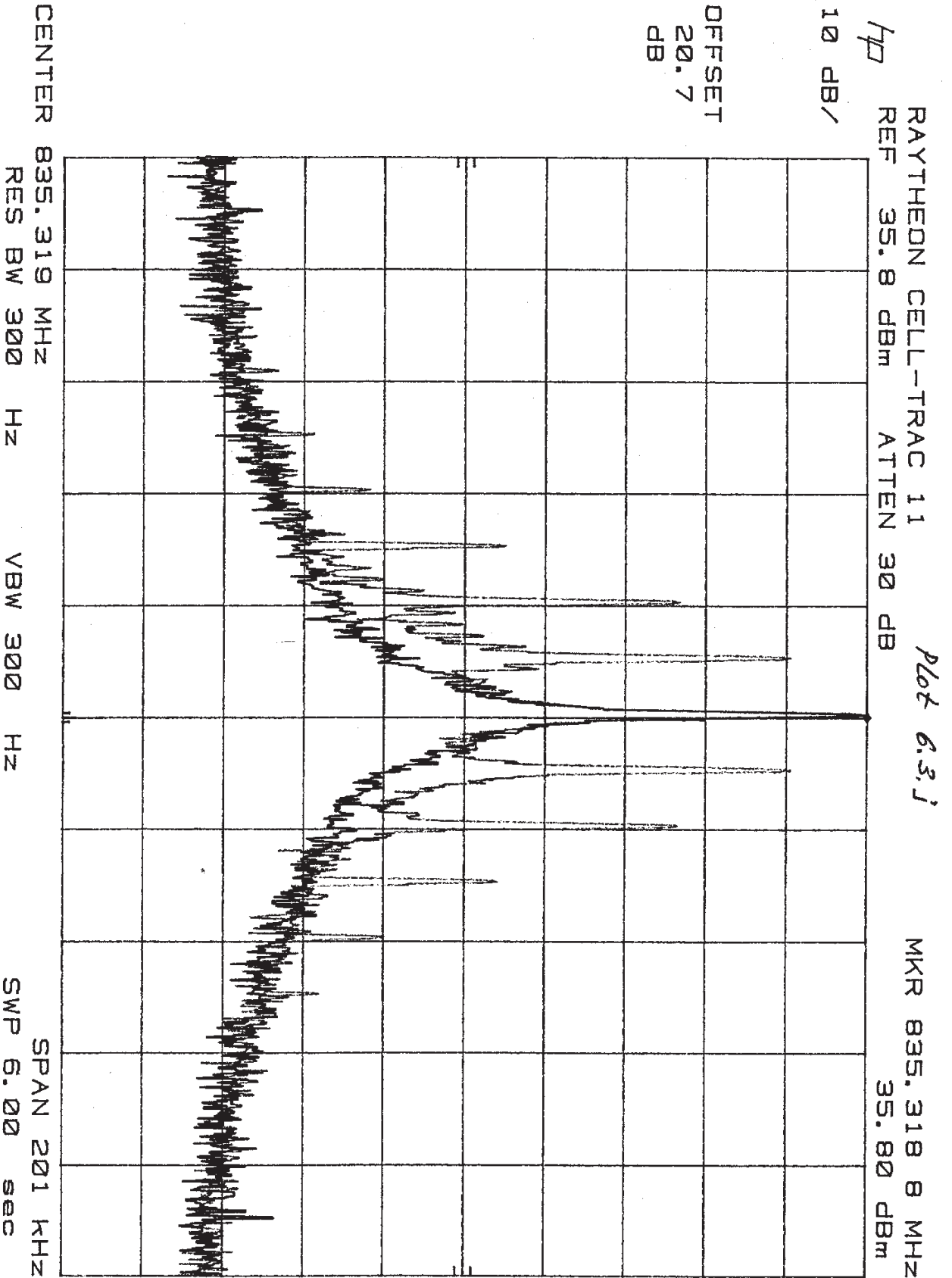

INTERTEK TESTING SERVICES

Raytheon TI Systems, Cellular Transceiver

Date of Test: Aug. 17, 1998 & Sept. 16, 1998

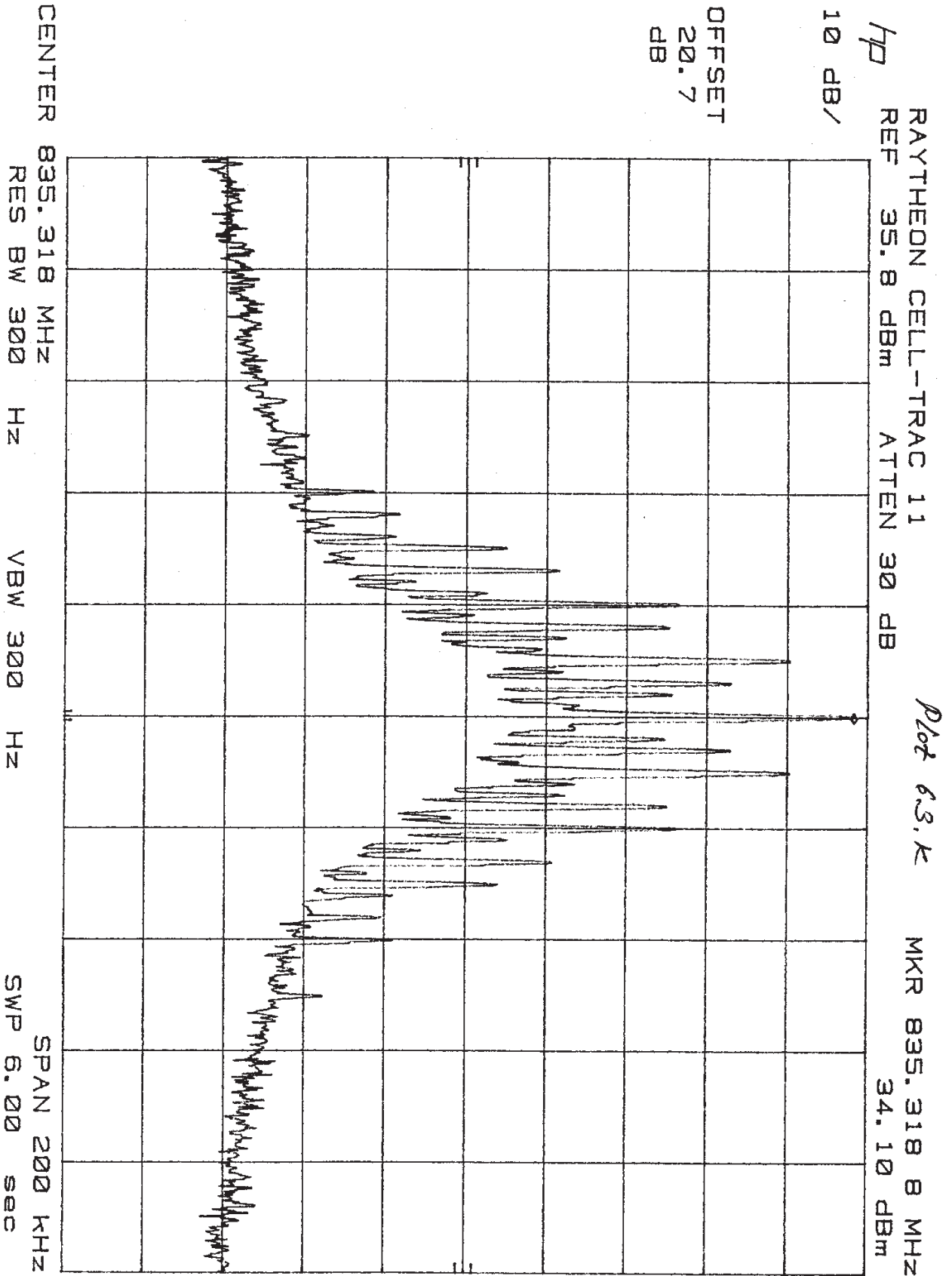

INTERTEK TESTING SERVICES

Raytheon TI Systems, Cellular Transceiver

Date of Test: Aug. 17, 1998 & Sept. 16, 1998

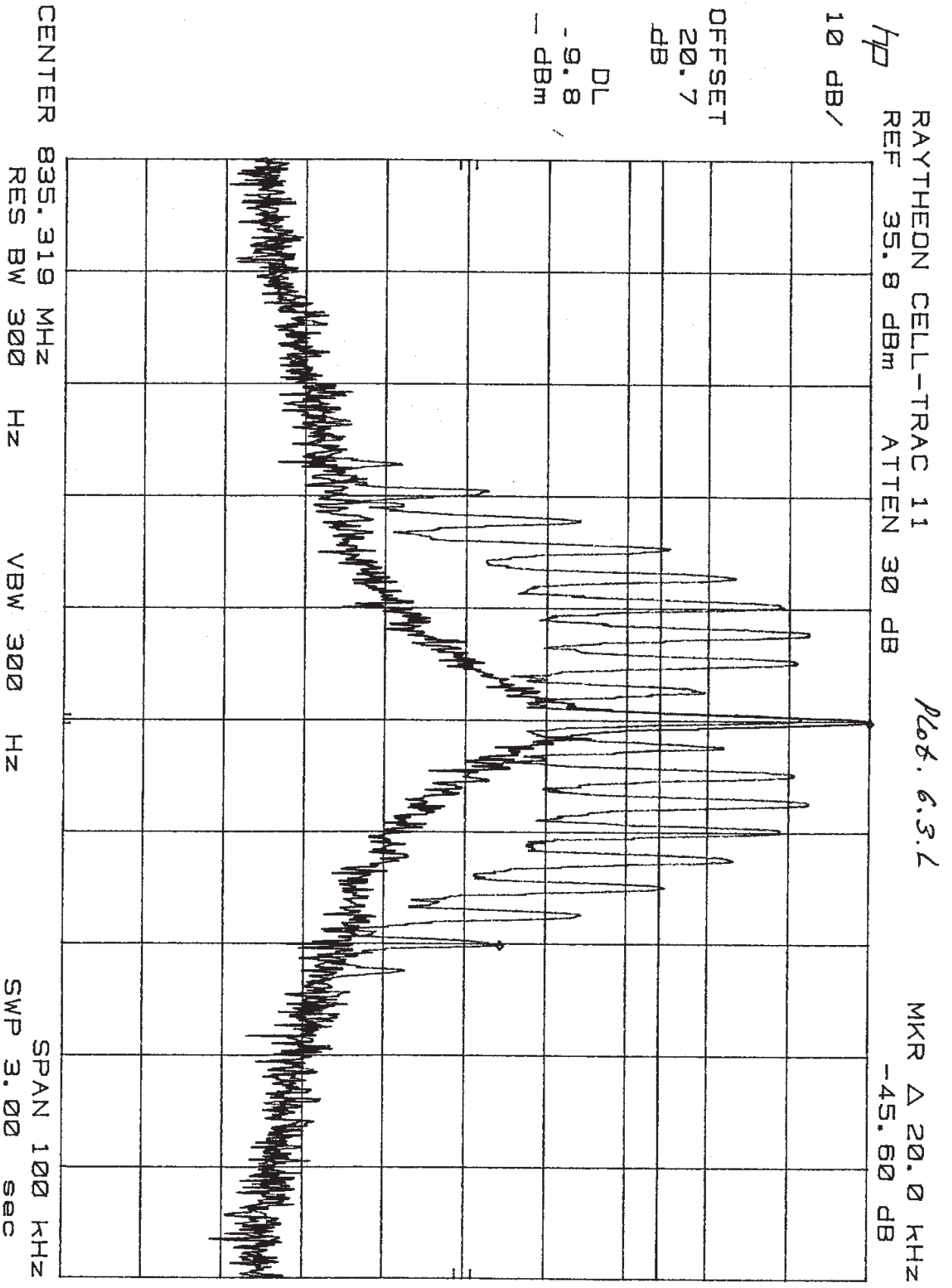

INTERTEK TESTING SERVICES

Raytheon TI Systems, Cellular Transceiver

Date of Test: Aug. 17, 1998 & Sept. 16, 1998

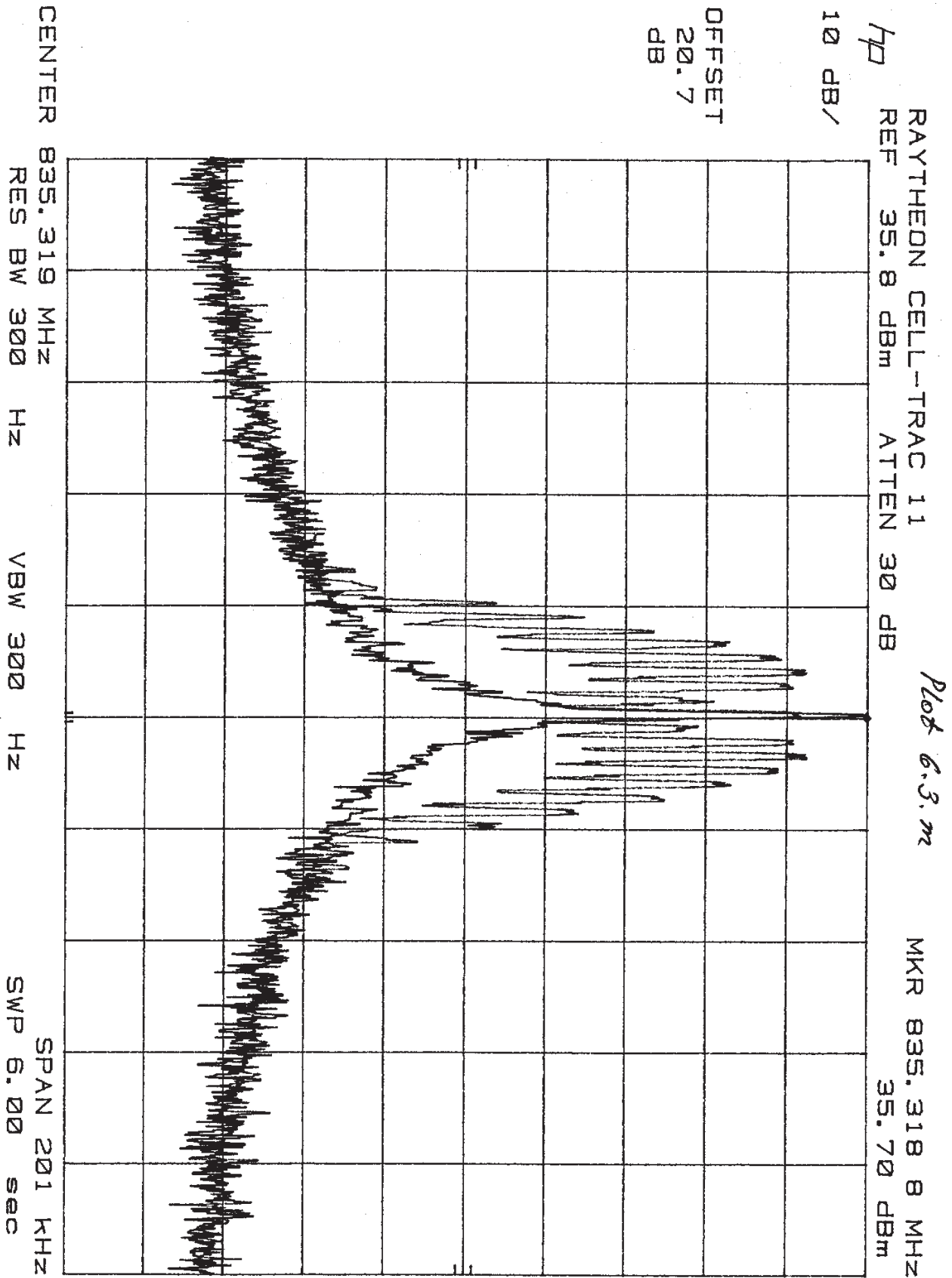

INTERTEK TESTING SERVICES

Raytheon TI Systems, Cellular Transceiver

Date of Test: Aug. 17, 1998 & Sept. 16, 1998

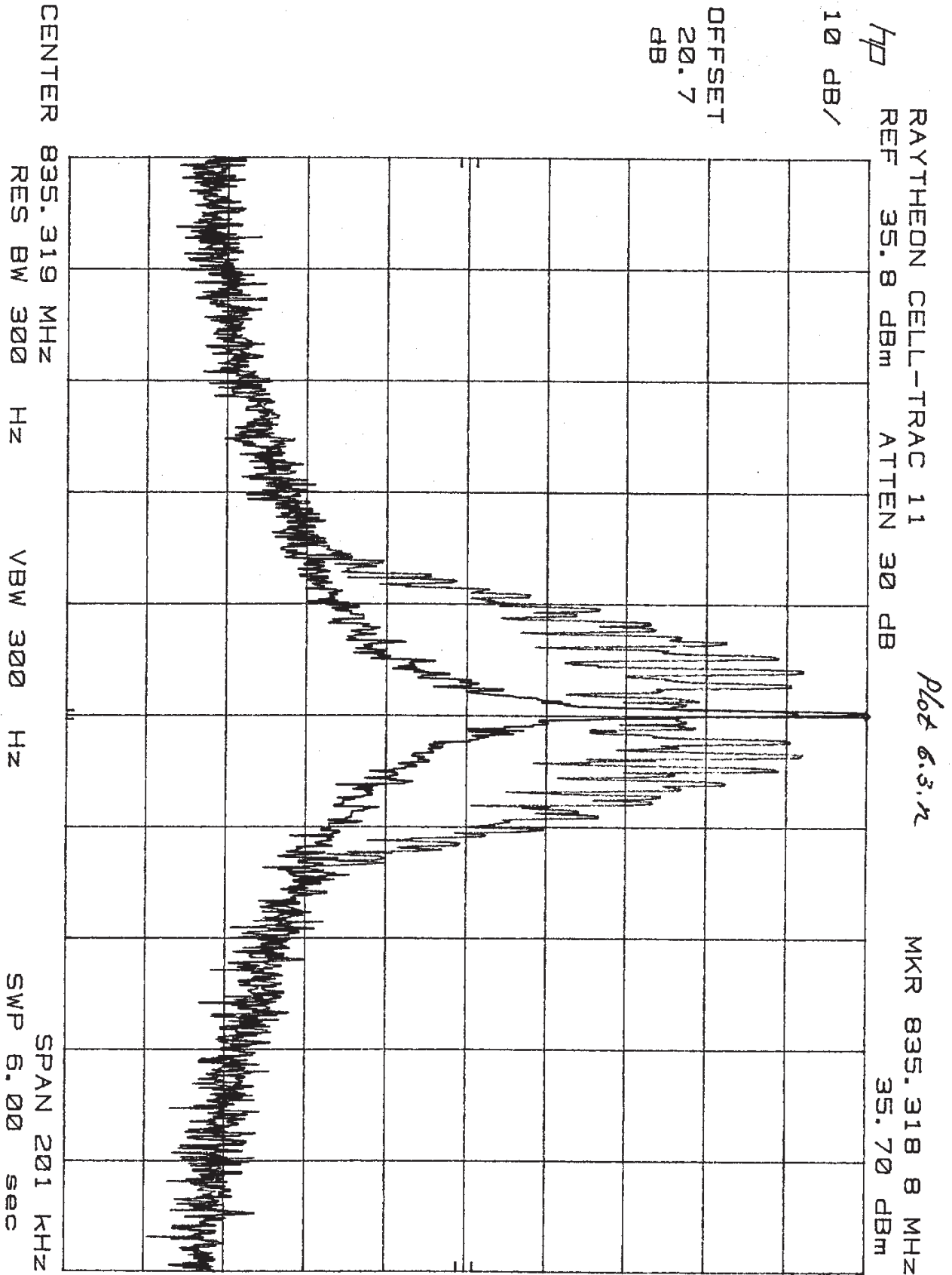

INTERTEK TESTING SERVICES

Raytheon TI Systems, Cellular Transceiver

Date of Test: Aug. 17, 1998 & Sept. 16, 1998

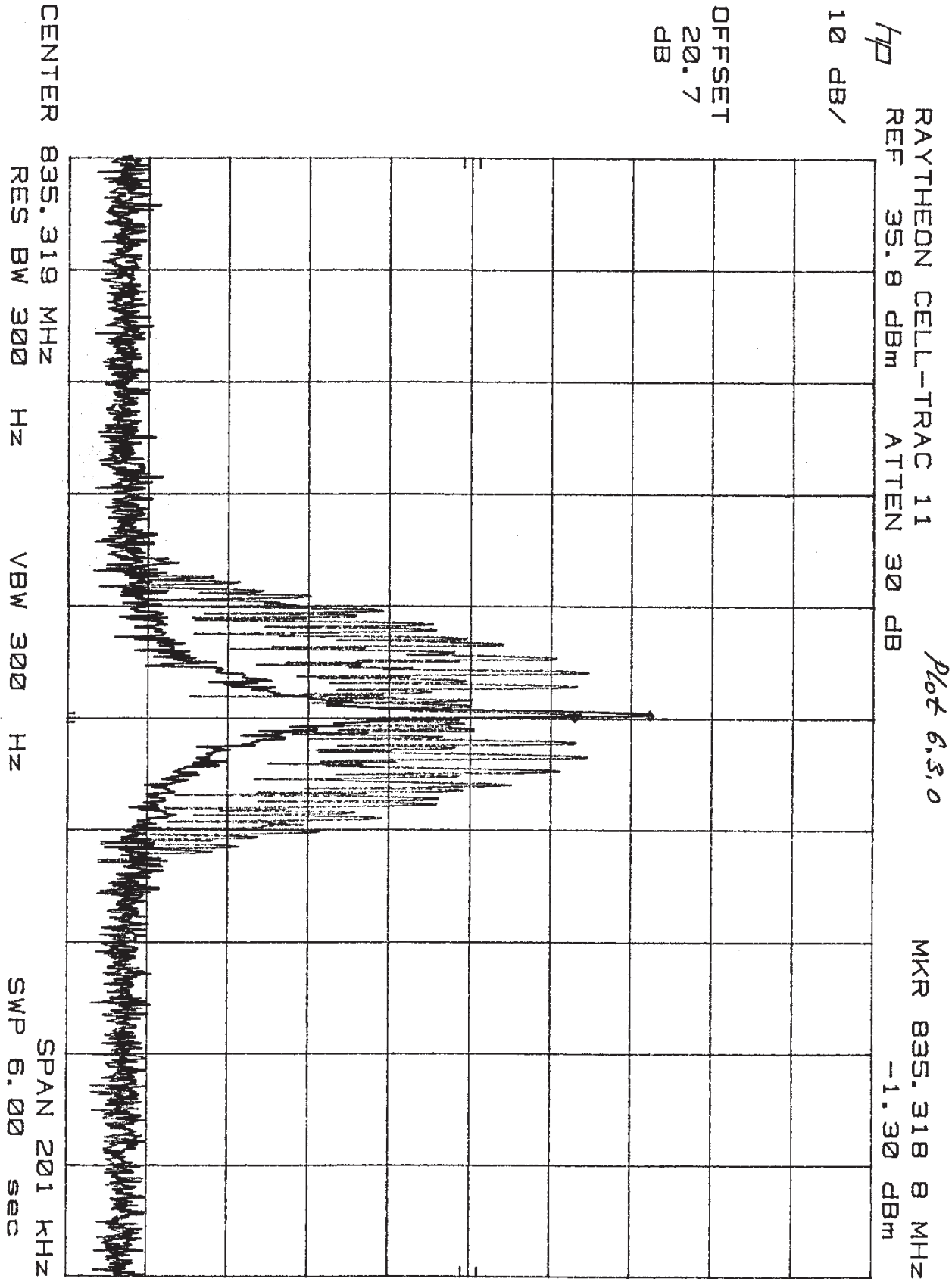

INTERTEK TESTING SERVICES

Raytheon TI Systems, Cellular Transceiver

Date of Test: Aug. 17, 1998 & Sept. 16, 1998

7.0 **Out of Band Emissions at Antenna Terminals**

Requirements: FCC 22.917(e), FCC 22.917(f)

Out of Band Emissions:

The mean power of emissions must be attenuated below the mean power of the unmodulated carrier (P) on any frequency twice or more than twice the fundamental frequency by at least $43 + 10 \log P$ dB.

Mobile Emissions in Base Frequency Range:

The mean power of any emissions appearing in the base station frequency range from cellular mobile transmitters operated must be attenuated to a level not to exceed -80 dBm at the transmit antenna connector.

7.1 Test Procedure

The RF output of the transceiver was connected to a spectrum analyzer through appropriate attenuation. The resolution bandwidth of the spectrum analyzer was set at 30 kHz. The audio modulating signal was adjusted like it is described in Section 6.1 of this report. Sufficient scans were taken to show the outband emissions if any up to 10th harmonic.

7.2 Test Equipment

HP 8566B Spectrum Analyzer
Leader LFG-1300S Function Generator
Leader LMV-182 AC Millivoltmeter
HP 7470A Plotter

7.3 Test Results

Refer to the attached plots.

The EUT passed the test.

INTERTEK TESTING SERVICES

Raytheon TI Systems, Cellular Transceiver

Date of Test: Aug. 17, 1998 & Sept. 16, 1998

Plot #	Description
7.3.a	1 MHz - 30 MHz (Low Channel)
7.3.b	30 MHz - 1 GHz (Low Channel)
7.3.c	1 GHz - 2.5 GHz (Low Channel)
7.3.d	2.5 GHz - 10 GHz (Low Channel)
7.3.e	1 MHz - 30 MHz (Middle Channel)
7.3.f	30 MHz - 1 GHz (Middle Channel)
7.3.g	1 GHz - 2.5 GHz (Middle Channel)
7.3.h	2.5 GHz - 10 GHz (Middle Channel)
7.3.i	1 MHz - 30 MHz (High Channel)
7.3.j	30 MHz - 1 GHz (High Channel)
7.3.k	1 GHz - 2.5 GHz (High Channel)
7.3.l	2.5 GHz - 10 GHz (High Channel)
7.3.m	869 MHz - 894 MHz (Low Channel)
7.3.n	869 MHz - 894 MHz (Middle Channel)
7.3.o	869 MHz - 894 MHz (High Channel)

INTERTEK TESTING SERVICES

Raytheon TI Systems, Cellular Transceiver

Date of Test: Aug. 17, 1998 & Sept. 16, 1998

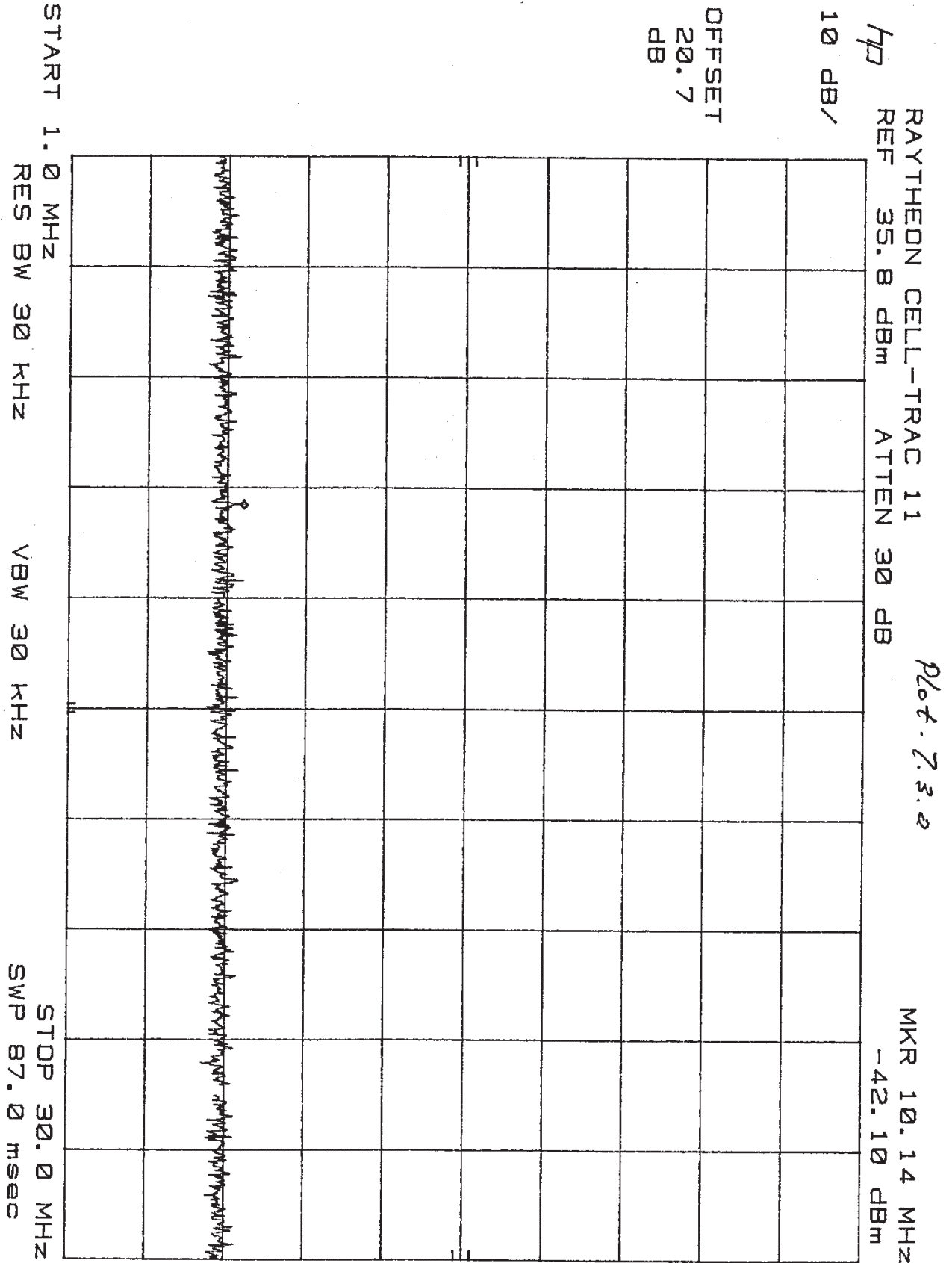

INTERTEK TESTING SERVICES

Raytheon TI Systems, Cellular Transceiver

Date of Test: Aug. 17, 1998 & Sept. 16, 1998

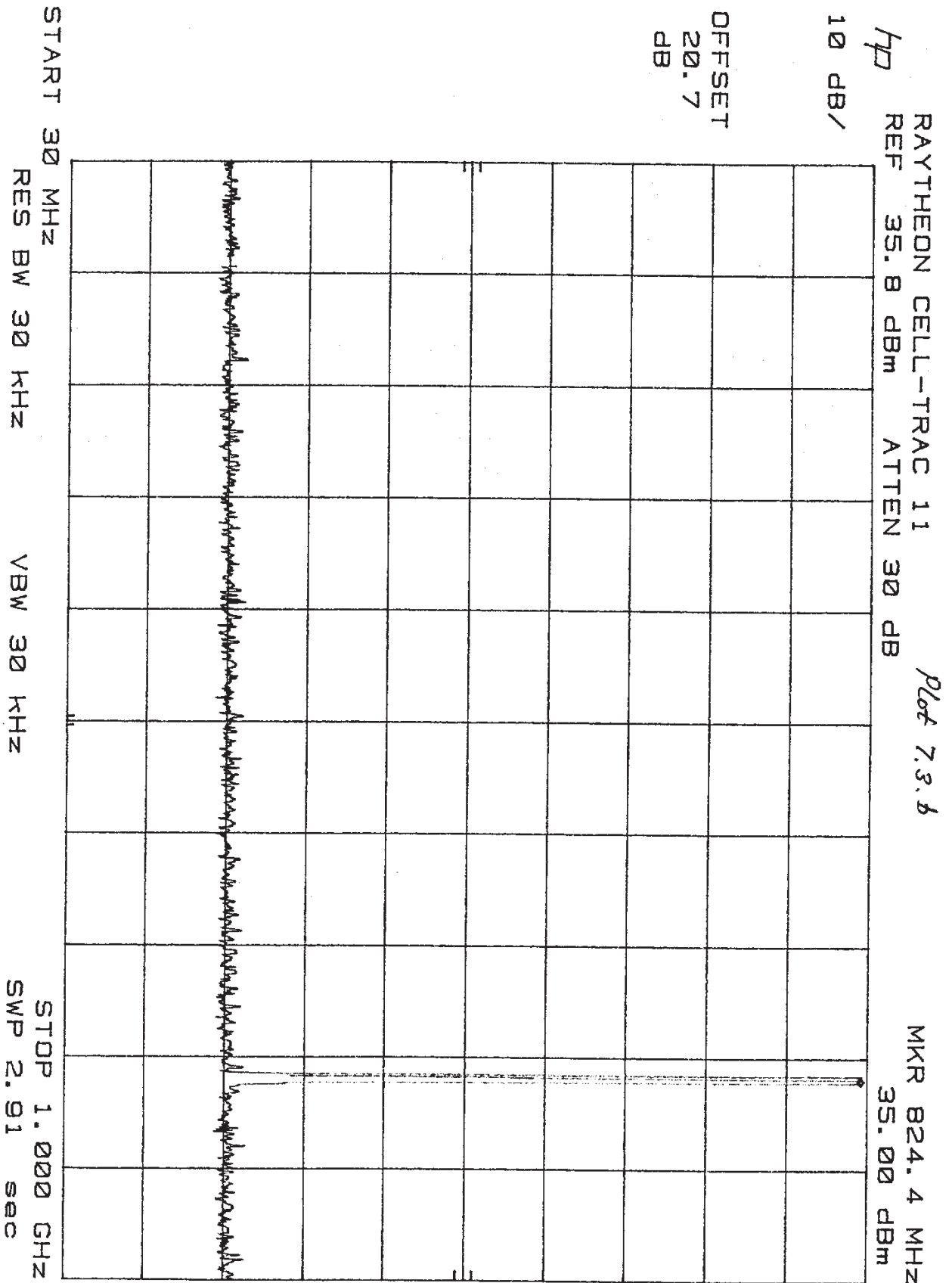

INTERTEK TESTING SERVICES

Raytheon TI Systems, Cellular Transceiver

Date of Test: Aug. 17, 1998 & Sept. 16, 1998

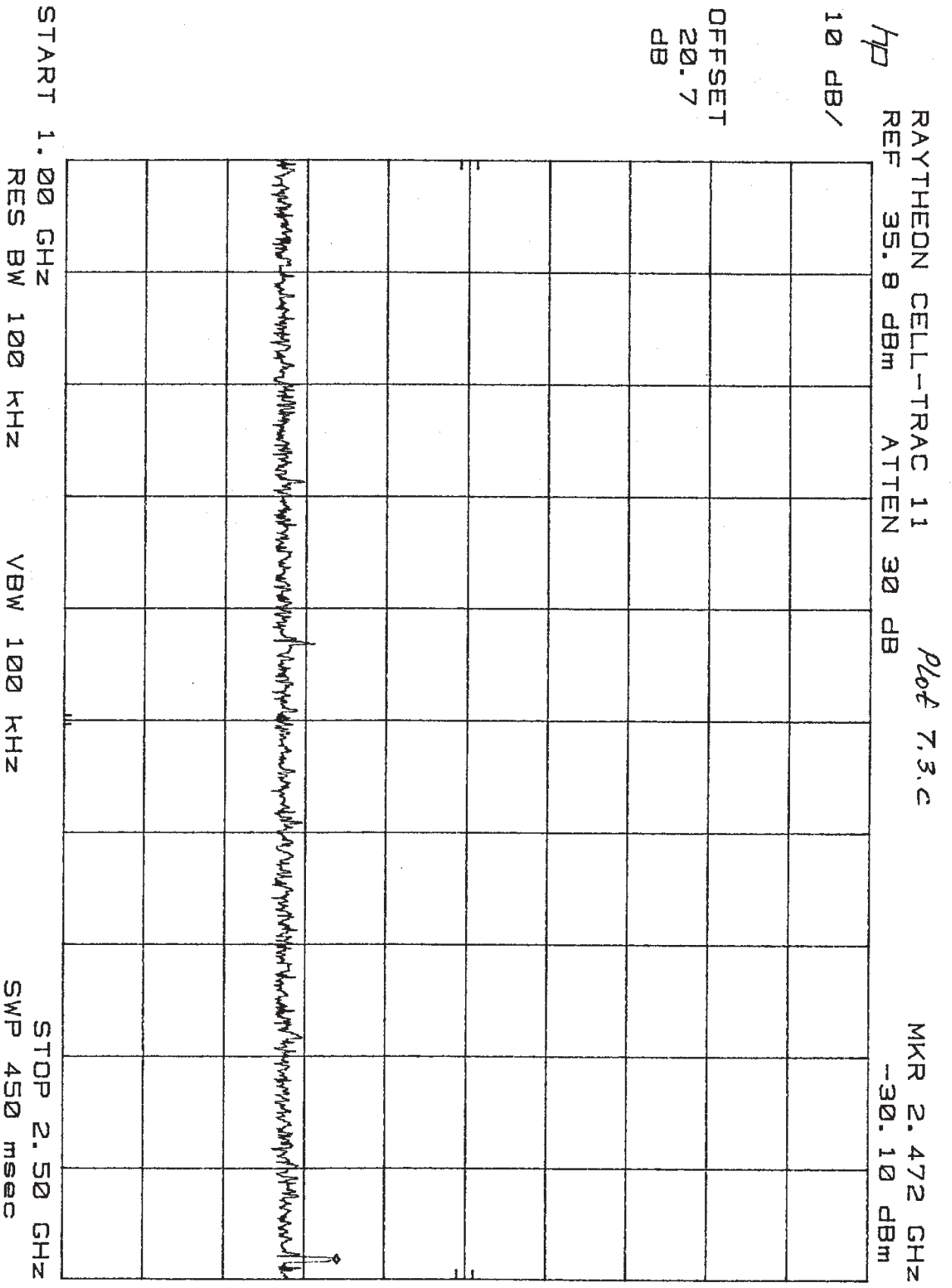

INTERTEK TESTING SERVICES

Raytheon TI Systems, Cellular Transceiver

Date of Test: Aug. 17, 1998 & Sept. 16, 1998

START 2.50 GHz RES BW 100 KHz VBW 100 KHz STOP 10.00 GHz
 SWP 2.25 sec

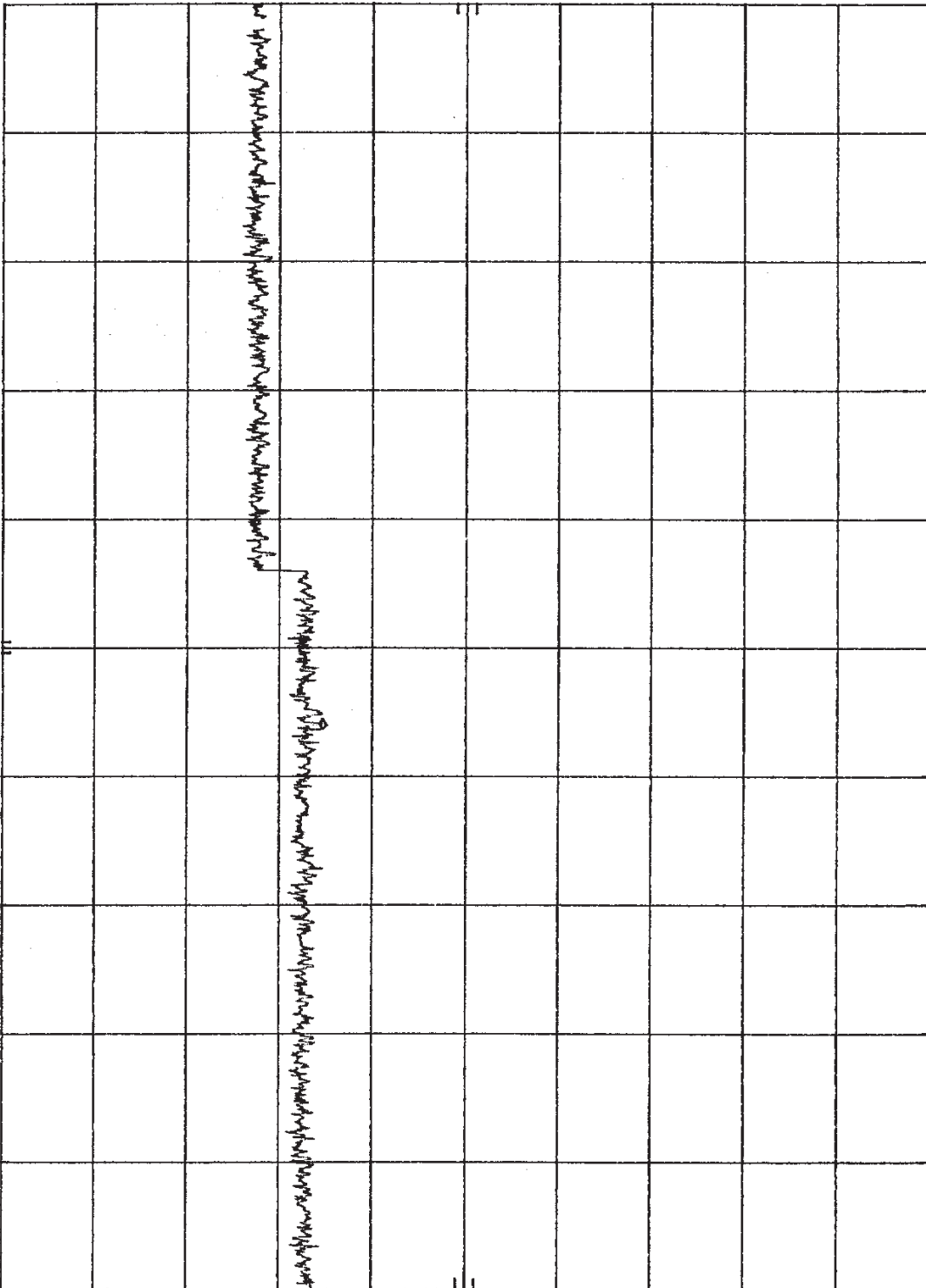

h7 RAYTHEON CELL-TRAC 11 *Plot 7.3.d* MKR 6.693 GHz
 REF 35.8 DBm ATTEN 30 DB -29.50 DBm

10 DB/
 OFFSET
 20.7
 DB

INTERTEK TESTING SERVICES

Raytheon TI Systems, Cellular Transceiver

Date of Test: Aug. 17, 1998 & Sept. 16, 1998

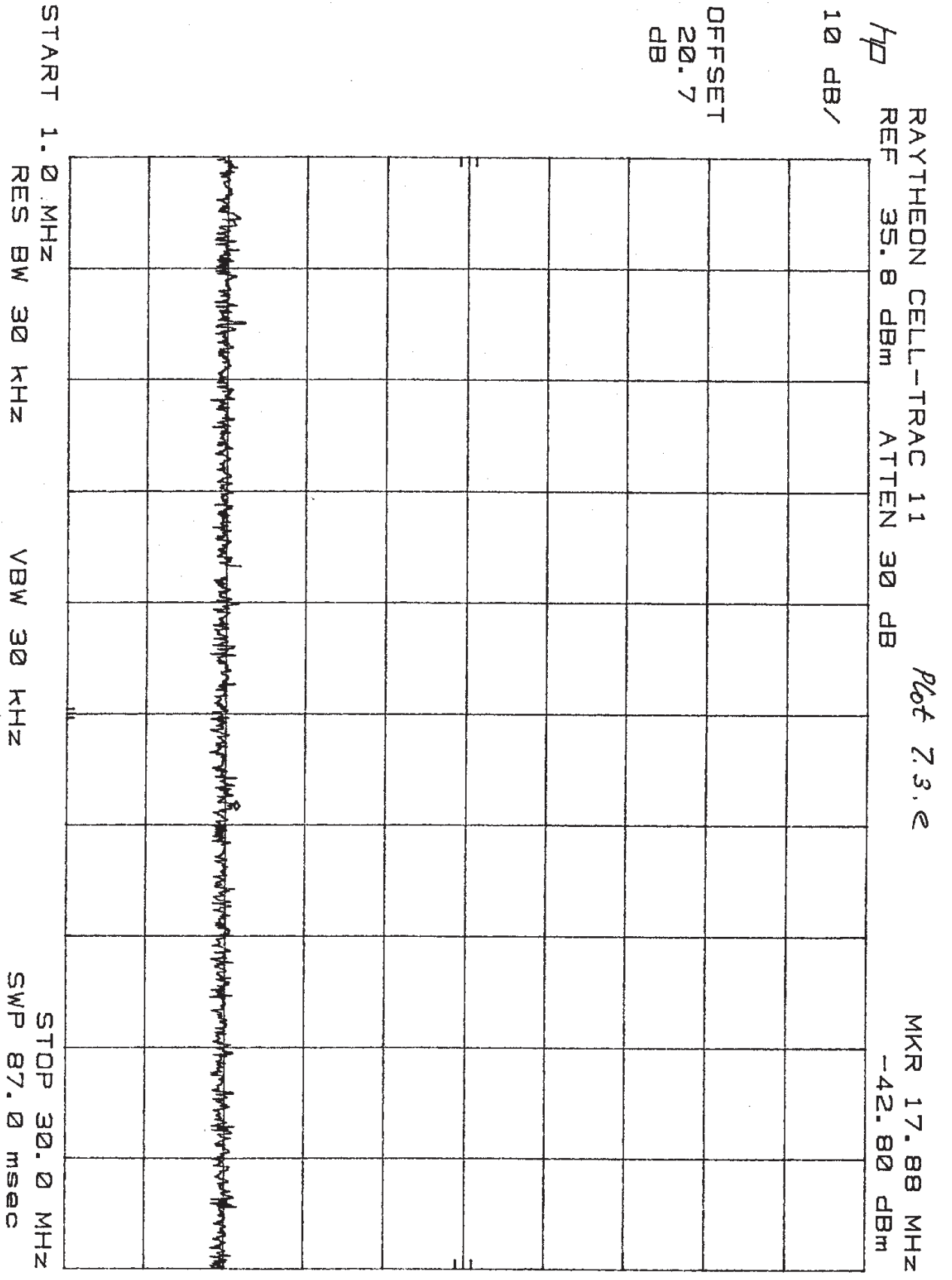

INTERTEK TESTING SERVICES

Raytheon TI Systems, Cellular Transceiver

Date of Test: Aug. 17, 1998 & Sept. 16, 1998

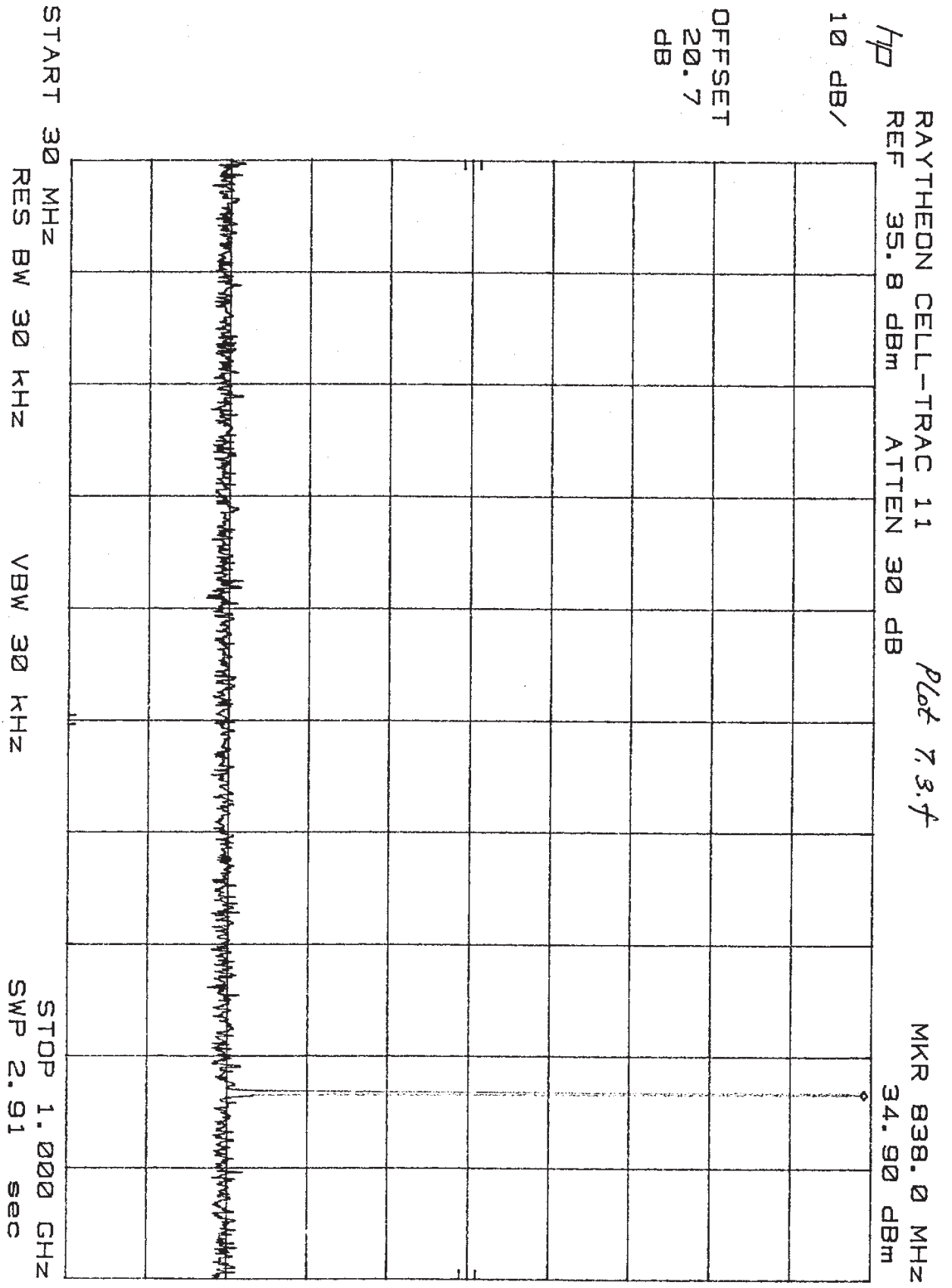

INTERTEK TESTING SERVICES

Raytheon TI Systems, Cellular Transceiver

Date of Test: Aug. 17, 1998 & Sept. 16, 1998

START 1.00 GHz RES BW 100 KHz VBW 100 KHz STOP 2.50 GHz
 SWP 450 msec

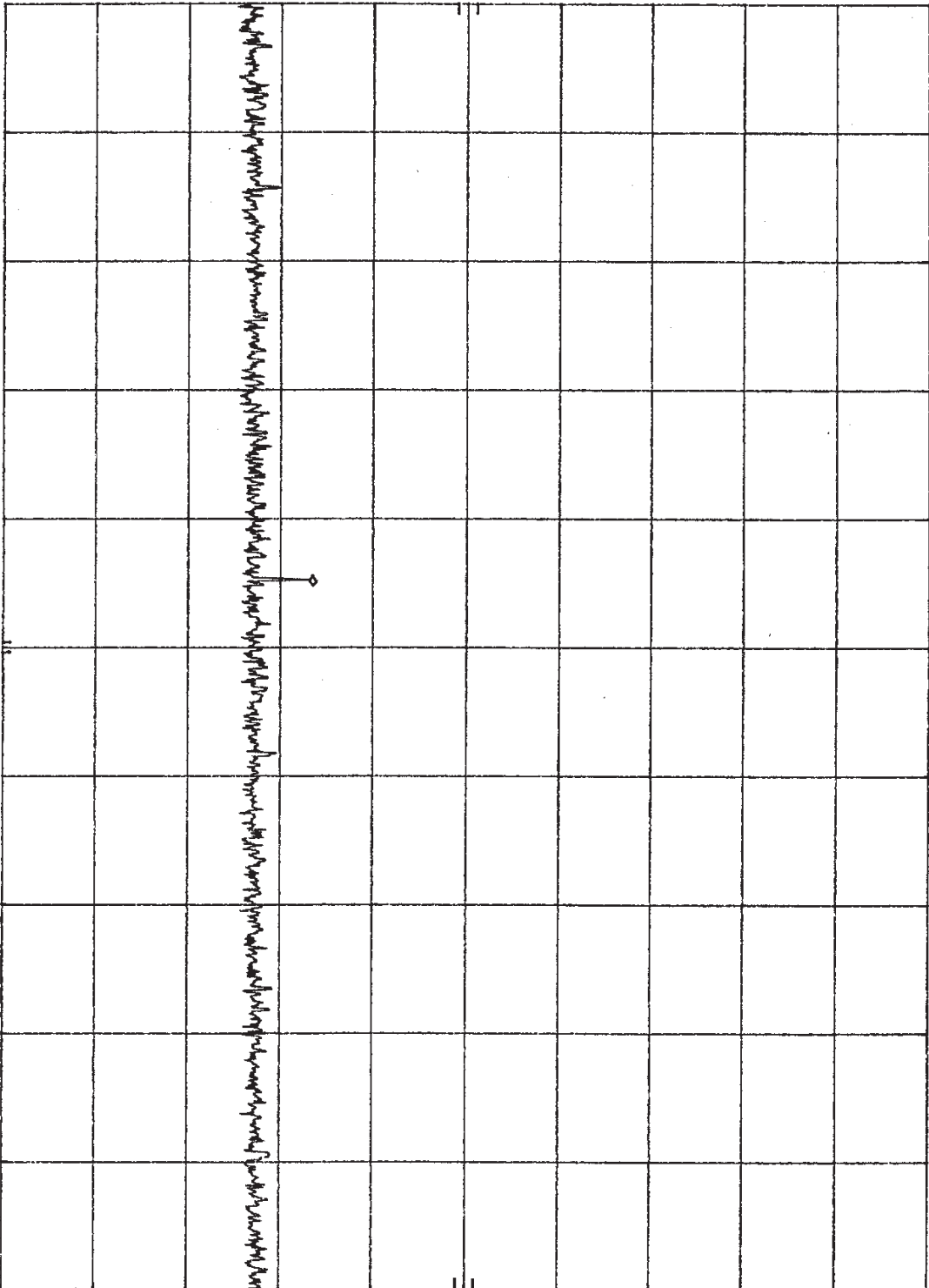

RAYTHEON CELL-TRAC 11 PLOT 7, 3, 9 MKR 1.672 GHz
 REF 35.8 DBm ATTEN 30 DB -30.70 DBm

OFFSET
 20.7
 DB

10 DB/

INTERTEK TESTING SERVICES

Raytheon TI Systems, Cellular Transceiver

Date of Test: Aug. 17, 1998 & Sept. 16, 1998

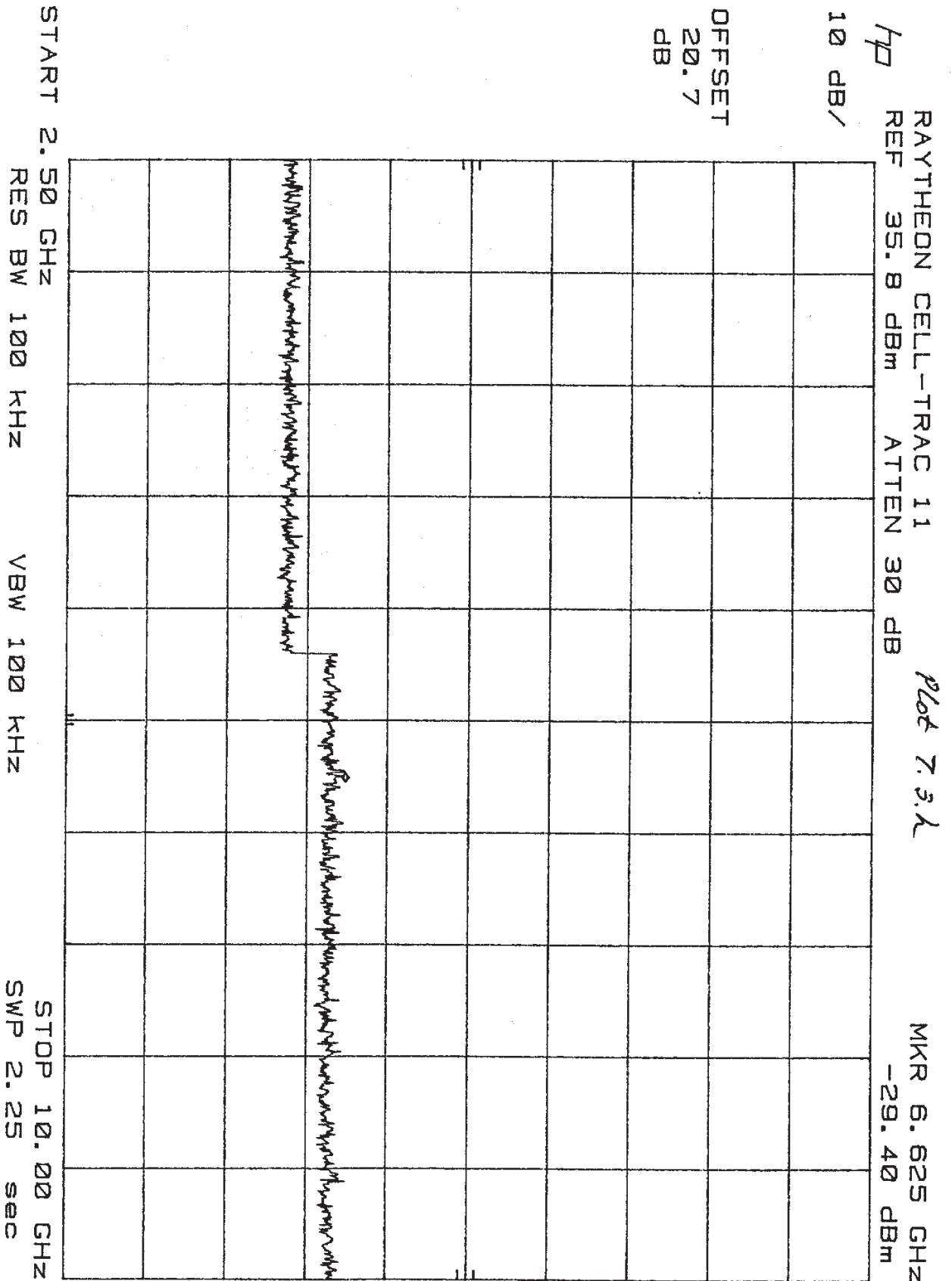

INTERTEK TESTING SERVICES

Raytheon TI Systems, Cellular Transceiver

Date of Test: Aug. 17, 1998 & Sept. 16, 1998

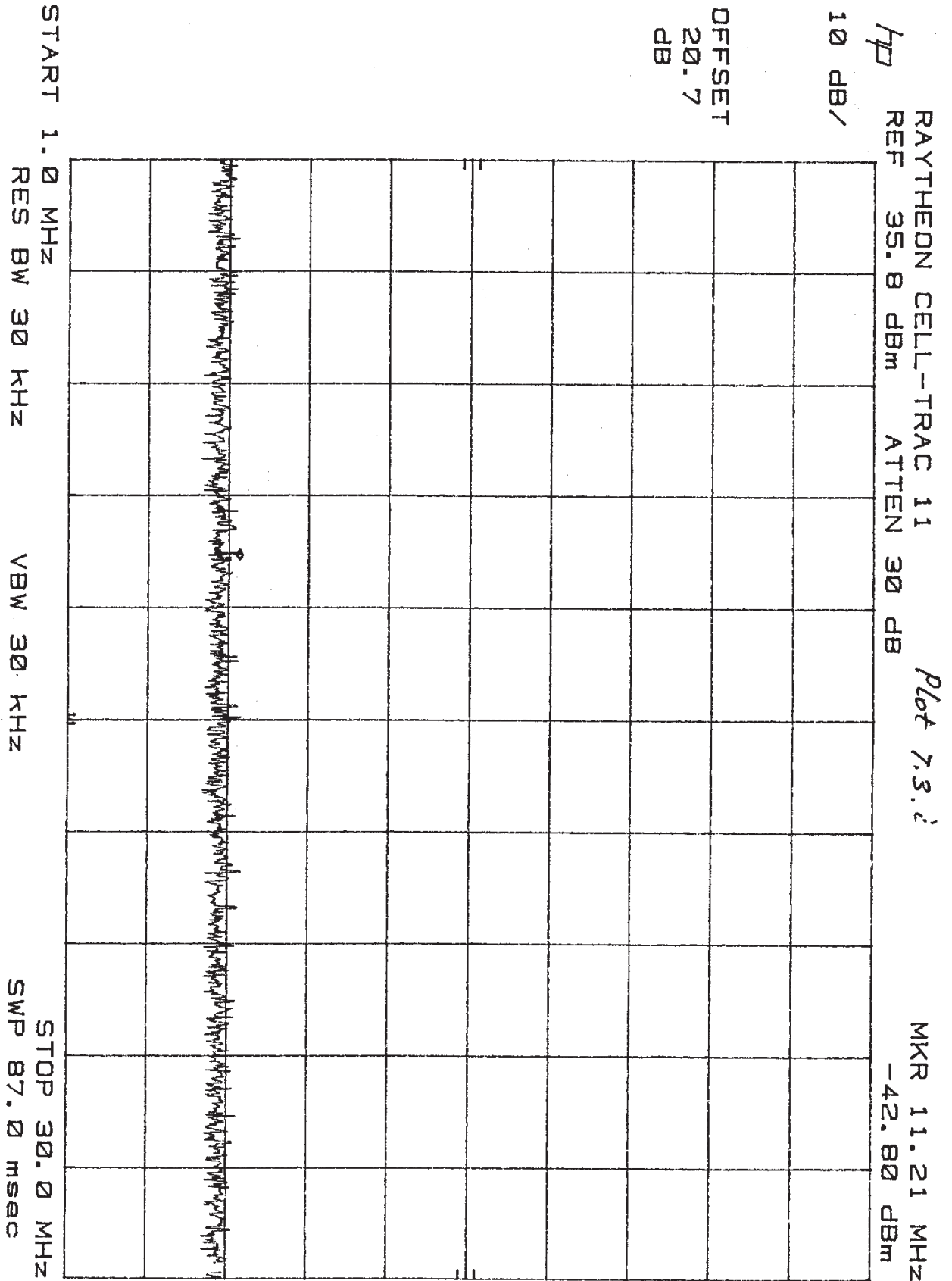

INTERTEK TESTING SERVICES

Raytheon TI Systems, Cellular Transceiver

Date of Test: Aug. 17, 1998 & Sept. 16, 1998

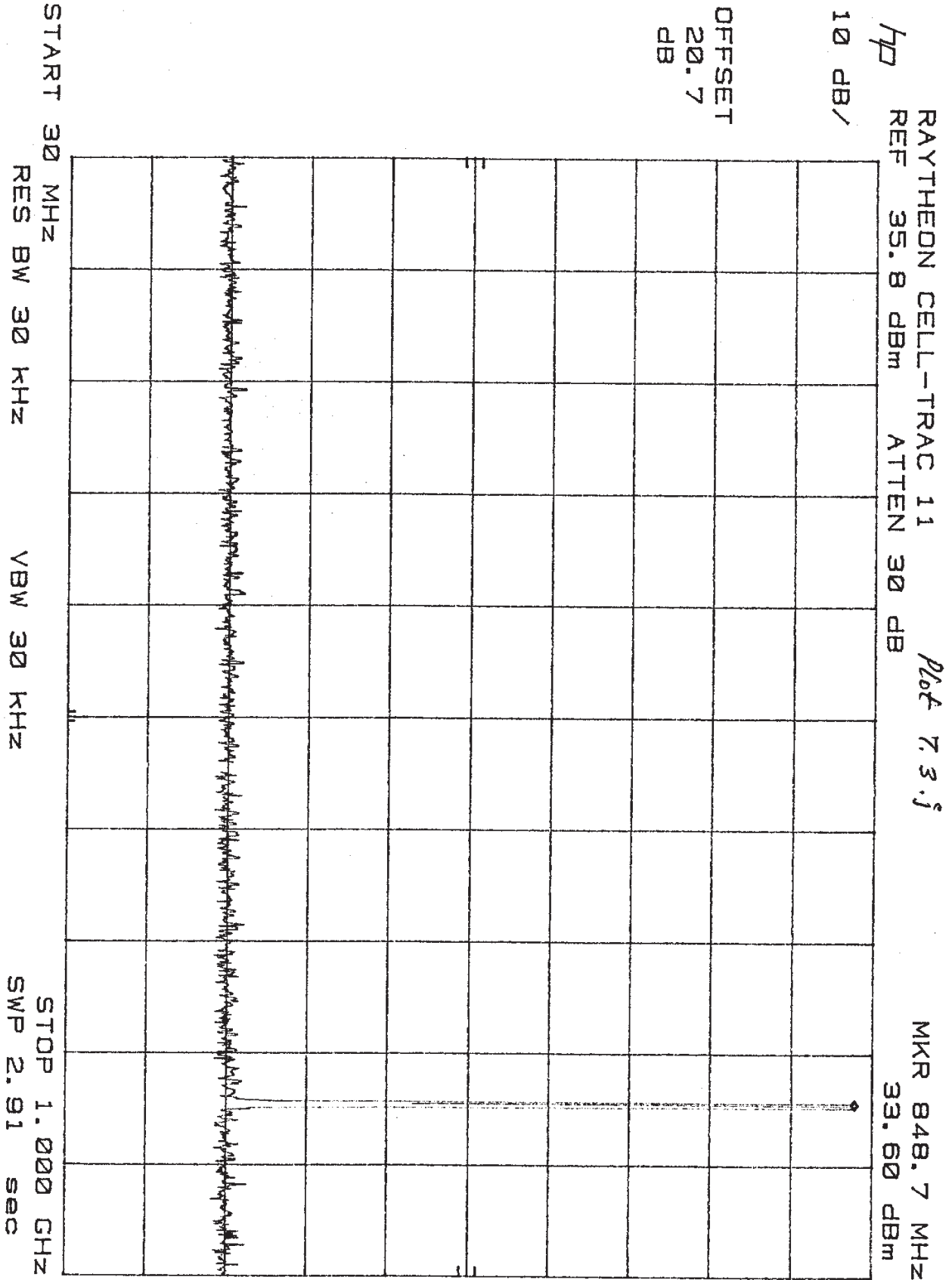

INTERTEK TESTING SERVICES

Raytheon TI Systems, Cellular Transceiver

Date of Test: Aug. 17, 1998 & Sept. 16, 1998

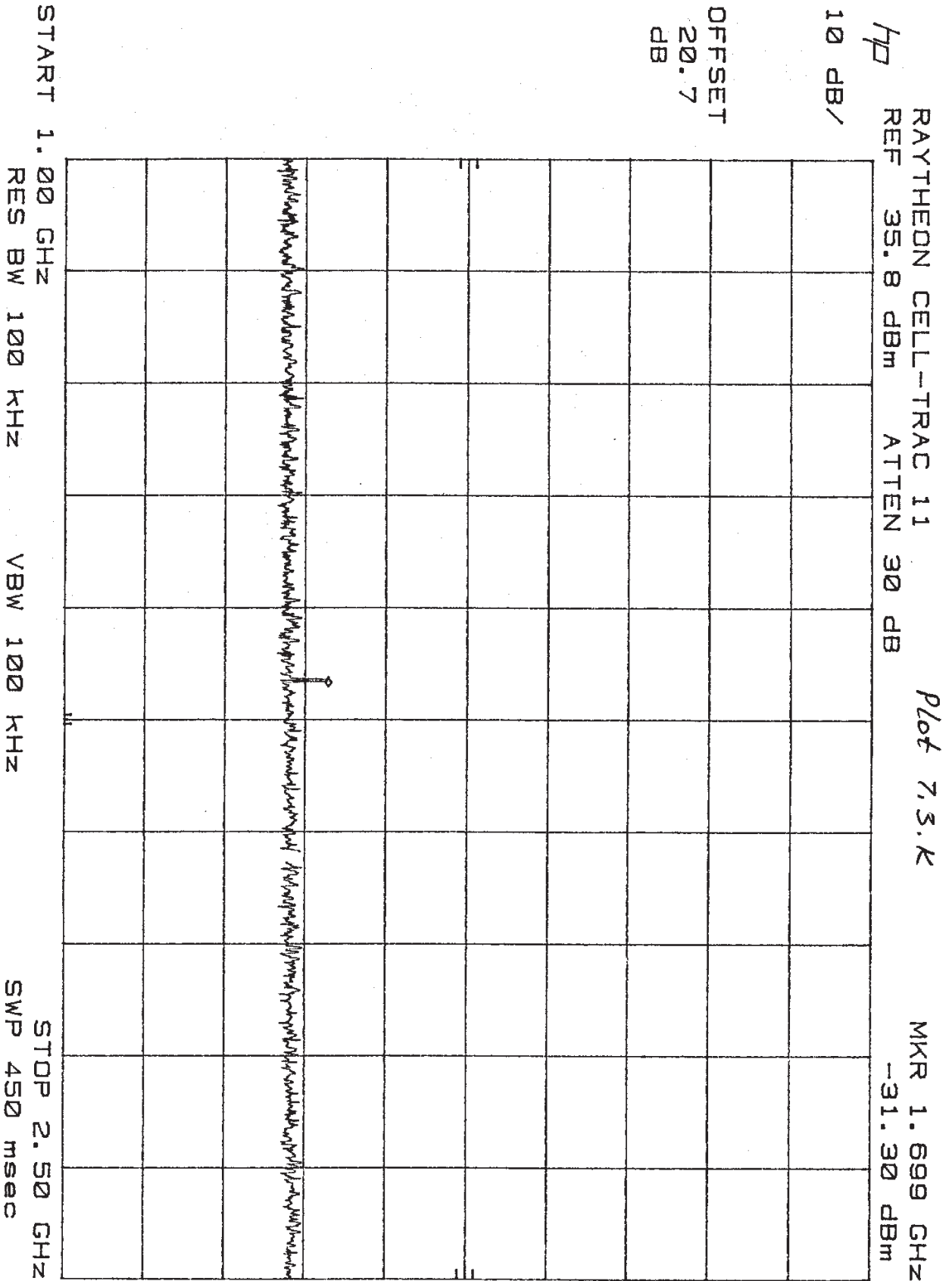

INTERTEK TESTING SERVICES

Raytheon TI Systems, Cellular Transceiver

Date of Test: Aug. 17, 1998 & Sept. 16, 1998

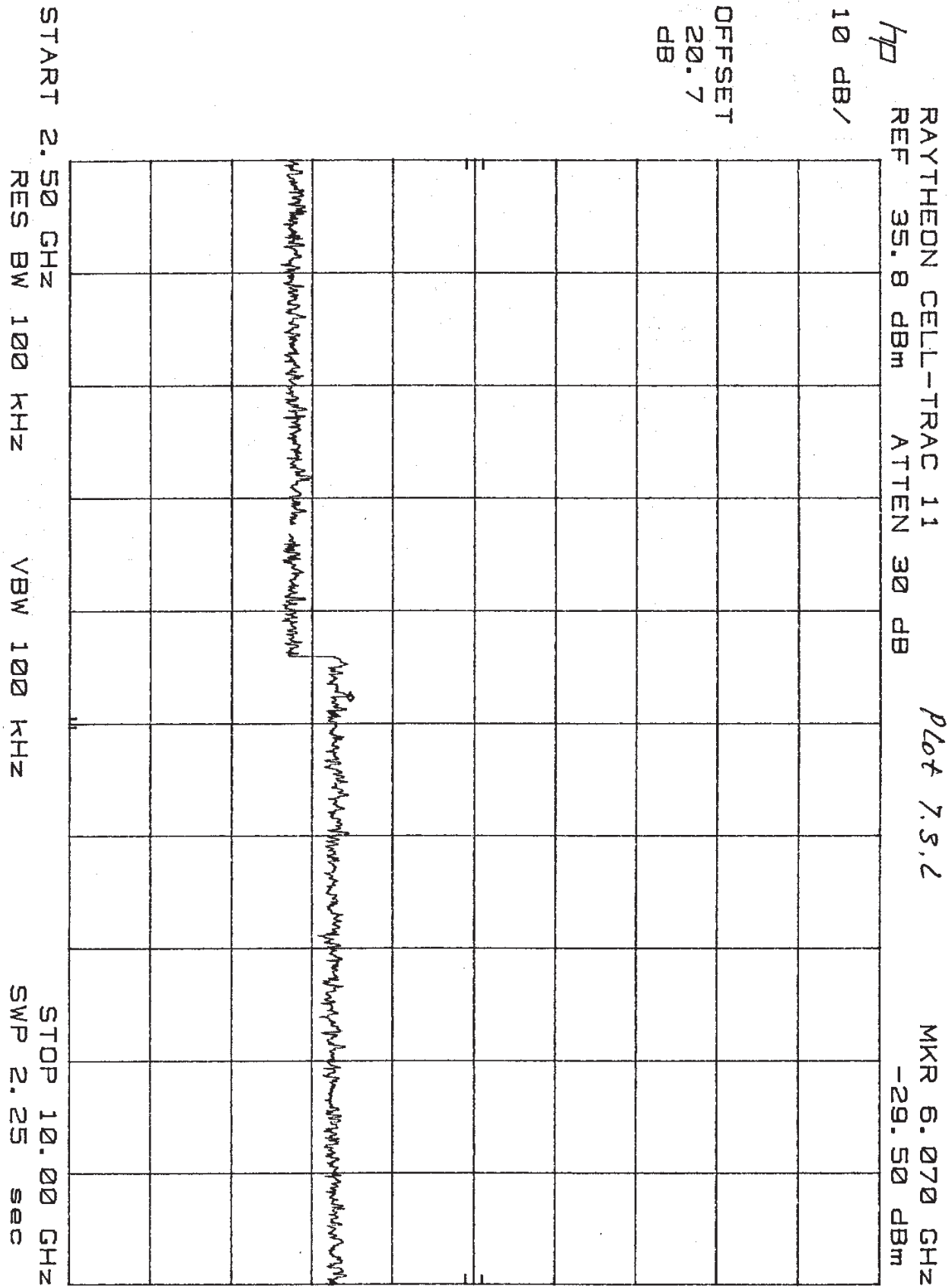

INTERTEK TESTING SERVICES

Raytheon TI Systems, Cellular Transceiver

Date of Test: Aug. 17, 1998 & Sept. 16, 1998

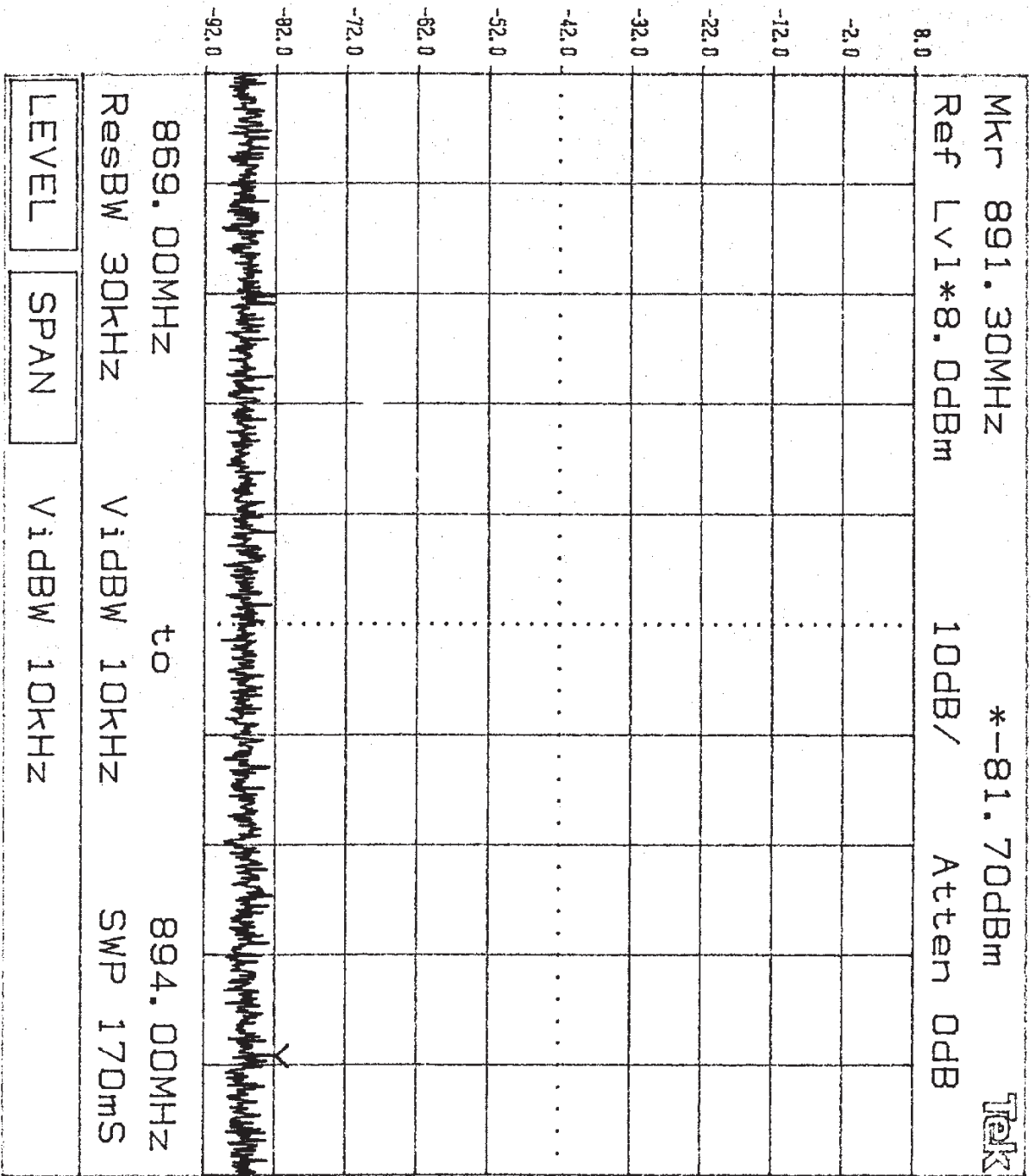

KNOB 2 KNOB 1 KEYPAD Tektronix 2784

Plot 7.3.m

INTERTEK TESTING SERVICES

Raytheon TI Systems, Cellular Transceiver

Date of Test: Aug. 17, 1998 & Sept. 16, 1998

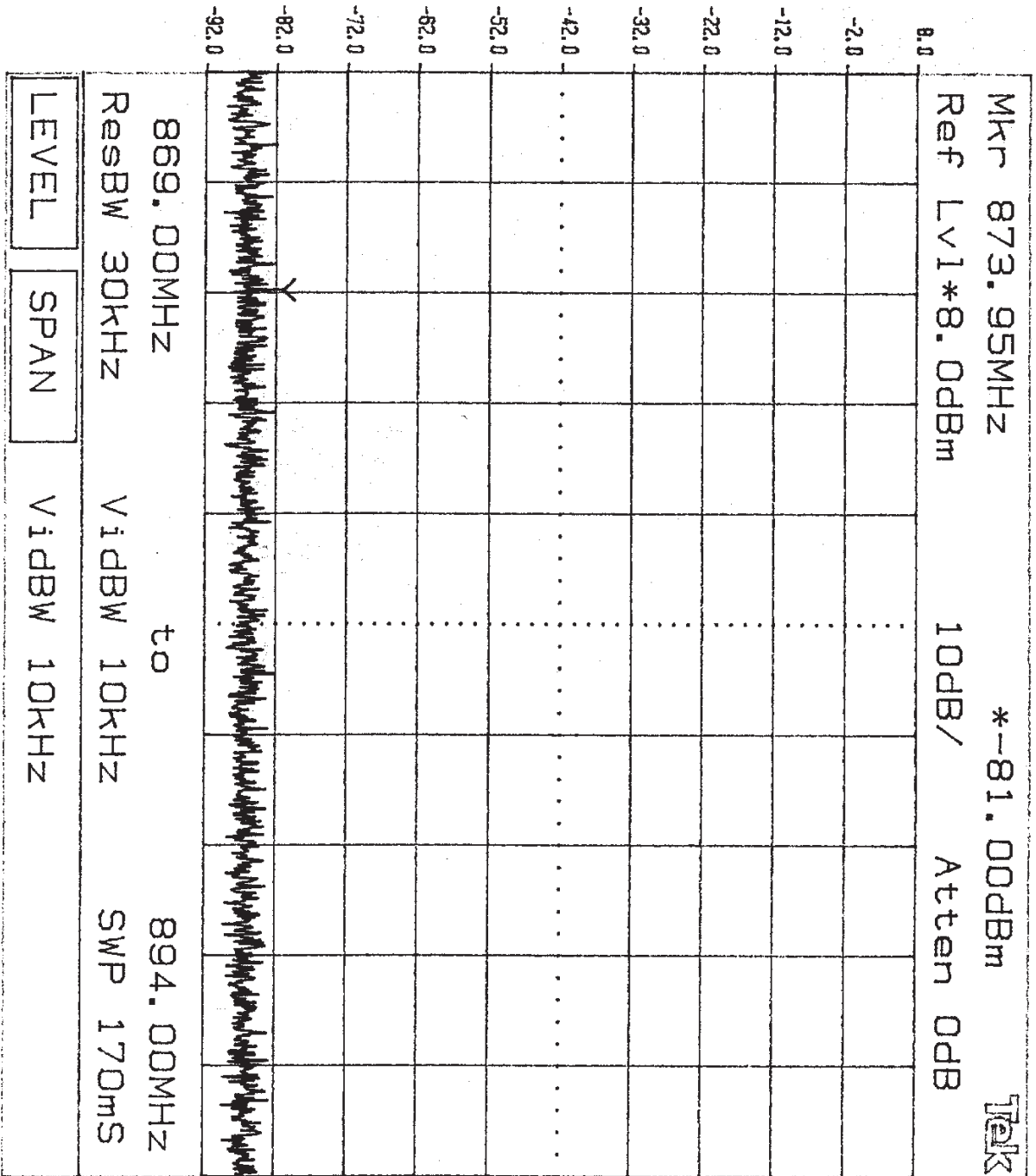

KNOB 2 KNOB 1 KEYPAD Tektronix 2784

Plot 7.3.2

INTERTEK TESTING SERVICES

Raytheon TI Systems, Cellular Transceiver

Date of Test: Aug. 17, 1998 & Sept. 16, 1998

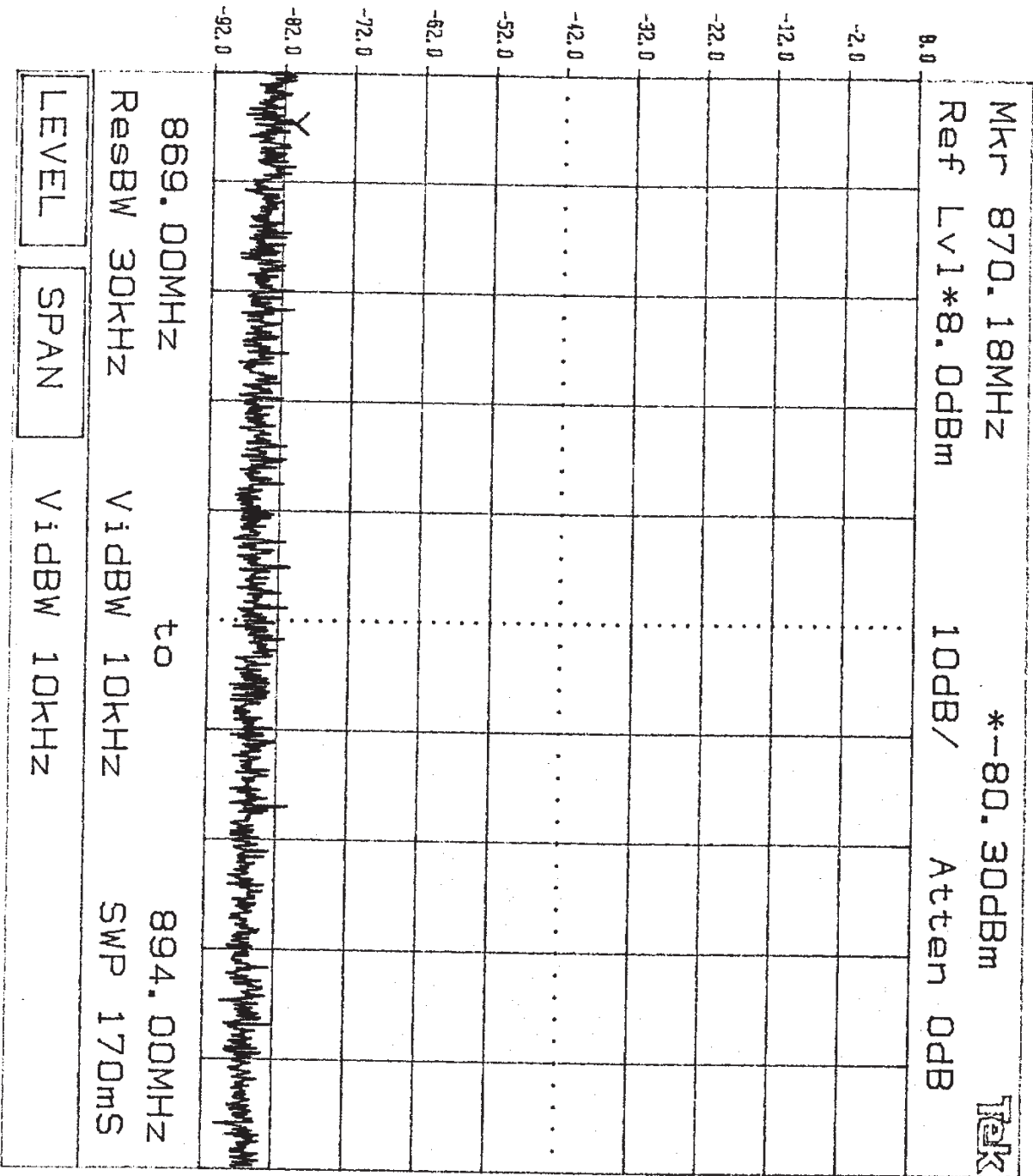

INTERTEK TESTING SERVICES

Raytheon TI Systems, Cellular Transceiver

Date of Test: Aug. 17, 1998 & Sept. 16, 1998

8.0 Field Strength of Spurious Radiation

Requirements: FCC 2.993, 22.917(e)

8.1 Test Procedure

The measurement antenna was placed at a distance of 3 meters from the EUT. During the tests, the antenna height and polarization as well as EUT azimuth were varied in order to identify the maximum level of emissions from the EUT.

The frequency range up to tenth harmonic of each of the three fundamental frequency (low, middle, and high channels) was investigated.

The spurious emissions attenuation was calculated as the difference between field strength in dBuV/m at the fundamental frequency (See Section 3) and at the spurious emissions frequency.

8.2 Test Equipment

EMCO 3115 Horn Antenna
HP 8566B Spectrum Analyzer
Tektronix 2782 Spectrum Analyzer
Low Pass Filter
Preamplifier

8.3 Test Results

Refer to the attached data sheets.

The EUT passed the test.

ITS Intertek Testing Services

Company: Raytheon Systems Company
Project #:
Model: Tx@824.04 MHz
Engineer: Xi-Ming Yang
Date of test: August 17, 1998

FCC Part 22 Radiated Emissions

Frequency	Antenna	Reading	Antenna	Pre-amp	Cable	Field	Spurious	Margin
MHz	Polarity	dB(uV)	Factor	dB	Loss	Strength	Attenuation	dB
	H/V		dB(1/m)		dB	dB(uV/m)	dB	
1648.1	V	74.0	26.7	-29.6	2.1	73.2	55.5	-8.6
2472.3	H	57.0	30.5	-28.4	3.6	62.7	66.0	-19.1
3296.2	H	52.0	32.7	-27.8	4.1	61.0	67.7	-20.8
4120.3	H	54.0	34.0	-27.6	4.5	64.9	63.8	-16.9
4944.2	H	52.0	35.1	-27.8	4.7	64.0	64.7	-17.8
5768.2	H	44.0	36.1	-28.0	5.1	57.2	71.5	-24.6
6592.3	H	35.0	37.2	-28.5	5.7	49.4	79.3	-32.4
7416.3	H	32.0	37.8	-29.0	6.1	46.9	81.8	-34.9
8240.3	H	36.0	38.8	-29.0	6.3	52.1	76.6	-29.7

- Note:
1. All measurement were made at 3 meters
 2. Field Strength at the fundamental frequency equals 128.7 dBuV/m
 3. Spurious emissions attenuation limit equals $43+10\log P = 46.9$ dB

ITS Intertek Testing Services

Company: Raytheon Systems Company
Project #:
Model: Tx@836.52 MHz
Engineer: Xi-Ming Yang
Date of test: August 17, 1998

FCC Part 22 Radiated Emissions

Frequency	Antenna	Reading	Antenna	Pre-amp	Cable	Field	Spurious	Margin
MHz	Polarity	dB(uV)	Factor	dB	Loss	Strength	Attenuation	dB
	H/V		dB(1/m)		dB	dB(uV/m)	dB	
1673.0	V	72.5	26.7	-29.6	2.1	71.7	60.9	-12.7
2509.6	V	59.0	30.5	-28.4	3.6	64.7	67.9	-19.7
3396.1	H	55.6	32.7	-27.8	4.1	64.6	68.0	-19.8
4182.6	V	54.0	34.0	-27.6	4.5	64.9	67.7	-19.5
5019.1	V	47.0	35.1	-27.8	4.7	59.0	73.6	-25.4
5856.6	H	42.0	36.1	-28.0	5.1	55.2	77.4	-29.2
6692.2	H	36.0	37.2	-28.5	5.7	50.4	82.2	-34.0
7528.7	H	35.0	37.8	-29.0	6.1	49.9	82.7	-34.5
8365.2	H	32.0	38.8	-29.0	6.3	48.1	84.5	-36.3

- Note:**
1. All measurement were made at 3 meters
 2. Field Strength at the fundamental frequency equals 132.6 dBuV/m
 3. Spurious emissions attenuation limit equals $43 + 10 \log P = 48.2$ dB

ITS Intertek Testing Services

Company: Raytheon Systems Company
Project #:
Model: Tx@848.97 MHz
Engineer: Xi-Ming Yang
Date of test: August 17, 1998

FCC Part 22 Radiated Emissions

Frequency MHz	Antenna Polarity H/V	Reading dB(uV)	Antenna Factor dB(1/m)	Pre-amp dB	Cable Loss dB	Field Strength dB(uV/m)	Spurious Attenuation dB	Margin dB
1696.8	V	72.7	26.7	-29.6	2.1	71.9	59.7	-11.6
2545.1	H	66.6	30.5	-28.4	3.6	72.3	59.3	-11.2
3393.4	H	52.9	32.7	-27.8	4.1	61.9	69.7	-21.6
4241.2	H	51.0	34.0	-27.6	4.5	61.9	69.7	-21.6
5089.5	V	43.0	35.1	-27.8	4.7	55.0	76.6	-28.5
5937.8	H	38.0	36.1	-28.0	5.1	51.2	80.4	-32.3
6786.1	V	30.0	37.2	-28.5	5.7	44.4	87.2	-39.1
7634.4	V	37.0	37.8	-29.0	6.1	51.9	79.7	-31.6
8482.8	V	31.0	38.8	-29.0	6.3	47.1	84.5	-36.4

- Note:
1. All measurement were made at 3 meters
 2. Field Strength at the fundamental frequency equals 131.6 dBuV/m
 3. Spurious emissions attenuation limit equals $43+10\log P = 48.1$ dB

ITS Intertek Testing Services

Company: Raytheon Systems Company
Project #:
Model:
Engineer: Xi-Ming Yang
Date of test: August 17, 1998

FCC 15 Class B Radiated Emissions

Low Channel

Frequency MHz	Antenna Polarity H/V	Reading dB(uV)	Antenna Factor dB(1/m)	Pre-amp dB	Cable Loss dB	Corrected Reading dB(uV/m)	Limit dB(uV/m)	Margin dB
914.0	V	26.0	23.0	-14.1	1.7	36.6	46.0	-9.4
1828.0	V	28.6	30.0	-29.1	2.3	31.8	54.0	-22.2
2742.1	V	34.6	31.3	-28.2	2.3	40.0	54.0	-14.0
3656.1	H	24.0	33.5	-27.8	2.8	32.5	54.0	-21.5

Mid Channel

926.5	V	24.0	23.3	-14.1	1.7	34.9	46.0	-11.1
1853.0	V	29.0	30.0	-29.1	2.3	32.2	54.0	-21.8
2779.5	H	42.0	31.3	-28.2	2.3	47.4	54.0	-6.6
3706.0	H	27.0	33.5	-27.8	2.8	35.5	54.0	-18.5

High Channel

933.0	V	25.0	23.3	-14.1	1.7	35.9	46.0	-10.1
1878.0	V	30.0	30.0	-29.1	2.3	33.2	54.0	-20.8
2816.9	H	38.0	31.3	-28.2	2.3	43.4	54.0	-10.6
3755.9	H	27.0	33.5	-27.8	2.8	35.5	54.0	-18.5

- Note:**
1. All measurement were made at 3 meters
 2. Negative signs (-) in the margin column signify levels below the limit.

ITS Intertek Testing Services

Company: Raytheon Systems Company
Project #:
Model:
Engineer: Xi-Ming Yang
Date of test: August 17, 1998

FCC15 Class B Radiated Emissions

Frequency	Antenna	Reading	Antenna	Pre-amp	Distance	Corrected	Limit	Margin
MHz	Polarity	dB(uV)	Factor	dB	Factor	Reading	dB(uV/m)	dB
87.0	V	24.5	7.6	0.0	0.0	32.1	40.0	-7.9
109.4	V	22.0	11.8	0.0	0.0	33.8	43.5	-9.7
113.7	V	21.0	12.2	0.0	0.0	33.2	43.5	-10.3
196.0	V	17.0	17.0	0.0	0.0	34.0	43.5	-9.5
280.0	H	9.0	14.1	0.0	0.0	23.1	46.0	-22.9
368.8	H	5.0	14.9	0.0	0.0	19.9	46.0	-26.1

- Note:**
- 1. All measurement were made at 3 meters**
 - 2. Negative signs (-) in the margin column signify levels below the limit.**

INTERTEK TESTING SERVICES

Raytheon TI Systems, Cellular Transceiver

Date of Test: Aug. 17, 1998 & Sept. 16, 1998

8.4 Test Configuration Setup

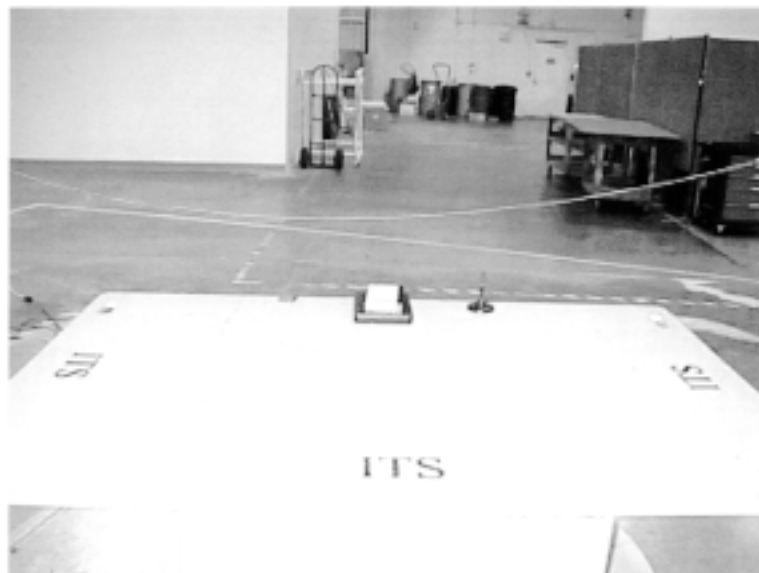
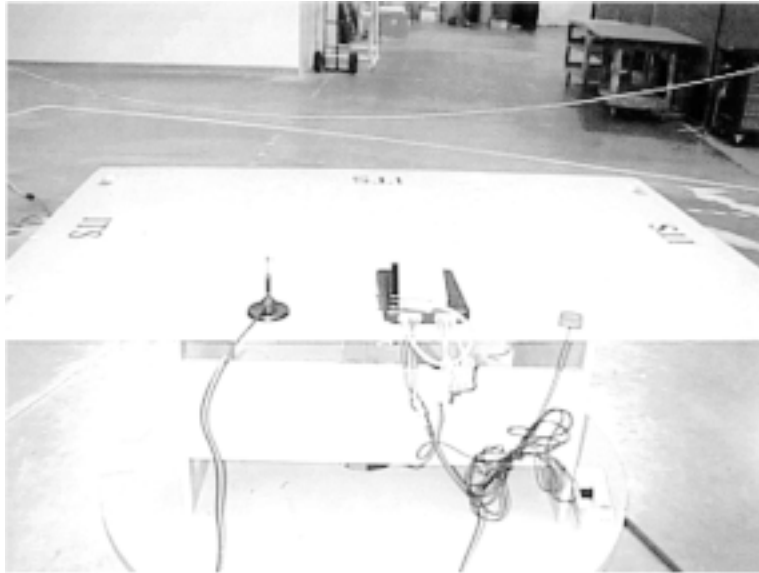

INTERTEK TESTING SERVICES

Raytheon TI Systems, Cellular Transceiver

Date of Test: Aug. 17, 1998 & Sept. 16, 1998

9.0 AC Line Conducted Emission

9.1 Test Procedure

The test was done according to the ANSI C63.4 procedure.

9.2 Test Equipment

HP 8566B Spectrum Analyzer

EMCO LISN

9.3 Test Results

Not applicable, the EUT is battery operated only.

INTERTEK TESTING SERVICES

Raytheon TI Systems, Cellular Transceiver

Date of Test: Aug. 17, 1998 & Sept. 16, 1998

10.0 Frequency Stability vs Temperature

Requirements: FCC 2.995(a), 22.355

Frequency Tolerance: ± 2.5 ppm

10.1 Test Procedure

The equipment under test was connected to an external DC power supply and the RF output was connected to a calibrated coaxial attenuator, the other end of which was connected to a frequency counter. The EUT was placed inside the temperature chamber. The DC leads, RF output cable, and external computer control cable exited the chamber through an opening made for that purpose.

After the temperature stabilized for approximately 20 minutes, the external computer activated the transmitter and the frequency output was recorded from the counter.

10.2 Test Equipment

Temperature Chamber, -50C to +100C

Hewlett Packard 5383A Frequency Counter

Goldstar DC Power Supply, GR303

Rohde & Schwarz ESVP Test Receiver

10.3 Test Results

Refer to the attached data sheet.

The EUT passed the test.

INTERTEK TESTING SERVICES

Raytheon TI Systems, Cellular Transceiver

Date of Test: Aug. 17, 1998 & Sept. 16, 1998

Company: Raytheon TI Systems
Model No.: CELL-TRAC™ II
Test Mode: TX @836.01 MHz

LTO# J98023875
Test Site #1
Engineer: Xi-Ming Yang

Frequency Stability vs. Temperature

Frequency: 835.32 MHz

Tolerance: +/-2088 Hz

Temperature (C)	Frequency (MHz)	Difference (Hz)	Output Power (dBm)
50	835.318880	-1120	34.8
40	835.318710	-1290	35.1
30	835.318420	-1580	35.6
20	835.318730	-1270	35.4
10	835.319510	-490	36.0
0	835.319900	-100	36.3
-10	835.320520	+520	36.1
-20	835.321610	+1610	35.4
-30	835.319000	-1000	34.7

INTERTEK TESTING SERVICES

Raytheon TI Systems, Cellular Transceiver

Date of Test: Aug. 17, 1998 & Sept. 16, 1998

11.0 Frequency Stability vs Voltage

Requirements: FCC 2.995(d)(2), 22.355

Frequency Tolerance: ± 2.5 ppm

11.1 Test Procedure

An external variable DC power supply was connected to the battery terminals of the equipment under test. The voltage was set to 115% of the nominal value and was then decreased until the transmitter light no longer illuminates; i.e., the battery end point. The output frequency was recorded for each battery voltage.

11.2 Test Equipment

Hewlett Packard 5383A Frequency Counter

DC Power Supply

Goldstar Rohde & Schwarz ESVPGR303 Test Receiver

11.3 Test Results

Refer to the attached sheet.

The EUT passed the test.

INTERTEK TESTING SERVICES

Raytheon TI Systems, Cellular Transceiver

Date of Test: Aug. 17, 1998 & Sept. 16, 1998

Company: Raytheon TI Systems
Model No.: CELL-TRAC™ II
Test Mode: TX @836.01 MHz

LTO# J98023875
Test Site #1
Engineer: Xi-Ming Yang

Frequency Stability vs. Temperature

Frequency: 835.32 MHz

Tolerance: +/-2088 Hz

DC Volts		Frequency (MHz)	Difference (Hz)
85%	10.5	835.319970	-30
100%	12.35	835.320050	+50
115%	14.2	835.320010	+10
Minimum	10.0	835.320395	+395