



Hearing Aid Compatibility (HAC) RF Emissions Test Report

for

High Tech Computer Corp.

on the

Smart Phone

Report No. : HA821901
Trade Name : hTC
Model Name : CONV100
FCC ID : NM8CV
Date of Testing : Mar. 18, 2008
Date of Report : Apr. 02, 2008
Date of Review : Apr. 02, 2008

- **Results Summary : M Category = M3**
- The test results refer exclusively to the presented test model/sample only.
- Without written approval of SPORTON International Inc., the test report shall not be reproduced except in full.
- Report Version: Rev.01

SPORTON International Inc.

No. 52, Hwa Ya 1st Rd., Hwa Ya Technology Park, Kwei-Shan Hsiang, Tao Yuan Hsien, Taiwan, R.O.C.



Table of Contents

1. Statement of Compliance1
2. Administration Data2
2.1 Testing Laboratory2
2.2 Detail of Applicant2
2.3 Detail of Manufacturer2
2.4 Application Details2
3. General Information3
3.1 Description of Device Under Test (DUT)3
3.2 Applied Standards4
3.4 Test Conditions5
3.4.1 Ambient Condition5
3.4.2 Test Configuration5
4. Hearing Aid Compliance (HAC)6
4.1 Introduction6
5. HAC Measurement Setup7
5.1 DASY4 E-Field and H-Field Probe System8
5.2 System Specification9
5.2.1 ER3DV6 E-Field Probe Description9
5.2.2 H3DV6 H-Field Probe Description9
5.2.3 Probe Tip Description10
5.3 DATA Acquisition Electronics (DAE)12
5.4 Robot12
5.5 Measurement Server12
5.6 Phone Positioner13
5.6.1 Test Arch Phantom14
5.7 Data Storage and Evaluation15
5.7.1 Data Storage15
5.7.2 Data Evaluation15
5.8 Test Equipment List17
6. Uncertainty Assessment18
7. HAC Measurement Evaluation20
7.1 Purpose of System Performance check20
7.2 System Setup20
7.3 Validation Results22
8. RF Field Probe Modulation Factor23
9. Description for DUT Testing Position26
10. RF Emissions Test Procedure27
11. HAC Test Results28
11.1 E-Field Emission28
11.2 H-Field Emission29
12. References30

- Appendix A - System Performance Check Data
Appendix B - HAC Measurement Data
Appendix C - Calibration Date
Appendix D - Setup Photographs



1. Statement of Compliance

The Hearing Aid Compliance (HAC) maximum results found during testing for the High Tech Computer Corp. Smart Phone hTC CONV100 are as follows (with expanded uncertainty $\pm 29.4\%$ for E-field and $\pm 21.8\%$ for H-field):

Band	E-Field (V/m)	M Rating	H-Field (A/m)	M Rating
GSM850	178.9	M3	0.172	M4
PCS1900	79.2	M3	0.085	M4

They are in compliance with HAC limits specified in guidelines FCC 47CFR §20.19 and ANSI Standard ANSI C63.19 for HAC Rated category M3.

Results Summary : M Category = M3

Approved by

Roy Wu
Manager



2. Administration Data

2.1 Testing Laboratory

Company Name : Sporton International Inc.
Department : Antenna Design/SAR
Address : No.52, Hwa-Ya 1st RD., Hwa Ya Technology Park, Kwei-Shan Hsiang, TaoYuan Hsien, Taiwan, R.O.C.
Telephone Number : 886-3-327-3456
Fax Number : 886-3-328-4978

2.2 Detail of Applicant

Company Name : High Tech Computer Corp.
Address : No. 23, Xinghua Rd., Taoyuan City, Taoyuan County 330, Taiwan

2.3 Detail of Manufacturer

Company Name : High Tech Computer Corp.
Address: No. 23, Xinghua Rd., Taoyuan City, Taoyuan County 330, Taiwan

2.4 Application Details

Date of reception of application: Feb. 19, 2008
Start of test : Mar. 18, 2008
End of test : Mar. 18, 2008



3. General Information

3.1 Description of Device Under Test (DUT)

Product Feature & Specification	
DUT Type :	Smart Phone
Trade Name :	hTC
Model Name :	CONV100
FCC ID :	NM8CV
Tx Frequency :	GSM850 : 826 MHz ~ 847 MHz PCS1900 : 1852 MHz ~1908 MHz Bluetooth : 2400 MHz ~ 2483.5 MHz WLAN : 2400 MHz ~ 2483.5 MHz
Rx Frequency :	GSM850 : 871 MHz ~ 892 MHz PCS1900 : 1932 MHz ~ 1988 MHz Bluetooth : 2400 MHz ~ 2483.5 MHz WLAN : 2400 MHz ~ 2483.5 MHz
Maximum Output Power to Antenna :	GSM850 : 32.64 dBm PCS1900 : 29.48 dBm
Antenna Type :	GSM : Fixed Internal Bluetooth : PIFA Antenna WLAN : PIFA Antenna
Antenna Gain :	GSM : 0 dBi Bluetooth : 0.5 dBi WLAN : 1 dBi
HW Version :	XA
SW Version :	W15.18.0.10
Type of Modulation :	GSM : GMSK Bluetooth : GFSK WLAN : DSSS / OFDM
DUT Stage :	Production Unit

3.2 Applied Standards

The ANSI Standard ANSI C63.19:2006 represents performance requirements for acceptable interoperability of hearing aids with wireless communications devices. When these parameters are met, a hearing aid operates acceptably in close proximity to a wireless communications device.

The following AWF factors shall be used for the standard transmission protocols:

Standard	Technology	AWF (dB)
TIA/EIA/IS-2000	CDMA	0
TIA/EIA-136	TDMA (50 Hz)	0
J-STD-007	GSM (217)	-5
T1/T1P1/3GPP	UMTS (WCDMA)	0
iDENTM	TDMA (22 and 11 Hz)	0

Table 3.1 Articulation Weighting Factor (AWF)

Category	Telephone RF Parameters				
	AWF	E-Field Emissions		H-Field Emissions	
< 960 MHz					
Category M1	0	631.0 – 1122.0	V/m	1.91 – 3.39	A/m
	-5	473.2 – 841.4	V/m	1.43 – 2.54	A/m
Category M2	0	354.8 – 631.0	V/m	1.07 – 1.91	A/m
	-5	266.1 – 473.2	V/m	0.80 – 1.43	A/m
Category M3	0	199.5 – 354.8	V/m	0.6 – 1.07	A/m
	-5	149.6 – 266.1	V/m	0.45 – 0.80	A/m
Category M4	0	< 199.5	V/m	< 0.60	A/m
	-5	< 149.6	V/m	< 0.45	A/m
> 960 MHz					
Category M1	0	199.5 – 354.8	V/m	0.60 – 1.07	A/m
	-5	149.6 – 266.1	V/m	0.45 – 0.80	A/m
Category M2	0	112.2 – 199.5	V/m	0.34 – 0.60	A/m
	-5	84.1 – 149.6	V/m	0.25 – 0.45	A/m
Category M3	0	63.1 – 112.2	V/m	0.19 – 0.34	A/m
	-5	47.3 – 84.1	V/m	0.14 – 0.25	A/m
Category M4	0	< 63.1	V/m	< 0.19	A/m
	-5	< 47.3	V/m	< 0.14	A/m

Table 3.2 Telephone near-field categories in linear units



3.4 Test Conditions

3.4.1 Ambient Condition

Ambient Temperature (°C)	20-24°C
Humidity (%)	<60%

3.4.2 Test Configuration

The device was controlled by using a base station emulator R&S CMU200. Communication between the device and the emulator was established by air link.

Measurements were performed on the low, middle and high channels of both bands.

The DUT was set from the emulator to radiate maximum output power during all testings.



4. Hearing Aid Compliance (HAC)

4.1 Introduction

The federal communication commission (FCC) adopted ANSI C63.19 as HAC test standard.

5. HAC Measurement Setup

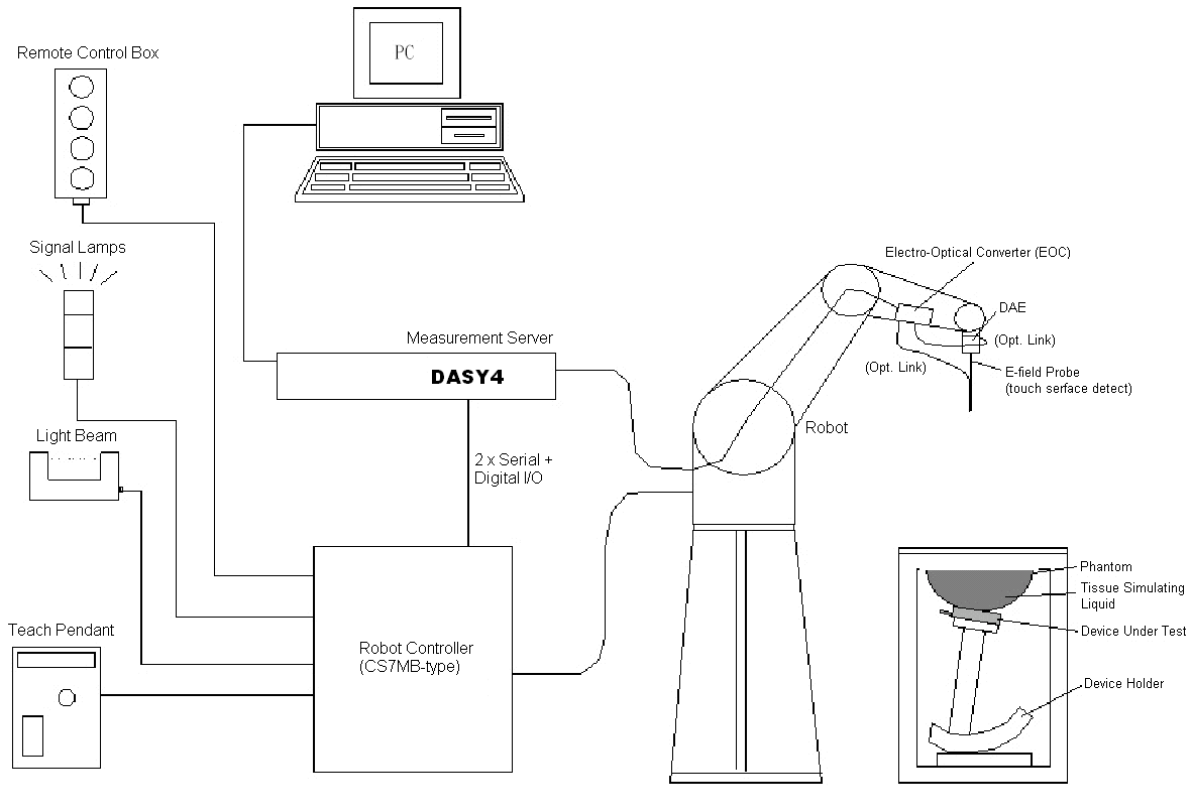

Fig. 5.1 DASY4 system



The DASY4 system for performance compliance tests is illustrated above graphically. This system consists of the following items:

- A standard high precision 6-axis robot with controller, a teach pendant and software
- A data acquisition electronic (DAE) attached to the robot arm extension
- A dosimetric probe equipped with an optical surface detector system
- The electro-optical converter (EOC) performs the conversion between optical and electrical signals
- A measurement server performs the time critical tasks such as signal filtering, control of the robot operation and fast movement interrupts.
- A probe alignment unit which improves the accuracy of the probe positioning
- A computer operating Windows XP
- DASY4 software
- Remote control with teach pendant and additional circuitry for robot safety such as warning lamps, etc.
- The SAM twin phantom
- A device holder
- Dipole for evaluating the proper functioning of the system
- Arch Phantom

Some of the components are described in details in the following sub-sections.

5.1 DASY4 E-Field and H-Field Probe System

The HAC measurement is conducted with the dosimetric probe ER3DV6 and H3DV6 (manufactured by SPEAG). The probe is specially designed and calibrated. This probe has a built in optical surface detection system to prevent from collision with DUT.

5.2 System Specification

5.2.1 *ER3DV6 E-Field Probe Description*

Construction	One dipole parallel, two dipoles normal to probe axis Built-in shielding against static charges
Calibration	In air from 100 MHz to 3.0 GHz (absolute accuracy $\pm 6.0\%$, $k=2$)
Frequency	100 MHz to 6 GHz; Linearity: ± 2.0 dB (100 MHz to 3 GHz)
Directivity	± 0.2 dB in air (rotation around probe axis) ± 0.4 dB in air (rotation normal to probe axis)
Dynamic Range	2 V/m to 1000 V/m (M3 or better device readings fall well below diode compression point)
Linearity	± 0.2 dB
Dimensions	Overall length: 330 mm (Tip: 16 mm) Tip diameter: 8 mm (Body: 12 mm) Distance from probe tip to dipole centers: 2.5 mm

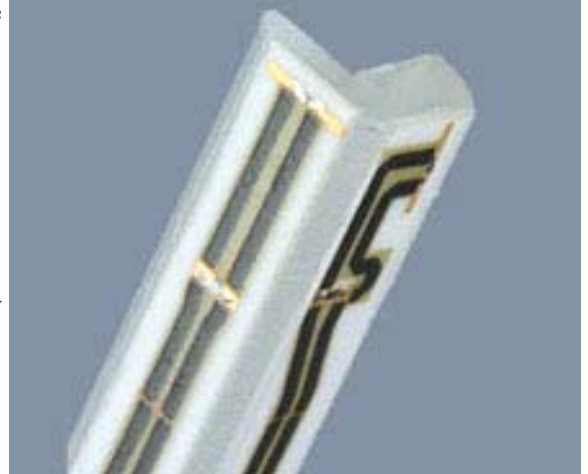

Fig. 5.2
E-field Free-space Probe

5.2.2 *H3DV6 H-Field Probe Description*

Construction	Three concentric loop sensors with 3.8 mm loop diameters Resistively loaded detector diodes for linear response Built-in shielding against static charges
Frequency	200 MHz to 3 GHz (absolute accuracy $\pm 6.0\%$, $k=2$); Output linearized
Directivity	± 0.25 dB (spherical isotropy error)
Dynamic Range	10 m A/m to 2 A/m at 1 GHz (M3 or better device readings fall well below diode compression point)
Dimensions	Overall length: 330 mm (Tip: 40 mm) Tip diameter: 6 mm (Body: 12 mm) Distance from probe tip to dipole centers: 3 mm
E-Field Interference	$< 10\%$ at 3 GHz (for plane wave)



Fig. 5.3
H-field Free-space Probe

5.2.3 Probe Tip Description

HAC field measurements take place in the close near field with high gradients. Increasing the measuring distance from the source will generally decrease the measured field values (in case of the validation dipole approx. 10% per mm).

Magnetic field sensors are measuring the integral of the H-field across their sensor area surrounded by the loop. They are calibrated in a precise, homogeneous field. When measuring a gradient field, the result will be very close to the field in the center of the loop which is equivalent to the value of a homogeneous field equivalent to the center value. But it will be different from the field at the field at the border of the loop.

Consequently, two sensors with different loop diameters – both calibrated ideally – would give different results when measuring from the edge of the probe sensor elements. The behavior for electrically small E-field sensors is equivalent. See below for distance plots from a WD which show the conservative nature of field readings at the probe element center vs. measurements at the sensor end:

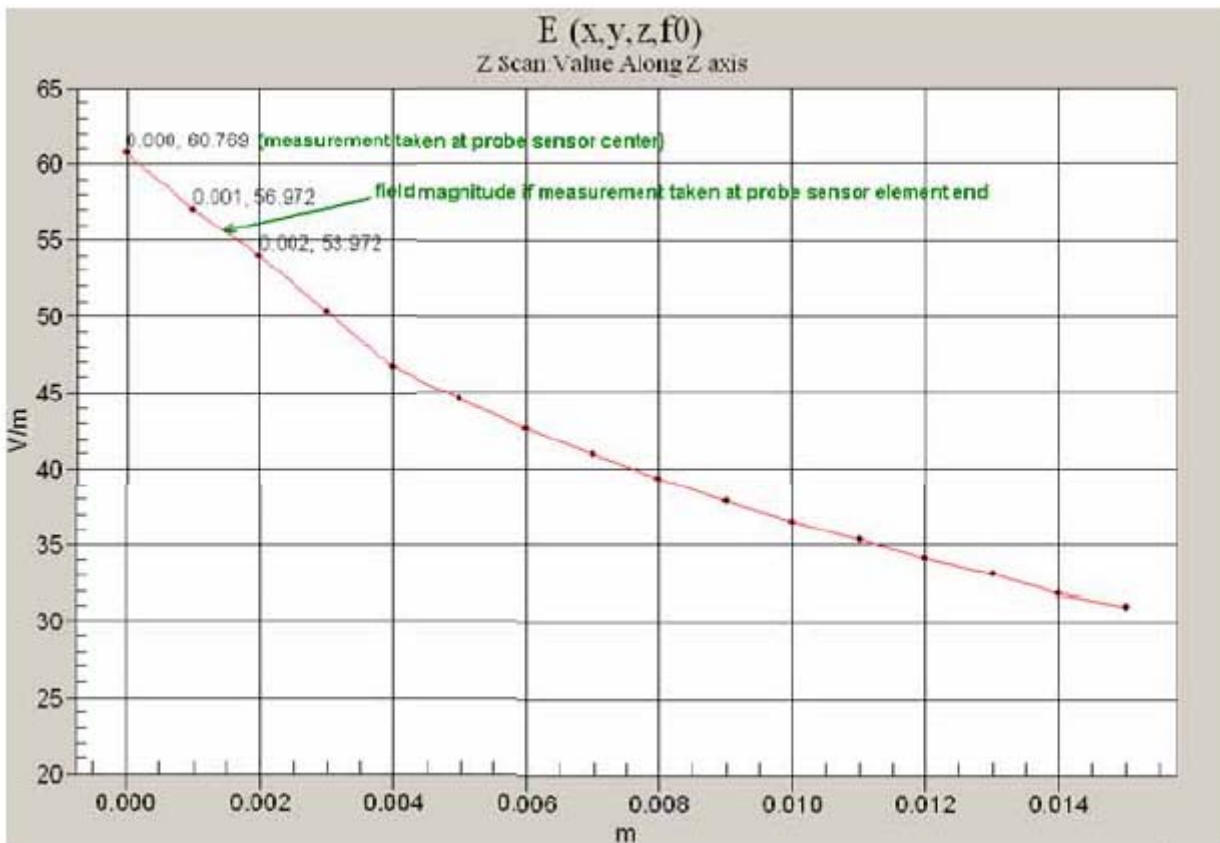

Fig. 5.4 Z-Axis Scan at maximum point above a typical wireless device for E-field

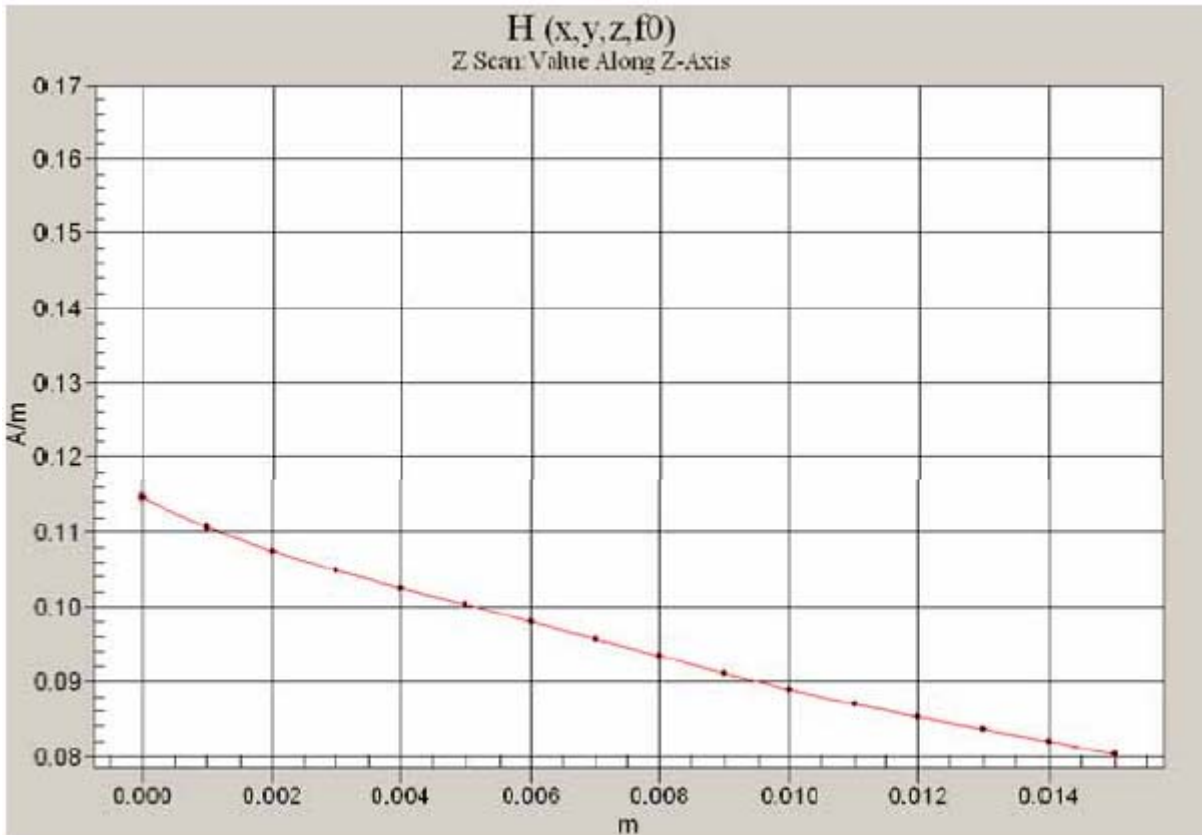

Fig. 5.5 Z-Axis Scan at maximum point above a typical wireless device for H-field

The magnetic field loops of the H3D probes are concentric, with the center 3mm from the tip for H3DV6. Their radius is 1.9 mm.

The electric field probes have a more irregular internal geometry because it is physically not possible to have the 3 orthogonal sensors situated with the same center. The effect of the different sensor centers is accounted for in the HAC uncertainty budget (“sensor displacement”). Their geometric center is at 2.5 mm from the tip, and the element ends are 1.1 mm closer to the tip.

Where:

Peak Field = Peak field (in dB V/m or dB A/m)

Raw = Raw field measurement from the measurement system (in V/m or A/m).

PMF = Probe Modulation Factor (in Linear units). See Chapter 8 of test report.



5.3 DATA Acquisition Electronics (DAE)

The data acquisition electronics (DAE4) consists of a highly sensitive electrometer-grade preamplifier with auto-zeroing, a channel and gain-switching multiplexer, a fast 16 bit AD-converter and a command decoder and control logic unit. Transmission to the measurement server is accomplished through an optical downlink for data and status information as well as an optical uplink for commands and the clock.

The mechanical probe mounting device includes two different sensor systems for frontal and sideways probe contacts. They are used for mechanical surface detection and probe collision detection.

The input impedance of the DAE4 is 200M Ohm; the inputs are symmetrical and floating. Common mode rejection is above 80dB.

5.4 Robot

The DASY4 system uses the high precision robots RX90BL type out of the newer series from Stäubli SA (France). For the 6-axis controller DASY4 system, the CS7MB robot controller version from Stäubli is used. The RX robot series have many features that are important for our application:

- High precision (repeatability 0.02 mm)
- High reliability (industrial design)
- Jerk-free straight movements
- Low ELF interference (the closed metallic construction shields against motor control fields)
- 6-axis controller

5.5 Measurement Server

The DASY4 measurement server is based on a PC/104 CPU board with
166 MHz CPU
32 MB chipset and
64 MB RAM.

Communication with
the DAE4 electronic box
the 16-bit AD-converter system for optical detection and digital I/O interface.

The measurement server performs all the real-time data evaluation for field measurements and surface detection, controls robot movements and handles safety operations.

5.6 Phone Positioner

The phone positioner shown in Fig. 5.8 is used to adjust DUT to the suitable position.



Fig. 5.6 Phone Positioner

5.6.1 Test Arch Phantom

Construction	Enables easy and well defined positioning of the phone and validation dipoles as well as simple teaching of the robot.
Dimensions	370 x 370 x 370 mm

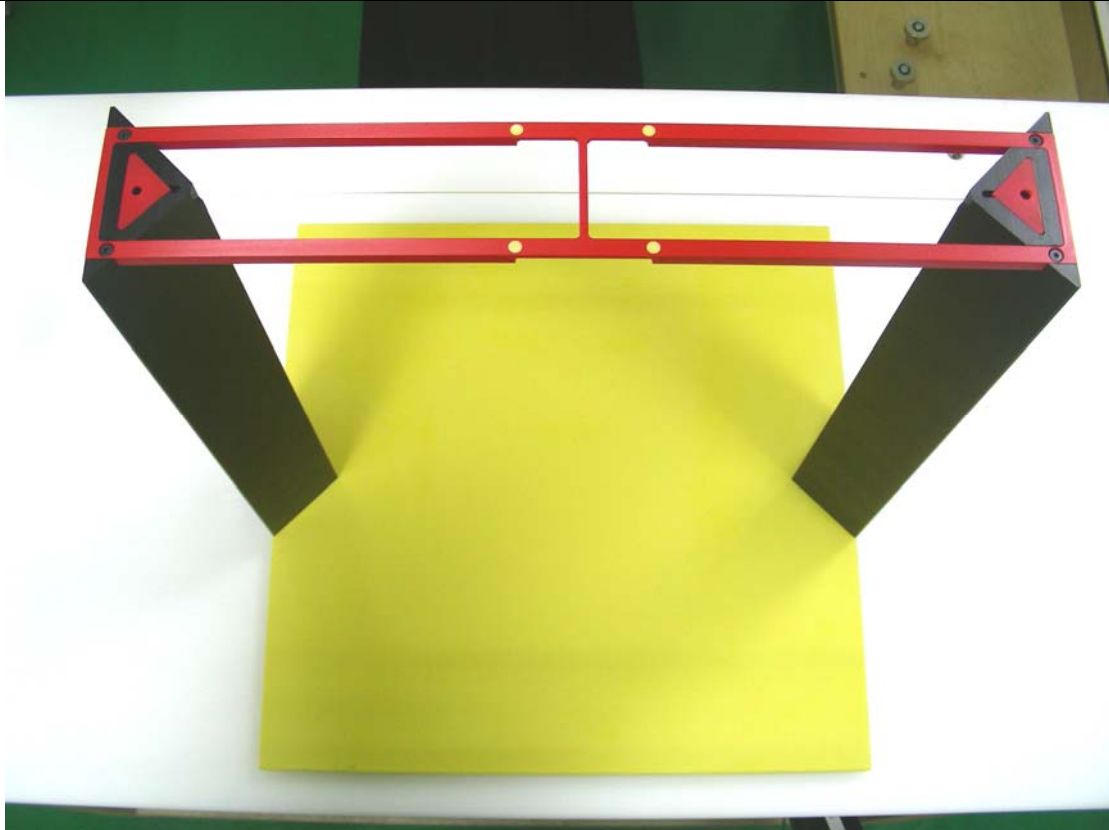

Fig. 5.7 Test Arch Phantom

5.7 Data Storage and Evaluation

5.7.1 Data Storage

The DASY4 software stores the assessed data from the data acquisition electronics as raw data (in microvolt readings from the probe sensors), together with all the necessary software parameters for the data evaluation (probe calibration data, and device frequency and modulation data) in measurement files with the extension .DA4. The post-processing software evaluates the desired unit and format for output each time the data is visualized or exported. This allows verification of the complete software setup even after the measurement and allows correction of erroneous parameter settings.

5.7.2 Data Evaluation

The DASY4 post-processing software (SEMCAD) automatically executes the following procedures to calculate the field units from the microvolt readings at the probe connector. The parameters used in the evaluation are stored in the configuration modules of the software :

Probe parameters :	- Sensitivity	Norm _i , a _{i0} , a _{i1} , a _{i2}
	- Conversion factor	ConvF _i
	- Diode compression point	dcp _i
Device parameters :	- Frequency	f
	- Crest factor	cf
Media parameters :	- Conductivity	σ
	- Density	ρ

These parameters must be set correctly in the software. They can be found in the component documents or they can be imported into the software from the configuration files issued for the DASY components. In the direct measuring mode of the multimeter option, the parameters of the actual system setup are used. In the scan visualization and export modes, the parameters stored in the corresponding document files are used.

The first step of the evaluation is a linearization of the filtered input signal to account for the compression characteristics of the detector diode. The compensation depends on the input signal, the diode type and the DC-transmission factor from the diode to the evaluation electronics. If the exciting field is pulsed, the crest factor of the signal must be known to correctly compensate for peak power. The formula for each channel can be given as :

$$V_i = U_i + U_i^2 \cdot \frac{cf}{dcp_i}$$

- with
- V_i* = compensated signal of channel *i* (*i* = x, y, z)
 - U_i* = input signal of channel *i* (*i* = x, y, z)
 - cf* = crest factor of exciting field (DASY parameter)
 - dcp_i* = diode compression point (DASY parameter)

From the compensated input signals, the primary field data for each channel can be evaluated :

$$\text{E-field probes : } E_i = \sqrt{\frac{V_i}{\text{Norm}_i \text{Conv}F}}$$

$$\text{H-field probes : } H_i = \sqrt{V_i \frac{a_{i0} + a_{i1}f + a_{i2}f^2}{f}}$$

with V_i = compensated signal of channel i ($i = x, y, z$)
 Norm_i = sensor sensitivity of channel i ($i = x, y, z$)
 $\mu \text{ V}/(\text{V/m})^2$ for E-field Probes
 $\text{Conv}F$ = sensitivity enhancement in solution
 a_{ij} = sensor sensitivity factors for H-field probes
 f = carrier frequency [GHz]
 E_i = electric field strength of channel i in V/m
 H_i = magnetic field strength of channel i in A/m

The RSS value of the field components gives the total field strength (Hermitian magnitude) :

$$E_{tot} = \sqrt{E_x^2 + E_y^2 + E_z^2}$$

The primary field data are used to calculate the derived field units.

The power flow density is calculated assuming the excitation field to be a free space field.

$$P_{pwe} = \frac{E_{tot}^2}{3770} \quad \text{or} \quad P_{pwe} = H_{tot}^2 \cdot 37.7$$

with P_{pwe} = equivalent power density of a plane wave in mW/cm²
 E_{tot} = total electric field strength in V/m
 H_{tot} = total magnetic field strength in A/m

The measurement/integration time per point, as specified by the system manufacturer is >500 ms.

The signal response time is evaluated as the time required by the system to reach 90% of the expected final value after an on/off switch of the power source with an integration time of 500 ms and a probe response time of <5 ms. In the current implementation, DASY4 waits longer than 100 ms after having reached the grid point before starting a measurement, i.e., the response time uncertainty is negligible.

If the device under test does not emit a CW signal, the integration time applied to measure the electric field at a specific point may introduce additional uncertainties due to the discretization. The tolerances for the different systems had the worst-case of 2.6%.



5.8 Test Equipment List

Manufacture	Name of Equipment	Type/Model	Serial Number	Calibration	
				Last Cal.	Due Date
SPEAG	Isotropic E-Filed Probe	ER3DV6	2358	Jan. 28, 2008	Jan. 27, 2009
SPEAG	Isotropic H-Filed Probe	H3DV6	6184	Jan. 28, 2008	Jan. 27, 2009
SPEAG	835MHz Calibration Dipole	CD835V3	1045	Sep. 25, 2007	Sep. 24, 2009
SPEAG	1880MHz Calibration Dipole	CD1880V3	1038	Sep. 27, 2007	Sep. 26, 2009
SPEAG	Data Acquisition Electronics	DAE4	778	Sep. 17, 2007	Sep. 16, 2008
SPEAG	Phone Positoiner	N/A	N/A	NCR	NCR
SPEAG	Test Arch Phantom	N/A	N/A	NCR	NCR
SPEAG	Phantom	QD 000 P40 C	TP-1150	NCR	NCR
SPEAG	Robot	Staubli RX90BL	F03/5W15A1/A/01	NCR	NCR
SPEAG	Software	DASY4 V4.7 Build 55	N/A	NCR	NCR
SPEAG	Software	SEMCAD V1.8 Build 176	N/A	NCR	NCR
SPEAG	Measurement Server	SE UMS 001 BA	1021	NCR	NCR
Agilent	Dual Directional Coupler	778D	50422	NCR	NCR
Agilent	Power Amplifier	8449B	3008A01917	NCR	NCR
Agilent	Power Meter	E4416A	GB41292344	Feb. 21, 2008	Feb. 20, 2009
Agilent	Power Sensor	E9327A	US40441548	Feb. 21, 2008	Feb. 20, 2009
Agilent	Wireless COM. Test Set	E5515C	GB46311322	Dec. 22, 2006	Dec. 21, 2008
R&S	Universal Radio Communication Tester	CMU200	103937	Oct. 19, 2007	Oct. 18, 2008

Table 5.6 Test Equipment List

6. Uncertainty Assessment

The component of uncertainty may generally be categorized according to the methods used to evaluate them. The evaluation of uncertainty by the statistical analysis of a series of observations is termed a Type A evaluation of uncertainty. The evaluation of uncertainty by means other than the statistical analysis of a series of observation is termed a Type B evaluation of uncertainty. Each component of uncertainty, however evaluated, is represented by an estimated standard deviation, termed standard uncertainty, which is determined by the positive square root of the estimated variance.

A Type A evaluation of standard uncertainty may be based on any valid statistical method for treating data. This includes calculating the standard deviation of the mean of a series of independent observations; using the method of least squares to fit a curve to the data in order to estimate the parameter of the curve and their standard deviations; or carrying out an analysis of variance in order to identify and quantify random effects in certain kinds of measurement.

A type B evaluation of standard uncertainty is typically based on scientific judgment using all of the relevant information available. These may include previous measurement data, experience and knowledge of the behavior and properties of relevant materials and instruments, manufacture’s specification, data provided in calibration reports and uncertainties assigned to reference data taken from handbooks. Broadly speaking, the uncertainty is either obtained from an outdoor source or obtained from an assumed distribution, such as the normal distribution, rectangular or triangular distributions indicated in Table 7.1

Uncertainty Distributions	Normal	Rectangular	Triangular	U-shape
Multiplying factor^(a)	1/k ^(b)	1/√3	1/√6	1/√2

- (a) standard uncertainty is determined as the product of the multiplying factor and the estimated range of variations in the measured quantity
- (b) *k* is the coverage factor

Table 6.1 Multiplying Fractions for Various Distributions

The combined standard uncertainty of the measurement result represents the estimated standard deviation of the result. It is obtained by combining the individual standard uncertainties of both Type A and Type B evaluation using the usual “root-sum-squares” (RSS) methods of combining standard deviations by taking the positive square root of the estimated variances.

Expanded uncertainty is a measure of uncertainty that defines an interval about the measurement result within which the measured value is confidently believed to lie. It is obtained by multiplying the combined standard uncertainty by a coverage factor. Typically, the coverage factor ranges from 2 to 3. Using a coverage factor allows the true value of a measured quantity to be specified with a defined probability within the specified uncertainty range. For purpose of this document, a coverage factor two is used, which corresponds to confidence interval of about 95 %. The DASY4 uncertainty Budget is showed in Table 6.2.



Error Description	Uncertainty Value (\pm %)	Probability Distribution	Divisor	(Ci) E	(Ci) H	Std. Unc. E	Std. Unc. H
Measurement System							
Probe Calibration	± 5.1	Normal	1	1	1	± 5.1	± 5.1
Axial Isotropy	± 4.7	Rectangular	$\sqrt{3}$	1	1	± 2.7	± 2.7
Sensor Displacement	± 16.5	Rectangular	$\sqrt{3}$	1	0.145	± 9.5	± 1.4
Boundary Effect	± 2.4	Rectangular	$\sqrt{3}$	1	1	± 1.4	± 1.4
Linearity	± 4.7	Rectangular	$\sqrt{3}$	1	1	± 2.7	± 2.7
Scaling to Peak Envelope Power	± 2.0	Rectangular	$\sqrt{3}$	1	1	± 1.2	± 1.2
System Detection Limit	± 1.0	Rectangular	$\sqrt{3}$	1	1	± 0.6	± 0.6
Readout Electronics	± 0.3	Normal	1	1	1	± 0.3	± 0.3
Response Time	± 0.8	Rectangular	$\sqrt{3}$	1	1	± 0.5	± 0.5
Integration Time	± 2.6	Rectangular	$\sqrt{3}$	1	1	± 1.5	± 1.5
RF Ambient Conditions	± 3.0	Rectangular	$\sqrt{3}$	1	1	± 1.7	± 1.7
RF Reflections	± 12.0	Rectangular	$\sqrt{3}$	1	1	± 6.9	± 6.9
Probe Positioner	± 1.2	Rectangular	$\sqrt{3}$	1	0.67	± 0.7	± 0.5
Probe Positioning	± 4.7	Rectangular	$\sqrt{3}$	1	0.67	± 2.7	± 1.8
Extrap. and Interpolation	± 1.0	Rectangular	$\sqrt{3}$	1	1	± 0.6	± 0.6
Test Sample Related							
Device Positioning Vertical	± 4.7	Rectangular	$\sqrt{3}$	1	0.67	± 2.7	± 1.8
Device Positioning Lateral	± 1.0	Rectangular	$\sqrt{3}$	1	1	± 0.6	± 0.6
Device Holder and Phantom	± 2.4	Rectangular	$\sqrt{3}$	1	1	± 1.4	± 1.4
Power Drift	± 5.0	Rectangular	$\sqrt{3}$	1	1	± 2.9	± 2.9
Phantom and Setup Related							
Phantom Thickness	± 2.4	Rectangular	$\sqrt{3}$	1	0.67	± 1.4	± 0.9
Combined Standard Uncertainty						± 14.7	± 10.9
Coverage Factor for 95 %		K=2					
Expanded uncertainty (Coverage factor = 2)						± 29.4	± 21.8

Table 6.2 Uncertainty Budget of DASY4

7. HAC Measurement Evaluation

Each DASY4 system is equipped with one or more system validation kits. These units, together with the predefined measurement procedures within the DASY4 software, enable the user to conduct the system performance check and system validation. System validation kit includes a dipole, tripod holder to fix it underneath the test Arch and a corresponding distance holder.

7.1 Purpose of System Performance check

The system performance check verifies that the system operates within its specifications. System and operator errors can be detected and corrected. It is recommended that the system performance check be performed prior to any usage of the system in order to guarantee reproducible results. The system performance check uses normal HAC measurements in a simplified setup with a well characterized source. This setup was selected to give a high sensitivity to all parameters that might fail or vary over time. The system check does not intend to replace the calibration of the components, but indicates situations where the system uncertainty is exceeded due to drift or failure.

7.2 System Setup

In the simplified setup for system evaluation, the DUT is replaced by a calibrated dipole and the power source is replaced by a continuous wave which comes from a signal generator at frequency 835 and 1880 MHz. The calibrated dipole must be placed beneath the flat phantom section of the ARC with the correct distance holder. The equipment setup is shown below:

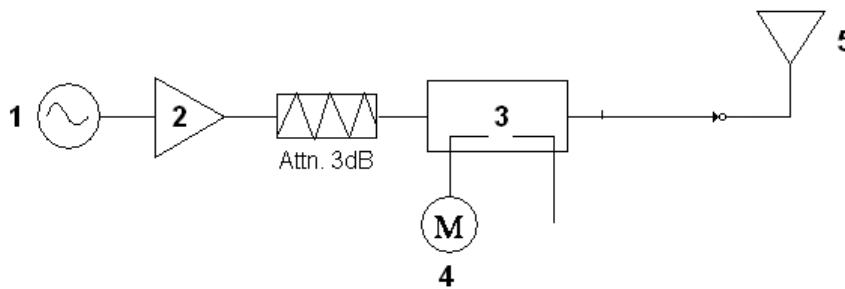

Fig. 7.1 System Setup of System Evaluation

1. Signal Generator
2. Amplifier
3. Directional Coupler
4. Power Meter
5. 835 or 1880 MHz Dipole

The output power on dipole port must be calibrated to 20dBm (100mW) before dipole is connected.

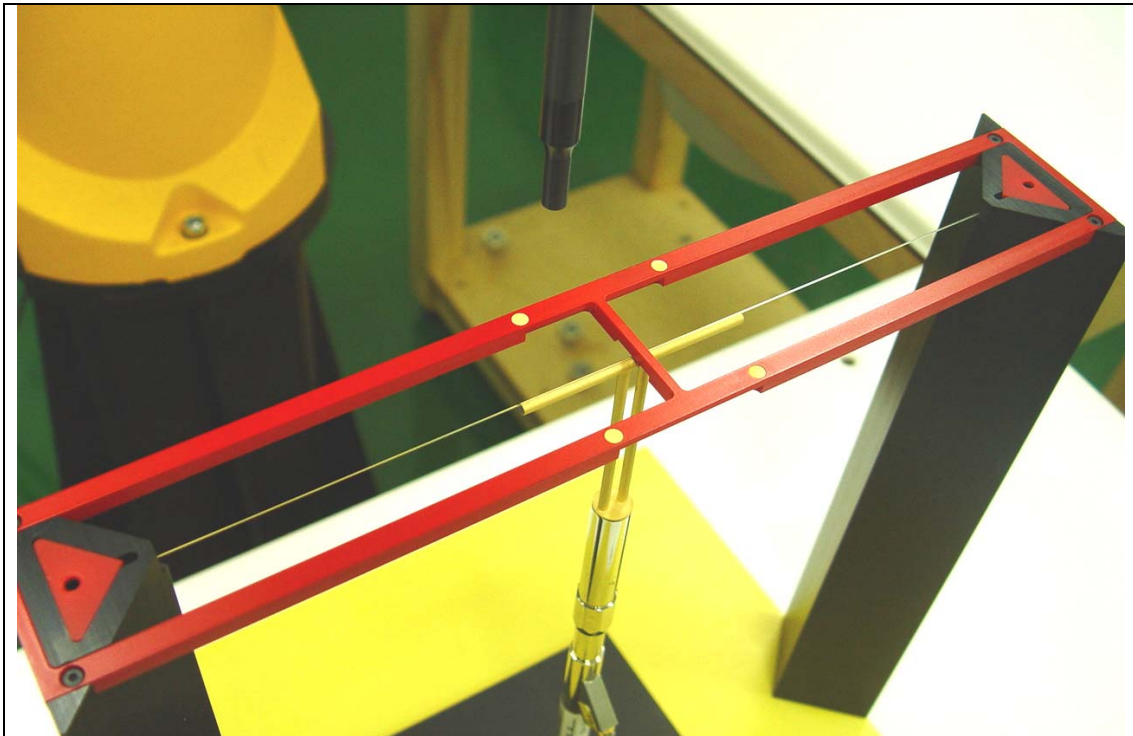

Fig 7.2 Dipole Setup

7.3 Validation Results

Frequency (MHz)	Input Power (dBm)	E-field Result (V/m)	Target Field (V/m)	Deviation (%)
835	20.0	171.1	167.1	2.39
1880	20.0	148.6	138.9	6.98
Frequency (MHz)	Input Power (dBm)	H-field Result (A/m)	Target Field (A/m)	Deviation (%)
835	20.0	0.454	0.453	0.22
1880	20.0	0.497	0.471	5.52

Table 7.1 System Validation

Remark: Deviation = ((E or H-field Result) - (Target field)) / (Target field) * 100%

The table above indicates the system performance check can meet the variation criterion, ±25%.

8. RF Field Probe Modulation Factor

A calibration shall be made of the modulation response of the probe and its instrumentation chain. This calibration shall be performed with the field probe, attached to the instrumentation that is to be used with it during the measurement. The response of the probe system to a CW field at the frequency(s) of interest is compared to its response to a modulated signal with equal peak amplitude. The field level of the test signals shall be more than 10 dB above the ambient level and the noise floor of the instrumentation being used. The ratio of the CW reading to that taken with a modulated field shall be applied to the readings taken of modulated fields of the specified type.

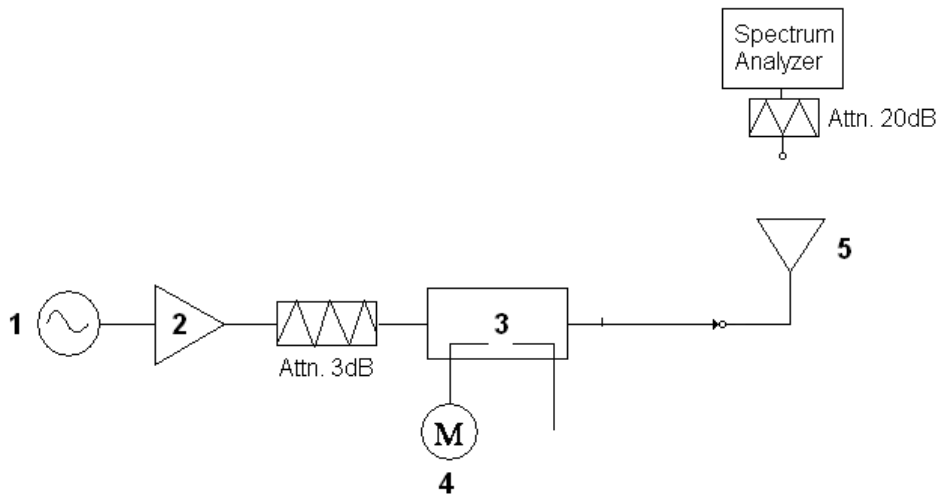

Fig. 8.1 System Calibration

This was done using the following procedure:

1. Fixing the probe in a set location relative to a field generating device.
2. Illuminate the probe with a CW signal at the intended measurement frequency.
3. Record the reading of the probe measurement system of the CW signal.
4. Determine the level of the CW signal being used to drive the field generating device.
5. Substitute a signal using the same modulation as that used by the intended WD for the CW signal.
6. Set the peak amplitude during transmission of the modulated signal to equal the amplitude of the CW signal.
7. Record the reading of the probe measurement system of the modulated signal.
8. The ratio of the CW to modulated signal reading is the modulation factor.
9. Repeat 2~8 steps at intended measurement frequency for both E and H field probe.



PMF Measurement Summary:

Frequency	Functions	E-field	H-field	PMF	
		V/m	A/m	E-field	H-field
835MHz	CW	749	1.984	-	-
835MHz	AM	431.8	1.462	1.73	1.36
835MHz	GSM	274.7	1.185	2.73	1.67
1880MHz	CW	482.2	1.52	-	-
1880MHz	AM	288.1	1.233	1.67	1.23
1880MHz	GSM	175.8	1.305	2.74	1.17

Zero span Spectrum Plots for RF Field Probe Modulation Factor

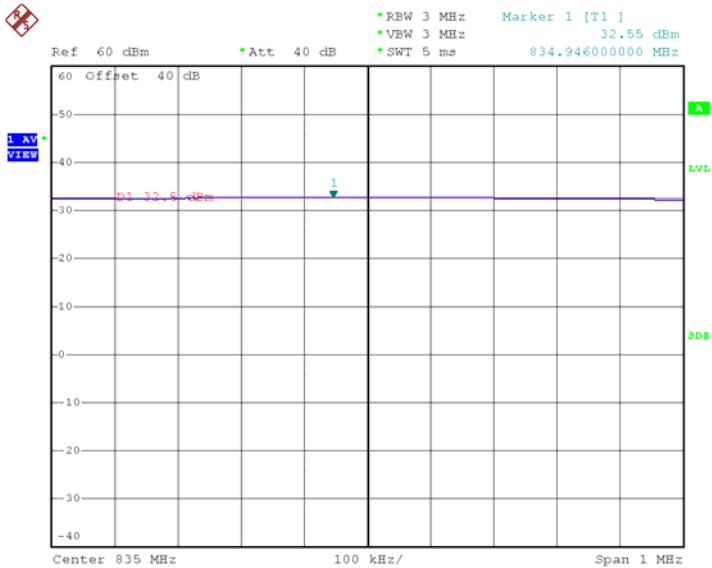

835MHz - CW

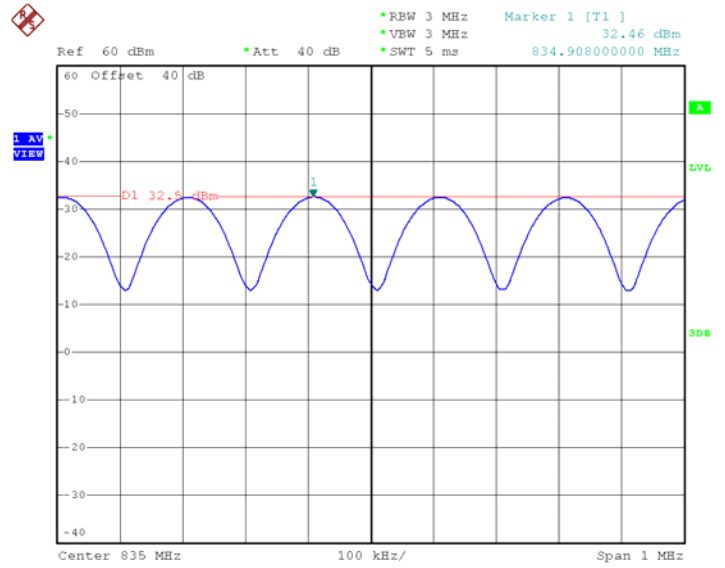

835MHz - 80% AM

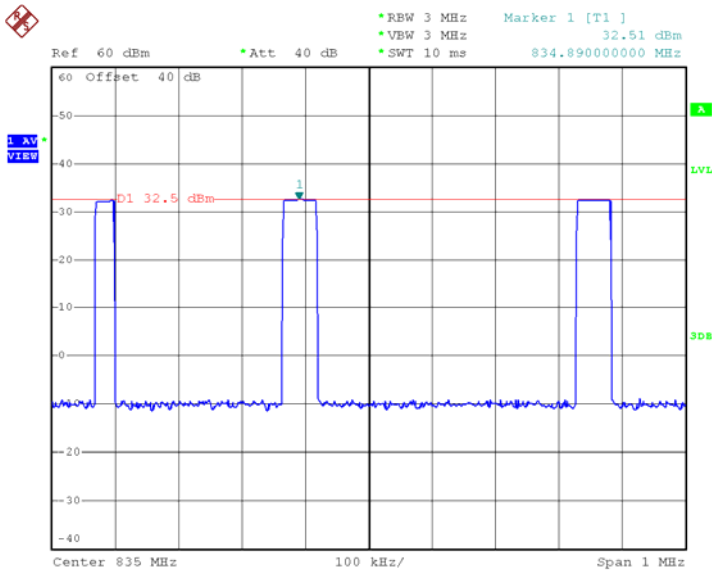

835MHz - GSM

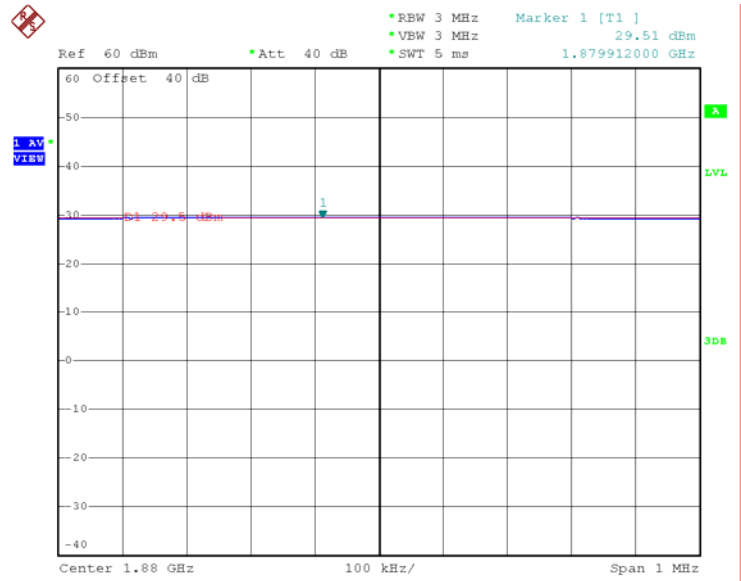

1880MHz - CW

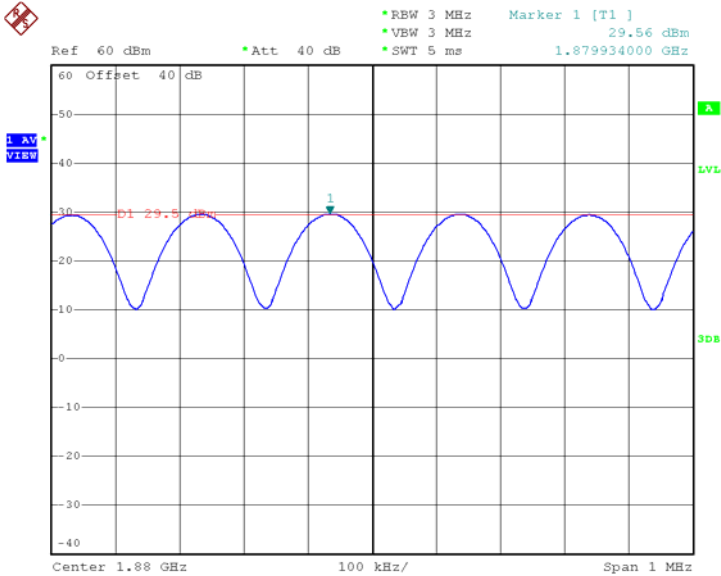

1880MHz - 80% AM

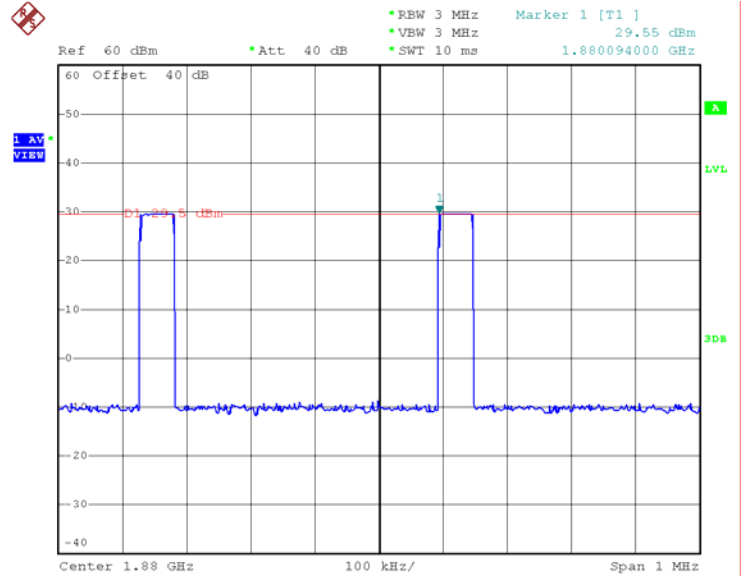

1880MHz - GSM



9. Description for DUT Testing Position

The DUT was put on device holder and adjusted to the accurate and reliable position.

Setup photographs please refer to Appendix E.



10. RF Emissions Test Procedure

The following illustrate a typical RF emissions test scan over a wireless communications device:

1. Proper operation of the field probe, probe measurement system, other instrumentation, and the positioning system was confirmed.
2. DUT is positioned in its intended test position, acoustic output point of the device perpendicular to the field probe.
3. The DUT operation for maximum rated RF output power was configured and confirmed with the base station simulator, at the test channel and other normal operating parameters as intended for the test. The battery was ensured to be fully charged before each test.
4. The center sub-grid was centered over the center of the acoustic output (also audio band magnetic output, if applicable). The DUT audio output was positioned tangent (as physically possible) to the measurement plane.
5. A surface calibration was performed before each setup change to ensure repeatable spacing and proper maintenance of the measurement plane using the test Arch.
6. The measurement system measured the field strength at the reference location.
7. Measurements at 5 mm increments in the 5 x 5 cm region were performed and recorded. A 360° rotation about the azimuth axis at the maximum interpolated position was measured. For the worst-case condition, the peak reading from this rotation was used in re-evaluating the HAC category.
8. The system performed a drift evaluation by measuring the field at the reference location.
9. Steps 1-8 were done for both the E and H-Field measurements.



11. HAC Test Results

11.1 E-Field Emission

EUT Slide Down									
Mode	Chan.	Freq. (MHz)	Modulation type	PMF	Conducted Power (dBm)	Power Drift (dB)	Peak Field (V/m)	Backlight	M-Rating
GSM850	128 (Low)	824.2	GMSK	2.73	32.49	0.044	128.2	Off	M4
	189 (Mid)	836.4	GMSK	2.73	32.56	-0.278	137.7	Off	M4
	251 (High)	848.8	GMSK	2.73	32.64	-0.06	142	Off	M4
	251 (High)	848.8	GMSK	2.73	32.64	-0.063	141.4	On	M4
GSM850 with BT On	251 (High)	848.8	GMSK	2.73	32.64	0.082	148.6	Off	M4
GSM850 with Wifi On	251 (High)	848.8	GMSK	2.73	32.64	-0.125	145.1	Off	M4
PCS1900	512(Low)	1850.2	GMSK	2.74	29.48	0.039	59.1	Off	M3
	661(Mid)	1880.0	GMSK	2.74	29.47	0.059	66.2	Off	M3
	810(High)	1909.8	GMSK	2.74	29.42	-0.266	77.5	Off	M3
	810(High)	1909.8	GMSK	2.74	29.42	0.051	77.9	On	M3
PCS1900 with BT On	810(High)	1909.8	GMSK	2.74	29.42	0.036	77.7	Off	M3
PCS1900 with Wifi On	810(High)	1909.8	GMSK	2.74	29.42	-0.074	79.2	Off	M3

EUT Slide Up									
Mode	Chan.	Freq. (MHz)	Modulation type	PMF	Conducted Power (dBm)	Power Drift (dB)	Peak Field (V/m)	Backlight	M-Rating
GSM850	128 (Low)	824.2	GMSK	2.73	32.49	0.003	167.4	Off	M3
	189 (Mid)	836.4	GMSK	2.73	32.56	-0.017	175.1	Off	M3
	251 (High)	848.8	GMSK	2.73	32.64	0.008	177.5	Off	M3
	251 (High)	848.8	GMSK	2.73	32.64	0.101	176.5	On	M3
GSM850 with BT On	251 (High)	848.8	GMSK	2.73	32.64	0.045	176.9	Off	M3
GSM850 with Wifi On	251 (High)	848.8	GMSK	2.73	32.64	-0.108	178.9	Off	M3
PCS1900	512(Low)	1850.2	GMSK	2.74	29.48	0.037	52.2	Off	M3
	661(Mid)	1880.0	GMSK	2.74	29.47	0.016	58.6	Off	M3
	810(High)	1909.8	GMSK	2.74	29.42	0.016	68.1	Off	M3
	810(High)	1909.8	GMSK	2.74	29.42	0.087	67.5	On	M3
PCS1900 with BT On	810(High)	1909.8	GMSK	2.74	29.42	0.098	67.9	Off	M3
PCS1900 with Wifi On	810(High)	1909.8	GMSK	2.74	29.42	0.106	71	Off	M3



11.2 H-Field Emission

EUT Slide Down									
Mode	Chan.	Freq. (MHz)	Modulation type	PMF	Conducted Power (dBm)	Power Drift (dB)	Peak Field (A/m)	Backlight	M-Rating
GSM850	128 (Low)	824.2	GMSK	1.67	32.49	-0.043	0.116	Off	M4
	189 (Mid)	836.4	GMSK	1.67	32.56	-0.235	0.131	Off	M4
	251 (High)	848.8	GMSK	1.67	32.64	-0.04	0.139	Off	M4
	251 (High)	848.8	GMSK	1.67	32.64	0.069	0.136	On	M4
GSM850 with BT On	251 (High)	848.8	GMSK	1.67	32.64	-0.194	0.136	Off	M4
GSM850 with Wifi On	251 (High)	848.8	GMSK	1.67	32.64	0.006	0.138	Off	M4
PCS1900	512(Low)	1850.2	GMSK	1.17	29.48	0.075	0.056	Off	M4
	661(Mid)	1880.0	GMSK	1.17	29.47	0.028	0.068	Off	M4
	810(High)	1909.8	GMSK	1.17	29.42	0.031	0.085	Off	M4
	810(High)	1909.8	GMSK	1.17	29.42	0.001	0.085	On	M4
PCS1900 with BT On	810(High)	1909.8	GMSK	1.17	29.42	-0.013	0.0085	Off	M4
PCS1900 with Wifi On	810(High)	1909.8	GMSK	1.17	29.42	0.064	0.076	Off	M4

EUT Slide Up									
Mode	Chan.	Freq. (MHz)	Modulation type	PMF	Conducted Power (dBm)	Power Drift (dB)	Peak Field (A/m)	Backlight	M-Rating
GSM850	128 (Low)	824.2	GMSK	1.67	32.49	0.108	0.152	Off	M4
	189 (Mid)	836.4	GMSK	1.67	32.56	0.006	0.159	Off	M4
	251 (High)	848.8	GMSK	1.67	32.64	0.046	0.168	Off	M4
	251 (High)	848.8	GMSK	1.67	32.64	0.126	0.166	On	M4
GSM850 with BT On	251 (High)	848.8	GMSK	1.67	32.64	-0.028	0.167	Off	M4
GSM850 with Wifi On	251 (High)	848.8	GMSK	1.67	32.64	-0.153	0.172	Off	M4
PCS1900	512(Low)	1850.2	GMSK	1.17	29.48	-0.035	0.058	Off	M4
	661(Mid)	1880.0	GMSK	1.17	29.47	-0.068	0.065	Off	M4
	810(High)	1909.8	GMSK	1.17	29.42	0.024	0.068	Off	M4
	810(High)	1909.8	GMSK	1.17	29.42	0.012	0.068	On	M4
PCS1900 with BT On	810(High)	1909.8	GMSK	1.17	29.42	0.002	0.069	Off	M4
PCS1900 with Wifi On	810(High)	1909.8	GMSK	1.17	29.42	0.036	0.07	Off	M4

Remark:

1. The output power is adjusted to maximum level during RF Emission testing.
2. Test Engineer: Gordon Lin, Eric Huang, and Jason Wang



12. References

- [1] ANSI C63.19, “American National Standard for Methods of Measurement of Compatibility between Wireless Communications Devices and Hearing Aids”
- [2] DASY4 System Hand book.



Appendix A - System Performance Check Data

Test Laboratory: Sporton International Inc. SAR/HAC Testing Lab

Date:2008/3/18

HAC_E_Dipole_835

DUT: HAC-Dipole 835 MHz; Type: D835V3

Communication System: CW; Frequency: 835 MHz;Duty Cycle: 1:1
Medium: Air Medium parameters used: sigma = 0 mho/m, epsilon = 1; rho = 1000 kg/m^3
Ambient Temperature : 22.0 C

DASY4 Configuration:

- Probe: ER3DV6 - SN2358; ConvF(1, 1, 1); Calibrated: 2008/1/28
- Sensor-Surface: (Fix Surface)
- Electronics: DAE4 Sn778; Calibrated: 2007/9/17
- Phantom: HAC Test Arch 4.6; Type: SD HAC P01 BA;
- Measurement SW: DASY4, V4.7 Build 55; Postprocessing SW: SEMCAD, V1.8 Build 176

E Scan - ER probe center 10mm above CD835 Dipole/Hearing Aid Compatibility Test

(41x361x1); Measurement grid: dx=5mm, dy=5mm

Maximum value of peak Total field = 175.6 V/m

Probe Modulation Factor = 1.00

Device Reference Point: 0.000, 0.000, 353.7 mm

Reference Value = 57.8 V/m; Power Drift = -0.016 dB

Hearing Aid Near-Field Category: M4 (AWF 0 dB)

Peak E-field in V/m

Table with 3 columns (Grid 1-3, Grid 4-6, Grid 7-9) and 3 rows of peak E-field values in V/m.

Cursor:

Total = 175.6 V/m

E Category: M4

Location: 0, -79, 363.7 mm

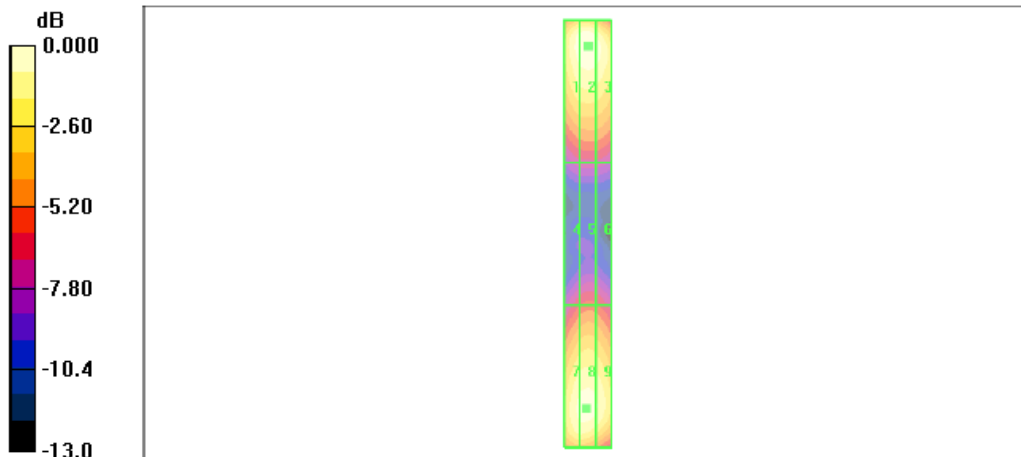

0 dB = 175.6V/m



Test Laboratory: Sporton International Inc. SAR/HAC Testing Lab

Date:2008/3/18

HAC_E_Dipole_1880

DUT: HAC Dipole 1880 MHz; Type: CD1880V3

Communication System: CW; Frequency: 1880 MHz;Duty Cycle: 1:1

Medium: Air Medium parameters used: $\sigma = 0$ mho/m, $\epsilon_r = 1$; $\rho = 1000$ kg/m³

Ambient Temperature : 22.0 °C

DASY4 Configuration:

- Probe: ER3DV6 - SN2358; ConvF(1, 1, 1); Calibrated: 2008/1/28
- Sensor-Surface: (Fix Surface)
- Electronics: DAE4 Sn778; Calibrated: 2007/9/17
- Phantom: HAC Test Arch 4.6; Type: SD HAC P01 BA;
- Measurement SW: DASY4, V4.7 Build 55; Postprocessing SW: SEMCAD, V1.8 Build 176

E Scan - ER probe center 10mm above CD1880 Dipole/Hearing Aid Compatibility Test

(41x181x1); Measurement grid: dx=5mm, dy=5mm

Maximum value of peak Total field = 148.7 V/m

Probe Modulation Factor = 1.00

Device Reference Point: 0.000, 0.000, 353.7 mm

Reference Value = 72.0 V/m; Power Drift = 0.003 dB

Hearing Aid Near-Field Category: M2 (AWF 0 dB)

Peak E-field in V/m

Grid 1 139.8 M2	Grid 2 148.5 M2	Grid 3 144.8 M2
Grid 4 92.5 M3	Grid 5 96.3 M3	Grid 6 93.1 M3
Grid 7 146.4 M2	Grid 8 148.7 M2	Grid 9 143.1 M2

Cursor:

Total = 148.7 V/m

E Category: M2

Location: 0.5, 33.5, 363.7 mm

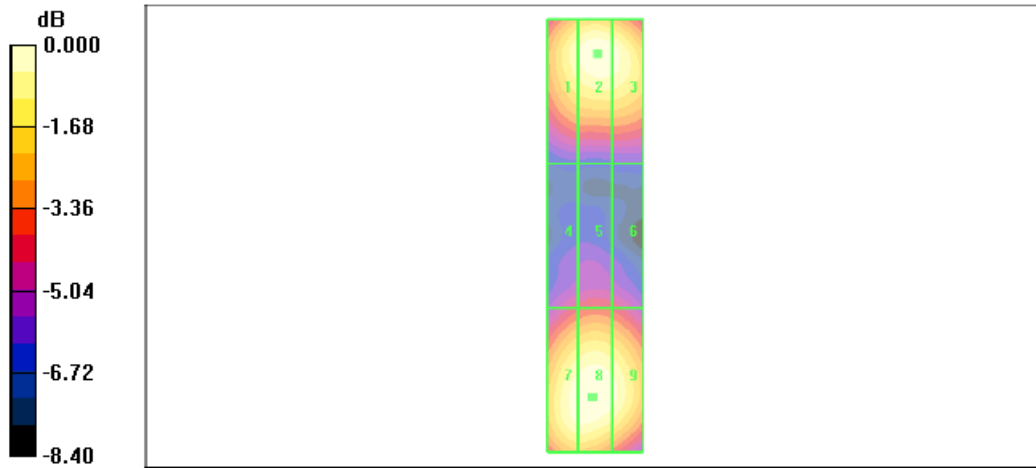

0 dB = 148.7V/m



Test Laboratory: Sporton International Inc. SAR/HAC Testing Lab

Date:2008/3/18

HAC_H_Dipole_835

DUT: HAC-Dipole 835 MHz; Type: D835V3

Communication System: CW; Frequency: 835 MHz;Duty Cycle: 1:1

Medium: Air Medium parameters used: $\sigma = 0$ mho/m, $\epsilon_r = 1$; $\rho = 1$ kg/m³

Ambient Temperature : 22.0 °C

DASY4 Configuration:

- Probe: H3DV6 - SN6184; ; Calibrated: 2008/1/28
- Sensor-Surface: (Fix Surface)
- Electronics: DAE4 Sn778; Calibrated: 2007/9/17
- Phantom: HAC Test Arch 4.6; Type: SD HAC P01 BA;
- Measurement SW: DASY4, V4.7 Build 55; Postprocessing SW: SEMCAD, V1.8 Build 176

H Scan - H3DV6 probe center 10mm above CD835 Dipole/Hearing Aid Compatibility Test

(41x361x1); Measurement grid: dx=5mm, dy=5mm

Maximum value of peak Total field = 0.454 A/m

Probe Modulation Factor = 1.00

Device Reference Point: 0.000, 0.000, 353.7 mm

Reference Value = 0.440 A/m; Power Drift = 0.017 dB

Hearing Aid Near-Field Category: M4 (AWF 0 dB)

Peak H-field in A/m

Grid 1	Grid 2	Grid 3
0.379 M4	0.400 M4	0.371 M4
Grid 4	Grid 5	Grid 6
0.433 M4	0.454 M4	0.421 M4
Grid 7	Grid 8	Grid 9
0.376 M4	0.396 M4	0.366 M4

Cursor:

Total = 0.454 A/m

H Category: M4

Location: 0.5, -4.5, 363.7 mm

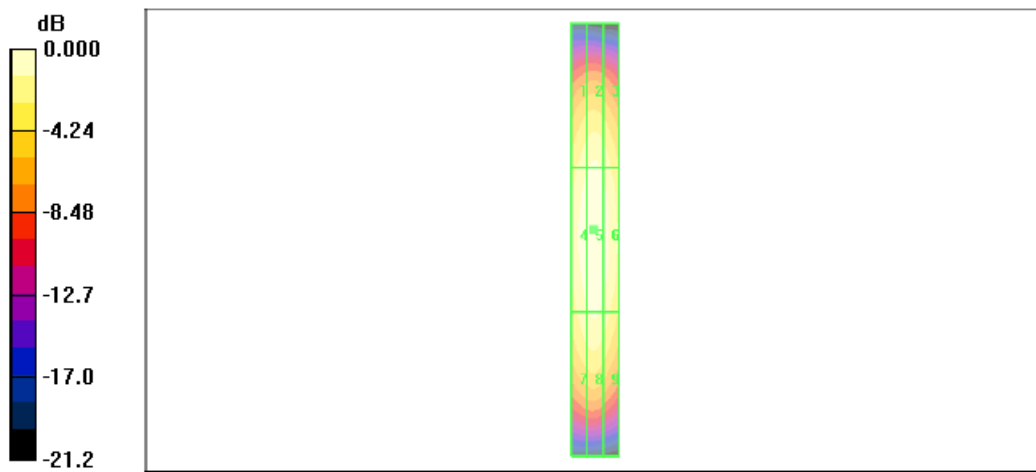

0 dB = 0.454A/m



Test Laboratory: Sporton International Inc. SAR/HAC Testing Lab

Date:2008/3/18

HAC_H_Dipole_1880

DUT: HAC Dipole 1880 MHz; Type: CD1880V3

Communication System: CW; Frequency: 1880 MHz;Duty Cycle: 1:1
Medium: Air Medium parameters used: sigma = 0 mho/m, epsilon = 1; rho = 1 kg/m^3
Ambient Temperature : 22.0 C

DASY4 Configuration:

- Probe: H3DV6 - SN6184; ; Calibrated: 2008/1/28
- Sensor-Surface: (Fix Surface)
- Electronics: DAE4 Sn778; Calibrated: 2007/9/17
- Phantom: HAC Test Arch 4.6; Type: SD HAC P01 BA;
- Measurement SW: DASY4, V4.7 Build 55; Postprocessing SW: SEMCAD, V1.8 Build 176

H Scan - HSSDV6 probe center 10mm above CD1880 Dipole/Hearing Aid Compatibility Test

(41x181x1); Measurement grid: dx=5mm, dy=5mm

Maximum value of peak Total field = 0.497 A/m

Probe Modulation Factor = 1.00

Device Reference Point: 0.000, 0.000, 353.7 mm

Reference Value = 0.484 A/m; Power Drift = -0.005 dB

Hearing Aid Near-Field Category: M2 (AWF 0 dB)

Peak H-field in A/m

Table with 3 columns (Grid 1-3, Grid 4-6, Grid 7-9) and 3 rows of peak H-field values in A/m.

Cursor:

Total = 0.497 A/m

H Category: M2

Location: 0.5, 0, 363.7 mm

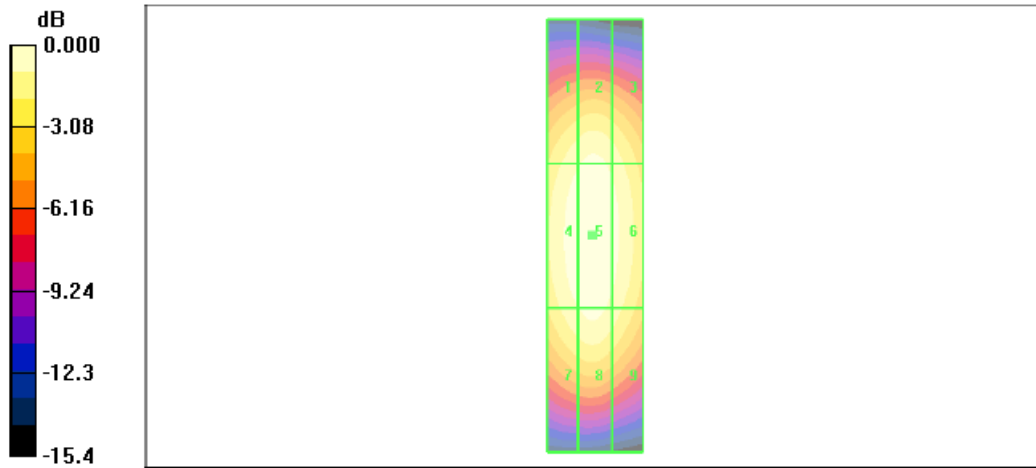

0 dB = 0.497A/m



Appendix B - HAC Measurement Data

Test Laboratory: Sporton International Inc. SAR/HAC Testing Lab

Date:2008/3/18

HAC_E_GSM850 Ch128_Close

DUT: 821901

Communication System: GSM850; Frequency: 824.2 MHz;Duty Cycle: 1:8.3
Medium: Air Medium parameters used: $\sigma = 0$ mho/m, $\epsilon_r = 1$; $\rho = 1000$ kg/m³
Ambient Temperature : 22.8 °C

DASY4 Configuration:

- Probe: ER3DV6 - SN2358; ConvF(1, 1, 1); Calibrated: 2008/1/28
- Sensor-Surface: (Fix Surface)
- Electronics: DAE4 Sn778; Calibrated: 2007/9/17
- Phantom: HAC Test Arch 4.6; Type: SD HAC P01 BA;
- Measurement SW: DASY4, V4.7 Build 55; Postprocessing SW: SEMCAD, V1.8 Build 176

CH128/Hearing Aid Compatibility Test (101x101x1): Measurement grid: dx=5mm, dy=5mm

Maximum value of peak Total field = 128.2 V/m

Probe Modulation Factor = 2.73

Device Reference Point: 0.000, 0.000, 353.7 mm

Reference Value = 49.2 V/m; Power Drift = -0.044 dB

Hearing Aid Near-Field Category: **M4 (AWF -5 dB)**

Peak E-field in V/m

Grid 1 104.2 M4	Grid 2 122.0 M4	Grid 3 119.1 M4
Grid 4 109.1 M4	Grid 5 128.2 M4	Grid 6 125.6 M4
Grid 7 102.0 M4	Grid 8 120.1 M4	Grid 9 118.4 M4

Cursor:

Total = 128.2 V/m

E Category: M4

Location: -4.5, -2, 364.8 mm

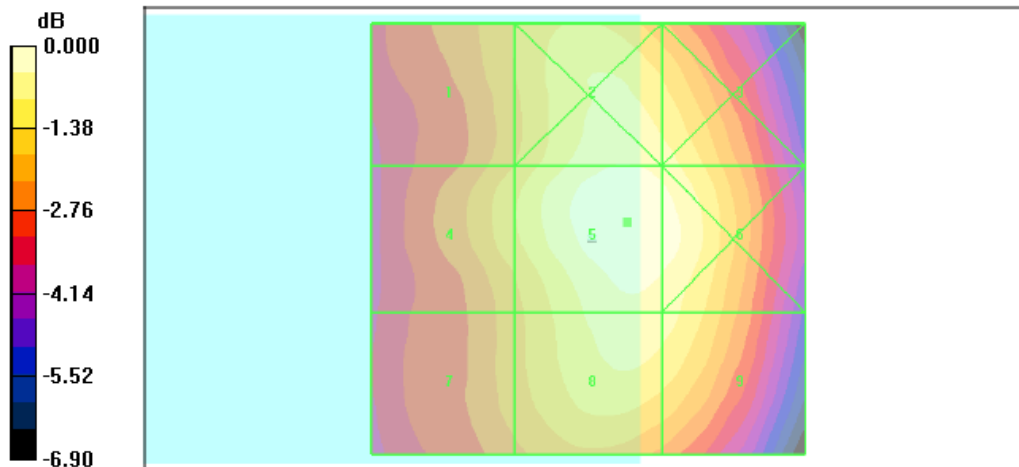

0 dB = 128.2V/m



Test Laboratory: Sporton International Inc. SAR/HAC Testing Lab

Date:2008/3/18

HAC_E_GSM850 Ch189_Close

DUT: 821901

Communication System: GSM850; Frequency: 836.4 MHz;Duty Cycle: 1:8.3
Medium: Air Medium parameters used: sigma = 0 mho/m, epsilon_r = 1; rho = 1000 kg/m^3
Ambient Temperature : 22.8 C

DASY4 Configuration:

- Probe: ER3DV6 - SN2358; ConvF(1, 1, 1); Calibrated: 2008/1/28
- Sensor-Surface: (Fix Surface)
- Electronics: DAE4 Sn778; Calibrated: 2007/9/17
- Phantom: HAC Test Arch 4.6; Type: SD HAC P01 BA;
- Measurement SW: DASY4, V4.7 Build 55; Postprocessing SW: SEMCAD, V1.8 Build 176

CH189/Hearing Aid Compatibility Test (101x101x1): Measurement grid: dx=5mm, dy=5mm

Maximum value of peak Total field = 137.7 V/m

Probe Modulation Factor = 2.73

Device Reference Point: 0.000, 0.000, 353.7 mm

Reference Value = 53.7 V/m; Power Drift = -0.278 dB

Hearing Aid Near-Field Category: M4 (AWF -5 dB)

Peak E-field in V/m

Table with 3 columns (Grid 1-3, Grid 4-6, Grid 7-9) and 3 rows of peak E-field values in V/m, ranging from 109.1 M4 to 137.7 M4.

Cursor:

Total = 137.7 V/m

E Category: M4

Location: -5, -1.5, 364.8 mm

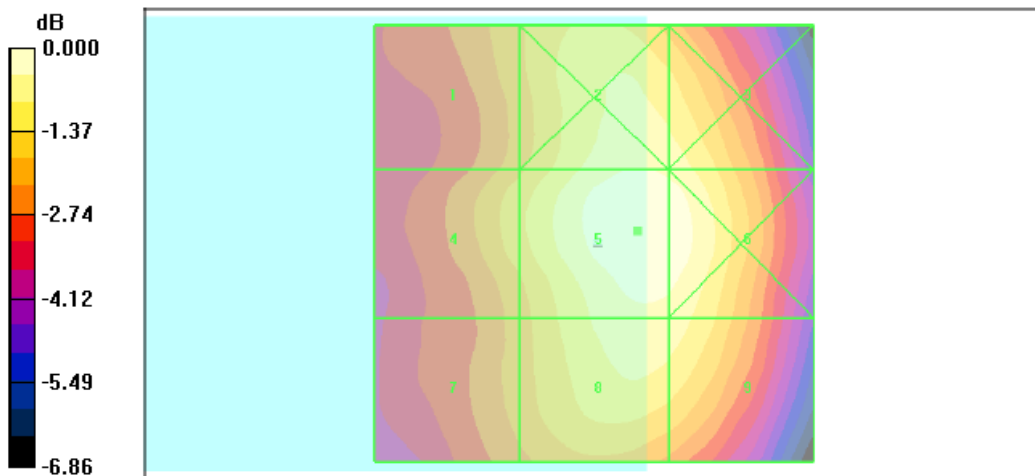

0 dB = 137.7V/m



Test Laboratory: Sporton International Inc. SAR/HAC Testing Lab

Data:2008/3/18

HAC_E_GSM850 Ch251_Close

DUT: 821901

Communication System: GSM850; Frequency: 848.8 MHz;Duty Cycle: 1:8.3
Medium: Air Medium parameters used: sigma = 0 mho/m, epsilon_r = 1; rho = 1000 kg/m^3
Ambient Temperature : 22.8 C

DASY4 Configuration:

- Probe: ER3DV6 - SN2358; ConvF(1, 1, 1); Calibrated: 2008/1/28
- Sensor-Surface: (Fix Surface)
- Electronics: DAE4 Sn778; Calibrated: 2007/9/17
- Phantom: HAC Test Arch 4.6; Type: SD HAC P01 BA;
- Measurement SW: DASY4, V4.7 Build 55; Postprocessing SW: SEMCAD, V1.8 Build 176

CH251/Hearing Aid Compatibility Test (101x101x1): Measurement grid: dx=5mm, dy=5mm

Maximum value of peak Total field = 142.0 V/m

Probe Modulation Factor = 2.73

Device Reference Point: 0.000, 0.000, 353.7 mm

Reference Value = 54.0 V/m; Power Drift = -0.060 dB

Hearing Aid Near-Field Category: M4 (AWF -5 dB)

Peak E-field in V/m

Table with 3 columns (Grid 1-3, Grid 4-6, Grid 7-9) and 3 rows of peak E-field values in V/m (e.g., 114.8 M4, 135.0 M4, 133.1 M4).

Cursor:

Total = 142.0 V/m

E Category: M4

Location: -5, -2.5, 364.8 mm

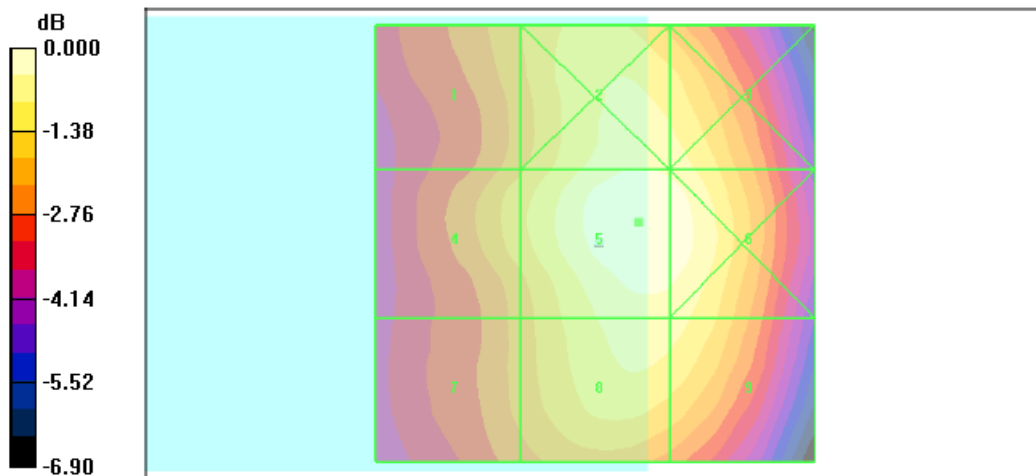

0 dB = 142.0V/m



Test Laboratory: Sporton International Inc. SAR/HAC Testing Lab

Data:2008/3/18

HAC_E_GSM850 Ch251_Close_Backlight on

DUT: 821901

Communication System: GSM850; Frequency: 848.8 MHz;Duty Cycle: 1:8.3
Medium: Air Medium parameters used: sigma = 0 mho/m, epsilon_r = 1; rho = 1000 kg/m^3
Ambient Temperature : 22.8 C

DASY4 Configuration:

- Probe: ER3DV6 - SN2358; ConvF(1, 1, 1); Calibrated: 2008/1/28
- Sensor-Surface: (Fix Surface)
- Electronics: DAE4 Sn778; Calibrated: 2007/9/17
- Phantom: HAC Test Arch 4.6; Type: SD HAC P01 BA;
- Measurement SW: DASY4, V4.7 Build 55; Postprocessing SW: SEMCAD, V1.8 Build 176

CH251/Hearing Aid Compatibility Test (101x101x1): Measurement grid: dx=5mm, dy=5mm

Maximum value of peak Total field = 141.4 V/m

Probe Modulation Factor = 2.73

Device Reference Point: 0.000, 0.000, 353.7 mm

Reference Value = 54.0 V/m; Power Drift = -0.063 dB

Hearing Aid Near-Field Category: M4 (AWF -5 dB)

Peak E-field in V/m

Table with 3 columns (Grid 1-3, Grid 4-6, Grid 7-9) and 3 rows of peak E-field values in V/m.

Cursor:

Total = 141.4 V/m

E Category: M4

Location: -5, -2.5, 364.8 mm

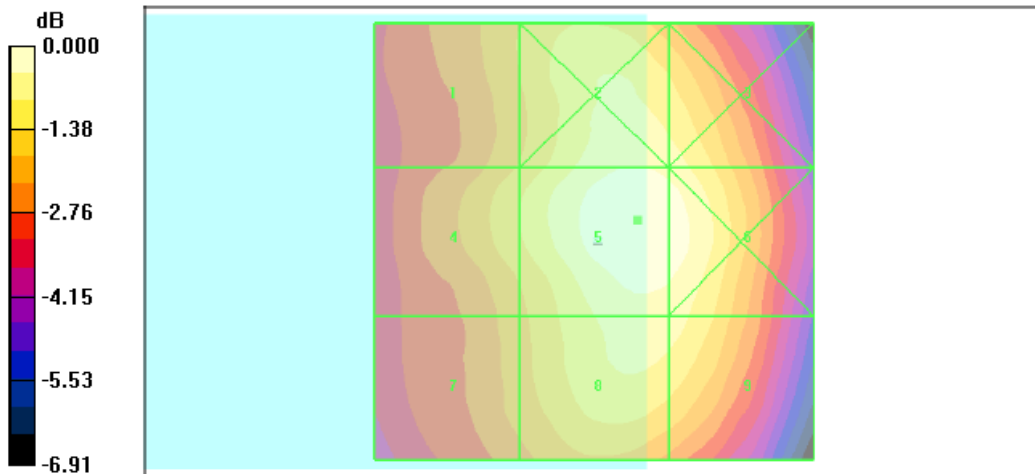

0 dB = 141.4V/m



Test Laboratory: Sporton International Inc. SAR/HAC Testing Lab

Date:2008/3/18

HAC_E_GSM850 Ch251_Close_Bluetooth on

DUT: 821901

Communication System: GSM850; Frequency: 848.8 MHz;Duty Cycle: 1:8.3
Medium: Air Medium parameters used: sigma = 0 mho/m, epsilon_r = 1; rho = 1000 kg/m^3
Ambient Temperature : 22.8 C

DASY4 Configuration:

- Probe: ER3DV6 - SN2358; ConvF(1, 1, 1); Calibrated: 2008/1/28
- Sensor-Surface: (Fix Surface)
- Electronics: DAE4 Sn778; Calibrated: 2007/9/17
- Phantom: HAC Test Arch 4.6; Type: SD HAC P01 BA;
- Measurement SW: DASY4, V4.7 Build 55; Postprocessing SW: SEMCAD, V1.8 Build 176

CH251/Hearing Aid Compatibility Test (101x101x1): Measurement grid: dx=5mm, dy=5mm

Maximum value of peak Total field = 148.6 V/m

Probe Modulation Factor = 2.88

Device Reference Point: 0.000, 0.000, 353.7 mm

Reference Value = 53.3 V/m; Power Drift = 0.082 dB

Hearing Aid Near-Field Category: M4 (AWF -5 dB)

Peak E-field in V/m

Table with 3 columns (Grid 1-3, Grid 4-6, Grid 7-9) and 3 rows of peak E-field values in V/m.

Cursor:

Total = 148.6 V/m

E Category: M4

Location: -5, -3, 364.8 mm

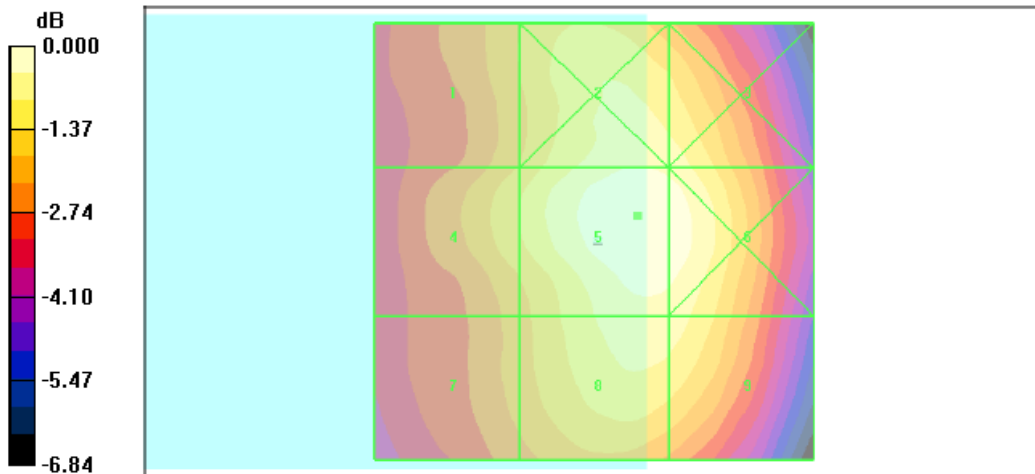

0 dB = 148.6V/m



Test Laboratory: Sporton International Inc. SAR/HAC Testing Lab

Date:2008/3/18

HAC_E_GSM850 Ch251_Close_Wifi on

DUT: 821901

Communication System: GSM850; Frequency: 848.8 MHz;Duty Cycle: 1:8.3
Medium: Air Medium parameters used: sigma = 0 mho/m, epsilon_r = 1; rho = 1000 kg/m^3
Ambient Temperature : 22.8 C

DASY4 Configuration:

- Probe: ER3DV6 - SN2358; ConvF(1, 1, 1); Calibrated: 2008/1/28
- Sensor-Surface: (Fix Surface)
- Electronics: DAE4 Sn778; Calibrated: 2007/9/17
- Phantom: HAC Test Arch 4.6; Type: SD HAC P01 BA;
- Measurement SW: DASY4, V4.7 Build 55; Postprocessing SW: SEMCAD, V1.8 Build 176

CH251/Hearing Aid Compatibility Test (101x101x1): Measurement grid: dx=5mm, dy=5mm

Maximum value of peak Total field = 145.1 V/m

Probe Modulation Factor = 2.73

Device Reference Point: 0.000, 0.000, 353.7 mm

Reference Value = 55.8 V/m; Power Drift = -0.125 dB

Hearing Aid Near-Field Category: M4 (AWF -5 dB)

Peak E-field in V/m

Table with 3 columns (Grid 1-3, Grid 4-6, Grid 7-9) and 3 rows of peak E-field values in V/m, ranging from 117.0 M4 to 135.8 M4.

Cursor:

Total = 145.1 V/m

E Category: M4

Location: -4.5, -2.5, 364.8 mm

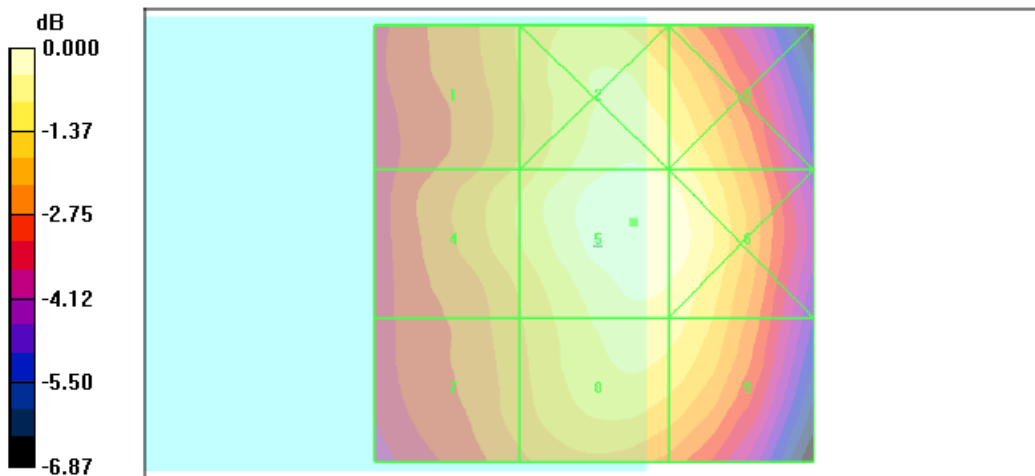

0 dB = 145.1V/m



Test Laboratory: Sporton International Inc. SAR/HAC Testing Lab

Date:2008/3/18

HAC_E_GSM850 Ch128_Open

DUT: 821901

Communication System: GSM850; Frequency: 824.2 MHz;Duty Cycle: 1:8.3
Medium: Air Medium parameters used: sigma = 0 mho/m, epsilon_r = 1; rho = 1000 kg/m^3
Ambient Temperature : 22.8 C

DASY4 Configuration:

- Probe: ER3DV6 - SN2358; ConvF(1, 1, 1); Calibrated: 2008/1/28
- Sensor-Surface: (Fix Surface)
- Electronics: DAE4 Sn778; Calibrated: 2007/9/17
- Phantom: HAC Test Arch 4.6; Type: SD HAC P01 BA;
- Measurement SW: DASY4, V4.7 Build 55; Postprocessing SW: SEMCAD, V1.8 Build 176

CH128/Hearing Aid Compatibility Test (101x101x1): Measurement grid: dx=5mm, dy=5mm

Maximum value of peak Total field = 167.4 V/m

Probe Modulation Factor = 2.73

Device Reference Point: 0.000, 0.000, 353.7 mm

Reference Value = 64.6 V/m; Power Drift = 0.003 dB

Hearing Aid Near-Field Category: M3 (AWF -5 dB)

Peak E-field in V/m

Table with 3 columns (Grid 1-3, Grid 4-6, Grid 7-9) and 3 rows of peak E-field values in V/m.

Cursor:

Total = 167.4 V/m

E Category: M3

Location: -4.5, -1, 364.8 mm

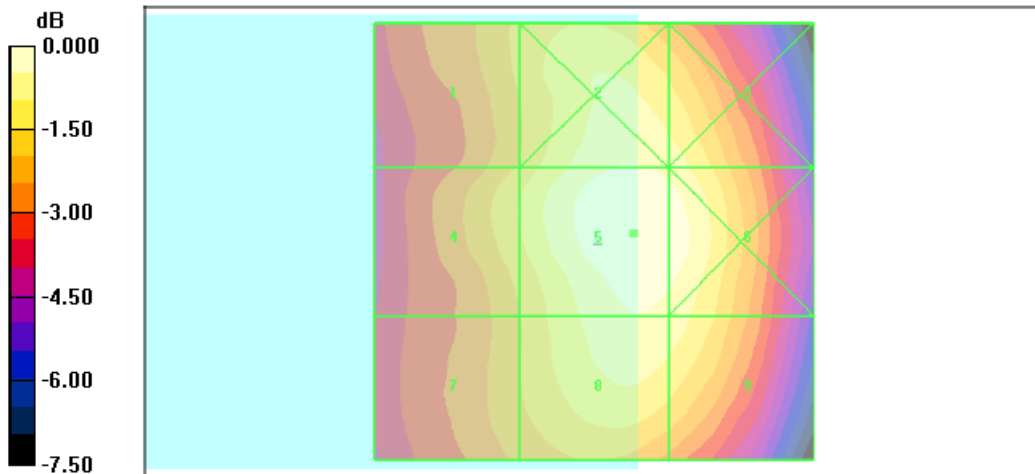

0 dB = 167.4V/m



Test Laboratory: Sporton International Inc. SAR/HAC Testing Lab

Date:2008/3/18

HAC_E_GSM850 Ch189_Open

DUT: 821901

Communication System: GSM850; Frequency: 836.4 MHz;Duty Cycle: 1:8.3
Medium: Air Medium parameters used: sigma = 0 mho/m, epsilon_r = 1; rho = 1000 kg/m^3
Ambient Temperature : 22.8 C

DASY4 Configuration:

- Probe: ER3DV6 - SN2358; ConvF(1, 1, 1); Calibrated: 2008/1/28
- Sensor-Surface: (Fix Surface)
- Electronics: DAE4 Sn778; Calibrated: 2007/9/17
- Phantom: HAC Test Arch 4.6; Type: SD HAC P01 BA;
- Measurement SW: DASY4, V4.7 Build 55; Postprocessing SW: SEMCAD, V1.8 Build 176

CH189/Hearing Aid Compatibility Test (101x101x1): Measurement grid: dx=5mm, dy=5mm

Maximum value of peak Total field = 175.1 V/m

Probe Modulation Factor = 2.73

Device Reference Point: 0.000, 0.000, 353.7 mm

Reference Value = 67.3 V/m; Power Drift = -0.017 dB

Hearing Aid Near-Field Category: M3 (AWF -5 dB)

Peak E-field in V/m

Table with 3 columns (Grid 1-3, Grid 4-6, Grid 7-9) and 3 rows of peak E-field values in V/m.

Cursor:

Total = 175.1 V/m

E Category: M3

Location: -4.5, -2.5, 364.8 mm

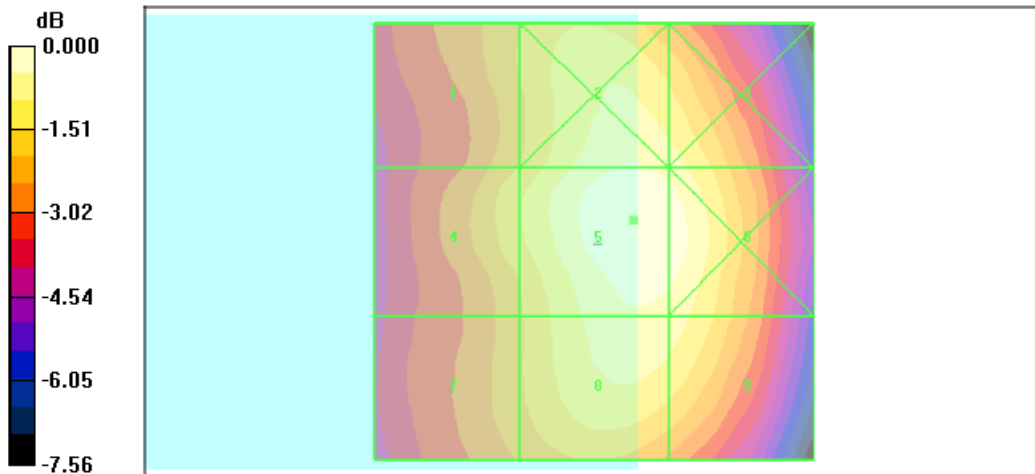

0 dB = 175.1V/m



Test Laboratory: Sporton International Inc. SAR/HAC Testing Lab

Date:2008/3/18

HAC_E_GSM850 Ch251_Open

DUT: 821901

Communication System: GSM850; Frequency: 848.8 MHz;Duty Cycle: 1:8.3
Medium: Air Medium parameters used: sigma = 0 mho/m, epsilon_r = 1; rho = 1000 kg/m^3
Ambient Temperature : 22.8 C

DASY4 Configuration:

- Probe: ER3DV6 - SN2358; ConvF(1, 1, 1); Calibrated: 2008/1/28
- Sensor-Surface: (Fix Surface)
- Electronics: DAE4 Sn778; Calibrated: 2007/9/17
- Phantom: HAC Test Arch 4.6; Type: SD HAC P01 BA;
- Measurement SW: DASY4, V4.7 Build 55; Postprocessing SW: SEMCAD, V1.8 Build 176

CH251/Hearing Aid Compatibility Test (101x101x1): Measurement grid: dx=5mm, dy=5mm

Maximum value of peak Total field = 177.5 V/m

Probe Modulation Factor = 2.73

Device Reference Point: 0.000, 0.000, 353.7 mm

Reference Value = 67.6 V/m; Power Drift = 0.008 dB

Hearing Aid Near-Field Category: M3 (AWF -5 dB)

Peak E-field in V/m

Table with 3 columns (Grid 1-3, Grid 4-6, Grid 7-9) and 3 rows of peak E-field values in V/m.

Cursor:

Total = 177.5 V/m

E Category: M3

Location: -4.5, -2, 364.8 mm

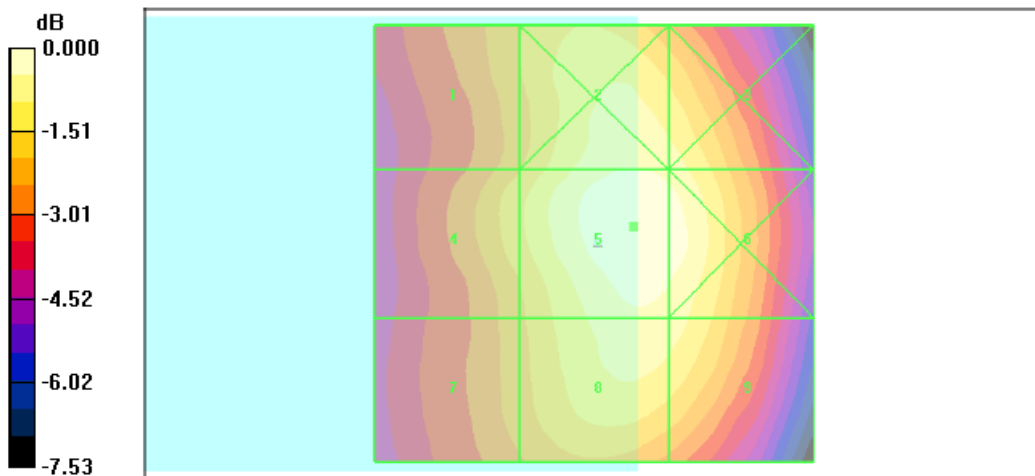

0 dB = 177.5V/m



Test Laboratory: Sporton International Inc. SAR/HAC Testing Lab

Data:2008/3/18

HAC_E_GSM850 Ch251_Open_Backlight on

DUT: 821901

Communication System: GSM850; Frequency: 848.8 MHz;Duty Cycle: 1:8.3
Medium: Air Medium parameters used: sigma = 0 mho/m, epsilon_r = 1; rho = 1000 kg/m^3
Ambient Temperature : 22.8 C

DASY4 Configuration:

- Probe: ER3DV6 - SN2358; ConvF(1, 1, 1); Calibrated: 2008/1/28
- Sensor-Surface: (Fix Surface)
- Electronics: DAE4 Sn778; Calibrated: 2007/9/17
- Phantom: HAC Test Arch 4.6; Type: SD HAC P01 BA;
- Measurement SW: DASY4, V4.7 Build 55; Postprocessing SW: SEMCAD, V1.8 Build 176

CH251/Hearing Aid Compatibility Test (101x101x1): Measurement grid: dx=5mm, dy=5mm

Maximum value of peak Total field = 176.5 V/m

Probe Modulation Factor = 2.73

Device Reference Point: 0.000, 0.000, 353.7 mm

Reference Value = 66.7 V/m; Power Drift = 0.101 dB

Hearing Aid Near-Field Category: M3 (AWF -5 dB)

Peak E-field in V/m

Table with 3 columns (Grid 1-3, Grid 4-6, Grid 7-9) and 3 rows of peak E-field values in V/m.

Cursor:

Total = 176.5 V/m

E Category: M3

Location: -4.5, -1.5, 364.8 mm

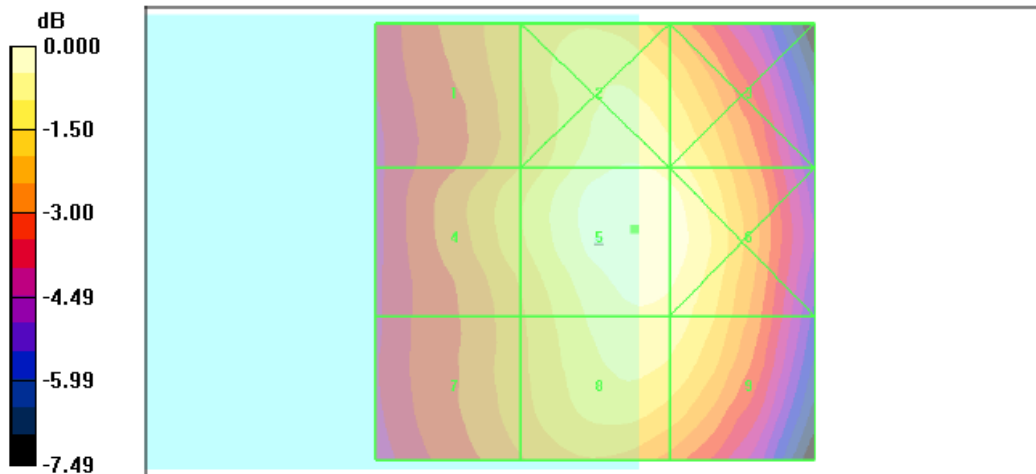

0 dB = 176.5V/m



Test Laboratory: Sporton International Inc. SAR/HAC Testing Lab

Data:2008/3/18

HAC_E_GSM850 Ch251_Open_Bluetooth on

DUT: 821901

Communication System: GSM850; Frequency: 848.8 MHz;Duty Cycle: 1:8.3
Medium: Air Medium parameters used: sigma = 0 mho/m, epsilon_r = 1; rho = 1000 kg/m^3
Ambient Temperature : 22.8 C

DASY4 Configuration:

- Probe: ER3DV6 - SN2358; ConvF(1, 1, 1); Calibrated: 2008/1/28
- Sensor-Surface: (Fix Surface)
- Electronics: DAE4 Sn778; Calibrated: 2007/9/17
- Phantom: HAC Test Arch 4.6; Type: SD HAC P01 BA;
- Measurement SW: DASY4, V4.7 Build 55; Postprocessing SW: SEMCAD, V1.8 Build 176

CH251/Hearing Aid Compatibility Test (101x101x1): Measurement grid: dx=5mm, dy=5mm

Maximum value of peak Total field = 176.9 V/m

Probe Modulation Factor = 2.73

Device Reference Point: 0.000, 0.000, 353.7 mm

Reference Value = 67.3 V/m; Power Drift = 0.045 dB

Hearing Aid Near-Field Category: M3 (AWF -5 dB)

Peak E-field in V/m

Table with 3 columns (Grid 1-3, Grid 4-6, Grid 7-9) and 3 rows of peak E-field values in V/m.

Cursor:

Total = 176.9 V/m

E Category: M3

Location: -4.5, -2, 364.8 mm

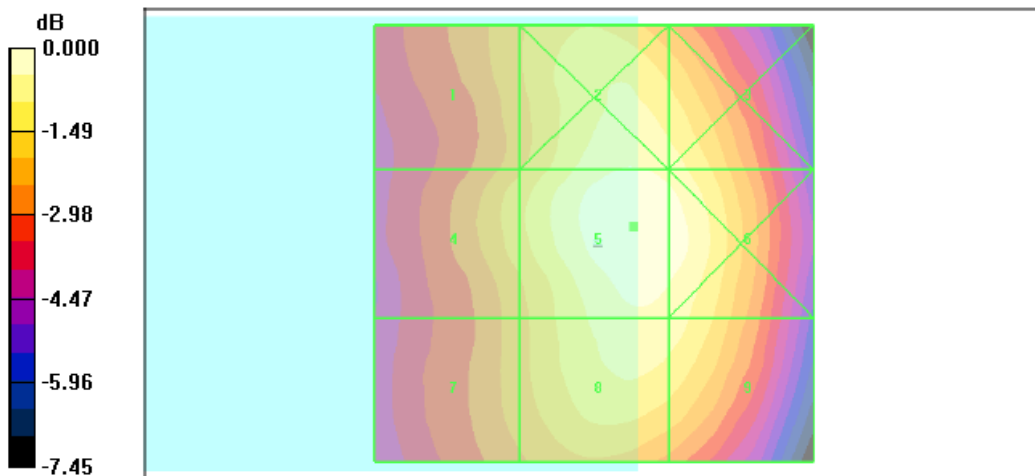

0 dB = 176.9V/m



Test Laboratory: Sporton International Inc. SAR/HAC Testing Lab

Data:2008/3/18

HAC_E_GSM850 Ch251_Open_Wifi on

DUT: 821901

Communication System: GSM850; Frequency: 848.8 MHz;Duty Cycle: 1:8.3
Medium: Air Medium parameters used: sigma = 0 mho/m, epsilon_r = 1; rho = 1000 kg/m^3
Ambient Temperature : 22.8 C

DASY4 Configuration:

- Probe: ER3DV6 - SN2358; ConvF(1, 1, 1); Calibrated: 2008/1/28
- Sensor-Surface: (Fix Surface)
- Electronics: DAE4 Sn778; Calibrated: 2007/9/17
- Phantom: HAC Test Arch 4.6; Type: SD HAC P01 BA;
- Measurement SW: DASY4, V4.7 Build 55; Postprocessing SW: SEMCAD, V1.8 Build 176

CH251/Hearing Aid Compatibility Test (101x101x1): Measurement grid: dx=5mm, dy=5mm

Maximum value of peak Total field = 178.9 V/m

Probe Modulation Factor = 2.73

Device Reference Point: 0.000, 0.000, 353.7 mm

Reference Value = 67.7 V/m; Power Drift = -0.108 dB

Hearing Aid Near-Field Category: M3 (AWF -5 dB)

Peak E-field in V/m

Table with 3 columns (Grid 1-3, Grid 4-6, Grid 7-9) and 3 rows of peak E-field values in V/m.

Cursor:

Total = 178.9 V/m

E Category: M3

Location: -5, -3.5, 364.8 mm

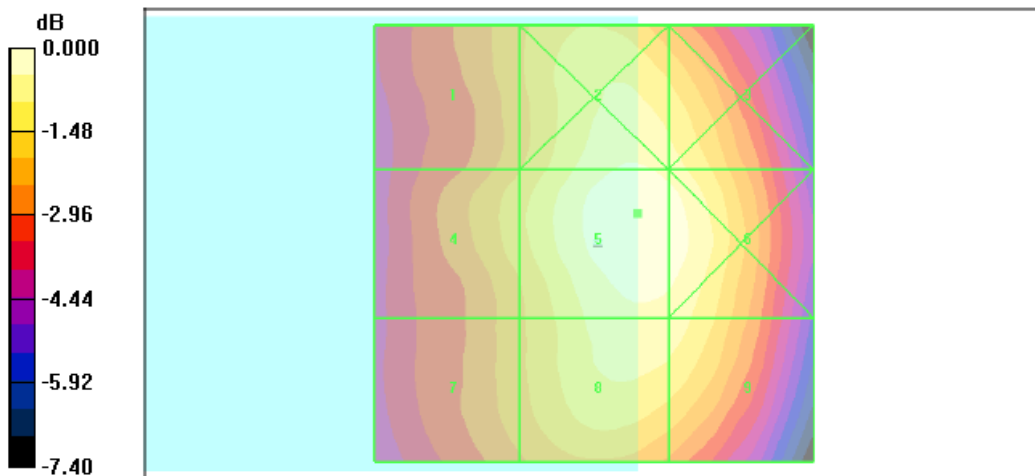

0 dB = 178.9V/m



Test Laboratory: Sporton International Inc. SAR/HAC Testing Lab

Date:2008/3/18

HAC_E_PCS Ch512_Close

DUT: 821901

Communication System: PCS; Frequency: 1850.2 MHz;Duty Cycle: 1:8.3
Medium: Air Medium parameters used: sigma = 0 mho/m, epsilon_r = 1; rho = 1000 kg/m^3
Ambient Temperature : 22.2 C

DASY4 Configuration:

- Probe: ER3DV6 - SN2358; ConvF(1, 1, 1); Calibrated: 2008/1/28
- Sensor-Surface: (Fix Surface)
- Electronics: DAE4 Sn778; Calibrated: 2007/9/17
- Phantom: HAC Test Arch 4.6; Type: SD HAC P01 BA;
- Measurement SW: DASY4, V4.7 Build 55; Postprocessing SW: SEMCAD, V1.8 Build 176

CH512/Hearing Aid Compatibility Test (101x101x1): Measurement grid: dx=5mm, dy=5mm

Maximum value of peak Total field = 59.1 V/m

Probe Modulation Factor = 2.74

Device Reference Point: 0.000, 0.000, 353.7 mm

Reference Value = 18.4 V/m; Power Drift = 0.039 dB

Hearing Aid Near-Field Category: M3 (AWF -5 dB)

Peak E-field in V/m

Table with 3 columns (Grid 1-3, Grid 4-6, Grid 7-9) and 3 rows showing peak E-field values in V/m for each grid.

Cursor:

Total = 59.1 V/m

E Category: M3

Location: -5.5, -6.5, 364.8 mm

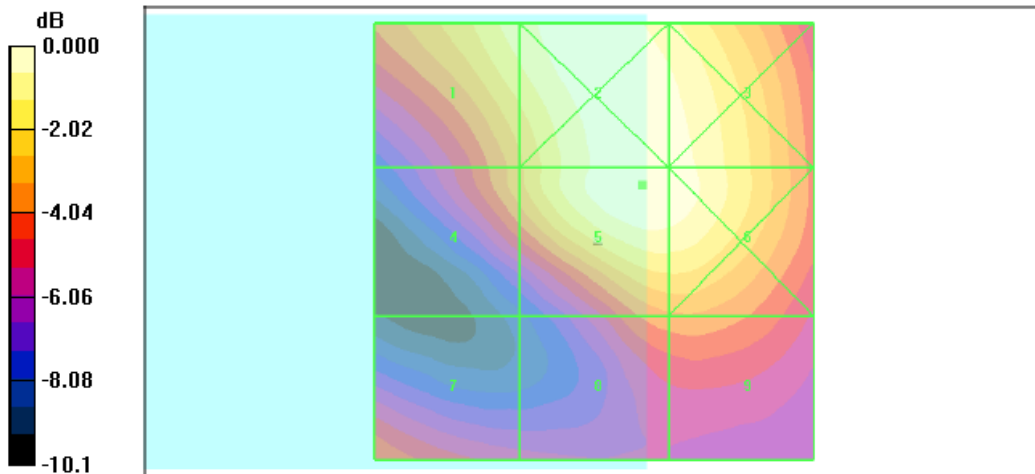

0 dB = 59.1V/m



Test Laboratory: Sporton International Inc. SAR/HAC Testing Lab

Date:2008/3/18

HAC_E_PCS Ch661_Close

DUT: 821901

Communication System: PCS; Frequency: 1880 MHz;Duty Cycle: 1:8.3
Medium: Air Medium parameters used: sigma = 0 mho/m, epsilon_r = 1; rho = 1000 kg/m^3
Ambient Temperature : 22.2 C

DASY4 Configuration:

- Probe: ER3DV6 - SN2358; ConvF(1, 1, 1); Calibrated: 2008/1/28
- Sensor-Surface: (Fix Surface)
- Electronics: DAE4 Sn778; Calibrated: 2007/9/17
- Phantom: HAC Test Arch 4.6; Type: SD HAC P01 BA;
- Measurement SW: DASY4, V4.7 Build 55; Postprocessing SW: SEMCAD, V1.8 Build 176

CH661/Hearing Aid Compatibility Test (101x101x1): Measurement grid: dx=5mm, dy=5mm

Maximum value of peak Total field = 66.2 V/m

Probe Modulation Factor = 2.74

Device Reference Point: 0.000, 0.000, 353.7 mm

Reference Value = 18.3 V/m; Power Drift = 0.059 dB

Hearing Aid Near-Field Category: M3 (AWF -5 dB)

Peak E-field in V/m

Table with 3 columns (Grid 1-3, Grid 4-6, Grid 7-9) and 3 rows of peak E-field values in V/m.

Cursor:

Total = 72.5 V/m

E Category: M3

Location: -2.5, -22, 364.8 mm

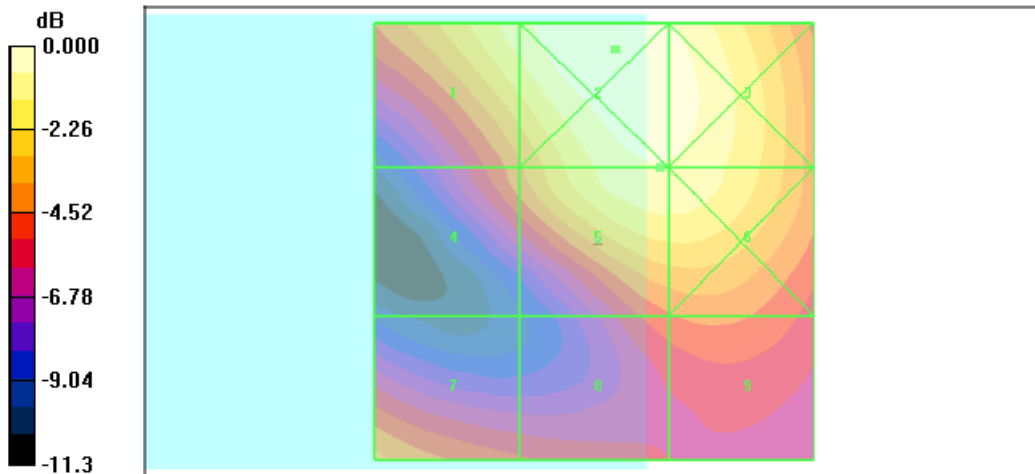

0 dB = 72.5V/m



Test Laboratory: Sporton International Inc. SAR/HAC Testing Lab

Date:2008/3/18

HAC_E_PCS Ch810_Close

DUT: 821901

Communication System: PCS; Frequency: 1909.8 MHz;Duty Cycle: 1:8.3
Medium: Air Medium parameters used: sigma = 0 mho/m, epsilon_r = 1; rho = 1000 kg/m^3
Ambient Temperature : 22.2 C

DASY4 Configuration:

- Probe: ER3DV6 - SN2358; ConvF(1, 1, 1); Calibrated: 2008/1/28
- Sensor-Surface: (Fix Surface)
- Electronics: DAE4 Sn778; Calibrated: 2007/9/17
- Phantom: HAC Test Arch 4.6; Type: SD HAC P01 BA;
- Measurement SW: DASY4, V4.7 Build 55; Postprocessing SW: SEMCAD, V1.8 Build 176

CH810/Hearing Aid Compatibility Test (101x101x1): Measurement grid: dx=5mm, dy=5mm

Maximum value of peak Total field = 77.5 V/m

Probe Modulation Factor = 2.74

Device Reference Point: 0.000, 0.000, 353.7 mm

Reference Value = 21.0 V/m; Power Drift = -0.266 dB

Hearing Aid Near-Field Category: M3 (AWF -5 dB)

Peak E-field in V/m

Table with 3 columns (Grid 1-3, Grid 4-6, Grid 7-9) and 3 rows of peak E-field values in V/m.

Cursor:

Total = 88.1 V/m

E Category: M2

Location: -3, -22.5, 364.8 mm

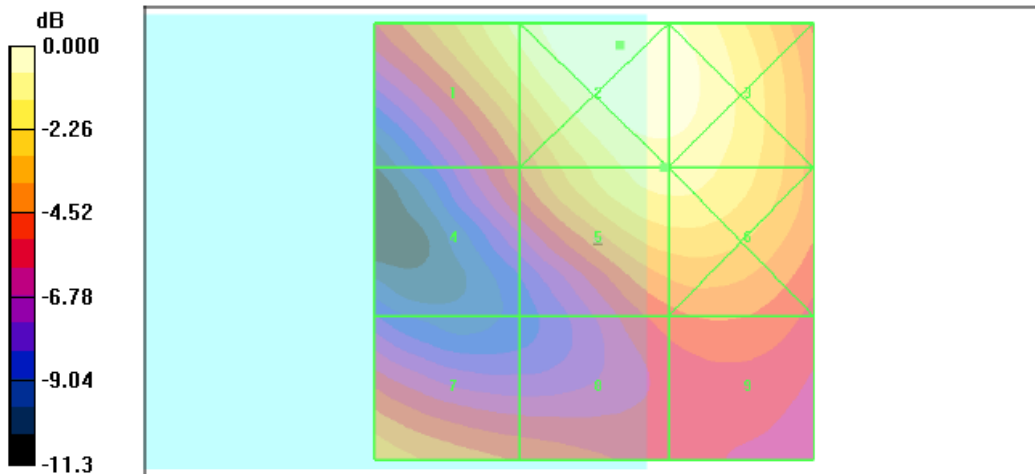

0 dB = 88.1V/m



Test Laboratory: Sporton International Inc. SAR/HAC Testing Lab

Date:2008/3/18

HAC_E_PCS Ch810_Close_Backlight on

DUT: 821901

Communication System: PCS; Frequency: 1909.8 MHz;Duty Cycle: 1:8.3
Medium: Air Medium parameters used: sigma = 0 mho/m, epsilon_r = 1; rho = 1000 kg/m^3
Ambient Temperature : 22.2 C

DASY4 Configuration:

- Probe: ER3DV6 - SN2358; ConvF(1, 1, 1); Calibrated: 2008/1/28
- Sensor-Surface: (Fix Surface)
- Electronics: DAE4 Sn778; Calibrated: 2007/9/17
- Phantom: HAC Test Arch 4.6; Type: SD HAC P01 BA;
- Measurement SW: DASY4, V4.7 Build 55; Postprocessing SW: SEMCAD, V1.8 Build 176

CH810/Hearing Aid Compatibility Test (101x101x1): Measurement grid: dx=5mm, dy=5mm

Maximum value of peak Total field = 77.9 V/m

Probe Modulation Factor = 2.74

Device Reference Point: 0.000, 0.000, 353.7 mm

Reference Value = 21.2 V/m; Power Drift = 0.051 dB

Hearing Aid Near-Field Category: M3 (AWF -5 dB)

Peak E-field in V/m

Table with 3 columns (Grid 1-3, Grid 4-6, Grid 7-9) and 3 rows of peak E-field values in V/m.

Cursor:

Total = 87.6 V/m

E Category: M2

Location: -2.5, -22, 364.8 mm

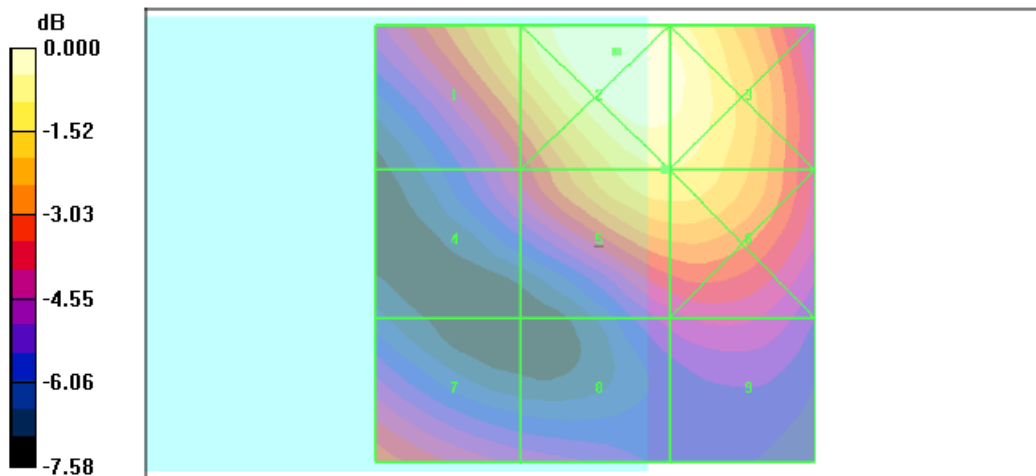

0 dB = 87.6V/m



Test Laboratory: Sporton International Inc. SAR/HAC Testing Lab

Date:2008/3/18

HAC_E_PCS Ch810_Close_Bluetooth on

DUT: 821901

Communication System: PCS; Frequency: 1909.8 MHz;Duty Cycle: 1:8.3
Medium: Air Medium parameters used: sigma = 0 mho/m, epsilon_r = 1; rho = 1000 kg/m^3
Ambient Temperature : 22.2 C

DASY4 Configuration:

- Probe: ER3DV6 - SN2358; ConvF(1, 1, 1); Calibrated: 2008/1/28
- Sensor-Surface: (Fix Surface)
- Electronics: DAE4 Sn778; Calibrated: 2007/9/17
- Phantom: HAC Test Arch 4.6; Type: SD HAC P01 BA;
- Measurement SW: DASY4, V4.7 Build 55; Postprocessing SW: SEMCAD, V1.8 Build 176

CH810/Hearing Aid Compatibility Test (101x101x1): Measurement grid: dx=5mm, dy=5mm

Maximum value of peak Total field = 77.7 V/m

Probe Modulation Factor = 2.74

Device Reference Point: 0.000, 0.000, 353.7 mm

Reference Value = 21.3 V/m; Power Drift = 0.036 dB

Hearing Aid Near-Field Category: M3 (AWF -5 dB)

Peak E-field in V/m

Table with 3 columns (Grid 1-3, Grid 4-6, Grid 7-9) and 3 rows of peak E-field values in V/m.

Cursor:

Total = 87.9 V/m

E Category: M2

Location: -3, -21.5, 364.8 mm

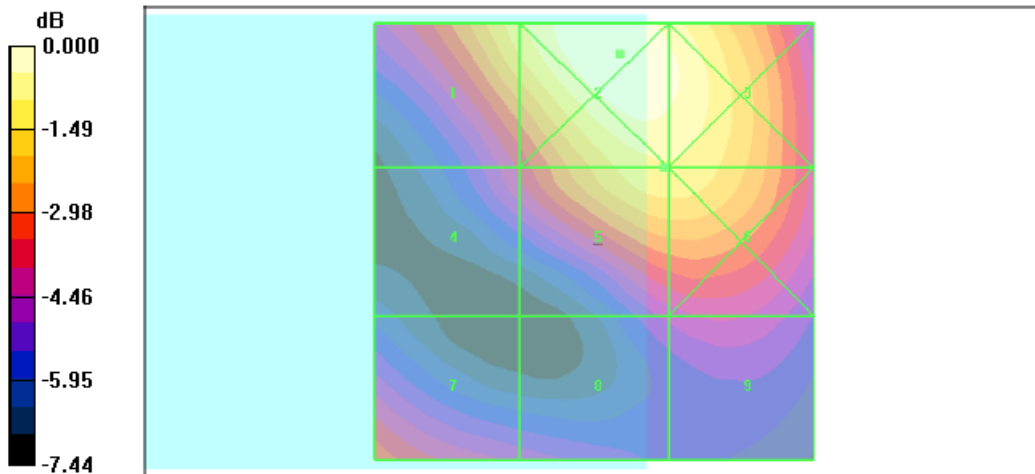



Test Laboratory: Sporton International Inc. SAR/HAC Testing Lab

Date:2008/3/18

HAC_E_PCS Ch810_Close_Wifi on

DUT: 821901

Communication System: PCS; Frequency: 1909.8 MHz;Duty Cycle: 1:8.3
Medium: Air Medium parameters used: sigma = 0 mho/m, epsilon_r = 1; rho = 1000 kg/m^3
Ambient Temperature : 22.8 C

DASY4 Configuration:

- Probe: ER3DV6 - SN2358; ConvF(1, 1, 1); Calibrated: 2008/1/28
- Sensor-Surface: (Fix Surface)
- Electronics: DAE4 Sn778; Calibrated: 2007/9/17
- Phantom: HAC Test Arch 4.6; Type: SD HAC P01 BA;
- Measurement SW: DASY4, V4.7 Build 55; Postprocessing SW: SEMCAD, V1.8 Build 176

CH810/Hearing Aid Compatibility Test (101x101x1): Measurement grid: dx=5mm, dy=5mm

Maximum value of peak Total field = 79.2 V/m

Probe Modulation Factor = 2.74

Device Reference Point: 0.000, 0.000, 353.7 mm

Reference Value = 20.9 V/m; Power Drift = -0.074 dB

Hearing Aid Near-Field Category: M3 (AWF -5 dB)

Peak E-field in V/m

Table with 3 columns (Grid 1-3, Grid 4-6, Grid 7-9) and 3 rows of peak E-field values in V/m.

Cursor:

Total = 92.9 V/m

E Category: M2

Location: -3, -23, 364.8 mm

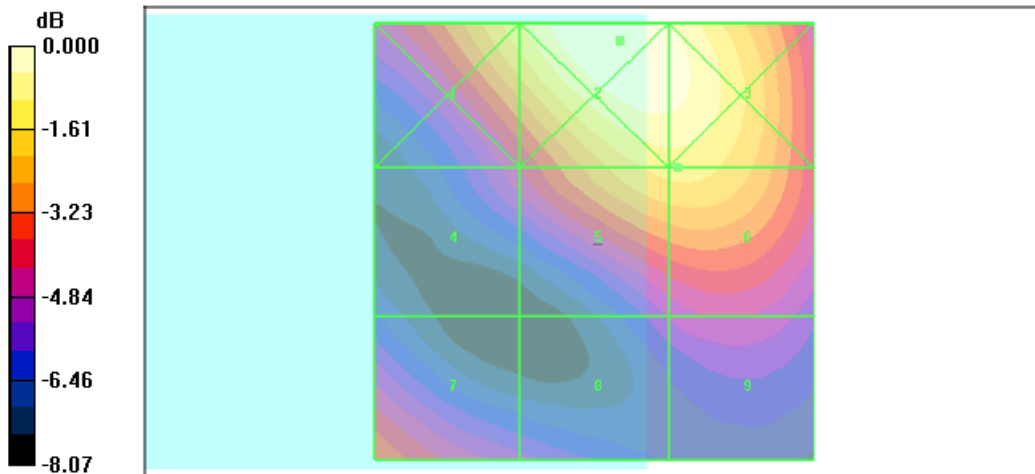

0 dB = 92.9V/m



Test Laboratory: Sporton International Inc. SAR/HAC Testing Lab

Date:2008/3/18

HAC_E_PCS Ch512_Open

DUT: 821901

Communication System: PCS; Frequency: 1850.2 MHz;Duty Cycle: 1:8.3
Medium: Air Medium parameters used: sigma = 0 mho/m, epsilon_r = 1; rho = 1000 kg/m^3
Ambient Temperature : 22.2 C

DASY4 Configuration:

- Probe: ER3DV6 - SN2358; ConvF(1, 1, 1); Calibrated: 2008/1/28
- Sensor-Surface: (Fix Surface)
- Electronics: DAE4 Sn778; Calibrated: 2007/9/17
- Phantom: HAC Test Arch 4.6; Type: SD HAC P01 BA;
- Measurement SW: DASY4, V4.7 Build 55; Postprocessing SW: SEMCAD, V1.8 Build 176

CH512/Hearing Aid Compatibility Test (101x101x1): Measurement grid: dx=5mm, dy=5mm

Maximum value of peak Total field = 52.2 V/m

Probe Modulation Factor = 2.74

Device Reference Point: 0.000, 0.000, 353.7 mm

Reference Value = 14.8 V/m; Power Drift = 0.037 dB

Hearing Aid Near-Field Category: M3 (AWF -5 dB)

Peak E-field in V/m

Table with 3 columns (Grid 1-3, Grid 4-6, Grid 7-9) and 3 rows of peak E-field values in V/m.

Cursor:

Total = 59.0 V/m

E Category: M3

Location: -1, -23.5, 364.8 mm

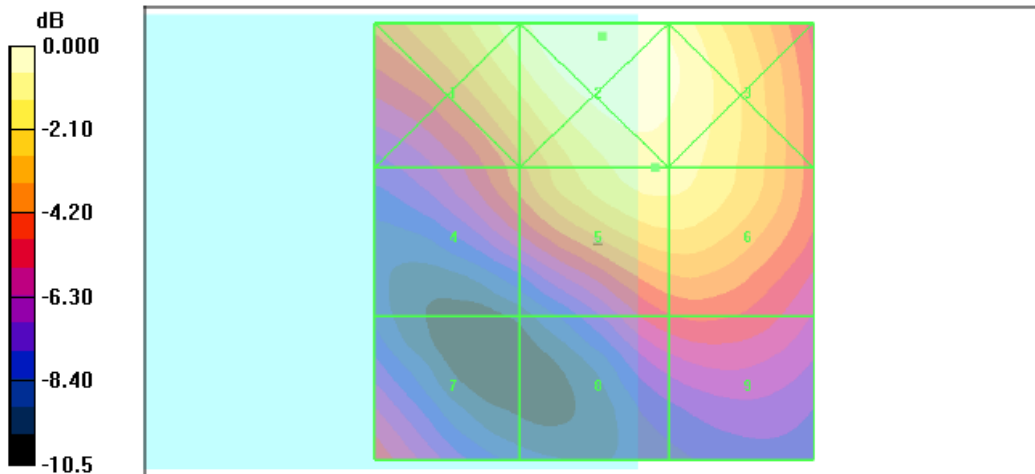

0 dB = 59.0V/m



Test Laboratory: Sporton International Inc. SAR/HAC Testing Lab

Date:2008/3/18

HAC_E_PCS Ch661_Open

DUT: 821901

Communication System: PCS; Frequency: 1880 MHz;Duty Cycle: 1:8.3
Medium: Air Medium parameters used: sigma = 0 mho/m, epsilon_r = 1; rho = 1000 kg/m^3
Ambient Temperature : 22.2 C

DASY4 Configuration:

- Probe: ER3DV6 - SN2358; ConvF(1, 1, 1); Calibrated: 2008/1/28
- Sensor-Surface: (Fix Surface)
- Electronics: DAE4 Sn778; Calibrated: 2007/9/17
- Phantom: HAC Test Arch 4.6; Type: SD HAC P01 BA;
- Measurement SW: DASY4, V4.7 Build 55; Postprocessing SW: SEMCAD, V1.8 Build 176

CH661/Hearing Aid Compatibility Test (101x101x1): Measurement grid: dx=5mm, dy=5mm

Maximum value of peak Total field = 58.6 V/m

Probe Modulation Factor = 2.74

Device Reference Point: 0.000, 0.000, 353.7 mm

Reference Value = 16.3 V/m; Power Drift = 0.016 dB

Hearing Aid Near-Field Category: M3 (AWF -5 dB)

Peak E-field in V/m

Table with 3 columns (Grid 1-3, Grid 4-6, Grid 7-9) and 3 rows of peak E-field values in V/m.

Cursor:

Total = 70.6 V/m

E Category: M3

Location: -1.5, -23, 364.8 mm

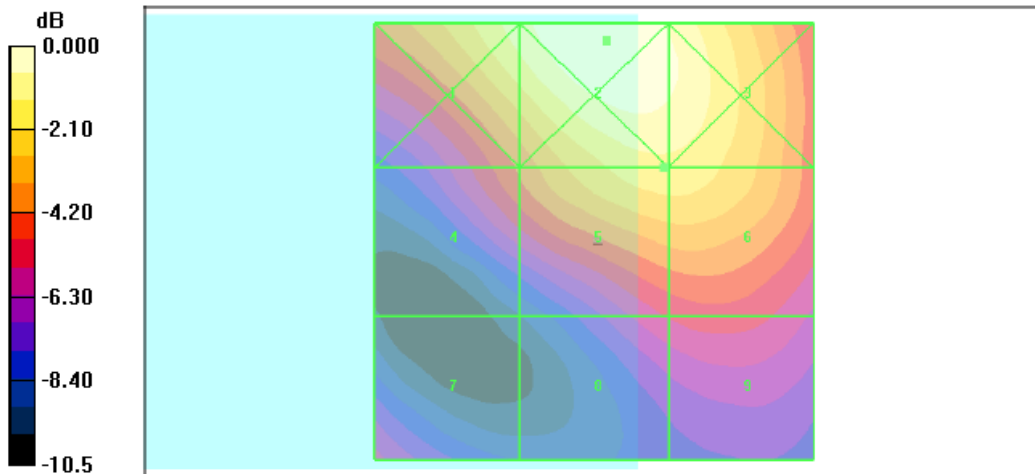

0 dB = 70.6V/m



Test Laboratory: Sporton International Inc. SAR/HAC Testing Lab

Date:2008/3/18

HAC_E_PCS Ch810_Open

DUT: 821901

Communication System: PCS; Frequency: 1909.8 MHz;Duty Cycle: 1:8.3
Medium: Air Medium parameters used: sigma = 0 mho/m, epsilon_r = 1; rho = 1000 kg/m^3
Ambient Temperature : 22.2 C

DASY4 Configuration:

- Probe: ER3DV6 - SN2358; ConvF(1, 1, 1); Calibrated: 2008/1/28
- Sensor-Surface: (Fix Surface)
- Electronics: DAE4 Sn778; Calibrated: 2007/9/17
- Phantom: HAC Test Arch 4.6; Type: SD HAC P01 BA;
- Measurement SW: DASY4, V4.7 Build 55; Postprocessing SW: SEMCAD, V1.8 Build 176

CH810/Hearing Aid Compatibility Test (101x101x1): Measurement grid: dx=5mm, dy=5mm

Maximum value of peak Total field = 68.1 V/m

Probe Modulation Factor = 2.74

Device Reference Point: 0.000, 0.000, 353.7 mm

Reference Value = 18.7 V/m; Power Drift = 0.016 dB

Hearing Aid Near-Field Category: M3 (AWF -5 dB)

Peak E-field in V/m

Table with 3 columns (Grid 1-3, Grid 4-6, Grid 7-9) and 3 rows of peak E-field values in V/m.

Cursor:

Total = 84.6 V/m

E Category: M2

Location: -1, -24, 364.8 mm

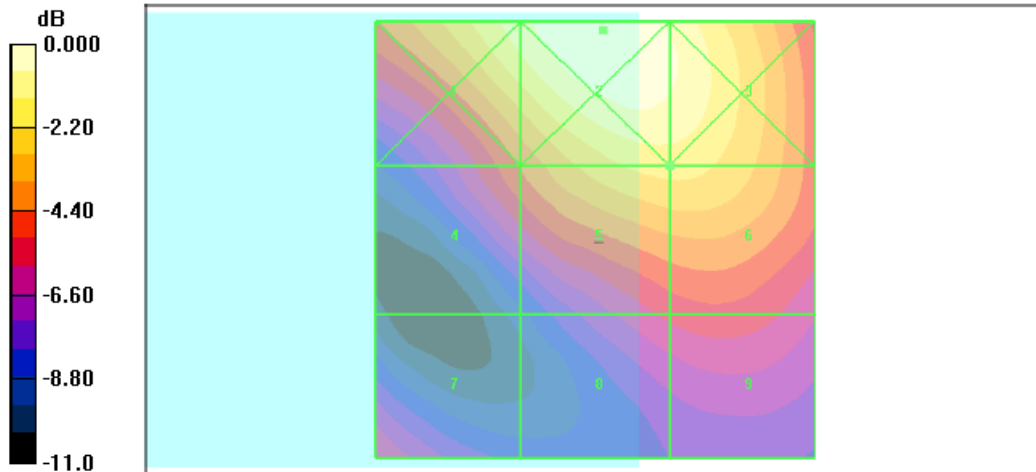

0 dB = 84.6V/m



Test Laboratory: Sporton International Inc. SAR/HAC Testing Lab

Date:2008/3/18

HAC_E_PCS Ch810_Open_Backlight on

DUT: 821901

Communication System: PCS; Frequency: 1909.8 MHz;Duty Cycle: 1:8.3
Medium: Air Medium parameters used: sigma = 0 mho/m, epsilon_r = 1; rho = 1000 kg/m^3
Ambient Temperature : 22.2 C

DASY4 Configuration:

- Probe: ER3DV6 - SN2358; ConvF(1, 1, 1); Calibrated: 2008/1/28
- Sensor-Surface: (Fix Surface)
- Electronics: DAE4 Sn778; Calibrated: 2007/9/17
- Phantom: HAC Test Arch 4.6; Type: SD HAC P01 BA;
- Measurement SW: DASY4, V4.7 Build 55; Postprocessing SW: SEMCAD, V1.8 Build 176

CH810/Hearing Aid Compatibility Test (101x101x1): Measurement grid: dx=5mm, dy=5mm

Maximum value of peak Total field = 67.5 V/m

Probe Modulation Factor = 2.74

Device Reference Point: 0.000, 0.000, 353.7 mm

Reference Value = 18.8 V/m; Power Drift = 0.087 dB

Hearing Aid Near-Field Category: M3 (AWF -5 dB)

Peak E-field in V/m

Table with 3 columns (Grid 1-3, Grid 4-6, Grid 7-9) and 3 rows of peak E-field values in V/m.

Cursor:

Total = 82.2 V/m

E Category: M3

Location: -1.5, -23, 364.8 mm

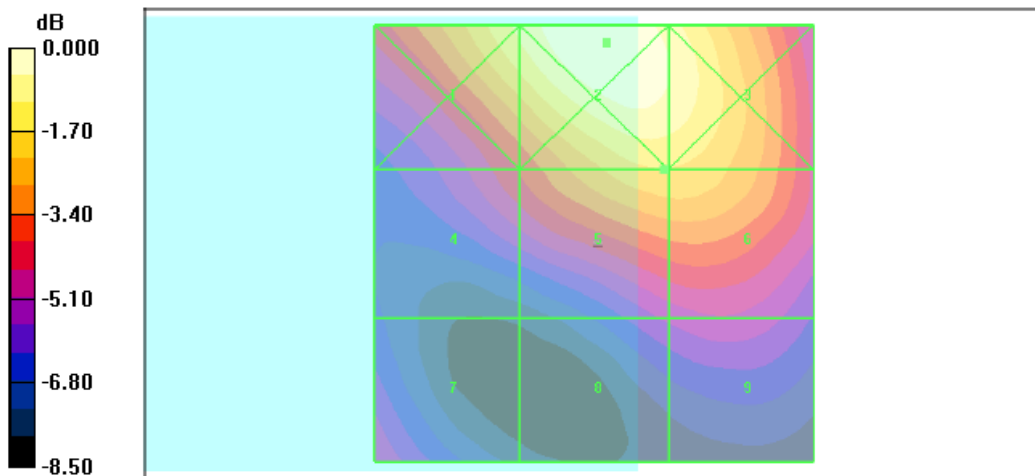

0 dB = 82.2V/m



Test Laboratory: Sporton International Inc. SAR/HAC Testing Lab

Date:2008/3/18

HAC_E_PCS Ch810_Open_Bluetooth on

DUT: 821901

Communication System: PCS; Frequency: 1909.8 MHz;Duty Cycle: 1:8.3
Medium: Air Medium parameters used: sigma = 0 mho/m, epsilon_r = 1; rho = 1000 kg/m^3
Ambient Temperature : 22.2 C

DASY4 Configuration:

- Probe: ER3DV6 - SN2358; ConvF(1, 1, 1); Calibrated: 2008/1/28
- Sensor-Surface: (Fix Surface)
- Electronics: DAE4 Sn778; Calibrated: 2007/9/17
- Phantom: HAC Test Arch 4.6; Type: SD HAC P01 BA;
- Measurement SW: DASY4, V4.7 Build 55; Postprocessing SW: SEMCAD, V1.8 Build 176

CH810/Hearing Aid Compatibility Test (101x101x1): Measurement grid: dx=5mm, dy=5mm

Maximum value of peak Total field = 67.9 V/m

Probe Modulation Factor = 2.74

Device Reference Point: 0.000, 0.000, 353.7 mm

Reference Value = 19.0 V/m; Power Drift = 0.098 dB

Hearing Aid Near-Field Category: M3 (AWF -5 dB)

Peak E-field in V/m

Table with 3 columns (Grid 1-3, Grid 4-6, Grid 7-9) and 3 rows of peak E-field values in V/m.

Cursor:

Total = 82.0 V/m

E Category: M3

Location: -1, -23.5, 364.8 mm

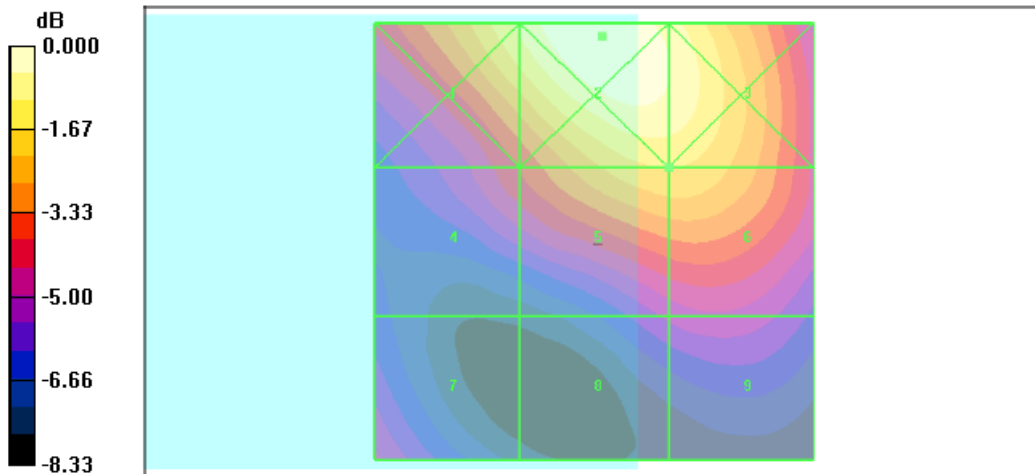

0 dB = 82.0V/m



Test Laboratory: Sporton International Inc. SAR/HAC Testing Lab

Date:2008/3/18

HAC_E_PCS Ch810_Open_Wifi on

DUT: 821901

Communication System: PCS; Frequency: 1909.8 MHz;Duty Cycle: 1:8.3
Medium: Air Medium parameters used: sigma = 0 mho/m, epsilon_r = 1; rho = 1000 kg/m^3
Ambient Temperature : 22.8 C

DASY4 Configuration:

- Probe: ER3DV6 - SN2358; ConvF(1, 1, 1); Calibrated: 2008/1/28
- Sensor-Surface: (Fix Surface)
- Electronics: DAE4 Sn778; Calibrated: 2007/9/17
- Phantom: HAC Test Arch 4.6; Type: SD HAC P01 BA;
- Measurement SW: DASY4, V4.7 Build 55; Postprocessing SW: SEMCAD, V1.8 Build 176

CH810/Hearing Aid Compatibility Test (101x101x1): Measurement grid: dx=5mm, dy=5mm

Maximum value of peak Total field = 71.0 V/m

Probe Modulation Factor = 2.74

Device Reference Point: 0.000, 0.000, 353.7 mm

Reference Value = 19.9 V/m; Power Drift = 0.106 dB

Hearing Aid Near-Field Category: M3 (AWF -5 dB)

Peak E-field in V/m

Table with 3 columns (Grid 1-3, Grid 4-6, Grid 7-9) and 3 rows of peak E-field values in V/m.

Cursor:

Total = 85.0 V/m

E Category: M2

Location: -2, -23, 364.8 mm

