



# FCC TEST REPORT (PART 27)

**REPORT NO.:** RF140616C01-2

**MODEL NO.:** 0PCV220

**FCC ID:** NM80PCV220

**RECEIVED:** Jun. 16, 2014

**TESTED:** Jun. 25, 2014 ~ Jul. 23, 2014

**ISSUED:** Jul. 28, 2014

**APPLICANT:** HTC Corporation

**ADDRESS:** 1F, 6-3 Baoqiang Road, Xindian District, New Taipei City, Taiwan 231

**ISSUED BY:** Bureau Veritas Consumer Products Services (H.K.) Ltd., Taoyuan Branch

**LAB ADDRESS:** No. 47, 14th Ling, Chia Pau Vil., Lin Kou Dist., New Taipei City, Taiwan, R.O.C.

**TEST LOCATION:** No. 19, Hwa Ya 2nd Rd, Wen Hwa Tsuen, Kwei Shan Hsiang, Taoyuan Hsien 333, Taiwan, R.O.C.

This report should not be used by the client to claim product certification, approval, or endorsement by TAF or any government agencies.



This report is for your exclusive use. Any copying or replication of this report to or for any other person or entity, or use of our name or trademark, is permitted only with our prior written permission. This report sets forth our findings solely with respect to the test samples identified herein. The results set forth in this report are not indicative or representative of the quality or characteristics of the lot from which a test sample was taken or any similar or identical product unless specifically and expressly noted. Our report includes all of the tests requested by you and the results thereof based upon the information that you provided to us. You have 60 days from date of issuance of this report to notify us of any material error or omission caused by our negligence, provided, however, that such notice shall be in writing and shall specifically address the issue you wish to raise. A failure to raise such issue within the prescribed time shall constitute your unqualified acceptance of the completeness of this report, the tests conducted and the correctness of the report contents. Unless specific mention, the uncertainty of measurement has been explicitly taken into account to declare the compliance or non-compliance to the specification



# TABLE OF CONTENTS

RELEASE CONTROL RECORD.....	3
1 CERTIFICATION .....	4
2 SUMMARY OF TEST RESULTS.....	5
2.1 MEASUREMENT UNCERTAINTY .....	6
2.2 TEST SITE AND INSTRUMENTS .....	7
3 GENERAL INFORMATION .....	8
3.1 GENERAL DESCRIPTION OF EUT.....	8
3.2 CONFIGURATION OF SYSTEM UNDER TEST .....	10
3.3 DESCRIPTION OF SUPPORT UNITS.....	10
3.4 DESCRIPTION OF TEST MODES.....	11
3.5 GENERAL DESCRIPTION OF APPLIED STANDARDS .....	14
4 TEST TYPES AND RESULTS.....	15
4.1 OUTPUT POWER MEASUREMENT .....	15
4.1.1 LIMITS OF OUTPUT POWER MEASUREMENT .....	15
4.1.2 TEST PROCEDURES.....	15
4.1.3 TEST SETUP .....	16
4.1.4 TEST RESULTS .....	17
4.2 FREQUENCY STABILITY MEASUREMENT .....	26
4.2.1 LIMITS OF FREQUENCY STABILITY MEASUREMENT .....	26
4.2.2 TEST PROCEDURE .....	26
4.2.3 TEST SETUP .....	26
4.2.4 TEST RESULTS .....	27
4.3 OCCUPIED BANDWIDTH MEASUREMENT.....	28
4.3.1 LIMITS OF OCCUPIED BANDWIDTH MEASUREMENT.....	28
4.3.2 TEST SETUP .....	28
4.3.3 TEST PROCEDURES.....	28
4.3.4 TEST RESULTS .....	29
4.4 PEAK TO AVERAGE RATIO.....	33
4.4.1 LIMITS OF PEAK TO AVERAGE RATIO MEASUREMENT .....	33
4.4.2 TEST SETUP .....	33
4.4.3 TEST PROCEDURES.....	33
4.4.4 TEST RESULTS .....	34
4.5 BAND EDGE MEASUREMENT .....	38
4.5.1 LIMITS OF BAND EDGE MEASUREMENT .....	38
4.5.2 TEST SETUP .....	38
4.5.3 TEST PROCEDURES.....	39
4.5.4 TEST RESULTS .....	40
4.6 CONDUCTED SPURIOUS EMISSIONS.....	45
4.6.1 LIMITS OF CONDUCTED SPURIOUS EMISSIONS MEASUREMENT.....	45
4.6.2 TEST PROCEDURE .....	45
4.6.3 TEST SETUP .....	45
4.6.4 TEST RESULTS .....	46
4.7 RADIATED EMISSION MEASUREMENT .....	48
4.7.1 LIMITS OF RADIATED EMISSION MEASUREMENT .....	48
4.7.2 TEST PROCEDURES.....	48
4.7.3 DEVIATION FROM TEST STANDARD.....	48
4.7.4 TEST SETUP .....	49
4.7.5 TEST RESULTS .....	50
5 INFORMATION ON THE TESTING LABORATORIES .....	62
6 APPENDIX A – MODIFICATIONS RECORDERS FOR ENGINEERING CHANGES TO THE EUT BY THE LAB.....	63



A D T

## RELEASE CONTROL RECORD

ISSUE NO.	REASON FOR CHANGE	DATE ISSUED
RF140616C01-2	Original release	Jul. 28, 2014



A D T

## 1 CERTIFICATION

**PRODUCT:** Smartphone  
**MODEL NO.:** 0PCV220  
**BRAND:** HTC  
**APPLICANT:** HTC Corporation  
**TESTED:** Jun. 25, 2014 ~ Jul. 23, 2014  
**TEST SAMPLE:** Production Unit  
**TEST STANDARDS:** **FCC Part 27, Subpart C, L**  
**FCC Part 2**  
ANSI C63.4-2003

The above equipment (model: 0PCV220) has been tested by **Bureau Veritas Consumer Products Services (H.K.) Ltd., Taoyuan Branch**, and found compliance with the requirement of the above standards. The test record, data evaluation & Equipment Under Test (EUT) configurations represented herein are true and accurate accounts of the measurements of the sample's EMC characteristics under the conditions specified in this report.

**PREPARED BY** : Ivonne Wu , **DATE:** Jul. 28, 2014  
Ivonne Wu / Supervisor

**APPROVED BY** : Sam Chen , **DATE:** Jul. 28, 2014  
Sam Chen / Senior Project Engineer

## 2 SUMMARY OF TEST RESULTS

The EUT has been tested according to the following specifications:

WCDMA			
STANDARD SECTION	TEST TYPE	RESULT	REMARK
2.1046 27.50(d)(4)	Equivalent Isotropically Radiated Power	PASS	Meet the requirement of limit.
2.1055 27.54	Frequency Stability	PASS	Meet the requirement of limit.
2.1049 27.53(h)	Occupied Bandwidth	PASS	Meet the requirement of limit.
27.50(d)(5)	Peak to Average Ratio	PASS	Meet the requirement of limit.
27.53(h)	Band Edge Measurements	PASS	Meet the requirement of limit.
2.1051 27.53(h)	Conducted Spurious Emissions	PASS	Meet the requirement of limit.
2.1053 27.53(h)	Radiated Spurious Emissions	PASS	Meet the requirement of limit. Minimum passing margin is -27.64dB at 36.48MHz.

LTE Band 17			
STANDARD SECTION	TEST TYPE AND LIMIT	RESULT	REMARK
2.1046 27.50(C)(10)	Maximum Peak Output Power	PASS	Meet the requirement of limit.
2.1055 27.54	Frequency Stability	PASS	Meet the requirement of limit.
2.1049 27.53(g)	Occupied Bandwidth	PASS	Meet the requirement of limit.
27.50(d)(5)	Peak to Average Ratio	PASS	Meet the requirement of limit.
27.53(g)	Band Edge Measurements	PASS	Meet the requirement of limit.
2.1051 27.53(g)	Conducted Spurious Emissions	PASS	Meet the requirement of limit.
2.1053 27.53(g)	Radiated Spurious Emissions	PASS	Meet the requirement of limit. Minimum passing margin is -30.72dB at 36.21MHz.



LTE Band 4			
STANDARD SECTION	TEST TYPE AND LIMIT	RESULT	REMARK
2.1046 27.50(d)(4)	Maximum Peak Output Power	PASS	Meet the requirement of limit.
2.1055 27.54	Frequency Stability	PASS	Meet the requirement of limit.
2.1049 27.53(h)	Occupied Bandwidth	PASS	Meet the requirement of limit.
27.50(d)(5)	Peak to Average Ratio	PASS	Meet the requirement of limit.
27.53(h)	Band Edge Measurements	PASS	Meet the requirement of limit.
2.1051 27.53(h)	Conducted Spurious Emissions	PASS	Meet the requirement of limit.
2.1053 27.53(h)	Radiated Spurious Emissions	PASS	Meet the requirement of limit. Minimum passing margin is -25.76dB at 5171.10MHz.

## 2.1 MEASUREMENT UNCERTAINTY

Where relevant, the following measurement uncertainty levels have been estimated for tests performed on the EUT as specified in CISPR 16-4-2:

MEASUREMENT	FREQUENCY	UNCERTAINTY
Conducted emissions	150kHz~30MHz	2.44 dB
Radiated emissions	30MHz ~ 200MHz	2.93 dB
	200MHz ~1000MHz	2.95 dB
	1GHz ~ 18GHz	2.26 dB
	18GHz ~ 40GHz	1.94 dB

This uncertainty represents an expanded uncertainty expressed at approximately the 95% confidence level using a coverage factor of k=2.



## 2.2 TEST SITE AND INSTRUMENTS

DESCRIPTION & MANUFACTURER	MODEL NO.	SERIAL NO.	DATE OF CALIBRATION	DUE DATE OF CALIBRATION
Test Receiver ROHDE & SCHWARZ	ESCI	100744	Apr. 15, 2014	Apr. 14, 2015
Spectrum Analyzer ROHDE & SCHWARZ	FSU43	101261	Dec. 21, 2013	Dec. 20, 2014
BILOG Antenna SCHWARZBECK	VULB9168	9168-472	Feb. 27, 2014	Feb. 26, 2015
HORN Antenna SCHWARZBECK	BBHA 9120 D	9120D-969	Feb. 19, 2014	Feb. 18, 2015
HORN Antenna SCHWARZBECK	BBHA 9170	9170-480	Dec. 18, 2013	Dec. 17, 2014
Preamplifier EMCI	EMC 012645	980115	Dec. 26, 2013	Dec. 25, 2014
Preamplifier EMCI	EMC 184045	980116	Jan. 13, 2014	Jan. 12, 2015
Preamplifier EMCI	EMC 330H	980112	Dec. 27, 2013	Dec. 26, 2014
RF signal cable HUBER+SUHNNER	SUCOFLEX 104	309219/4 2950114	Oct. 18, 2013	Oct. 17, 2014
RF signal cable HUBER+SUHNNER	SUCOFLEX 104	250130/4	Oct. 18, 2013	Oct. 17, 2014
RF signal cable Worken	RG-213	NA	Nov. 07, 2013	Nov. 06, 2014
Software BV ADT	E3 6.120103	NA	NA	NA
Antenna Tower MF	MFA-440H	NA	NA	NA
Turn Table MF	MFT-201SS	NA	NA	NA
Antenna Tower & Turn Table Controller MF	MF-7802	NA	NA	NA
JFW 20dB attenuation	50HF-020-SMA	NA	NA	NA
Communications Tester-Wireless	E5515C	MY52102544	Sep. 05, 2012	Sep. 04, 2014
Radio Communication Analyzer	MT8820C	6201300640	Aug. 01, 2013	Jul. 31, 2014

- NOTE:**
1. The calibration interval of the above test instruments is 12 months and the calibrations are traceable to NML/ROC and NIST/USA.
  2. The test was performed in HwaYa Chamber 10.
  3. The horn antenna and HP preamplifier (model: 8449B) are used only for the measurement of emission frequency above 1GHz if tested.
  4. The FCC Site Registration No. is 690701.
  5. The IC Site Registration No. is IC 7450F-10.



### 3 GENERAL INFORMATION

#### 3.1 GENERAL DESCRIPTION OF EUT

<b>PRODUCT</b>	Smartphone	
<b>MODEL NO.</b>	0PCV220	
<b>POWER SUPPLY</b>	5Vdc (adapter or host equipment) 3.8Vdc (battery)	
<b>MODULATION TECHNOLOGY</b>	<b>WCDMA</b>	QPSK, BPSK
	<b>LTE Band 17</b>	QPSK, 16QAM
	<b>LTE Band 4</b>	QPSK, 16QAM
<b>FREQUENCY RANGE</b>	<b>WCDMA</b>	1712.4MHz ~1752.6MHz
	<b>LTE Band 17 Channel Bandwidth: 5MHz</b>	706.5MHz ~ 713.5MHz
	<b>LTE Band 17 Channel Bandwidth: 10MHz</b>	709MHz ~ 711MHz
	<b>LTE Band 4 Channel Bandwidth: 5MHz</b>	1712.5MHz ~1752.5MHz
	<b>LTE Band 4 Channel Bandwidth: 10MHz</b>	1715.0MHz ~1750.0MHz
	<b>LTE Band 4 Channel Bandwidth: 20MHz</b>	1720.0MHz ~1745.0MHz
<b>EMISSION DESIGNATOR</b>	<b>WCDMA</b>	4M16F9W
	<b>LTE Band 17 Channel Bandwidth: 5MHz</b>	4M50G7D
	<b>LTE Band 17 Channel Bandwidth: 10MHz</b>	8M92G7D
	<b>LTE Band 4 Channel Bandwidth: 5MHz</b>	4M49G7D
	<b>LTE Band 4 Channel Bandwidth: 10MHz</b>	8M92G7D
	<b>LTE Band 4 Channel Bandwidth: 20MHz</b>	17M8G7D
<b>MAX. ERP POWER</b>	<b>LTE Band 17 Channel Bandwidth: 5MHz</b>	52.00mW
	<b>LTE Band 17 Channel Bandwidth: 10MHz</b>	49.89mW
<b>MAX. EIRP POWER</b>	<b>WCDMA</b>	171.79mW
	<b>LTE Band 4 Channel Bandwidth: 5MHz</b>	157.76mW
	<b>LTE Band 4 Channel Bandwidth: 10MHz</b>	192.26mW
	<b>LTE Band 4 Channel Bandwidth: 20MHz</b>	179.06mW





A D T

<b>ANTENNA TYPE</b>	Fixed Internal Antenna
<b>DATA CABLE</b>	Refer to Note as below
<b>I/O PORTS</b>	Refer to users' manual
<b>ACCESSORY DEVICES</b>	Refer to Note as below

**NOTE:**

1. The EUT's accessories list refers to Ext. Pho.
2. The above EUT information is declared by manufacturer and for more detailed features description, please refer to the manufacturer's specifications or User's Manual.

### 3.2 CONFIGURATION OF SYSTEM UNDER TEST FOR RADIATION EMISSION TEST

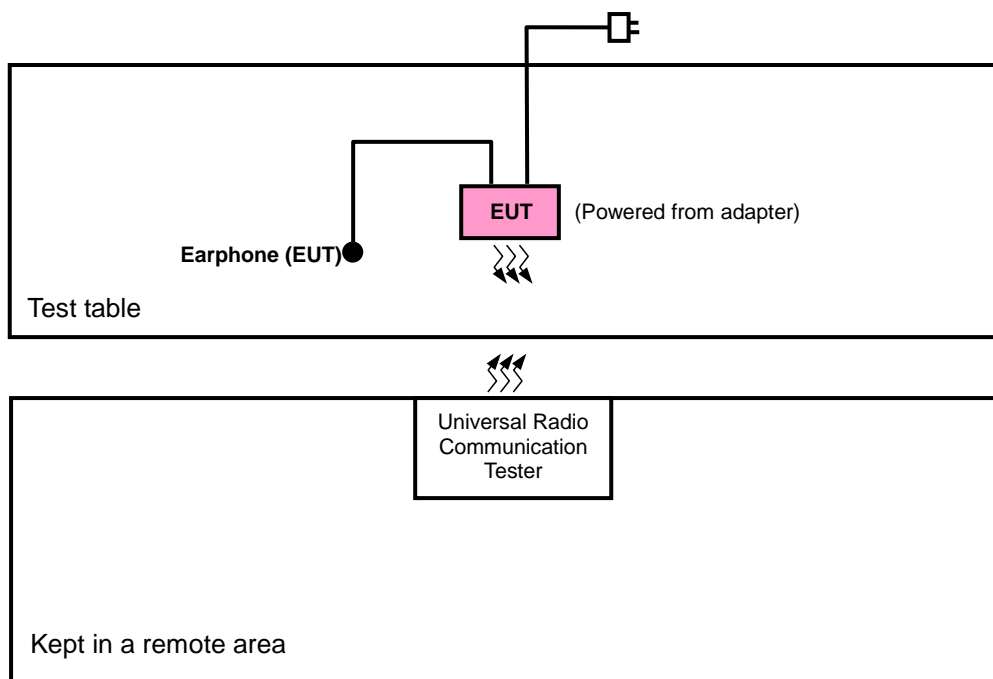

### FOR E.R.P. / E.I.R.P. TEST

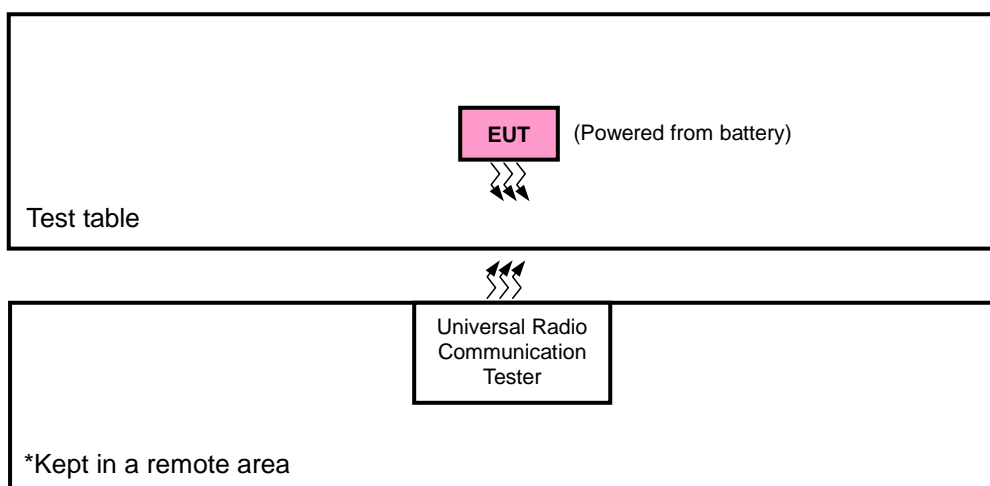

### 3.3 DESCRIPTION OF SUPPORT UNITS

The EUT has been tested as an independent unit together with other necessary accessories or support units.



### 3.4 DESCRIPTION OF TEST MODES

Pre-Scan has been conducted to determine the worst-case mode from all possible combinations between available modulations, data rates, XYZ axis and antenna ports. The worst case was found when positioned on X-plane for ERP, Y-plane for EIRP, and Z-axis for radiated emission. Following channel(s) was (were) selected for the final test as listed below:

EUT CONFIGURE MODE	DESCRIPTION
A	EUT with battery 1
B	EUT with battery 2

#### WCDMA

EUT CONFIGURE MODE	TEST ITEM	AVAILABLE CHANNEL	TESTED CHANNEL	MODE
A, B	EIRP	1312 to 1513	1312, 1413, 1513	WCDMA
A	FREQUENCY STABILITY	1312 to 1513	1413	WCDMA
A	OCCUPIED BANDWIDTH	1312 to 1513	1312, 1413, 1513	WCDMA
A	BAND EDGE	1312 to 1513	1312, 1513	WCDMA
A	CONDCUDED EMISSION	1312 to 1513	1413	WCDMA
A, B	RADIATED EMISSION	1312 to 1513	1413	WCDMA



**LTE Band 17**

EUT CONFIGURE MODE	TEST ITEM	AVAILABLE CHANNEL	TESTED CHANNEL	CHANNEL BANDWIDTH	MODULATION	MODE
A	ERP	23755 to 23825	23755, 23790, 23825	5MHz	QPSK, 16QAM	1 RB / 24 RB Offset
		23780 to 23800	23780, 23790, 23800	10MHz	QPSK, 16QAM	1 RB / 49 RB Offset
B	ERP	23780 to 23800	23780, 23790, 23800	10MHz	QPSK, 16QAM	1 RB / 49 RB Offset
A	FREQUENCY STABILITY	23755 to 23825	23790	5MHz	QPSK	1 RB / 24 RB Offset
		23780 to 23800	23790	10MHz	QPSK	1 RB / 49 RB Offset
A	OCCUPIED BANDWIDTH	23755 to 23825	23755, 23790, 23825	5MHz	QPSK, 16QAM	25 RB / 0 RB Offset
		23780 to 23800	23780, 23790, 23800	10MHz	QPSK, 16QAM	50 RB / 0 RB Offset
A	PEAK TO AVERAGE RATIO	23755 to 23825	23755, 23790, 23825	5MHz	QPSK, 16QAM	1 RB / 24 RB Offset
		23780 to 23800	23780, 23790, 23800	10MHz	QPSK, 16QAM	1 RB / 49 RB Offset
A	BAND EDGE	23755 to 23825	23755	5MHz	QPSK	1 RB / 0 RB Offset
			23825	5MHz	QPSK	25 RB / 0 RB Offset
		23780 to 23800	23780	10MHz	QPSK	1 RB / 0 RB Offset
			23800	10MHz	QPSK	50 RB / 0 RB Offset
			23780	10MHz	QPSK	1 RB / 49 RB Offset
			23800	10MHz	QPSK	50 RB / 0 RB Offset
A	CONDUCTED EMISSION	23755 to 23825	23790	5MHz	QPSK	1 RB / 24 RB Offset
		23780 to 23800	23790	10MHz	QPSK	1 RB / 49 RB Offset
A, B	RADIATED EMISSION	23780 to 23800	23790	10MHz	QPSK	1 RB / 49 RB Offset

**Note:** This device was tested under all bandwidths, RB configurations and modulations. The worst case was found in QPSK modulation.



**LTE Band 4**

EUT CONFIGURE MODE	TEST ITEM	AVAILABLE CHANNEL	TESTED CHANNEL	CHANNEL BANDWIDTH	MODULATION	MODE		
A	EIRP	19975 to 20375	19975, 20175, 20375	5MHz	QPSK, 16QAM	1 RB / 0 RB Offset		
		20000 to 20350	20000, 20175, 20350	10MHz	QPSK, 16QAM	1 RB / 0 RB Offset		
		20050 to 20300	20050, 20175, 20300	20MHz	QPSK, 16QAM	1 RB / 0 RB Offset		
B	EIRP	20050 to 20300	20050, 20175, 20300	20MHz	QPSK, 16QAM	1 RB / 0 RB Offset		
A	FREQUENCY STABILITY	19975 to 20375	20175	5MHz	QPSK	1 RB / 0 RB Offset		
		20000 to 20350	20175	10MHz	QPSK	1 RB / 0 RB Offset		
		20050 to 20300	20175	20MHz	QPSK	1 RB / 0 RB Offset		
A	OCCUPIED BANDWIDTH	19975 to 20375	19975, 20175, 20375	5MHz	QPSK, 16QAM	25 RB / 0 RB Offset		
		20000 to 20350	20000, 20175, 20350	10MHz	QPSK, 16QAM	50 RB / 0 RB Offset		
		20050 to 20300	20050, 20175, 20300	20MHz	QPSK, 16QAM	100 RB / 0 RB Offset		
A	PEAK TO AVERAGE RATIO	19975 to 20375	19975, 20175, 20375	5MHz	QPSK, 16QAM	1 RB / 0 RB Offset		
		20000 to 20350	20000, 20175, 20350	10MHz	QPSK, 16QAM	1 RB / 0 RB Offset		
		20050 to 20300	20050, 20175, 20300	20MHz	QPSK, 16QAM	1 RB / 0 RB Offset		
A	BAND EDGE	19975 to 20375	19975	5MHz	QPSK	1 RB / 0 RB Offset 25 RB / 0 RB Offset		
			20375	5MHz	QPSK	1 RB / 24 RB Offset 25 RB / 0 RB Offset		
		20000 to 20350	20000	10MHz	QPSK	1 RB / 0 RB Offset 50 RB / 0 RB Offset		
			20350	10MHz	QPSK	1 RB / 49 RB Offset 50 RB / 0 RB Offset		
		20050 to 20300	20050	20MHz	QPSK	1 RB / 0 RB Offset 100 RB / 0 RB Offset		
			20300	20MHz	QPSK	1 RB / 99 RB Offset 100 RB / 0 RB Offset		
		A	CONDCUDED EMISSION	19975 to 20375	20175	5MHz	QPSK	1 RB / 0 RB Offset
				20000 to 20350	20175	10MHz	QPSK	1 RB / 0 RB Offset
20050 to 20300	20175			20MHz	QPSK	1 RB / 0 RB Offset		
A, B	RADIATED EMISSION	20050 to 20300	20175	20MHz	QPSK	1 RB / 50 RB Offset		

**Note:** This device was tested under all bandwidths, RB configurations and modulations. The worst case was found in QPSK modulation.

**TEST CONDITION:**

TEST ITEM	ENVIRONMENTAL CONDITIONS	INPUT POWER	TESTED BY
ERP/EIRP	26deg. C, 58%RH	3.8Vdc	Anson Lin
FREQUENCY STABILITY	26deg. C, 58%RH	3.8Vdc	Dylan Yang
OCCUPIED BANDWIDTH	26deg. C, 58%RH	3.8Vdc	Dylan Yang
PEAK TO AVERAGE RATIO	26deg. C, 58%RH	3.8Vdc	Dylan Yang
BAND EDGE	26deg. C, 58%RH	3.8Vdc	Dylan Yang
CONDCUDED EMISSION	26deg. C, 58%RH	3.8Vdc	Dylan Yang
RADIATED EMISSION	25deg. C, 65%RH	120Vac, 60Hz	Anson Lin



A D T

### **3.5 GENERAL DESCRIPTION OF APPLIED STANDARDS**

The EUT is a RF product. According to the specifications of the manufacturer, it must comply with the requirements of the following standards:

**FCC 47 CFR Part 2**

**FCC 47 CFR Part 27**

**ANSI C63.4-2003**

**ANSI/TIA/EIA-603-C 2004**

**NOTE:** All test items have been performed and recorded as per the above standards.

## 4 TEST TYPES AND RESULTS

### 4.1 OUTPUT POWER MEASUREMENT

#### 4.1.1 LIMITS OF OUTPUT POWER MEASUREMENT

Fixed, mobile, and portable (hand-held) stations operating in the 1710–1755 MHz band are limited to 1 watt EIRP.

Portable stations (hand-held devices) operating in the 704-716 MHz band are limited to 3 watts ERP

#### 4.1.2 TEST PROCEDURES

##### EIRP MEASUREMENT:

- a. All measurements were done at low, middle and high operational frequency range. RBW and VBW is 5MHz for WCDMA and 10MHz for LTE mode.
- b. Substitution method is used for E.I.R.P measurement. In the semi-anechoic chamber, EUT placed on the 0.8m height of Turn Table, rotated the table around 360 degrees to search the maximum radiation power and receiver antenna shall be rotated vertical and horizontal polarization and moved height from 1m to 4m to find the maximum polar radiated power. The “Read Value” is the spectrum reading the maximum power value.
- c. The substitution horn antenna is substituted for EUT at the same position and signals generator export the CW signal to the substitution antenna via a tx cable. Rotated the Turn Table and moved receiving antenna to find the maximum radiation power. Adjust output power level of S.G to get a Value of spectrum reading equal to “Read Value” of step b. Record the power level of S.G
- d.  $EIRP = \text{Output power level of S.G} - \text{TX cable loss} + \text{Antenna gain of substitution horn}.$

##### CONDUCTED POWER MEASUREMENT:

- a. The EUT was set up for the maximum power with LTE link data modulation and link up with simulator.
- b. Set the EUT to transmit under low, middle and high channel and record the power level shown on simulator.

### 4.1.3 TEST SETUP

#### EIRP / ERP MEASUREMENT:

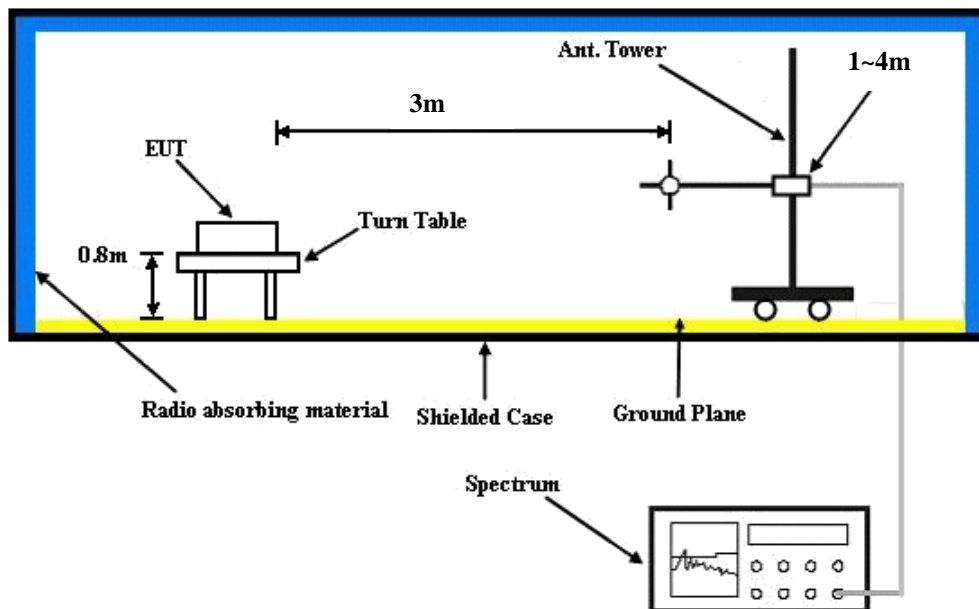

#### CONDUCTED POWER MEASUREMENT:

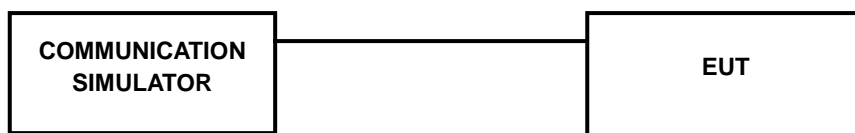





#### 4.1.4 TEST RESULTS

##### Average Conducted Output Power (dBm)

Band	WCDMA IV		
Channel	1312	1413	1513
Frequency (MHz)	1712.4	1732.6	1752.6
RMC 12.2K	<b>23.76</b>	23.68	23.73
HSDPA Subtest-1	22.89	22.81	22.86
HSDPA Subtest-2	22.82	22.74	22.79
HSDPA Subtest-3	22.35	22.27	22.32
HSDPA Subtest-4	22.33	22.25	22.30
HSUPA Subtest-1	22.59	22.51	22.56
HSUPA Subtest-2	21.31	21.23	21.28
HSUPA Subtest-3	21.04	20.96	21.01
HSUPA Subtest-4	21.20	21.12	21.17
HSUPA Subtest-5	22.73	22.65	22.70

Band / BW	RB Size	RB Offset	QPSK			3GPP MPR (dB)	16QAM			3GPP MPR (dB)
			Low CH 23755	Mid CH 23790	High CH 23825		Low CH 23755	Mid CH 23790	High CH 23825	
			706.5 MHz	710.0 MHz	713.5 MHz		706.5 MHz	710.0 MHz	713.5 MHz	
17 / 5M	1	0	23.26	23.24	23.30	0	22.25	22.23	22.29	1
	1	12	23.29	23.27	23.32	0	22.28	22.26	22.31	1
	1	24	23.33	23.31	23.39	0	22.32	22.30	22.38	1
	12	0	22.33	22.26	22.36	1	21.32	21.25	21.35	2
	12	6	22.32	22.31	22.36	1	21.31	21.3	21.35	2
	12	13	22.29	22.26	22.32	1	21.28	21.25	21.31	2
	25	0	22.37	22.35	22.41	1	21.36	21.34	21.40	2

Band / BW	RB Size	RB Offset	QPSK			3GPP MPR (dB)	16QAM			3GPP MPR (dB)
			Low CH 23780	Mid CH 23790	High CH 23800		Low CH 23780	Mid CH 23790	High CH 23800	
			709.0 MHz	710.0 MHz	711.0 MHz		709.0 MHz	710.0 MHz	711.0 MHz	
17 / 10M	1	0	23.37	23.35	23.41	0	22.36	22.34	22.40	1
	1	24	23.40	23.38	23.43	0	22.39	22.37	22.42	1
	1	49	23.47	23.42	<b>23.48</b>	0	22.43	22.41	22.49	1
	25	0	22.44	22.37	22.47	1	21.43	21.36	21.46	2
	25	12	22.43	22.42	22.47	1	21.42	21.41	21.46	2
	25	25	22.40	22.37	22.43	1	21.39	21.36	21.42	2
	50	0	22.48	22.46	22.52	1	21.47	21.45	21.51	2



Band / BW	RB Size	RB Offset	QPSK			3GPP MPR (dB)	16QAM			3GPP MPR (dB)
			Low CH 19975	Mid CH 20175	High CH 20375		Low CH 19975	Mid CH 20175	High CH 20375	
			1712.5 MHz	1732.5 MHz	1752.5 MHz		1712.5 MHz	1732.5 MHz	1752.5 MHz	
4 / 5M	1	0	23.03	23.07	23.10	0	21.28	21.26	21.35	1
	1	12	23.06	23.05	23.07	0	21.29	21.24	21.31	1
	1	24	22.91	22.92	22.91	0	21.14	21.11	21.15	1
	12	0	22.11	22.13	22.13	1	20.34	20.32	20.37	2
	12	6	22.05	22.05	22.11	1	20.28	20.24	20.35	2
	12	13	21.99	22.02	22.00	1	20.22	20.21	20.24	2
	25	0	22.06	22.03	22.07	1	20.29	20.22	20.31	2

Band / BW	RB Size	RB Offset	QPSK			3GPP MPR (dB)	16QAM			3GPP MPR (dB)
			Low CH 20000	Mid CH 20175	High CH 20350		Low CH 20000	Mid CH 20175	High CH 20350	
			1715.0 MHz	1732.5 MHz	1750.0 MHz		1715.0 MHz	1732.5 MHz	1750.0 MHz	
4 / 10M	1	0	23.16	23.20	23.23	0	21.41	21.39	21.48	1
	1	24	23.19	23.18	23.20	0	21.42	21.37	21.44	1
	1	49	23.04	23.05	23.04	0	21.27	21.24	21.28	1
	25	0	22.24	22.26	22.26	1	20.47	20.45	20.50	2
	25	12	22.18	22.18	22.24	1	20.41	20.37	20.48	2
	25	25	22.12	22.15	22.13	1	20.35	20.34	20.37	2
	50	0	22.19	22.16	22.20	1	20.42	20.35	20.44	2

Band / BW	RB Size	RB Offset	QPSK			3GPP MPR (dB)	16QAM			3GPP MPR (dB)
			Low CH 20050	Mid CH 20175	High CH 20300		Low CH 20050	Mid CH 20175	High CH 20300	
			1720.0 MHz	1732.5 MHz	1745.0 MHz		1720.0 MHz	1732.5 MHz	1745.0 MHz	
4 / 20M	1	0	23.40	23.42	23.46	0	22.35	22.33	22.42	1
	1	50	23.40	23.39	23.41	0	22.36	22.31	22.38	1
	1	99	23.26	23.27	23.26	0	22.21	22.18	22.22	1
	50	0	22.46	22.48	22.48	1	21.41	21.39	21.44	2
	50	25	22.40	22.40	22.46	1	21.35	21.31	21.42	2
	50	50	22.34	22.37	22.35	1	21.29	21.28	21.31	2
	100	0	22.41	22.38	22.42	1	21.36	21.29	21.38	2



A D T

**MODE A**

**AVERAGE ERP (dBm)**

LTE Band 17							
Channel Bandwidth: 5MHz / QPSK							
Plane	Channel	Frequency (MHz)	LVL (dBm)	Correction Factor(dB)	ERP(dBm)	ERP(mW)	Polarization (H/V)
X	23755	706.5	-11.93	30.36	16.28	42.46	H
	23790	710.0	-11.34	30.17	16.68	46.56	
	23825	713.5	-10.86	30.17	17.16	52.00	
	23755	706.5	-22.08	32.03	7.80	6.03	V
	23790	710.0	-21.85	31.98	7.98	6.28	
	23825	713.5	-20.95	32.06	8.96	7.87	

LTE Band 17							
Channel Bandwidth: 5MHz / 16QAM							
Plane	Channel	Frequency (MHz)	LVL (dBm)	Correction Factor(dB)	ERP(dBm)	ERP(mW)	Polarization (H/V)
X	23755	706.5	-12.70	30.36	15.51	35.56	H
	23790	710.0	-12.23	30.17	15.79	37.93	
	23825	713.5	-11.97	30.17	16.05	40.27	
	23755	706.5	-23.87	32.03	6.01	3.99	V
	23790	710.0	-23.00	31.98	6.83	4.82	
	23825	713.5	-22.30	32.06	7.61	5.77	



A D T

LTE Band 17							
Channel Bandwidth: 10MHz / QPSK							
Plane	Channel	Frequency (MHz)	LVL (dBm)	Correction Factor(dB)	ERP(dBm)	ERP(mW)	Polarization (H/V)
X	23780	709.0	-11.04	30.17	16.98	49.89	H
	23790	710.0	-11.08	30.17	16.94	49.43	
	23800	711.0	-11.11	30.18	16.92	49.20	
	23780	709.0	-21.48	31.96	8.33	6.81	V
	23790	710.0	-21.34	31.98	8.49	7.06	
	23800	711.0	-21.21	32.03	8.67	7.36	

LTE Band 17							
Channel Bandwidth: 10MHz / 16QAM							
Plane	Channel	Frequency (MHz)	LVL (dBm)	Correction Factor(dB)	ERP(dBm)	ERP(mW)	Polarization (H/V)
X	23780	709.0	-12.01	30.17	16.01	39.90	H
	23790	710.0	-12.13	30.17	15.89	38.82	
	23800	711.0	-11.92	30.18	16.11	40.83	
	23780	709.0	-22.54	31.96	7.27	5.33	V
	23790	710.0	-22.65	31.98	7.18	5.22	
	23800	711.0	-22.22	32.03	7.66	5.83	



A D T

**AVERAGE EIRP (dBm)**

WCDMA							
Plane	Channel	Frequency (MHz)	LVL (dBm)	Correction Factor(dB)	EIRP(dBm)	EIRP(mW)	Polarization (H/V)
Y	1312	1712.4	-26.94	36.29	9.35	8.61	H
	1413	1732.6	-26.02	36.69	10.67	11.67	
	1513	1752.6	-26.15	36.98	10.83	12.10	
	1312	1712.4	-15.95	37.11	21.16	130.56	V
	1413	1732.6	-15.25	37.60	22.35	171.79	
	1513	1752.6	-15.53	37.65	22.12	162.89	

LTE Band 4							
Channel Bandwidth: 5MHz / QPSK							
Plane	Channel	Frequency (MHz)	LVL (dBm)	Correction Factor(dB)	EIRP(dBm)	EIRP(mW)	Polarization (H/V)
Y	19975	1712.5	-17.72	36.45	18.73	74.64	H
	20175	1732.5	-17.01	36.80	19.79	95.26	
	20375	1752.5	-17.25	36.94	19.69	93.18	
	19975	1712.5	-15.35	37.28	21.93	155.85	V
	20175	1732.5	-15.65	37.63	21.98	157.76	
	20375	1752.5	-15.72	37.64	21.92	155.60	

LTE Band 4							
Channel Bandwidth: 5MHz / 16QAM							
Plane	Channel	Frequency (MHz)	LVL (dBm)	Correction Factor(dB)	EIRP(dBm)	EIRP(mW)	Polarization (H/V)
Y	19975	1712.5	-17.75	36.45	18.70	74.13	H
	20175	1732.5	-17.97	36.80	18.83	76.37	
	20375	1752.5	-17.07	36.94	19.87	97.12	
	19975	1712.5	-16.51	37.28	20.77	119.32	V
	20175	1732.5	-16.55	37.63	21.08	128.23	
	20375	1752.5	-16.74	37.64	20.90	123.03	



A D T

LTE Band 4							
Channel Bandwidth: 10MHz / QPSK							
Plane	Channel	Frequency (MHz)	LVL (dBm)	Correction Factor(dB)	EIRP(dBm)	EIRP(mW)	Polarization (H/V)
Y	20000	1715.0	-16.41	36.64	20.23	105.44	H
	20175	1732.5	-16.68	36.80	20.12	102.68	
	20350	1750.0	-16.55	36.80	20.25	105.93	
	20000	1715.0	-15.44	37.44	22.00	158.45	V
	20175	1732.5	-14.79	37.63	22.84	192.26	
	20350	1750.0	-15.04	37.64	22.60	181.76	

LTE Band 4							
Channel Bandwidth: 10MHz / 16QAM							
Plane	Channel	Frequency (MHz)	LVL (dBm)	Correction Factor(dB)	EIRP(dBm)	EIRP(mW)	Polarization (H/V)
Y	20000	1715.0	-17.71	36.64	18.93	78.16	H
	20175	1732.5	-17.82	36.80	18.98	78.98	
	20350	1750.0	-17.72	36.80	19.08	80.91	
	20000	1715.0	-16.43	37.44	21.01	126.15	V
	20175	1732.5	-16.03	37.63	21.60	144.51	
	20350	1750.0	-16.12	37.64	21.52	141.74	



A D T

LTE Band 4							
Channel Bandwidth: 20MHz / QPSK							
Plane	Channel	Frequency (MHz)	LVL (dBm)	Correction Factor(dB)	EIRP(dBm)	EIRP(mW)	Polarization (H/V)
Y	20050	1720.0	-17.64	36.45	18.81	76.03	H
	20175	1732.5	-17.02	36.80	19.78	95.04	
	20300	1745.0	-17.68	36.94	19.26	84.39	
	20050	1720.0	-15.45	37.28	21.83	152.30	V
	20175	1732.5	-15.10	37.63	22.53	179.06	
	20300	1745.0	-15.77	37.64	21.87	153.82	

LTE Band 4							
Channel Bandwidth: 20MHz / 16QAM							
Plane	Channel	Frequency (MHz)	LVL (dBm)	Correction Factor(dB)	EIRP(dBm)	EIRP(mW)	Polarization (H/V)
Y	20050	1720.0	-17.37	36.45	19.08	80.91	H
	20175	1732.5	-17.84	36.80	18.96	78.69	
	20300	1745.0	-17.67	36.94	19.27	84.59	
	20050	1720.0	-16.21	37.28	21.07	127.85	V
	20175	1732.5	-15.99	37.63	21.64	145.88	
	20300	1745.0	-15.83	37.64	21.81	151.71	



**A D T**

**MODE B**

**AVERAGE ERP (dBm)**

LTE Band 17							
Channel Bandwidth: 10MHz / QPSK							
Plane	Channel	Frequency (MHz)	LVL (dBm)	Correction Factor(dB)	ERP(dBm)	ERP(mW)	Polarization (H/V)
X	23780	709.0	-11.18	30.17	16.84	48.31	H
	23790	710.0	-11.13	30.17	16.89	48.87	
	23800	711.0	-11.34	30.18	16.69	46.67	
	23780	709.0	-21.65	31.96	8.16	6.55	V
	23790	710.0	-21.56	31.98	8.27	6.71	
	23800	711.0	-21.28	32.03	8.60	7.24	

LTE Band 17							
Channel Bandwidth: 10MHz / 16QAM							
Plane	Channel	Frequency (MHz)	LVL (dBm)	Correction Factor(dB)	ERP(dBm)	ERP(mW)	Polarization (H/V)
X	23780	709.0	-12.24	30.17	15.78	37.84	H
	23790	710.0	-12.33	30.17	15.69	37.07	
	23800	711.0	-12.05	30.18	15.98	39.63	
	23780	709.0	-22.68	31.96	7.13	5.16	V
	23790	710.0	-22.77	31.98	7.06	5.08	
	23800	711.0	-22.26	32.03	7.62	5.78	





A D T

**AVERAGE EIRP (dBm)**

WCDMA							
Plane	Channel	Frequency (MHz)	LVL (dBm)	Correction Factor(dB)	EIRP(dBm)	EIRP(mW)	Polarization (H/V)
Y	1312	1712.4	-26.08	36.29	10.21	10.49	H
	1413	1732.6	-26.14	36.69	10.55	11.35	
	1513	1752.6	-26.22	36.98	10.76	11.91	
	1312	1712.4	-15.84	37.11	21.27	133.91	V
	1413	1732.6	-15.33	37.60	22.27	168.66	
	1513	1752.6	-15.75	37.65	21.90	154.85	

LTE Band 4							
Channel Bandwidth: 20MHz / QPSK							
Plane	Channel	Frequency (MHz)	LVL (dBm)	Correction Factor(dB)	EIRP(dBm)	EIRP(mW)	Polarization (H/V)
Y	20050	1720.0	-17.58	36.45	18.87	77.09	H
	20175	1732.5	-17.14	36.80	19.66	92.45	
	20300	1745.0	-17.55	36.94	19.39	86.96	
	20050	1720.0	-15.32	37.28	21.96	156.93	V
	20175	1732.5	-15.16	37.63	22.47	176.60	
	20300	1745.0	-15.89	37.64	21.75	149.62	

LTE Band 4							
Channel Bandwidth: 20MHz / 16QAM							
Plane	Channel	Frequency (MHz)	LVL (dBm)	Correction Factor(dB)	EIRP(dBm)	EIRP(mW)	Polarization (H/V)
Y	20050	1720.0	-17.64	36.45	18.81	76.03	H
	20175	1732.5	-17.92	36.80	18.88	77.25	
	20300	1745.0	-17.54	36.94	19.40	87.16	
	20050	1720.0	-16.20	37.28	21.08	128.14	V
	20175	1732.5	-15.83	37.63	21.80	151.36	
	20300	1745.0	-15.88	37.64	21.76	149.97	

## 4.2 FREQUENCY STABILITY MEASUREMENT

### 4.2.1 LIMITS OF FREQUENCY STABILITY MEASUREMENT

The frequency stability shall be sufficient to ensure that the fundamental emissions stay within the authorized bands of operation.

### 4.2.2 TEST PROCEDURE

- a. Device is placed at the oven room. The oven room could control the temperatures and humidity. Power warm up is at least 15 min and power applied should perform before recording frequency error.
- b. EUT is connected the external power supply to control the DC input power. The test voltage range is from minimum to maximum working voltage. Each step shall be record the frequency error rate.
- c. The temperature range step is 10 degrees in this test items. All temperature levels shall be hold the  $\pm 0.5^{\circ}\text{C}$  during the measurement testing. The each temperature step shall be at least 0.5 hours, consider the EUT could be test under the stability condition.

**NOTE:** The frequency error was recorded frequency error from the communication simulator.

### 4.2.3 TEST SETUP

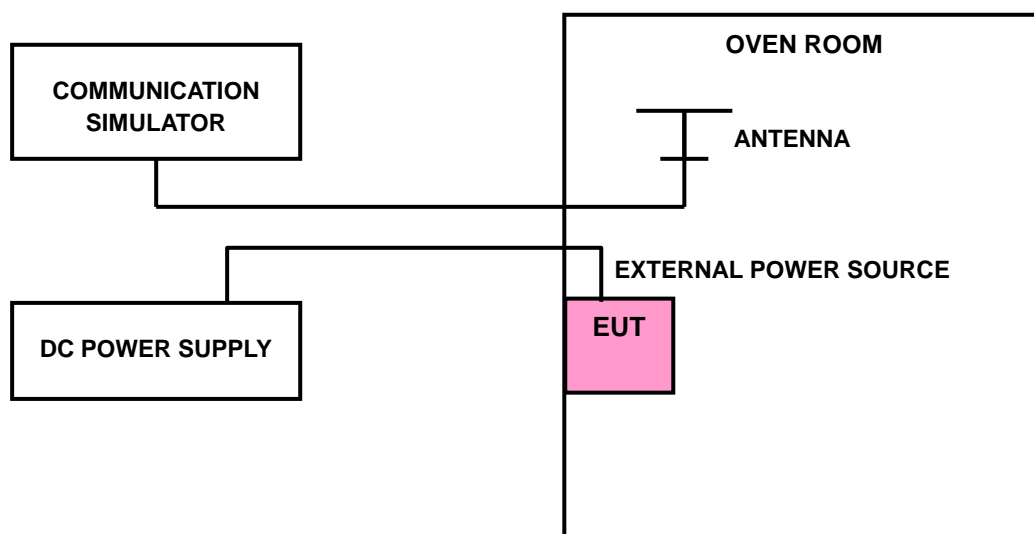



#### 4.2.4 TEST RESULTS

##### FREQUENCY ERROR vs. VOLTAGE

VOLTAGE (Volts)	FREQUENCY ERROR (ppm)						LIMIT (ppm)
	WCDMA	LTE BAND 17		LTE BAND 4			
		5MHz	10MHz	5MHz	10MHz	20MHz	
3.8	-0.002	0.003	0.002	-0.002	0.003	-0.001	2.5
3.6	-0.002	0.004	0.003	0.003	0.002	0.001	2.5
4.35	-0.003	0.002	0.005	0.002	0.004	-0.002	2.5

**NOTE:** The applicant defined the normal working voltage of the battery is from 3.6Vdc to 4.35Vdc.

##### FREQUENCY ERROR vs. TEMPERATURE

TEMP. (°C)	FREQUENCY ERROR (ppm)						LIMIT (ppm)
	WCDMA	LTE BAND 17		LTE BAND 4			
		5MHz	10MHz	5MHz	10MHz	5MHz	
-30	-0.003	-0.003	0.002	-0.003	-0.001	0.002	2.5
-20	-0.002	0.002	0.002	0.002	0.003	0.002	2.5
-10	-0.002	-0.002	0.005	-0.001	0.002	0.002	2.5
0	-0.004	-0.002	0.004	0.001	0.001	-0.003	2.5
10	-0.004	-0.003	0.003	0.002	-0.001	-0.004	2.5
20	-0.003	-0.004	0.003	0.001	-0.002	-0.002	2.5
30	-0.002	-0.002	0.002	0.002	0.001	-0.004	2.5
40	-0.003	-0.003	0.002	-0.002	0.002	-0.002	2.5
50	-0.002	0.003	-0.002	0.001	0.001	-0.002	2.5
60	-0.002	-0.002	-0.006	0.001	0.003	0.003	2.5

### 4.3 OCCUPIED BANDWIDTH MEASUREMENT

#### 4.3.1 LIMITS OF OCCUPIED BANDWIDTH MEASUREMENT

The width of a frequency band such that, below the lower and above the upper frequency limits, the mean powers emitted are each equal to a specified percentage 0.5 %of the total mean power of a given emission.

#### 4.3.2 TEST SETUP

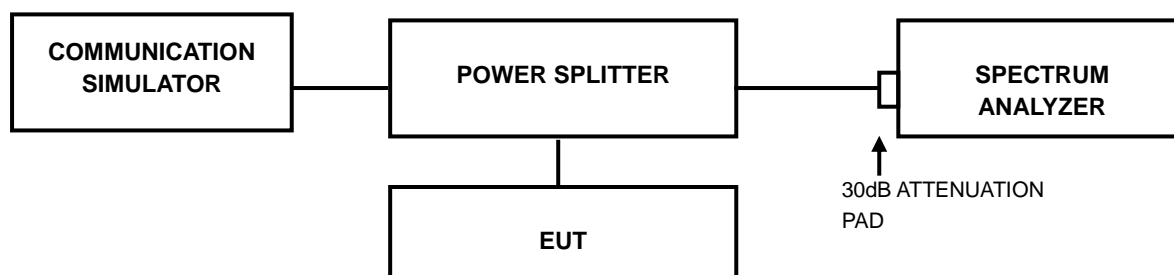

#### 4.3.3 TEST PROCEDURES

- a. The conducted occupied bandwidth used the power splitter via EUT RF power connector between simulation base station and spectrum analyzer.
- b. Use OBW measurement function of Spectrum analyzer to measure 99 % occupied bandwidth.



A D T

### 4.3.4 TEST RESULTS

WCDMA		
CHANNEL	FREQUENCY (MHz)	99% OCCUPIED BANDWIDTH (MHz)
1312	1712.4	4.1609
1413	1732.6	4.1642
1513	1752.6	4.1589

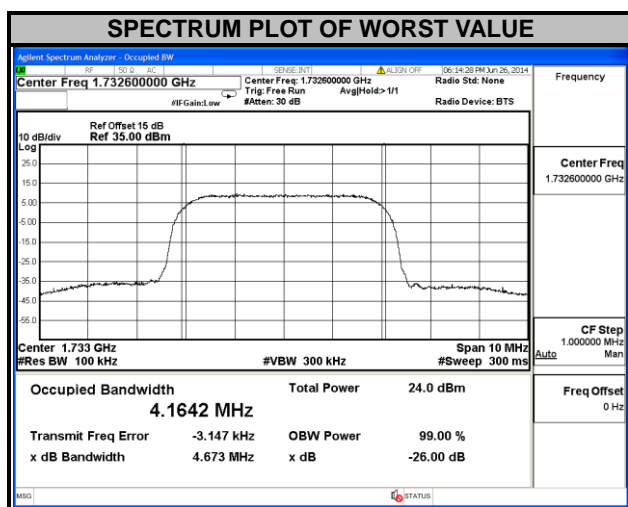



A D T

LTE BAND 17							
CHANNEL BANDWIDTH: 5MHz				CHANNEL BANDWIDTH: 10MHz			
CHANNEL	FREQUENCY (MHz)	99% OCCUPIED BANDWIDTH (MHz)		CHANNEL	FREQUENCY (MHz)	99% OCCUPIED BANDWIDTH (MHz)	
		QPSK	16QAM			QPSK	16QAM
23755	706.5	4.5000	4.4958	23780	709.0	8.9194	8.9220
23790	710.0	4.4906	4.4932	23790	710.0	8.9200	8.9130
23825	713.5	4.5006	4.4946	23800	711.0	8.9239	8.9160

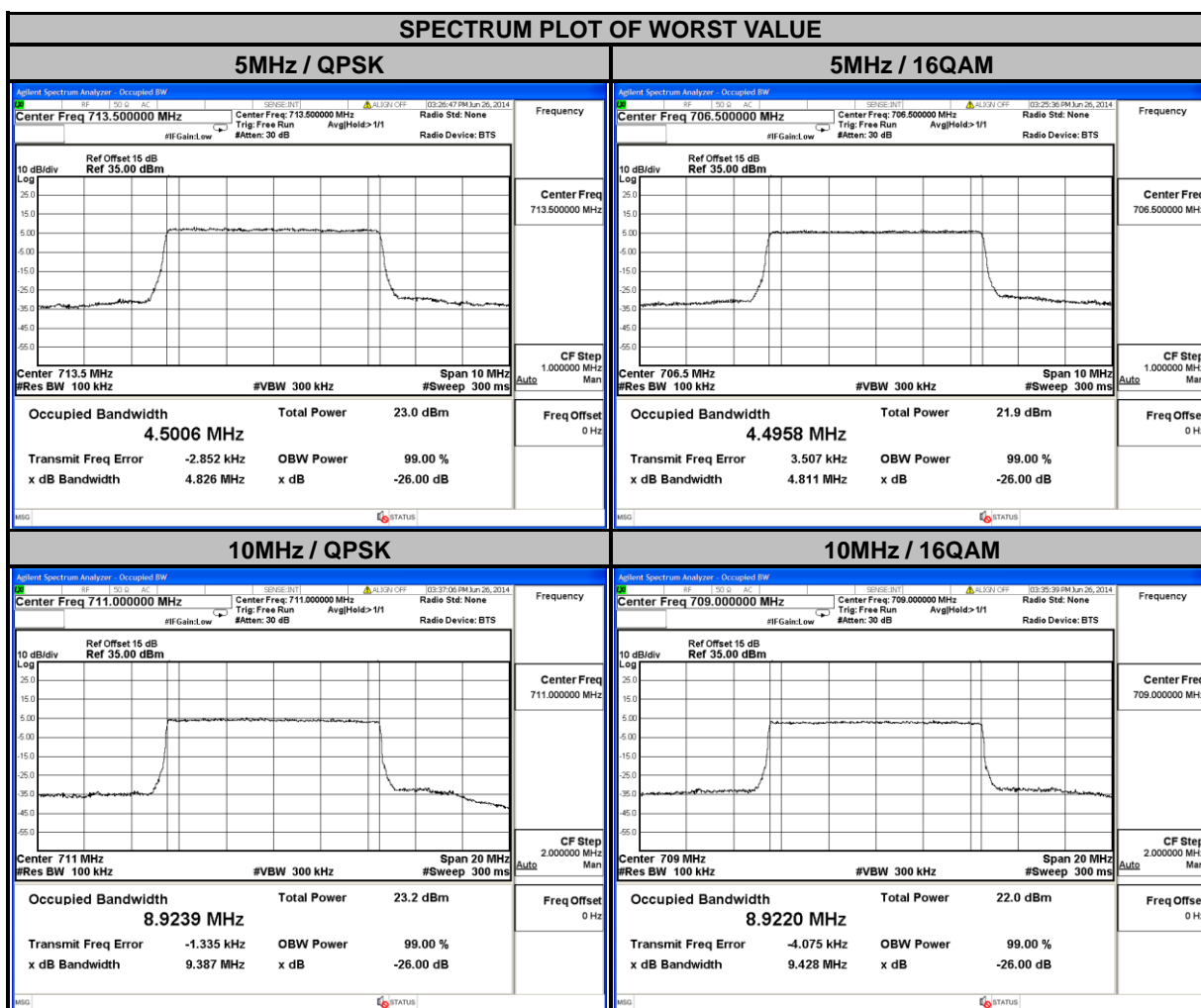



A D T

LTE BAND 4							
CHANNEL BANDWIDTH: 5MHz				CHANNEL BANDWIDTH: 10MHz			
CHANNEL	FREQUENCY (MHz)	99% OCCUPIED BANDWIDTH (MHz)		CHANNEL	FREQUENCY (MHz)	99% OCCUPIED BANDWIDTH (MHz)	
		QPSK	16QAM			QPSK	16QAM
19975	1712.5	4.4912	4.4853	20000	1715.0	8.9079	8.9103
20175	1732.5	4.4911	4.4898	20175	1732.5	8.9169	8.9151
20375	1752.5	4.4939	4.4866	20350	1750.0	8.9087	8.9110

**SPECTRUM PLOT OF WORST VALUE**

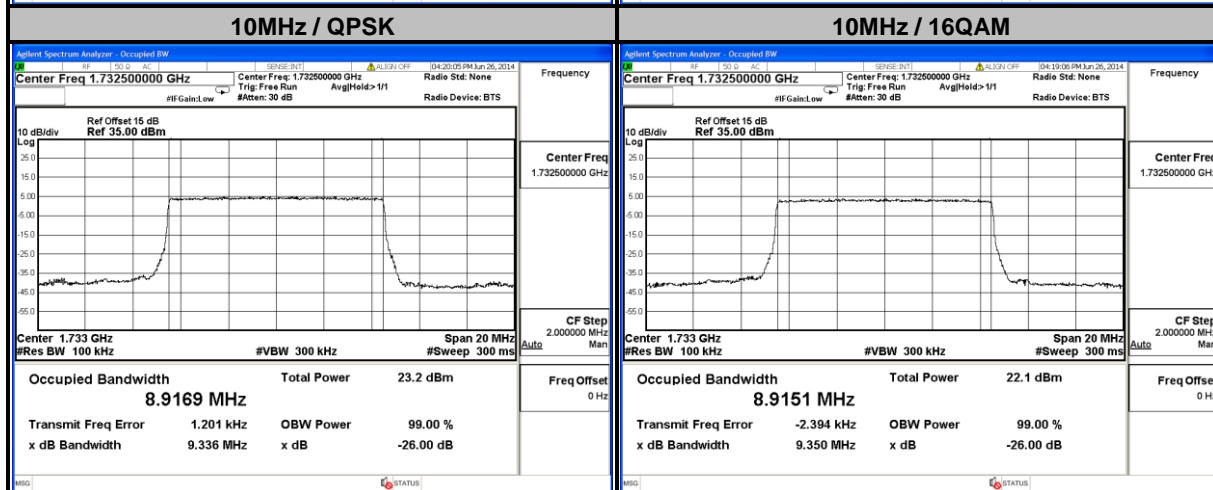
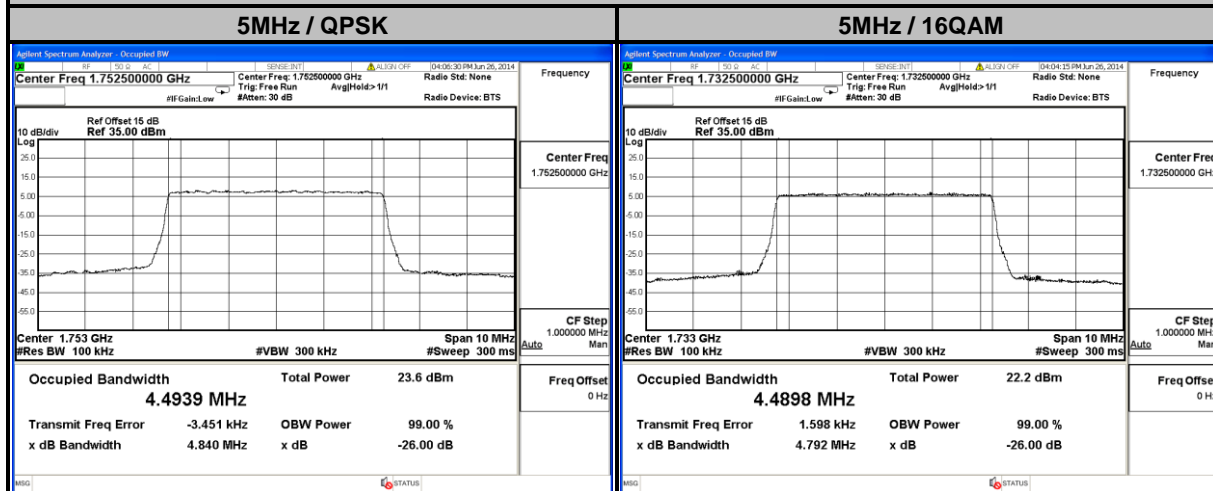



A D T

LTE BAND 4			
CHANNEL BANDWIDTH: 20MHz			
CHANNEL	FREQUENCY (MHz)	99% OCCUPIED BANDWIDTH (MHz)	
		QPSK	16QAM
20050	1720.0	17.792	17.785
20175	1732.5	17.821	17.819
20300	1745.0	17.783	17.786

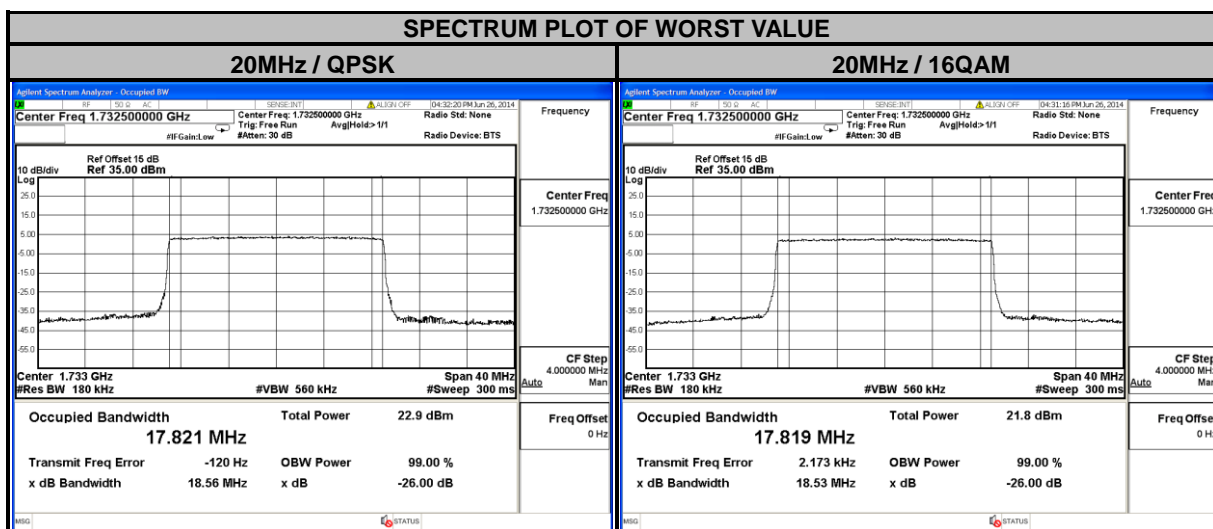



## 4.4 PEAK TO AVERAGE RATIO

### 4.4.1 LIMITS OF PEAK TO AVERAGE RATIO MEASUREMENT

In measuring transmissions in this band using an average power technique, the peak to-average ratio (PAR) of the transmission may not exceed 13 dB.

### 4.4.2 TEST SETUP

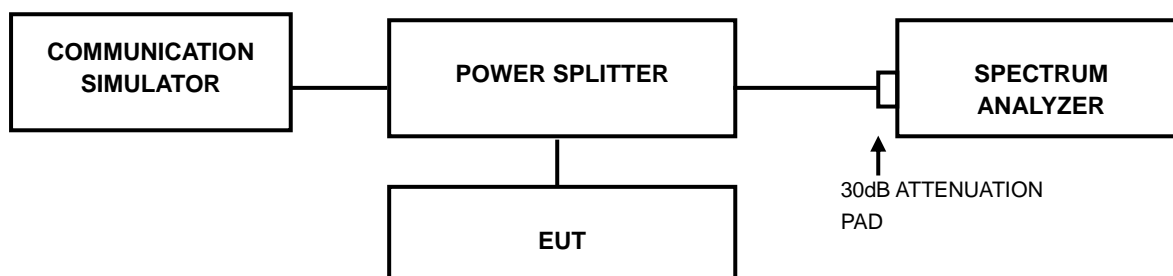

### 4.4.3 TEST PROCEDURES

1. Set resolution/measurement bandwidth  $\geq$  signal's occupied bandwidth;
2. Set the number of counts to a value that stabilizes the measured CCDF curve;
3. Record the maximum PAPR level associated with a probability of 0.1%.



### 4.4.4 TEST RESULTS

WCDMA		
CHANNEL	FREQUENCY (MHz)	PEAK TO AVERAGE RATIO (dB)
1312	1712.4	3.33
1413	1732.6	3.25
1513	1752.6	3.41

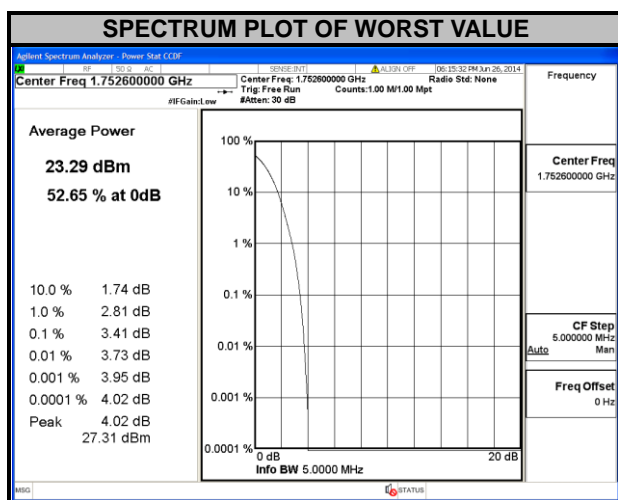



A D T

LTE BAND 17							
CHANNEL BANDWIDTH: 5MHz				CHANNEL BANDWIDTH: 10MHz			
CHANNEL	FREQUENCY (MHz)	PEAK TO AVERAGE RATIO (dB)		CHANNEL	FREQUENCY (MHz)	PEAK TO AVERAGE RATIO (dB)	
		QPSK	16QAM			QPSK	16QAM
23755	706.5	4.62	5.78	23780	709.0	4.68	5.94
23790	710.0	4.73	5.85	23790	710.0	4.73	5.93
23825	713.5	4.54	5.63	23800	711.0	4.81	6.05

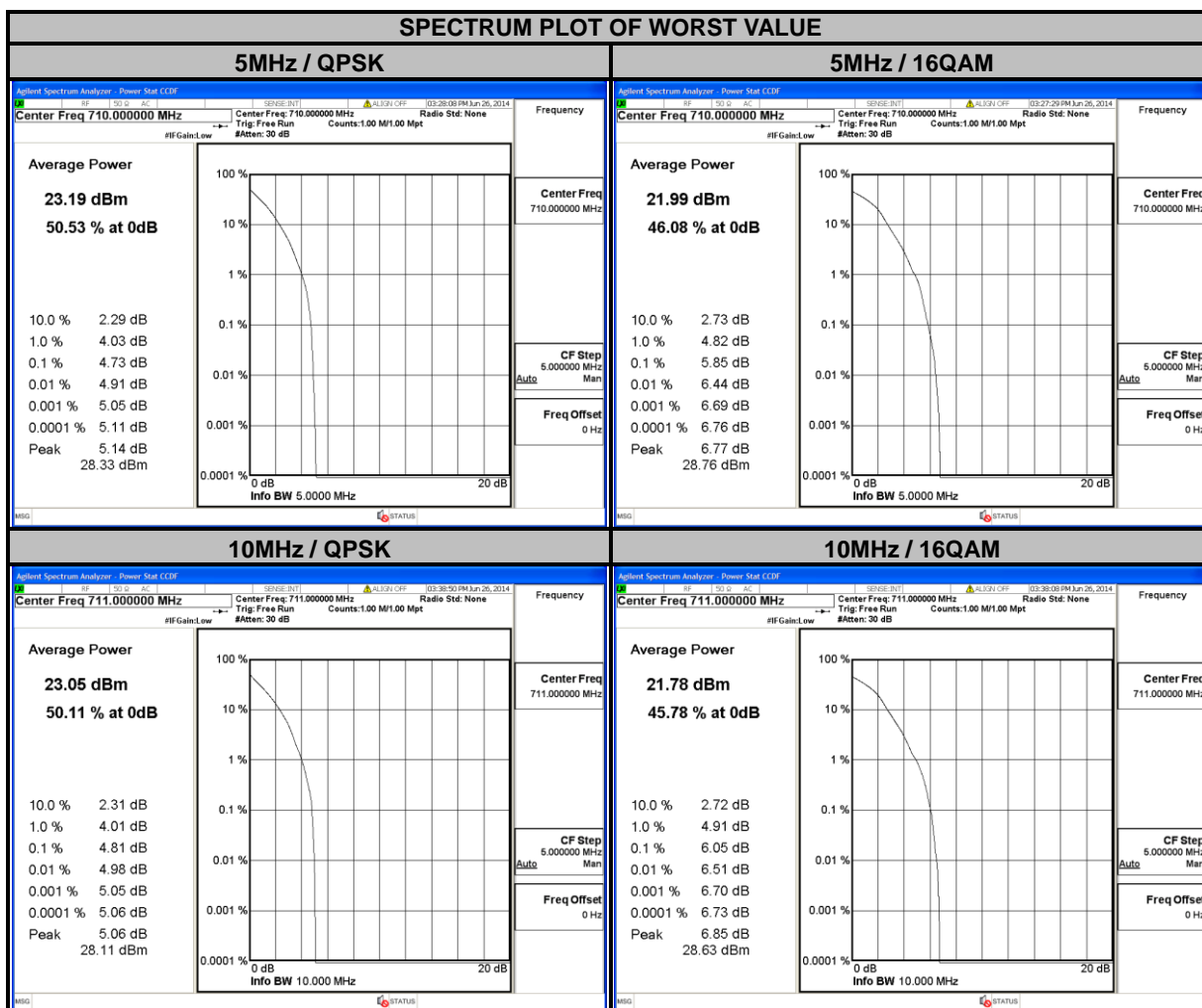



A D T

LTE BAND 4							
CHANNEL BANDWIDTH: 5MHz				CHANNEL BANDWIDTH: 10MHz			
CHANNEL	FREQUENCY (MHz)	PEAK TO AVERAGE RATIO (dB)		CHANNEL	FREQUENCY (MHz)	PEAK TO AVERAGE RATIO (dB)	
		QPSK	16QAM			QPSK	16QAM
19975	1712.5	5.04	6.29	20000	1715.0	5.00	6.29
20175	1732.5	5.23	6.48	20175	1732.5	5.18	6.49
20375	1752.5	4.76	6.00	20350	1750.0	5.24	6.54

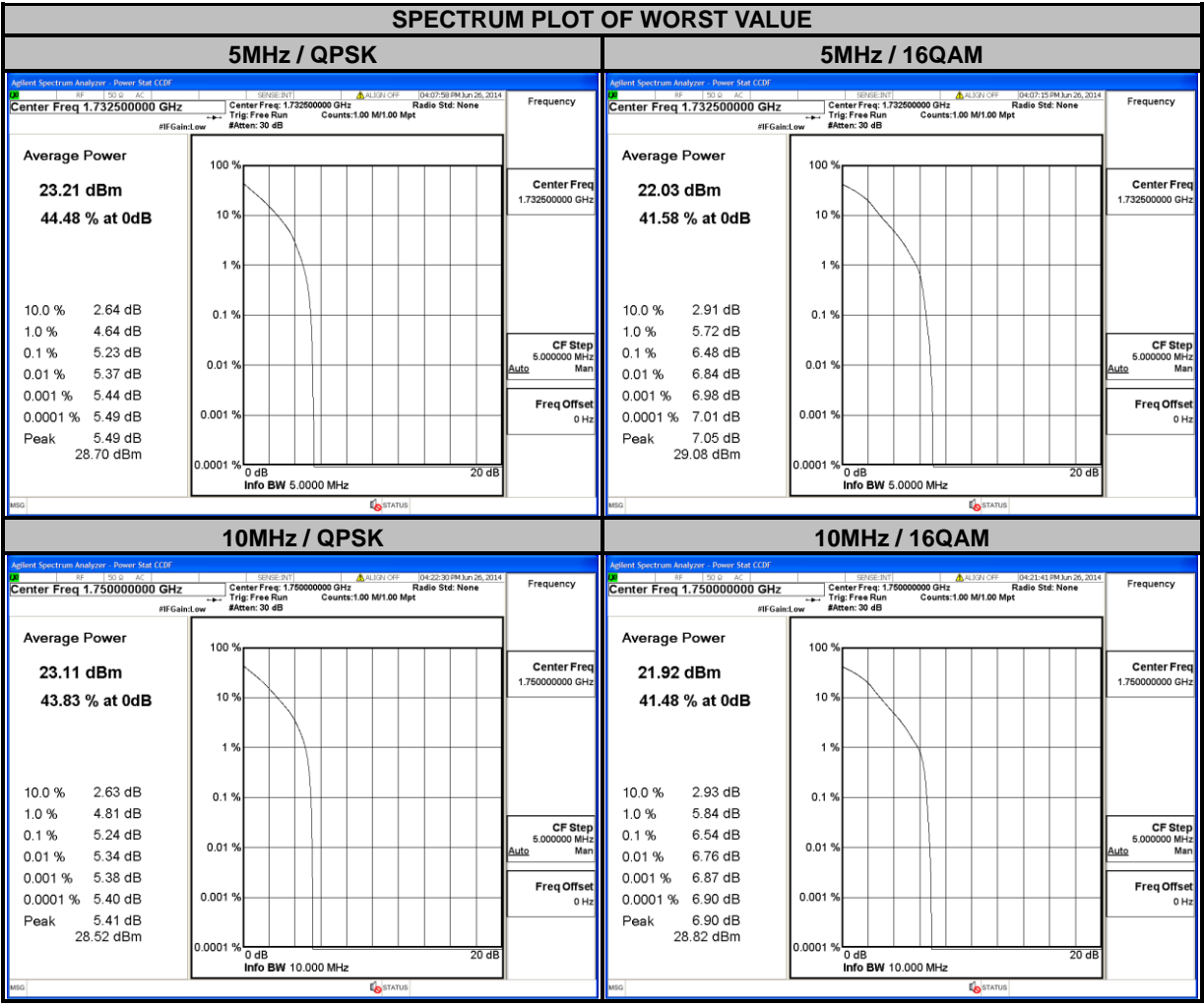



A D T

LTE BAND 4			
CHANNEL BANDWIDTH: 20MHz			
CHANNEL	FREQUENCY (MHz)	PEAK TO AVERAGE RATIO (dB)	
		QPSK	16QAM
20050	1720.0	5.04	6.33
20175	1732.5	5.05	6.34
20300	1745.0	5.45	6.69

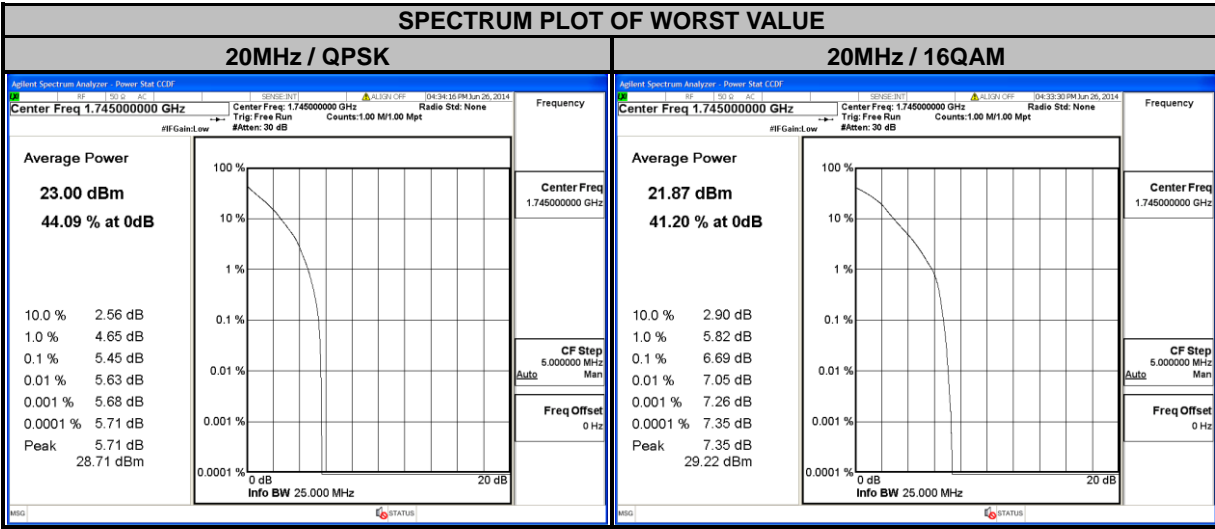

## 4.5 BAND EDGE MEASUREMENT

### 4.5.1 LIMITS OF BAND EDGE MEASUREMENT

For operations in the 704-716 MHz band, the power of any emission outside a licensee's frequency band(s) of operation shall be attenuated below the transmitter power (P) within the licensed band(s) of operation, measured in watts, by at least  $43 + 10 \log(P)$  dB. Compliance with this provision is based on the use of measurement instrumentation employing a resolution bandwidth of 100 kilohertz or greater. However, in the 100 kilohertz bands immediately outside and adjacent to a licensee's frequency block, a resolution bandwidth of at least 30 kHz may be employed.

For operations in the 1710–1755 MHz bands, the power of any emission outside a licensee's frequency block shall be attenuated below the transmitter power (P) by at least  $43 + 10 \log_{10}(P)$  dB.

### 4.5.2 TEST SETUP

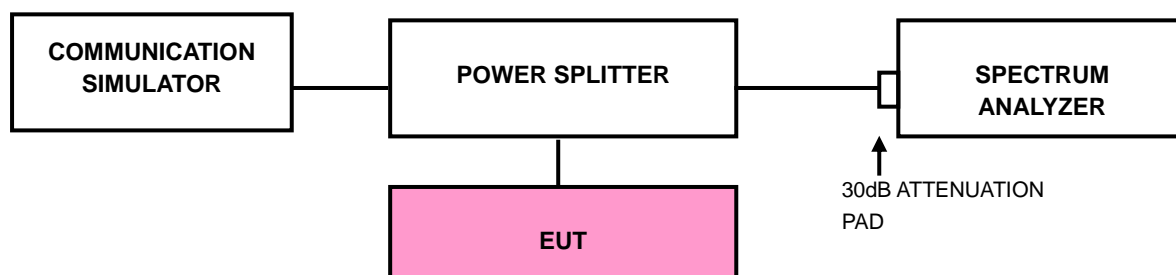

#### 4.5.3 TEST PROCEDURES

- a. The EUT was set up for the maximum peak power with LTE link data modulation. The power was measured with R&S Spectrum Analyzer. All measurements were done at 2 channels (low and high operational frequency range.).
- b. The band edge measurement used the power splitter via EUT RF power connector between simulation base station and spectrum analyzer.
- c. The center frequency of spectrum is the band edge frequency and span is 5 MHz. RB of the spectrum is 100kHz and VB of the spectrum is 300kHz. (WCDMA / LTE Band 17 / LTE Band 4 Channel Bandwidth 5MHz/10MHz)
- d. The center frequency of spectrum is the band edge frequency and span is 1 MHz. RB of the spectrum is 180kHz and VB of the spectrum is 560kHz (LTE Band 4 Channel Bandwidth 20MHz).
- e. Record the max trace plot into the test report.



A D T

### 4.5.4 TEST RESULTS

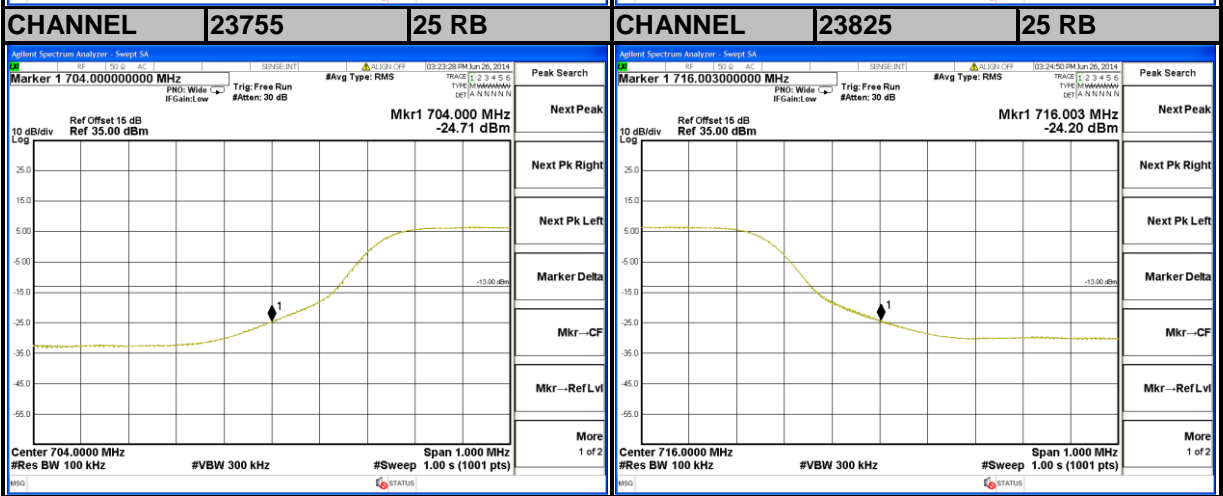
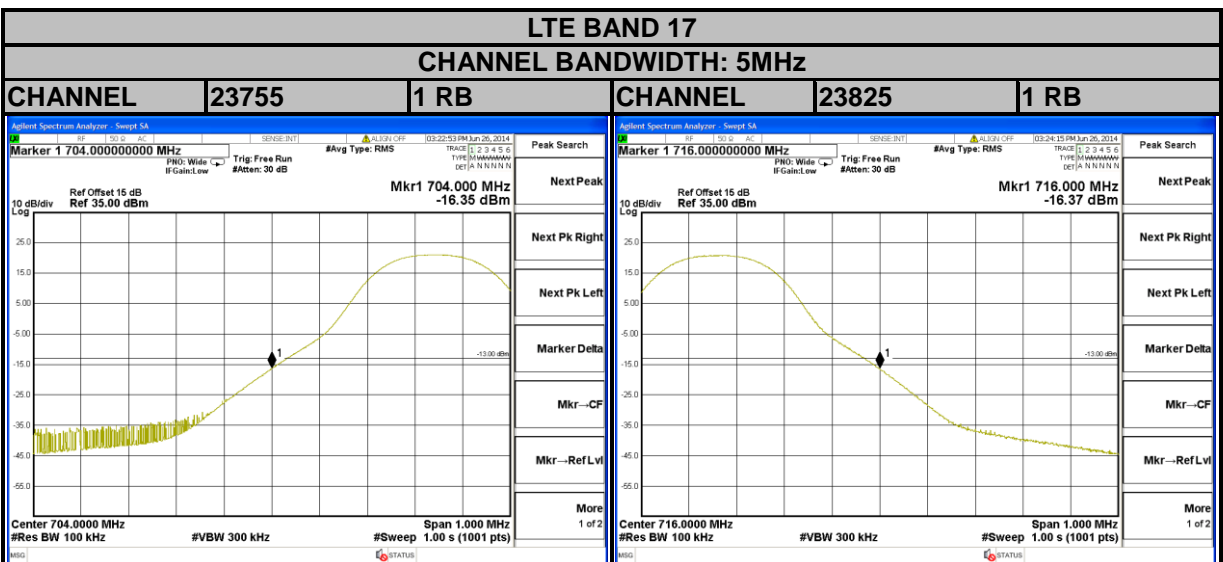
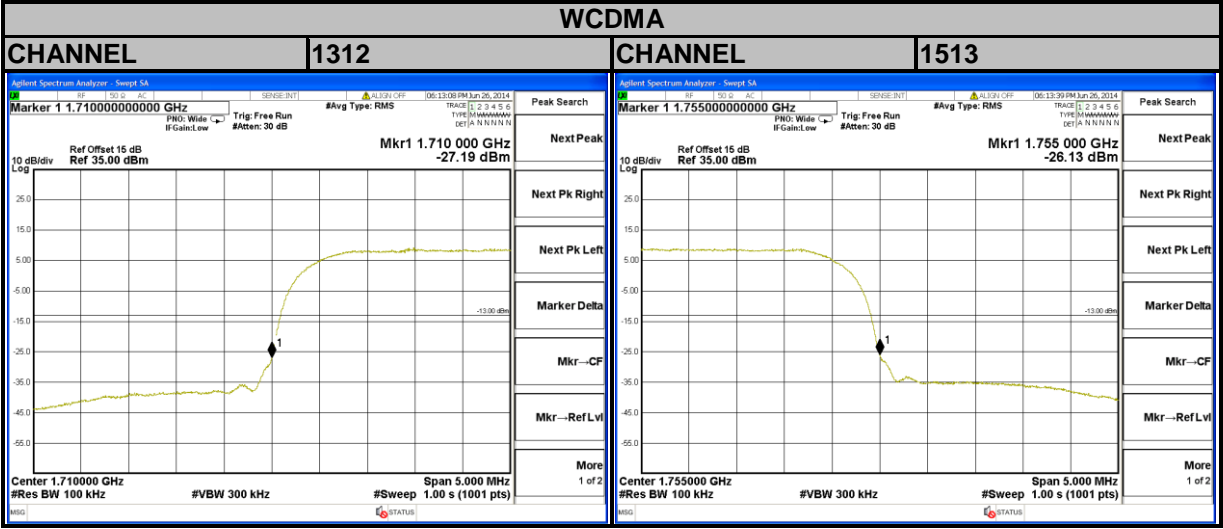





A D T

### LTE BAND 17

#### CHANNEL BANDWIDTH: 10MHz

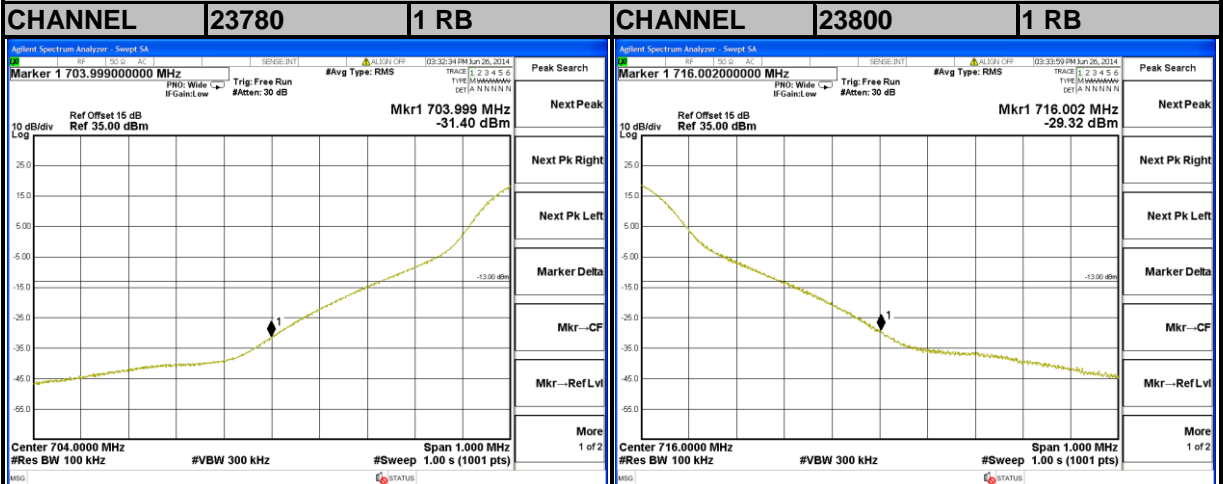

CHANNEL	23780	50 RB	CHANNEL	23800	50 RB
---------	-------	-------	---------	-------	-------

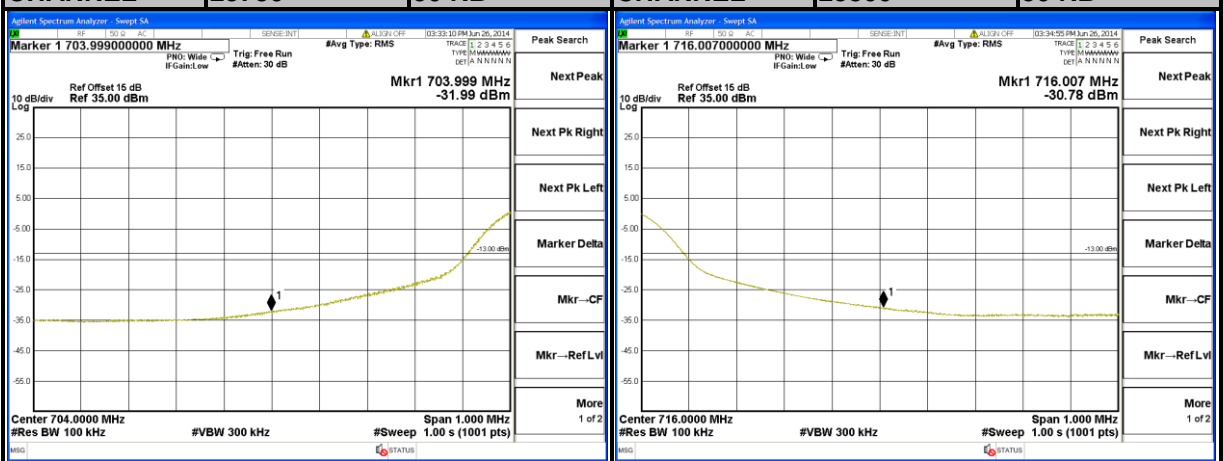



A D T

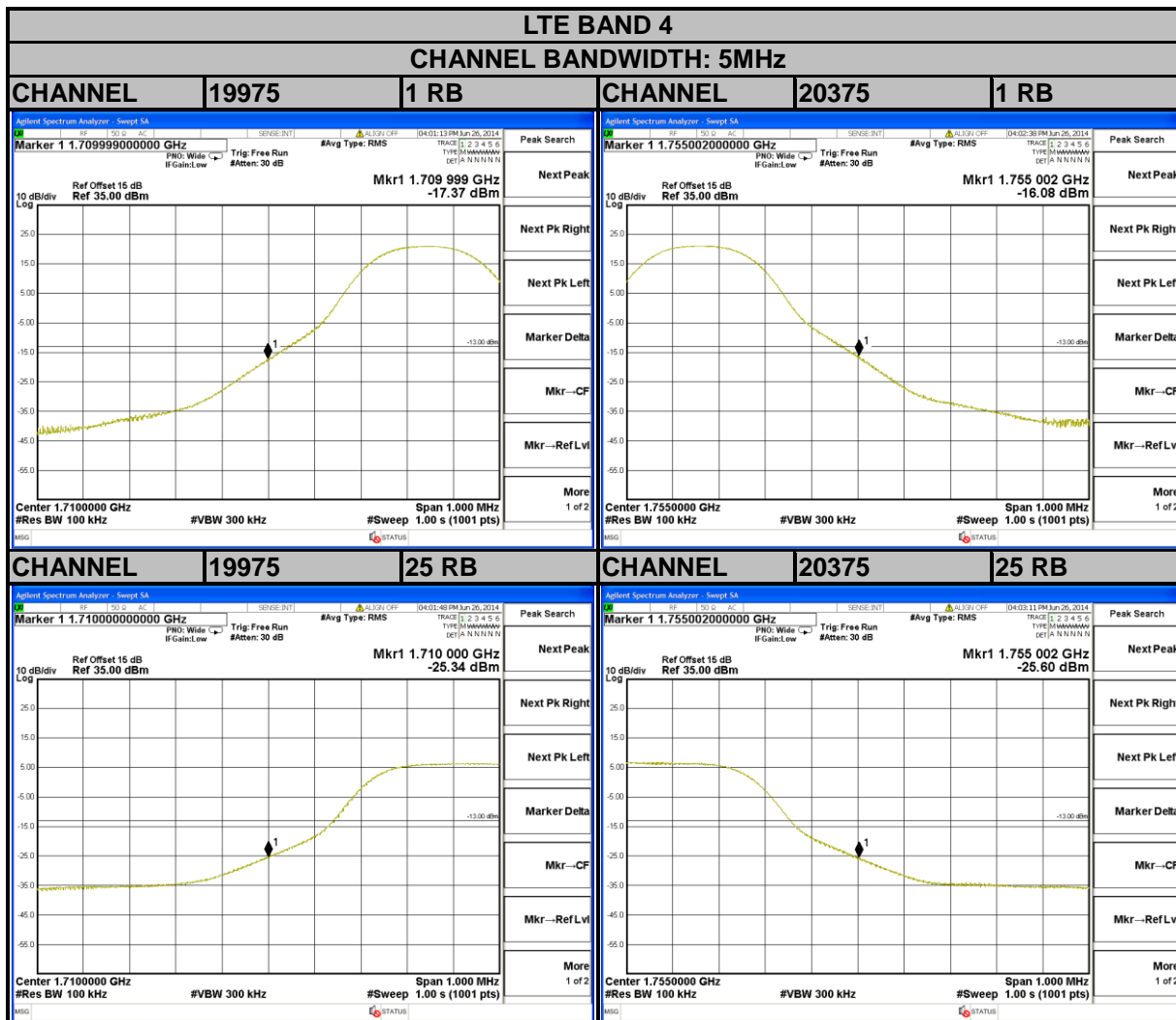



A D T

### LTE BAND 4

#### CHANNEL BANDWIDTH: 10MHz

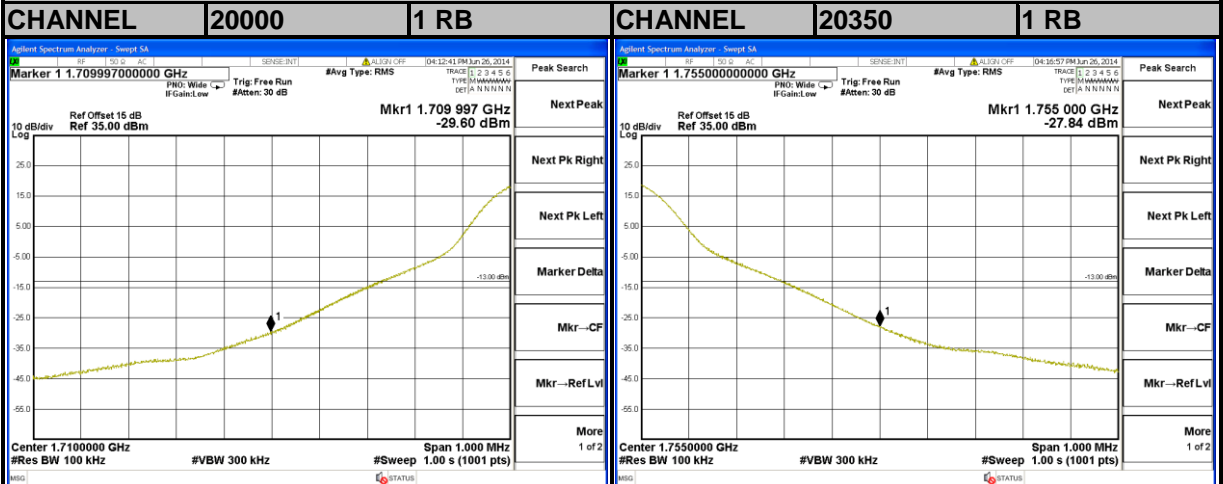

#### CHANNEL BANDWIDTH: 50 RB

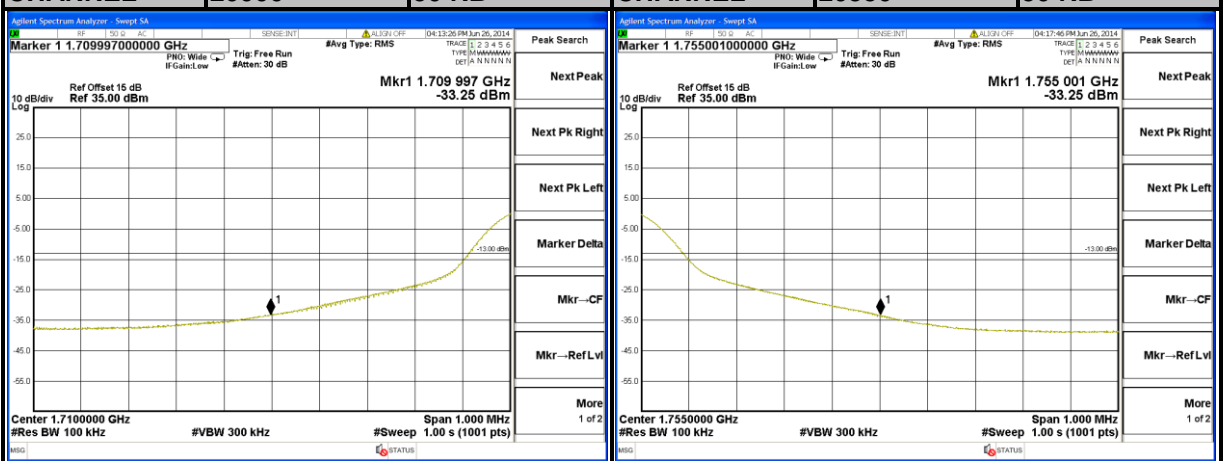



A D T

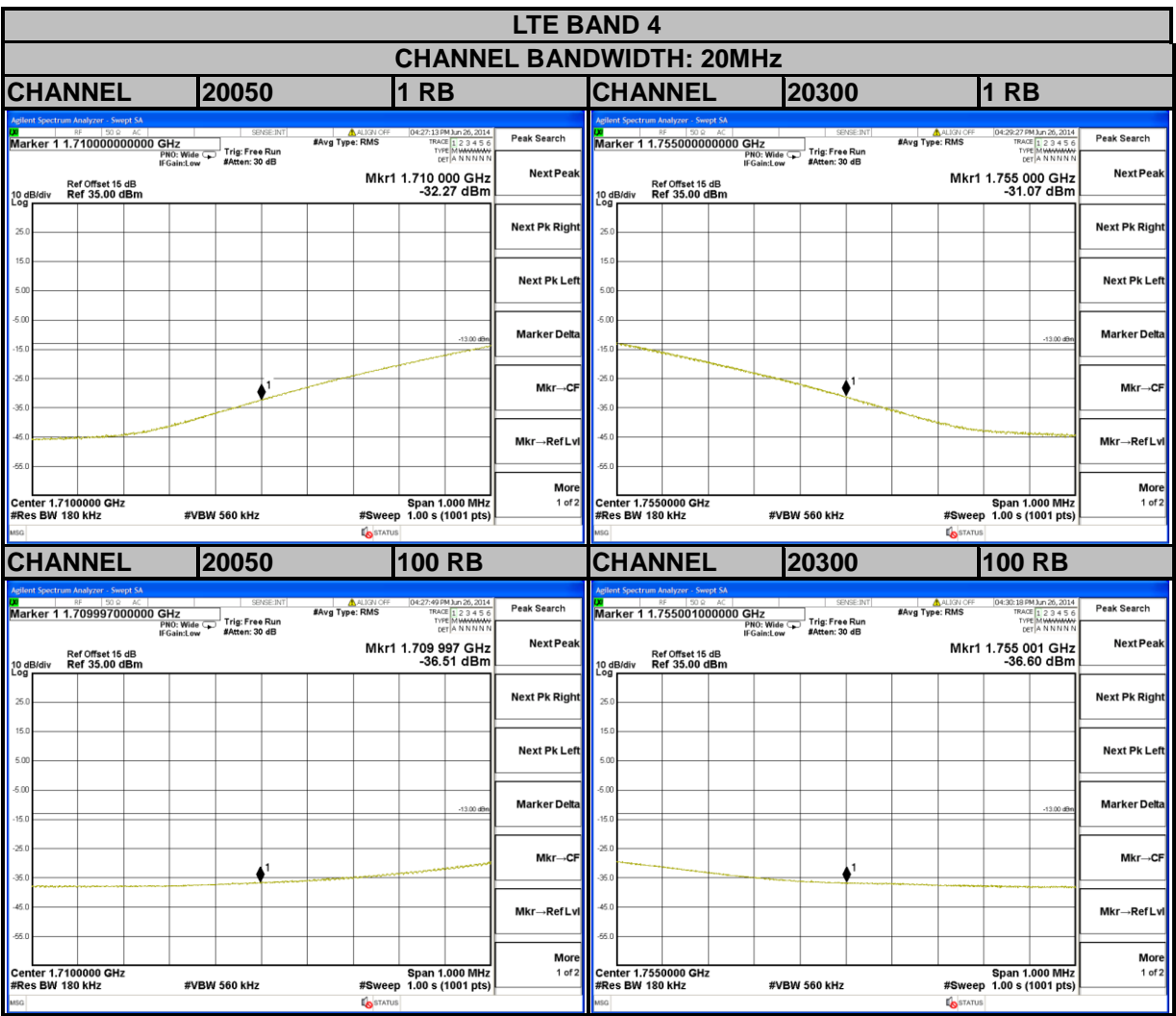

## 4.6 CONDUCTED SPURIOUS EMISSIONS

### 4.6.1 LIMITS OF CONDUCTED SPURIOUS EMISSIONS MEASUREMENT

The power of any emission outside a licensee's frequency block shall be attenuated below the transmitter power (P) by at least  $43 + 10 \log_{10}(P)$  dB. The limit of emission is equal to -13dBm.

### 4.6.2 TEST PROCEDURE

- a. The EUT makes a phone call to the communication simulator. All measurements were done at low, middle and high operational frequency range.
- b. Measuring frequency range is from 30 MHz to 8GHz for LTE Band 17 and from 30MHz to 18GHz for LTE Band 4. 10dB attenuation pad is connected with spectrum. RBW=1MHz and VBW=3MHz are used for conducted emission measurement.

### 4.6.3 TEST SETUP

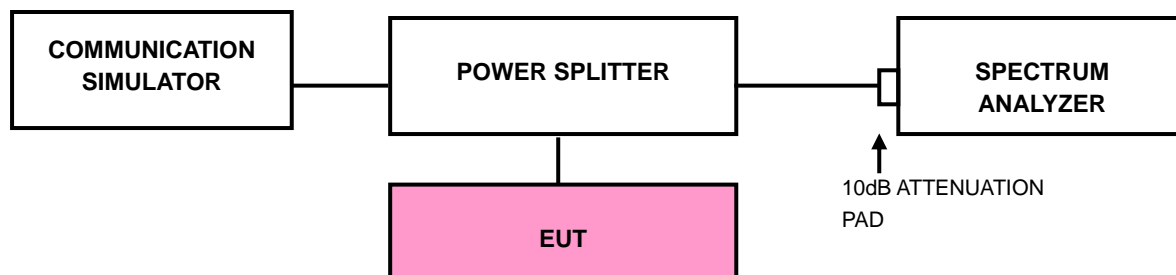



A D T

### 4.6.4 TEST RESULTS

FREQUENCY RANGE: 30MHz~8GHz

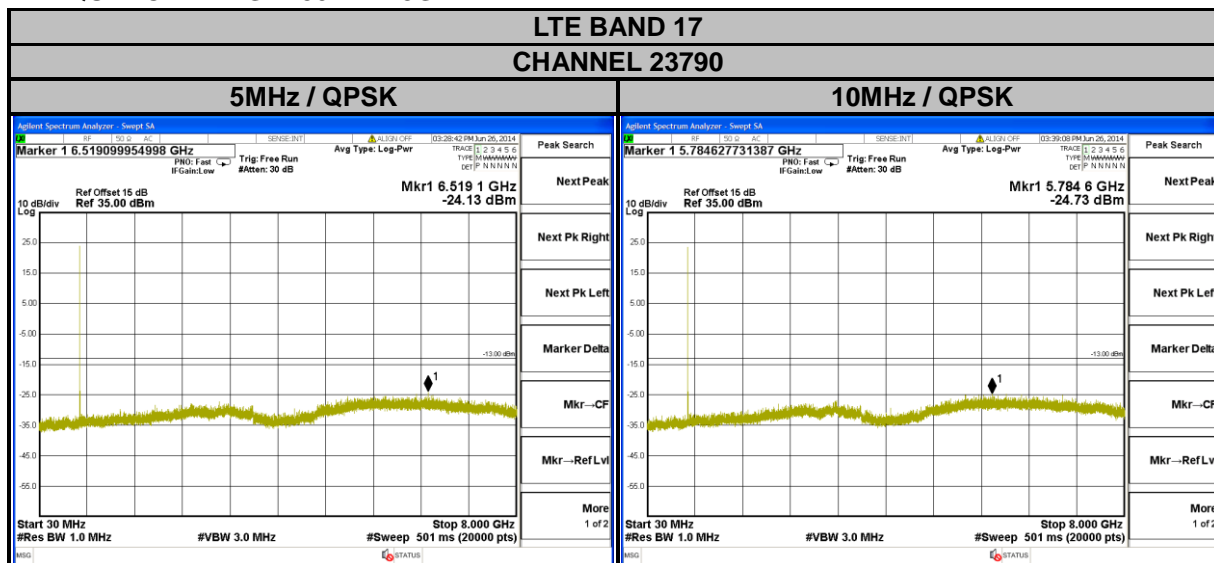

FREQUENCY RANGE: 30MHz~18GHz

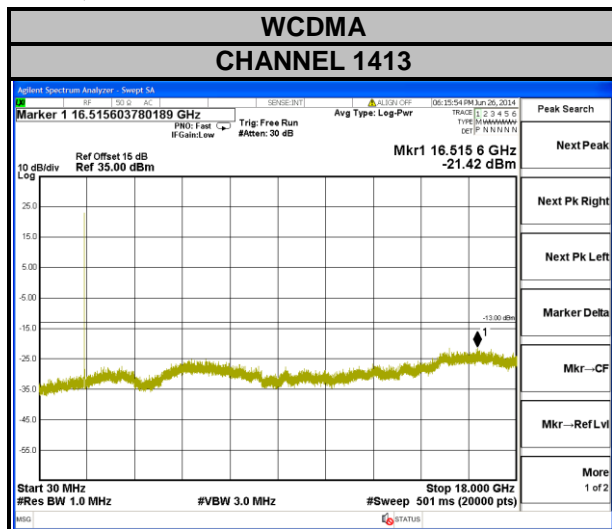



A D T

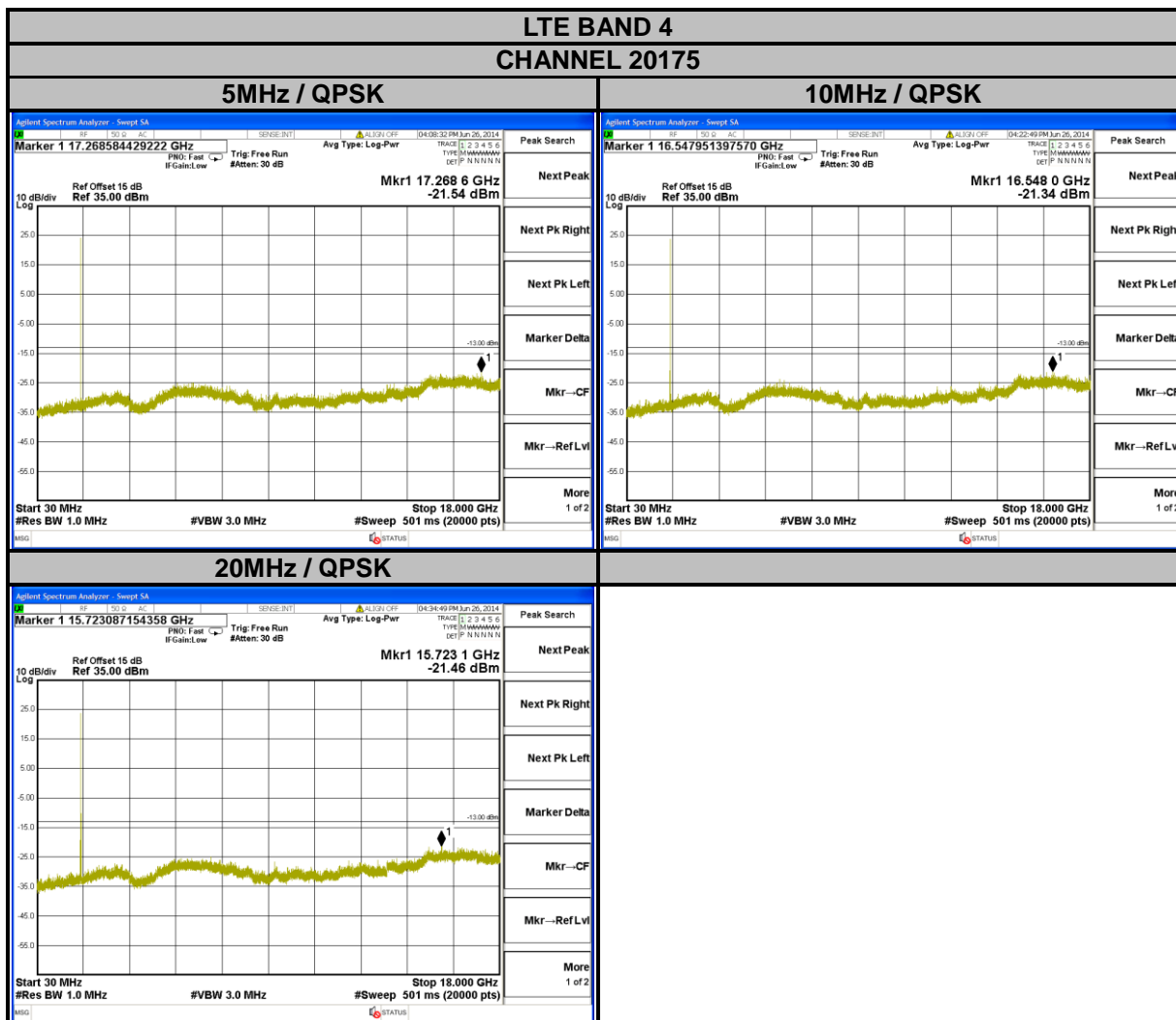

## 4.7 RADIATED EMISSION MEASUREMENT

### 4.7.1 LIMITS OF RADIATED EMISSION MEASUREMENT

The power of any emission outside a licensee's frequency block shall be attenuated below the transmitter power (P) by at least  $43 + 10 \log_{10}(P)$  dB. The limit of emission equal to  $-13\text{dBm}$

### 4.7.2 TEST PROCEDURES

- a. Substitution method is used for E.I.R.P measurement. In the semi-anechoic chamber, EUT placed on the 0.8m height of Turn Table, rotated the table around 360 degrees to search the maximum radiation power and receiver antenna shall be rotated vertical and horizontal polarization and moved height from 1m to 4m to find the maximum polar radiated power. The "Read Value" is the spectrum reading the maximum power value.
- b. The substitution horn antenna is substituted for EUT at the same position and signals generator export the CW signal to the substitution antenna via a TX cable. Rotated the Turn Table and moved receiving antenna to find the maximum radiation power. Adjust output power level of S.G to get a Value of spectrum reading equal to "Read Value " of step a. Record the power level of S.G
- c.  $\text{EIRP} = \text{Output power level of S.G} - \text{TX cable loss} + \text{Antenna gain of substitution horn.}$
- d. E.R.P power can be calculated form E.I.R.P power by subtracting the gain of dipole,  $\text{E.R.P power} = \text{E.I.P.R power} - 2.15\text{dBi.}$

**NOTE:** The resolution bandwidth of spectrum analyzer is 1 MHz and the video bandwidth is 3 MHz.

### 4.7.3 DEVIATION FROM TEST STANDARD

No deviation



#### 4.7.4 TEST SETUP

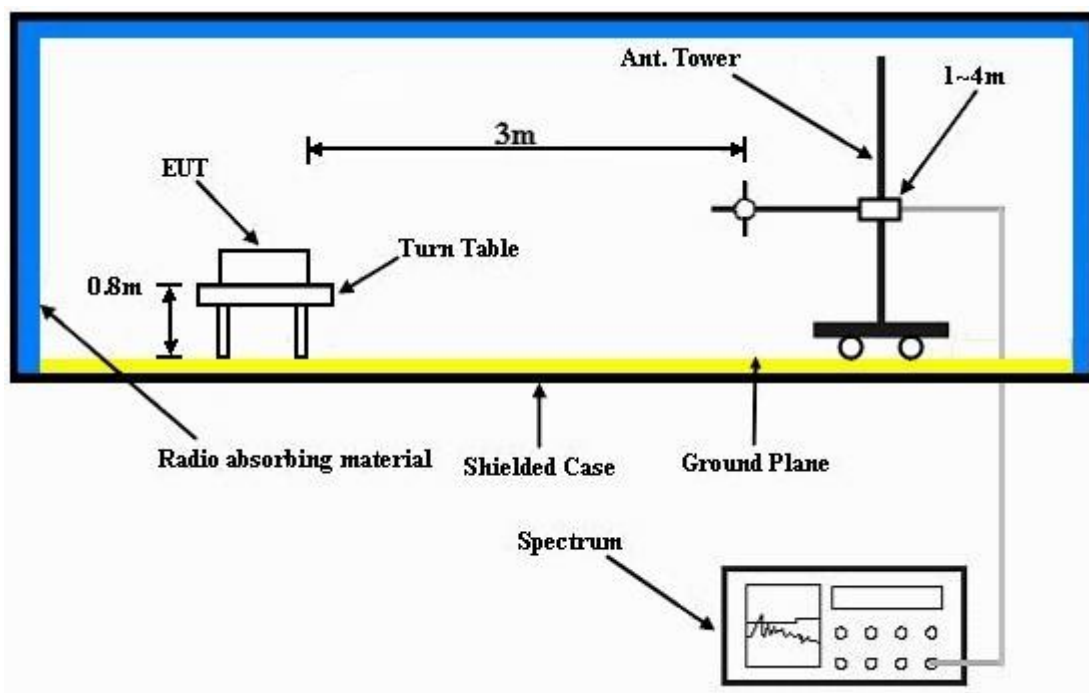

For the actual test configuration, please refer to the attached file (Test Setup Photo).



A D T

### 4.7.5 TEST RESULTS

MODE A  
WCDMA



Bureau Veritas Consumer Products Services Ltd., Taoyuan Branch

A D T

Data: 13

Date: 2014-07-22

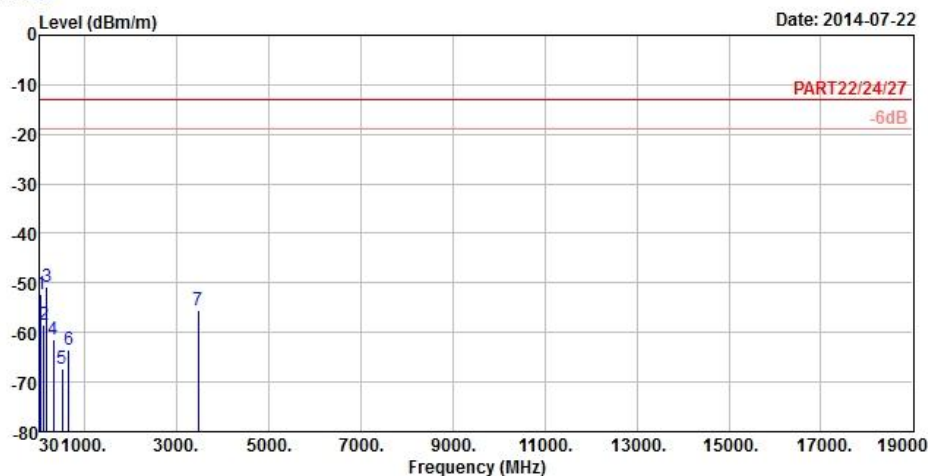

Site : 966 Chamber 5  
 Condition: PART22/24/27 3m HORIZONTAL  
 Remark : Band IV Link  
 Tested by: Anson Lin  
 Plane : Z

	Freq	Level	Read Level	Limit Line	Over Limit	Factor	Remark
	MHz	dBm/m	dBm	dBm/m	dB	dB/m	
1	56.19	-52.33	-46.83	-13.00	-39.33	-5.50	Peak
2	112.08	-58.57	-47.90	-13.00	-45.57	-10.67	Peak
3 pp	180.66	-50.83	-45.16	-13.00	-37.83	-5.67	Peak
4	328.70	-61.41	-55.25	-13.00	-48.41	-6.16	Peak
5	509.30	-67.28	-64.43	-13.00	-54.28	-2.85	Peak
6	662.60	-63.44	-64.21	-13.00	-50.44	0.77	Peak
7	3465.20	-55.40	-46.38	-13.00	-42.40	-9.02	Peak



A D T



Bureau Veritas Consumer Products Services Ltd., Taoyuan Branch

A D T

Data: 14

Date: 2014-07-22

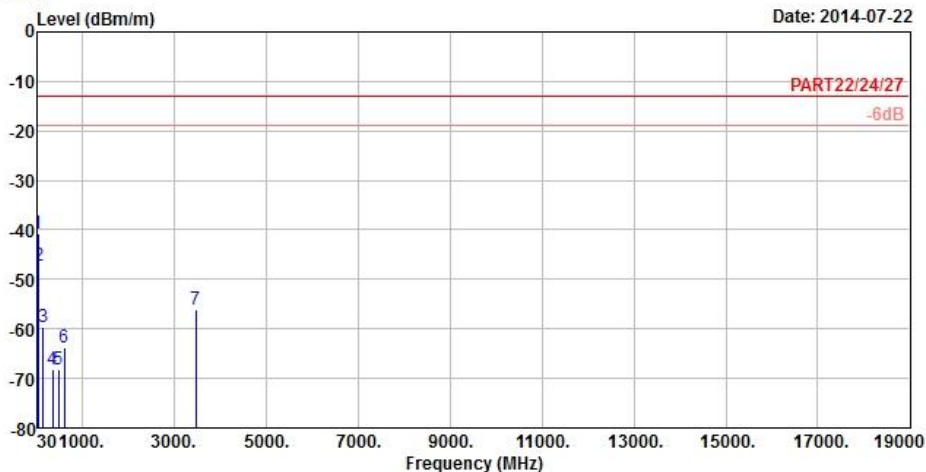

Site : 966 Chamber 5  
 Condition: PART22/24/27 3m VERTICAL  
 Remark : Band IV Link  
 Tested by: Anson Lin  
 Plane : Z

	Freq	Level	Read Level	Limit Line	Over Limit	Factor	Remark
	MHz	dBm/m	dBm	dBm/m	dB	dB/m	
1	pp	36.48	-40.64	-38.49	-13.00	-27.64	-2.15 Peak
2		55.92	-47.21	-41.71	-13.00	-34.21	-5.50 Peak
3		153.39	-59.71	-53.30	-13.00	-46.71	-6.41 Peak
4		345.50	-68.09	-62.05	-13.00	-55.09	-6.04 Peak
5		475.00	-68.11	-64.38	-13.00	-55.11	-3.73 Peak
6		601.70	-63.91	-63.58	-13.00	-50.91	-0.33 Peak
7		3465.20	-56.14	-47.12	-13.00	-43.14	-9.02 Peak



A D T

# LTE BAND 17 CHANNEL BANDWIDTH: 10MHz / QPSK



Bureau Veritas Consumer Products Services Ltd., Taoyuan Branch

A D T

Data: 9

Date: 2014-07-24

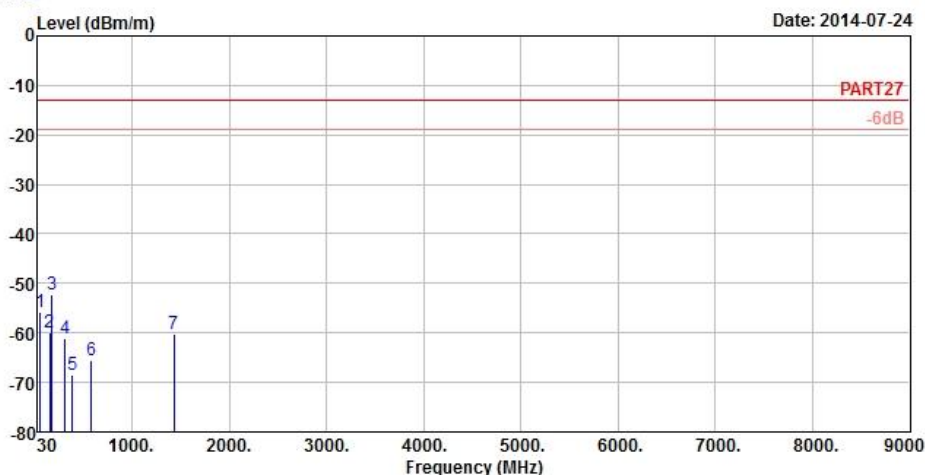

Site : 966 Chamber 5  
 Condition: PART27 3m HORIZONTAL  
 Remark : LTE Band 17\_10M\_QPSK(1,49) Link  
 Tested by: Anson Lin  
 Plane : Z

	Read	Limit	Over				
Freq	Level	Level	Line	Limit	Factor	Remark	
MHz	dBm/m	dBm	dBm/m	dB	dB/m		
1	52.14	-55.67	-50.77	-13.00	-42.67	-4.90	Peak
2	152.04	-59.98	-53.59	-13.00	-46.98	-6.39	Peak
3 pp	176.88	-52.21	-45.79	-13.00	-39.21	-6.42	Peak
4	309.80	-61.03	-54.72	-13.00	-48.03	-6.31	Peak
5	386.80	-68.57	-62.84	-13.00	-55.57	-5.73	Peak
6	578.60	-65.41	-64.47	-13.00	-52.41	-0.94	Peak
7	1428.80	-60.14	-46.54	-13.00	-47.14	-13.60	Peak



A D T



Bureau Veritas Consumer Products Services Ltd., Taoyuan Branch

A D T

Data: 10

Date: 2014-07-24

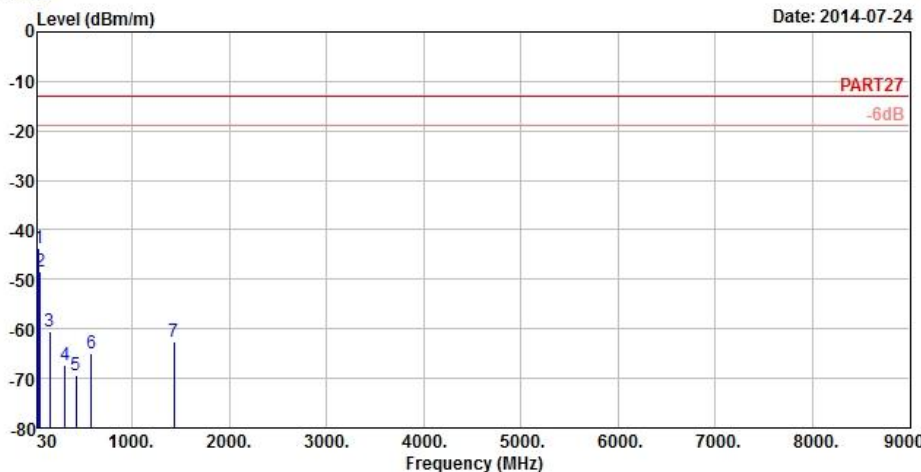

Site : 966 Chamber 5  
 Condition: PART27 3m VERTICAL  
 Remark : LTE Band 17\_10M\_QPSK(1,49) Link  
 Tested by: Anson Lin  
 Plane : Z

	Freq	Level	Read Level	Limit Line	Over Limit	Factor	Remark
	MHz	dBm/m	dBm	dBm/m	dB	dB/m	
1	pp	36.21	-43.72	-41.36	-13.00	-30.72	-2.36 Peak
2		57.27	-48.31	-42.66	-13.00	-35.31	-5.65 Peak
3		152.04	-60.41	-54.02	-13.00	-47.41	-6.39 Peak
4		309.10	-67.24	-60.93	-13.00	-54.24	-6.31 Peak
5		423.90	-69.46	-64.43	-13.00	-56.46	-5.03 Peak
6		583.50	-65.02	-64.22	-13.00	-52.02	-0.80 Peak
7		1428.80	-62.53	-48.93	-13.00	-49.53	-13.60 Peak



A D T

# LTE BAND 4 CHANNEL BANDWIDTH: 20MHz / QPSK



Bureau Veritas Consumer Products Services Ltd., Taoyuan Branch

A D T

Data: 13

Date: 2014-07-23

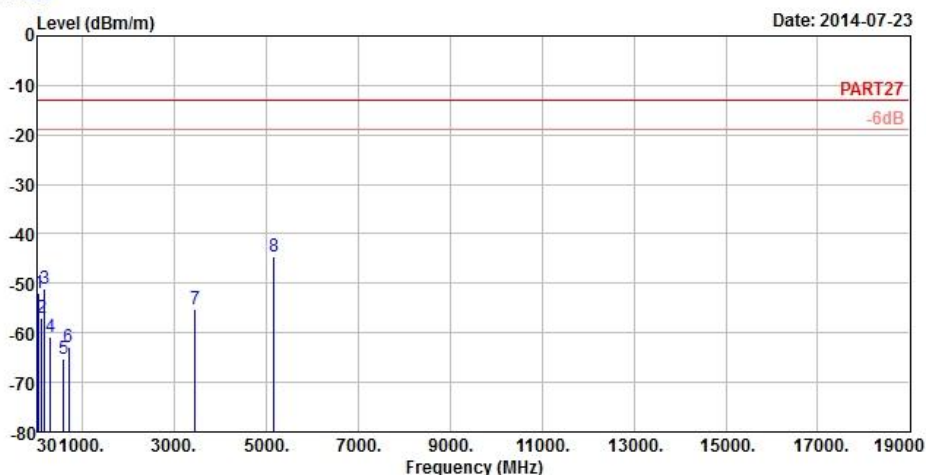

Site : 966 Chamber 5  
 Condition: PART27 3m HORIZONTAL  
 Remark : LTE Band 4\_20M\_QPSK(1,0) Link  
 Tested by: Anson Lin  
 Plane : Z

	Freq	Level	Read Level	Limit Line	Over Limit	Factor	Remark
	MHz	dBm/m	dBm	dBm/m	dB	dB/m	
1	57.27	-52.07	-46.42	-13.00	-39.07	-5.65	Peak
2	107.76	-56.94	-46.37	-13.00	-43.94	-10.57	Peak
3	180.12	-51.08	-45.41	-13.00	-38.08	-5.67	Peak
4	311.20	-60.75	-54.46	-13.00	-47.75	-6.29	Peak
5	596.80	-65.22	-64.76	-13.00	-52.22	-0.46	Peak
6	702.50	-62.89	-64.35	-13.00	-49.89	1.46	Peak
7	3447.40	-55.22	-46.13	-13.00	-42.22	-9.09	Peak
8 pp	5171.10	-44.55	-41.40	-13.00	-31.55	-3.15	Peak



A D T



Bureau Veritas Consumer Products Services Ltd., Taoyuan Branch

A D T

Data: 14

Date: 2014-07-23

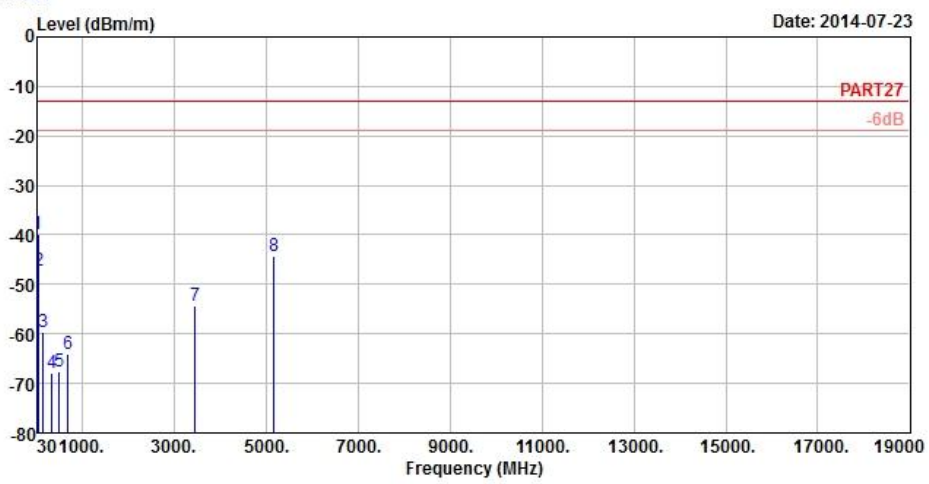

Site : 966 Chamber 5  
 Condition: PART27 3m VERTICAL  
 Remark : LTE Band 4\_20M\_QPSK(1,0) Link  
 Tested by: Anson Lin  
 Plane : Z

	Freq	Level	Read Level	Limit	Over		Remark
	MHz	dBm/m	dBm	dBm/m	dB	dB/m	
1	pp	36.21	-39.91	-37.55	-13.00	-26.91	-2.36 Peak
2		56.46	-47.32	-41.82	-13.00	-34.32	-5.50 Peak
3		152.85	-59.77	-53.36	-13.00	-46.77	-6.41 Peak
4		342.70	-68.03	-61.97	-13.00	-55.03	-6.06 Peak
5		488.30	-67.52	-64.11	-13.00	-54.52	-3.41 Peak
6		690.60	-63.93	-65.21	-13.00	-50.93	1.28 Peak
7		3447.40	-54.25	-45.16	-13.00	-41.25	-9.09 Peak
8		5171.10	-44.16	-41.01	-13.00	-31.16	-3.15 Peak





A D T

MODE B  
WCDMA



Bureau Veritas Consumer Products Services Ltd., Taoyuan Branch

A D T

Data: 13

Date: 2014-07-24

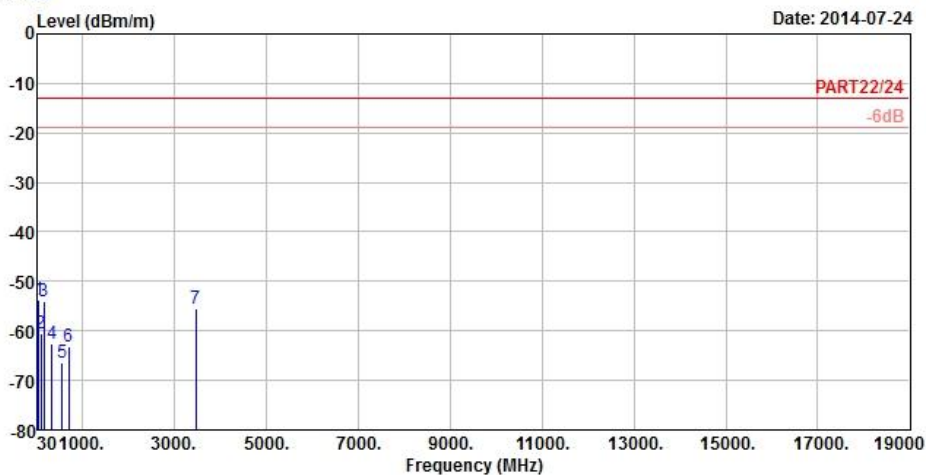

Site : 966 Chamber 5  
 Condition: PART22/24/27 3m HORIZONTAL  
 Remark : Band IV Link  
 Tested by: Anson Lin  
 Plane : Z

	Freq	Level	Read Level	Limit Line	Over Limit	Factor	Remark
	MHz	dBm/m	dBm	dBm/m	dB	dB/m	
1	pp	53.76	-53.60	-48.55	-13.00	-40.60	-5.05 Peak
2		103.98	-60.49	-50.01	-13.00	-47.49	-10.48 Peak
3		167.43	-54.10	-47.44	-13.00	-41.10	-6.66 Peak
4		337.80	-62.67	-56.57	-13.00	-49.67	-6.10 Peak
5		552.00	-66.45	-64.77	-13.00	-53.45	-1.68 Peak
6		701.10	-63.06	-64.52	-13.00	-50.06	1.46 Peak
7		3465.20	-55.64	-46.62	-13.00	-42.64	-9.02 Peak





A D T



Bureau Veritas Consumer Products Services Ltd., Taoyuan Branch

A D T

Data: 14

Date: 2014-07-24

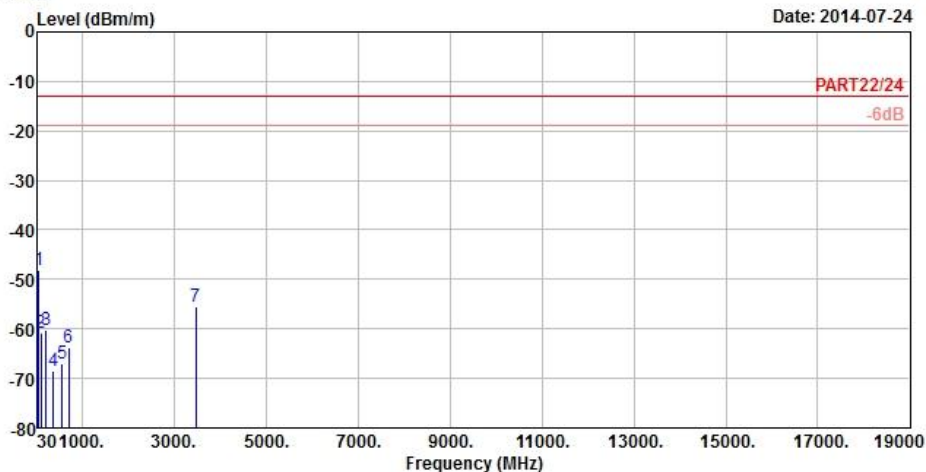

Site : 966 Chamber 5  
 Condition: PART22/24/27 3m VERTICAL  
 Remark : Band IV Link  
 Tested by: Anson Lin  
 Plane : Z

	Freq	Level	Read Level	Limit Line	Over Limit	Factor	Remark
	MHz	dBm/m	dBm	dBm/m	dB	dB/m	
1	pp	58.08	-48.25	-42.45	-13.00	-35.25	-5.80 Peak
2		105.87	-60.69	-50.16	-13.00	-47.69	-10.53 Peak
3		208.20	-60.28	-52.72	-13.00	-47.28	-7.56 Peak
4		373.50	-68.58	-62.75	-13.00	-55.58	-5.83 Peak
5		561.10	-66.98	-65.57	-13.00	-53.98	-1.41 Peak
6		705.30	-63.81	-65.29	-13.00	-50.81	1.48 Peak
7		3465.20	-55.57	-46.55	-13.00	-42.57	-9.02 Peak



A D T

# LTE BAND 17 CHANNEL BANDWIDTH: 10MHz / QPSK



Bureau Veritas Consumer Products Services Ltd., Taoyuan Branch

A D T

Data: 9

Date: 2014-07-24

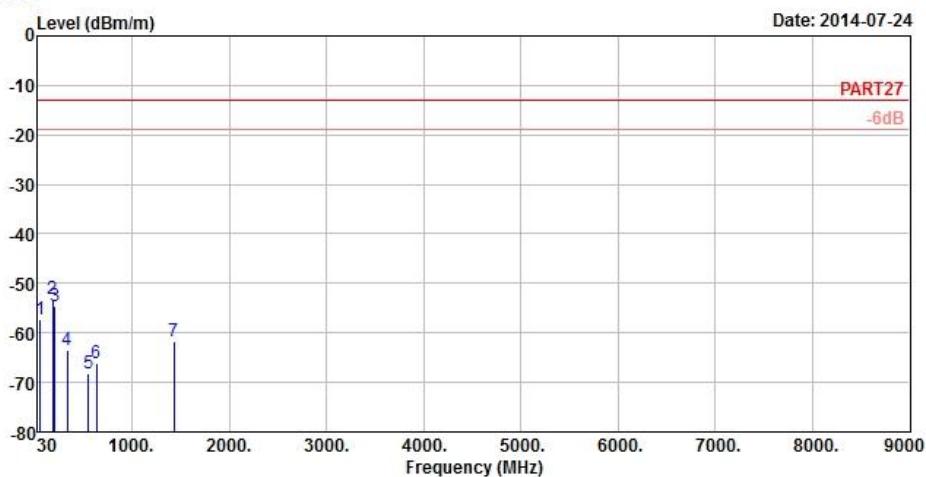

Site : 966 Chamber 5  
 Condition: PART27 3m HORIZONTAL  
 Remark : LTE Band 17\_10M\_QPSK(1,49) Link  
 Tested by: Anson Lin  
 Plane : Z

	Read	Limit	Over				
Freq	Level	Level	Line	Limit	Factor	Remark	
MHz	dBm/m	dBm	dBm/m	dB	dB/m		
1	52.95	-57.19	-52.14	-13.00	-44.19	-5.05	Peak
2 pp	181.20	-53.02	-47.24	-13.00	-40.02	-5.78	Peak
3	207.66	-54.68	-47.08	-13.00	-41.68	-7.60	Peak
4	335.00	-63.60	-57.48	-13.00	-50.60	-6.12	Peak
5	554.10	-68.06	-66.43	-13.00	-55.06	-1.63	Peak
6	633.20	-66.15	-66.39	-13.00	-53.15	0.24	Peak
7	1428.80	-61.58	-47.98	-13.00	-48.58	-13.60	Peak



A D T



Bureau Veritas Consumer Products Services Ltd., Taoyuan Branch

A D T

Data: 10

Date: 2014-07-24

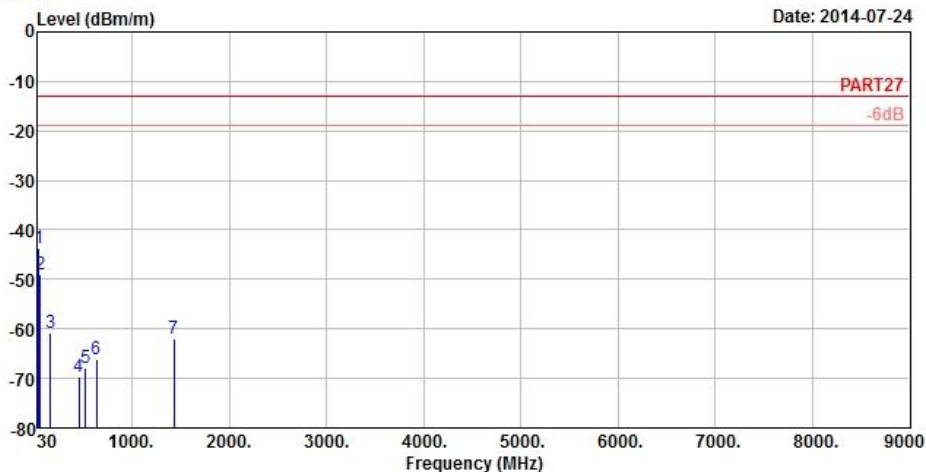

Site : 966 Chamber 5  
 Condition: PART27 3m VERTICAL  
 Remark : LTE Band 17\_10M\_QPSK(1,49) Link  
 Tested by: Anson Lin  
 Plane : Z

	Freq	Level	Read Level	Limit Line	Over Limit	Factor	Remark
	MHz	dBm/m	dBm	dBm/m	dB	dB/m	
1	pp	36.21	-43.72	-41.36	-13.00	-30.72	-2.36 Peak
2		55.92	-49.15	-43.65	-13.00	-36.15	-5.50 Peak
3		157.71	-60.81	-54.33	-13.00	-47.81	-6.48 Peak
4		455.40	-69.72	-65.50	-13.00	-56.72	-4.22 Peak
5		524.00	-68.01	-65.56	-13.00	-55.01	-2.45 Peak
6		631.80	-66.17	-66.38	-13.00	-53.17	0.21 Peak
7		1428.80	-62.08	-48.48	-13.00	-49.08	-13.60 Peak



A D T

# LTE BAND 4 CHANNEL BANDWIDTH: 20MHz / QPSK



Bureau Veritas Consumer Products Services Ltd., Taoyuan Branch

A D T

Data: 13

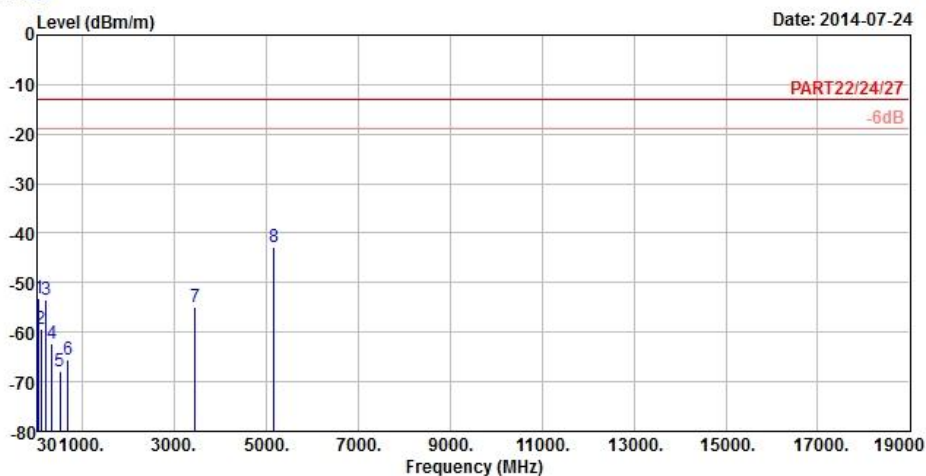

Site : 966 Chamber 5  
 Condition: PART22/24/27 3m HORIZONTAL  
 Remark : LTE Band 4\_20M\_QPSK(1,0) Link  
 Tested by: Anson Lin  
 Plane : Z

	Freq	Level	Read Level	Limit Line	Over Limit	Factor	Remark
	MHz	dBm/m	dBm	dBm/m	dB	dB/m	
1	55.92	-53.06	-47.56	-13.00	-40.06	-5.50	Peak
2	105.33	-59.43	-48.90	-13.00	-46.43	-10.53	Peak
3	207.93	-53.30	-45.70	-13.00	-40.30	-7.60	Peak
4	329.40	-62.21	-56.05	-13.00	-49.21	-6.16	Peak
5	505.80	-68.03	-65.10	-13.00	-55.03	-2.93	Peak
6	678.70	-65.41	-66.48	-13.00	-52.41	1.07	Peak
7	3447.40	-54.78	-45.69	-13.00	-41.78	-9.09	Peak
8 pp	5171.10	-42.71	-39.56	-13.00	-29.71	-3.15	Peak



A D T



Bureau Veritas Consumer Products Services Ltd., Taoyuan Branch

A D T

Data: 14

Date: 2014-07-24

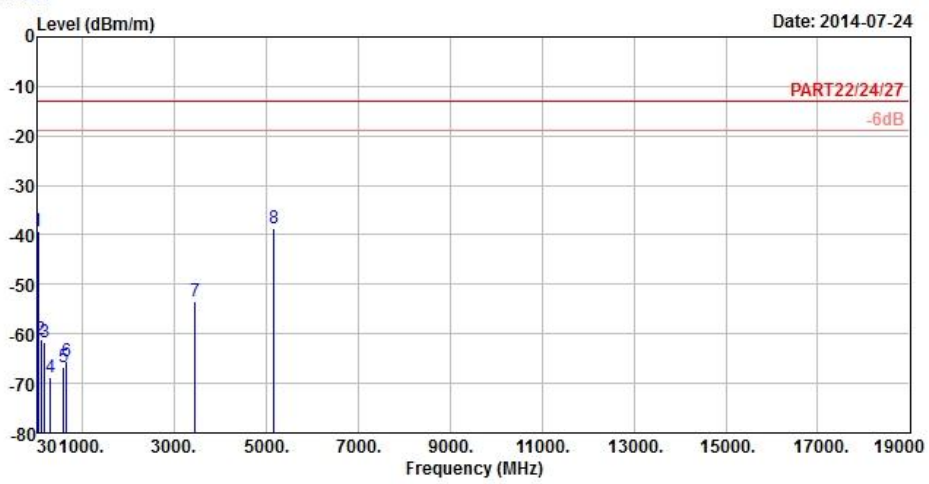

Site : 966 Chamber 5  
 Condition: PART22/24/27 3m VERTICAL  
 Remark : LTE Band 4\_20M\_QPSK(1,0) Link  
 Tested by: Anson Lin  
 Plane : Z

	Freq	Level	Read Level	Limit	Over	Factor	Remark
	MHz	dBm/m	dBm	dBm/m	dB	dB/m	
1	31.08	-39.16	-39.50	-13.00	-26.16	0.34	Peak
2	106.14	-61.19	-50.66	-13.00	-48.19	-10.53	Peak
3	173.10	-61.73	-54.96	-13.00	-48.73	-6.77	Peak
4	306.30	-68.77	-62.44	-13.00	-55.77	-6.33	Peak
5	594.70	-66.83	-66.32	-13.00	-53.83	-0.51	Peak
6	657.00	-65.54	-66.20	-13.00	-52.54	0.66	Peak
7	3447.40	-53.35	-44.26	-13.00	-40.35	-9.09	Peak
8 pp	5171.10	-38.76	-35.61	-13.00	-25.76	-3.15	Peak



## 5 INFORMATION ON THE TESTING LABORATORIES

We, Bureau Veritas Consumer Products Services (H.K.) Ltd., Taoyuan Branch, were founded in 1988 to provide our best service in EMC, Radio, Telecom and Safety consultation. Our laboratories are accredited and approved according to ISO/IEC 17025.

If you have any comments, please feel free to contact us at the following:

**Linko EMC/RF Lab:**

Tel: 886-2-26052180

Fax: 886-2-26051924

**Hsin Chu EMC/RF Lab:**

Tel: 886-3-5935343

Fax: 886-3-5935342

**Hwa Ya EMC/RF/Safety/Telecom Lab:**

Tel: 886-3-3183232

Fax: 886-3-3270892

**Email:** [service.adt@tw.bureauveritas.com](mailto:service.adt@tw.bureauveritas.com)

**Web Site:** [www.adt.com.tw](http://www.adt.com.tw)

The address and road map of all our labs can be found in our web site also.



A D T

## **6 APPENDIX A – MODIFICATIONS RECORDERS FOR ENGINEERING CHANGES TO THE EUT BY THE LAB**

No modifications were made to the EUT by the lab during the test.

---END---