

# FCC Test Report

Product Name : Smart Display  
Trade Name : Verizon  
Model No. : LVD1  
FCC ID : NKR-LVD1-IDU

Applicant : Wistron NeWeb Corporation  
Address : No. 20, Yuanqu 2nd Rd., Baoshan Township,,  
Hsinchu County 30844 Taiwan

Date of Receipt : May 06, 2021  
Issued Date : Jun. 16, 2021  
Report No. : 2150109R-E3032110108  
Report Version : V1.0



The test results relate only to the samples tested.

The test report shall not be reproduced except in full without the written approval of DEKRA Testing and Certification Co., Ltd.

# Test Report Certification

Issued Date : Jun. 16, 2021

Report No. : 2150109R-E3032110108



Product Name : Smart Display  
 Applicant : Wistron NeWeb Corporation  
 Address : No. 20, Yuanqu 2nd Rd., Baoshan Township,, Hsinchu County  
 30844 Taiwan  
 Manufacturer : Wistron NeWeb Corporation  
 Address : No. 20, Yuanqu 2nd Rd., Baoshan Township,, Hsinchu County  
 30844 Taiwan  
 Trade name : Verizon  
 Model No. : LVD1  
 FCC ID : NKR-LVD1-IDU  
 EUT Voltage : AC 100-120V, 60Hz for adapter 1  
 AC 100-120V, 60Hz for adapter 2  
 Testing Voltage : AC 120V/60Hz  
 Applicable Standard : FCC CFR Title 47 Part 15 Subpart C Section 15.247: 2019  
 ANSI C63.10: 2013  
 Laboratory Name : Hsin Chu Laboratory  
 Address : No.372-2, Sec. 4, Zhongxing Rd., Zhudong Township, Hsinchu  
 County 310, Taiwan, R.O.C.  
 TEL: +886-3-582-8001 / FAX: +886-3-582-8958  
 Test Result : Complied

Documented By :   
 \_\_\_\_\_  
 ( Demi Chang / Senior Engineering Adm. Specialist )

Tested By :   
 \_\_\_\_\_  
 ( Scott Chang / Senior Engineer )

Approved By :   
 \_\_\_\_\_  
 ( Louis Hsu / Deputy Manager )

---

**Revision History**

<b>Version</b>	<b>Description</b>	<b>Issued Date</b>
V1.0	Initial issue of report	Jun. 16, 2021

## TABLE OF CONTENTS

<b>Description</b>	<b>Page</b>
1. General Information .....	6
1.1. EUT Description .....	6
1.2. Test Mode.....	8
1.3. Tested System Details.....	9
1.4. Configuration of tested System .....	9
1.5. EUT Exercise Software .....	9
1.6. Comments and Remarks .....	10
1.7. Test Facility .....	11
1.8. List of Test Equipment.....	12
1.9. Uncertainty .....	14
1.10. Duty Cycle.....	15
2. Conducted Emission.....	16
2.1. Test Setup .....	16
2.2. Limits.....	16
2.3. Test Procedure .....	16
2.4. Test Specification .....	16
2.5. Test Result .....	17
3. Maximum peak conducted output power .....	21
3.1. Test Setup .....	21
3.2. Test procedures.....	21
3.3. Limits.....	21
3.4. Test Specification .....	21
3.5. Test Result .....	22
4. Radiated Emission.....	23
4.1. Test Setup .....	23
4.2. Limits.....	24
4.3. Test Procedure .....	25
4.4. Test Specification .....	25
4.5. Test Result .....	26
5. RF antenna conducted test.....	42
5.1. Test Setup .....	42
5.2. Limits.....	42
5.3. Test Procedure .....	42
5.4. Test Specification .....	42
5.5. Test Result .....	43
6. Bandedge .....	50
6.1. Test Setup .....	50

6.2.	Limits.....	50
6.3.	Test Procedure.....	50
6.4.	Test Specification.....	50
6.5.	Test Result.....	51
7.	Number of hopping frequency.....	79
7.1.	Test Setup.....	79
7.2.	Limits.....	79
7.3.	Test Procedures.....	80
7.4.	Test Specification.....	80
7.5.	Test Result.....	81
8.	Carrier Frequency Separation.....	84
8.1.	Test Setup.....	84
8.2.	Limits.....	84
8.3.	Test Procedures.....	84
8.4.	Test Specification.....	84
8.5.	Test Result.....	85
9.	-20dB Bandwidth.....	89
9.1.	Test Setup.....	89
9.2.	Limits.....	89
9.3.	Test Procedures.....	89
9.4.	Test Specification.....	89
9.5.	Test Result.....	90
10.	Dwell Time.....	94
10.1.	Test Setup.....	94
10.2.	Limits.....	94
10.3.	Test Procedures.....	95
10.4.	Test Specification.....	95
10.5.	Test Result.....	96
Attachment 1.....		100
Test Setup Photograph.....		100
Attachment 2.....		105
Radiated Emission Co-location.....		105

## 1. General Information

### 1.1. EUT Description

Product Name	Smart Display
Trade Name	Verizon
Model No.	LVD1
Frequency Range	2402~2480MHz
Channel Number	79 Channels
Type of Modulation	GFSK, 8-DPSK

Antenna Information	
MFR.	WNC
Model No.	N/A
Antenna Type	PCB Antenna
Antenna Gain	3.21 dBi

Accessories Information	
Power Adapter 1	Delta, ADP-36DW B I/P: 100-120V~60Hz, 0.9A O/P: 12Vdc, 3.0A Cable Out: Shielded, 1.8m
Power Adapter 2	Lucent Trans, 1A100-US1230 I/P: 100-120V~60Hz, 0.9A O/P: 12Vdc, 3.0A Cable Out: Shielded, 1.8m

Working Frequency of Each Channel							
Channel	Frequency	Channel	Frequency	Channel	Frequency	Channel	Frequency
00	2402 MHz	20	2422 MHz	40	2442 MHz	60	2462 MHz
01	2403 MHz	21	2423 MHz	41	2443 MHz	61	2463 MHz
02	2404 MHz	22	2424 MHz	42	2444 MHz	62	2464 MHz
03	2405 MHz	23	2425 MHz	43	2445 MHz	63	2465 MHz
04	2406 MHz	24	2426 MHz	44	2446 MHz	64	2466 MHz
05	2407 MHz	25	2427 MHz	45	2447 MHz	65	2467 MHz
06	2408 MHz	26	2428 MHz	46	2448 MHz	66	2468 MHz
07	2409 MHz	27	2429 MHz	47	2449 MHz	67	2469 MHz
08	2410 MHz	28	2430 MHz	48	2450 MHz	68	2470 MHz
09	2411 MHz	29	2431 MHz	49	2451 MHz	69	2471 MHz
10	2412 MHz	30	2432 MHz	50	2452 MHz	70	2472 MHz
11	2413 MHz	31	2433 MHz	51	2453 MHz	71	2473 MHz
12	2414 MHz	32	2434 MHz	52	2454 MHz	72	2474 MHz
13	2415 MHz	33	2435 MHz	53	2455 MHz	73	2475 MHz
14	2416 MHz	34	2436 MHz	54	2456 MHz	74	2476 MHz
15	2417 MHz	35	2437 MHz	55	2457 MHz	75	2477 MHz
16	2418 MHz	36	2438 MHz	56	2458 MHz	76	2478 MHz
17	2419 MHz	37	2439 MHz	57	2459 MHz	77	2479 MHz
18	2420 MHz	38	2440 MHz	58	2460 MHz	78	2480 MHz
19	2421 MHz	39	2441 MHz	59	2461 MHz		

## Note:

1. This Smart Display including 2.4GHz b/g/n/ac and 5GHz a/n/ac and BT2.0 & BT 5.0 transmitting and receiving functions.
2. The device contains certified module (Brand: WNC, M/N: IMQ7, FCC ID: NKRIMQ7).
3. Regards to the frequency band operation; the lowest , middle and highest frequency of channel were selected to perform the test, and then shown on this report.
4. The EUT description is from the customer declaration.

## 1.2. Test Mode

DEKRA has verified the construction and function in typical operation. All the test modes were carried out with the EUT in transmitting operation, which was shown in this test report and defined as follows:

Test Mode	Mode 1: Transmit_Adapter_ADP-36DW B Mode 2: Transmit_Adapter_1A100-US1230
-----------	--

Test Items	Modulation	Channel	Result
Conducted Emission	GFSK	00	Complies
Maximum peak conducted output power	GFSK/8-DPSK	00/39/78	Complies
Radiated Emission	GFSK/8-DPSK	00/39/78	Complies
RF antenna conducted test	GFSK/8-DPSK	00/39/78	Complies
Bandedge	GFSK/8-DPSK	00/39/78	Complies
Number of hopping Frequency	GFSK/8-DPSK	00/39/78	Complies
Carrier Frequency Separation	GFSK/8-DPSK	00/39/78	Complies
-20dB Bandwidth	GFSK/8-DPSK	00/39/78	Complies
Dwell Time	GFSK/8-DPSK	00/39/78	Complies

Note 1: Pre-Scan has been conducted to determine the worst-case mode from all possible combinations between available modulations, data rates and antenna ports (if EUT with antenna diversity architecture).

Note 2: Determining compliance shall be based on the results of the compliance measurement, not taking into account measurement instrumentation uncertainty.



### 1.3. Tested System Details

The types for all equipment, plus descriptions of all cables used in the tested system (including inserted cards) are:

Product	Manufacturer	Model No.	Serial No.	FCC ID	Power Cord
1   Notebook PC	Lenove	80SJ	MP16Z7TB	DoC	Shielded, 1.8m
2   UART to RS232 console board	WNC	48.J53RS.SGA	--	DoC	--

### 1.4. Configuration of tested System

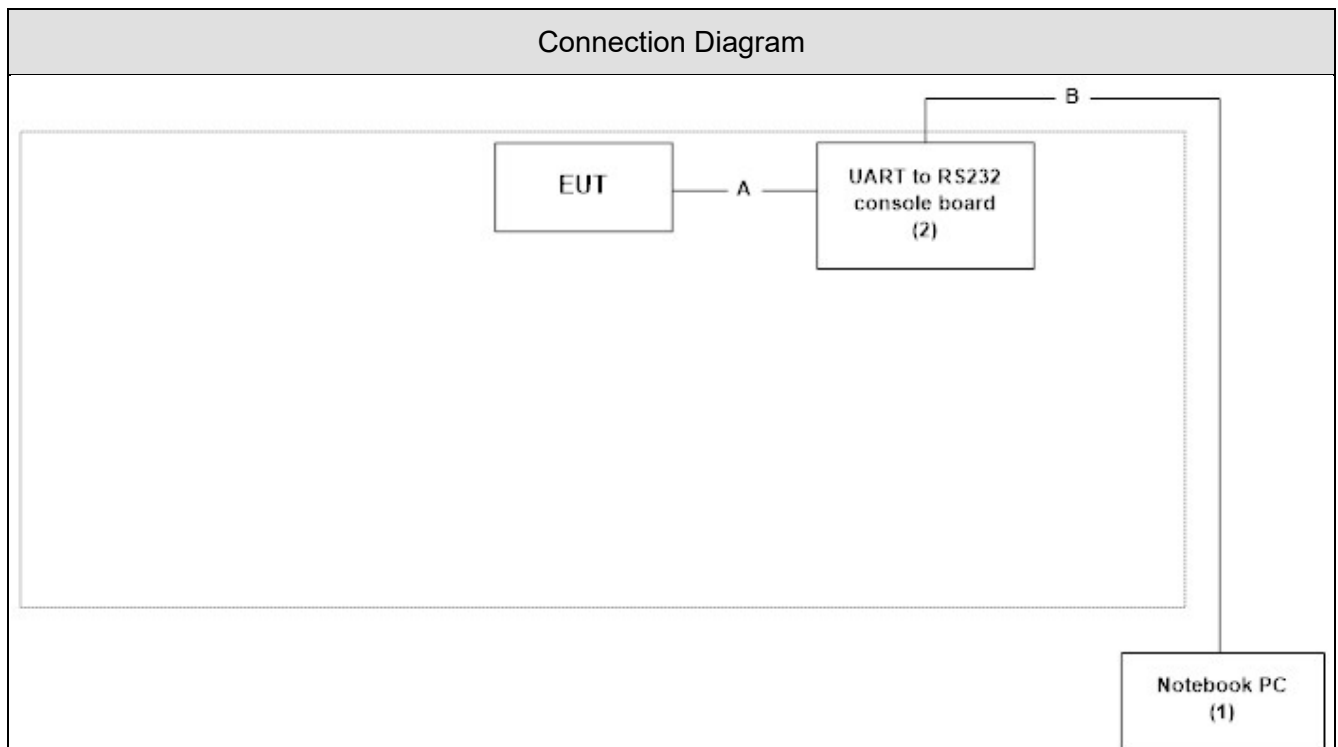

Signal Cable Type	Signal cable Description
A   Signal Cable	Non-Shielded, 0.2m
B   USB to RS232 Cable	Shielded, 10m

### 1.5. EUT Exercise Software

1	Set the EUT as shown.
2	Execute control command by software "TeraTerm".
3	Configure test mode, test channel and data rate.
4	Let the EUT start transmitting signal continuously.
5	Verify that device is working properly.

---

## **1.6. Comments and Remarks**

The product specification and testing instructions for the EUT declared in the report are provided by the manufacturer who will take all responsibilities for the accuracy.

## 1.7. Test Facility

Ambient conditions in the laboratory:

Items	Test Item	Required	Test Site
Temperature (°C)	FCC PART 15 C 15.207	15 - 35	2
Humidity (%RH)	Conducted Emission	25 - 75	
Temperature (°C)	FCC PART 15 C 15.247	15 - 35	1
Humidity (%RH)	Maximum peak conducted output power	25 - 75	
Temperature (°C)	FCC PART 15 C 15.247	15 - 35	1
Humidity (%RH)	Radiated Emission	25 - 75	
Temperature (°C)	FCC PART 15 C 15.247	15 - 35	1
Humidity (%RH)	RF antenna conducted test	25 - 75	
Temperature (°C)	FCC PART 15 C 15.247	15 - 35	1
Humidity (%RH)	Bandedge	25 - 75	
Temperature (°C)	FCC PART 15 C 15.247	15 - 35	1
Humidity (%RH)	Number of hopping Frequency	25 - 75	
Temperature (°C)	FCC PART 15 C 15.247	15 - 35	1
Humidity (%RH)	Carrier Frequency Separation	25 - 75	
Temperature (°C)	FCC PART 15 C 15.247	15 - 35	1
Humidity (%RH)	-20dB Bandwidth	25 - 75	
Temperature (°C)	FCC PART 15 C 15.247	15 - 35	1
Humidity (%RH)	Dwell Time	25 - 75	

Note: Test site information refers to Laboratory Information.

### Laboratory Information

<b>USA</b>	<b>:</b>	<b>FCC Registration Number: TW3024</b>
<b>Canada</b>	<b>:</b>	<b>IC Registration Number: 22397-1 / 22397-2 / 22397-3</b>

The address and introduction of DEKRA Testing and Certification Co., Ltd. laboratories can be founded in our Web site: <http://www.dekra.com.tw>

If you have any comments, please don't hesitate to contact us. Our test sites as below:

Test Laboratory	DEKRA Testing and Certification Co., Ltd.
Address	1. No.372, Sec. 4, Zhongxing Rd., Zhudong Township, Hsinchu County 31061, Taiwan, R.O.C. 2. No.372-2, Sec. 4, Zhongxing Rd., Zhudong Township, Hsinchu County 31061, Taiwan, R.O.C.
Phone number	1. +886-3-582-8001 2. +886-3-582-8001
Fax number	1. +886-3-582-8958 2. +886-3-582-8958
Email address	<a href="mailto:info.tw@dekra.com">info.tw@dekra.com</a>
Website	<a href="http://www.dekra.com.tw">http://www.dekra.com.tw</a>

## 1.8. List of Test Equipment

### Conducted Emission / SR2-H

Instrument	Manufacturer	Model No.	Serial No.	Cal. Date	Next Cal. Date
Artificial Mains Network	R&S	ENV4200	848411/010	2020/12/24	2021/12/23
Test Receiver	R&S	ESCS 30	836858/022	2021/02/22	2022/02/21
LISN	R&S	ENV216	100092	2020/06/22	2021/06/21

### Maximum peak conducted output power / SR12-H

Instrument	Manufacturer	Model No.	Serial No.	Cal. Date	Next Cal. Date
High Speed Peak Power Meter Dual Input	Anritsu	ML2496A	1602004	2020/11/30	2021/11/29
Pulse Power Sensor	Anritsu	MA2411B	1531043	2020/11/30	2021/11/29
Pulse Power Sensor	Anritsu	MA2411B	1531044	2020/11/30	2021/11/29
Power Meter	Keysight	8990B	MY51000248	2020/05/20	2021/05/19
Power Sensor	Keysight	N1923A	MY57240005	2020/05/20	2021/05/19

### Radiated Emission / CB2-H

Instrument	Manufacturer	Model No.	Serial No.	Cal. Date	Next Cal. Date
Signal Analyzer	R&S	FSVA40	101455	2020/10/12	2021/10/11
Signal & Spectrum Analyzer	R&S	FSV40	101049	2021/03/31	2022/03/30
Signal Analyzer	R&S	FSVA40	101435	2020/06/24	2021/06/23
EXA Signal Analyzer	Keysight	N9010A	MY51440132	2021/01/25	2022/01/24
Bilog Antenna	Teseq	CBL6112D	23191	2021/02/26	2022/02/25
Horn Antenna	Schwarzbeck	BBHA 9120D	639	2020/06/04	2021/06/03
Horn Antenna	Schwarzbeck	BBHA 9170	202	2020/12/16	2021/12/15
Pre-Amplifier	EMCI	EMC01820I	980365	2020/06/19	2021/06/18
Pre-Amplifier	EMEC	EM01G18GA	060741	2020/07/24	2021/07/23
Pre-Amplifier	DEKRA	AP-400C	201801231	2020/11/16	2021/11/15
Band Reject Filter	Micro-Tronics	BRM50702	G258	2020/12/16	2021/12/15
Wideband Radio Communication Tester	R&S	CMW500	106071	2021/01/27	2022/01/26
Wireless Conn. Tseter	R&S	CMW500	157118	2020/07/23	2021/07/22
Coaxial Cable(13m)	Huber+Suhner	SF104	CB2-H	2020/07/25	2021/07/24
DEKRA Testing System	DEKRA	Version 2.0	CB2-H	NA	NA

## RF antenna conducted test / SR12-H

Instrument	Manufacturer	Model No.	Serial No.	Cal. Date	Next Cal. Date
Spectrum Analyzer	Keysight	N9030B	MY57140404	2020/06/03	2021/06/02
Spectrum Analyzer	Keysight	N9010B	MY57110159	2021/03/29	2022/03/28
Spectrum Analyzer	Agilent	N9010A	US47140172	2020/06/18	2021/06/17
Signal & Spectrum Analyzer	R&S	FSV40	101049	2021/03/31	2022/03/30

## Bandedge / CB2-H

Instrument	Manufacturer	Model No.	Serial No.	Cal. Date	Next Cal. Date
Signal Analyzer	R&S	FSVA40	101455	2020/10/12	2021/10/11
Signal & Spectrum Analyzer	R&S	FSV40	101049	2021/03/31	2022/03/30
Signal Analyzer	R&S	FSVA40	101435	2020/06/24	2021/06/23
EXA Signal Analyzer	Keysight	N9010A	MY51440132	2021/01/25	2022/01/24
Bilog Antenna	Teseq	CBL6112D	23191	2021/02/26	2022/02/25
Horn Antenna	Schwarzbeck	BBHA 9120D	639	2020/06/04	2021/06/03
Horn Antenna	Schwarzbeck	BBHA 9170	202	2020/12/16	2021/12/15
Pre-Amplifier	EMCI	EMC01820I	980365	2020/06/19	2021/06/18
Pre-Amplifier	EMEC	EM01G18GA	060741	2020/07/24	2021/07/23
Pre-Amplifier	DEKRA	AP-400C	201801231	2020/11/16	2021/11/15
Band Reject Filter	Micro-Tronics	BRM50702	G258	2020/12/16	2021/12/15
Wideband Radio Communication Tester	R&S	CMW500	106071	2021/01/27	2022/01/26
Wireless Conn. Tseter	R&S	CMW500	157118	2020/07/23	2021/07/22
Coaxial Cable(13m)	Huber+Suhner	SF104	CB2-H	2020/07/25	2021/07/24
DEKRA Testing System	DEKRA	Version 2.0	CB2-H	NA	NA

## Number of hopping frequency / SR12-H

Instrument	Manufacturer	Model No.	Serial No.	Cal. Date	Next Cal. Date
Spectrum Analyzer	Keysight	N9030B	MY57140404	2020/06/03	2021/06/02
Spectrum Analyzer	Keysight	N9010B	MY57110159	2021/03/29	2022/03/28
Spectrum Analyzer	Agilent	N9010A	US47140172	2020/06/18	2021/06/17
Signal & Spectrum Analyzer	R&S	FSV40	101049	2021/03/31	2022/03/30

## Carrier Frequency Separation / SR12-H

Instrument	Manufacturer	Model No.	Serial No.	Cal. Date	Next Cal. Date
Spectrum Analyzer	Keysight	N9030B	MY57140404	2020/06/03	2021/06/02
Spectrum Analyzer	Keysight	N9010B	MY57110159	2021/03/29	2022/03/28
Spectrum Analyzer	Agilent	N9010A	US47140172	2020/06/18	2021/06/17
Signal & Spectrum Analyzer	R&S	FSV40	101049	2021/03/31	2022/03/30

## -20dB Bandwidth / SR12-H

Instrument	Manufacturer	Model No.	Serial No.	Cal. Date	Next Cal. Date
Spectrum Analyzer	Keysight	N9030B	MY57140404	2020/06/03	2021/06/02
Spectrum Analyzer	Keysight	N9010B	MY57110159	2021/03/29	2022/03/28
Spectrum Analyzer	Agilent	N9010A	US47140172	2020/06/18	2021/06/17
Signal & Spectrum Analyzer	R&S	FSV40	101049	2021/03/31	2022/03/30

## Dwell Time / SR12-H

Instrument	Manufacturer	Model No.	Serial No.	Cal. Date	Next Cal. Date
Spectrum Analyzer	Keysight	N9030B	MY57140404	2020/06/03	2021/06/02
Spectrum Analyzer	Keysight	N9010B	MY57110159	2021/03/29	2022/03/28
Spectrum Analyzer	Agilent	N9010A	US47140172	2020/06/18	2021/06/17
Signal & Spectrum Analyzer	R&S	FSV40	101049	2021/03/31	2022/03/30

Note: All equipment upon which need to calibrated are with calibration period of 1 year.

## 1.9. Uncertainty

Test item	Uncertainty
Conducted Emission	$\pm 2.26$ dB
Maximum peak conducted output power	$\pm 1.27$ dB
Radiated Emission	30MHz~1GHz as $\pm 3.43$ dB 1GHz~26.5GHz as $\pm 3.65$ dB
RF antenna conducted test	$\pm 1.27$ dB
Bandedge	$\pm 1.27$ dB
Number of hopping frequency	$\pm 1.27$ dB
Carrier Frequency Separation	$\pm 50$ Hz
-20dB Bandwidth	$\pm 50$ Hz
Dwell Time	$\pm 25$ msec

### 1.10. Duty Cycle

Mode	On Time (ms)	On+Off Time (ms)	Duty Cycle (%)	Duty Factor (dB) linear voltage	Duty Factor (dB) Power	1/T Minimum VBW (kHz)
DH5	2.882	3.728	77.31%	2.235639	1.12	0.347
3-DH5	2.881	3.736	77.11%	2.257272	1.13	0.347

#### DH5

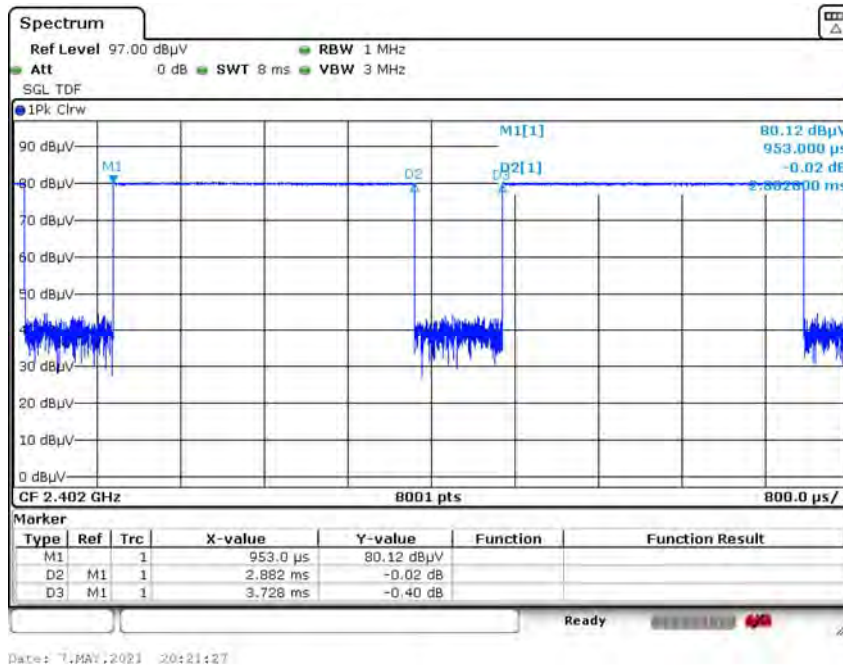

#### 3DH5

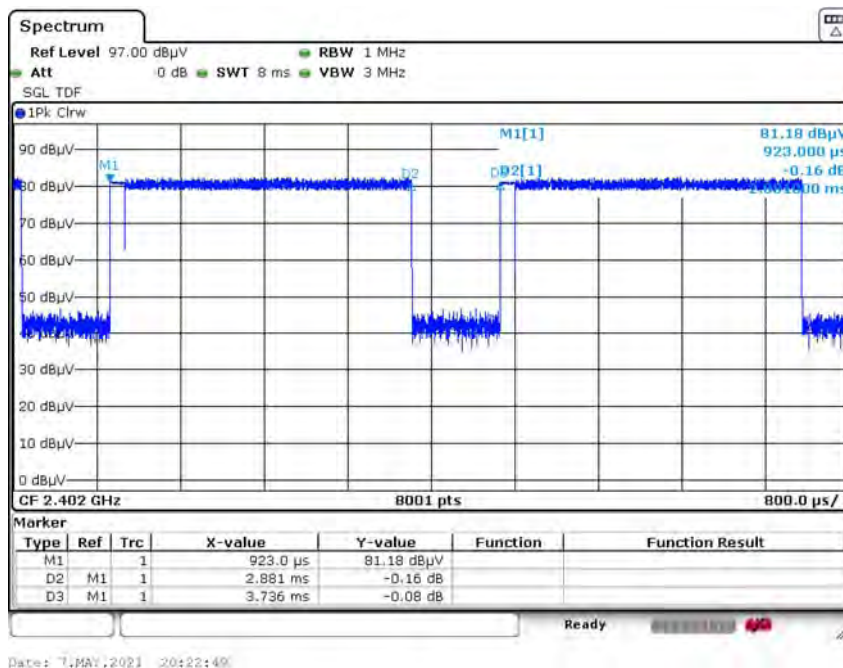

## 2. Conducted Emission

### 2.1. Test Setup

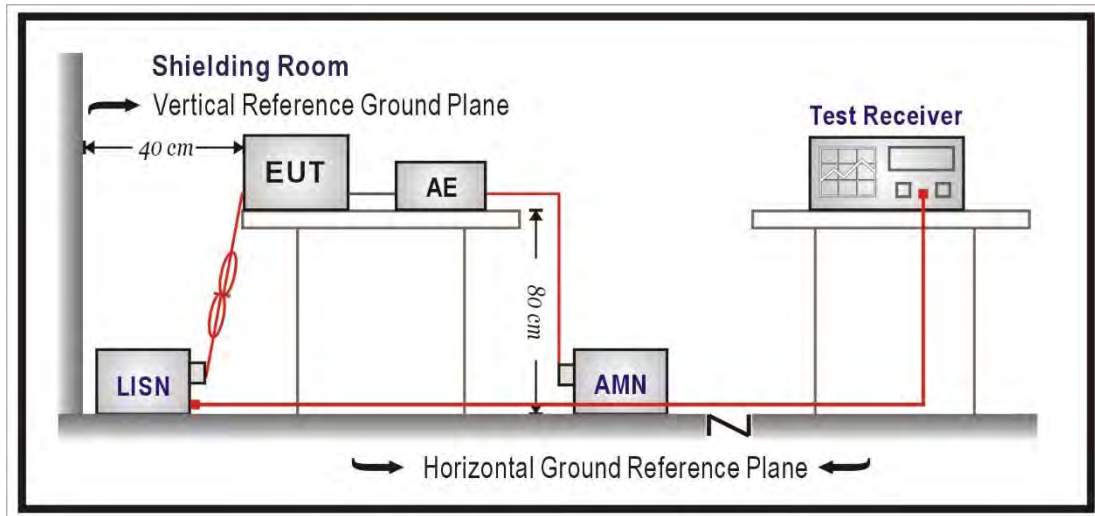

### 2.2. Limits

FCC Part 15 Subpart C Paragraph 15.207 Limits (dBuV)		
Frequency	QP	AV
0.15 - 0.50	66 - 56	56 - 46
0.50 - 5.0	56	46
5.0 - 30	60	50

Remarks: In the above table, the tighter limit applies at the band edges.

### 2.3. Test Procedure

The EUT and simulators are connected to the main power through a line impedance stabilization network (L.I.S.N.). This provides a 50 ohm /50uH coupling impedance for the measuring equipment. The peripheral devices are also connected to the main power through a LISN that provides a 50ohm /50uH coupling impedance with 50ohm termination. (Please refer to the block diagram of the test setup and photographs.)

Both sides of A.C. line are checked for maximum conducted interference. In order to find the maximum emission, the relative positions of equipment and all of the interface cables must be changed according to ANSI C63.10: 2013 on conducted measurement.

Conducted emissions were investigated over the frequency range from 0.15MHz to 30MHz using a receiver bandwidth of 9 kHz.

### 2.4. Test Specification

According to FCC Part 15 Subpart C Paragraph 15.207: 2019



## 2.5. Test Result

Model No	LVD1	Site	SR2-H
Test Voltage	AC 120V/60Hz	Test Date	2021/5/25
Test Mode	Mode 1: Transmit Adapter ADP-36DW B	Engineer	Lion Wang
Phase	L	Temperature (°C)	26.7
Test Condition	BT 2.0,DH5,Ch 0,2.402G	Humidity (%RH)	57.8

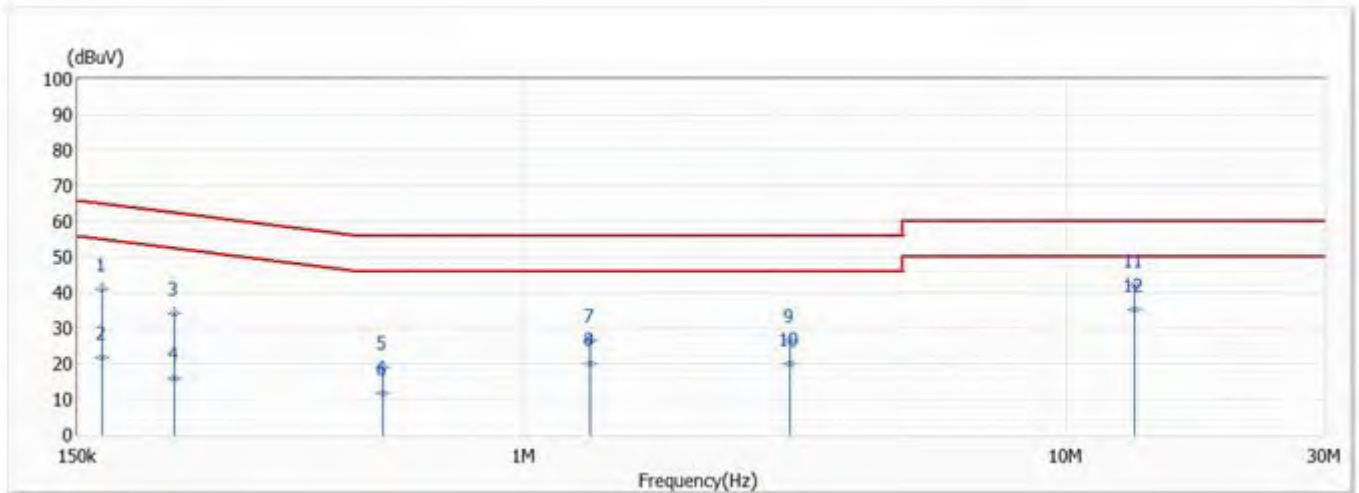

No	Frequency (MHz)	Emission Level (dBuV)	Limit (dBuV)	Margin (dB)	Reading Level (dBuV)	Correct Factor (dB)	Detector Type
1	0.166	41.15	65.14	-23.99	31.50	9.65	QP
2	0.166	21.82	55.14	-33.32	12.17	9.65	AV
3	0.226	34.02	62.59	-28.57	24.37	9.65	QP
4	0.226	15.95	52.59	-36.64	6.30	9.65	AV
5	0.549	18.95	56.00	-37.05	9.26	9.69	QP
6	0.549	11.63	46.00	-34.37	1.94	9.69	AV
7	1.321	26.54	56.00	-29.46	16.78	9.76	QP
8	1.321	20.08	46.00	-25.92	10.32	9.76	AV
9	3.095	26.64	56.00	-29.36	16.80	9.84	QP
10	3.095	20.13	46.00	-25.87	10.29	9.84	AV
11	13.347	41.99	60.00	-18.01	31.77	10.22	QP
*12	13.347	35.07	50.00	-14.93	24.85	10.22	AV

Remark:

1. "\*" means this data is the worst emission level.
2. Emission Level = Reading Level + Correct Factor (Correct Factor = LISN Insertion Loss + Cable Loss).
3. Margin = Emission Level - Limit.

Model No	LVD1	Site	SR2-H
Test Voltage	AC 120V/60Hz	Test Date	2021/5/25
Test Mode	Mode 1: Transmit Adapter ADP-36DW B	Engineer	Lion Wang
Phase	N	Temperature (°C)	26.7
Test Condition	BT 2.0,DH5,Ch 0,2.402G	Humidity (%RH)	57.8

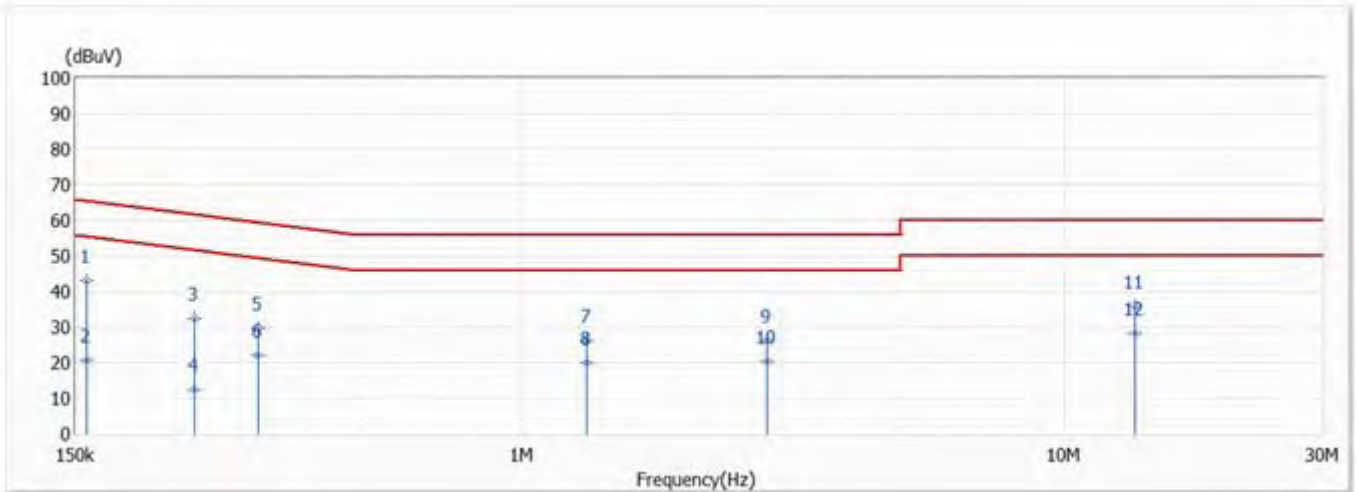

No	Frequency (MHz)	Emission Level (dBuV)	Limit (dBuV)	Margin (dB)	Reading Level (dBuV)	Correct Factor (dB)	Detector Type
1	0.157	43.12	65.62	-22.50	33.48	9.64	QP
2	0.157	20.79	55.62	-34.83	11.15	9.64	AV
3	0.249	32.32	61.79	-29.47	22.68	9.64	QP
4	0.249	12.46	51.79	-39.33	2.82	9.64	AV
5	0.327	29.64	59.53	-29.89	19.98	9.66	QP
6	0.327	22.17	49.53	-27.36	12.51	9.66	AV
7	1.320	26.31	56.00	-29.69	16.57	9.74	QP
8	1.320	20.09	46.00	-25.91	10.35	9.74	AV
9	2.826	26.06	56.00	-29.94	16.24	9.82	QP
10	2.826	20.35	46.00	-25.65	10.53	9.82	AV
11	13.521	35.75	60.00	-24.25	25.47	10.28	QP
*12	13.521	28.13	50.00	-21.87	17.85	10.28	AV

Remark:

1. "\*" means this data is the worst emission level.
2. Emission Level = Reading Level + Correct Factor (Correct Factor = LISN Insertion Loss + Cable Loss).
3. Margin = Emission Level - Limit.

Model No	LVD1	Site	SR2-H
Test Voltage	AC 120V/60Hz	Test Date	2021/5/25
Test Mode	Mode 2: Transmit Adapter_1A100-US1230	Engineer	Lion Wang
Phase	L	Temperature (°C)	26.7
Test Condition	BT 2.0,DH5,Ch 0,2.402G	Humidity (%RH)	57.8

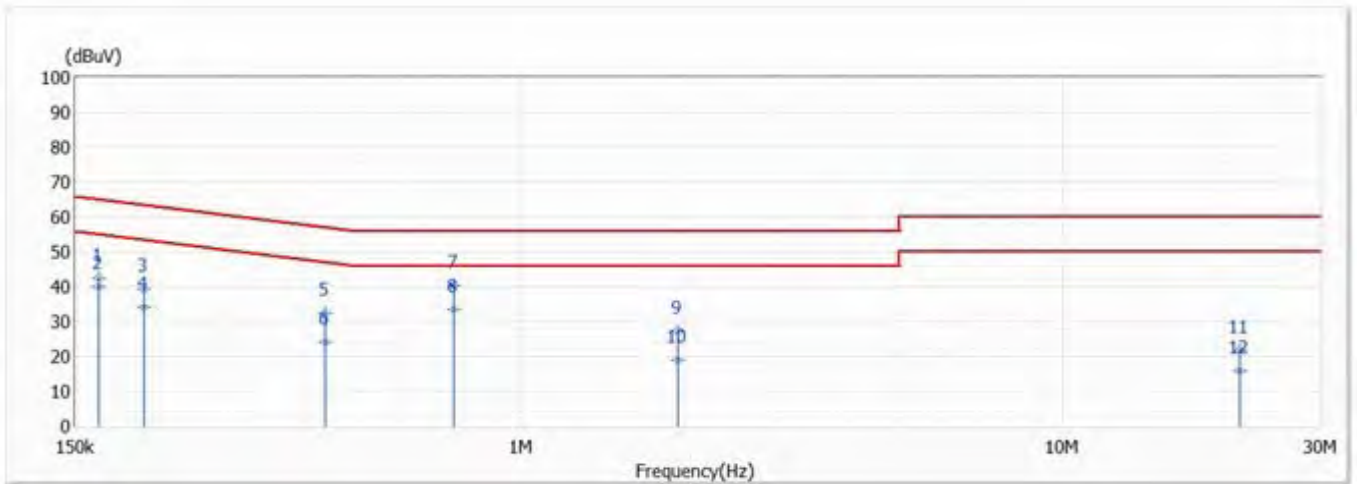

No	Frequency (MHz)	Emission Level (dBuV)	Limit (dBuV)	Margin (dB)	Reading Level (dBuV)	Correct Factor (dB)	Detector Type
1	0.166	42.49	65.18	-22.69	32.84	9.65	QP
2	0.166	40.15	55.18	-15.03	30.50	9.65	AV
3	0.201	39.14	63.56	-24.42	29.49	9.65	QP
4	0.201	34.01	53.56	-19.55	24.36	9.65	AV
5	0.433	32.38	57.19	-24.81	22.70	9.68	QP
6	0.433	24.30	47.19	-22.89	14.62	9.68	AV
7	0.749	40.30	56.00	-15.70	30.58	9.72	QP
*8	0.749	33.55	46.00	-12.45	23.83	9.72	AV
9	1.945	27.28	56.00	-28.72	17.49	9.79	QP
10	1.945	19.04	46.00	-26.96	9.25	9.79	AV
11	21.218	21.88	60.00	-38.12	11.49	10.39	QP
12	21.218	15.80	50.00	-34.20	5.41	10.39	AV

Remark:

1. "\*" means this data is the worst emission level.
2. Emission Level = Reading Level + Correct Factor (Correct Factor = LISN Insertion Loss + Cable Loss).
3. Margin = Emission Level - Limit.

Model No	LVD1	Site	SR2-H
Test Voltage	AC 120V/60Hz	Test Date	2021/5/25
Test Mode	Mode 2: Transmit Adapter_1A100-US1230	Engineer	Lion Wang
Phase	N	Temperature (°C)	26.7
Test Condition	BT 2.0,DH5,Ch 0,2.402G	Humidity (%RH)	57.8

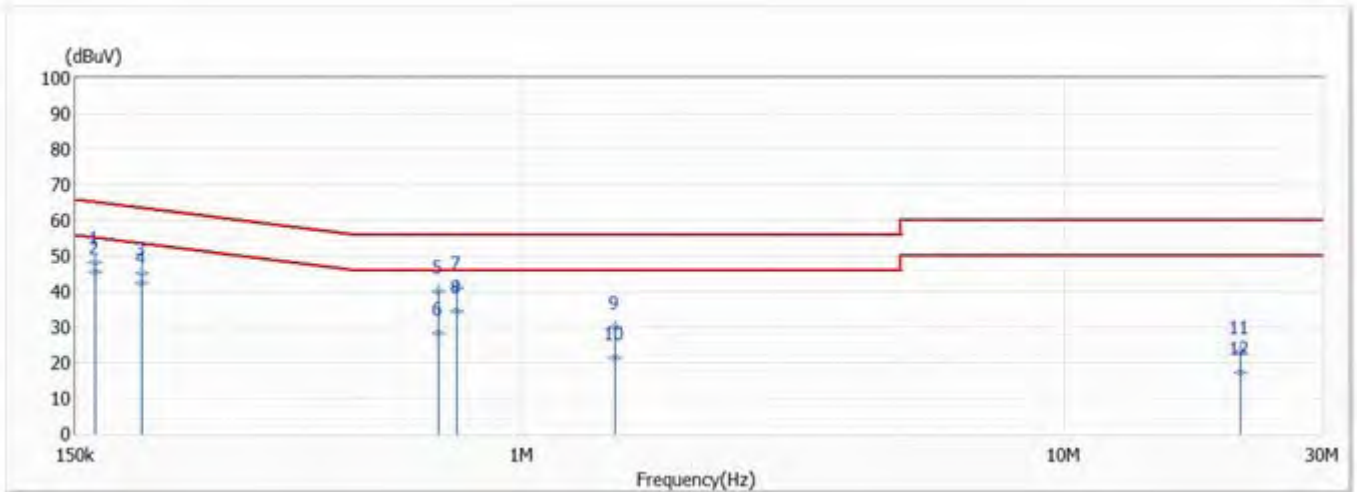

No	Frequency (MHz)	Emission Level (dBuV)	Limit (dBuV)	Margin (dB)	Reading Level (dBuV)	Correct Factor (dB)	Detector Type
1	0.163	48.38	65.32	-16.94	38.74	9.64	QP
*2	0.163	45.62	55.32	-9.70	35.98	9.64	AV
3	0.198	45.23	63.67	-18.44	35.59	9.64	QP
4	0.198	42.43	53.67	-11.24	32.79	9.64	AV
5	0.701	40.01	56.00	-15.99	30.31	9.70	QP
6	0.701	28.36	46.00	-17.64	18.66	9.70	AV
7	0.760	41.12	56.00	-14.88	31.42	9.70	QP
8	0.760	34.46	46.00	-11.54	24.76	9.70	AV
9	1.485	29.98	56.00	-26.02	20.24	9.74	QP
10	1.485	21.52	46.00	-24.48	11.78	9.74	AV
11	21.146	23.10	60.00	-36.90	12.55	10.55	QP
12	21.146	17.21	50.00	-32.79	6.66	10.55	AV

Remark:

1. "\*" means this data is the worst emission level.
2. Emission Level = Reading Level + Correct Factor (Correct Factor = LISN Insertion Loss + Cable Loss).
3. Margin = Emission Level - Limit.

### 3. Maximum peak conducted output power

#### 3.1. Test Setup

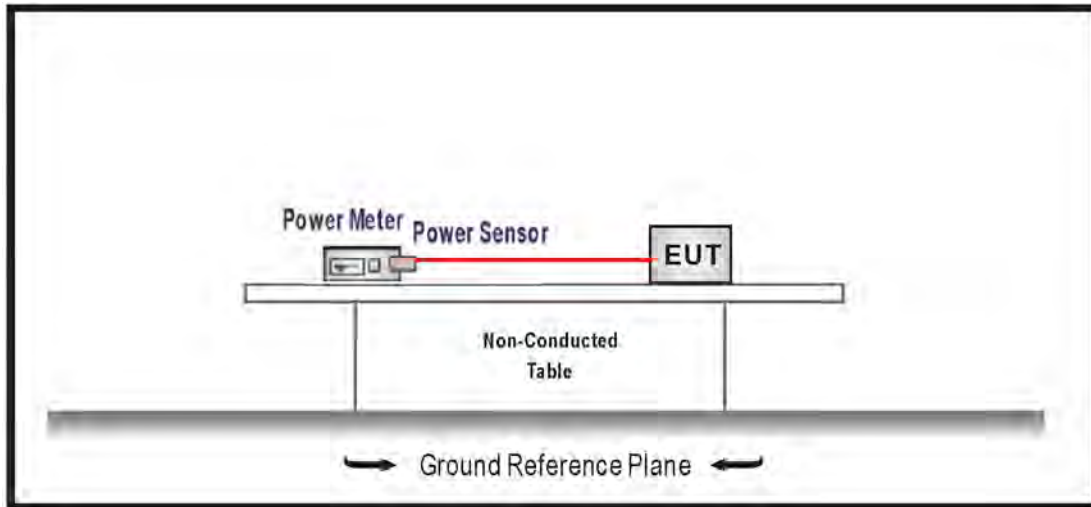

#### 3.2. Test procedures

The EUT was setup according to ANSI C63.10: 2013 and tested according to FHSS test procedure of FCC KDB 558074 D01 v05r02 for compliance to FCC 47CFR 15.247 requirements

#### 3.3. Limits

For frequency hopping systems operating in the 902-928 MHz band: 1 Watt for systems employing at least 50 hopping channels; and, 0.25 Watts for systems employing less than 50 hopping channels.

For frequency hopping systems operating in the 2400-2483.5 MHz band employing at least 75 non-overlapping hopping channels, and all frequency hopping systems in the 5725-5850 MHz band: 1 watt. For all other frequency hopping systems in the 2400-2483.5 MHz band: 0.125 watts.

#### 3.4. Test Specification

According to FCC Part 15 Subpart C Paragraph 15.247: 2019.

### 3.5. Test Result

Product	Smart Display		
Test Item	Maximum peak conducted output power		
Test Mode	Mode 2: Transmit_Adapter_1A100-US1230		
Date of Test	2021/05/12	Test Site	SR12-H
Temperature(°C)	24.0	Humidity (%RH)	68.0

#### GFSK

Channel No.	Frequency (MHz)	Measure Level (dBm)	Limit (dBm)
00	2402	2.540	≤30
39	2441	2.580	≤30
78	2480	2.380	≤30

#### 8-DPSK

Channel No.	Frequency (MHz)	Measure Level (dBm)	Limit (dBm)
00	2402	3.190	≤30
39	2441	3.180	≤30
78	2480	2.740	≤30

#### 4. Radiated Emission

##### 4.1. Test Setup

Under 30MHz Test Setup:

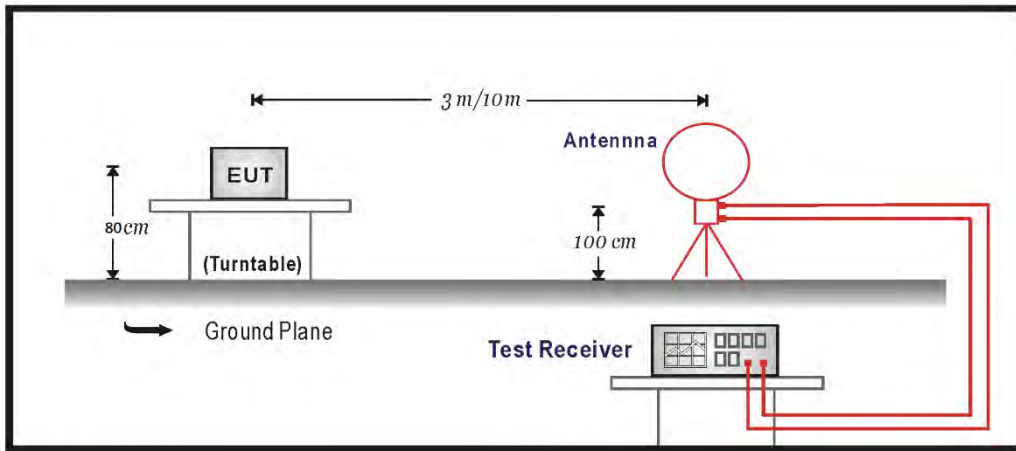

Under 1GHz Test Setup:

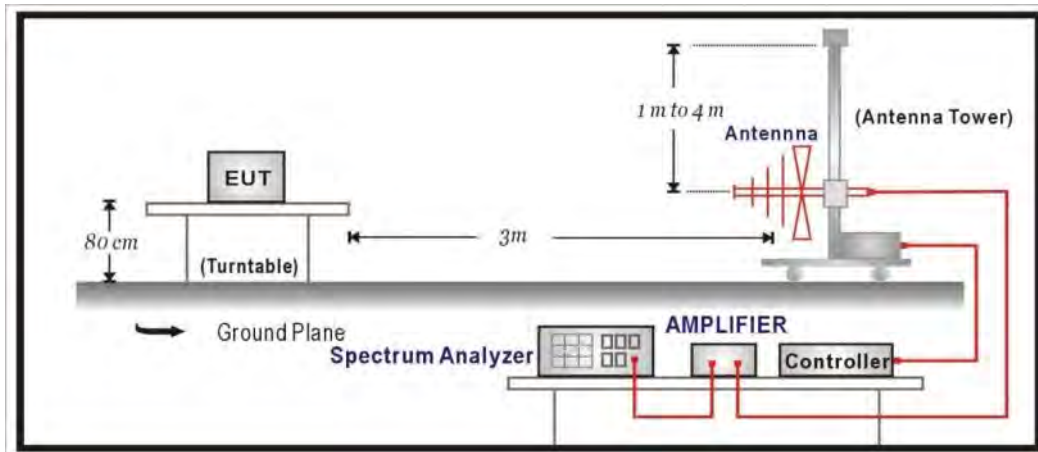

Above 1GHz Test Setup:

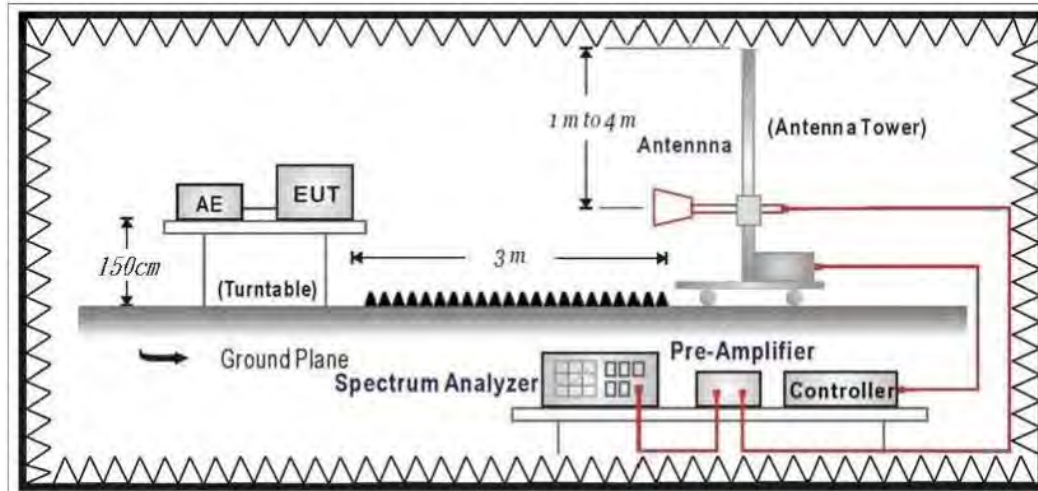

## 4.2. Limits

Emissions radiated outside of the specified frequency bands, except for harmonics, shall be attenuated by at least 20dB below the level of the fundamental or to the general radiated emission limits in paragraph 15.209, whichever is the lesser attenuation.

<b>FCC Part 15 Subpart C Paragraph 15.209 Limits</b>		
Frequency (MHz)	uV/m	dBuV/m
30-88	100	40
88-216	150	43.5
216-960	200	46
Above 960	500	54

- Remarks:
1. RF Voltage (dBuV) = 20 log RF Voltage (uV)
  2. In the Above Table, the tighter limit applies at the band edges.
  3. Distance refers to the distance in meters between the measuring instrument antenna and the closed point of any part of the device or system.



### **4.3. Test Procedure**

The EUT was setup according to ANSI C63.10: 2013 and tested according to FHSS test procedure of FCC KDB 558074 D01 v05r02 for compliance to FCC 47CFR 15.247 requirements.

The EUT and its simulators are placed on a turn table which is 0.8 or 1.5 meter above ground. The turn table can rotate 360 degrees to determine the position of the maximum emission level.

The antenna can move up and down between 1 meter and 4 meters to find out the maximum emission level.

Both horizontal and vertical polarization of the antenna are set on measurement. In order to find the maximum emission, all of the interface cables must be manipulated according to ANSI C63.10: 2013 on radiated measurement.

On any frequency or frequencies from 9KHz (include The the lowest oscillator frequency generated within the device up to the 10th harmonic) to 1000 MHz, the limits shown are based on measuring equipment employing a quasi-peak detector function and on any frequency or frequencies above 1000 MHz the radiated limits shown are based upon the use of measurement instrumentation employing an average detector function. When average radiated emission measurement are included emission measurement below 1000 MHz, there also is a limit on the radio frequency emissions, as measured using instrumentation with a peak detector function, corresponding to 20 dB above the maximum permitted average limit.

The bandwidth below 1GHz setting on the field strength meter is 120 kHz and above 1GHz is 1MHz.

### **4.4. Test Specification**

According to FCC Part 15 Subpart C Paragraph 15.247: 2019

### 4.5. Test Result

#### 30 MHz – 1 GHz

Model No	LVD1	Site	CB2-H
Test Voltage	AC 120V/60Hz	Test Date	2021/5/25
Test Mode	Mode 1: Transmit_Adapter_ADP-36DW B	Engineer	Scott Chang
Polarity	Horizontal	Temperature (°C)	24.0
Test Condition	BT 2.0,DH5,Ch 0,2.402G	Humidity (%RH)	66.0

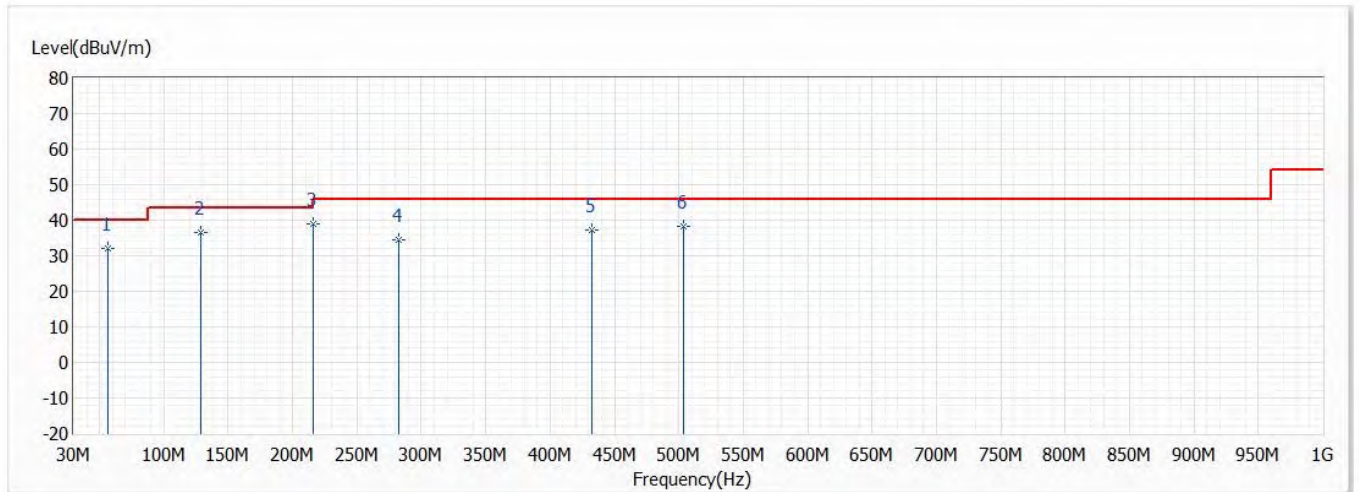

No	Frequency (MHz)	Emission Level (dBuV/m)	Limit (dBuV/m)	Margin (dB)	Reading Level (dBuV)	Correct Factor (dB)	Detector Type
1	56.675	31.92	40.00	-8.08	39.58	-7.66	QP
2	128.940	36.59	43.50	-6.91	39.20	-2.61	QP
* 3	215.755	39.04	43.50	-4.46	43.00	-3.96	QP
4	282.200	34.55	46.00	-11.45	36.06	-1.51	QP
5	432.065	37.34	46.00	-8.66	34.73	2.61	QP
6	503.845	38.44	46.00	-7.56	34.62	3.82	QP

Note:

1. All reading levels is Quasi-Peak value.
2. “ \* ”, means this data is the worst value.
3. Emission Level = Reading Level + Correct Factor
4. The emission under 30MHz were not included is because their levels are lower than 20dB from limit.

Model No	LVD1	Site	CB2-H
Test Voltage	AC 120V/60Hz	Test Date	2021/5/25
Test Mode	Mode 1: Transmit Adapter ADP-36DW B	Engineer	Scott Chang
Polarity	Vertical	Temperature (°C)	24.0
Test Condition	BT 2.0,DH5,Ch 0,2.402G	Humidity (%RH)	66.0

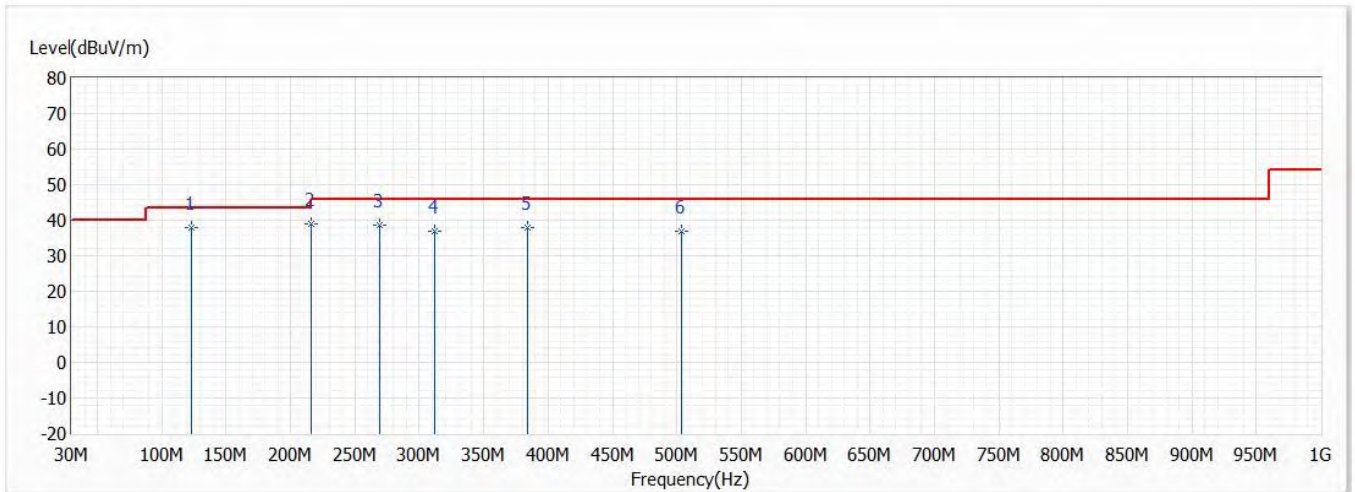

No	Frequency (MHz)	Emission Level (dBuV/m)	Limit (dBuV/m)	Margin (dB)	Reading Level (dBuV)	Correct Factor (dB)	Detector Type
1	122.635	37.89	43.50	-5.61	40.34	-2.45	QP
* 2	215.755	38.92	43.50	-4.58	42.88	-3.96	QP
3	269.105	38.55	46.00	-7.45	40.27	-1.72	QP
4	311.785	36.91	46.00	-9.09	37.75	-0.84	QP
5	384.050	37.96	46.00	-8.04	36.45	1.51	QP
6	503.845	37.02	46.00	-8.98	33.20	3.82	QP

Note:

1. All reading levels is Quasi-Peak value.
2. “ \* ”, means this data is the worst value.
3. Emission Level = Reading Level + Correct Factor
4. The emission under 30MHz were not included is because their levels are lower than 20dB from limit.

Model No	LVD1	Site	CB2-H
Test Voltage	AC 120V/60Hz	Test Date	2021/5/24
Test Mode	Mode 2: Transmit Adapter_1A100-US1230	Engineer	Scott Chang
Polarity	Horizontal	Temperature (°C)	24.0
Test Condition	BT 2.0,DH5,Ch 0,2.402G	Humidity (%RH)	66.0

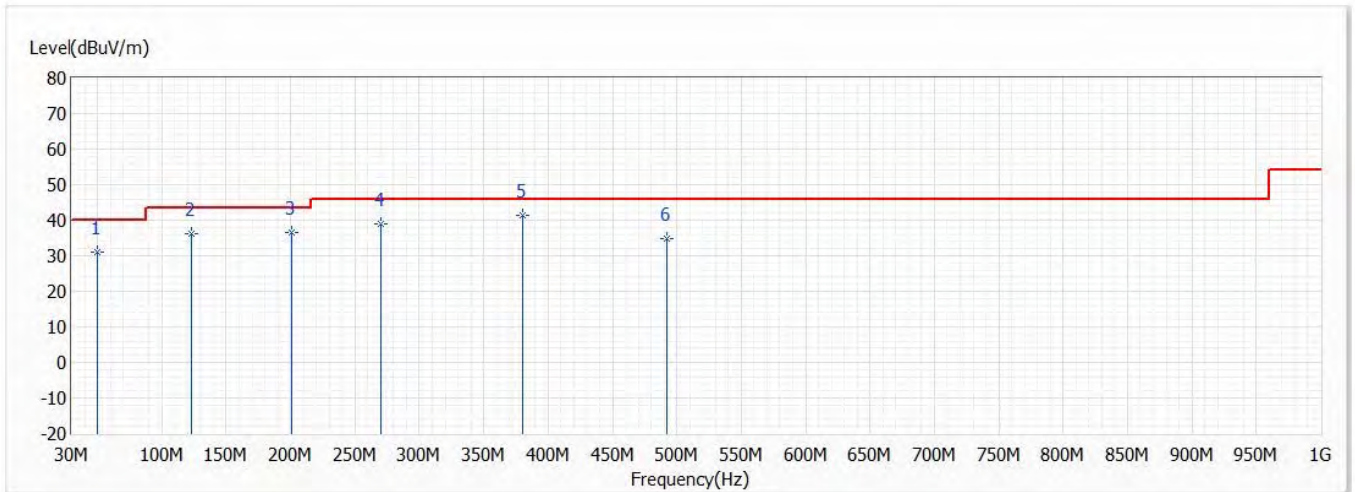

No	Frequency (MHz)	Emission Level (dBuV/m)	Limit (dBuV/m)	Margin (dB)	Reading Level (dBuV)	Correct Factor (dB)	Detector Type
1	50.370	31.15	40.00	-8.85	36.88	-5.73	QP
2	123.120	36.28	43.50	-7.22	38.74	-2.46	QP
3	200.720	36.60	43.50	-6.90	41.40	-4.80	QP
4	270.075	38.84	46.00	-7.16	40.55	-1.71	QP
* 5	380.655	41.27	46.00	-4.73	39.87	1.40	QP
6	492.205	34.86	46.00	-11.14	31.21	3.65	QP

Note:

1. All reading levels is Quasi-Peak value.
2. “ \* ”, means this data is the worst value.
3. Emission Level = Reading Level + Correct Factor
4. The emission under 30MHz were not included is because their levels are lower than 20dB from limit.

Model No	LVD1	Site	CB2-H
Test Voltage	AC 120V/60Hz	Test Date	2021/5/24
Test Mode	Mode 2: Transmit Adapter_1A100-US1230	Engineer	Scott Chang
Polarity	Vertical	Temperature (°C)	24.0
Test Condition	BT 2.0,DH5,Ch 0,2.402G	Humidity (%RH)	66.0

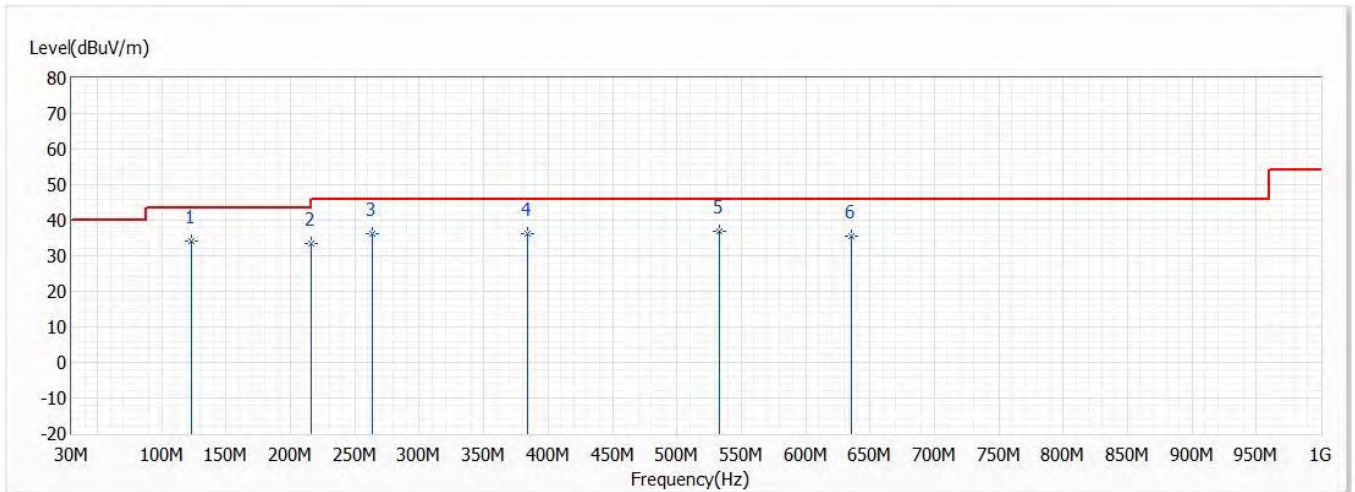

No	Frequency (MHz)	Emission Level (dBuV/m)	Limit (dBuV/m)	Margin (dB)	Reading Level (dBuV)	Correct Factor (dB)	Detector Type
1	123.120	34.29	43.50	-9.21	36.75	-2.46	QP
2	215.755	33.43	43.50	-10.07	37.39	-3.96	QP
3	263.770	36.36	46.00	-9.64	38.18	-1.82	QP
4	384.050	36.26	46.00	-9.74	34.75	1.51	QP
* 5	533.430	36.91	46.00	-9.09	32.71	4.20	QP
6	635.765	35.35	46.00	-10.65	29.91	5.44	QP

Note:

1. All reading levels is Quasi-Peak value.
2. “ \* ”, means this data is the worst value.
3. Emission Level = Reading Level + Correct Factor
4. The emission under 30MHz were not included is because their levels are lower than 20dB from limit.

**Above 1 GHz**

Model No	LVD1	Site	CB2-H
Test Voltage	AC 120V/60Hz	Test Date	2021/5/7
Test Mode	Mode 2: Transmit Adapter_1A100-US1230	Engineer	Rueyyan Lin
Polarity	Horizontal	Temperature (°C)	24.0
Test Condition	BT 2.0,DH5,Ant0,Ch 0,2.402G	Humidity (%RH)	63.0

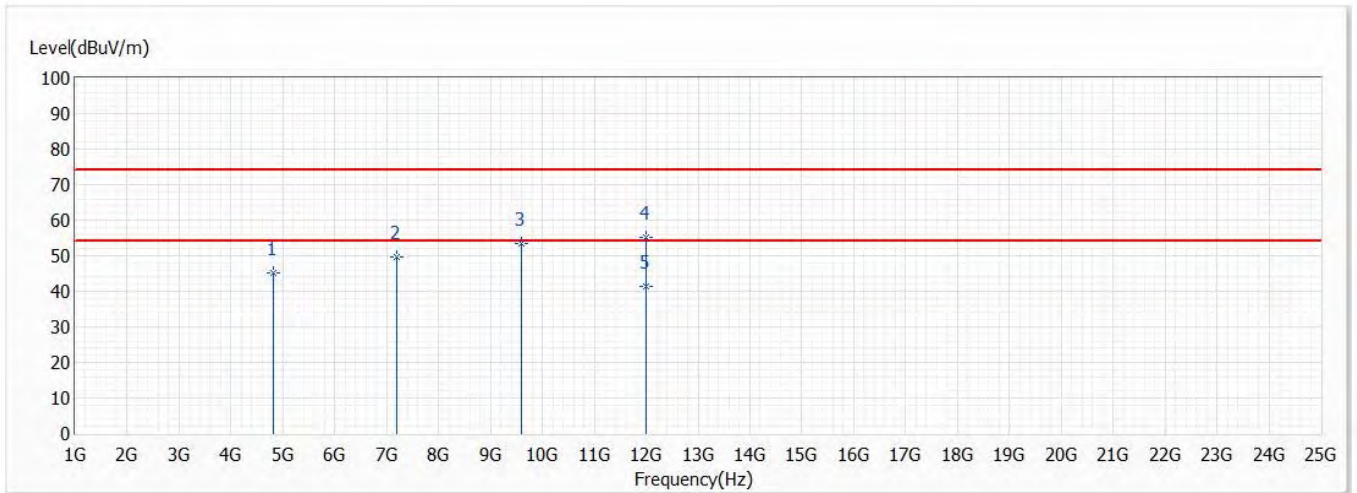

No	Frequency (MHz)	Emission Level (dBuV/m)	Limit (dBuV/m)	Margin (dB)	Reading Level (dBuV)	Correct Factor (dB)	Detector Type
1	4804.000	45.09	74.00	-28.91	57.12	-12.03	PK
2	7206.000	49.81	74.00	-24.19	54.49	-4.68	PK
3	9608.000	53.33	74.00	-20.67	54.66	-1.33	PK
4	12010.000	55.10	74.00	-18.90	52.29	2.81	PK
* 5	12010.000	41.46	54.00	-12.54	38.65	2.81	AV

**Note:**

1. All reading above 1GHz is performed with peak and/or average measurements as necessary.
2. “ \* ”, means this data is the worst value.
3. Emission Level = Reading Level + Correct Factor.
4. The average measurement was not performed when the peak measured data under the limit of average detection.
5. The emission above 13GHz were not included is because their levels are lower than 20dB form limit.

Model No	LVD1	Site	CB2-H
Test Voltage	AC 120V/60Hz	Test Date	2021/5/7
Test Mode	Mode 2: Transmit Adapter_1A100-US1230	Engineer	Rueyyan Lin
Polarity	Vertical	Temperature (°C)	24.0
Test Condition	BT 2.0,DH5,Ant0,Ch 0,2.402G	Humidity (%RH)	63.0

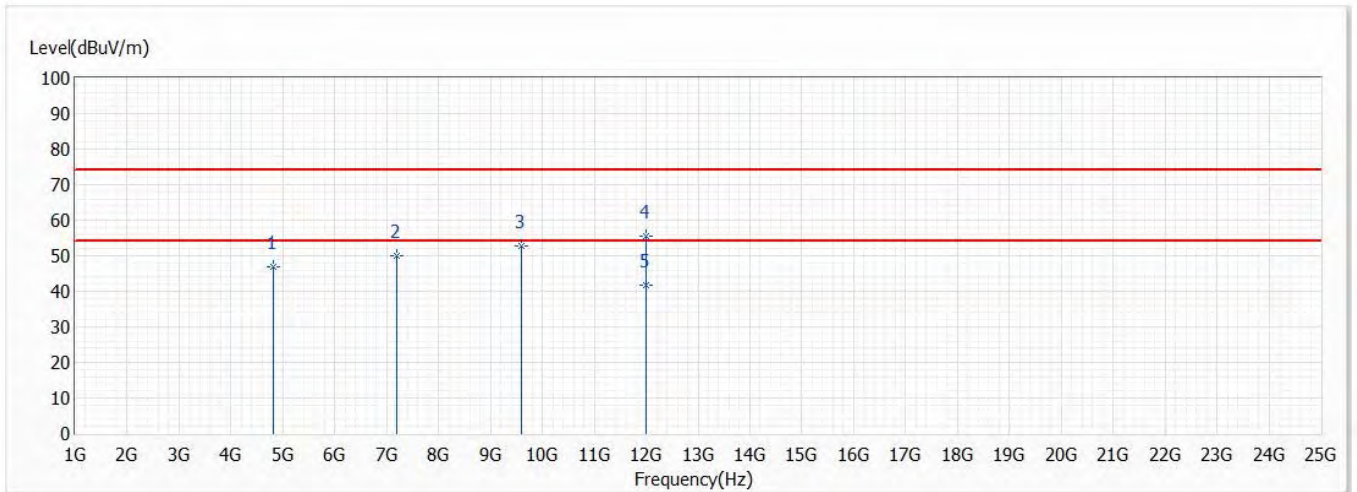

No	Frequency (MHz)	Emission Level (dBuV/m)	Limit (dBuV/m)	Margin (dB)	Reading Level (dBuV)	Correct Factor (dB)	Detector Type
1	4804.000	46.84	74.00	-27.16	58.87	-12.03	PK
2	7206.000	50.15	74.00	-23.85	54.83	-4.68	PK
3	9608.000	52.77	74.00	-21.23	54.10	-1.33	PK
4	12010.000	55.55	74.00	-18.45	52.74	2.81	PK
* 5	12010.000	41.80	54.00	-12.20	38.99	2.81	AV

**Note:**

1. All reading above 1GHz is performed with peak and/or average measurements as necessary.
2. “ \* ”, means this data is the worst value.
3. Emission Level = Reading Level + Correct Factor.
4. The average measurement was not performed when the peak measured data under the limit of average detection.
5. The emission above 13GHz were not included is because their levels are lower than 20dB form limit.

Model No	LVD1	Site	CB2-H
Test Voltage	AC 120V/60Hz	Test Date	2021/5/7
Test Mode	Mode 2: Transmit Adapter_1A100-US1230	Engineer	Rueyyan Lin
Polarity	Horizontal	Temperature (°C)	24.0
Test Condition	BT 2.0,DH5,Ant0,Ch 39,2.441G	Humidity (%RH)	63.0

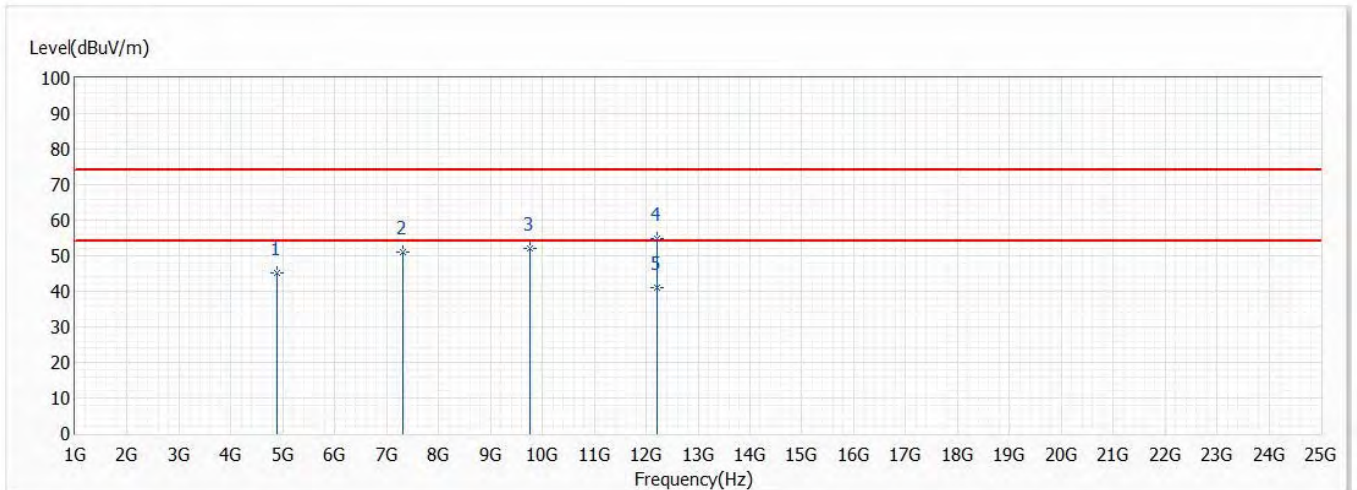

No	Frequency (MHz)	Emission Level (dBuV/m)	Limit (dBuV/m)	Margin (dB)	Reading Level (dBuV)	Correct Factor (dB)	Detector Type
1	4882.000	45.12	74.00	-28.88	56.95	-11.83	PK
2	7323.000	50.96	74.00	-23.04	55.31	-4.35	PK
3	9764.000	52.12	74.00	-21.88	53.39	-1.27	PK
4	12205.000	54.72	74.00	-19.28	52.14	2.58	PK
* 5	12205.000	41.09	54.00	-12.91	38.51	2.58	AV

**Note:**

1. All reading above 1GHz is performed with peak and/or average measurements as necessary.
2. “ \* ”, means this data is the worst value.
3. Emission Level = Reading Level + Correct Factor.
4. The average measurement was not performed when the peak measured data under the limit of average detection.
5. The emission above 13GHz were not included is because their levels are lower than 20dB form limit.



Model No	LVD1	Site	CB2-H
Test Voltage	AC 120V/60Hz	Test Date	2021/5/8
Test Mode	Mode 2: Transmit Adapter_1A100-US1230	Engineer	Rueyyan Lin
Polarity	Vertical	Temperature (°C)	24.0
Test Condition	BT 2.0,DH5,Ant0,Ch 39,2.441G	Humidity (%RH)	63.0

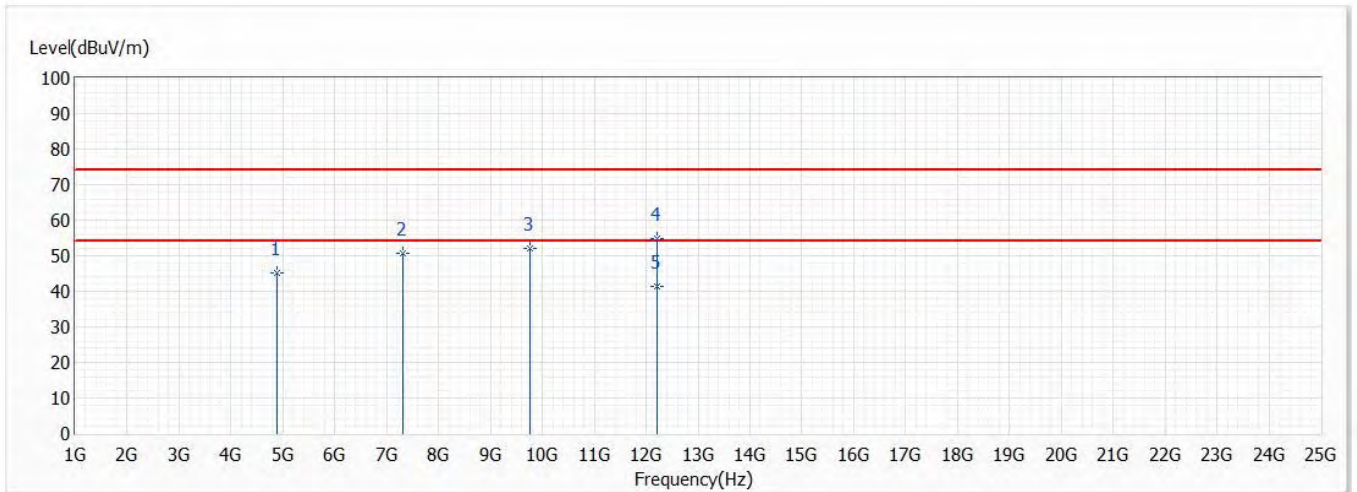

No	Frequency (MHz)	Emission Level (dBuV/m)	Limit (dBuV/m)	Margin (dB)	Reading Level (dBuV)	Correct Factor (dB)	Detector Type
1	4882.000	45.19	74.00	-28.81	57.02	-11.83	PK
2	7323.000	50.80	74.00	-23.20	55.15	-4.35	PK
3	9764.000	51.92	74.00	-22.08	53.19	-1.27	PK
4	12205.000	54.67	74.00	-19.33	52.09	2.58	PK
* 5	12205.000	41.42	54.00	-12.58	38.84	2.58	AV

**Note:**

1. All reading above 1GHz is performed with peak and/or average measurements as necessary.
2. “ \* ”, means this data is the worst value.
3. Emission Level = Reading Level + Correct Factor.
4. The average measurement was not performed when the peak measured data under the limit of average detection.
5. The emission above 13GHz were not included is because their levels are lower than 20dB form limit.

Model No	LVD1	Site	CB2-H
Test Voltage	AC 120V/60Hz	Test Date	2021/5/7
Test Mode	Mode 2: Transmit Adapter_1A100-US1230	Engineer	Rueyyan Lin
Polarity	Horizontal	Temperature (°C)	24.0
Test Condition	BT 2.0,DH5,Ant0,Ch 78,2.48G	Humidity (%RH)	63.0

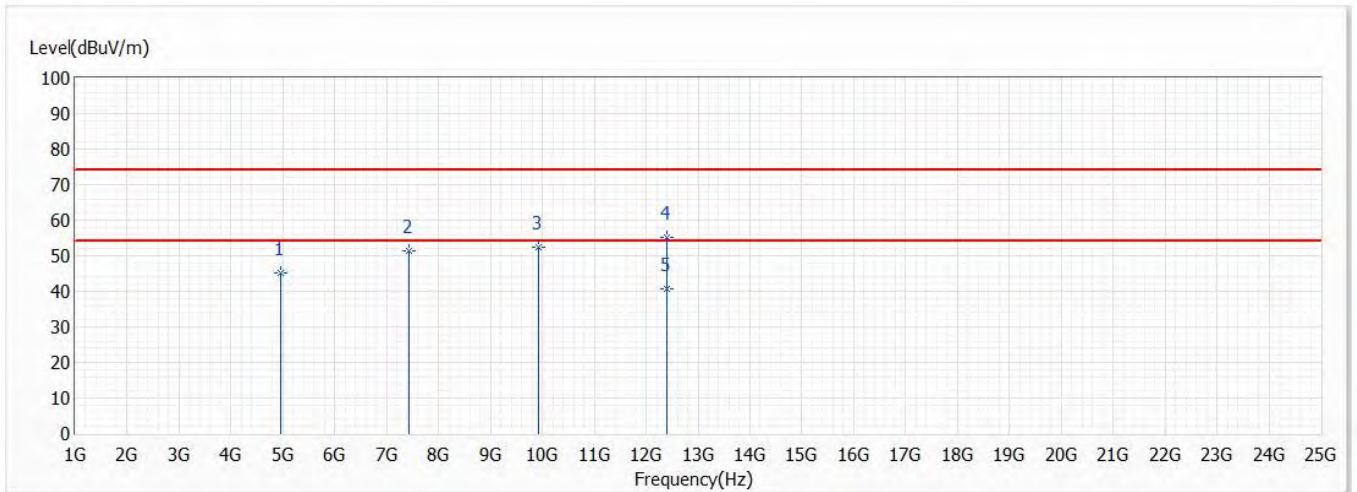

No	Frequency (MHz)	Emission Level (dBuV/m)	Limit (dBuV/m)	Margin (dB)	Reading Level (dBuV)	Correct Factor (dB)	Detector Type
1	4960.000	45.14	74.00	-28.86	56.74	-11.60	PK
2	7440.000	51.54	74.00	-22.46	55.55	-4.01	PK
3	9920.000	52.54	74.00	-21.46	53.73	-1.19	PK
4	12400.000	55.21	74.00	-18.79	52.87	2.34	PK
* 5	12400.000	40.74	54.00	-13.26	38.40	2.34	AV

**Note:**

1. All reading above 1GHz is performed with peak and/or average measurements as necessary.
2. “ \* ”, means this data is the worst value.
3. Emission Level = Reading Level + Correct Factor.
4. The average measurement was not performed when the peak measured data under the limit of average detection.
5. The emission above 13GHz were not included is because their levels are lower than 20dB form limit.

Model No	LVD1	Site	CB2-H
Test Voltage	AC 120V/60Hz	Test Date	2021/5/7
Test Mode	Mode 2: Transmit Adapter_1A100-US1230	Engineer	Rueyyan Lin
Polarity	Vertical	Temperature (°C)	24.0
Test Condition	BT 2.0,DH5,Ant0,Ch 78,2.48G	Humidity (%RH)	63.0

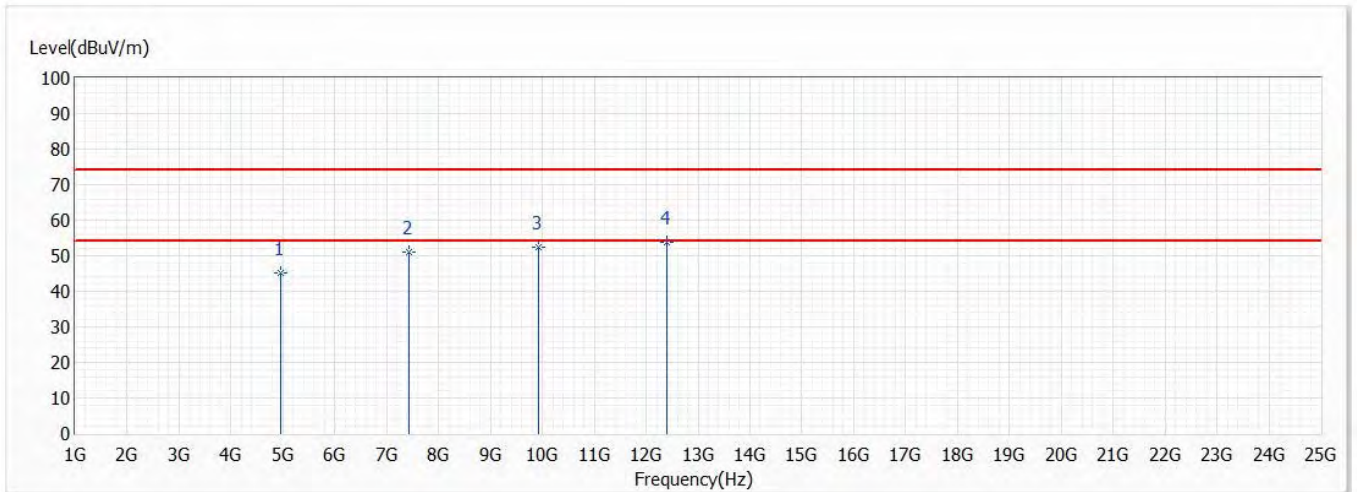

No	Frequency (MHz)	Emission Level (dBuV/m)	Limit (dBuV/m)	Margin (dB)	Reading Level (dBuV)	Correct Factor (dB)	Detector Type
1	4960.000	45.09	74.00	-28.91	56.69	-11.60	PK
2	7440.000	51.20	74.00	-22.80	55.21	-4.01	PK
3	9920.000	52.42	74.00	-21.58	53.61	-1.19	PK
* 4	12400.000	53.86	74.00	-20.14	51.52	2.34	PK

Note:

1. All reading above 1GHz is performed with peak and/or average measurements as necessary.
2. “ \* ”, means this data is the worst value.
3. Emission Level = Reading Level + Correct Factor.
4. The average measurement was not performed when the peak measured data under the limit of average detection.
5. The emission above 13GHz were not included is because their levels are lower than 20dB form limit.

Model No	LVD1	Site	CB2-H
Test Voltage	AC 120V/60Hz	Test Date	2021/5/7
Test Mode	Mode 2: Transmit Adapter_1A100-US1230	Engineer	Rueyyan Lin
Polarity	Horizontal	Temperature (°C)	24.0
Test Condition	BT 2.0,3DH5,Ant0,Ch 0,2.402G	Humidity (%RH)	63.0

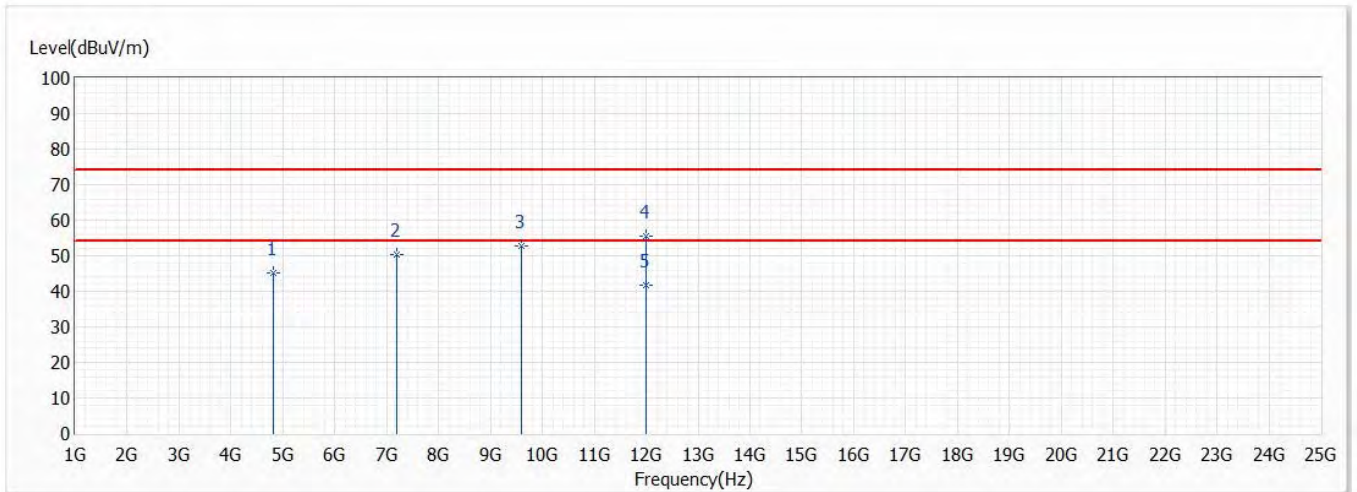

No	Frequency (MHz)	Emission Level (dBuV/m)	Limit (dBuV/m)	Margin (dB)	Reading Level (dBuV)	Correct Factor (dB)	Detector Type
1	4804.000	45.06	74.00	-28.94	57.09	-12.03	PK
2	7206.000	50.33	74.00	-23.67	55.01	-4.68	PK
3	9608.000	52.79	74.00	-21.21	54.12	-1.33	PK
4	12010.000	55.41	74.00	-18.59	52.60	2.81	PK
* 5	12010.000	41.70	54.00	-12.30	38.89	2.81	AV

**Note:**

1. All reading above 1GHz is performed with peak and/or average measurements as necessary.
2. “ \* ”, means this data is the worst value.
3. Emission Level = Reading Level + Correct Factor.
4. The average measurement was not performed when the peak measured data under the limit of average detection.
5. The emission above 13GHz were not included is because their levels are lower than 20dB form limit.

Model No	LVD1	Site	CB2-H
Test Voltage	AC 120V/60Hz	Test Date	2021/5/7
Test Mode	Mode 2: Transmit Adapter_1A100-US1230	Engineer	Rueyyan Lin
Polarity	Vertical	Temperature (°C)	24.0
Test Condition	BT 2.0,3DH5,Ant0,Ch 0,2.402G	Humidity (%RH)	63.0

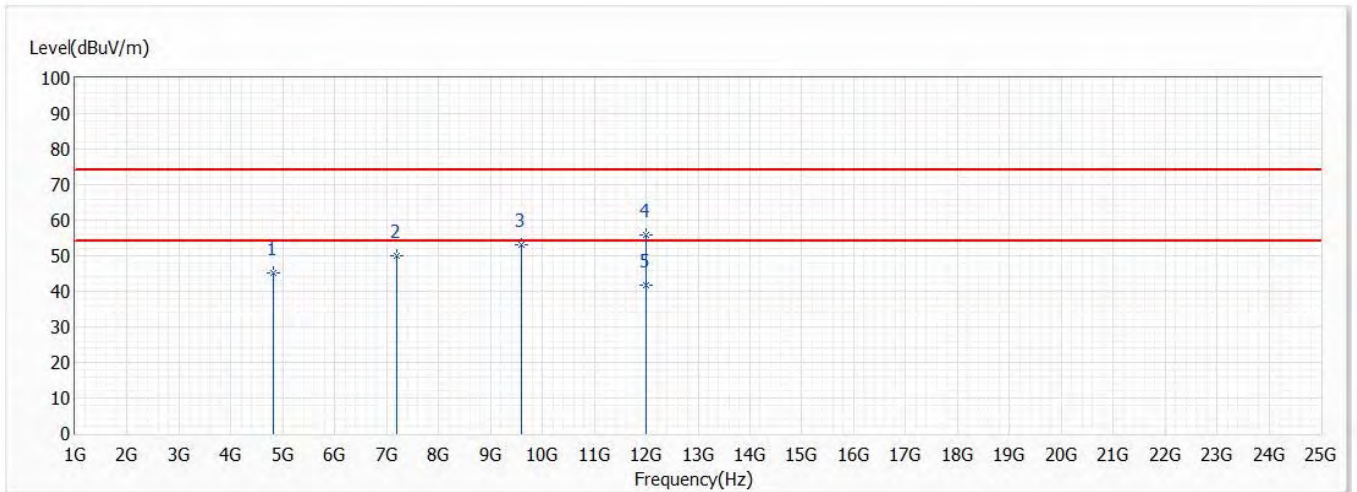

No	Frequency (MHz)	Emission Level (dBuV/m)	Limit (dBuV/m)	Margin (dB)	Reading Level (dBuV)	Correct Factor (dB)	Detector Type
1	4804.000	45.04	74.00	-28.96	57.07	-12.03	PK
2	7206.000	50.06	74.00	-23.94	54.74	-4.68	PK
3	9608.000	53.10	74.00	-20.90	54.43	-1.33	PK
4	12010.000	55.89	74.00	-18.11	53.08	2.81	PK
* 5	12010.000	41.72	54.00	-12.28	38.91	2.81	AV

**Note:**

1. All reading above 1GHz is performed with peak and/or average measurements as necessary.
2. “ \* ”, means this data is the worst value.
3. Emission Level = Reading Level + Correct Factor.
4. The average measurement was not performed when the peak measured data under the limit of average detection.
5. The emission above 13GHz were not included is because their levels are lower than 20dB form limit.

Model No	LVD1	Site	CB2-H
Test Voltage	AC 120V/60Hz	Test Date	2021/5/7
Test Mode	Mode 2: Transmit Adapter_1A100-US1230	Engineer	Rueyyan Lin
Polarity	Horizontal	Temperature (°C)	24.0
Test Condition	BT 2.0,3DH5,Ant0,Ch 39,2.441G	Humidity (%RH)	63.0

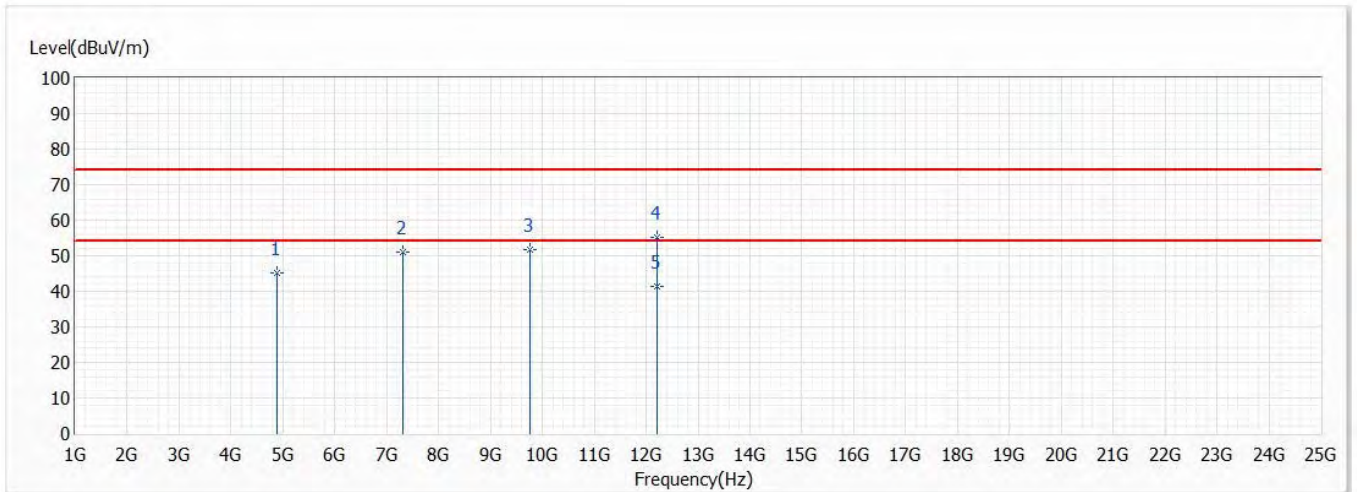

No	Frequency (MHz)	Emission Level (dBuV/m)	Limit (dBuV/m)	Margin (dB)	Reading Level (dBuV)	Correct Factor (dB)	Detector Type
1	4882.000	45.29	74.00	-28.71	57.12	-11.83	PK
2	7323.000	50.96	74.00	-23.04	55.31	-4.35	PK
3	9764.000	51.81	74.00	-22.19	53.08	-1.27	PK
4	12205.000	55.06	74.00	-18.94	52.48	2.58	PK
* 5	12205.000	41.33	54.00	-12.67	38.75	2.58	AV

**Note:**

1. All reading above 1GHz is performed with peak and/or average measurements as necessary.
2. “ \* ”, means this data is the worst value.
3. Emission Level = Reading Level + Correct Factor.
4. The average measurement was not performed when the peak measured data under the limit of average detection.
5. The emission above 13GHz were not included is because their levels are lower than 20dB form limit.

Model No	LVD1	Site	CB2-H
Test Voltage	AC 120V/60Hz	Test Date	2021/5/8
Test Mode	Mode 2: Transmit Adapter_1A100-US1230	Engineer	Rueyyan Lin
Polarity	Vertical	Temperature (°C)	24.0
Test Condition	BT 2.0,3DH5,Ant0,Ch 39,2.441G	Humidity (%RH)	63.0

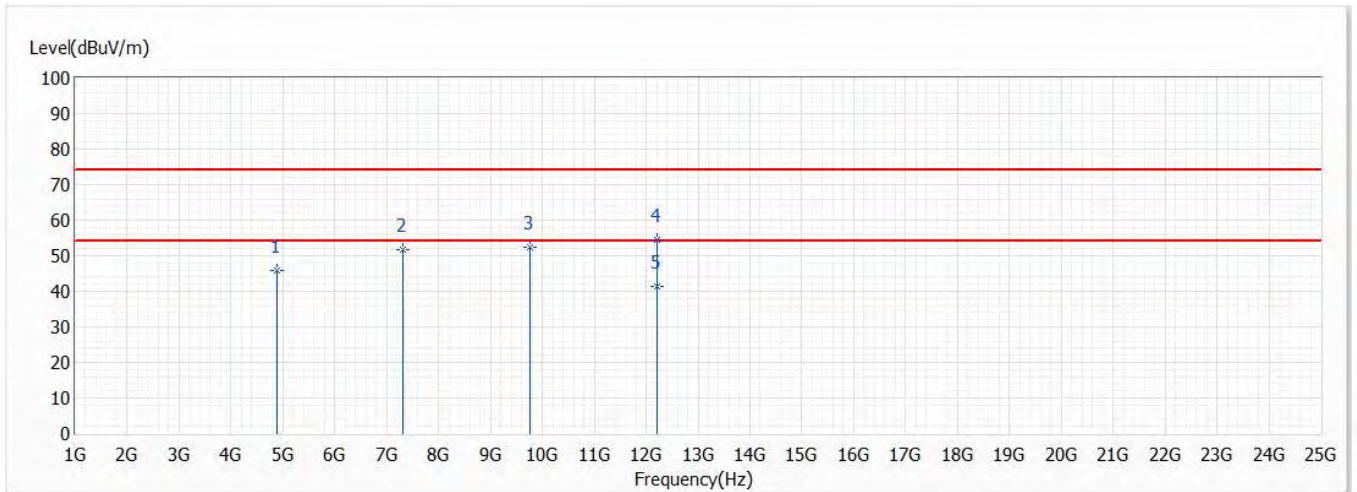

No	Frequency (MHz)	Emission Level (dBuV/m)	Limit (dBuV/m)	Margin (dB)	Reading Level (dBuV)	Correct Factor (dB)	Detector Type
1	4882.000	45.77	74.00	-28.23	57.60	-11.83	PK
2	7323.000	51.86	74.00	-22.14	56.21	-4.35	PK
3	9764.000	52.34	74.00	-21.66	53.61	-1.27	PK
4	12205.000	54.51	74.00	-19.49	51.93	2.58	PK
* 5	12205.000	41.26	54.00	-12.74	38.68	2.58	AV

**Note:**

1. All reading above 1GHz is performed with peak and/or average measurements as necessary.
2. “ \* ”, means this data is the worst value.
3. Emission Level = Reading Level + Correct Factor.
4. The average measurement was not performed when the peak measured data under the limit of average detection.
5. The emission above 13GHz were not included is because their levels are lower than 20dB form limit.

Model No	LVD1	Site	CB2-H
Test Voltage	AC 120V/60Hz	Test Date	2021/5/8
Test Mode	Mode 2: Transmit Adapter_1A100-US1230	Engineer	Rueyyan Lin
Polarity	Horizontal	Temperature (°C)	24.0
Test Condition	BT 2.0,3DH5,Ant0,Ch 78,2.48G	Humidity (%RH)	63.0

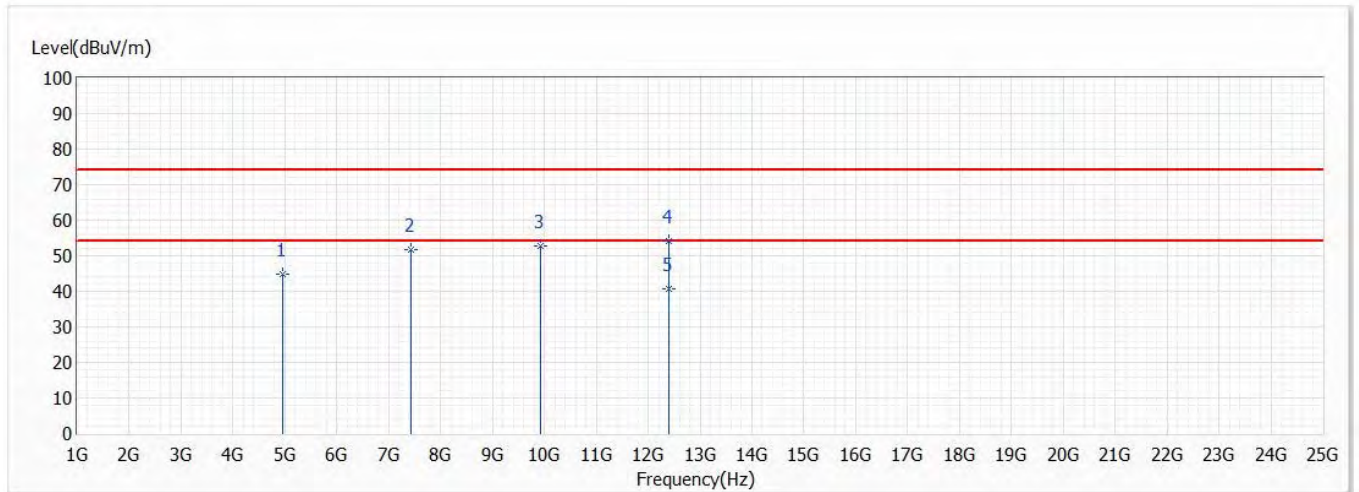

No	Frequency (MHz)	Emission Level (dBuV/m)	Limit (dBuV/m)	Margin (dB)	Reading Level (dBuV)	Correct Factor (dB)	Detector Type
1	4960.000	44.76	74.00	-29.24	56.36	-11.60	PK
2	7440.000	51.59	74.00	-22.41	55.60	-4.01	PK
3	9920.000	52.66	74.00	-21.34	53.85	-1.19	PK
4	12400.000	54.22	74.00	-19.78	51.88	2.34	PK
* 5	12400.000	40.75	54.00	-13.25	38.41	2.34	AV

**Note:**

1. All reading above 1GHz is performed with peak and/or average measurements as necessary.
2. “ \* ”, means this data is the worst value.
3. Emission Level = Reading Level + Correct Factor.
4. The average measurement was not performed when the peak measured data under the limit of average detection.
5. The emission above 13GHz were not included is because their levels are lower than 20dB form limit.



Model No	LVD1	Site	CB2-H
Test Voltage	AC 120V/60Hz	Test Date	2021/5/8
Test Mode	Mode 2: Transmit Adapter_1A100-US1230	Engineer	Rueyyan Lin
Polarity	Vertical	Temperature (°C)	24.0
Test Condition	BT 2.0,3DH5,Ant0,Ch 78,2.48G	Humidity (%RH)	63.0

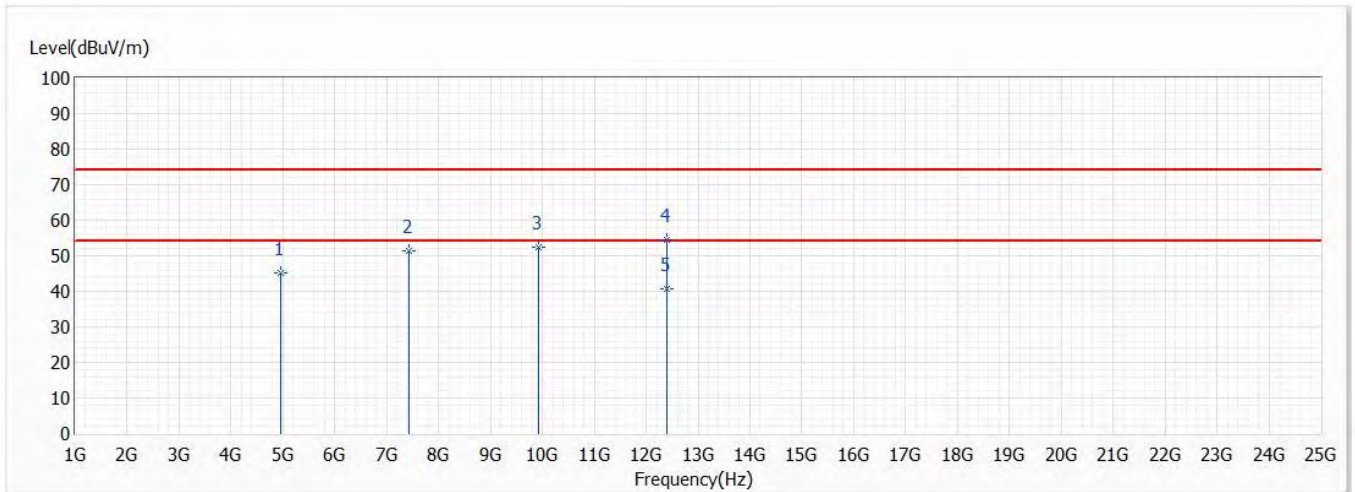

No	Frequency (MHz)	Emission Level (dBuV/m)	Limit (dBuV/m)	Margin (dB)	Reading Level (dBuV)	Correct Factor (dB)	Detector Type
1	4960.000	45.34	74.00	-28.66	56.94	-11.60	PK
2	7440.000	51.24	74.00	-22.76	55.25	-4.01	PK
3	9920.000	52.53	74.00	-21.47	53.72	-1.19	PK
4	12400.000	54.32	74.00	-19.68	51.98	2.34	PK
* 5	12400.000	40.77	54.00	-13.23	38.43	2.34	AV

**Note:**

1. All reading above 1GHz is performed with peak and/or average measurements as necessary.
2. “ \* ”, means this data is the worst value.
3. Emission Level = Reading Level + Correct Factor.
4. The average measurement was not performed when the peak measured data under the limit of average detection.
5. The emission above 13GHz were not included is because their levels are lower than 20dB form limit.

## 5. RF antenna conducted test

### 5.1. Test Setup

RF Conducted Measurement:

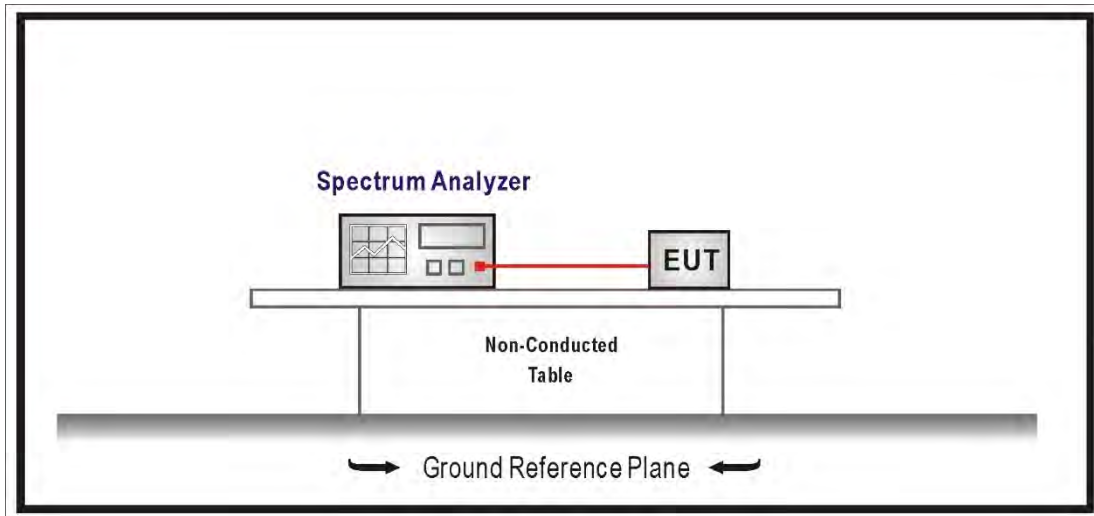

### 5.2. Limits

In any 100 kHz bandwidth outside the frequency band in which the spread spectrum intentional radiator is operating, the radio frequency power that is produced by the intentional radiator shall be at least 20 dB below that in the 100 kHz bandwidth within the band that contains the highest level of the desired power, based on an RF conducted or radiated measurement. Attenuation below the general limits specified in Section 15.209(a) is not required. In addition, radiated emissions which fall in the restricted bands, as defined in Section 15.205(a), must also comply with the radiated emission limits specified in Section 15.209(a) (see Section 15.205(c)).

### 5.3. Test Procedure

The EUT was setup according to ANSI C63.10: 2013 and tested according to FHSS test procedure of FCC KDB 558074 D01 v05r02 for compliance to FCC 47CFR 15.247

### 5.4. Test Specification

According to FCC Part 15 Subpart C Paragraph 15.247: 2019

### 5.5. Test Result

Product	Smart Display		
Test Item	RF antenna conducted test		
Test Mode	Mode 2: Transmit_Adapter_1A100-US1230		
Date of Test	2021/05/12	Test Site	SR12-H
Temperature(°C)	24.0	Humidity (%RH)	68.0

#### GFSK

Channel	Frequency (MHz)	Measure Level (dBc)	Limit (dBc)
00	2402	49.450	$\geq 20$
39	2441	48.420	$\geq 20$
78	2480	48.430	$\geq 20$

#### 8-DPSK

Channel	Frequency (MHz)	Measure Level (dBc)	Limit (dBc)
00	2402	48.530	$\geq 20$
39	2441	49.900	$\geq 20$
78	2480	46.990	$\geq 20$

### Channel 00\_GFSK

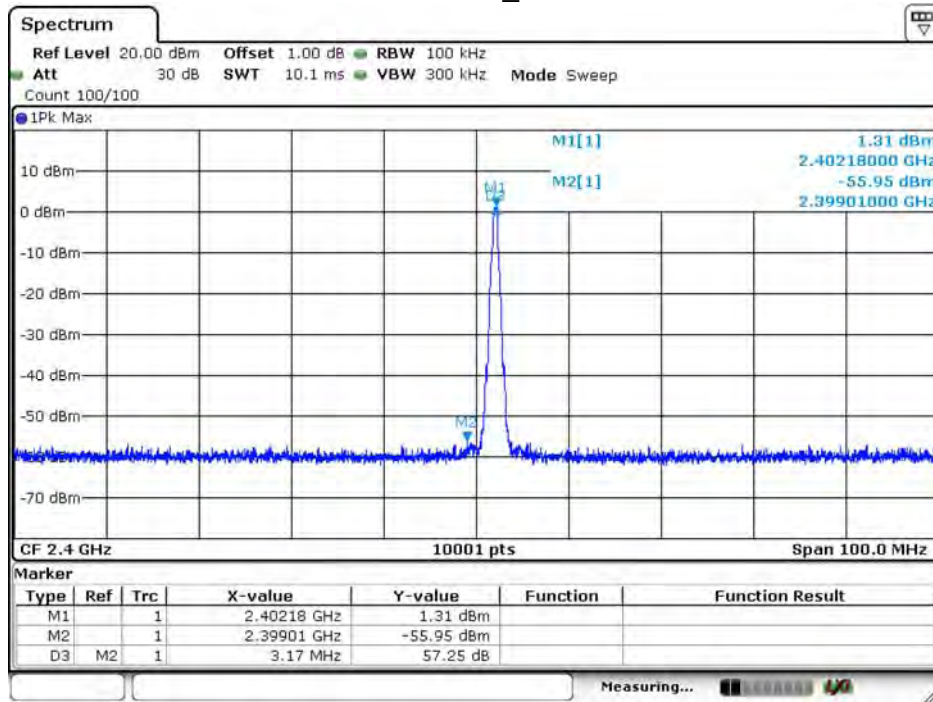

Date: 12.MAY.2021 15:28:27

### Channel 00 (30MHz-25GHz)\_GFSK

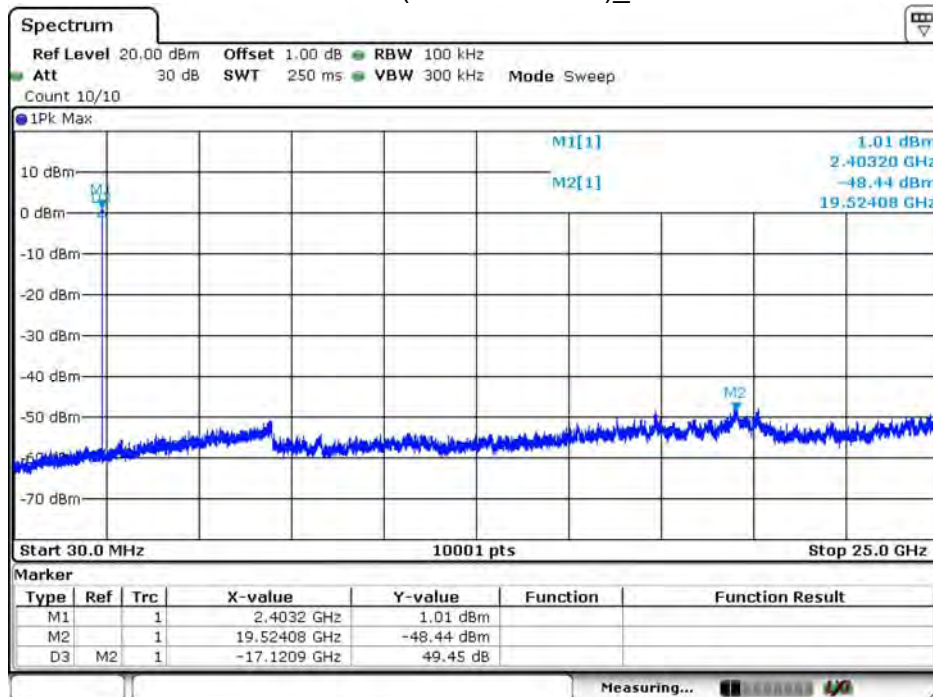

Date: 12.MAY.2021 15:36:45

### Channel 39\_GFSK

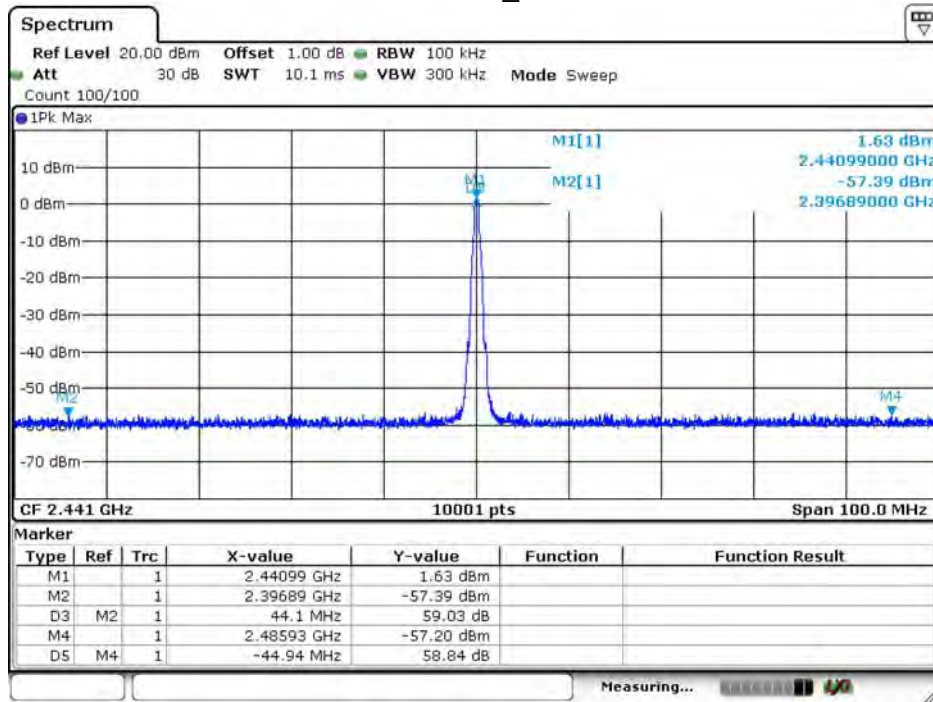

Date: 12.MAY.2021 15:29:14

### Channel 39 (30MHz-25GHz)\_GFSK

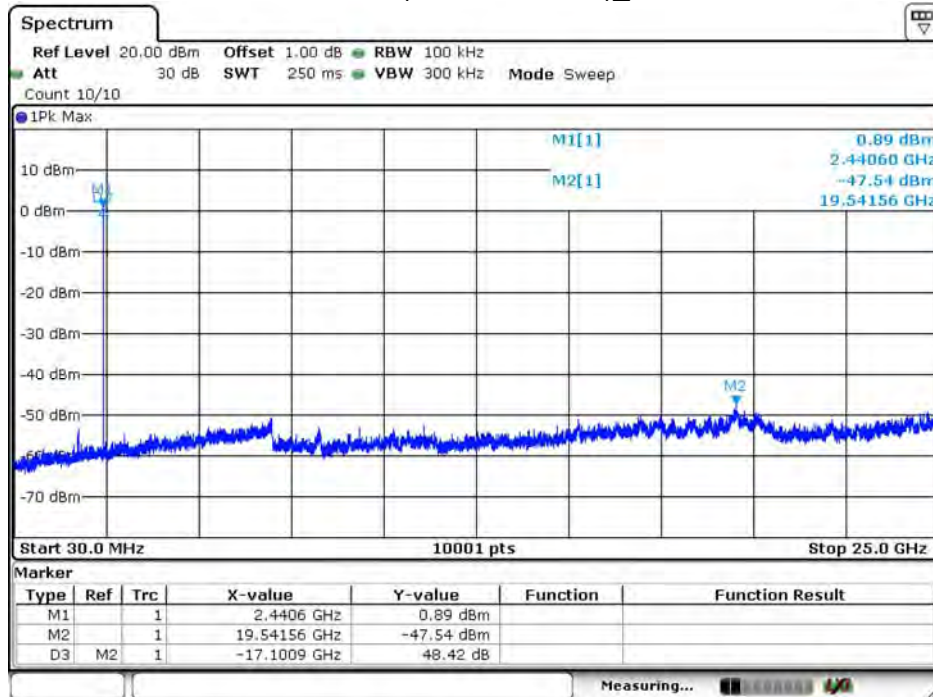

Date: 12.MAY.2021 15:35:20

Channel 78\_GFSK

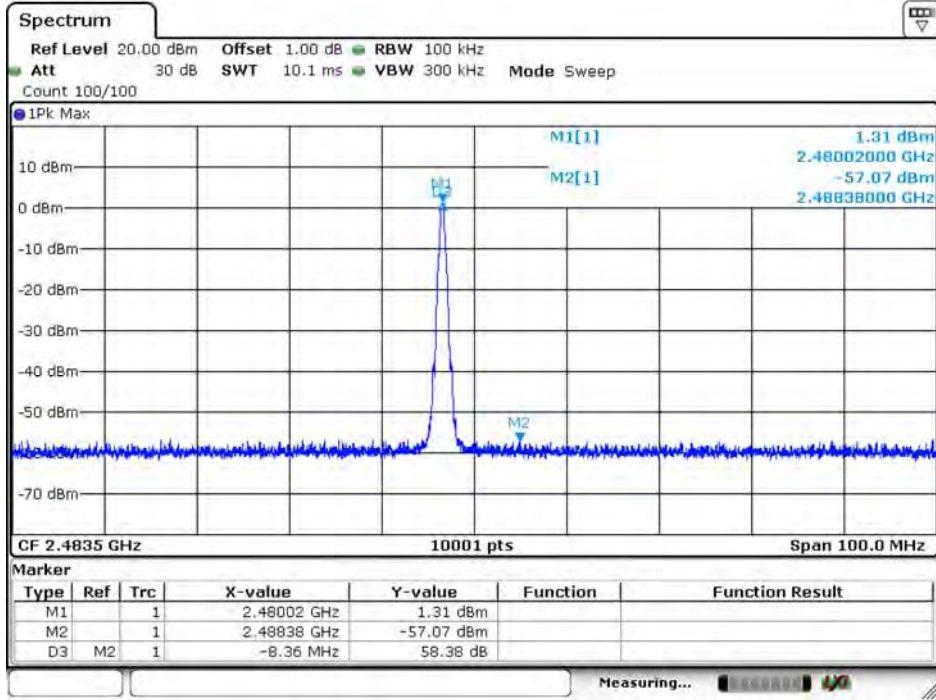

Channel 78 (30MHz-25GHz)\_GFSK

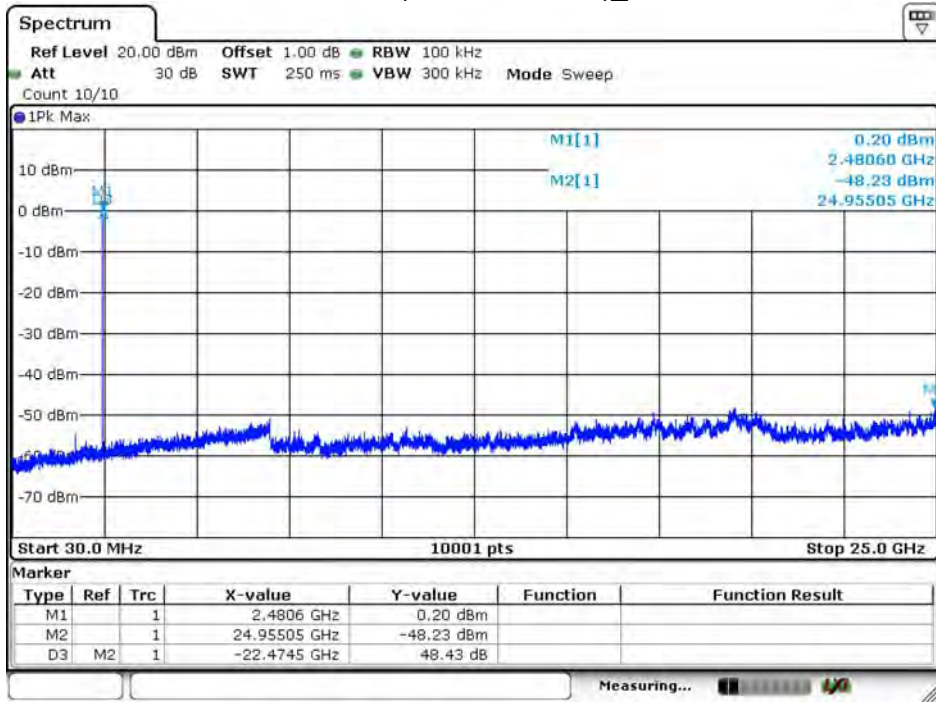

Channel 00\_8-DPSK

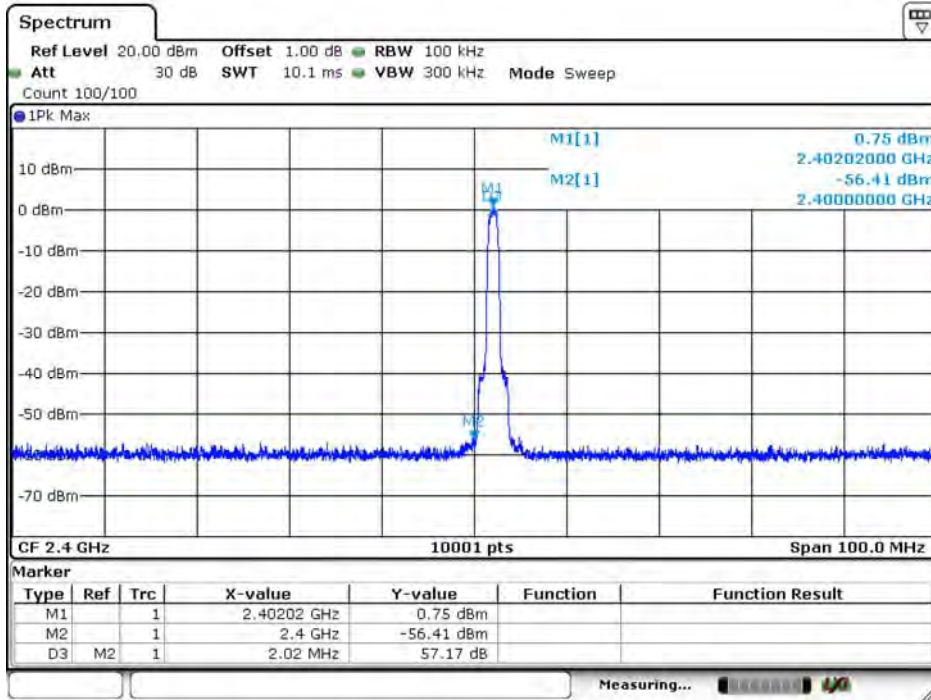

Date: 12.MAY.2021 15:26:35

Channel 00 (30MHz-25GHz)\_8-DPSK

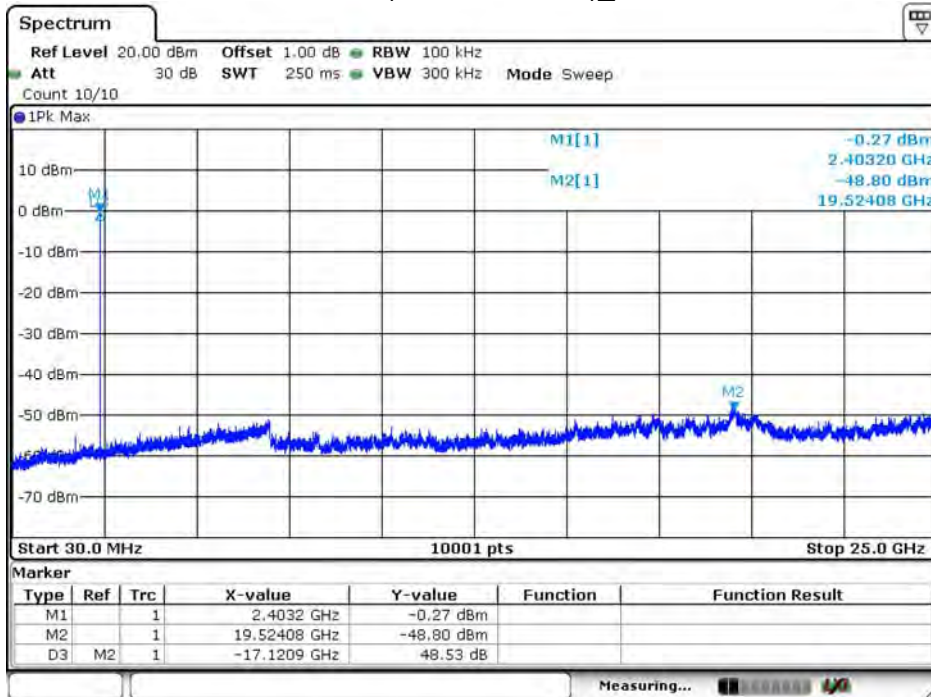

Date: 12.MAY.2021 15:38:32

### Channel 39\_8-DPSK

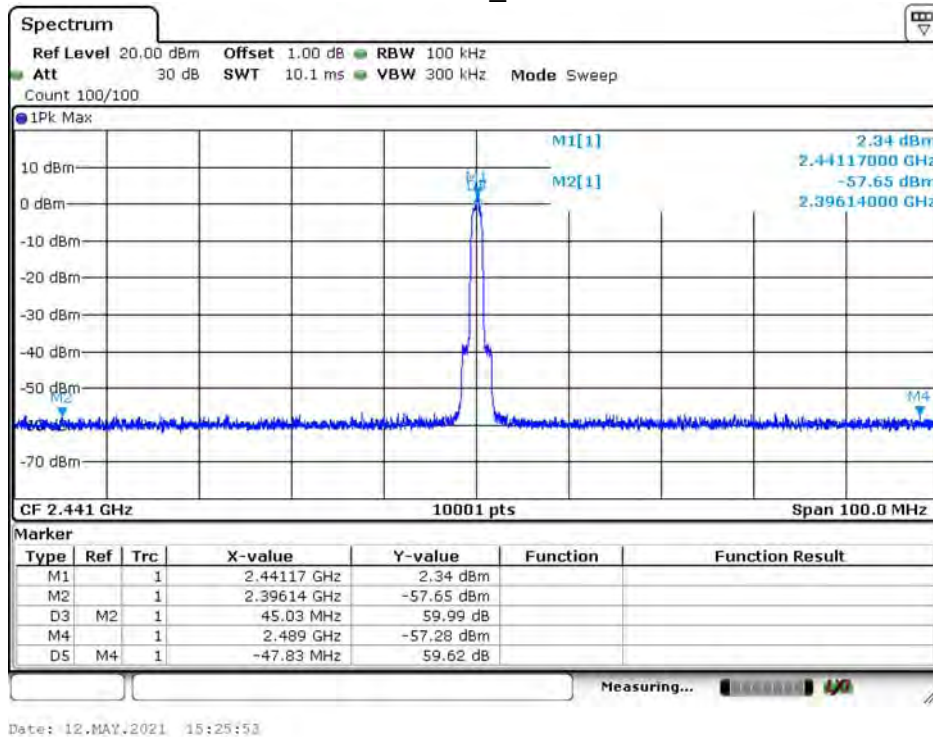

### Channel 39 (30MHz-25GHz)\_8-DPSK

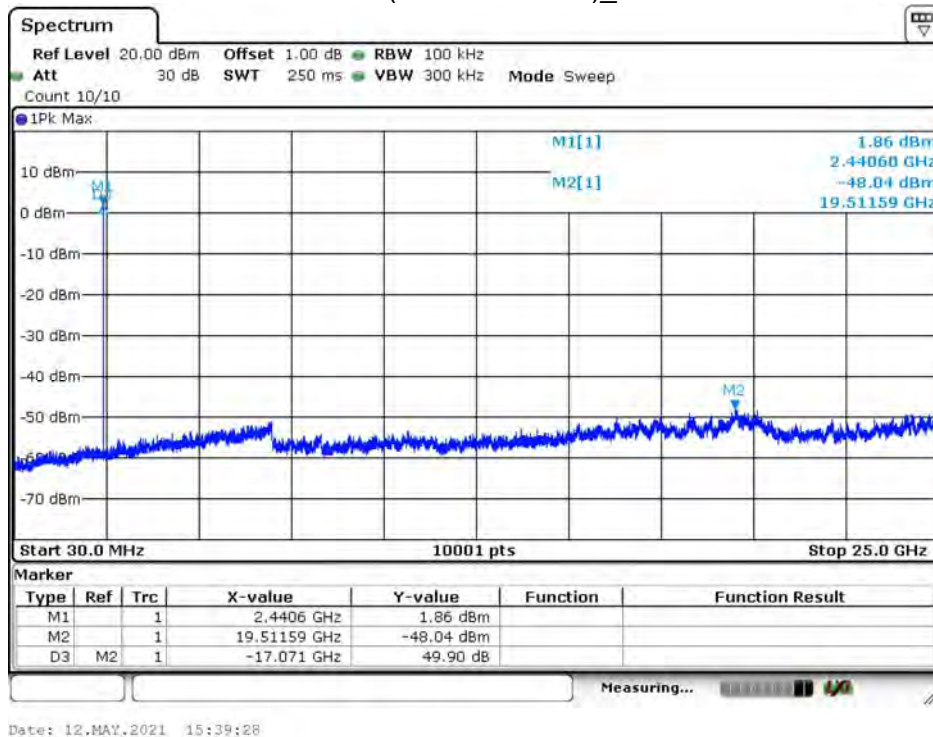



### Channel 78\_8-DPSK

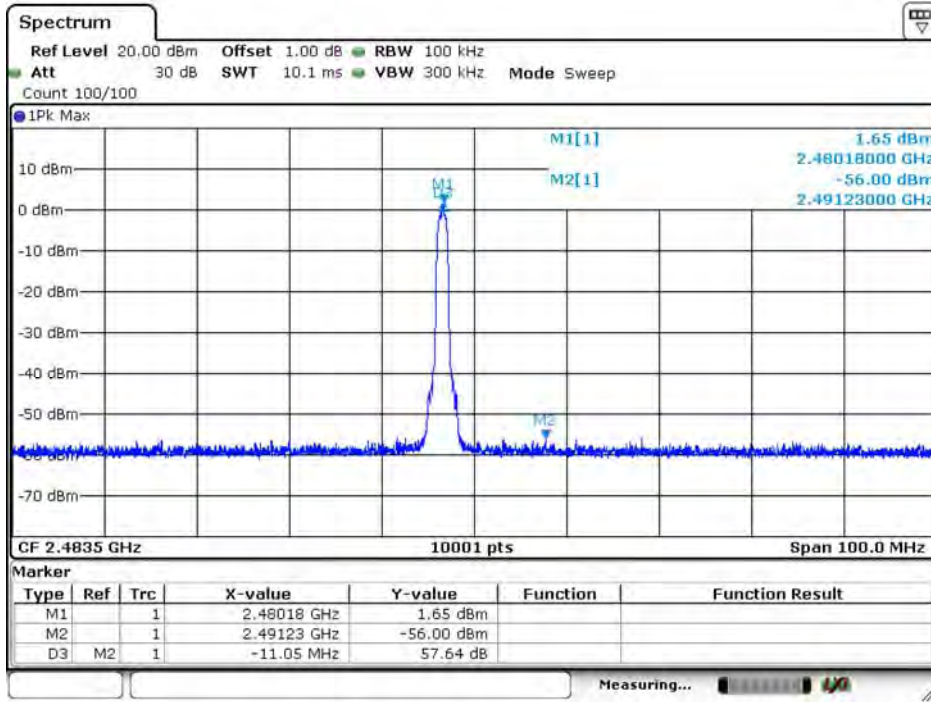

### Channel 78 (30MHz-25GHz)\_8-DPSK

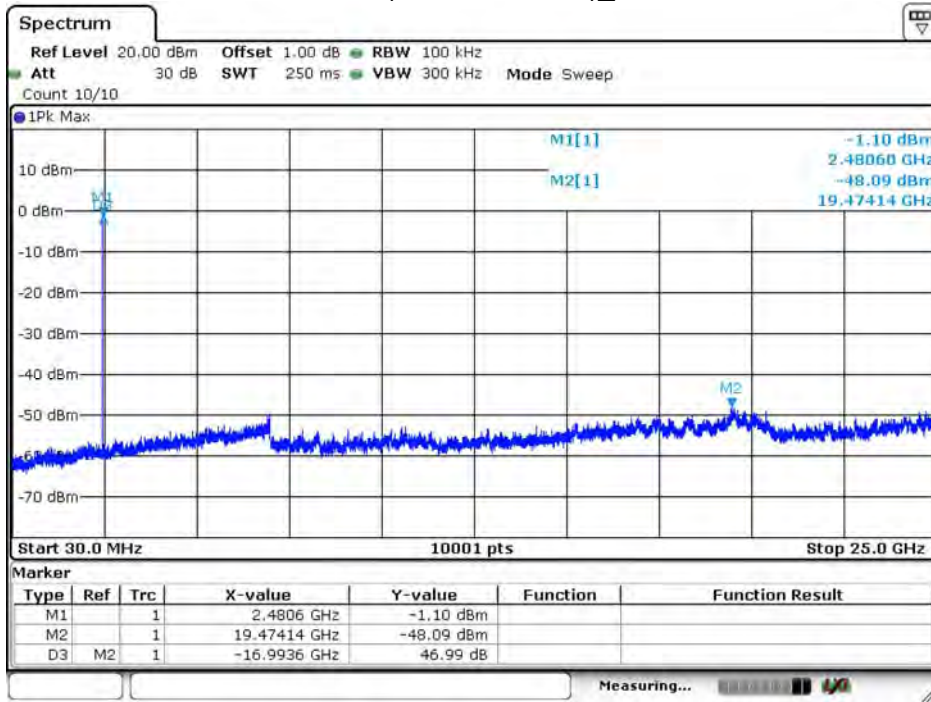

## 6. Bandedge

### 6.1. Test Setup

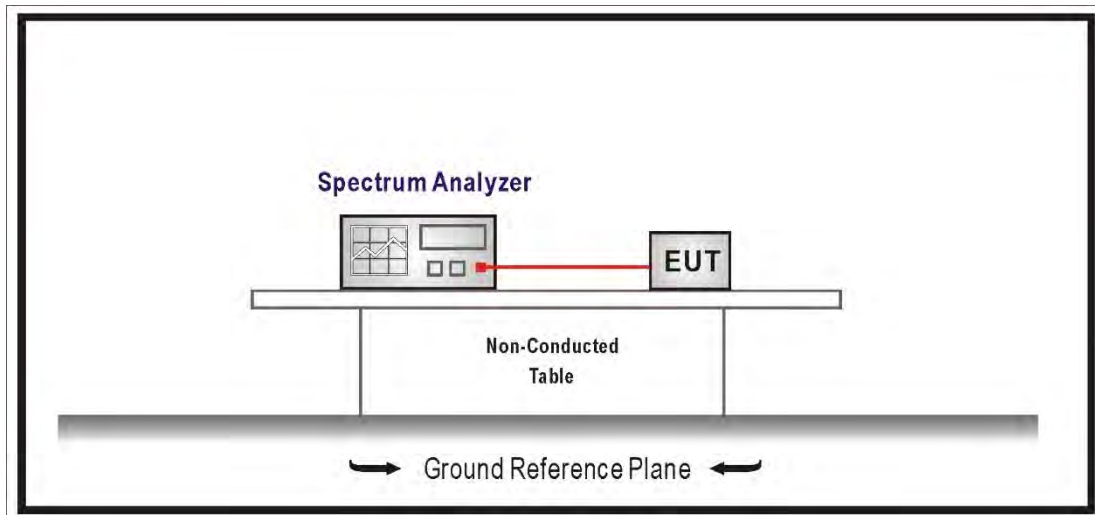

### 6.2. Limits

Emissions radiated outside of the specified frequency bands, except for harmonics, shall be attenuated by at least 20dB below the level of the fundamental or to the general radiated emission limits in paragraph 15.209, whichever is the lesser attenuation.

### 6.3. Test Procedure

The EUT was setup according to ANSI C63.10: 2013 and tested according to FHSS test procedure of FCC KDB 558074 D01 v05r02 for compliance to FCC 47CFR 15.247 requirements

### 6.4. Test Specification

According to FCC Part 15 Subpart C Paragraph 15.247: 2019

### 6.5. Test Result

Model No	LVD1	Site	CB2-H
Test Voltage	AC 120V/60Hz	Test Date	2021/5/7
Test Mode	Mode 2: Transmit_Adapter_1A100-US1230	Engineer	Rueyyan Lin
Polarity	Horizontal	Temperature (°C)	24.0
Test Condition	BT 2.0,DH5,Ant0,Ch 0,2.402G	Humidity (%RH)	63.0

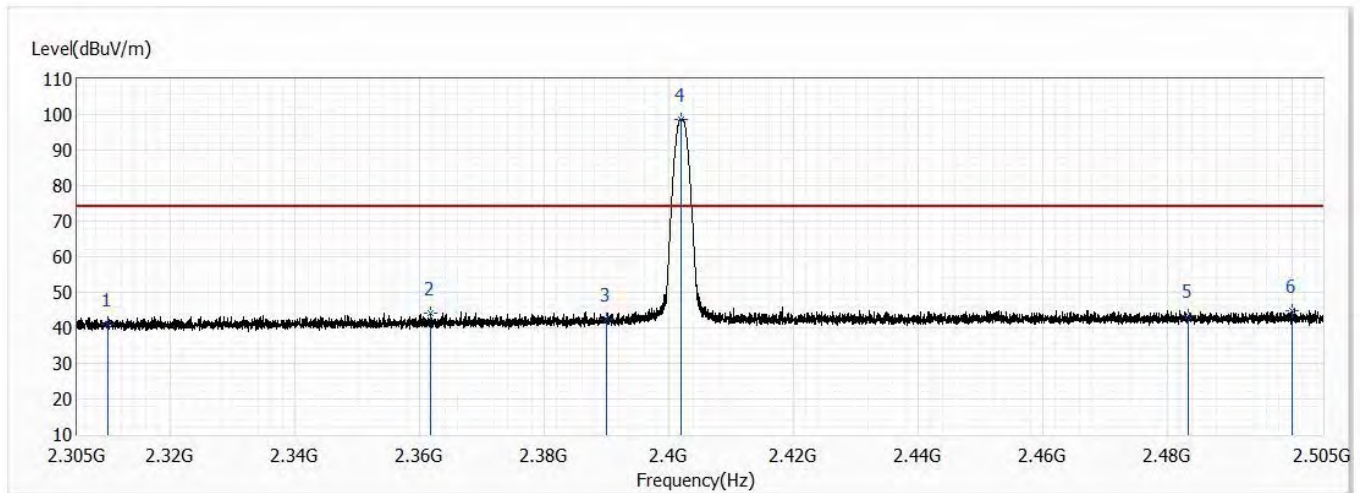

No	Frequency (MHz)	Emission Level (dBuV/m)	Limit (dBuV/m)	Margin (dB)	Reading Level (dBuV)	Correct Factor (dB)	Detector Type
1	2310.000	41.04	74.00	-32.96	27.89	13.15	PK
2	2361.800	44.27	74.00	-29.73	30.77	13.50	PK
3	2390.000	42.52	74.00	-31.48	28.82	13.70	PK
! 4	2401.900	98.68	74.00	24.68	84.89	13.79	PK
5	2483.500	43.48	74.00	-30.52	29.12	14.36	PK
6	2500.000	44.67	74.00	-29.33	30.19	14.48	PK

**Note:**

1. All reading above 1GHz is performed with peak and/or average measurements as necessary.
2. Emission Level = Reading Level + Correct Factor.
3. The average measurement was not performed when the peak measured data under the limit of average detection. If the readings given are average, peak measurement should also be supplied.
4. The fundamental for reference only, it's not restricted by unwanted emission limit.

Model No	LVD1	Site	CB2-H
Test Voltage	AC 120V/60Hz	Test Date	2021/5/7
Test Mode	Mode 2: Transmit Adapter_1A100-US1230	Engineer	Rueyyan Lin
Polarity	Horizontal	Temperature (°C)	24.0
Test Condition	BT 2.0,DH5,Ant0,Ch 0,2.402G	Humidity (%RH)	63.0

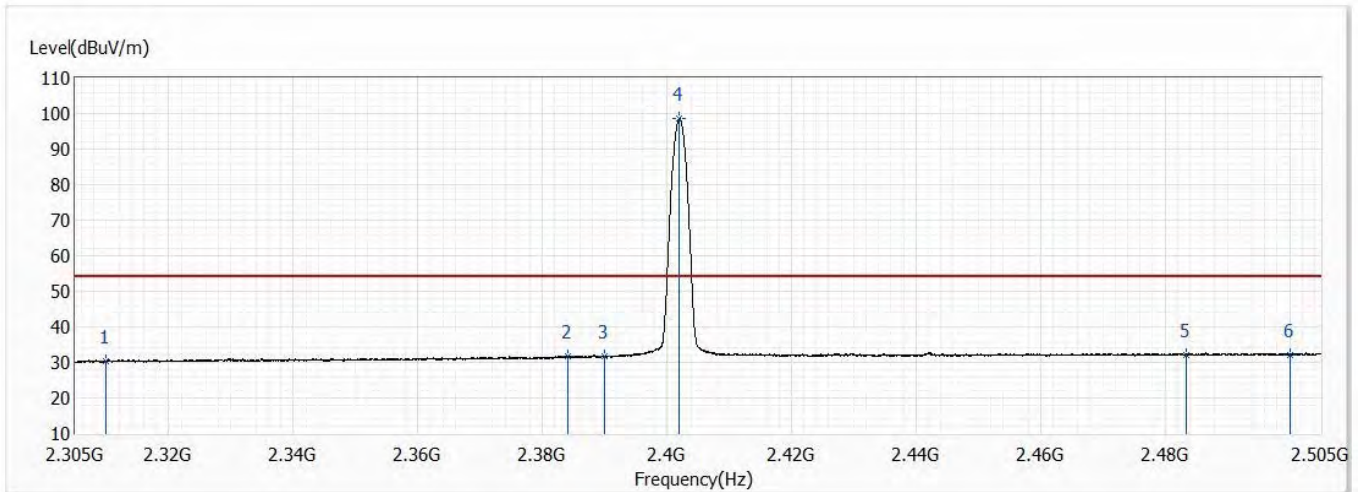

No	Frequency (MHz)	Emission Level (dBuV/m)	Limit (dBuV/m)	Margin (dB)	Reading Level (dBuV)	Correct Factor (dB)	Detector Type
1	2310.000	30.38	54.00	-23.62	17.23	13.15	AV
2	2384.100	31.79	54.00	-22.21	18.13	13.66	AV
3	2390.000	31.76	54.00	-22.24	18.06	13.70	AV
! 4	2402.025	98.51	54.00	44.51	84.72	13.79	AV
5	2483.500	32.15	54.00	-21.85	17.79	14.36	AV
6	2500.000	32.23	54.00	-21.77	17.75	14.48	AV

Note:

1. All reading above 1GHz is performed with peak and/or average measurements as necessary.
2. Emission Level = Reading Level + Correct Factor.
3. The average measurement was not performed when the peak measured data under the limit of average detection. If the readings given are average, peak measurement should also be supplied.
4. The fundamental for reference only, it's not restricted by unwanted emission limit.

Model No	LVD1	Site	CB2-H
Test Voltage	AC 120V/60Hz	Test Date	2021/5/7
Test Mode	Mode 2: Transmit Adapter_1A100-US1230	Engineer	Rueyyan Lin
Polarity	Vertical	Temperature (°C)	24.0
Test Condition	BT 2.0,DH5,Ant0,Ch 0,2.402G	Humidity (%RH)	63.0

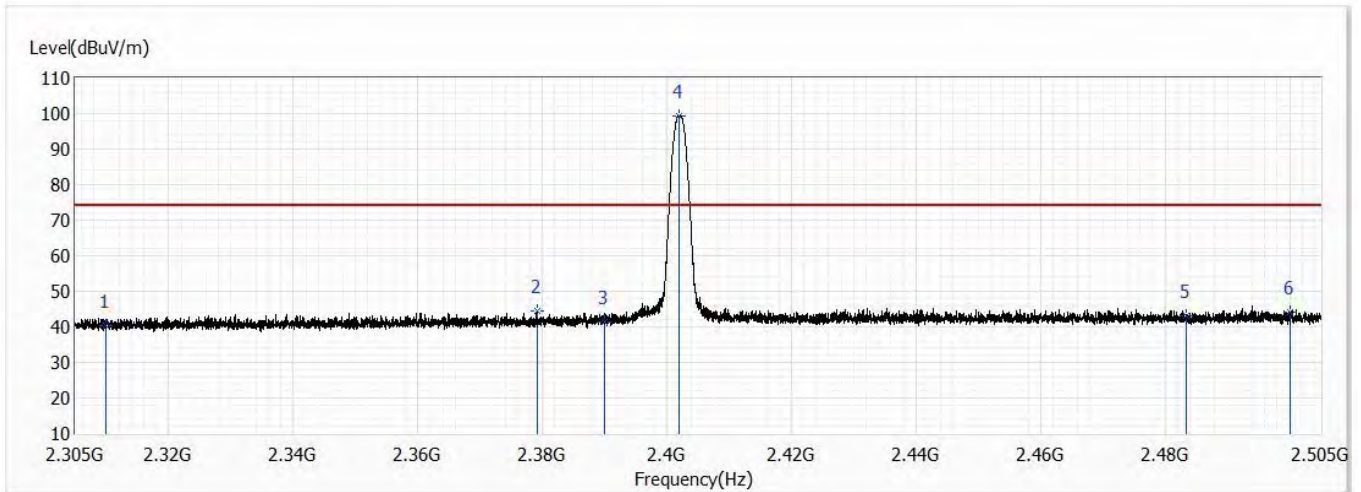

No	Frequency (MHz)	Emission Level (dBuV/m)	Limit (dBuV/m)	Margin (dB)	Reading Level (dBuV)	Correct Factor (dB)	Detector Type
1	2310.000	40.38	74.00	-33.62	27.23	13.15	PK
2	2379.150	44.32	74.00	-29.68	30.70	13.62	PK
3	2390.000	41.22	74.00	-32.78	27.52	13.70	PK
! 4	2402.050	99.45	74.00	25.45	85.66	13.79	PK
5	2483.500	43.11	74.00	-30.89	28.75	14.36	PK
6	2500.000	44.14	74.00	-29.86	29.66	14.48	PK

**Note:**

1. All reading above 1GHz is performed with peak and/or average measurements as necessary.
2. Emission Level = Reading Level + Correct Factor.
3. The average measurement was not performed when the peak measured data under the limit of average detection. If the readings given are average, peak measurement should also be supplied.
4. The fundamental for reference only, it's not restricted by unwanted emission limit.

Model No	LVD1	Site	CB2-H
Test Voltage	AC 120V/60Hz	Test Date	2021/5/7
Test Mode	Mode 2: Transmit Adapter_1A100-US1230	Engineer	Rueyyan Lin
Polarity	Vertical	Temperature (°C)	24.0
Test Condition	BT 2.0,DH5,Ant0,Ch 0,2.402G	Humidity (%RH)	63.0

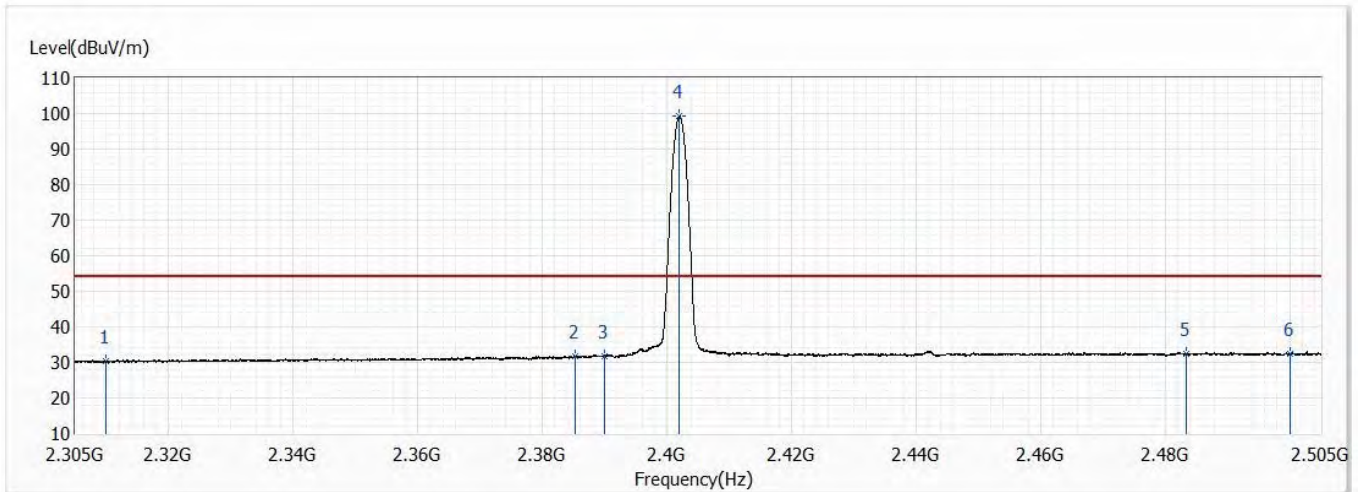

No	Frequency (MHz)	Emission Level (dBuV/m)	Limit (dBuV/m)	Margin (dB)	Reading Level (dBuV)	Correct Factor (dB)	Detector Type
1	2310.000	30.18	54.00	-23.82	17.03	13.15	AV
2	2385.275	31.83	54.00	-22.17	18.16	13.67	AV
3	2390.000	31.81	54.00	-22.19	18.11	13.70	AV
! 4	2402.000	99.24	54.00	45.24	85.45	13.79	AV
5	2483.500	32.37	54.00	-21.63	18.01	14.36	AV
6	2500.000	32.41	54.00	-21.59	17.93	14.48	AV

**Note:**

1. All reading above 1GHz is performed with peak and/or average measurements as necessary.
2. Emission Level = Reading Level + Correct Factor.
3. The average measurement was not performed when the peak measured data under the limit of average detection. If the readings given are average, peak measurement should also be supplied.
4. The fundamental for reference only, it's not restricted by unwanted emission limit.

Model No	LVD1	Site	CB2-H
Test Voltage	AC 120V/60Hz	Test Date	2021/5/7
Test Mode	Mode 2: Transmit Adapter_1A100-US1230	Engineer	Rueyyan Lin
Polarity	Horizontal	Temperature (°C)	24.0
Test Condition	BT 2.0,DH5,Ant0,Ch 39,2.441G	Humidity (%RH)	63.0

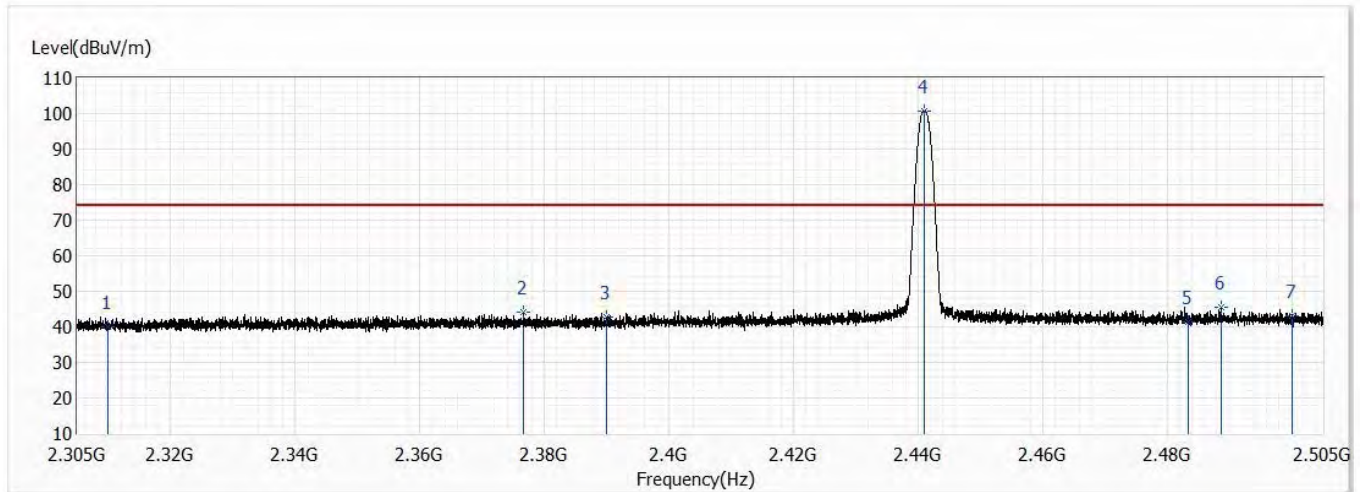

No	Frequency (MHz)	Emission Level (dBuV/m)	Limit (dBuV/m)	Margin (dB)	Reading Level (dBuV)	Correct Factor (dB)	Detector Type
1	2310.000	40.04	74.00	-33.96	26.89	13.15	PK
2	2376.600	44.27	74.00	-29.73	30.65	13.62	PK
3	2390.000	42.82	74.00	-31.18	29.12	13.70	PK
! 4	2440.925	100.67	74.00	26.67	86.61	14.06	PK
5	2483.500	41.50	74.00	-32.50	27.14	14.36	PK
6	2488.750	45.49	74.00	-28.51	31.09	14.40	PK
7	2500.000	43.25	74.00	-30.75	28.77	14.48	PK

Note:

1. All reading above 1GHz is performed with peak and/or average measurements as necessary.
2. Emission Level = Reading Level + Correct Factor.
3. The average measurement was not performed when the peak measured data under the limit of average detection. If the readings given are average, peak measurement should also be supplied.
4. The fundamental for reference only, it's not restricted by unwanted emission limit.

Model No	LVD1	Site	CB2-H
Test Voltage	AC 120V/60Hz	Test Date	2021/5/7
Test Mode	Mode 2: Transmit Adapter_1A100-US1230	Engineer	Rueyyan Lin
Polarity	Horizontal	Temperature (°C)	24.0
Test Condition	BT 2.0,DH5,Ant0,Ch 39,2.441G	Humidity (%RH)	63.0

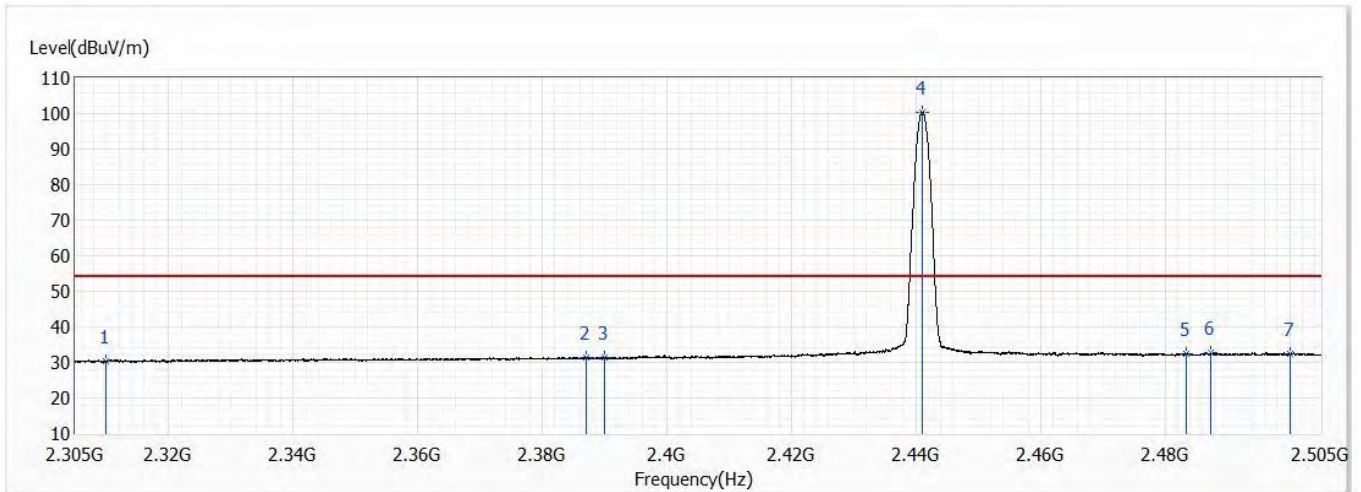

No	Frequency (MHz)	Emission Level (dBuV/m)	Limit (dBuV/m)	Margin (dB)	Reading Level (dBuV)	Correct Factor (dB)	Detector Type
1	2310.000	30.25	54.00	-23.75	17.10	13.15	AV
2	2387.100	31.39	54.00	-22.61	17.70	13.69	AV
3	2390.000	31.39	54.00	-22.61	17.69	13.70	AV
! 4	2441.025	100.46	54.00	46.46	86.40	14.06	AV
5	2483.500	32.30	54.00	-21.70	17.94	14.36	AV
6	2487.400	32.69	54.00	-21.31	18.30	14.39	AV
7	2500.000	32.32	54.00	-21.68	17.84	14.48	AV

Note:

1. All reading above 1GHz is performed with peak and/or average measurements as necessary.
2. Emission Level = Reading Level + Correct Factor.
3. The average measurement was not performed when the peak measured data under the limit of average detection. If the readings given are average, peak measurement should also be supplied.
4. The fundamental for reference only, it's not restricted by unwanted emission limit.



Model No	LVD1	Site	CB2-H
Test Voltage	AC 120V/60Hz	Test Date	2021/5/7
Test Mode	Mode 2: Transmit Adapter_1A100-US1230	Engineer	Rueyyan Lin
Polarity	Vertical	Temperature (°C)	24.0
Test Condition	BT 2.0,DH5,Ant0,Ch 39,2.441G	Humidity (%RH)	63.0

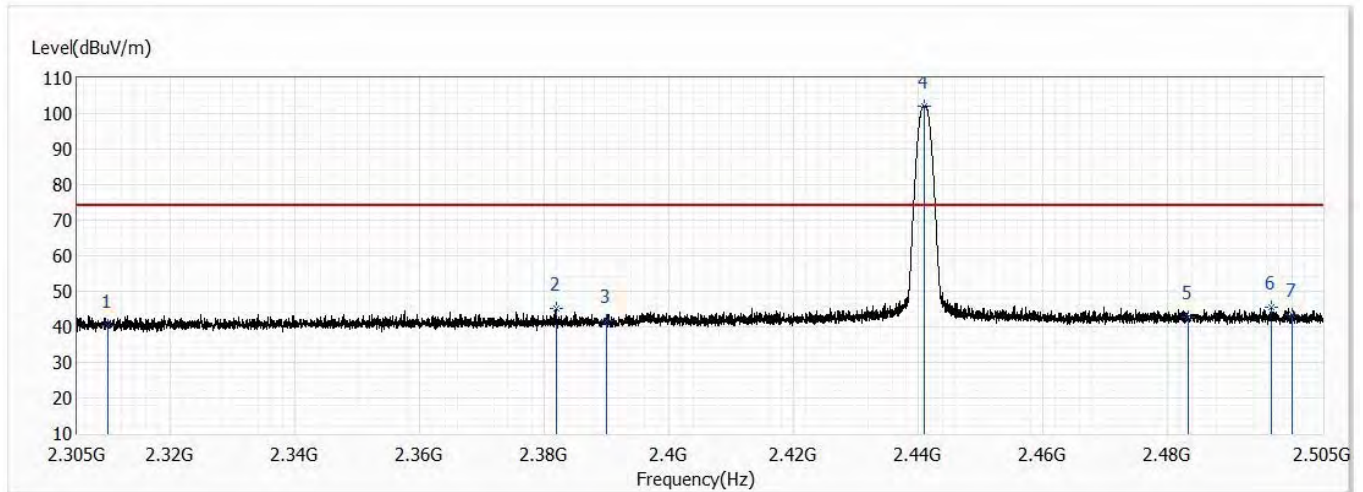

No	Frequency (MHz)	Emission Level (dBuV/m)	Limit (dBuV/m)	Margin (dB)	Reading Level (dBuV)	Correct Factor (dB)	Detector Type
1	2310.000	40.34	74.00	-33.66	27.19	13.15	PK
2	2381.850	45.18	74.00	-28.82	31.53	13.65	PK
3	2390.000	41.57	74.00	-32.43	27.87	13.70	PK
! 4	2440.925	102.15	74.00	28.15	88.09	14.06	PK
5	2483.500	42.72	74.00	-31.28	28.36	14.36	PK
6	2496.850	45.43	74.00	-28.57	30.98	14.45	PK
7	2500.000	43.31	74.00	-30.69	28.83	14.48	PK

Note:

1. All reading above 1GHz is performed with peak and/or average measurements as necessary.
2. Emission Level = Reading Level + Correct Factor.
3. The average measurement was not performed when the peak measured data under the limit of average detection. If the readings given are average, peak measurement should also be supplied.
4. The fundamental for reference only, it's not restricted by unwanted emission limit.

Model No	LVD1	Site	CB2-H
Test Voltage	AC 120V/60Hz	Test Date	2021/5/7
Test Mode	Mode 2: Transmit Adapter_1A100-US1230	Engineer	Rueyyan Lin
Polarity	Vertical	Temperature (°C)	24.0
Test Condition	BT 2.0,DH5,Ant0,Ch 39,2.441G	Humidity (%RH)	63.0

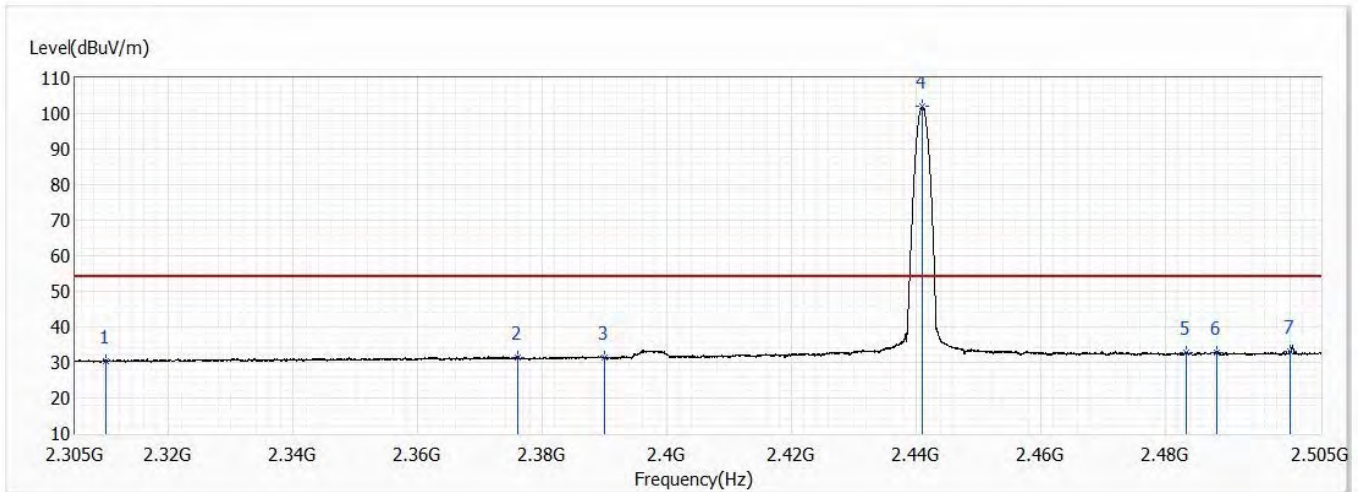

No	Frequency (MHz)	Emission Level (dBuV/m)	Limit (dBuV/m)	Margin (dB)	Reading Level (dBuV)	Correct Factor (dB)	Detector Type
1	2310.000	30.32	54.00	-23.68	17.17	13.15	AV
2	2376.075	31.54	54.00	-22.46	17.93	13.61	AV
3	2390.000	31.34	54.00	-22.66	17.64	13.70	AV
! 4	2441.025	101.97	54.00	47.97	87.91	14.06	AV
5	2483.500	32.67	54.00	-21.33	18.31	14.36	AV
6	2488.225	32.90	54.00	-21.10	18.50	14.40	AV
7	2500.000	33.06	54.00	-20.94	18.58	14.48	AV

Note:

1. All reading above 1GHz is performed with peak and/or average measurements as necessary.
2. Emission Level = Reading Level + Correct Factor.
3. The average measurement was not performed when the peak measured data under the limit of average detection. If the readings given are average, peak measurement should also be supplied.
4. The fundamental for reference only, it's not restricted by unwanted emission limit.

Model No	LVD1	Site	CB2-H
Test Voltage	AC 120V/60Hz	Test Date	2021/5/7
Test Mode	Mode 2: Transmit Adapter_1A100-US1230	Engineer	Rueyyan Lin
Polarity	Horizontal	Temperature (°C)	24.0
Test Condition	BT 2.0,DH5,Ant0,Ch 78,2.48G	Humidity (%RH)	63.0

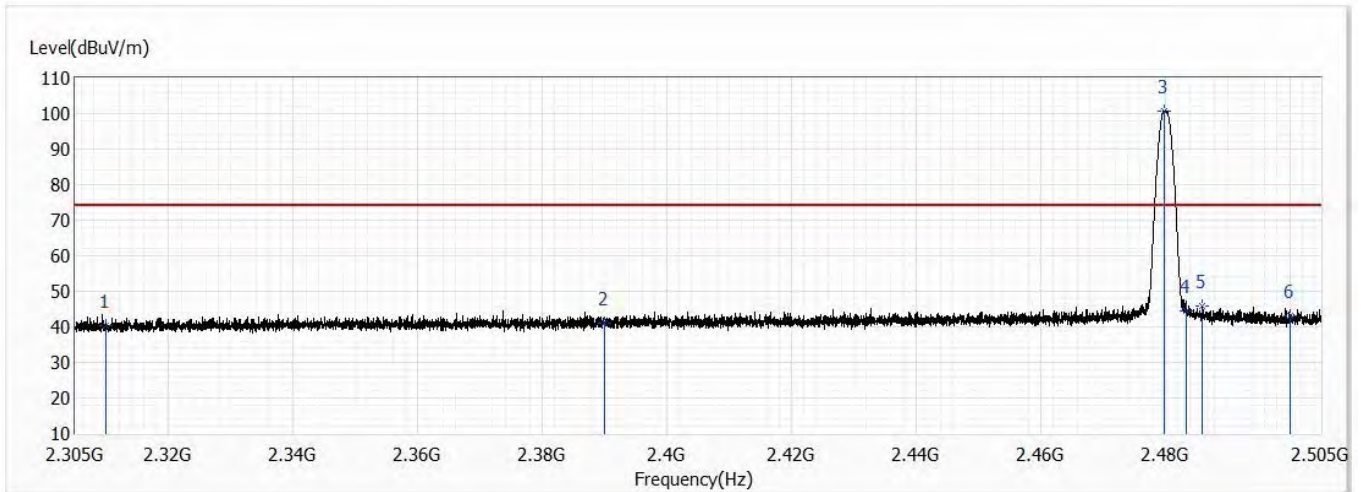

No	Frequency (MHz)	Emission Level (dBuV/m)	Limit (dBuV/m)	Margin (dB)	Reading Level (dBuV)	Correct Factor (dB)	Detector Type
1	2310.000	40.40	74.00	-33.60	27.25	13.15	PK
2	2390.000	41.12	74.00	-32.88	27.42	13.70	PK
! 3	2479.925	100.72	74.00	26.72	86.38	14.34	PK
4	2483.500	44.39	74.00	-29.61	30.03	14.36	PK
5	2486.050	45.77	74.00	-28.23	31.39	14.38	PK
6	2500.000	42.98	74.00	-31.02	28.50	14.48	PK

**Note:**

1. All reading above 1GHz is performed with peak and/or average measurements as necessary.
2. Emission Level = Reading Level + Correct Factor.
3. The average measurement was not performed when the peak measured data under the limit of average detection. If the readings given are average, peak measurement should also be supplied.
4. The fundamental for reference only, it's not restricted by unwanted emission limit.

Model No	LVD1	Site	CB2-H
Test Voltage	AC 120V/60Hz	Test Date	2021/5/7
Test Mode	Mode 2: Transmit Adapter_1A100-US1230	Engineer	Rueyyan Lin
Polarity	Horizontal	Temperature (°C)	24.0
Test Condition	BT 2.0,DH5,Ant0,Ch 78,2.48G	Humidity (%RH)	63.0

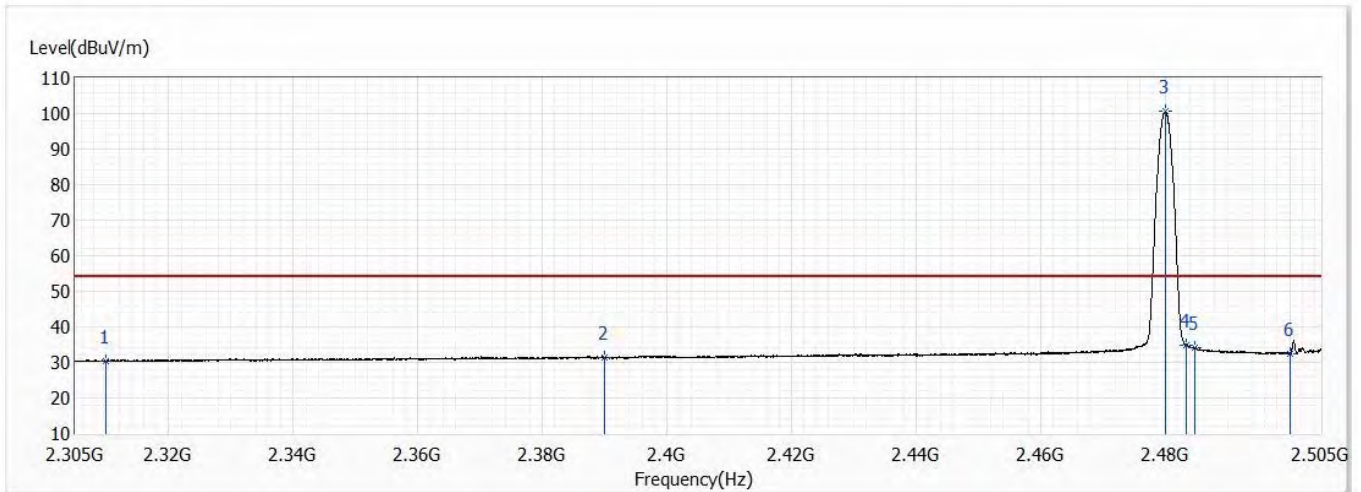

No	Frequency (MHz)	Emission Level (dBuV/m)	Limit (dBuV/m)	Margin (dB)	Reading Level (dBuV)	Correct Factor (dB)	Detector Type
1	2310.000	30.48	54.00	-23.52	17.33	13.15	AV
2	2390.000	31.54	54.00	-22.46	17.84	13.70	AV
! 3	2480.025	100.52	54.00	46.52	86.18	14.34	AV
4	2483.500	34.78	54.00	-19.22	20.42	14.36	AV
5	2484.700	34.07	54.00	-19.93	19.71	14.36	AV
6	2500.000	32.51	54.00	-21.49	18.03	14.48	AV

**Note:**

1. All reading above 1GHz is performed with peak and/or average measurements as necessary.
2. Emission Level = Reading Level + Correct Factor.
3. The average measurement was not performed when the peak measured data under the limit of average detection. If the readings given are average, peak measurement should also be supplied.
4. The fundamental for reference only, it's not restricted by unwanted emission limit.

Model No	LVD1	Site	CB2-H
Test Voltage	AC 120V/60Hz	Test Date	2021/5/7
Test Mode	Mode 2: Transmit Adapter_1A100-US1230	Engineer	Rueyyan Lin
Polarity	Vertical	Temperature (°C)	24.0
Test Condition	BT 2.0,DH5,Ant0,Ch 78,2.48G	Humidity (%RH)	63.0

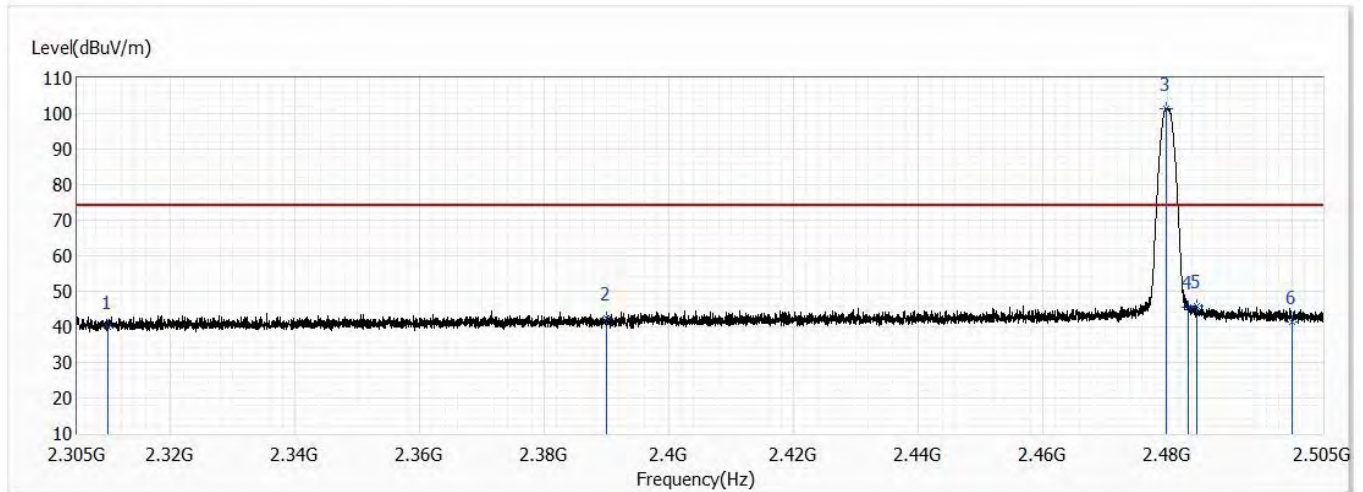

No	Frequency (MHz)	Emission Level (dBuV/m)	Limit (dBuV/m)	Margin (dB)	Reading Level (dBuV)	Correct Factor (dB)	Detector Type
1	2310.000	40.00	74.00	-34.00	26.85	13.15	PK
2	2390.000	42.33	74.00	-31.67	28.63	13.70	PK
! 3	2479.900	101.52	74.00	27.52	87.18	14.34	PK
4	2483.500	45.37	74.00	-28.63	31.01	14.36	PK
5	2484.700	45.87	74.00	-28.13	31.51	14.36	PK
6	2500.000	41.31	74.00	-32.69	26.83	14.48	PK

**Note:**

1. All reading above 1GHz is performed with peak and/or average measurements as necessary.
2. Emission Level = Reading Level + Correct Factor.
3. The average measurement was not performed when the peak measured data under the limit of average detection. If the readings given are average, peak measurement should also be supplied.
4. The fundamental for reference only, it's not restricted by unwanted emission limit.

Model No	LVD1	Site	CB2-H
Test Voltage	AC 120V/60Hz	Test Date	2021/5/7
Test Mode	Mode 2: Transmit Adapter_1A100-US1230	Engineer	Rueyyan Lin
Polarity	Vertical	Temperature (°C)	24.0
Test Condition	BT 2.0,DH5,Ant0,Ch 78,2.48G	Humidity (%RH)	63.0

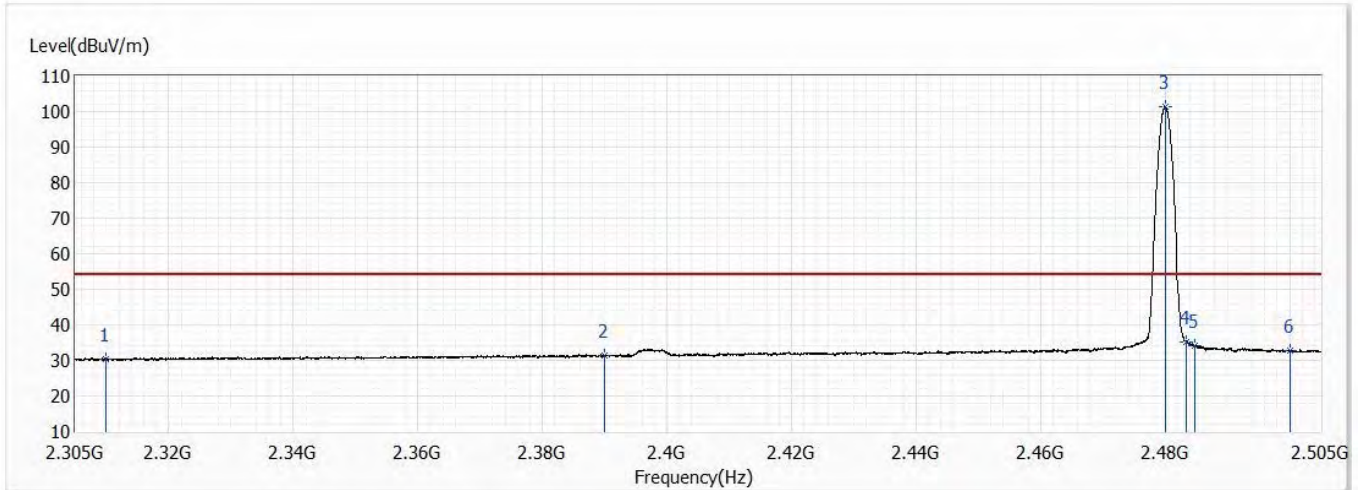

No	Frequency (MHz)	Emission Level (dBuV/m)	Limit (dBuV/m)	Margin (dB)	Reading Level (dBuV)	Correct Factor (dB)	Detector Type
1	2310.000	30.35	54.00	-23.65	17.20	13.15	AV
2	2390.000	31.50	54.00	-22.50	17.80	13.70	AV
! 3	2480.050	101.32	54.00	47.32	86.98	14.34	AV
4	2483.500	35.17	54.00	-18.83	20.81	14.36	AV
5	2484.775	34.06	54.00	-19.94	19.69	14.37	AV
6	2500.000	32.62	54.00	-21.38	18.14	14.48	AV

**Note:**

1. All reading above 1GHz is performed with peak and/or average measurements as necessary.
2. Emission Level = Reading Level + Correct Factor.
3. The average measurement was not performed when the peak measured data under the limit of average detection. If the readings given are average, peak measurement should also be supplied.
4. The fundamental for reference only, it's not restricted by unwanted emission limit.

Model No	LVD1	Site	CB2-H
Test Voltage	AC 120V/60Hz	Test Date	2021/5/7
Test Mode	Mode 2: Transmit Adapter_1A100-US1230	Engineer	Rueyyan Lin
Polarity	Horizontal	Temperature (°C)	24.0
Test Condition	BT 2.0,3DH5,Ant0,Ch 0,2.402G	Humidity (%RH)	63.0

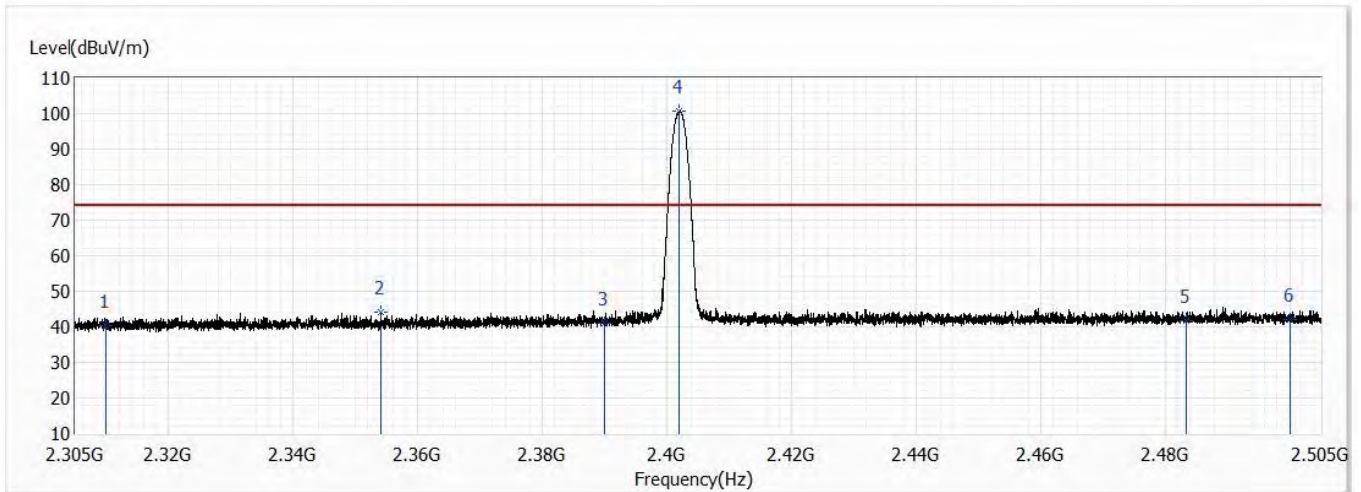

No	Frequency (MHz)	Emission Level (dBuV/m)	Limit (dBuV/m)	Margin (dB)	Reading Level (dBuV)	Correct Factor (dB)	Detector Type
1	2310.000	40.23	74.00	-33.77	27.08	13.15	PK
2	2354.125	44.00	74.00	-30.00	30.55	13.45	PK
3	2390.000	40.89	74.00	-33.11	27.19	13.70	PK
! 4	2402.000	100.68	74.00	26.68	86.89	13.79	PK
5	2483.500	41.57	74.00	-32.43	27.21	14.36	PK
6	2500.000	42.23	74.00	-31.77	27.75	14.48	PK

**Note:**

1. All reading above 1GHz is performed with peak and/or average measurements as necessary.
2. Emission Level = Reading Level + Correct Factor.
3. The average measurement was not performed when the peak measured data under the limit of average detection. If the readings given are average, peak measurement should also be supplied.
4. The fundamental for reference only, it's not restricted by unwanted emission limit.

Model No	LVD1	Site	CB2-H
Test Voltage	AC 120V/60Hz	Test Date	2021/5/7
Test Mode	Mode 2: Transmit Adapter_1A100-US1230	Engineer	Rueyyan Lin
Polarity	Horizontal	Temperature (°C)	24.0
Test Condition	BT 2.0,3DH5,Ant0,Ch 0,2.402G	Humidity (%RH)	63.0

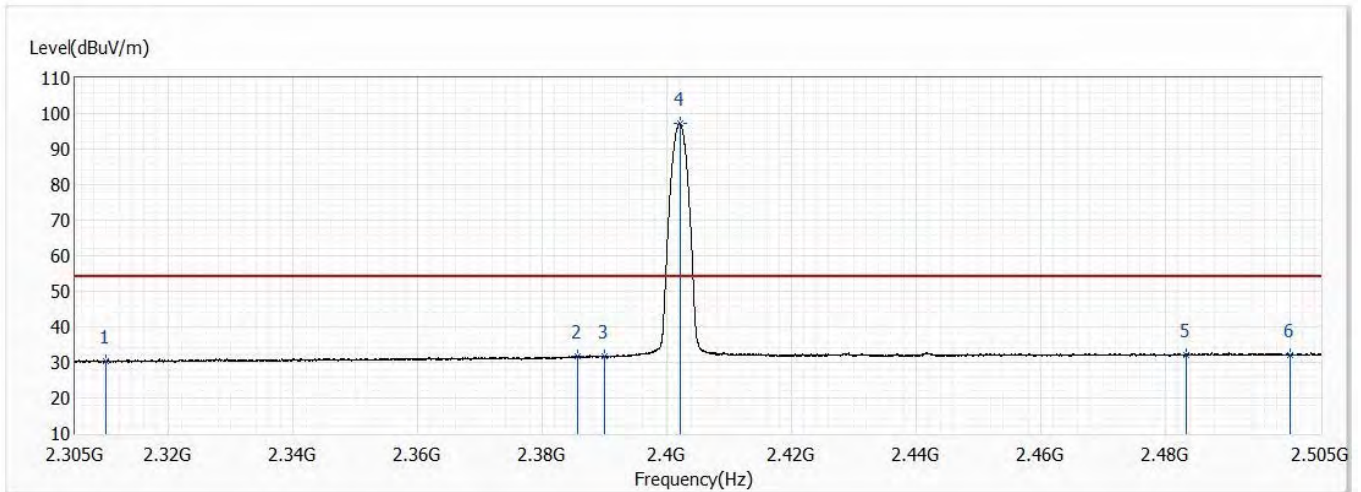

No	Frequency (MHz)	Emission Level (dBuV/m)	Limit (dBuV/m)	Margin (dB)	Reading Level (dBuV)	Correct Factor (dB)	Detector Type
1	2310.000	30.26	54.00	-23.74	17.11	13.15	AV
2	2385.675	31.80	54.00	-22.20	18.13	13.67	AV
3	2390.000	31.72	54.00	-22.28	18.02	13.70	AV
! 4	2402.075	97.19	54.00	43.19	83.40	13.79	AV
5	2483.500	32.23	54.00	-21.77	17.87	14.36	AV
6	2500.000	32.08	54.00	-21.92	17.60	14.48	AV

Note:

1. All reading above 1GHz is performed with peak and/or average measurements as necessary.
2. Emission Level = Reading Level + Correct Factor.
3. The average measurement was not performed when the peak measured data under the limit of average detection. If the readings given are average, peak measurement should also be supplied.
4. The fundamental for reference only, it's not restricted by unwanted emission limit.



Model No	LVD1	Site	CB2-H
Test Voltage	AC 120V/60Hz	Test Date	2021/5/7
Test Mode	Mode 2: Transmit Adapter_1A100-US1230	Engineer	Rueyyan Lin
Polarity	Vertical	Temperature (°C)	24.0
Test Condition	BT 2.0,3DH5,Ant0,Ch 0,2.402G	Humidity (%RH)	63.0

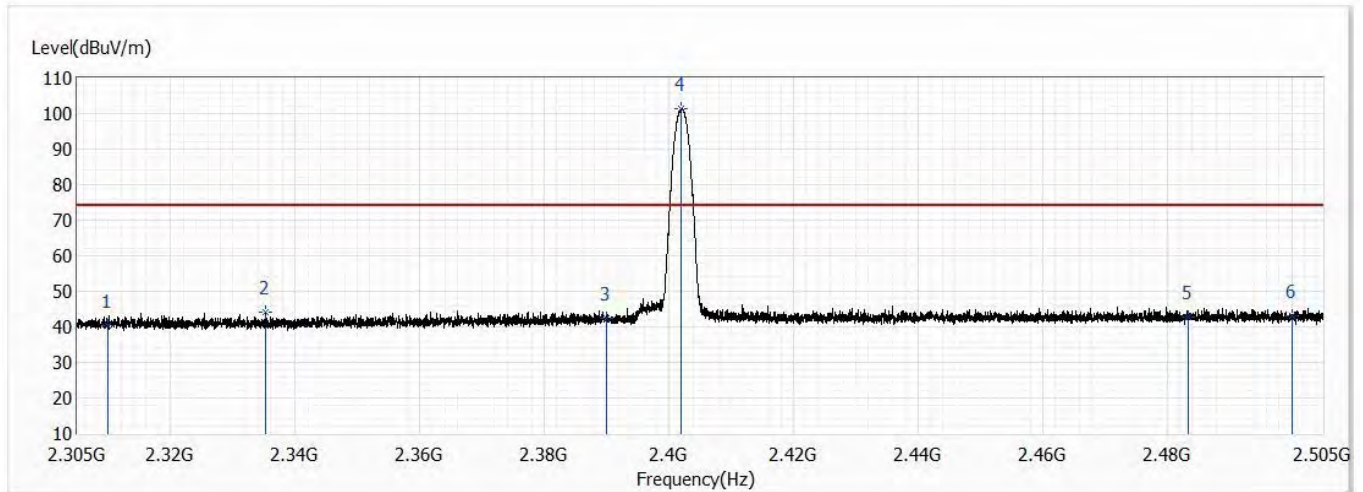

No	Frequency (MHz)	Emission Level (dBuV/m)	Limit (dBuV/m)	Margin (dB)	Reading Level (dBuV)	Correct Factor (dB)	Detector Type
1	2310.000	40.44	74.00	-33.56	27.29	13.15	PK
2	2335.275	44.28	74.00	-29.72	30.96	13.32	PK
3	2390.000	42.40	74.00	-31.60	28.70	13.70	PK
! 4	2402.025	101.46	74.00	27.46	87.67	13.79	PK
5	2483.500	42.64	74.00	-31.36	28.28	14.36	PK
6	2500.000	43.27	74.00	-30.73	28.79	14.48	PK

**Note:**

1. All reading above 1GHz is performed with peak and/or average measurements as necessary.
2. Emission Level = Reading Level + Correct Factor.
3. The average measurement was not performed when the peak measured data under the limit of average detection. If the readings given are average, peak measurement should also be supplied.
4. The fundamental for reference only, it's not restricted by unwanted emission limit.

Model No	LVD1	Site	CB2-H
Test Voltage	AC 120V/60Hz	Test Date	2021/5/7
Test Mode	Mode 2: Transmit Adapter_1A100-US1230	Engineer	Rueyyan Lin
Polarity	Vertical	Temperature (°C)	24.0
Test Condition	BT 2.0,3DH5,Ant0,Ch 0,2.402G	Humidity (%RH)	63.0

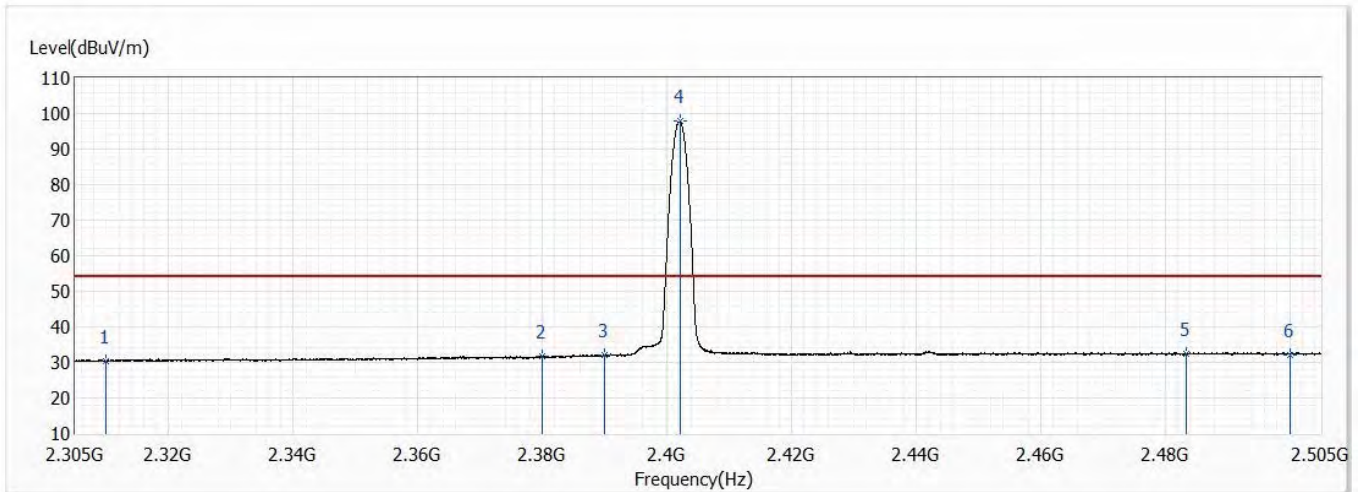

No	Frequency (MHz)	Emission Level (dBuV/m)	Limit (dBuV/m)	Margin (dB)	Reading Level (dBuV)	Correct Factor (dB)	Detector Type
1	2310.000	30.49	54.00	-23.51	17.34	13.15	AV
2	2379.950	31.82	54.00	-22.18	18.19	13.63	AV
3	2390.000	32.04	54.00	-21.96	18.34	13.70	AV
! 4	2402.125	97.80	54.00	43.80	84.01	13.79	AV
5	2483.500	32.34	54.00	-21.66	17.98	14.36	AV
6	2500.000	32.23	54.00	-21.77	17.75	14.48	AV

**Note:**

1. All reading above 1GHz is performed with peak and/or average measurements as necessary.
2. Emission Level = Reading Level + Correct Factor.
3. The average measurement was not performed when the peak measured data under the limit of average detection. If the readings given are average, peak measurement should also be supplied.
4. The fundamental for reference only, it's not restricted by unwanted emission limit.

Model No	LVD1	Site	CB2-H
Test Voltage	AC 120V/60Hz	Test Date	2021/5/7
Test Mode	Mode 2: Transmit Adapter_1A100-US1230	Engineer	Rueyyan Lin
Polarity	Horizontal	Temperature (°C)	24.0
Test Condition	BT 2.0,3DH5,Ant0,Ch 39,2.441G	Humidity (%RH)	63.0

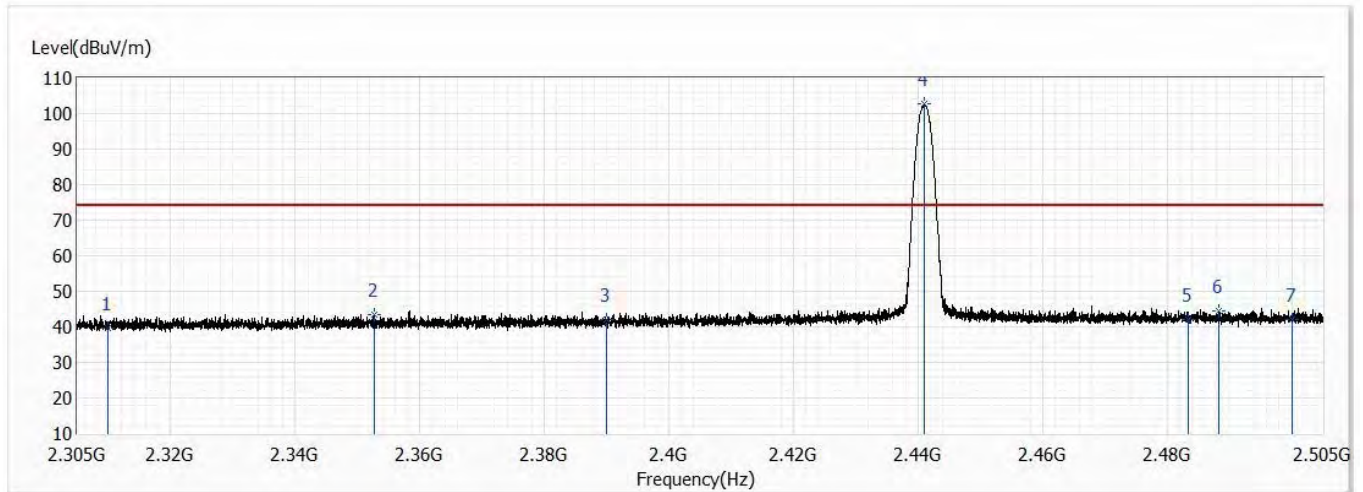

No	Frequency (MHz)	Emission Level (dBuV/m)	Limit (dBuV/m)	Margin (dB)	Reading Level (dBuV)	Correct Factor (dB)	Detector Type
1	2310.000	39.82	74.00	-34.18	26.67	13.15	PK
2	2352.775	43.39	74.00	-30.61	29.95	13.44	PK
3	2390.000	42.18	74.00	-31.82	28.48	13.70	PK
! 4	2441.000	102.67	74.00	28.67	88.61	14.06	PK
5	2483.500	42.24	74.00	-31.76	27.88	14.36	PK
6	2488.400	44.61	74.00	-29.39	30.21	14.40	PK
7	2500.000	42.04	74.00	-31.96	27.56	14.48	PK

Note:

1. All reading above 1GHz is performed with peak and/or average measurements as necessary.
2. Emission Level = Reading Level + Correct Factor.
3. The average measurement was not performed when the peak measured data under the limit of average detection. If the readings given are average, peak measurement should also be supplied.
4. The fundamental for reference only, it's not restricted by unwanted emission limit.

Model No	LVD1	Site	CB2-H
Test Voltage	AC 120V/60Hz	Test Date	2021/5/7
Test Mode	Mode 2: Transmit Adapter_1A100-US1230	Engineer	Rueyyan Lin
Polarity	Horizontal	Temperature (°C)	24.0
Test Condition	BT 2.0,3DH5,Ant0,Ch 39,2.441G	Humidity (%RH)	63.0

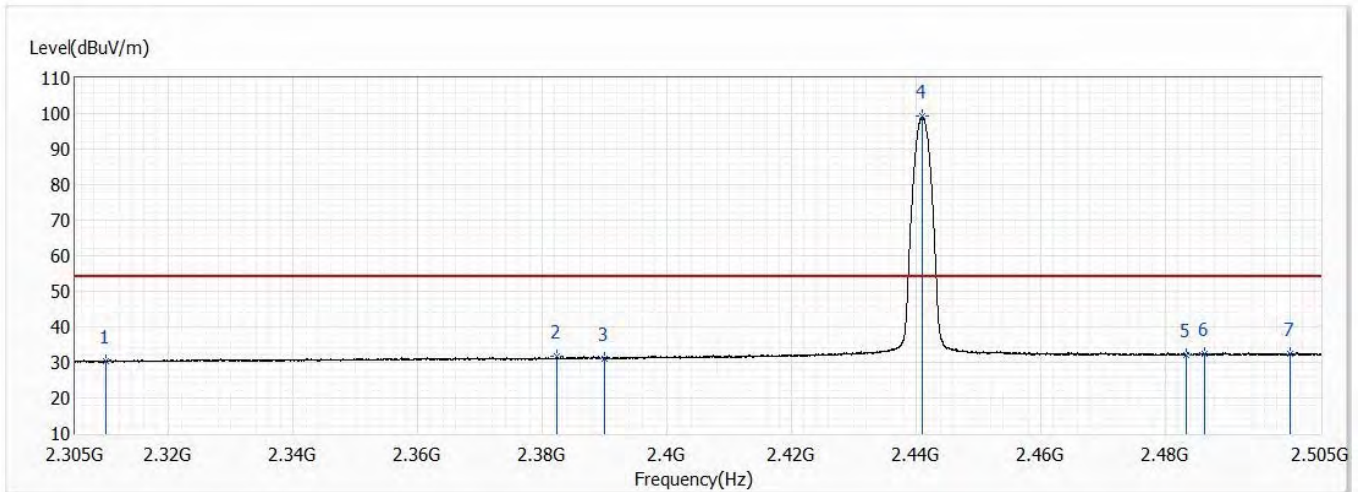

No	Frequency (MHz)	Emission Level (dBuV/m)	Limit (dBuV/m)	Margin (dB)	Reading Level (dBuV)	Correct Factor (dB)	Detector Type
1	2310.000	30.32	54.00	-23.68	17.17	13.15	AV
2	2382.250	31.58	54.00	-22.42	17.92	13.66	AV
3	2390.000	31.12	54.00	-22.88	17.42	13.70	AV
! 4	2441.025	99.20	54.00	45.20	85.14	14.06	AV
5	2483.500	32.23	54.00	-21.77	17.87	14.36	AV
6	2486.375	32.55	54.00	-21.45	18.16	14.39	AV
7	2500.000	32.30	54.00	-21.70	17.82	14.48	AV

Note:

1. All reading above 1GHz is performed with peak and/or average measurements as necessary.
2. Emission Level = Reading Level + Correct Factor.
3. The average measurement was not performed when the peak measured data under the limit of average detection. If the readings given are average, peak measurement should also be supplied.
4. The fundamental for reference only, it's not restricted by unwanted emission limit.

Model No	LVD1	Site	CB2-H
Test Voltage	AC 120V/60Hz	Test Date	2021/5/7
Test Mode	Mode 2: Transmit Adapter_1A100-US1230	Engineer	Rueyyan Lin
Polarity	Vertical	Temperature (°C)	24.0
Test Condition	BT 2.0,3DH5,Ant0,Ch 39,2.441G	Humidity (%RH)	63.0

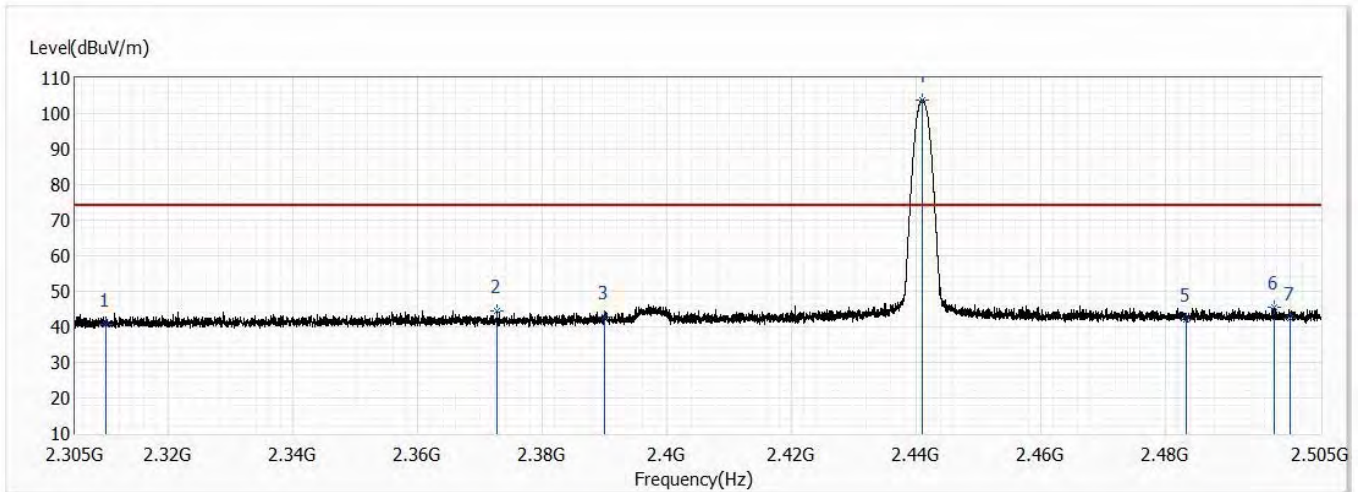

No	Frequency (MHz)	Emission Level (dBuV/m)	Limit (dBuV/m)	Margin (dB)	Reading Level (dBuV)	Correct Factor (dB)	Detector Type
1	2310.000	40.73	74.00	-33.27	27.58	13.15	PK
2	2372.650	44.42	74.00	-29.58	30.84	13.58	PK
3	2390.000	42.61	74.00	-31.39	28.91	13.70	PK
! 4	2441.050	103.92	74.00	29.92	89.86	14.06	PK
5	2483.500	42.16	74.00	-31.84	27.80	14.36	PK
6	2497.475	45.66	74.00	-28.34	31.20	14.46	PK
7	2500.000	42.56	74.00	-31.44	28.08	14.48	PK

Note:

1. All reading above 1GHz is performed with peak and/or average measurements as necessary.
2. Emission Level = Reading Level + Correct Factor.
3. The average measurement was not performed when the peak measured data under the limit of average detection. If the readings given are average, peak measurement should also be supplied.
4. The fundamental for reference only, it's not restricted by unwanted emission limit.

Model No	LVD1	Site	CB2-H
Test Voltage	AC 120V/60Hz	Test Date	2021/5/7
Test Mode	Mode 2: Transmit Adapter_1A100-US1230	Engineer	Rueyyan Lin
Polarity	Vertical	Temperature (°C)	24.0
Test Condition	BT 2.0,3DH5,Ant0,Ch 39,2.441G	Humidity (%RH)	63.0

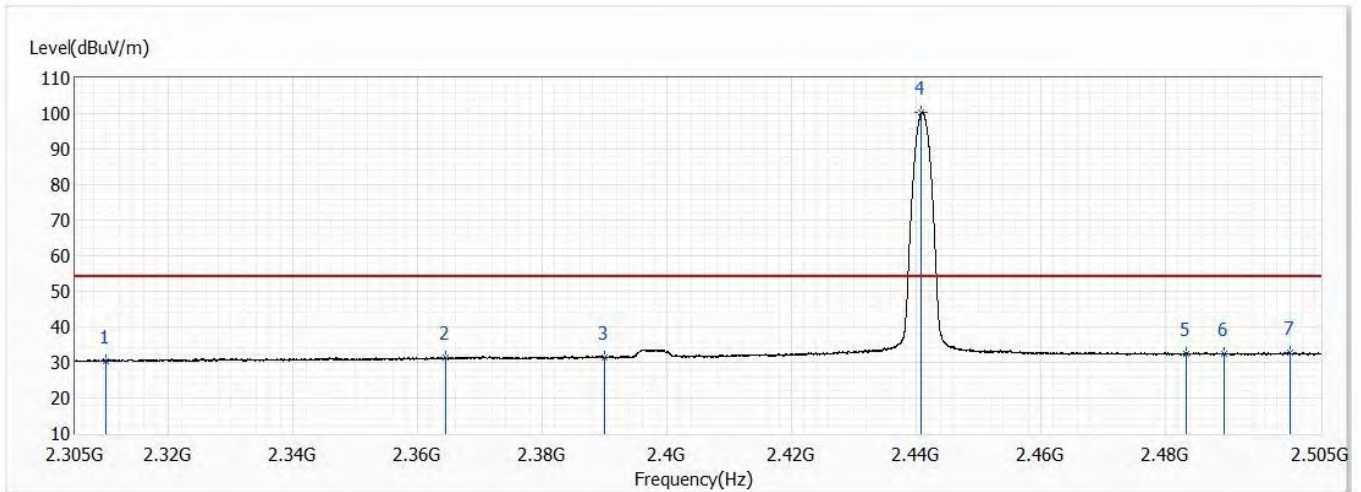

No	Frequency (MHz)	Emission Level (dBuV/m)	Limit (dBuV/m)	Margin (dB)	Reading Level (dBuV)	Correct Factor (dB)	Detector Type
1	2310.000	30.51	54.00	-23.49	17.36	13.15	AV
2	2364.475	31.29	54.00	-22.71	17.76	13.53	AV
3	2390.000	31.53	54.00	-22.47	17.83	13.70	AV
! 4	2440.900	100.32	54.00	46.32	86.26	14.06	AV
5	2483.500	32.32	54.00	-21.68	17.96	14.36	AV
6	2489.475	32.57	54.00	-21.43	18.17	14.40	AV
7	2500.000	32.59	54.00	-21.41	18.11	14.48	AV

Note:

1. All reading above 1GHz is performed with peak and/or average measurements as necessary.
2. Emission Level = Reading Level + Correct Factor.
3. The average measurement was not performed when the peak measured data under the limit of average detection. If the readings given are average, peak measurement should also be supplied.
4. The fundamental for reference only, it's not restricted by unwanted emission limit.

Model No	LVD1	Site	CB2-H
Test Voltage	AC 120V/60Hz	Test Date	2021/5/7
Test Mode	Mode 2: Transmit Adapter_1A100-US1230	Engineer	Rueyyan Lin
Polarity	Horizontal	Temperature (°C)	24.0
Test Condition	BT 2.0,3DH5,Ant0,Ch 78,2.48G	Humidity (%RH)	63.0

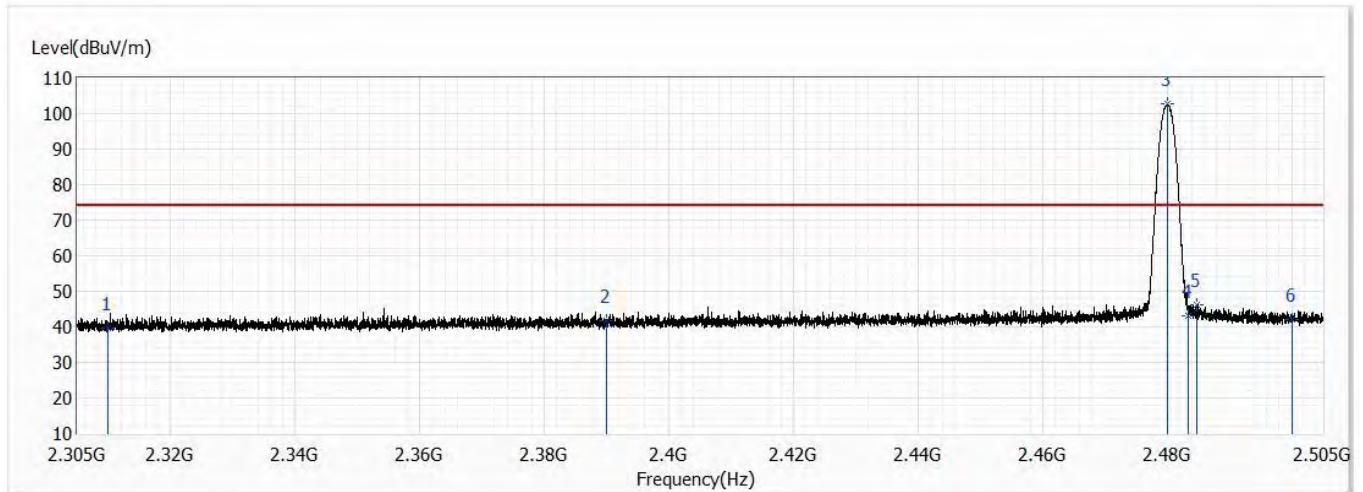

No	Frequency (MHz)	Emission Level (dBuV/m)	Limit (dBuV/m)	Margin (dB)	Reading Level (dBuV)	Correct Factor (dB)	Detector Type
1	2310.000	39.76	74.00	-34.24	26.61	13.15	PK
2	2390.000	41.73	74.00	-32.27	28.03	13.70	PK
! 3	2480.000	102.68	74.00	28.68	88.34	14.34	PK
4	2483.500	43.08	74.00	-30.92	28.72	14.36	PK
5	2484.875	46.28	74.00	-27.72	31.91	14.37	PK
6	2500.000	41.99	74.00	-32.01	27.51	14.48	PK

**Note:**

1. All reading above 1GHz is performed with peak and/or average measurements as necessary.
2. Emission Level = Reading Level + Correct Factor.
3. The average measurement was not performed when the peak measured data under the limit of average detection. If the readings given are average, peak measurement should also be supplied.
4. The fundamental for reference only, it's not restricted by unwanted emission limit.

Model No	LVD1	Site	CB2-H
Test Voltage	AC 120V/60Hz	Test Date	2021/5/7
Test Mode	Mode 2: Transmit Adapter_1A100-US1230	Engineer	Rueyyan Lin
Polarity	Horizontal	Temperature (°C)	24.0
Test Condition	BT 2.0,3DH5,Ant0,Ch 78,2.48G	Humidity (%RH)	63.0

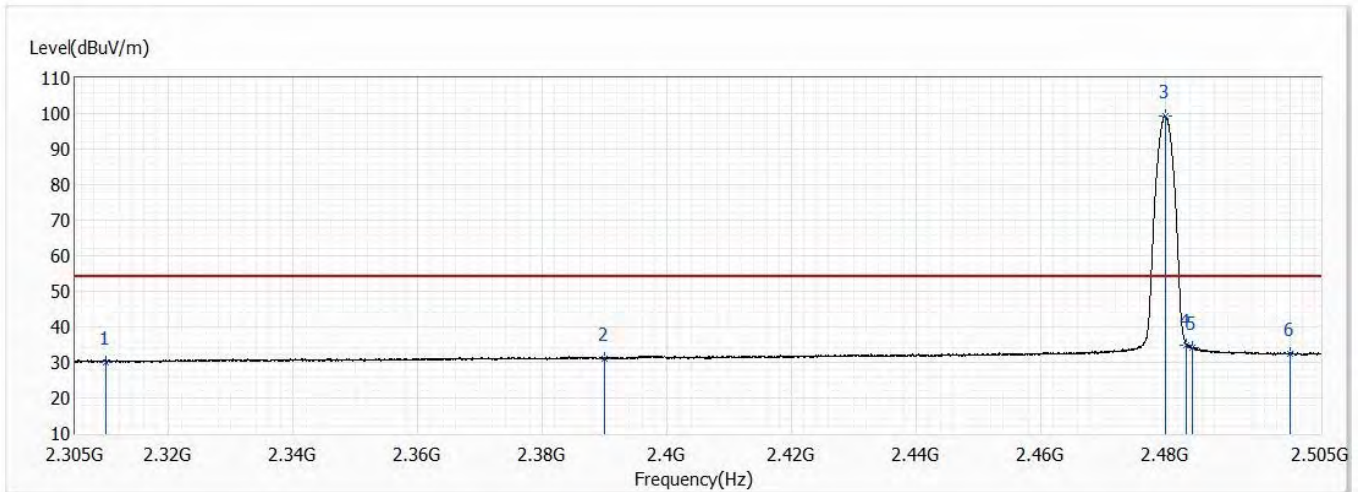

No	Frequency (MHz)	Emission Level (dBuV/m)	Limit (dBuV/m)	Margin (dB)	Reading Level (dBuV)	Correct Factor (dB)	Detector Type
1	2310.000	30.13	54.00	-23.87	16.98	13.15	AV
2	2390.000	31.10	54.00	-22.90	17.40	13.70	AV
! 3	2480.000	99.31	54.00	45.31	84.97	14.34	AV
4	2483.500	34.94	54.00	-19.06	20.58	14.36	AV
5	2484.325	34.09	54.00	-19.91	19.73	14.36	AV
6	2500.000	32.36	54.00	-21.64	17.88	14.48	AV

**Note:**

1. All reading above 1GHz is performed with peak and/or average measurements as necessary.
2. Emission Level = Reading Level + Correct Factor.
3. The average measurement was not performed when the peak measured data under the limit of average detection. If the readings given are average, peak measurement should also be supplied.
4. The fundamental for reference only, it's not restricted by unwanted emission limit.



Model No	LVD1	Site	CB2-H
Test Voltage	AC 120V/60Hz	Test Date	2021/5/7
Test Mode	Mode 2: Transmit Adapter_1A100-US1230	Engineer	Rueyyan Lin
Polarity	Vertical	Temperature (°C)	24.0
Test Condition	BT 2.0,3DH5,Ant0,Ch 78,2.48G	Humidity (%RH)	63.0

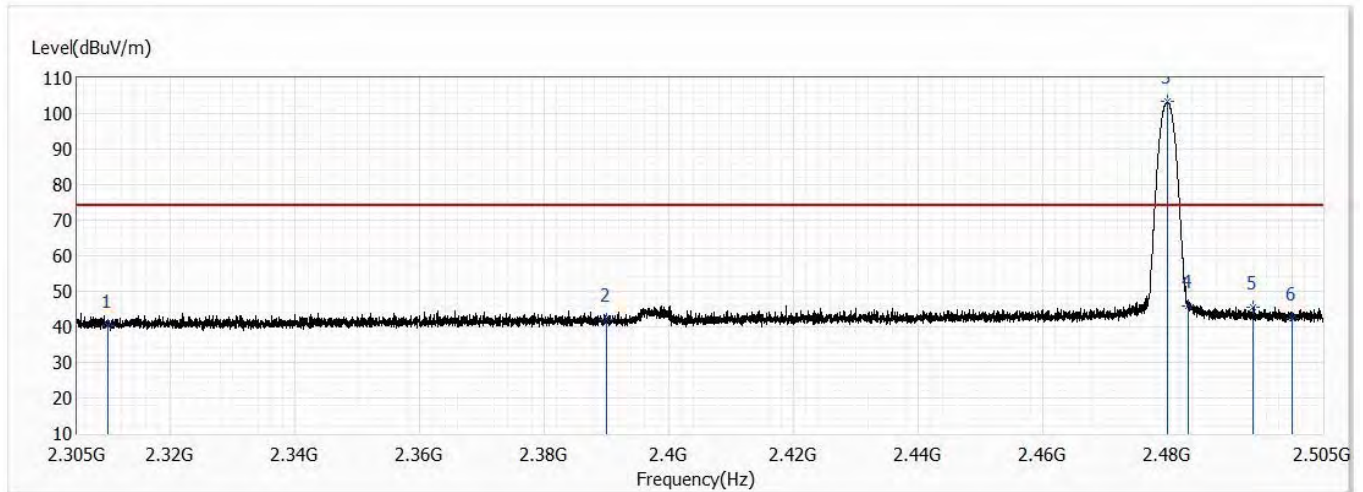

No	Frequency (MHz)	Emission Level (dBuV/m)	Limit (dBuV/m)	Margin (dB)	Reading Level (dBuV)	Correct Factor (dB)	Detector Type
1	2310.000	40.51	74.00	-33.49	27.36	13.15	PK
2	2390.000	41.92	74.00	-32.08	28.22	13.70	PK
! 3	2480.050	103.39	74.00	29.39	89.05	14.34	PK
4	2483.500	45.76	74.00	-28.24	31.40	14.36	PK
5	2493.750	45.64	74.00	-28.36	31.20	14.44	PK
6	2500.000	42.56	74.00	-31.44	28.08	14.48	PK

**Note:**

1. All reading above 1GHz is performed with peak and/or average measurements as necessary.
2. Emission Level = Reading Level + Correct Factor.
3. The average measurement was not performed when the peak measured data under the limit of average detection. If the readings given are average, peak measurement should also be supplied.
4. The fundamental for reference only, it's not restricted by unwanted emission limit.

Model No	LVD1	Site	CB2-H
Test Voltage	AC 120V/60Hz	Test Date	2021/5/7
Test Mode	Mode 2: Transmit Adapter_1A100-US1230	Engineer	Rueyyan Lin
Polarity	Vertical	Temperature (°C)	24.0
Test Condition	BT 2.0,3DH5,Ant0,Ch 78,2.48G	Humidity (%RH)	63.0

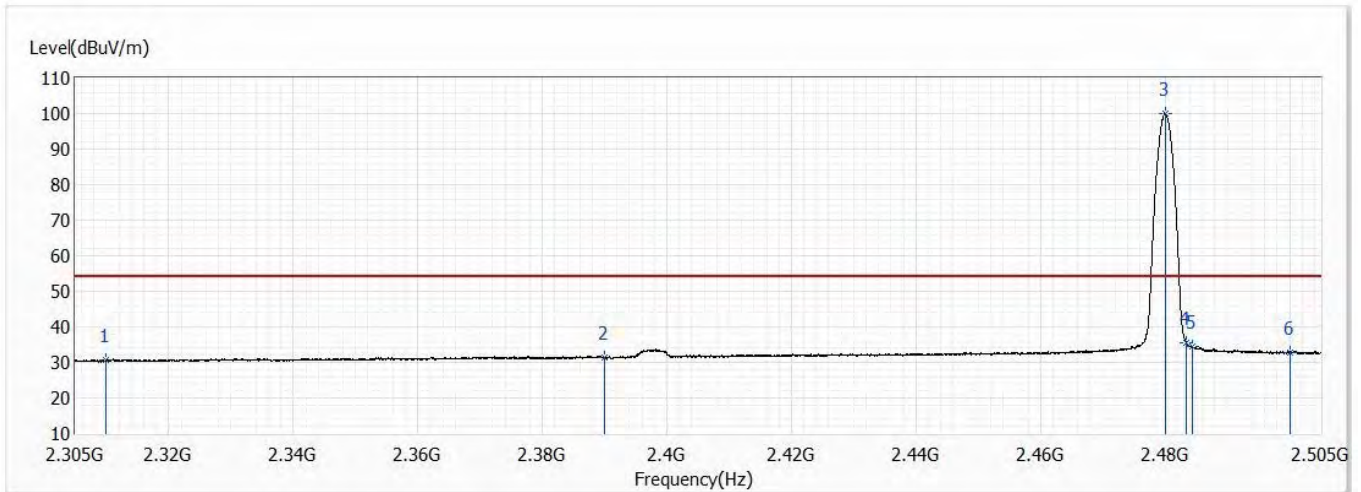

No	Frequency (MHz)	Emission Level (dBuV/m)	Limit (dBuV/m)	Margin (dB)	Reading Level (dBuV)	Correct Factor (dB)	Detector Type
1	2310.000	30.54	54.00	-23.46	17.39	13.15	AV
2	2390.000	31.30	54.00	-22.70	17.60	13.70	AV
! 3	2480.050	99.94	54.00	45.94	85.60	14.34	AV
4	2483.500	35.37	54.00	-18.63	21.01	14.36	AV
5	2484.375	34.37	54.00	-19.63	20.01	14.36	AV
6	2500.000	32.92	54.00	-21.08	18.44	14.48	AV

Note:

1. All reading above 1GHz is performed with peak and/or average measurements as necessary.
2. Emission Level = Reading Level + Correct Factor.
3. The average measurement was not performed when the peak measured data under the limit of average detection. If the readings given are average, peak measurement should also be supplied.
4. The fundamental for reference only, it's not restricted by unwanted emission limit.

Model No	LVD1	Site	CB2-H
Test Voltage	AC 120V/60Hz	Test Date	2021/5/10
Test Mode	Mode 2: Transmit Adapter_1A100-US1230	Engineer	Ling Chen
Polarity	Horizontal	Temperature (°C)	24.0
Test Condition	BT 2.0,DH5,Ant0,Hopping	Humidity (%RH)	63.0

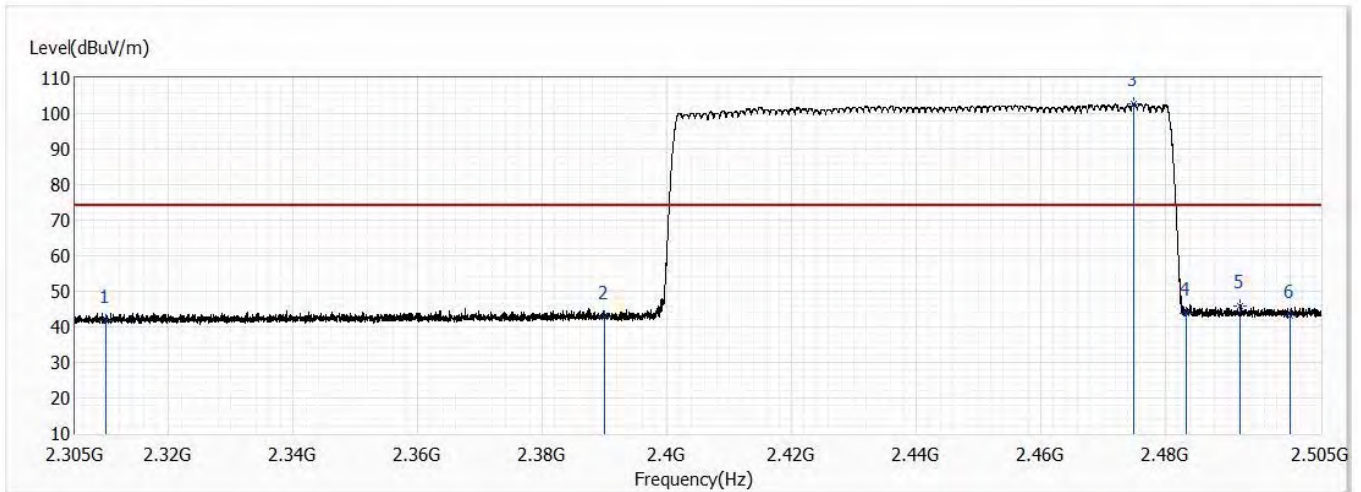

No	Frequency (MHz)	Emission Level (dBuV/m)	Limit (dBuV/m)	Margin (dB)	Reading Level (dBuV)	Correct Factor (dB)	Detector Type
1	2310.000	41.86	74.00	-32.14	28.71	13.15	PK
2	2390.000	42.86	74.00	-31.14	29.16	13.70	PK
! 3	2474.975	102.70	74.00	28.70	88.40	14.30	PK
4	2483.500	43.70	74.00	-30.30	29.34	14.36	PK
5	2491.975	46.02	74.00	-27.98	31.59	14.43	PK
6	2500.000	43.23	74.00	-30.77	28.75	14.48	PK

Note:

1. All reading above 1GHz is performed with peak and/or average measurements as necessary.
2. Emission Level = Reading Level + Correct Factor.
3. The average measurement was not performed when the peak measured data under the limit of average detection. If the readings given are average, peak measurement should also be supplied.
4. The fundamental for reference only, it's not restricted by unwanted emission limit.

Model No	LVD1	Site	CB2-H
Test Voltage	AC 120V/60Hz	Test Date	2021/5/10
Test Mode	Mode 2: Transmit Adapter_1A100-US1230	Engineer	Ling Chen
Polarity	Vertical	Temperature (°C)	24.0
Test Condition	BT 2.0,DH5,Ant0,Hopping	Humidity (%RH)	63.0

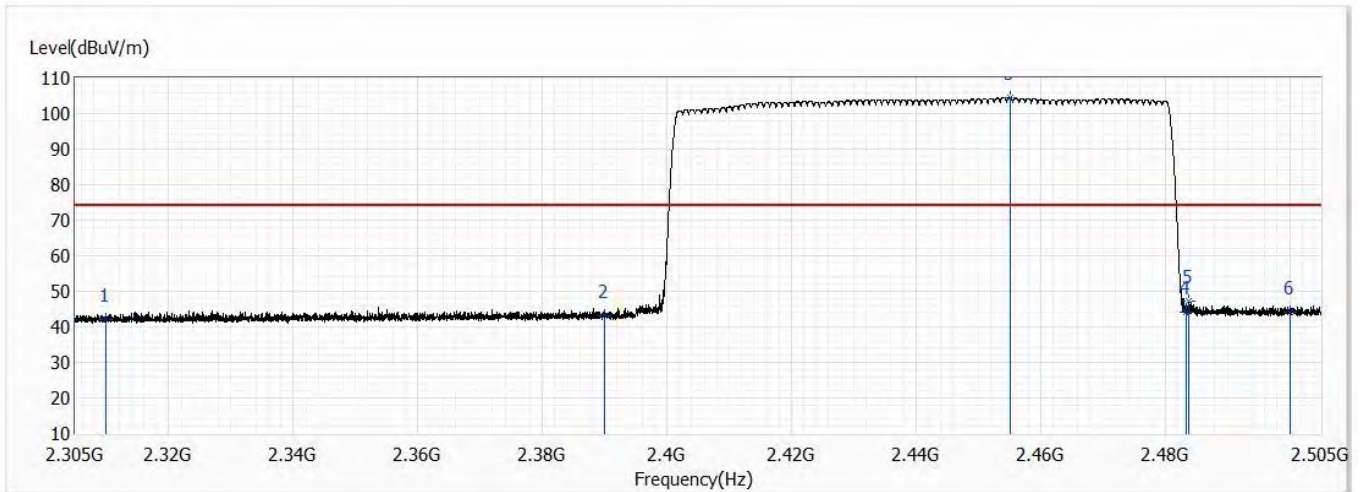

No	Frequency (MHz)	Emission Level (dBuV/m)	Limit (dBuV/m)	Margin (dB)	Reading Level (dBuV)	Correct Factor (dB)	Detector Type
1	2310.000	42.05	74.00	-31.95	28.90	13.15	PK
2	2390.000	43.05	74.00	-30.95	29.35	13.70	PK
! 3	2455.100	104.42	74.00	30.42	90.25	14.17	PK
4	2483.500	44.12	74.00	-29.88	29.76	14.36	PK
5	2483.875	47.34	74.00	-26.66	32.98	14.36	PK
6	2500.000	44.23	74.00	-29.77	29.75	14.48	PK

**Note:**

1. All reading above 1GHz is performed with peak and/or average measurements as necessary.
2. Emission Level = Reading Level + Correct Factor.
3. The average measurement was not performed when the peak measured data under the limit of average detection. If the readings given are average, peak measurement should also be supplied.
4. The fundamental for reference only, it's not restricted by unwanted emission limit.

Model No	LVD1	Site	CB2-H
Test Voltage	AC 120V/60Hz	Test Date	2021/5/10
Test Mode	Mode 2: Transmit Adapter_1A100-US1230	Engineer	Ling Chen
Polarity	Horizontal	Temperature (°C)	24.0
Test Condition	BT 2.0,3DH5,Ant0,Hopping	Humidity (%RH)	63.0

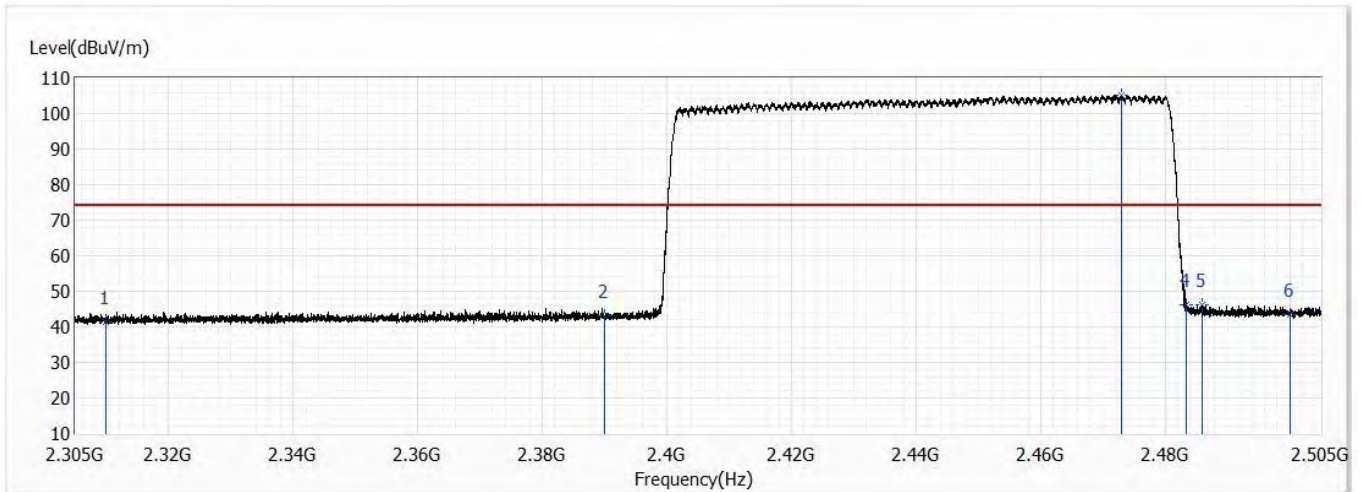

No	Frequency (MHz)	Emission Level (dBuV/m)	Limit (dBuV/m)	Margin (dB)	Reading Level (dBuV)	Correct Factor (dB)	Detector Type
1	2310.000	41.27	74.00	-32.73	28.12	13.15	PK
2	2390.000	43.10	74.00	-30.90	29.40	13.70	PK
! 3	2473.000	105.14	74.00	31.14	90.86	14.28	PK
4	2483.500	46.10	74.00	-27.90	31.74	14.36	PK
5	2486.050	46.16	74.00	-27.84	31.78	14.38	PK
6	2500.000	43.36	74.00	-30.64	28.88	14.48	PK

Note:

1. All reading above 1GHz is performed with peak and/or average measurements as necessary.
2. Emission Level = Reading Level + Correct Factor.
3. The average measurement was not performed when the peak measured data under the limit of average detection. If the readings given are average, peak measurement should also be supplied.
4. The fundamental for reference only, it's not restricted by unwanted emission limit.

Model No	LVD1	Site	CB2-H
Test Voltage	AC 120V/60Hz	Test Date	2021/5/10
Test Mode	Mode 2: Transmit Adapter_1A100-US1230	Engineer	Ling Chen
Polarity	Vertical	Temperature (°C)	24.0
Test Condition	BT 2.0,3DH5,Ant0,Hopping	Humidity (%RH)	63.0

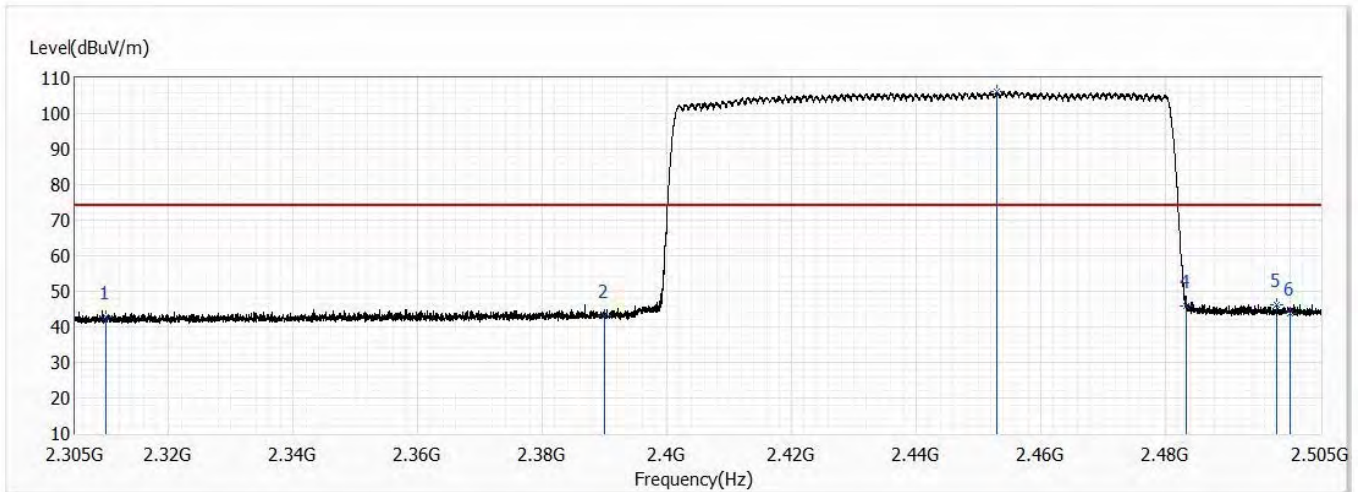

No	Frequency (MHz)	Emission Level (dBuV/m)	Limit (dBuV/m)	Margin (dB)	Reading Level (dBuV)	Correct Factor (dB)	Detector Type
1	2310.000	42.70	74.00	-31.30	29.55	13.15	PK
2	2390.000	43.06	74.00	-30.94	29.36	13.70	PK
! 3	2452.950	106.23	74.00	32.23	92.08	14.15	PK
4	2483.500	45.99	74.00	-28.01	31.63	14.36	PK
5	2497.950	46.30	74.00	-27.70	31.83	14.47	PK
6	2500.000	43.80	74.00	-30.20	29.32	14.48	PK

Note:

1. All reading above 1GHz is performed with peak and/or average measurements as necessary.
2. Emission Level = Reading Level + Correct Factor.
3. The average measurement was not performed when the peak measured data under the limit of average detection. If the readings given are average, peak measurement should also be supplied.
4. The fundamental for reference only, it's not restricted by unwanted emission limit.

## 7. Number of hopping frequency

### 7.1. Test Setup

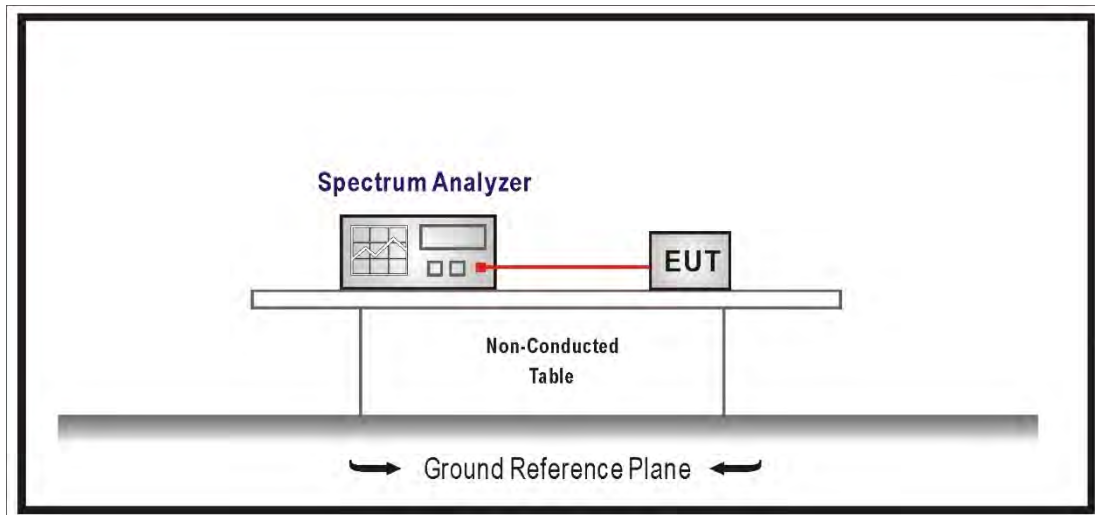

### 7.2. Limits

For frequency hopping systems operating in the 902-928 MHz band: if the 20 dB bandwidth of the hopping channel is less than 250 kHz, the system shall use at least 50 hopping frequencies and the average time of occupancy on any frequency shall not be greater than 0.4 seconds within a 20 second period; if the 20 dB bandwidth of the hopping channel is 250 kHz or greater, the system shall use at least 25 hopping frequencies and the average time of occupancy on any frequency shall not be greater than 0.4 seconds within a 10 second period. The maximum allowed 20 dB bandwidth of the hopping channel is 500 kHz.

Frequency hopping systems in the 2400-2483.5 MHz band shall use at least 15 channels. The average time of occupancy on any channel shall not be greater than 0.4 seconds within a period of 0.4 seconds multiplied by the number of hopping channels employed. Frequency hopping systems may avoid or suppress transmissions on a particular hopping frequency provided that a minimum of 15 channels are used.

Frequency hopping systems operating in the 5725-5850 MHz band shall use at least 75 hopping frequencies. The maximum 20 dB bandwidth of the hopping channel is 1 MHz. The average time of occupancy on any frequency shall not be greater than 0.4 seconds within a 30 second period.

---

### **7.3. Test Procedures**

The EUT was setup according to ANSI C63.10: 2013 and tested according to FHSS test procedure of FCC KDB 558074 D01 v05r02 for compliance to FCC 47CFR 15.247 requirements.

### **7.4. Test Specification**

According to FCC Part 15 Subpart C Paragraph 15.247: 2019



### 7.5. Test Result

Product	Smart Display		
Test Item	Number of hopping frequency		
Test Mode	Mode 2: Transmit_Adapter_1A100-US1230		
Date of Test	2021/05/12	Test Site	SR12-H
Temperature(°C)	24.0	Humidity (%RH)	68.0

Frequency Range (MHz)	Measure Level (Channels)	Limit (Channels)
2402 - 2480	79	≥ 75

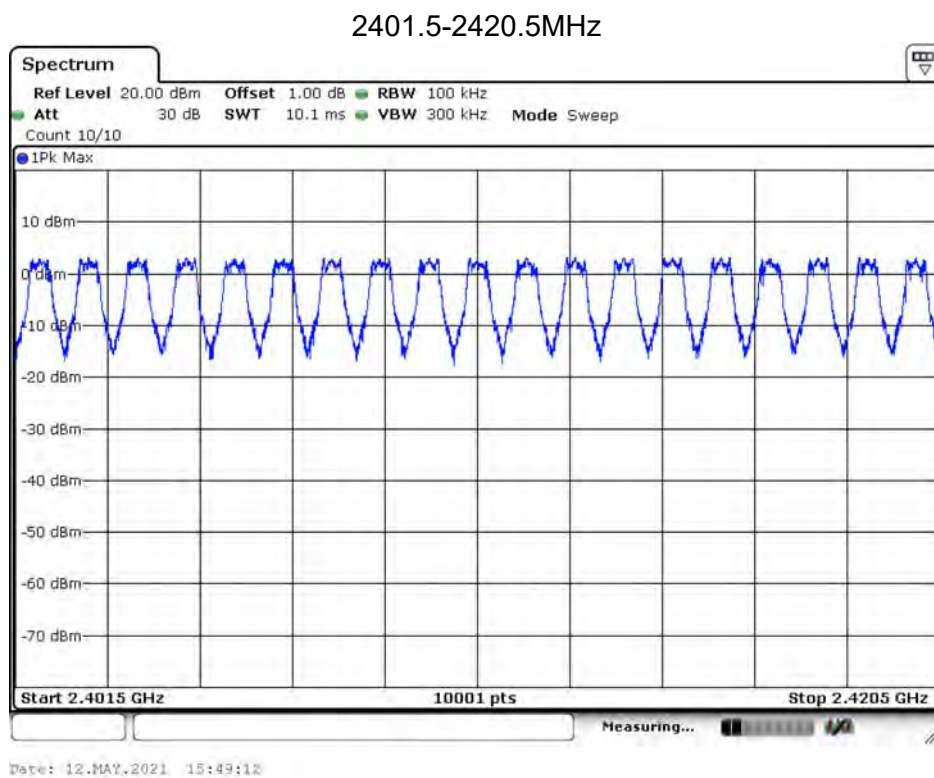

### 2420.5-2440.5MHz

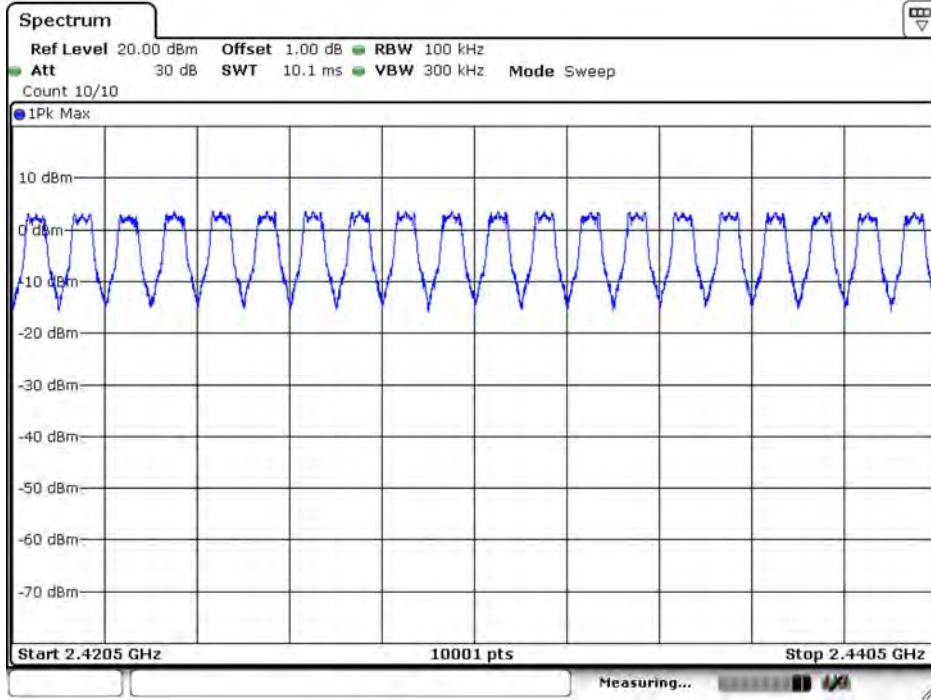

Date: 12.MAY.2021 15:57:04

### 2440.5-2460.5MHz

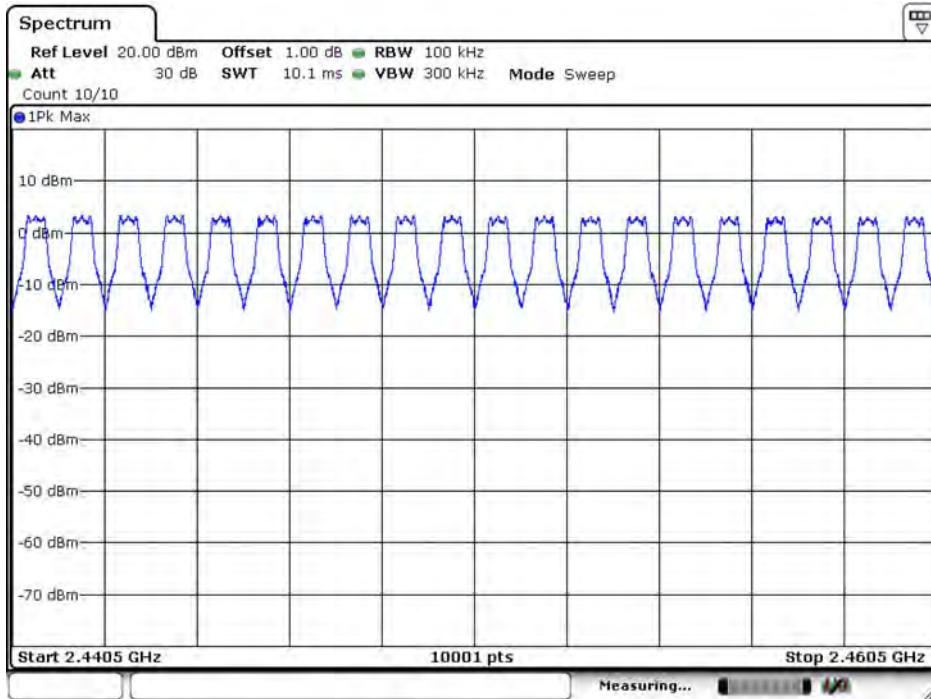

Date: 12.MAY.2021 16:12:20

2460.5-2480.5MHz

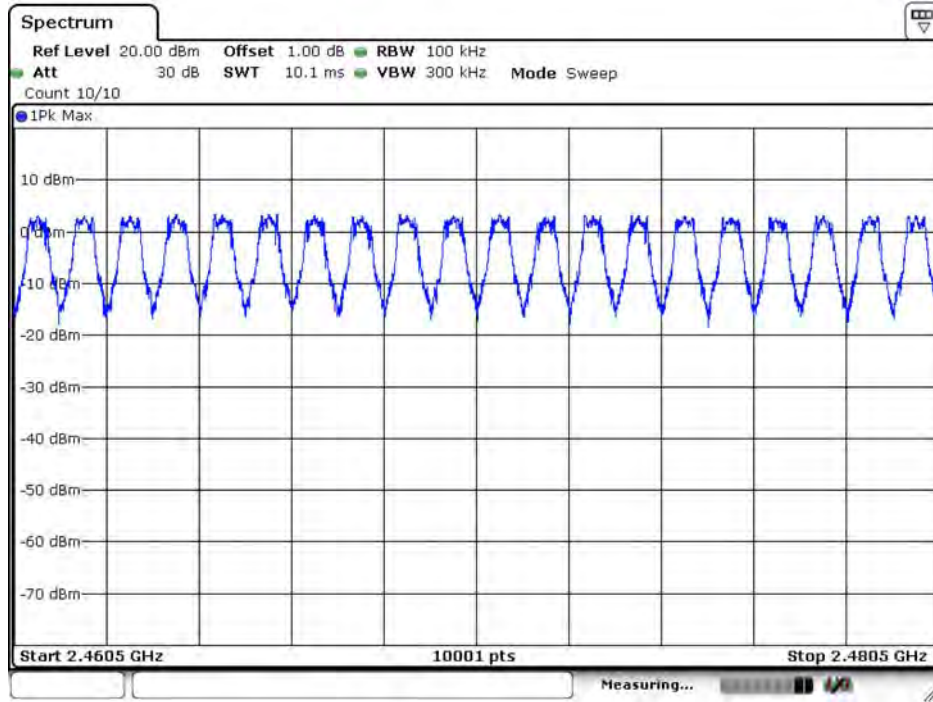

Date: 12.MAY.2021 16:15:43

## 8. Carrier Frequency Separation

### 8.1. Test Setup

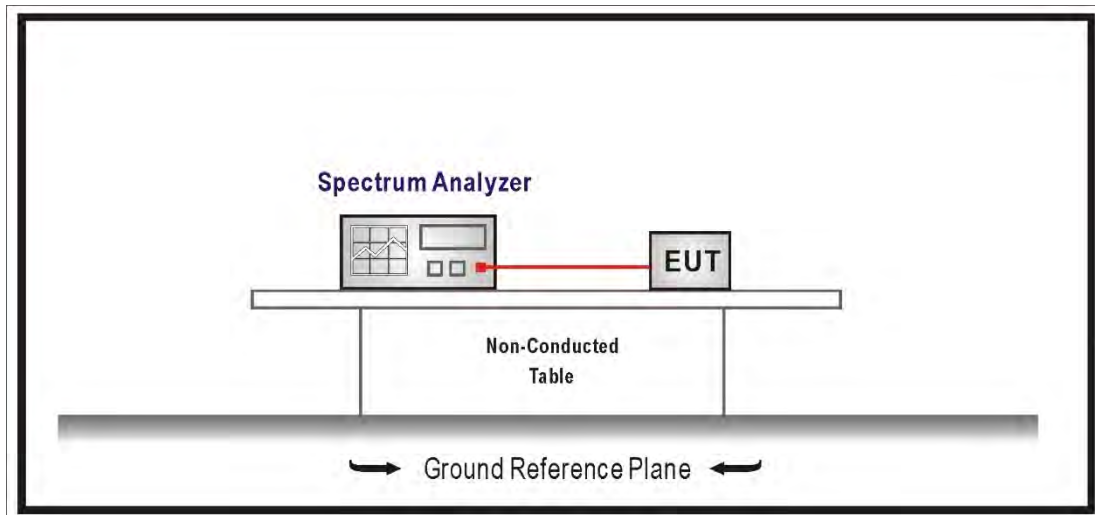

### 8.2. Limits

Frequency hopping systems shall have hopping channel carrier frequencies separated by a minimum of 25 kHz or the 20 dB bandwidth of the hopping channel, whichever is greater. Alternatively, frequency hopping systems operating in the 2400-2483.5 MHz band may have hopping channel carrier frequencies that are separated by 25 kHz or two-thirds of the 20 dB bandwidth of the hopping channel, whichever is greater, provided the systems operate with an Maximum peak conducted output power no greater than 125 mW. The system shall hop to channel frequencies that are selected at the system hopping rate from a pseudo randomly ordered list of hopping frequencies. Each frequency must be used equally on the average by each transmitter. The system receivers shall have input bandwidths that match the hopping channel bandwidths of their corresponding transmitters and shall shift frequencies in synchronization with the transmitted signals.

### 8.3. Test Procedures

The EUT was setup according to ANSI C63.10: 2013 and tested according to FHSS test procedure of FCC KDB 558074 D01 v05r02 for compliance to FCC 47CFR 15.247 requirements.

### 8.4. Test Specification

According to FCC Part 15 Subpart C Paragraph 15.247: 2019

### 8.5. Test Result

Product	Smart Display		
Test Item	Carrier Frequency Separation		
Test Mode	Mode 2: Transmit_Adapter_1A100-US1230		
Date of Test	2021/05/12	Test Site	SR12-H
Temperature(°C)	24.0	Humidity (%RH)	68.0

#### GFSK

Channel No.	Frequency (MHz)	Measure Level (MHz)	Limit (MHz)
00	2402	1.003	$\geq 0.685$
39	2441	1.000	$\geq 0.684$
78	2480	1.000	$\geq 0.684$

#### 8-DPSK

Channel No.	Frequency (MHz)	Measure Level (MHz)	Limit (MHz)
00	2402	1.000	$\geq 0.867$
39	2441	1.000	$\geq 0.867$
78	2480	1.000	$\geq 0.864$

### Channel 00\_GFSK

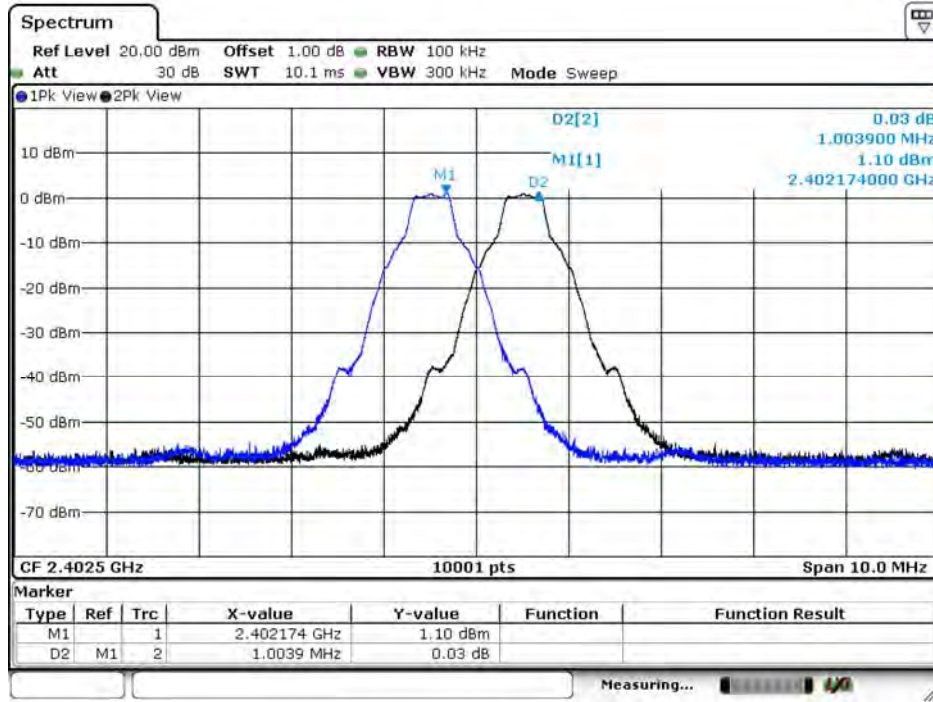

Date: 12.MAY.2021 14:27:53

### Channel 39\_GFSK

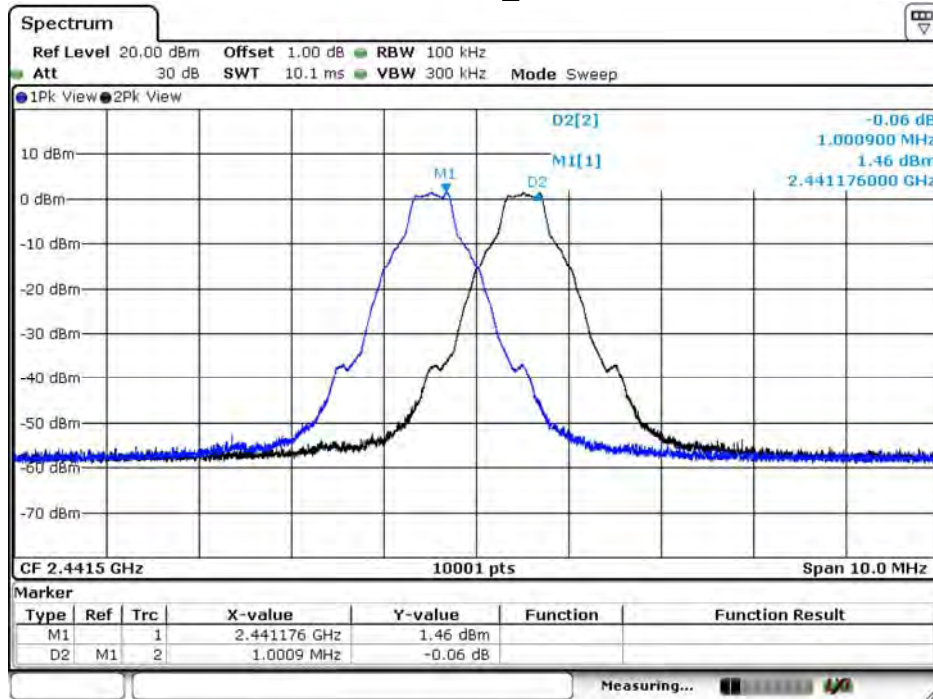

Date: 12.MAY.2021 14:56:25

### Channel 78\_GFSK

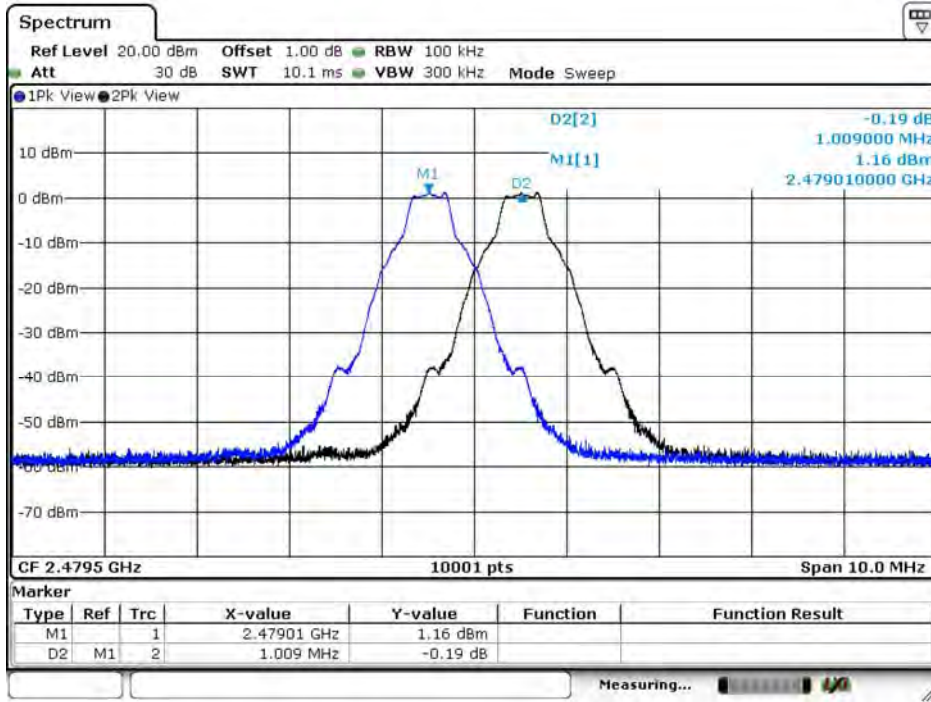

Date: 12.MAY.2021 15:08:59

### Channel 00\_8-DPSK

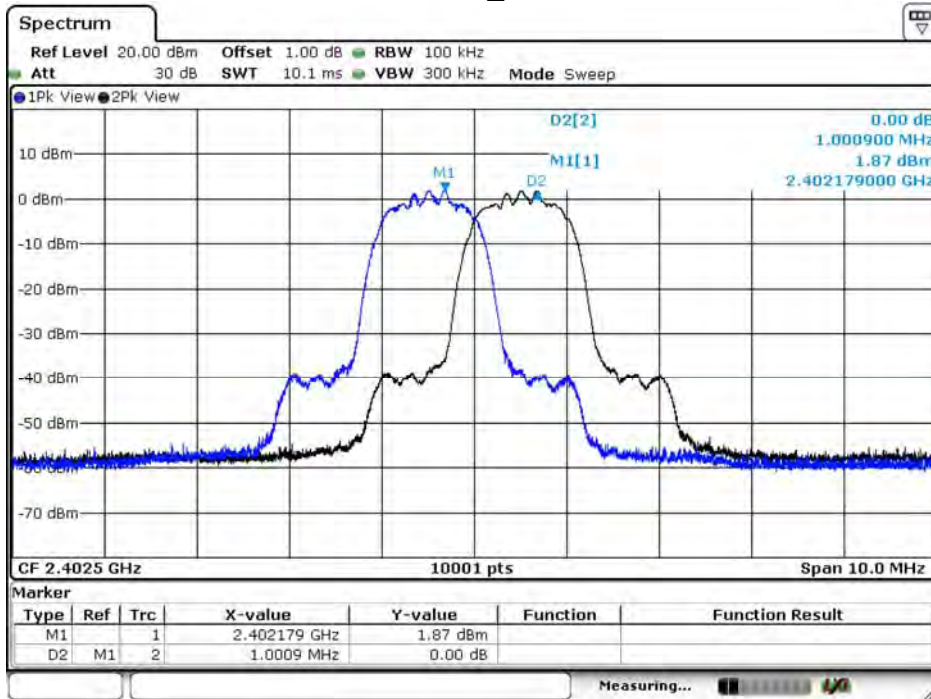

Date: 12.MAY.2021 14:33:05

### Channel 39\_8-DPSK

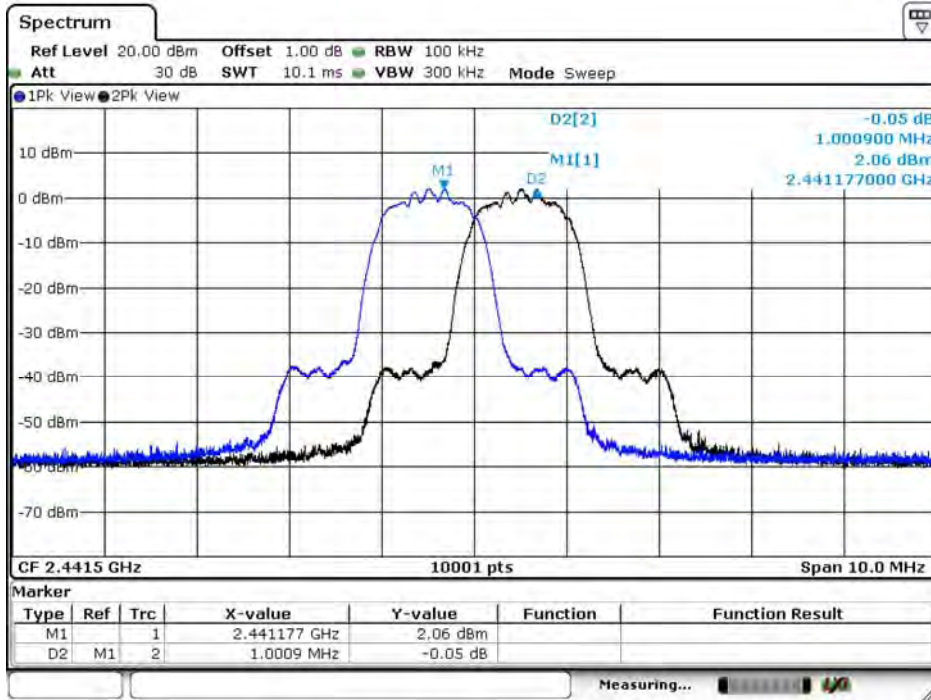

Date: 12.MAY.2021 14:36:26

### Channel 78\_8-DPSK

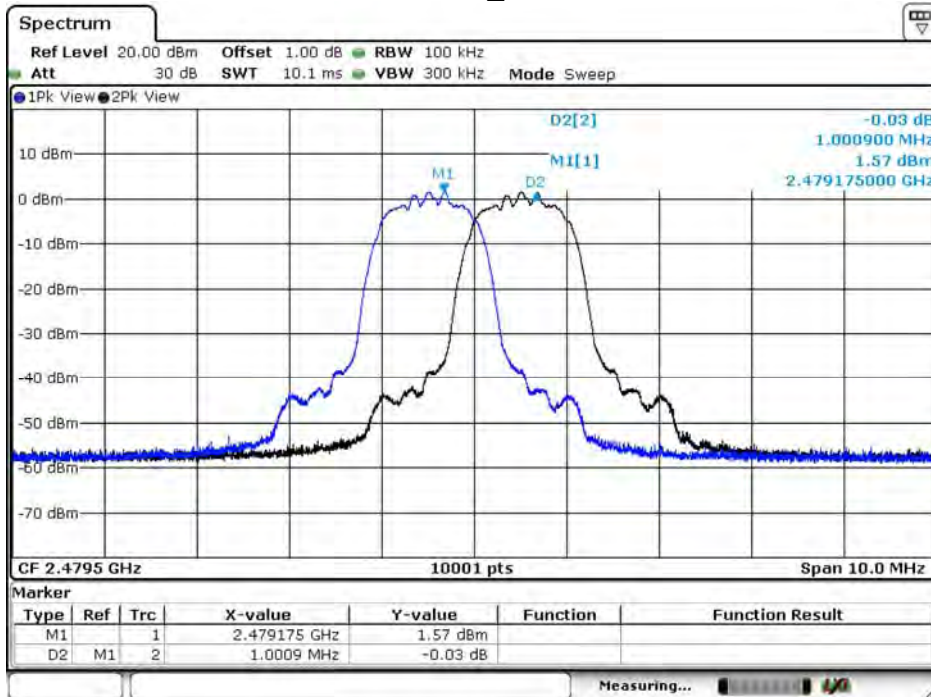

Date: 12.MAY.2021 15:23:51



## 9. -20dB Bandwidth

### 9.1. Test Setup

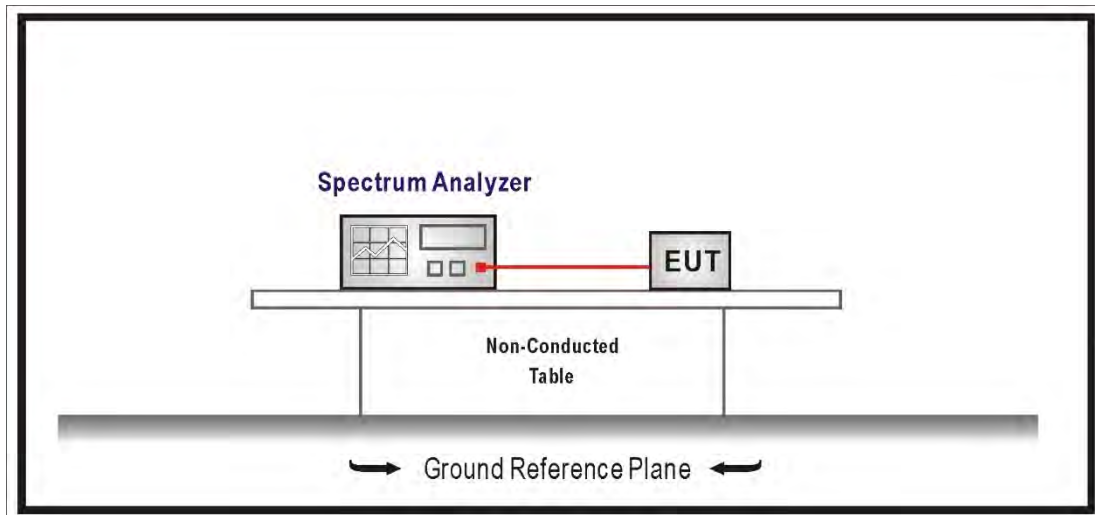

### 9.2. Limits

N/A

### 9.3. Test Procedures

The EUT was setup according to ANSI C63.10: 2013 and tested according to FHSS test procedure of FCC KDB 558074 D01 v05r02 for compliance to FCC 47CFR 15.247 requirements

Use the following spectrum analyzer settings:

Span = approximately 2 to 3 times the 20 dB bandwidth, centered on a hopping channel  
RBW  $\geq$  1% of the 20 dB bandwidth, VBW  $\geq$  RBW, Sweep = auto, Detector function = peak, Trace = max hold, The EUT should be transmitting at its maximum data rate.

### 9.4. Test Specification

According to FCC Part 15 Subpart C Paragraph 15.247: 2019.

### 9.5. Test Result

Product	Smart Display		
Test Item	-20dB Bandwidth		
Test Mode	Mode 2: Transmit_Adapter_1A100-US1230		
Date of Test	2021/05/12	Test Site	SR12-H
Temperature(°C)	24.0	Humidity (%RH)	68.0

#### GFSK

Channel No.	Frequency (MHz)	Measure Level (MHz)	Limit (MHz)
00	2402	1.027	---
39	2441	1.026	---
78	2480	1.026	---

#### 8-DPSK

Channel No.	Frequency (MHz)	Measure Level (MHz)	Limit (MHz)
00	2402	1.300	---
39	2441	1.300	---
78	2480	1.296	---

Channel 00\_GFSK

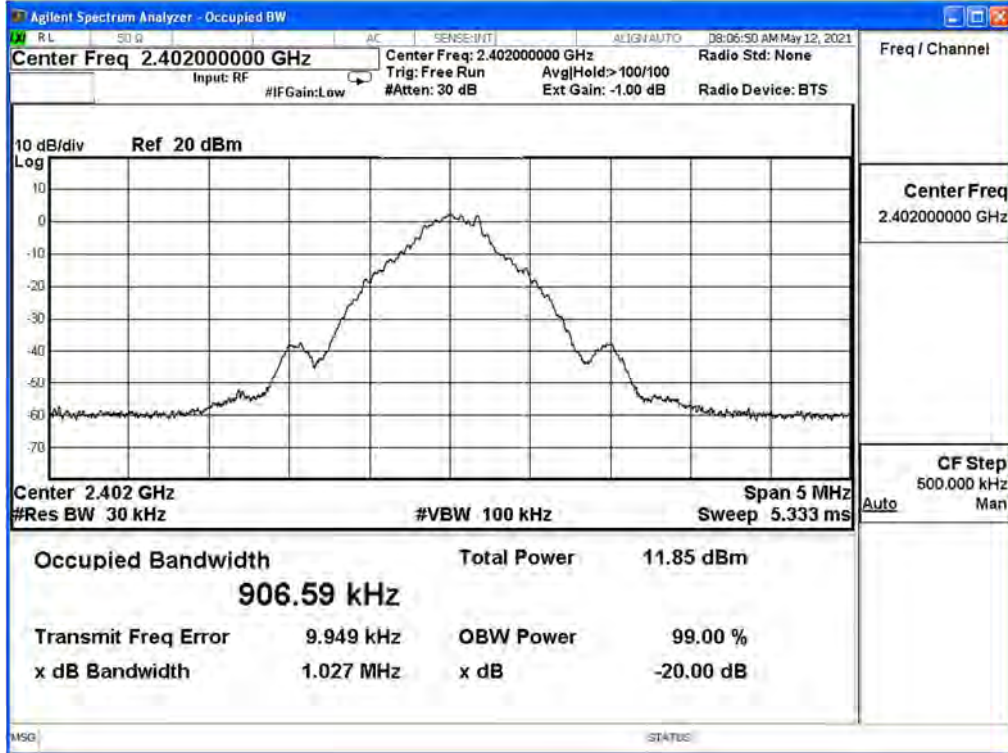

Channel 39\_GFSK

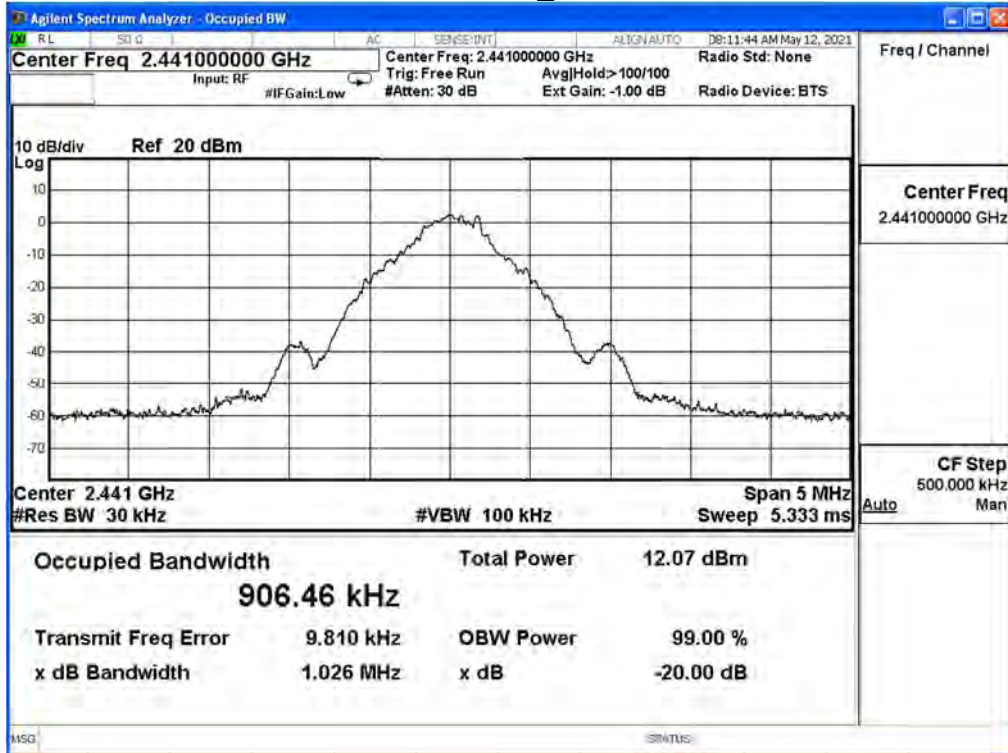

Channel 78\_GFSK

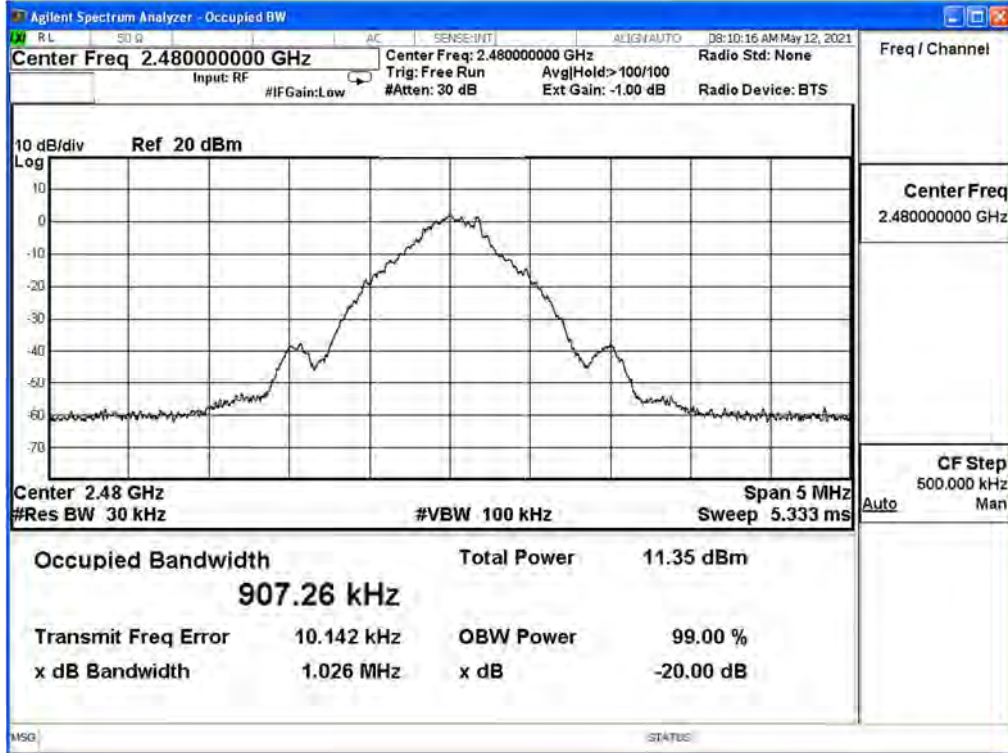

Channel 00\_8-DPSK

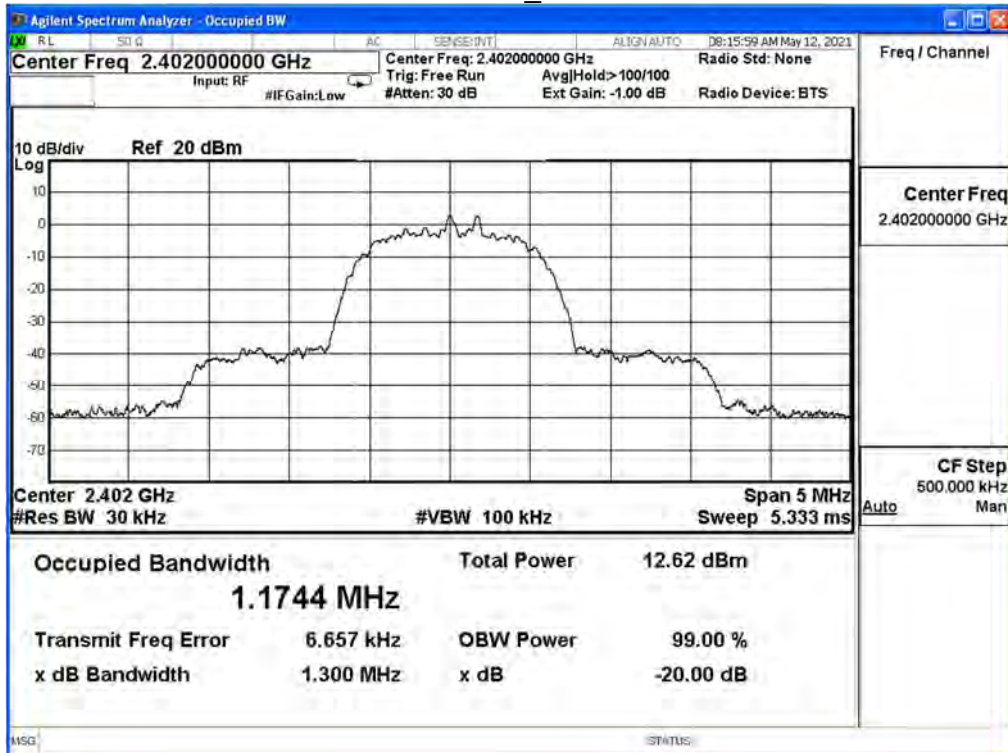

Channel 39\_8-DPSK

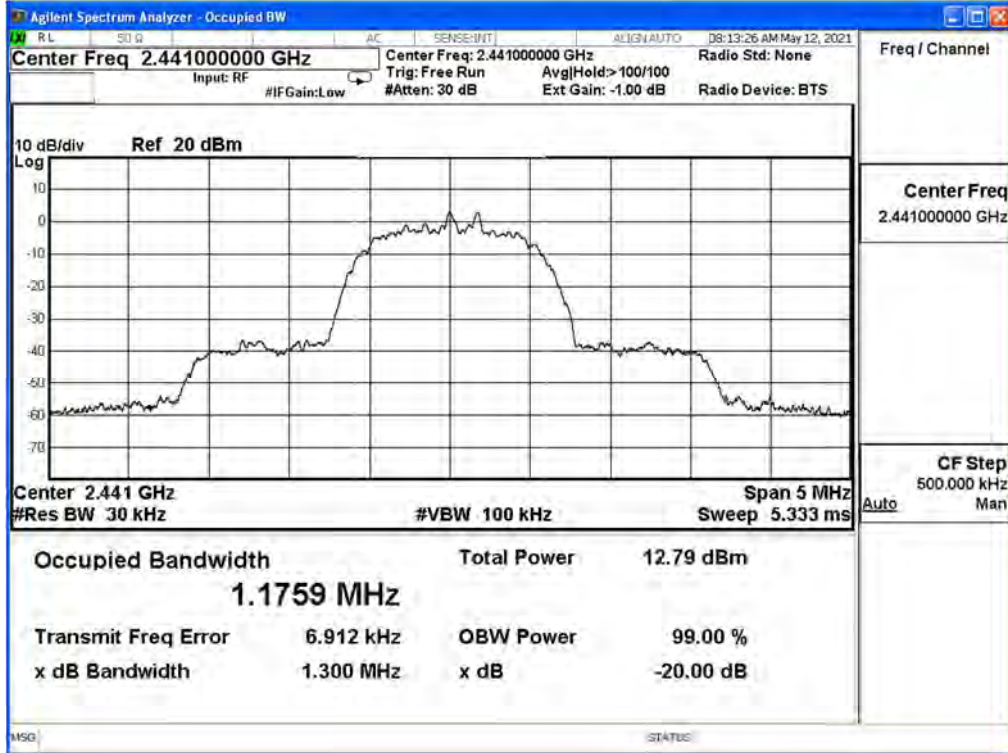

Channel 78\_8-DPSK

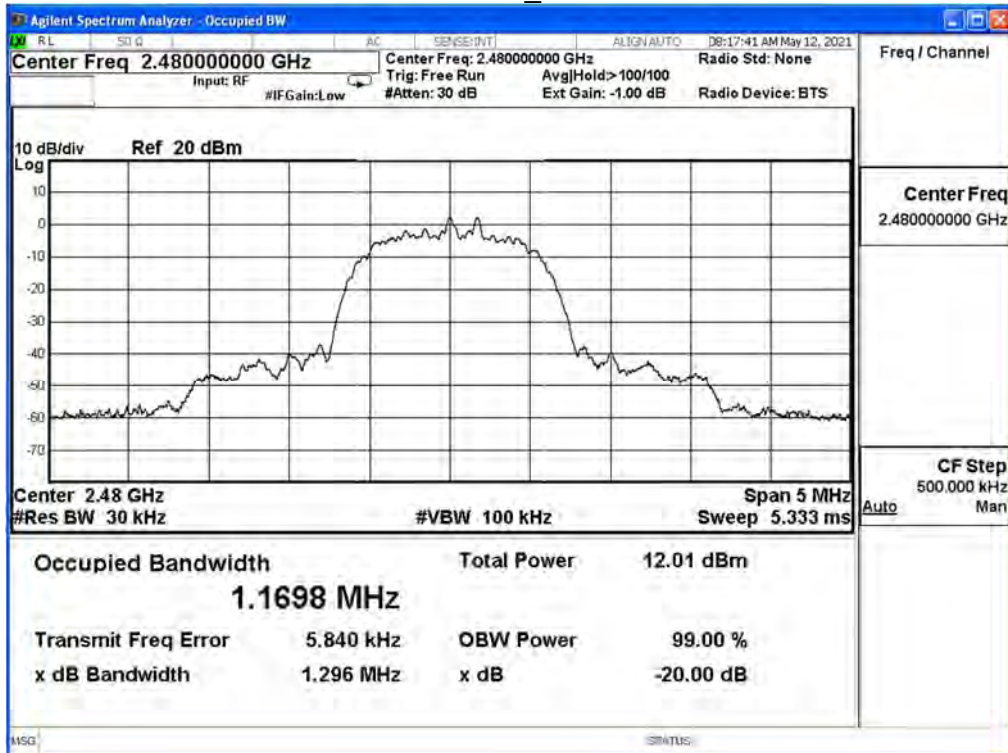

## 10. Dwell Time

### 10.1. Test Setup

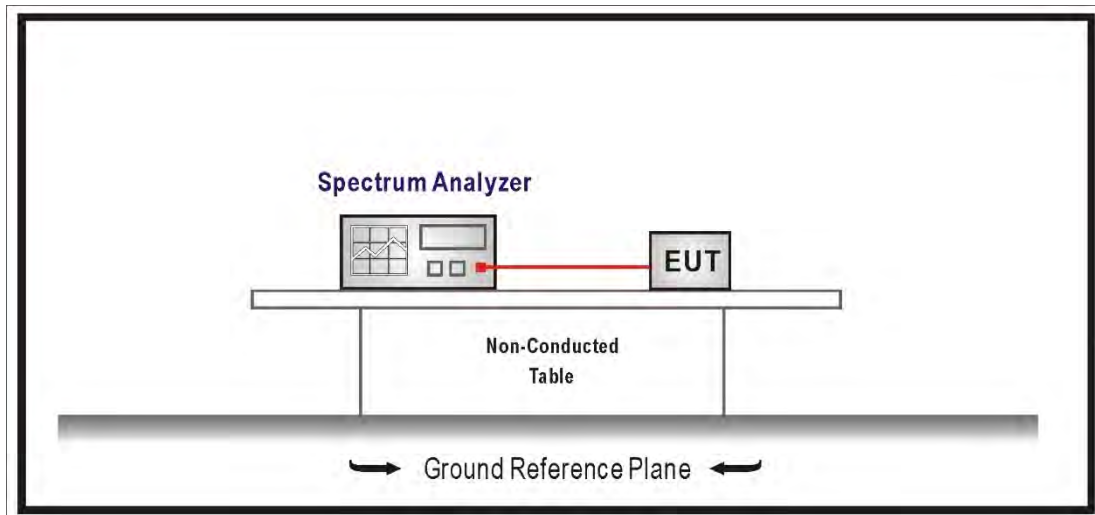

### 10.2. Limits

For frequency hopping systems operating in the 902-928 MHz band: if the 20 dB bandwidth of the hopping channel is less than 250 kHz, the system shall use at least 50 hopping frequencies and the average time of occupancy on any frequency shall not be greater than 0.4 seconds within a 20 second period; if the 20 dB bandwidth of the hopping channel is 250 kHz or greater, the system shall use at least 25 hopping frequencies and the average time of occupancy on any frequency shall not be greater than 0.4 seconds within a 10 second period.

For frequency hopping systems operating in the 2400-2483.5 MHz bands. The average time of occupancy on any channel shall not be greater than 0.4 seconds within a period of 0.4 seconds multiplied by the number of hopping channels employed.

For frequency hopping systems operating in the 5725-5850 MHz bands. The average time of occupancy on any frequency shall not be greater than 0.4 seconds within a 30 second period.

---

### **10.3. Test Procedures**

The EUT was setup according to ANSI C63.10: 2013 and tested according to FHSS test procedure of FCC KDB 558074 D01 v05r02 for compliance to FCC 47CFR 15.247 requirements

Span = zero span, centered on a hopping channel, RBW = 1 MHz, VBW  $\geq$  RBW,

Sweep = as necessary to capture the entire dwell time per hopping channel,

Detector function = peak, Trace = max hold.

### **10.4. Test Specification**

According to FCC Part 15 Subpart C Paragraph 15.247: 2019

## 10.5. Test Result

Product	Smart Display		
Test Item	Dwell Time		
Test Mode	Mode 2: Transmit_Adapter_1A100-US1230		
Date of Test	2021/05/12	Test Site	SR12-H
Temperature(°C)	24.0	Humidity (%RH)	68.0

### GFSK

Occupancy Time of Frequency Hopping System

A) 2402MHz Test Time Period:  $0.4 \times 79 = 31.60 \text{sec}$  , Time slot length : 2.882 ms = 0.002882 sec

Dwell Time :  $0.002882 \times (266.67/79) \times 31.60 = 0.3074$  sec ◦

B) 2441MHz Test Time Period:  $0.4 \times 79 = 31.60 \text{sec}$  , Time slot length : 2.882 ms = 0.002882 sec

Dwell Time :  $0.002882 \times (266.67/79) \times 31.60 = 0.3074$  sec ◦

C) 2480MHz Test Time Period:  $0.4 \times 79 = 31.60 \text{sec}$  , Time slot length : 2.882 ms = 0.002882 sec

Dwell Time :  $0.002882 \times (266.67/79) \times 31.60 = 0.3074$  sec ◦

Test Result: The Average Occupancy Time of Each Highest , Middle and Lowest Channel Is Less Than 0.4sec , And Corresponds to The Standard ◦

### 8-DPSK

Occupancy Time of Frequency Hopping System

A) 2402MHz Test Time Period:  $0.4 \times 79 = 31.60 \text{sec}$  , Time slot length : 2.888 ms = 0.002888 sec

Dwell Time :  $0.002888 \times (266.67/79) \times 31.60 = 0.3081$  sec ◦

B) 2441MHz Test Time Period:  $0.4 \times 79 = 31.60 \text{sec}$  , Time slot length : 2.888 ms = 0.002888 sec

Dwell Time :  $0.002888 \times (266.67/79) \times 31.60 = 0.3081$  sec ◦

C) 2480MHz Test Time Period:  $0.4 \times 79 = 31.60 \text{sec}$  , Time slot length : 2.888 ms = 0.002888 sec

Dwell Time :  $0.002888 \times (266.67/79) \times 31.60 = 0.3081$  sec ◦

Test Result: The Average Occupancy Time of Each Highest , Middle and Lowest Channel Is Less Than 0.4sec , And Corresponds to The Standard ◦



### Hop rate-2402MHz\_GFSK

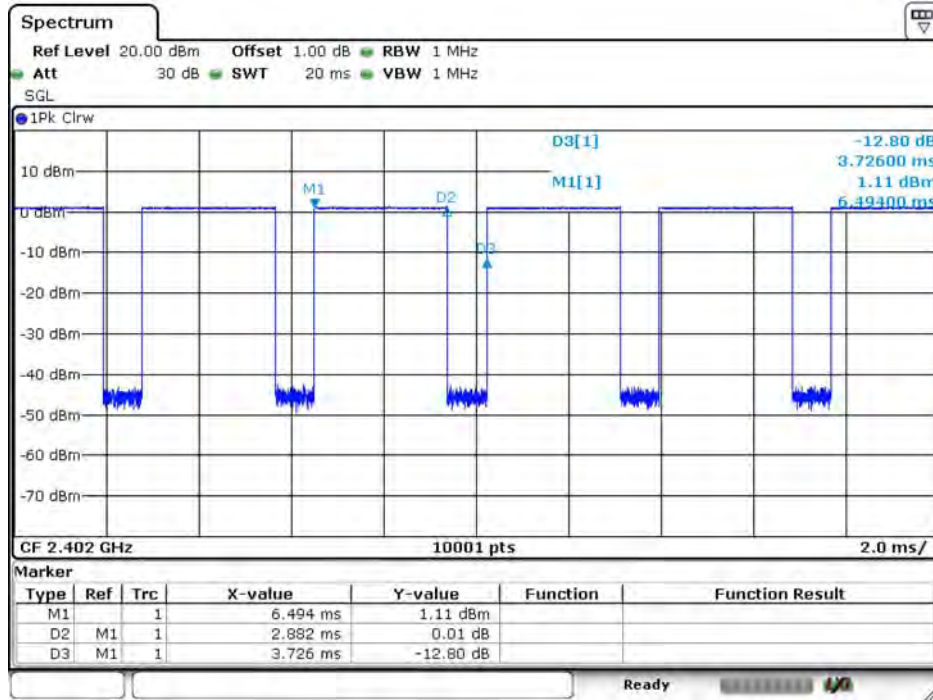

Date: 12.MAY.2021 14:18:25

### Hop rate-2441MHz\_GFSK

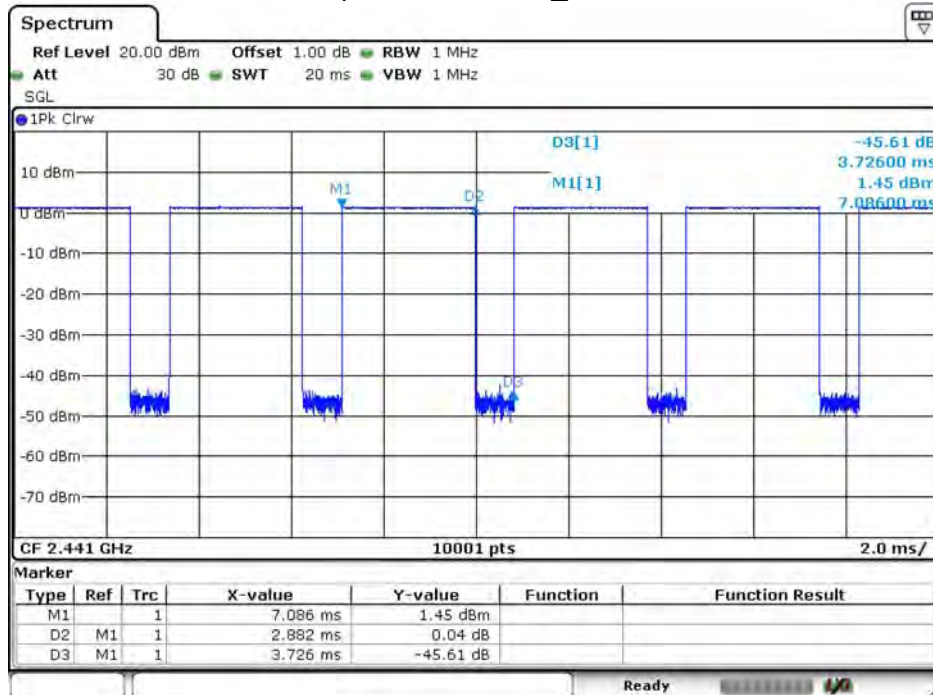

Date: 12.MAY.2021 14:19:31

### Hop rate-2480MHz\_GFSK

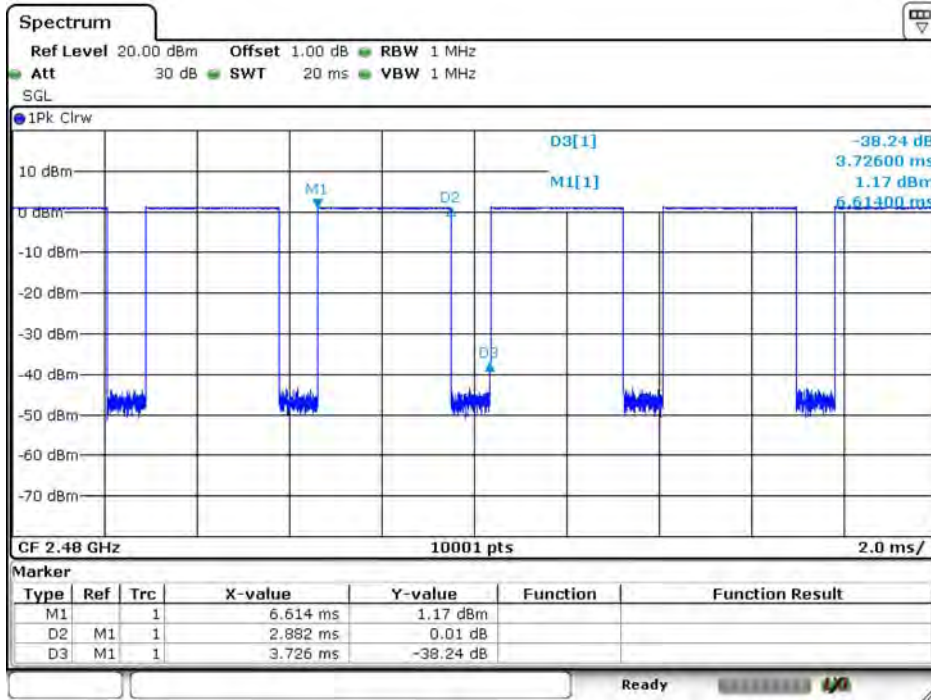

Date: 12.MAY.2021 14:21:43

### Hop rate-2402MHz\_8-DPSK

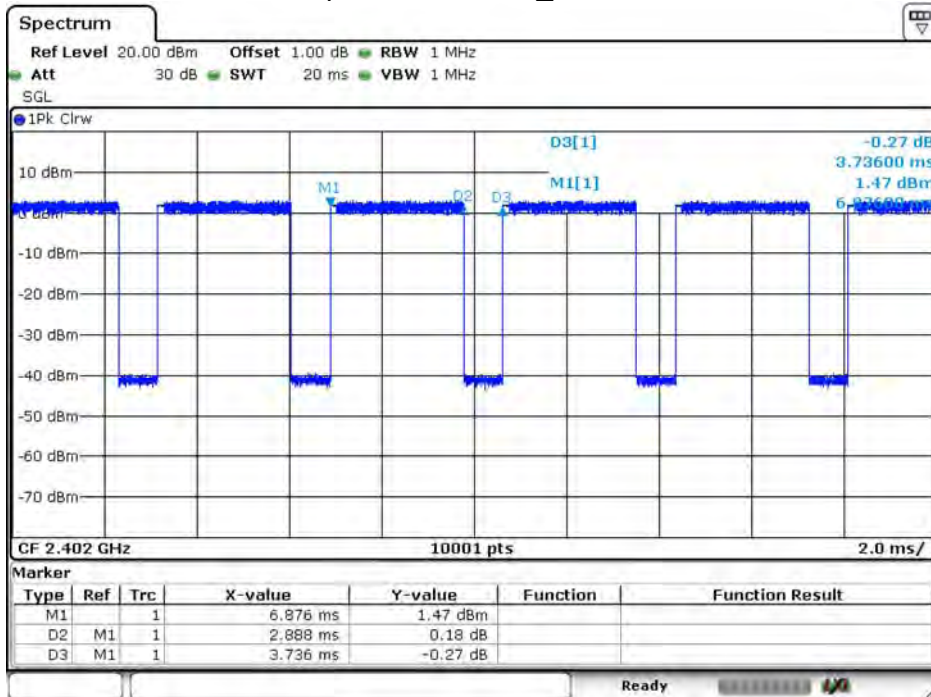

Date: 12.MAY.2021 13:50:53

### Hop rate-2441MHz\_8-DPSK

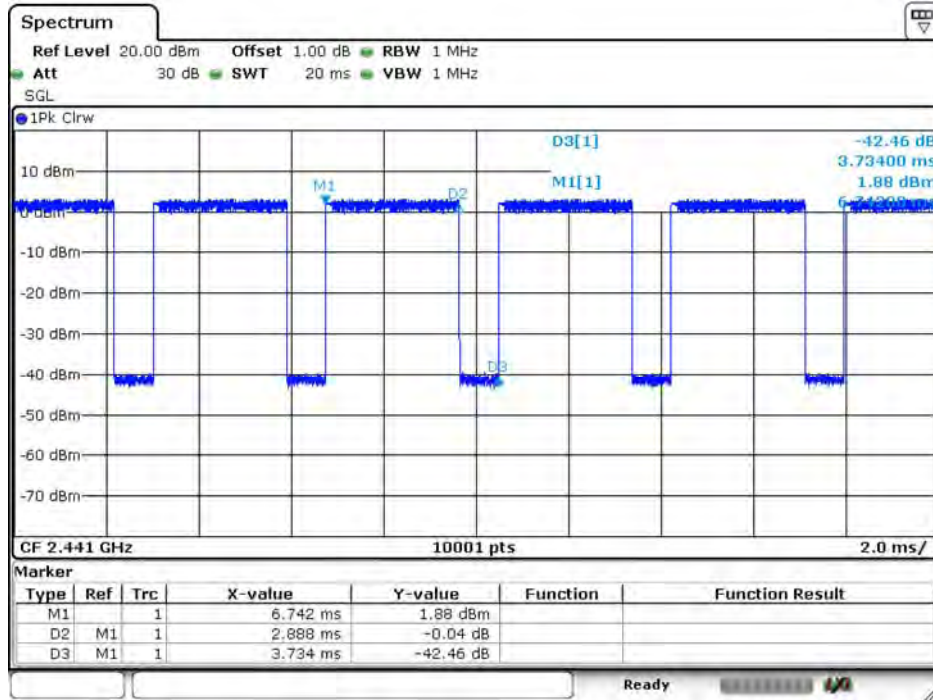

Date: 12.MAY.2021 13:39:54

### Hop rate-2480MHz\_8-DPSK

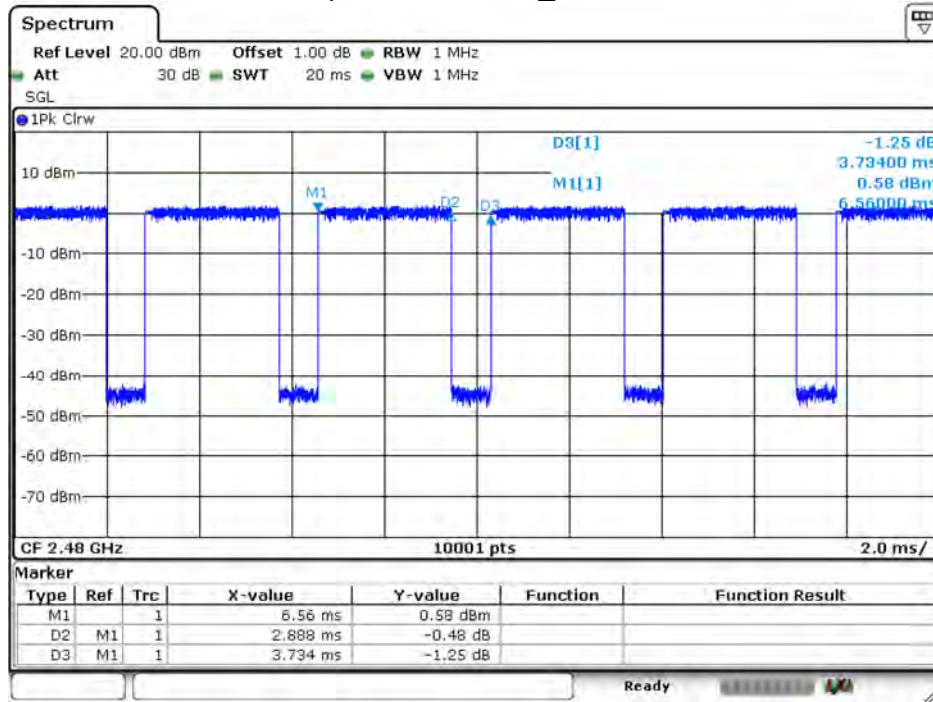

Date: 12.MAY.2021 13:37:59

Note: Dwell time = time slot length \* hop rate / number of hopping channels \* period

---

**Attachment 2**

➤ **Radiated Emission Co-location**