



SPORTON International Inc.

No. 52, Hwa Ya 1st Rd., Hwa Ya Technology Park, Kwei-Shan Hsiang, Tao Yuan Hsien, Taiwan, R.O.C.
Ph: 886-3-327-3456 / FAX: 886-3-327-0973 / www.sporton.com.tw

FCC RADIO TEST REPORT

Applicant's company	CyberTAN Technology Inc.
Applicant Address	No. 99, Park Avenue III, Science-based Industrial Park, Hsinchu, 308 Taiwan
FCC ID	N89-NU361
Manufacturer's company	CyberTAN Technology Inc.
Manufacturer Address	No. 99, Park Avenue III, Science-based Industrial Park, Hsinchu, 308 Taiwan

Product Name	802.11a/b/g/n/ac Wi-Fi + Bluetooth Combo Module
Brand Name	CyberTAN
Model Name	NU361-HS
Test Rule	47 CFR FCC Part 15 Subpart C § 15.247
Test Freq. Range	2402 ~ 2480MHz
Received Date	Mar. 10, 2015
Final Test Date	Mar. 23, 2016
Submission Type	Class II Change

Statement

Test result included is only for the Bluetooth BR/EDR of the product.

The test result in this report refers exclusively to the presented test model / sample.

Without written approval of SPORTON International Inc., the test report shall not be reproduced except in full.

The measurements and test results shown in this test report were made in accordance with the procedures and found in compliance with the limit given in **ANSI C63.10-2013** and **47 CFR FCC Part 15 Subpart C**.

The test equipment used to perform the test is calibrated and traceable to NML/ROC.





Table of Contents

1. VERIFICATION OF COMPLIANCE	1
2. SUMMARY OF THE TEST RESULT	2
3. GENERAL INFORMATION	3
3.1. Product Details.....	3
3.2. Accessories.....	3
3.3. Table for Carrier Frequencies	3
3.4. Table for Filed Antenna.....	4
3.5. Table for Test Modes.....	5
3.6. Table for Testing Locations.....	5
3.7. Table for Class II Change	6
3.8. Table for Supporting Units	6
3.9. Test Configurations	7
4. TEST RESULT	9
4.1. AC Power Line Conducted Emissions Measurement.....	9
4.2. Radiated Emissions Measurement	13
4.3. Antenna Requirements	19
5. LIST OF MEASURING EQUIPMENTS	20
6. MEASUREMENT UNCERTAINTY	21
APPENDIX A. TEST PHOTOS	A1 ~ A7



History of This Test Report

REPORT NO.	VERSION	DESCRIPTION	ISSUED DATE
FR530540-04AB	Rev. 01	Initial issue of report	Jun. 22, 2016



1. VERIFICATION OF COMPLIANCE

Product Name : 802.11a/b/g/n/ac WI-FI + Bluetooth Combo Module
Brand Name : CyberTAN
Model No. : NU361-HS
Applicant : CyberTAN Technology Inc.
Test Rule Part(s) : 47 CFR FCC Part 15 Subpart C § 15.247

Sporton International as requested by the applicant to evaluate the EMC performance of the product sample received on Mar. 10, 2015 would like to declare that the tested sample has been evaluated and found to be in compliance with the tested rule parts. The data recorded as well as the test configuration specified is true and accurate for showing the sample's EMC nature.

A handwritten signature in blue ink, appearing to read "Sam Chen", is written over a horizontal line.

Sam Chen

SPORTON INTERNATIONAL INC.

2. SUMMARY OF THE TEST RESULT

Applied Standard: 47 CFR FCC Part 15 Subpart C				
Part	Rule Section	Description of Test	Result	Under Limit
4.1	15.207	AC Power Line Conducted Emissions	Complies	12.34 dB
4.2	15.247(d)	Radiated Emissions	Complies	3.04 dB
4.3	15.203	Antenna Requirements	Complies	-

3. GENERAL INFORMATION

3.1. Product Details

Items	Description
Power Type	From host system
Modulation	FHSS (GFSK / $\pi/4$ -DQPSK / 8DPSK)
Data Rate (Mbps)	GFSK: 1 ; $\pi/4$ -DQPSK: 2 ; 8DPSK: 3
Frequency Range	2402 ~ 2480MHz
Channel Number	79
Carrier Frequencies	Please refer to section 3.3
Antenna	Please refer to section 3.4
Note 1: Bluetooth BR uses a combination of GFSK (1Mbps).	
Note 2: Bluetooth EDR uses a combination of $\pi/4$ -DQPSK (2Mbps) and 8DPSK (3Mbps).	

3.2. Accessories

N/A

3.3. Table for Carrier Frequencies

Frequency Band	Channel No.	Frequency	Channel No.	Frequency
2400~2483.5MHz	0	2402 MHz	40	2442 MHz
	1	2403 MHz	:	:
	:	:	77	2479 MHz
	38	2440 MHz	78	2480 MHz
	39	2441 MHz	-	-

3.4. Table for Filed Antenna

Ant.	Brand	Part No.	Antenna Type	Connector	Gain (dBi)		
					2.4GHz	5GHz	Bluetooth
1	INPAQ	WAG-M-LB-00-002	PIFA Antenna	Murata	1.21	3.97	-
2	INPAQ	WAG-M-LB-00-003	PIFA Antenna	Murata	1.21	3.97	-
3	MAG. LAYERS	MSA-3507-25GC1-A1	PIFA Antenna	I-PEX	-	-	4.12

Note:

For 2.4GHz:

For IEEE 802.11b mode (1TX/1RX)

Only Chain 1 can be used as transmitting/receiving antenna.

For IEEE 802.11g/n mode (2TX/2RX)

Chain 1 and Chain 2 can be used as transmitting/receiving antenna.

Chain 1 and Chain 2 could transmit/receive simultaneously.

For 5GHz:

For IEEE 802.11a/n/ac mode (2TX/2RX)

Chain 1 and Chain 2 can be used as transmitting/receiving antenna.

Chain 1 and Chain 2 could transmit/receive simultaneously.

For Bluetooth mode (1TX/1RX)

Only Chain 3 can be used as transmitting/receiving antenna.

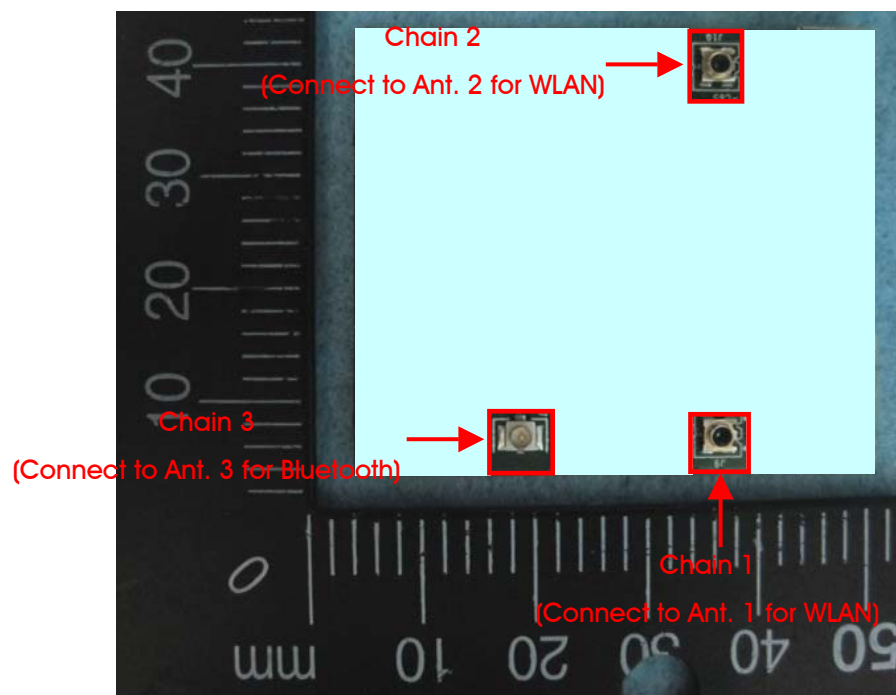

3.5. Table for Test Modes

Preliminary tests were performed in different data rate to find the worst radiated emission. The data rate shown in the table below is the worst-case rate with respect to the specific test item. Investigation has been done on all the possible configurations for searching the worst cases. The following table is a list of the test modes shown in this test report.

Test Items	Mode	Data Rate	Channel	Chain
AC Power Conducted Emissions	Normal Link	-	-	-
Radiated Emissions Below 1GHz	Normal Link	-	-	-

The following test modes were performed for all tests:

For Conducted Emission test:

Mode 1. 2.4GHz WLAN Function + Bluetooth Function

Mode 2. 5GHz WLAN Function + Bluetooth Function

Mode 1 is the worst case, so it was selected to record in this test report.

For Radiated Emission test (Below 1GHz):

Mode 1. 2.4GHz WLAN Function + Bluetooth Function + X axis

Mode 2. 2.4GHz WLAN Function + Bluetooth Function + Y axis

Mode 3. 2.4GHz WLAN Function + Bluetooth Function + Z axis

Mode 2 has been evaluated to be the worst case among Mode 1~3, thus measurement for Mode 4 will follow this same test mode.

Mode 4. 5GHz WLAN Function + Bluetooth Function + Y axis

Mode 2 is the worst case, so it was selected to record in this test report.

3.6. Table for Testing Locations

Test Site Location					
Address:	No.8, Lane 724, Bo-ai St., Jhubei City, Hsinchu County 302, Taiwan, R.O.C.				
TEL:	886-3-656-9065				
FAX:	886-3-656-9085				
Test Site No.	Site Category	Location	FCC Reg. No.	IC File No.	VCCI Reg. No
03CH01-CB	SAC	Hsin Chu	262045	IC 4086D	-
CO01-CB	Conduction	Hsin Chu	262045	IC 4086D	-

Open Area Test Site (OATS); Semi Anechoic Chamber (SAC).

3.7. Table for Class II Change

This product is an extension of original one reported under Sporton project number: FR530540AB

Below is the table for the change of the product with respect to the original one.

Modifications	Performance Checking
1. Changing the module to 10 pin from 9 pin (adding 1 pin GND). 2. Removing the components: U9, U10, U11 and Q1 3. Adding the components Q2 and Q3.	1. AC Power Line Conducted Emissions Measurement 2. Radiated Emissions (Below 1GHz)

Note: There is no change in existing RF relevant portion.

There is no any software that can be modified by end-user.

3.8. Table for Supporting Units

For Test Site No: 03CH01-CB (Below 1GHz)

Support Unit	Brand	Model	FCC ID
Earphone	e-Power	S90W	N/A
Mouse	Logitech	M-U0026	DoC
NB	DELL	E4300	DoC
CBT Bluetooth tester	Anritsu	MT8852B	N/A
Wireless ac AP	Netgear	R6300V2	PY313200227

For Test Site No: CO01-CB

Support Unit	Brand	Model	FCC ID
AP Router	Planex	GW-AP54SGX	KA220030603014-1
CBT Bluetooth tester	Anritsu	MT8852B	DoC
NB	DELL	E6430	DoC
Mouse	HP	FM100	DoC
Earphone	e-Power	S90W	DoC

3.9. Test Configurations

3.9.1. AC Power Line Conduction Emissions Test Configuration

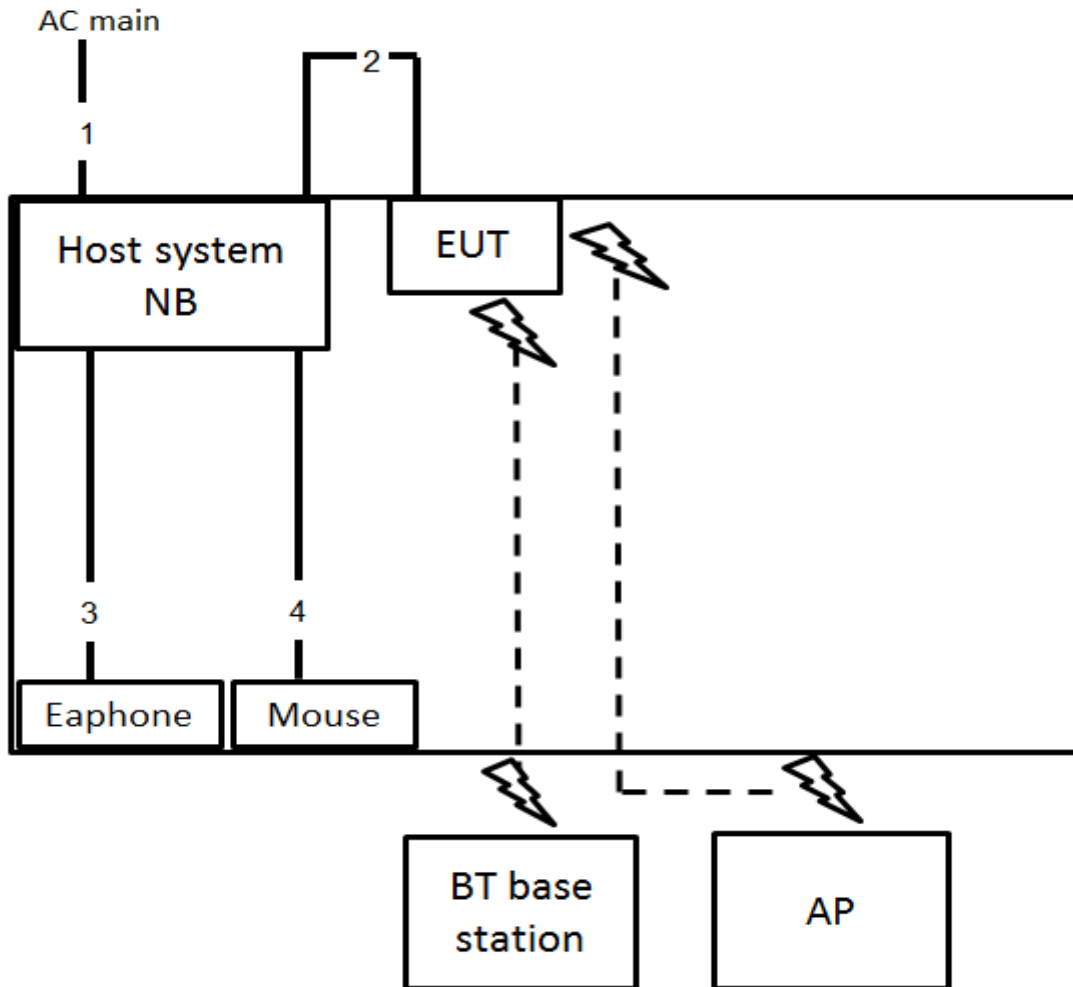

Item	Connection	Shielded	Length
1	Power cable	No	2.6m
2	USB cable	Yes	0.3m
3	Audio cable	No	1.4m
4	USB cable	Yes	1.8m

3.9.2. Radiation Emissions (Belowe 1GHz) Test Configuration

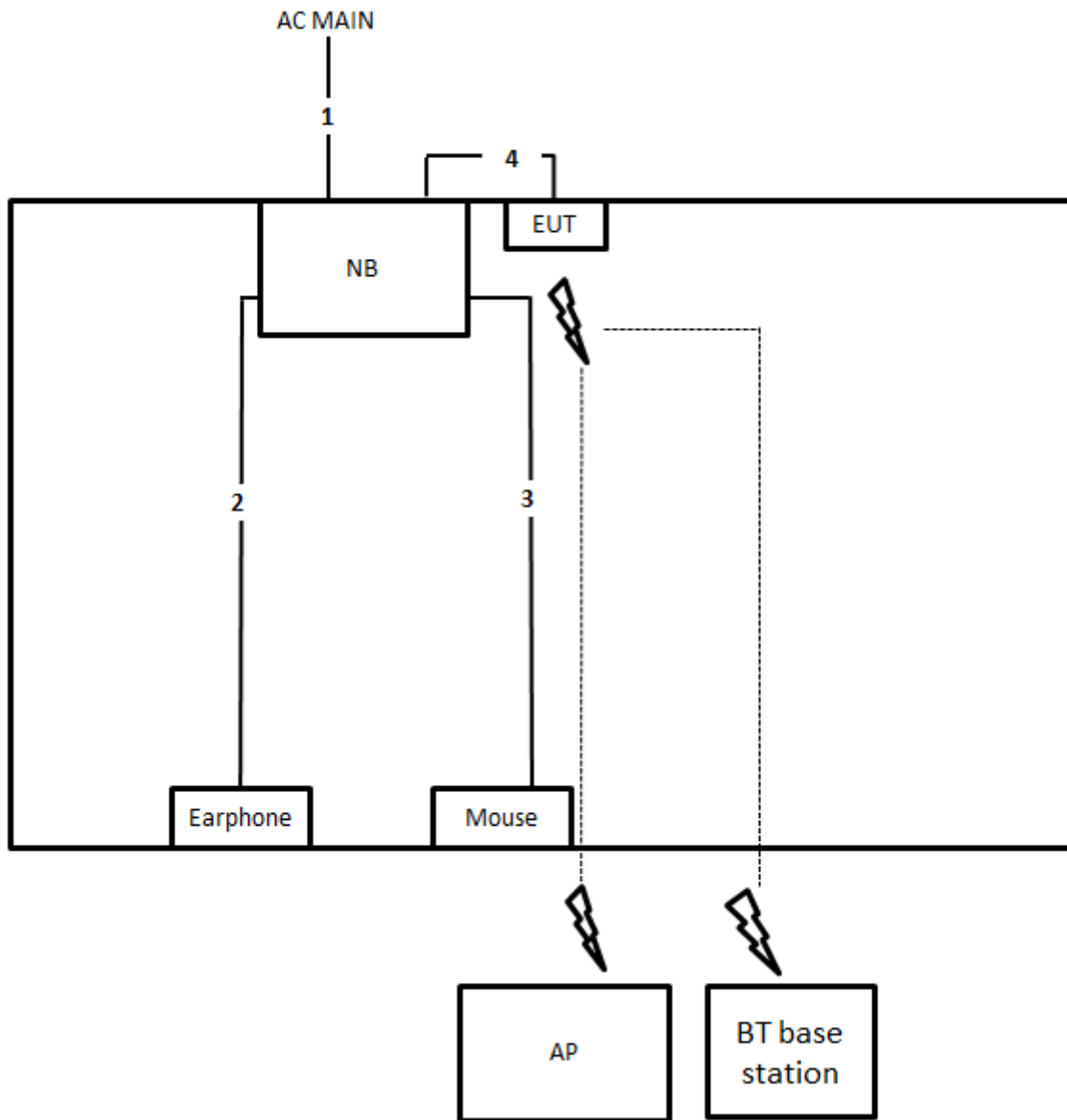

Item	Connection	Shielded	Length
1	Power cable	No	2.6m
2	Audio cable	No	1.4m
3	USB cable	Yes	1.8m
4	USB cable	Yes	0.3m

4. TEST RESULT

4.1. AC Power Line Conducted Emissions Measurement

4.1.1. Limit

For this product which is designed to be connected to the AC power line, the radio frequency voltage that is conducted back onto the AC power line on any frequency or frequencies within the band 150 kHz to 30 MHz shall not exceed below limits table.

Frequency (MHz)	QP Limit (dBuV)	AV Limit (dBuV)
0.15~0.5	66~56	56~46
0.5~5	56	46
5~30	60	50

4.1.2. Measuring Instruments and Setting

Please refer to section 錯誤! 找不到參照來源。 of equipments list in this report. The following table is the setting of the receiver.

Receiver Parameters	Setting
Attenuation	10 dB
Start Frequency	0.15 MHz
Stop Frequency	30 MHz
IF Bandwidth	9 kHz

4.1.3. Test Procedures

1. Configure the EUT according to ANSI C63.10. The EUT or host of EUT has to be placed 0.4 meter far from the conducting wall of the shielding room and at least 80 centimeters from any other grounded conducting surface.
2. Connect EUT or host of EUT to the power mains through a line impedance stabilization network (LISN).
3. All the support units are connected to the other LISNs. The LISN should provide 50uH/50ohms coupling impedance.
4. The frequency range from 150 kHz to 30 MHz was searched.
5. Set the test-receiver system to Peak Detect Function and Specified Bandwidth with Maximum Hold Mode.
6. The measurement has to be done between each power line and ground at the power terminal.

4.1.4. Test Setup Layout

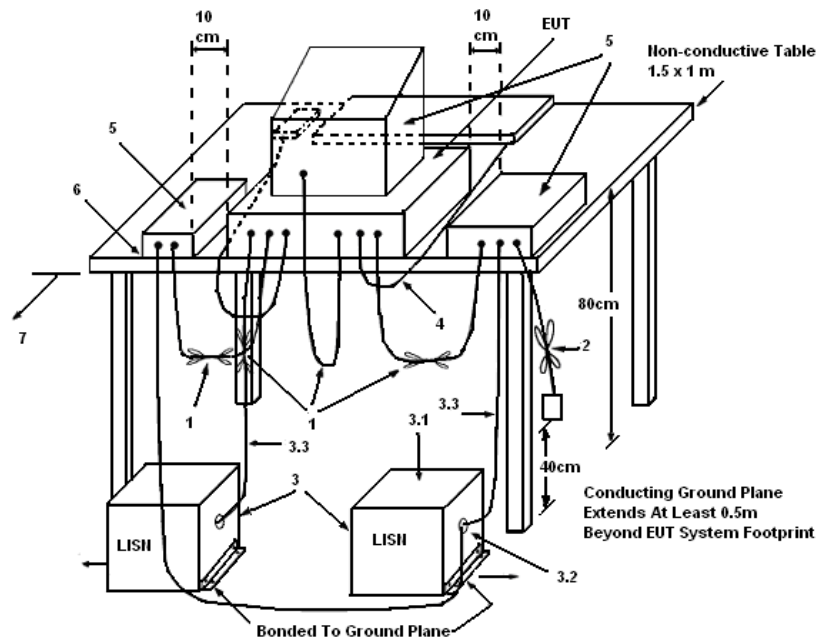

LEGEND:

- (1) Interconnecting cables that hang closer than 40 cm to the ground plane shall be folded back and forth in the center forming a bundle 30 to 40 cm long.
- (2) I/O cables that are not connected to a peripheral shall be bundled in the center. The end of the cable may be terminated, if required, using the correct terminating impedance. The overall length shall not exceed 1 m.
- (3) EUT connected to one LISN. Unused LISN measuring port connectors shall be terminated in 50 Ω . LISN can be placed on top of, or immediately beneath, reference ground plane.
 - (3.1) All other equipment powered from additional LISN(s).
 - (3.2) Multiple outlet strip can be used for multiple power cords of non-EUT equipment.
 - (3.3) LISN at least 80 cm from nearest part of EUT chassis.
- (4) Cables of hand-operated devices, such as keyboards, mice, etc., shall be placed as for normal use.
- (5) Non-EUT components of EUT system being tested.
- (6) Rear of EUT, including peripherals, shall all be aligned and flush with rear of tabletop.
- (7) Rear of tabletop shall be 40 cm removed from a vertical conducting plane that is bonded to the ground plane.

4.1.5. Test Deviation

There is no deviation with the original standard.

4.1.6. EUT Operation during Test

The EUT was placed on the test table and programmed in normal function.

4.1.7. Results of AC Power Line Conducted Emissions Measurement

Temperature	22°C	Humidity	63%
Test Engineer	Edison Lin	Phase	Line
Configuration	Normal Link / Mode 1		

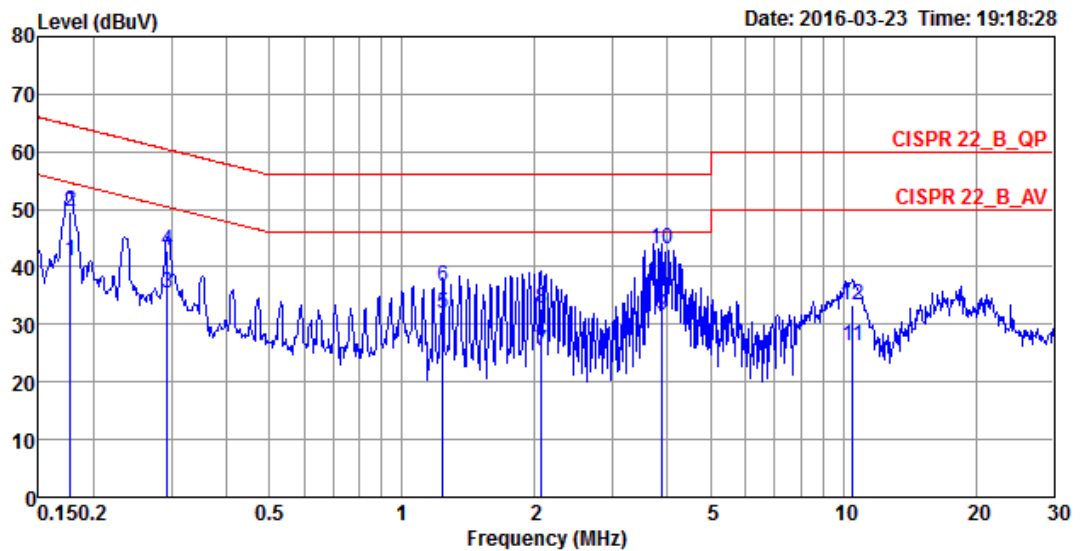

	Freq	Level	Over Limit	Limit Line	Read Level	LISN Factor	Cable Loss	Pol/Phase	Remark
	MHz	dBuV	dB	dBuV	dBuV	dB	dB		
1	0.1768	41.03	-13.61	54.64	31.08	9.93	0.02	LINE	Average
2	0.1768	49.56	-15.08	64.64	39.61	9.93	0.02	LINE	QP
3	0.2940	35.38	-15.03	50.41	25.41	9.93	0.04	LINE	Average
4	0.2940	42.68	-17.73	60.41	32.71	9.93	0.04	LINE	QP
5	1.2357	31.84	-14.16	46.00	21.82	9.97	0.05	LINE	Average
6	1.2357	36.68	-19.32	56.00	26.66	9.97	0.05	LINE	QP
7	2.0659	25.25	-20.75	46.00	15.20	9.99	0.06	LINE	Average
8	2.0659	32.63	-23.37	56.00	22.58	9.99	0.06	LINE	QP
9	3.8808	31.69	-14.31	46.00	21.60	10.02	0.07	LINE	Average
10	3.8808	42.98	-13.02	56.00	32.89	10.02	0.07	LINE	QP
11	10.5079	26.37	-23.63	50.00	15.92	10.20	0.25	LINE	Average
12	10.5079	33.50	-26.50	60.00	23.05	10.20	0.25	LINE	QP

Temperature	22°C	Humidity	63%
Test Engineer	Edison Lin	Phase	Neutral
Configuration	Normal Link / Mode 1		

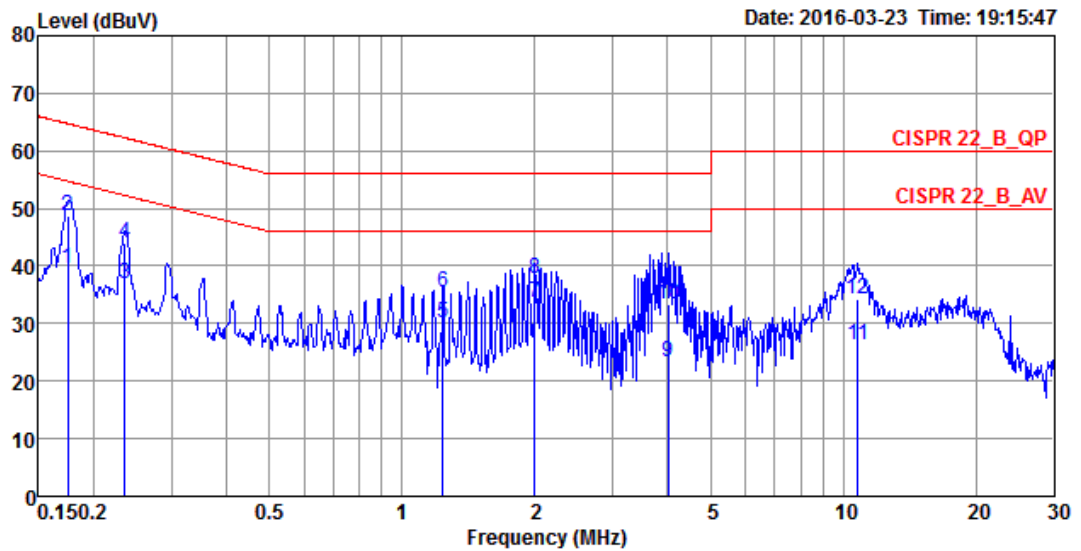

	Freq	Level	Over Limit	Limit Line	Read Level	LISN Factor	Cable Loss	Pol/Phase	Remark
	MHz	dBuV	dB	dBuV	dBuV	dB	dB		
1	0.1749	39.48	-15.24	54.72	29.67	9.79	0.02	NEUTRAL	Average
2	0.1749	48.80	-15.92	64.72	38.99	9.79	0.02	NEUTRAL	QP
3	0.2353	36.90	-15.36	52.26	27.08	9.79	0.03	NEUTRAL	Average
4	0.2353	43.88	-18.38	62.26	34.06	9.79	0.03	NEUTRAL	QP
5	1.2357	30.25	-15.75	46.00	20.38	9.82	0.05	NEUTRAL	Average
6	1.2357	35.56	-20.44	56.00	25.69	9.82	0.05	NEUTRAL	QP
7	2.0012	33.66	-12.34	46.00	23.76	9.84	0.06	NEUTRAL	Average
8	2.0012	37.79	-18.21	56.00	27.89	9.84	0.06	NEUTRAL	QP
9	4.0062	23.31	-22.69	46.00	13.37	9.87	0.07	NEUTRAL	Average
10	4.0062	33.49	-22.51	56.00	23.55	9.87	0.07	NEUTRAL	QP
11	10.7900	26.38	-23.62	50.00	16.10	10.03	0.25	NEUTRAL	Average
12	10.7900	34.10	-25.90	60.00	23.82	10.03	0.25	NEUTRAL	QP

Note:

Level = Read Level + LISN Factor + Cable Loss.

4.2. Radiated Emissions Measurement

4.2.1. Limit

20dBc in any 100 kHz bandwidth outside the operating frequency band. In case the emission fall within the restricted band specified on 15.205(a), then the 15.209(a) limit in the table below has to be followed.

Frequencies (MHz)	Field Strength (micorvolts/meter)	Measurement Distance (meters)
0.009~0.490	2400/F(kHz)	300
0.490~1.705	24000/F(kHz)	30
1.705~30.0	30	30
30~88	100	3
88~216	150	3
216~960	200	3
Above 960	500	3

4.2.2. Measuring Instruments and Setting

Please refer to section 5 of equipments list in this report. The following table is the setting of spectrum analyzer and receiver.

Spectrum Parameter	Setting
Attenuation	Auto
Start Frequency	1000 MHz
Stop Frequency	10th carrier harmonic
RBW / VBW (Emission in restricted band)	1 MHz / 3MHz for Peak, 1 MHz / 1/T for Average
RBW / VBW (Emission in non-restricted band)	100kHz, 300kHz for peak

Receiver Parameter	Setting
Attenuation	Auto
Start ~ Stop Frequency	9kHz~150kHz, RBW 200Hz for QP
Start ~ Stop Frequency	150kHz~30MHz, RBW 9kHz for QP
Start ~ Stop Frequency	30MHz~1000MHz, RBW 120kHz for QP

4.2.3. Test Procedures

1. Configure the EUT according to ANSI C63.10. The EUT was placed on the top of the turntable 0.8 meter above ground. The phase center of the receiving antenna mounted on the top of a height-variable antenna tower was placed 1m & 3m far away from the turntable.
2. Power on the EUT and all the supporting units. The turntable was rotated by 360 degrees to determine the position of the highest radiation.
3. The height of the broadband receiving antenna was varied between one meter and four meters above ground to find the maximum emissions field strength of both horizontal and vertical polarization.
4. For each suspected emissions, the antenna tower was scan (from 1 M to 4 M) and then the turntable was rotated (from 0 degree to 360 degrees) to find the maximum reading.
5. Set the test-receiver system to Peak or CISPR quasi-peak Detect Function with specified bandwidth under Maximum Hold Mode.
6. For emissions above 1GHz, use 1MHz VBW and 3MHz RBW for peak reading. Then 1MHz RBW and 1/T VBW for average reading in spectrum analyzer.
7. When the radiated emissions limits are expressed in terms of the average value of the emissions, and pulsed operation is employed, the measurement field strength shall be determined by averaging over one complete pulse train, including blanking intervals, as long as the pulse train does not exceed 0.1 seconds. As an alternative (provided the transmitter operates for longer than 0.1 seconds) or in cases where the pulse train exceeds 0.1 seconds, the measured field strength shall be determined from the average absolute voltage during a 0.1 second interval during which the field strength is at its maximum value.
8. If the emissions level of the EUT in peak mode was 3 dB lower than the average limit specified, then testing will be stopped and peak values of EUT will be reported, otherwise, the emissions which do not have 3 dB margin will be repeated one by one using the quasi-peak method for below 1GHz.
9. For testing above 1GHz, the emissions level of the EUT in peak mode was lower than average limit (that means the emissions level in peak mode also complies with the limit in average mode), then testing will be stopped and peak values of EUT will be reported, otherwise, the emissions will be measured in average mode again and reported.
10. In case the emission is lower than 30MHz, loop antenna has to be used for measurement and the recorded data should be QP measured by receiver. High – Low scan is not required in this case.

4.2.4. Test Setup Layout

For Radiated Emissions: 9kHz ~30MHz

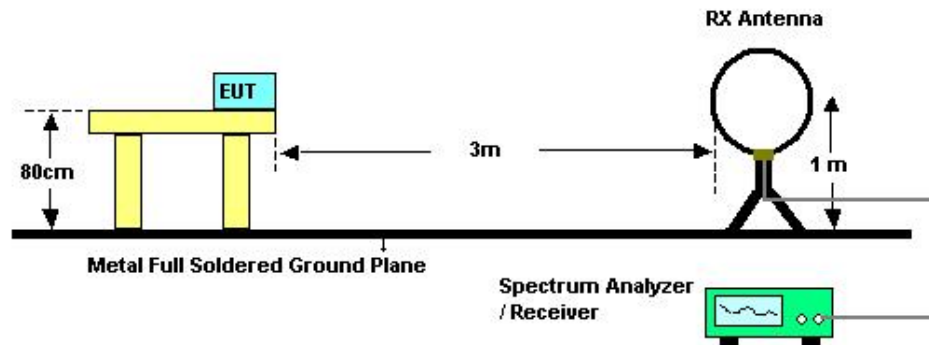

For Radiated Emissions: 30MHz~1GHz

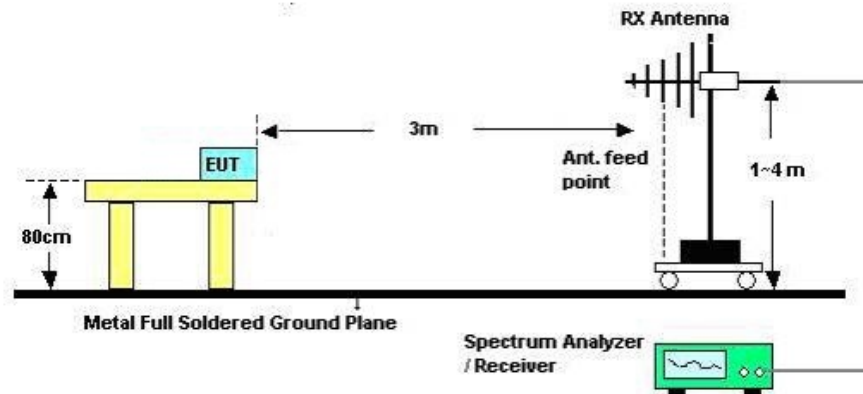

4.2.5. Test Deviation

There is no deviation with the original standard.

4.2.6. EUT Operation during Test

The EUT was programmed to be in continuously transmitting mode.

4.2.7. Results of Radiated Emissions (9kHz~30MHz)

Temperature	22.8°C	Humidity	61%
Test Engineer	Charlie Cheng / Lucke Hsieh	Configurations	Normal Link / Mode 2
Test Date	Mar. 21, 2016		

Freq. (MHz)	Level (dBuV)	Over Limit (dB)	Limit Line (dBuV)	Remark
-	-	-	-	See Note

Note:

The amplitude of spurious emissions which are attenuated by more than 20 dB below the permissible value has no need to be reported.

Distance extrapolation factor = $40 \log(\text{specific distance} / \text{test distance})$ (dB);

Limit line = specific limits (dBuV) + distance extrapolation factor.

4.2.8. Results of Radiated Emissions (30MHz~1GHz)

Temperature	22.8°C	Humidity	61%
Test Engineer	Charlie Cheng / Lucke Hsieh	Configurations	Normal Link / Mode 2

Horizontal

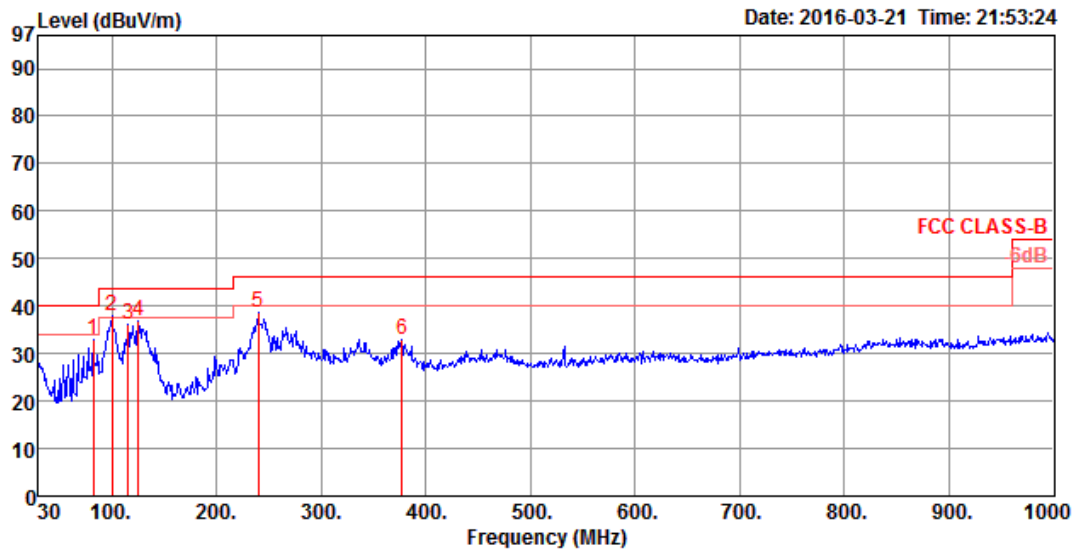

	Freq	Level	Limit	Over	Read	CableAntenna	Preamp	A/Pos	T/Pos	Remark	Pol/Phase
	MHz	dBuV/m	dBuV/m	dB	dBuV	dB	dB/m	dB	cm	deg	
1	82.38	32.76	40.00	-7.24	46.95	0.75	13.41	28.35	100	245 Peak	HORIZONTAL
2	99.84	38.00	43.50	-5.50	48.72	0.87	16.70	28.29	100	147 Peak	HORIZONTAL
3	115.36	36.24	43.50	-7.26	45.51	0.87	18.06	28.20	100	331 Peak	HORIZONTAL
4	125.06	36.84	43.50	-6.66	45.95	0.89	18.15	28.15	125	1 Peak	HORIZONTAL
5	239.52	38.74	46.00	-7.26	47.52	1.23	17.62	27.63	100	197 Peak	HORIZONTAL
6	377.26	32.86	46.00	-13.14	37.79	1.50	21.62	28.05	150	218 Peak	HORIZONTAL

Vertical

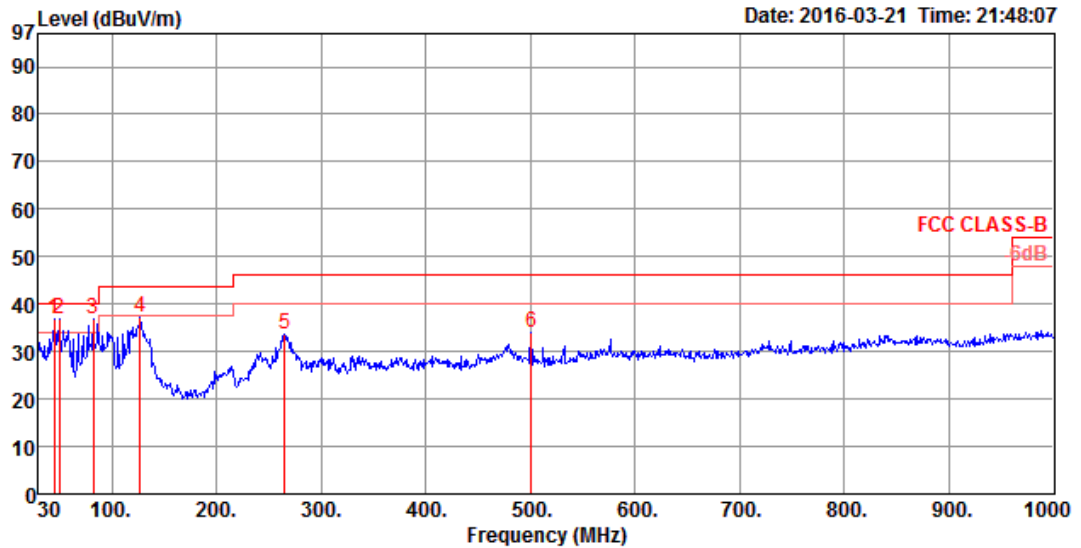

	Freq	Level	Limit	Over	Read	CableAntenna	Preamp	A/Pos	T/Pos	Remark	Pol/Phase
	MHz	dBuV/m	dBuV/m	dB	dBuV	dB	dB/m	dB	cm	deg	
1	44.55	36.96	40.00	-3.04	48.09	0.60	16.75	28.48	100	228 Peak	VERTICAL
2	49.40	36.84	40.00	-3.16	50.11	0.61	14.59	28.47	100	316 Peak	VERTICAL
3	82.38	36.73	40.00	-3.27	50.92	0.75	13.41	28.35	100	219 Peak	VERTICAL
4	127.00	37.05	43.50	-6.45	46.16	0.89	18.13	28.13	150	310 Peak	VERTICAL
5	264.74	33.81	46.00	-12.19	40.76	1.29	19.32	27.56	100	285 Peak	VERTICAL
6	500.45	34.10	46.00	-11.90	37.29	1.76	23.73	28.68	100	196 Peak	VERTICAL

Note:

The amplitude of spurious emissions which are attenuated by more than 20 dB below the permissible value has no need to be reported.

Emission level (dBuV/m) = 20 log Emission level (uV/m).

Corrected Reading: Antenna Factor + Cable Loss + Read Level - Preamp Factor = Level.

4.3. Antenna Requirements

4.3.1. Limit

Except for special regulations, the Low-power Radio-frequency Devices must not be equipped with any jacket for installing an antenna with extension cable. An intentional radiator shall be designed to ensure that no antenna other than that furnished by the responsible party shall be used with the device. The use of a permanently attached antenna or of an antenna that uses a unique coupling to the intentional radiator shall be considered sufficient to comply with the provisions of this Section. The manufacturer may design the unit so that the user can replace a broken antenna, but the use of a standard antenna jack or electrical connector is prohibited.

4.3.2. Antenna Connector Construction

Please refer to section 3.3 in this test report, antenna connector complied with the requirements.

5. LIST OF MEASURING EQUIPMENTS

Instrument	Manufacturer	Model No.	Serial No.	Characteristics	Calibration Date	Remark
EMI Test Receiver	R&S	ESCS 30	100355	9kHz ~ 2.75GHz	Apr. 22, 2015	Conduction (CO01-CB)
LISN	F.C.C.	FCC-LISN-50-16-2	04083	150kHz ~ 100MHz	Dec. 08, 2015	Conduction (CO01-CB)
LISN	Schwarzbeck	NSLK 8127	8127647	9kHz ~ 30MHz	Dec. 23, 2015	Conduction (CO01-CB)
COND Cable	Woken	Cable	01	150kHz ~ 30MHz	May 25, 2015	Conduction (CO01-CB)
Software	Audix	E3	6.120210n	-	N.C.R.	Conduction (CO01-CB)
BILOG ANTENNA	Schaffner	CBL6112D	37880	20MHz ~ 2GHz	Sep. 03, 2015	Radiation (03CH01-CB)
Loop Antenna	Teseq	HLA 6120	24155	9kHz - 30 MHz	Mar. 16, 2016*	Radiation (03CH01-CB)
Pre-Amplifier	Agilent	8447D	2944A10991	0.1MHz ~ 1.3GHz	Mar. 15, 2016	Radiation (03CH01-CB)
Spectrum Analyzer	R&S	FSP40	100056	9kHz ~ 40GHz	Oct. 27, 2015	Radiation (03CH01-CB)
EMI Receiver	Agilent	N9038A	MY52260123	9kHz ~ 8.4GHz	Jan. 27, 2016	Radiation (03CH01-CB)
RF Cable-low	Woken	Low Cable-1	N/A	30 MHz ~ 1 GHz	Nov. 02, 2015	Radiation (03CH01-CB)

Note: Calibration Interval of instruments listed above is one year.

*Calibration Interval of instruments listed above is two year.

NCR means Non-Calibration required.

6. MEASUREMENT UNCERTAINTY

Test Items	Uncertainty	Remark
Conducted Emission (150kHz ~ 30MHz)	2.4 dB	Confidence levels of 95%
Radiated Emission (30MHz ~ 1,000MHz)	3.6 dB	Confidence levels of 95%