



# FCC TEST REPORT (PART 22)

**REPORT NO.:** RF110516C10

**MODEL NO.:** DPH153-AT

**FCC ID:** MXF-DPH153AT

**RECEIVED:** May 16, 2011

**TESTED:** Aug. 22 ~ Aug. 31, 2011

**ISSUED:** Sep. 06, 2011

**APPLICANT:** Gemtek Technology Co., Ltd.

**ADDRESS:** No.15-1, Zhonghua Rd, Hsinchu Industrial Park,  
Hsinchu County, Taiwan, R.O.C. 303

**ISSUED BY:** Bureau Veritas Consumer Products Services (H.K.)  
Ltd., Taoyuan Branch

**LAB ADDRESS:** No. 47, 14th Ling, Chia Pau Tsuen, Lin Kou Hsiang,  
Taipei Hsien 244, Taiwan, R.O.C.

**TEST LOCATION:** No. 19, Hwa Ya 2nd Rd, Wen Hwa Tsuen, Kwei  
Shan Hsiang, Taoyuan Hsien 333, Taiwan, R.O.C.

This test report consists of 45 pages in total. It may be duplicated completely for legal use with the approval of the applicant. It should not be reproduced except in full, without the written approval of our laboratory. The client should not use it to claim product, certification, approval or endorsement by TAF or any government agency. The test results in the report only apply to the tested sample.



## TABLE OF CONTENTS

RELEASE CONTROL RECORD.....	4
1 CERTIFICATION .....	5
2 SUMMARY OF TEST RESULTS .....	6
2.1 MEASUREMENT UNCERTAINTY .....	6
3 GENERAL INFORMATION.....	7
3.1 GENERAL DESCRIPTION OF EUT.....	7
3.2 DESCRIPTION OF TEST MODES.....	8
3.2.1 CONFIGURATION OF SYSTEM UNDER TEST.....	8
3.2.2 TEST MODE APPLICABILITY AND TESTED CHANNEL DETAIL.....	9
3.3 GENERAL DESCRIPTION OF APPLIED STANDARDS .....	11
3.4 DESCRIPTION OF SUPPORT UNITS.....	12
4 TEST TYPES AND RESULTS.....	13
4.1 OUTPUT POWER MEASUREMENT .....	13
4.1.1 LIMITS OF OUTPUT POWER MEASUREMENT.....	13
4.1.2 TEST INSTRUMENTS .....	14
4.1.3 TEST PROCEDURES .....	15
4.1.4 TEST SETUP .....	16
4.1.5 EUT OPERATING CONDITIONS.....	16
4.1.6 TEST RESULTS .....	17
4.2 FREQUENCY STABILITY MEASUREMENT .....	18
4.2.1 LIMITS OF FREQUENCY STABILITY MEASUREMENT.....	18
4.2.2 TEST INSTRUMENTS .....	18
4.2.3 TEST PROCEDURE .....	19
4.2.4 TEST SETUP .....	19
4.2.5 TEST RESULTS .....	20
4.3 OCCUPIED BANDWIDTH MEASUREMENT.....	21
4.3.1 LIMITS OF OCCUPIED BANDWIDTH MEASUREMENT.....	21
4.3.2 TEST INSTRUMENTS .....	21
4.3.3 TEST SETUP .....	21
4.3.4 TEST PROCEDURES.....	22
4.3.5 EUT OPERATING CONDITION .....	22
4.3.6 TEST RESULTS .....	23
4.4 BAND EDGE MEASUREMENT .....	24
4.4.1 LIMITS OF BAND EDGE MEASUREMENT.....	24
4.4.2 TEST INSTRUMENTS .....	24
4.4.3 TEST SETUP .....	24
4.4.4 TEST PROCEDURES.....	25



4.4.5	EUT OPERATING CONDITION .....	25
4.4.6	TEST RESULTS .....	26
4.5	CONDUCTED SPURIOUS EMISSIONS .....	27
4.5.1	LIMITS OF CONDUCTED SPURIOUS EMISSIONS MEASUREMENT .....	27
4.5.2	TEST INSTRUMENTS .....	27
4.5.3	TEST PROCEDURE .....	28
4.5.4	TEST SETUP .....	28
4.5.5	EUT OPERATING CONDITIONS .....	28
4.5.6	TEST RESULTS .....	29
4.6	RADIATED EMISSION MEASUREMENT .....	35
4.6.1	LIMITS OF RADIATED EMISSION MEASUREMENT .....	35
4.6.2	TEST INSTRUMENTS .....	35
4.6.3	TEST PROCEDURES .....	36
4.6.4	DEVIATION FROM TEST STANDARD .....	36
4.6.5	TEST SETUP .....	37
4.6.6	EUT OPERATING CONDITIONS .....	37
4.6.7	TEST RESULTS (FREQUENCY RANGE BELOW 1GHz) .....	38
4.6.8	TEST RESULTS (FREQUENCY RANGE ABOVE 1GHz) .....	40
5	PHOTOGRAPHS OF THE TEST CONFIGURATION .....	43
6	INFORMATION ON THE TESTING LABORATORIES .....	44
7	APPENDIX A – MODIFICATIONS RECORDERS FOR ENGINEERING CHANGES TO THE EUT BY THE LAB .....	45



## RELEASE CONTROL RECORD

ISSUE NO.	REASON FOR CHANGE	DATE ISSUED
Original release	N/A	Sep. 06, 2011

## 1 CERTIFICATION

**PRODUCT :** FEMTOCELL, DUAL BAND, 2 PORT  
**MODEL NO. :** DPH153-AT  
**BRAND :** CISCO  
**APPLICANT :** Gemtek Technology Co., Ltd.  
**TEST SAMPLE :** ENGINEERING SAMPLE  
**TESTED :** Aug. 22 ~ Aug. 31, 2011  
**STANDARDS :** **FCC Part 22, Subpart H**  
ANSI C63.4-2003

The above equipment (model: DPH153-AT) has been tested by **Bureau Veritas Consumer Products Services (H.K.) Ltd., Taoyuan Branch**, and found compliance with the requirement of the above standards. The test record, data evaluation & Equipment Under Test (EUT) configurations represented herein are true and accurate accounts of the measurements of the sample's EMC characteristics under the conditions specified in this report.

**PREPARED BY :** , **DATE :** Sep. 06, 2011  
Joanna Wang / Senior Specialist

**APPROVED BY :** , **DATE :** Sep. 06, 2011  
Gary Chang / Technical Manager

## 2 SUMMARY OF TEST RESULTS

The EUT has been tested according to the following specifications:

APPLIED STANDARD: FCC Part 22 & Part 2			
STANDARD SECTION	TEST TYPE AND LIMIT	RESULT	REMARK
2.1046 22.913 (a)	Maximum Peak Output Power Limit: max. 7 watts e.r.p peak power	PASS	Meet the requirement of limit. Minimum passing margin is 13.1dBm at 871.4MHz.
2.1055	Frequency Stability AFC Freq. Error vs. Voltage AFC Freq. Error vs. Temperature Limit: max. $\pm 2.5$ ppm	PASS	Meet the requirement of limit.
2.1049 (h)	Occupied Bandwidth	PASS	Meet the requirement of limit.
22.917	Band Edge Measurements	PASS	Meet the requirement of limit.
2.1051 22.917	Conducted Spurious Emissions	PASS	Meet the requirement of limit.
2.1053 22.917	Radiated Spurious Emissions	PASS	Meet the requirement of limit. Minimum passing margin is -18.6dB at 36.02MHz.

### 2.1 MEASUREMENT UNCERTAINTY

Where relevant, the following measurement uncertainty levels have been estimated for tests performed on the EUT as specified in CISPR 16-4-2:

MEASUREMENT	FREQUENCY	UNCERTAINTY
Conducted emissions	9kHz~30MHz	2.44dB
Radiated emissions	30MHz ~ 200MHz	2.93dB
	200MHz ~1000MHz	2.95dB
	1GHz ~ 18GHz	2.26dB
	18GHz ~ 40GHz	1.94dB

This uncertainty represents an expanded uncertainty expressed at approximately the 95% confidence level using a coverage factor of  $k=2$ .

### 3 GENERAL INFORMATION

#### 3.1 GENERAL DESCRIPTION OF EUT

<b>PRODUCT</b>	FEMTOCELL, DUAL BAND, 2 PORT	
<b>MODEL NO.</b>	DPH153-AT	
<b>FCC ID</b>	MXF-DPH153AT	
<b>NOMINAL VOLTAGE</b>	12Vdc (adapter)	
<b>MODULATION TYPE</b>	<b>WCDMA</b>	16QAM
<b>FREQUENCY RANGE</b>	<b>WCDMA</b>	871.4MHz ~ 891.6MHz
<b>RELEASE VERSION</b>	<b>WCDMA</b>	Release 5
<b>MAX. ERP POWER</b>	<b>WCDMA</b>	0.0204Watts
<b>ANTENNA TYPE</b>	PCB printed antenna with 1.5dBi gain	
<b>DATA CABLE</b>	NA	
<b>I/O PORTS</b>	Refer to user's manual	
<b>ACCESSORY DEVICES</b>	Adapter	

**NOTE:**

- The EUT was powered by the following adapters:

ADAPTER 1	
<b>BRAND:</b>	ENG
<b>MODEL:</b>	3A-156WU12
<b>INPUT:</b>	100-120Vac, 50-60Hz, 0.4A
<b>OUTPUT:</b>	12Vdc, 1.25A
<b>POWER LINE:</b>	1.5m non-shielded cable without core

ADAPTER 2	
<b>BRAND:</b>	OEM
<b>MODEL:</b>	A015112-PU2
<b>INPUT:</b>	100-240Vac, 50-60Hz, 0.5A
<b>OUTPUT:</b>	12Vdc, 1.25A
<b>POWER LINE:</b>	1.5m non-shielded cable without core

- The above EUT information is declared by manufacturer and for more detailed feature description, please refer to the manufacturer's specifications or User's Manual.

### 3.2 DESCRIPTION OF TEST MODES

102 channels are provided to this EUT. Therefore, the low, middle and high channels are chosen for testing.

	CHANNEL	FREQUENCY	TX MODE
LOW	4357	871.4 MHz	WCDMA
MIDDLE	4408	881.6 MHz	WCDMA
HIGH	4458	891.6 MHz	WCDMA

**NOTE:**

1. Below 1 GHz, the channel 4357, 4408 and 4458 were pre-tested in chamber. The channel 4458 was chosen for final test.
2. Above 1 GHz, the channel 4357, 4408 and 4458 were tested individually.
3. The channel space is 0.2MHz.

#### 3.2.1 CONFIGURATION OF SYSTEM UNDER TEST

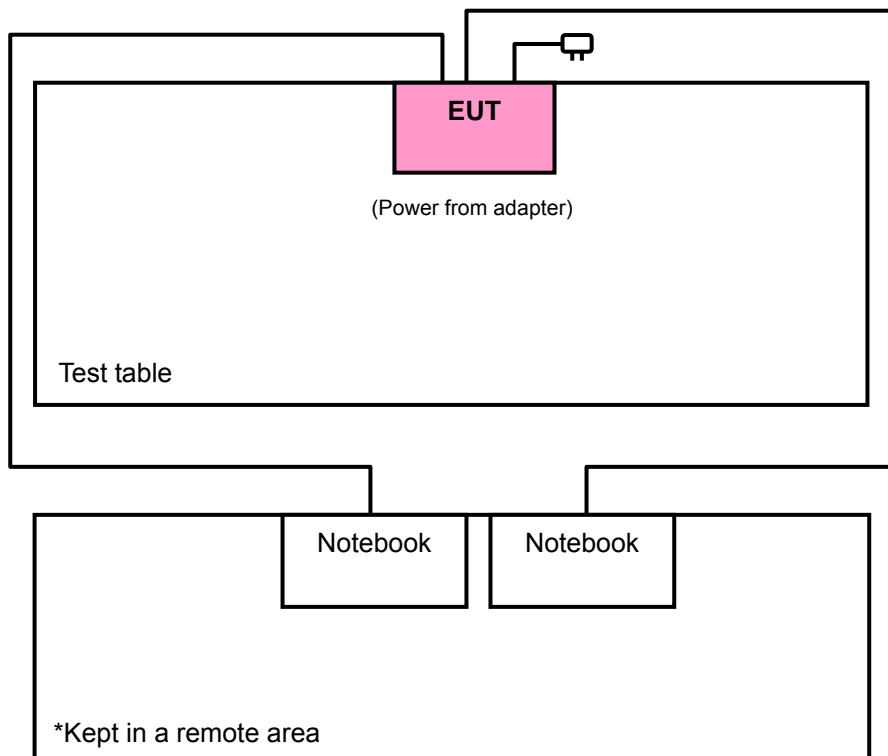



### 3.2.2 TEST MODE APPLICABILITY AND TESTED CHANNEL DETAIL

EUT CONFIGURE MODE	APPLICABLE TO							DESCRIPTION
	OP	FS	OB	BE	CE	RE<1G	RE≥1G	
A	-	-	-	-	-	√	-	Adapter 1
B	√	√	√	√	√	√	√	Adapter 2

Where **OP**: Output power **FS**: Frequency stability  
**OB**: Occupied bandwidth **BE**: Band edge  
**CE**: Conducted spurious emissions **RE<1G**: Radiated emission below 1GHz  
**RE≥1G**: Radiated emission above 1GHz

**NOTE:** "-" means no effect

#### OUTPUT POWER MEASUREMENT:

- Pre-Scan has been conducted to determine the worst-case mode from all possible combinations between available modulations and antenna ports (if EUT with antenna diversity architecture).
- Following channel(s) was (were) selected for the final test as listed below.

EUT CONFIGURE MODE	AVAILABLE CHANNEL	TESTED CHANNEL	MODULATION TECHNOLOGY
B	4357 to 4458	4357, 4408, 4458	WCDMA

#### FREQUENCY STABILITY MEASUREMENT:

- Pre-Scan has been conducted to determine the worst-case mode from all possible combinations between available modulations and antenna ports (if EUT with antenna diversity architecture).
- Following channel(s) was (were) selected for the final test as listed below.

EUT CONFIGURE MODE	AVAILABLE CHANNEL	TESTED CHANNEL	MODULATION TECHNOLOGY
B	4357 to 4458	4357	WCDMA

#### OCCUPIED BANDWIDTH MEASUREMENT:

- This item includes all test value of each mode, but only includes spectrum plot of worst value of each mode.
- Pre-Scan has been conducted to determine the worst-case mode from all possible combinations between available modulations and antenna ports (if EUT with antenna diversity architecture).
- Following channel(s) was (were) selected for the final test as listed below.

EUT CONFIGURE MODE	AVAILABLE CHANNEL	TESTED CHANNEL	MODULATION TECHNOLOGY
B	4357 to 4458	4357, 4408, 4458	WCDMA

**BAND EDGE MEASUREMENT:**

- Pre-Scan has been conducted to determine the worst-case mode from all possible combinations between available modulations and antenna ports (if EUT with antenna diversity architecture).
- Following channel(s) was (were) selected for the final test as listed below.

EUT CONFIGURE MODE	AVAILABLE CHANNEL	TESTED CHANNEL	MODULATION TECHNOLOGY
B	4357 to 4458	4357, 4458	WCDMA

**CONDUCTED SPURIOUS EMISSIONS MEASUREMENT:**

- Pre-Scan has been conducted to determine the worst-case mode from all possible combinations between available modulations and antenna ports (if EUT with antenna diversity architecture).
- Following channel(s) was (were) selected for the final test as listed below.

EUT CONFIGURE MODE	AVAILABLE CHANNEL	TESTED CHANNEL	MODULATION TECHNOLOGY
B	4357 to 4458	4357, 4408, 4458	WCDMA

**RADIATED EMISSION MEASUREMENT (BELOW 1 GHz):**

- Pre-Scan has been conducted to determine the worst-case mode from all possible combinations between available modulations, XYZ Axis and antenna ports (if EUT with antenna diversity architecture).
- Following channel(s) was (were) selected for the final test as listed below.

EUT CONFIGURE MODE	AVAILABLE CHANNEL	TESTED CHANNEL	MODULATION TECHNOLOGY	AXIS
A, B	4357 to 4458	4357	WCDMA	Z

**RADIATED EMISSION MEASUREMENT (ABOVE 1 GHz):**

- Pre-Scan has been conducted to determine the worst-case mode from all possible combinations between available modulations, XYZ Axis and antenna ports (if EUT with antenna diversity architecture).
- Following channel(s) was (were) selected for the final test as listed below.

EUT CONFIGURE MODE	AVAILABLE CHANNEL	TESTED CHANNEL	MODULATION TECHNOLOGY	AXIS
B	4357 to 4458	4357, 4408, 4458	WCDMA	Z

**TEST CONDITION:**

APPLICABLE TO	ENVIRONMENTAL CONDITIONS	INPUT POWER	TESTED BY
OP	25deg. C, 68%RH	120Vac, 60Hz	Sun Lin
FS	25deg. C, 68%RH	120Vac, 60Hz	Sun Lin
OB	25deg. C, 68%RH	120Vac, 60Hz	Sun Lin
EM	25deg. C, 68%RH	120Vac, 60Hz	Sun Lin
BE	25deg. C, 68%RH	120Vac, 60Hz	Sun Lin
CE	25deg. C, 68%RH	120Vac, 60Hz	Sun Lin
RE < 1G	25deg. C, 65%RH	120Vac, 60Hz	Antony Lee
RE ≥ 1G	25deg. C, 68%RH	120Vac, 60Hz	Sun Lin

**3.3 GENERAL DESCRIPTION OF APPLIED STANDARDS**

The EUT is a RF product. According to the specifications of the manufacturer, it must comply with the requirements of the following standards:

**FCC 47 CFR Part 2**

**FCC 47 CFR Part 22**

**ANSI C63.4-2003**

**ANSI/TIA/EIA-603-C 2004**

**NOTE:** All test items have been performed and recorded as per the above standards.

### 3.4 DESCRIPTION OF SUPPORT UNITS

The EUT has been tested as an independent unit together with other necessary accessories or support units. The following support units or accessories were used to form a representative test configuration during the tests.

NO.	PRODUCT	BRAND	MODEL NO.	SERIAL NO.	FCC ID
1	NOTEBOOK	DELL	PP18L	33497605792	CXSMM01BRD02D330
2	NOTEBOOK	DELL	D531	CN-0XM006-48643-8 1U-2610	QDS-BRCM1020

NO.	SIGNAL CABLE DESCRIPTION OF THE ABOVE SUPPORT UNITS
1	10m RJ45 cable without core
2	10m RJ45 cable without core

**NOTE 1:** All power cords of the above support units are non shielded (1.8m).

**NOTE 2:** Item 1~2 acted as a communication partners to transfer data.

## **4 TEST TYPES AND RESULTS**

### **4.1 OUTPUT POWER MEASUREMENT**

#### **4.1.1 LIMITS OF OUTPUT POWER MEASUREMENT**

The radiated peak output power shall be according to the specific rule Part 22.913 (a) that "Mobile / Portable station are limited to 7 watts e.r.p".

#### 4.1.2 TEST INSTRUMENTS

DESCRIPTION & MANUFACTURER	MODEL NO.	SERIAL NO.	DATE OF CALIBRATION	DUE DATE OF CALIBRATION
Test Receiver ROHDE & SCHWARZ	ESCI	100744	Apr. 19, 2011	Apr. 18, 2012
Spectrum Analyzer ROHDE & SCHWARZ	FSP40	100269	Jan. 06, 2011	Jan. 05, 2012
BILOG Antenna SCHWARZBECK	VULB9168	9168-156	Apr. 12, 2011	Apr. 11, 2012
HORN Antenna SCHWARZBECK	BBHA 9120 D	9120D-404	Dec. 28, 2010	Dec. 27, 2011
HORN Antenna SCHWARZBECK	BBHA 9170	BBHA9170243	Dec. 27, 2010	Dec. 26, 2011
Preamplifier Agilent	8449B	3008A01910	Sep. 09, 2010	Sep. 08, 2011
Preamplifier Agilent	8447D	2944A10638	Nov. 03, 2010	Nov. 02, 2011
RF signal cable HUBER+SUHNNER	SUCOFLEX 104	295013/4 283403/4	Sep 03, 2010	Sep 03, 2011
RF signal cable Worken	8D-FB	Cable-HYCH9-01	Aug. 13, 2011	Aug. 12, 2012
Software	ADT_Radiated_ V7.6.15.9.2	NA	NA	NA
Antenna Tower EMCO	2070/2080	512.835.4684	NA	NA
Turn Table EMCO	2087-2.03	NA	NA	NA
Antenna Tower & Turn Table Controller EMCO	2090	NA	NA	NA

- NOTE:**
1. The calibration interval of the above test instruments is 12 months and the calibrations are traceable to NML/ROC and NIST/USA.
  2. The test was performed in HwaYa Chamber 9.
  3. The horn antenna and HP preamplifier (model: 8449B) are used only for the measurement of emission frequency above 1GHz if tested.
  4. The FCC Site Registration No. is 460141.
  5. The IC Site Registration No. is IC 7450F-4.

### 4.1.3 TEST PROCEDURES

#### **EIRP / ERP MEASUREMENT:**

- a. The power was measured with R&S Spectrum Analyzer. All measurements were done at 3 channels, 4357, 4408 and 4458 (WCDMA) (low, middle and high operational frequency range.) RWB and VBW is 5MHz for WCDMA mode.
- b. Substitution method is used for E.I.R.P measurement. In the semi-anechoic chamber, EUT placed on the 0.8m height of Turn Table, rotated the table around 360 degrees to search the maximum radiation power and receiver antenna shall be rotated vertical and horizontal polarization and moved height from 1m to 4m to find the maximum polar radiated power. The “Read Value” is the spectrum reading the maximum power value.
- c. The substitution horn antenna is substituted for EUT at the same position and signals generator export the CW signal to the substitution antenna via a tx cable. Rotated the Turn Table and moved receiving antenna to find the maximum radiation power. Adjust output power level of S.G to get a Value of spectrum reading equal to “Read Value” of step c. Record the power level of S.G
- d.  $EIRP = \text{Output power level of S.G} - \text{TX cable loss} + \text{Antenna gain of substitution horn.}$
- e. E.R.P power can be calculated form E.I.R.P power by subtracting the gain of dipole,  
 $E.R.P \text{ power} = E.I.P.R \text{ power} - 2.15\text{dBi.}$

#### 4.1.4 TEST SETUP

##### EIRP / ERP MEASUREMENT:

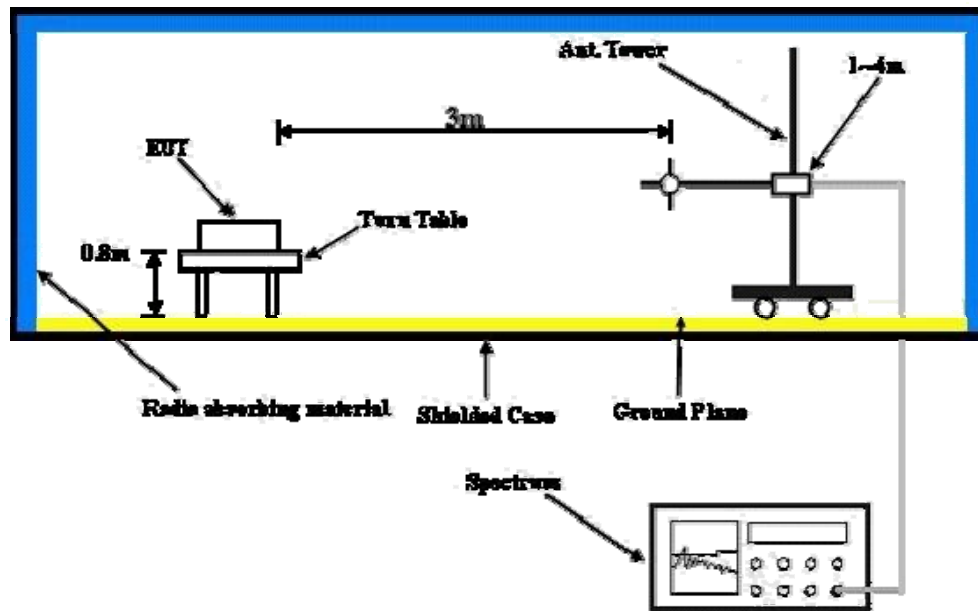

For the actual test configuration, please refer to the attached file (Test Setup Photo).

#### 4.1.5 EUT OPERATING CONDITIONS

- a. Placed the EUT on the testing table.
- b. Prepared two notebooks to act as communication partners and placed them outside of testing area.
- c. Notebook sends commands to control EUT to transmit at specific frequency, modulation and output power level via telnet utility.



#### 4.1.6 TEST RESULTS

ERP POWER					
CHANNEL NO.	FREQUENCY (MHz)	S.G VALUE (dBm)	CORRECTION FACTOR (dB)	OUTPUT POWER	
				dBm	Watt
4357	871.4	21.7	-8.6	13.1	0.0204
4408	881.6	21.5	-8.6	12.9	0.0195
4458	891.6	21.4	-8.7	12.7	0.0186

**REMARKS:** 1. Output Power (dBm) = S.G Value (dBm) + Correction Factor (dB).  
 2. Correction Factor (dB) = Substitution Antenna Gain (dB) + Cable Loss (dB).

## 4.2 FREQUENCY STABILITY MEASUREMENT

### 4.2.1 LIMITS OF FREQUENCY STABILITY MEASUREMENT

According to the FCC part 22.863 shall be tested the frequency stability. The rule is defined that "The frequency stability shall be sufficient to ensure that the fundamental emission stays within the authorized frequency block." The frequency error rate is according to the JTC standard that the frequency error rate shall be accurate to within 2.5ppm of the received frequency from the base station. The test extreme voltage is according to the 2.1055(d)(1) Vary primary supply voltage from 85 to 115 percent of the nominal value for other than hand carried battery equipment and the extreme temperature rule is comply with the 2.1055(a)(1)  $-30^{\circ}\text{C} \sim 55^{\circ}\text{C}$ .

### 4.2.2 TEST INSTRUMENTS

DESCRIPTION & MANUFACTURER	MODEL NO.	SERIAL NO.	DATE OF CALIBRATION	DUE DATE OF CALIBRATION
Spectrum Analyzer Agilent	E4446A	MY44360124	Dec. 29, 2010	Dec. 28, 2011
Hewlett Packard RF cable	8120-6192	01428251	NA	NA
RF cable	SUCOFLEX 104	257029	Jan. 27, 2011	Jan. 26, 2012
WIT Standard Temperature & Humidity Chamber	MHU-225AU	920842	Jun. 15, 2011	Jun. 14, 2012

**NOTE:** The calibration interval of the above test instruments is 12 months. And the calibrations are traceable to NML/ROC and NIST/USA.

### 4.2.3 TEST PROCEDURE

- a. Because of the measure the carrier frequency under the condition of the AFC lock, it shall be used the mobile station in the WCDMA link mode. This is accomplished with the use of the communication simulator station. The oven room could control the temperatures and humidity.
- b. Power must be removed when changing from one temperature to another or one voltage to another voltage. Power warm up is at least 15 min and power applied should perform before recording frequency error.
- c. EUT is connected the external power supply to control the host equipment power. The various Volts from the minimum 93.5 Volts to 126.5 Volts. Each step shall be record the frequency error rate.
- d. The temperature range step is 10 degrees in this test items. All temperature levels shall be hold the  $\pm 0.5^{\circ}\text{C}$  during the measurement testing.
- e. The each temperature step shall be at least 0.5 hours, consider the EUT could be test under the stability condition.

**NOTE:** The frequency error was recorded frequency error from the communication simulator.

### 4.2.4 TEST SETUP

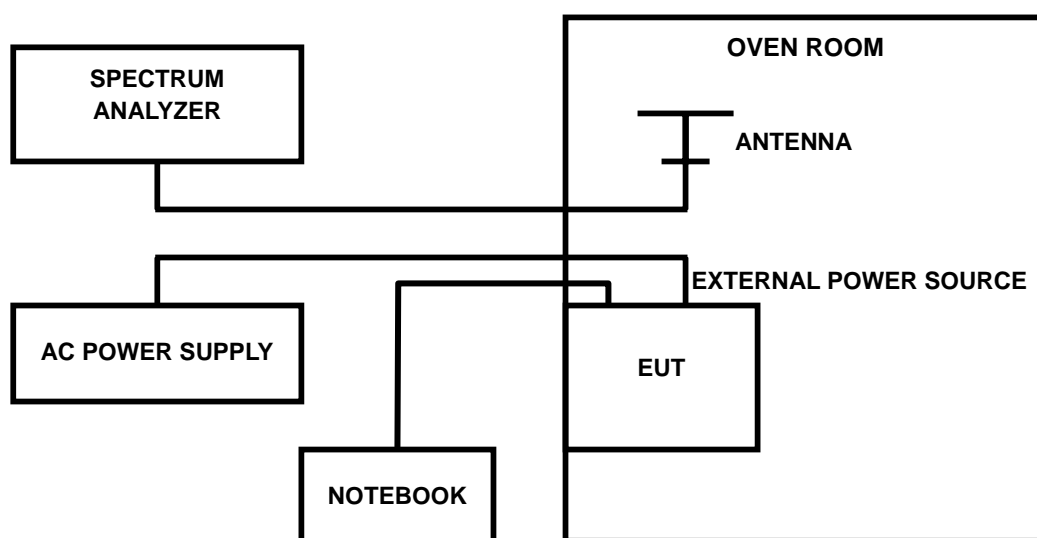

#### 4.2.5 TEST RESULTS

AFC FREQUENCY ERROR vs. VOLTAGE			
VOLTAGE (Volts)	FREQUENCY ERROR (MHz)	FREQUENCY ERROR (ppm)	LIMIT (ppm)
93.5	871.400535	0.614	2.5
110.0	871.400436	0.500	2.5
126.5	871.400529	0.607	2.5

**NOTE:** The applicant defined the normal working voltage of the host equipment is from 93.5Vac to 126.5Vac.

AFC FREQUENCY ERROR vs. TEMP.			
TEMP. (°C)	FREQUENCY ERROR (MHz)	FREQUENCY ERROR (ppm)	LIMIT (ppm)
55	871.400792	0.909	2.5
50	871.400720	0.826	2.5
40	871.400897	1.029	2.5
30	871.400501	0.575	2.5
20	871.400436	0.500	2.5
10	871.400498	0.571	2.5
0	871.400265	0.304	2.5
-10	871.400394	0.452	2.5
-20	871.400768	0.881	2.5
-30	871.400709	0.814	2.5

### 4.3 OCCUPIED BANDWIDTH MEASUREMENT

#### 4.3.1 LIMITS OF OCCUPIED BANDWIDTH MEASUREMENT

The width of a frequency band such that, below the lower and above the upper frequency limits, the mean powers emitted are each equal to a specified percentage 0.5 %of the total mean power of a given emission.

#### 4.3.2 TEST INSTRUMENTS

DESCRIPTION & MANUFACTURER	MODEL NO.	SERIAL NO.	DATE OF CALIBRATION	DUE DATE OF CALIBRATION
ROHDE & SCHWARZ Spectrum Analyzer	FSP40	100040	Aug. 01, 2011	Jul. 31, 2012
RF cable	SUCOFLEX 104	274403/4	Aug. 19, 2011	Aug. 18, 2012
RF cable	SUCOFLEX 104	250729/4	Aug. 19, 2011	Aug. 18, 2012
RF cable	SUCOFLEX 104	214377/4	Aug. 19, 2011	Aug. 18, 2012
JFW 20dB attenuation	50HF-020-SMA	NA	NA	NA

**NOTE:** The calibration interval of the above test instruments is 12 months. And the calibrations are traceable to NML/ROC and NIST/USA.

#### 4.3.3 TEST SETUP

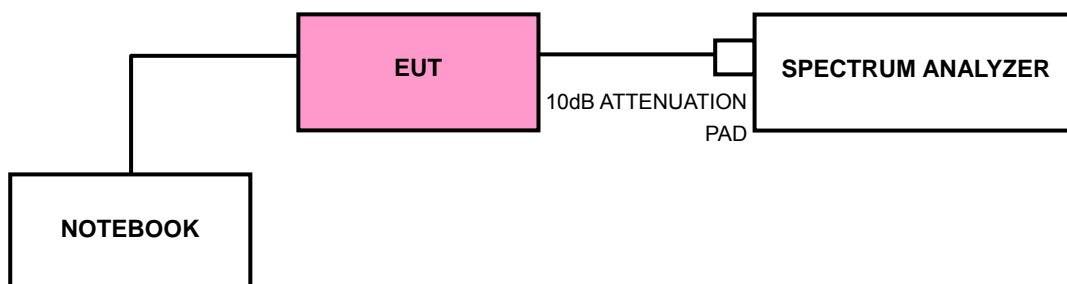

#### 4.3.4 TEST PROCEDURES

- a. The power was measured with R&S Spectrum Analyzer. All measurements were done at 3 channels, 4357, 4408 and 4458 (WCDMA) (low, middle and high operational frequency range.)
- b. EUT connected to spectrum analyzer with a 10 dB attenuator.
- c. Notebook sends commands to control EUT to export maximum output power under transmission mode and specific channel frequency. Use OBW measurement function of Spectrum analyzer to measure 99 % occupied bandwidth.

#### 4.3.5 EUT OPERATING CONDITION

Same as 4.1.5.

### 4.3.6 TEST RESULTS

CHANNEL	FREQUENCY (MHz)	99% OCCUPIED BANDWIDTH (MHz)
4357	871.4	4.18
4408	881.6	4.16
4458	891.6	4.20

#### CH 4458

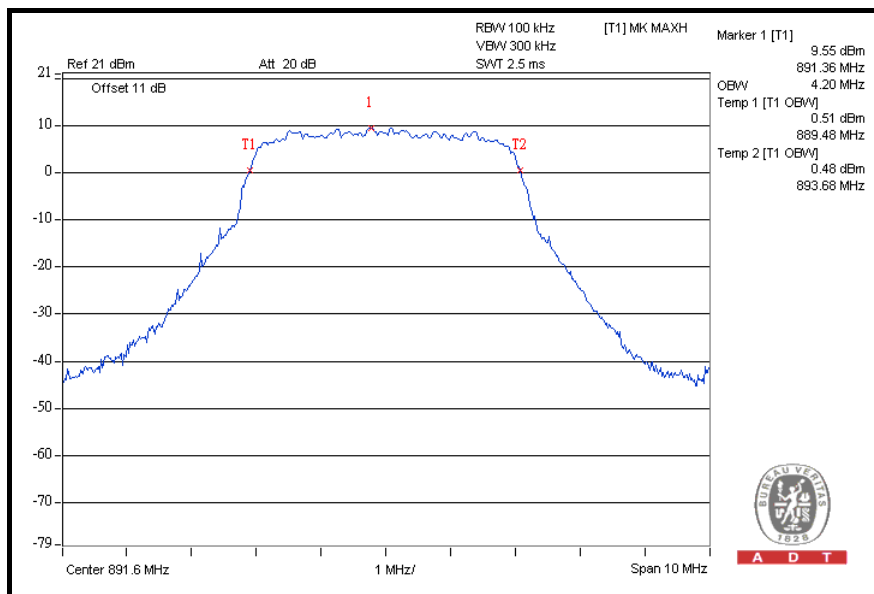

## 4.4 BAND EDGE MEASUREMENT

### 4.4.1 LIMITS OF BAND EDGE MEASUREMENT

According to FCC 22.917 specified that power of any emission outside of the authorized operating frequency ranges must be attenuated below the transmitting power (P) by a factor of at least  $43 + 10 \log(P)$  dB. In the 1 MHz bands immediately outside and adjacent to the frequency block a resolution bandwidth of at least one percent of the emission bandwidth of the fundamental emission of the transmitter may be employed.

### 4.4.2 TEST INSTRUMENTS

DESCRIPTION & MANUFACTURER	MODEL NO.	SERIAL NO.	DATE OF CALIBRATION	DUE DATE OF CALIBRATION
ROHDE & SCHWARZ Spectrum Analyzer	FSP40	100040	Aug. 01, 2011	Jul. 31, 2012
RF cable	SUCOFLEX 104	274403/4	Aug. 19, 2011	Aug. 18, 2012
RF cable	SUCOFLEX 104	250729/4	Aug. 19, 2011	Aug. 18, 2012
RF cable	SUCOFLEX 104	214377/4	Aug. 19, 2011	Aug. 18, 2012
JFW 20dB attenuation	50HF-020-SMA	NA	NA	NA

**NOTE:** The calibration interval of the above test instruments is 12 months. And the calibrations are traceable to NML/ROC and NIST/USA.

### 4.4.3 TEST SETUP

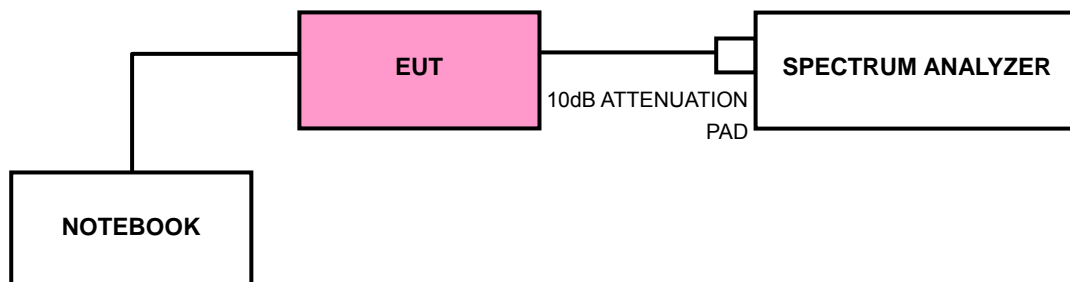



#### 4.4.4 TEST PROCEDURES

- a. EUT connected to spectrum analyzer with a 10 dB attenuator
- b. Notebook sends commands to control EUT to transmit at specific frequency, modulation and output power level via telnet utility. The power was measured with R&S Spectrum Analyzer. All measurements were done at 2 channels (low and high operational frequency range.).
- c. The center frequency of spectrum is the band edge frequency and span is 10MHz. RB of the spectrum is 100kHz and VB of the spectrum is 300kHz (WCDMA).
- d. Record the max trace plot into the test report.

#### 4.4.5 EUT OPERATING CONDITION

Same as 4.1.5.

## 4.4.6 TEST RESULTS

### LOWER BAND EDGE

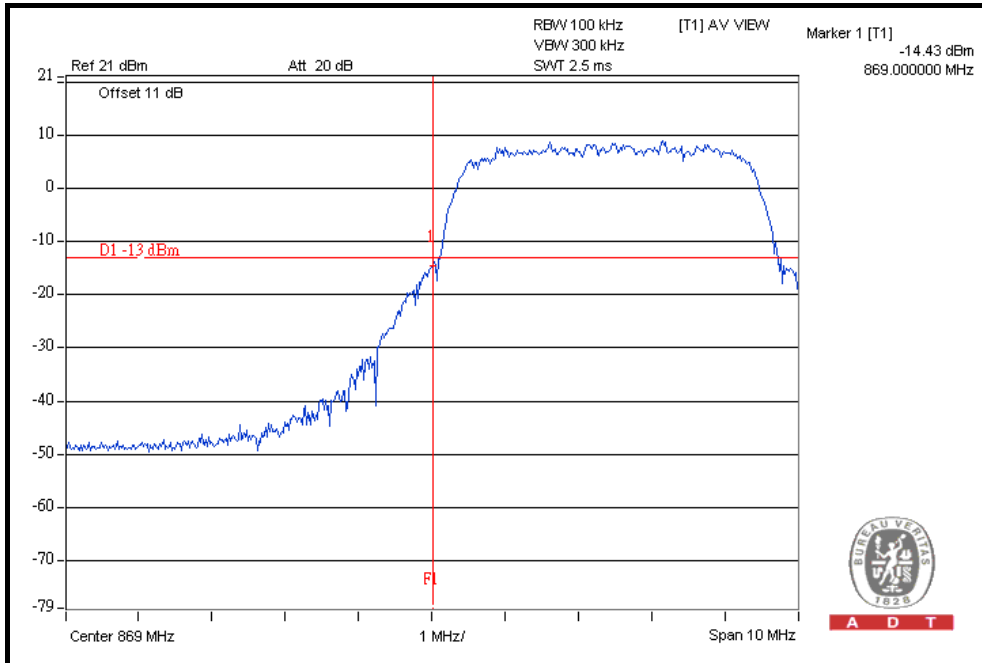

### HIGHER BAND EDGE

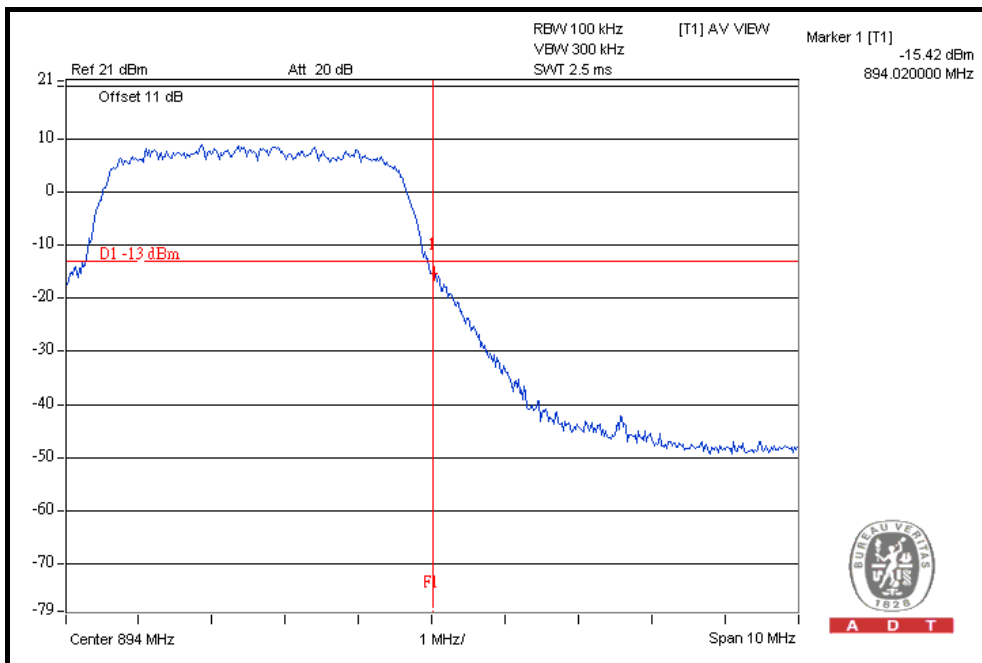

## 4.5 CONDUCTED SPURIOUS EMISSIONS

### 4.5.1 LIMITS OF CONDUCTED SPURIOUS EMISSIONS MEASUREMENT

In the FCC 22.917, On any frequency outside a licensee's frequency block within GPRS spectrum, the power of any emission shall be attenuated below the transmitter power (P) by at least  $43 + 10 \log (P)$  dB. The emission limit equal to  $-13\text{dBm}$ .

### 4.5.2 TEST INSTRUMENTS

DESCRIPTION & MANUFACTURER	MODEL NO.	SERIAL NO.	DATE OF CALIBRATION	DUE DATE OF CALIBRATION
ROHDE & SCHWARZ Spectrum Analyzer	FSP40	100040	Aug. 01, 2011	Jul. 31, 2012
RF cable	SUCOFLEX 104	274403/4	Aug. 19, 2011	Aug. 18, 2012
RF cable	SUCOFLEX 104	250729/4	Aug. 19, 2011	Aug. 18, 2012
RF cable	SUCOFLEX 104	214377/4	Aug. 19, 2011	Aug. 18, 2012
JFW 20dB attenuation	50HF-020-SMA	NA	NA	NA

**NOTE:** The calibration interval of the above test instruments is 12 months. And the calibrations are traceable to NML/ROC and NIST/USA.

#### 4.5.3 TEST PROCEDURE

- a. EUT connected to spectrum analyzer with a 10 dB attenuator
- b. Notebook sends commands to control EUT to transmit at specific frequency, modulation and output power level via telnet utility
- c. The EUT was set up for the maximum peak power with WCDMA link data modulation. The power was measured with R&S Spectrum Analyzer. All measurements were done at 3 channels, 4357, 4408 and 4458 (WCDMA) (low, middle and high operational frequency range.)
- d. Measuring frequency range is from 9 kHz to 20GHz. 10dB attenuation pad is connected with spectrum. RBW=1MHz and VBW=3MHz is used for conducted emission measurement.

#### 4.5.4 TEST SETUP

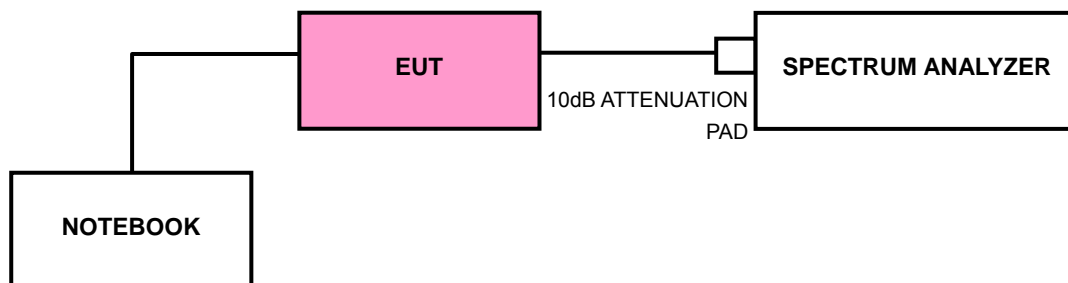

#### 4.5.5 EUT OPERATING CONDITIONS

Same as 4.1.5.

## 4.5.6 TEST RESULTS

### CH 4357: 9kHz ~ 1GHz

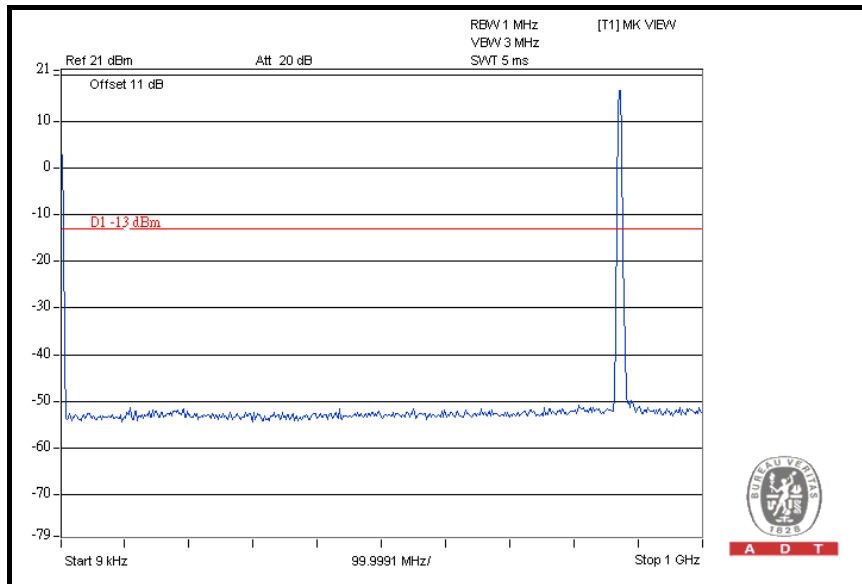

### 1GHz ~ 4GHz

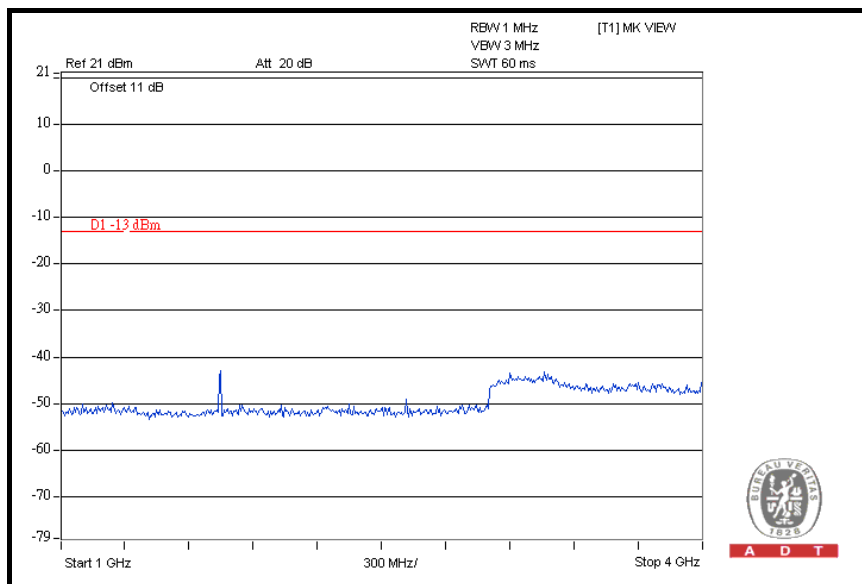



A D T

### 4GHz ~ 7GHz

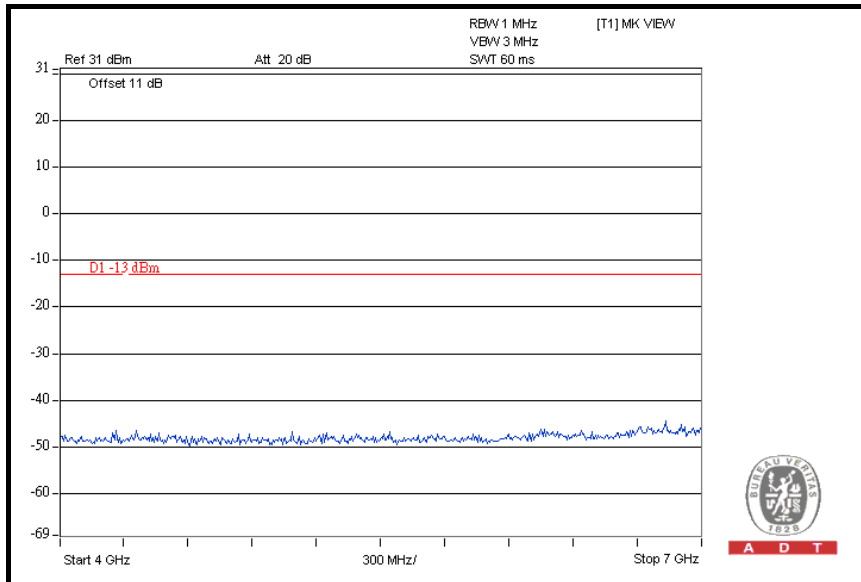

### 7GHz ~ 9GHz

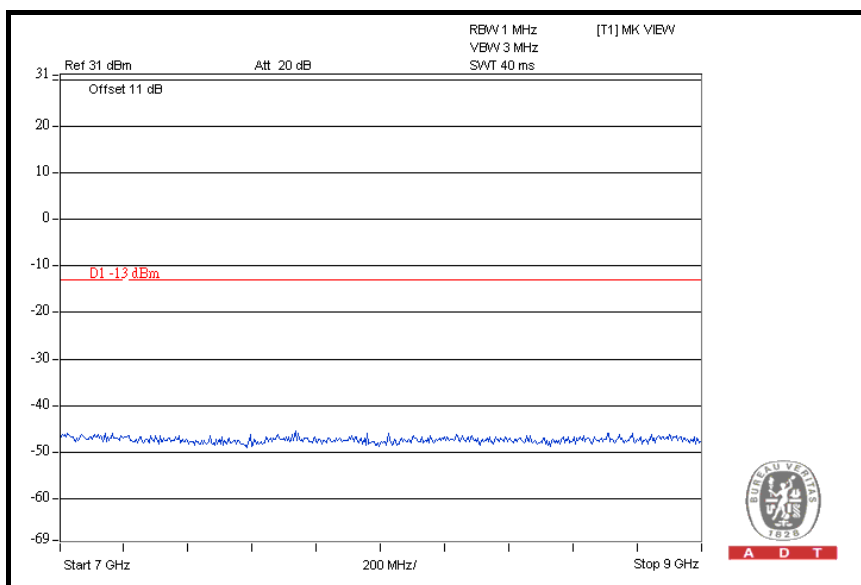

**CH 4408: 9kHz ~ 1GHz**

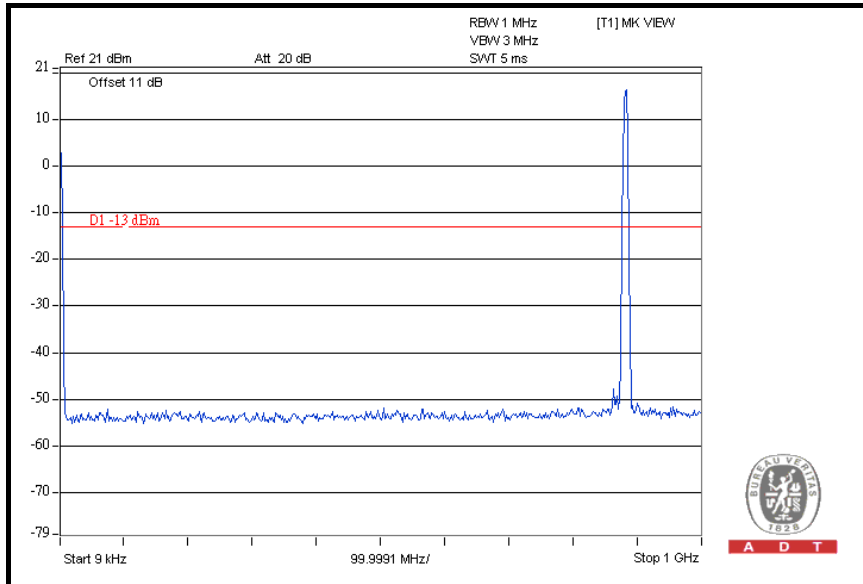

**1GHz ~ 4GHz**

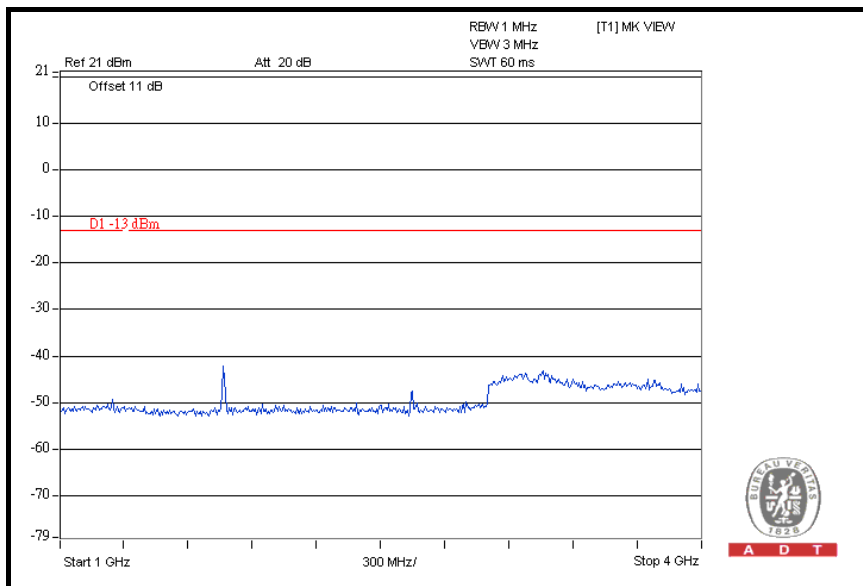

### 4GHz ~ 7GHz

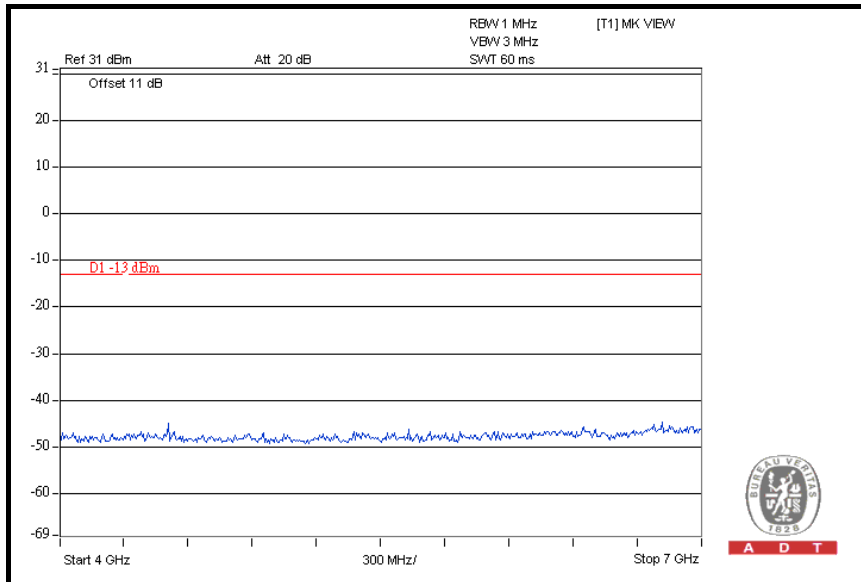

### 7GHz ~ 9GHz

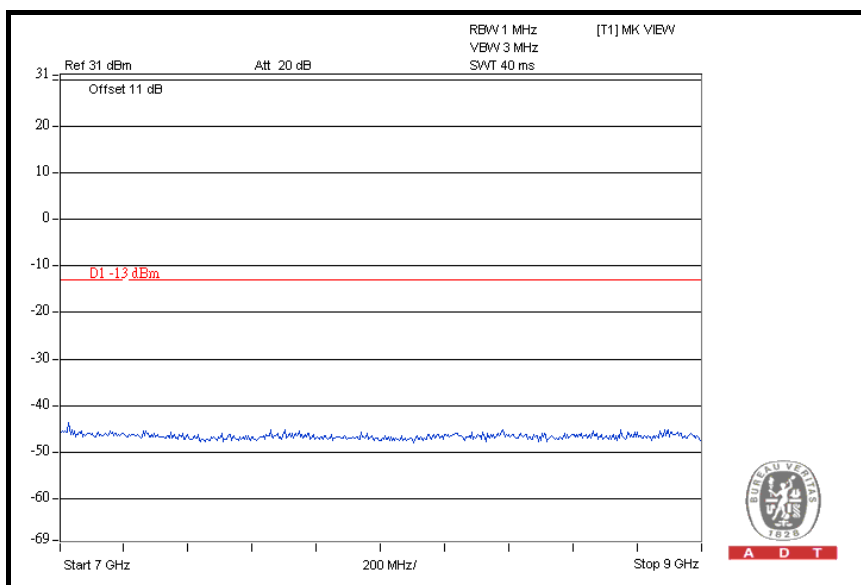



**CH 4458: 9kHz ~ 1GHz**

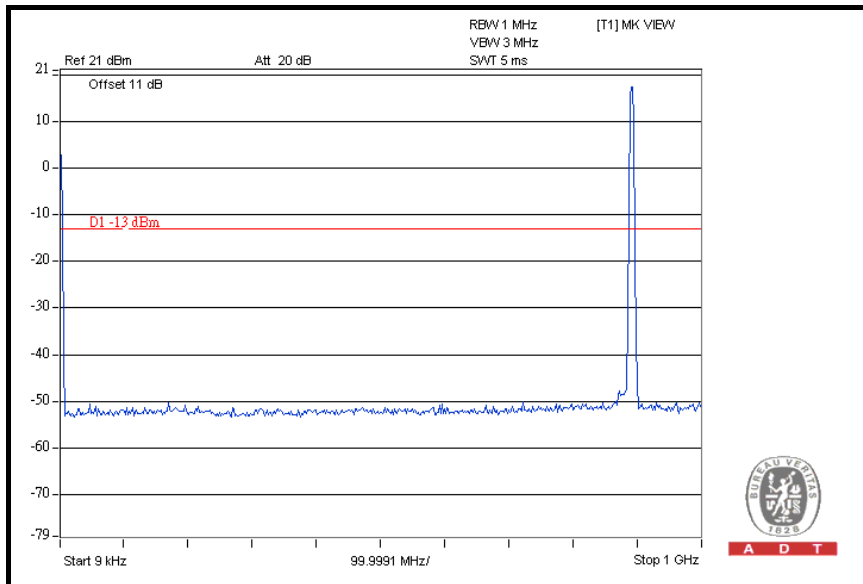

**1GHz ~ 4GHz**

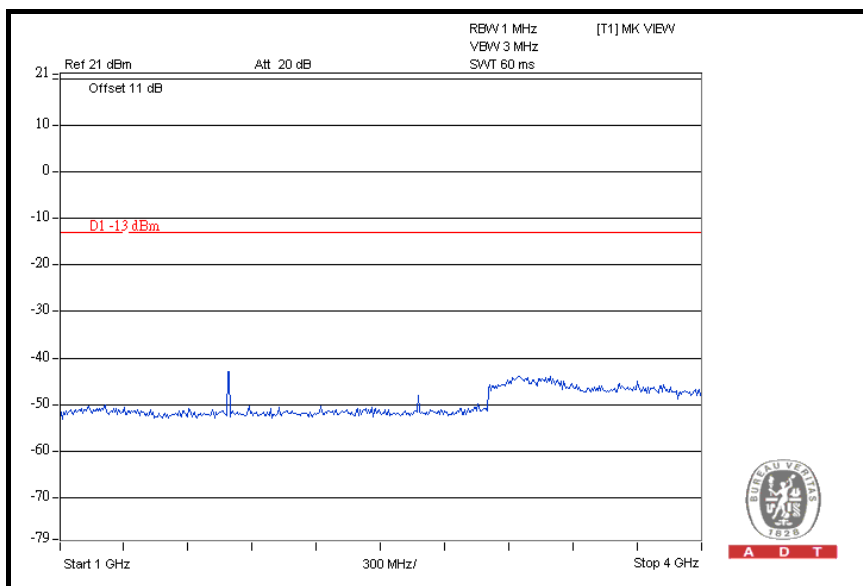



A D T

### 4GHz ~ 7GHz

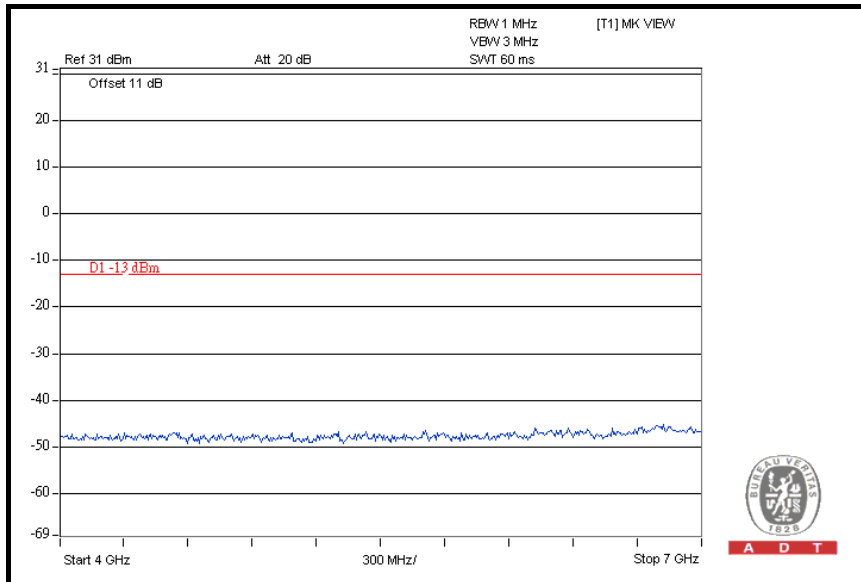

### 7GHz ~ 9GHz

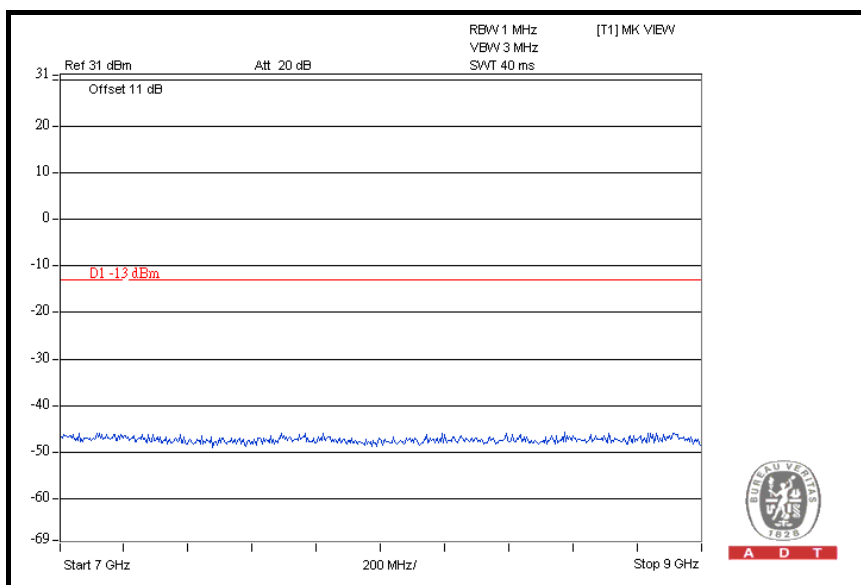

## 4.6 RADIATED EMISSION MEASUREMENT

### 4.6.1 LIMITS OF RADIATED EMISSION MEASUREMENT

In the FCC 22.917 (a), On any frequency outside a licensee's frequency block within GPRS spectrum, the power of any emission shall be attenuated below the transmitter power (P) by at least  $43 + 10 \log (P)$  dB. The emission limit equal to  $-13\text{dBm}$ .

### 4.6.2 TEST INSTRUMENTS

Same as 4.1.2.

#### 4.6.3 TEST PROCEDURES

- a. Substitution method is used for E.I.R.P measurement. In the semi-anechoic chamber, EUT placed on the 0.8m height of Turn Table, rotated the table around 360 degrees to search the maximum radiation power and receiver antenna shall be rotated vertical and horizontal polarization and moved height from 1m to 4m to find the maximum polar radiated power. The “Read Value” is the spectrum reading the maximum power value.
- b. The substitution horn antenna is substituted for EUT at the same position and signals generator export the CW signal to the substitution antenna via a tx cable. Rotated the Turn Table and moved receiving antenna to find the maximum radiation power. Adjust output power level of S.G to get a Value of spectrum reading equal to “Read Value” of step c. Record the power level of S.G
- c.  $EIRP = \text{Output power level of S.G} - \text{TX cable loss} + \text{Antenna gain of substitution horn.}$
- d. E.R.P power can be calculated form E.I.R.P power by subtracting the gain of dipole,  
 $E.R.P \text{ power} = E.I.P.R \text{ power} - 2.15dBi.$

**NOTE:** The resolution bandwidth and video bandwidth of test receiver/spectrum analyzer is 1MHz/3MHz.

#### 4.6.4 DEVIATION FROM TEST STANDARD

No deviation.

#### 4.6.5 TEST SETUP

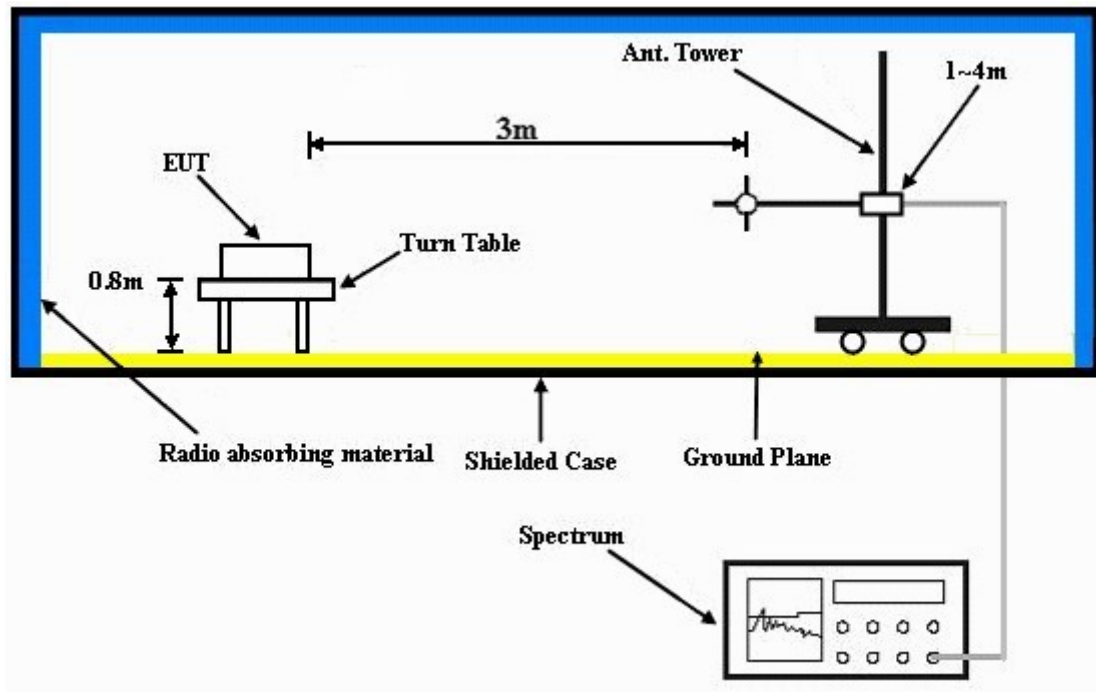

For the actual test configuration, please refer to the attached file (Test Setup Photo).

#### 4.6.6 EUT OPERATING CONDITIONS

Same as 4.1.5.

#### 4.6.7 TEST RESULTS (FREQUENCY RANGE BELOW 1GHz)

<b>MODE</b>	TX channel 4357	<b>FREQUENCY RANGE</b>	Below 1000 MHz
<b>ENVIRONMENTAL CONDITIONS</b>	25deg. C, 65%RH	<b>INPUT POWER</b>	120Vac, 60 Hz
<b>TESTED BY</b>	Antony Lee	<b>TEST MODE</b>	A

ANTENNA POLARITY & TEST DISTANCE: HORIZONTAL AT 3 M						
No.	Freq. (MHz)	Emission Level (dBuV)	Limit (dBm)	S.G Power Value (dBm)	Correction Factor (dB)	Power Value (dBm)
1	125.03	38.6	-13	-48.5	-7.7	-56.2
2	250.83	47.9	-13	-39.1	-7.7	-46.8
3	463.24	42.8	-13	-43.8	-7.7	-51.5
4	501.22	47.3	-13	-38.7	-7.8	-46.5
5	583.04	42.6	-13	-43.3	-7.8	-51.1
6	751.03	44.8	-13	-42.9	-7.9	-50.8
ANTENNA POLARITY & TEST DISTANCE: VERTICAL AT 3 M						
No.	Freq. (MHz)	Emission Level (dBuV)	Limit (dBm)	S.G Power Value (dBm)	Correction Factor (dB)	Power Value (dBm)
1	125.62	39.4	-13	-47.4	-7.7	-55.1
2	250.26	39.8	-13	-47.1	-7.7	-54.8
3	439.26	46.9	-13	-39.9	-7.7	-47.6
4	500.02	46.2	-13	-40.4	-7.8	-48.2
5	625.69	43.5	-13	-42.4	-7.8	-50.2
6	752.03	42.8	-13	-43.3	-7.9	-51.2

**NOTE:** Power Value (dBum) = S.G Power Value (dBm) + Correction Factor (dB).



A D T

<b>MODE</b>	TX channel 4357	<b>FREQUENCY RANGE</b>	Below 1000 MHz
<b>ENVIRONMENTAL CONDITIONS</b>	25deg. C, 65%RH	<b>INPUT POWER</b>	120Vac, 60 Hz
<b>TESTED BY</b>	Antony Lee	<b>TEST MODE</b>	B

<b>ANTENNA POLARITY &amp; TEST DISTANCE: HORIZONTAL AT 3 M</b>						
No.	Freq. (MHz)	Emission Level (dBuV)	Limit (dBm)	S.G Power Value (dBm)	Correction Factor (dB)	Power Value (dBm)
1	35.89	48.5	-13	-38.5	-7.7	-46.2
2	60.50	46.2	-13	-40.5	-7.7	-48.2
3	128.36	50.7	-13	-38.0	-7.7	-45.7
4	250.03	49.3	-13	-38.7	-7.7	-46.4
5	500.03	51.1	-13	-37.9	-7.8	-45.7
6	625.74	46.2	-13	-40.5	-7.8	-48.3

<b>ANTENNA POLARITY &amp; TEST DISTANCE: VERTICAL AT 3 M</b>						
No.	Freq. (MHz)	Emission Level (dBuV)	Limit (dBm)	S.G Power Value (dBm)	Correction Factor (dB)	Power Value (dBm)
1	36.02	62.8	-13	-23.9	-7.7	-31.6
2	85.04	56.8	-13	-29.5	-7.7	-37.2
3	125.77	49.9	-13	-38.7	-7.7	-46.4
4	450.25	52.3	-13	-35.7	-7.7	-43.4
5	500.02	49.8	-13	-38.3	-7.8	-46.1
6	625.32	46.2	-13	-43.0	-7.8	-50.8

**NOTE:** Power Value (dBum) = S.G Power Value (dBm) + Correction Factor (dB).

#### 4.6.8 TEST RESULTS (FREQUENCY RANGE ABOVE 1GHz)

<b>MODE</b>	TX channel 4357	<b>FREQUENCY RANGE</b>	Above 1000 MHz
<b>INPUT POWER</b>	120Vac, 60 Hz	<b>ENVIRONMENTAL CONDITIONS</b>	25deg. C, 68%RH
<b>TESTED BY</b>	Sun Lin		

ANTENNA POLARITY & TEST DISTANCE: HORIZONTAL AT 3 M						
No.	Freq. (MHz)	Emission Level (dBuV)	Limit (dBm)	S.G Power Value (dBm)	Correction Factor (dB)	Power Value (dBm)
1	1742.8	39.2	-13.0	-62.9	7.9	-55.0
2	2614.2	41.3	-13.0	-61.5	8.5	-53.0
3	3485.6	45.1	-13.0	-59.4	10.0	-49.4
ANTENNA POLARITY & TEST DISTANCE: VERTICAL AT 3 M						
No.	Freq. (MHz)	Emission Level (dBuV)	Limit (dBm)	S.G Power Value (dBm)	Correction Factor (dB)	Power Value (dBm)
1	1742.8	39.8	-13.0	-62.3	7.9	-54.4
2	2614.2	41.3	-13.0	-61.5	8.5	-53.0
3	3485.6	45.3	-13.0	-59.2	10.0	-49.2

**NOTE:** Power Value (dBum) = S.G Power Value (dBm) + Correction Factor (dB).



<b>MODE</b>	TX channel 4408	<b>FREQUENCY RANGE</b>	Above 1000 MHz
<b>INPUT POWER</b>	120Vac, 60 Hz	<b>ENVIRONMENTAL CONDITIONS</b>	25deg. C, 68%RH
<b>TESTED BY</b>	Sun Lin		

ANTENNA POLARITY & TEST DISTANCE: HORIZONTAL AT 3 M						
No.	Freq. (MHz)	Emission Level (dBuV)	Limit (dBm)	S.G Power Value (dBm)	Correction Factor (dB)	Power Value (dBm)
1	1763.2	40.4	-13.0	-62.3	8.3	-54.0
2	2644.8	42.8	-13.0	-60.0	8.5	-51.5
3	3526.4	46.2	-13.0	-58.0	10.0	-48.0
ANTENNA POLARITY & TEST DISTANCE: VERTICAL AT 3 M						
No.	Freq. (MHz)	Emission Level (dBuV)	Limit (dBm)	S.G Power Value (dBm)	Correction Factor (dB)	Power Value (dBm)
1	1763.2	39.3	-13.0	-63.4	8.3	-55.1
2	2644.8	42.4	-13.0	-60.4	8.5	-51.9
3	3526.4	48.2	-13.0	-56.0	10.0	-46.0

**NOTE:** Power Value (dBum) = S.G Power Value (dBm) + Correction Factor (dB).

<b>MODE</b>	TX channel 4458	<b>FREQUENCY RANGE</b>	Above 1000 MHz
<b>INPUT POWER</b>	120Vac, 60 Hz	<b>ENVIRONMENTAL CONDITIONS</b>	25deg. C, 68%RH
<b>TESTED BY</b>	Sun Lin		

ANTENNA POLARITY & TEST DISTANCE: HORIZONTAL AT 3 M						
No.	Freq. (MHz)	Emission Level (dBuV)	Limit (dBm)	S.G Power Value (dBm)	Correction Factor (dB)	Power Value (dBm)
1	1783.2	39.8	-13.0	-62.8	8.3	-54.5
2	2674.8	41.9	-13.0	-60.8	8.6	-52.2
3	3566.4	45.8	-13.0	-58.5	9.9	-48.6
ANTENNA POLARITY & TEST DISTANCE: VERTICAL AT 3 M						
No.	Freq. (MHz)	Emission Level (dBuV)	Limit (dBm)	S.G Power Value (dBm)	Correction Factor (dB)	Power Value (dBm)
1	1783.2	40.8	-13.0	-61.8	8.3	-53.5
2	2674.8	41.8	-13.0	-60.9	8.6	-52.3
3	3566.4	45.8	-13.0	-58.5	9.9	-48.6

**NOTE:** Power Value (dBum) = S.G Power Value (dBm) + Correction Factor (dB).

## 5 PHOTOGRAPHS OF THE TEST CONFIGURATION

Please refer to the attached file (Test Setup Photo).



## 6 INFORMATION ON THE TESTING LABORATORIES

We, Bureau Veritas Consumer Products Services (H.K.) Ltd., Taoyuan Branch, were founded in 1988 to provide our best service in EMC, Radio, Telecom and Safety consultation. Our laboratories are accredited and approved according to ISO/IEC 17025.

Copies of accreditation certificates of our laboratories obtained from approval agencies can be downloaded from our web site: [www.adt.com.tw/index.5.phtml](http://www.adt.com.tw/index.5.phtml).  
If you have any comments, please feel free to contact us at the following:

**Linko EMC/RF Lab:**  
Tel: 886-2-26052180  
Fax: 886-2-26051924

**Hsin Chu EMC/RF Lab:**  
Tel: 886-3-5935343  
Fax: 886-3-5935342

**Hwa Ya EMC/RF/Safety/Telecom Lab:**  
Tel: 886-3-3183232  
Fax: 886-3-3185050

**Email:** [service.adt@tw.bureauveritas.com](mailto:service.adt@tw.bureauveritas.com)  
**Web Site:** [www.adt.com.tw](http://www.adt.com.tw)

The address and road map of all our labs can be found in our web site also.

## **7 APPENDIX A – MODIFICATIONS RECORDERS FOR ENGINEERING CHANGES TO THE EUT BY THE LAB**

No any modifications are made to the EUT by the lab during the test.

**---END---**