

FCC SAR Test Report (Class II Permissive Change)

Product Name : Intel Wireless-AC 9560
Model No. : 9560D2W

Applicant : ASUSTeK COMPUTER INC.
Address : 4F, No. 150, Li-Te Rd., Peitou, Taipei, Taiwan

Date of Receipt : 2019/03/09
Issued Date : 2019/03/19
Report No. : 1930114R-SAUSP64V00
Report Version : V1.0



The test results relate only to the samples tested.

The test results shown in the test report are traceable to the national/international standard through the calibration of the equipment and evaluated measurement uncertainty herein.

This report must not be used to claim product endorsement by TAF or any agency of the government.

The test report shall not be reproduced without the written approval of DEKRA Testing and Certification Co., Ltd.

Test Report

Issued Date: 2019/03/19

Report No.: 1930114R-SAUSP64V00



Product Name : Intel Wireless-AC 9560
 Applicant : ASUSTeK COMPUTER INC.
 Address : 4F, No. 150, Li-Te Rd., Peitou, Taipei, Taiwan
 Manufacturer : Intel Mobile Communications
 Model No. : 9560D2W
 Trade Name : Intel
 FCC ID : MSQ9560D2
 Applicable Standard : 47CFR § 2.1093
 KDB 447498 D01 v06
 Measurement : KDB 248227 D01 v02r02
 procedures : KDB 616217 D04 V01r02
 KDB 865664 D01 V01r04
 Test Result : Max. SAR Measurement (1g)
 2.4GHz: **0.635** W/kg
 5 GHz: **1.155** W/kg
 Application Type : Certification

The above equipment has been tested by DEKRA, and found compliance with the requirement of the above standards. The test record, data evaluation & Equipment Under Test (EUT) configurations represented herein are true and accurate accounts of the measurements of the sample's SAR characteristics under the conditions specified in this report.

Documented By : _____

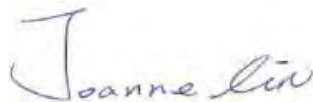

(Senior Adm. Specialist / Joanne Lin)

Tested By : _____



(Senior Engineer / Vorana Chen)

Approved By : _____



(Director / Vincent Lin)

TABLE OF CONTENTS

Description	Page
1. General Information.....	3
1.1 EUT Description	4
1.2 Antenna List	5
1.3 SAR Test Exclusion Calculation	6
1.4 Test Environment	10
2. SAR Measurement System	11
2.1 DASY5 System Description	11
2.1.1 Applications	12
2.1.2 Area Scans	12
2.1.3 Zoom Scan (Cube Scan Averaging)	12
2.1.4 Uncertainty of Inter-/Extrapolation and Averaging	12
2.2 DASY5 E-Field Probe	13
2.2.1 Isotropic E-Field Probe Specification	13
2.3 Boundary Detection Unit and Probe Mounting Device.....	14
2.4 DATA Acquisition Electronics (DAE) and Measurement Server	14
2.5 Robot.....	15
2.6 Light Beam Unit	15
2.7 Device Holder	16
2.8 SAM Twin Phantom	16
3. Tissue Simulating Liquid	17
3.1 The composition of the tissue simulating liquid.....	17
3.2 Tissue Calibration Result.....	17
3.3 Tissue Dielectric Parameters for Head and Body Phantoms	19
4. SAR Measurement Procedure	20
4.1 SAR System Check	20
4.1.1 Dipoles.....	20
4.1.2 System Check Result	20
4.2 SAR Measurement Procedure.....	22
5. SAR Exposure Limits	23
6. Test Equipment List.....	24
7. Measurement Uncertainty	27
8. Conducted Power Measurement (Including tolerance allowed for production unit)	29
9. Test Results.....	37
9.1 SAR Test Results Summary	37
9.2 Simultaneous Transmission.....	39
9.2.1 Simultaneous transmission of MIMO in 802.11 test exclusion considerations	39
9.2.2 simultaneous transmission of Wi-Fi and other wireless technologies....	41
10. SAR measurement variability	42
Appendix	43
Appendix A. SAR System Check Data	43
Appendix B. SAR measurement Data	43
Appendix C. Test Setup Photographs & EUT Photographs	43
Appendix D. Probe Calibration Data.....	43
Appendix E. Dipole Calibration Data	43

1. General Information

1.1 EUT Description

Product Name	Intel Wireless-AC 9560				
Trade Name	Intel				
Model No.	9560D2W				
FCC ID	MSQ9560D2				
TX Frequency	802.11b/g/n-20MHz:2412MHz~2472MHz, 802.11n-40MHz: 2422MHz~2462MHz 802.11a/n-20:5180-5320MHz,5500-5720MHz, 5745-5825MHz 802.11n-40/MHz: 5190-5310MHz, 5510-5670MHz, 5755-5795MHz 802.11ac-20MHz: 5720MHz, 802.11ac-40MHz: 5710MHz 802.11ac-80MHz: 5210-5290MHz, 5530-5690MHz, 5775MHz 802.11ac-160: 5250MHz, BT : 2402 – 2480MHz				
Channel separation	802.11b/g/n-20MHz: 5 MHz, 802.11a/n-20/ac-20MHz: 20MHz 802.11n-40/ac-40MHz: 40MHz, 802.11ac-80MHz: 80MHz 802.11ac-160MHz: 320MHz, BT : 1MHz , BLE : 2MHz				
Number of Channels	802.11b/g/n-20MHz: 13, n-40MHz: 9 802.11a/n-20MHz: 24; 802.11n-40MHz: 11 802.11ac-20MHz: 1, 802.11ac-40MHz: 1,802.11ac-80MHz: 6 802.11ac-160MHz: 1, BT : 79 , BLE : 40				
Data Rate	802.11b: 1-11Mbps, 802.11a/g: 6-54Mbps, 802.11n: up to 300Mbps 802.11ac-80MHz: up to 866.7Mbps, 802.11ac-160: up to 1733.3Mbps BT : 3Mbps , BLE : 1Mbps				
Type of Modulation	DSSS/OFDM/BPSK/QPSK/16QAM/64QAM/256QAM FHSS: GFSK(1Mbps) / π /4DQPSK(2Mbps) / 8DPSK(3Mbps)				
Antenna Type	PIFA				
Device Category	Portable				
RF Exposure Environment	Uncontrolled				
Summary of test result –Reported 1g SAR (W/Kg)					
Test configuration	DTS(Main)	DTS(Aux)	U-NII(Main)	U-NII(Aux)	DTS(BT)
Body-Standalone	0.635	0.630	1.082	0.812	0.341
Body-Simultaneous	DTS (Main + Aux)		U-NII (MIMO)		UNII(MIMO)+BT
	1.265		1.155		1.496
When BT and WIFI transmitter does simultaneously transmitter, WIFI will transmit on Main and BT will transmit on Aux					

* Note: (1) This is to request a Class II permissive change for FCC ID: MSQ9560D2 originally granted on 03/07/2018.

The major change filed under this application is:

Change

#1: Additional Chassis added, ASUSTeK, model number: UX562F, RX562F, Q546F.

Brand	Model	Difference
ASUS	UX562F	All models are electrically identical, different model names are for marketing purpose.
	RX562F	
	Q546F	

#2: Reduce the Output Power through firmware, and SAR measurement were evaluated. (Only reduce Wi-Fi Output Power, Bluetooth Output Power haven't changes).

#3: Addition one antenna, the antenna a type is same, the antenna gain is lower than the original application.

(2) Modular has proceed 15mm which smaller than 25mm of bystander requirement and excluded testing.

1.2 Antenna List

No.	Manufacturer	Part No.(Vendor)	Part No.(ASUS)	Peak Gain
1.	INPAQ (NB)	MDA-LB-02-013 (Main) MDA-LB-01-007 (Aux)	14008-03240600 (Main) 14008-03240700 (Aux)	0.3dBi in 2.4GHz -2.8dBi for 5.15~5.25GHz -1.0dBi for 5.25~5.35GHz -1.3dBi for 5.47~5.725GHz -2.2dBi For 5.725~5.850GHz
2.	INPAQ (PAD)	MDA-LB-02-013 (Main) MDA-LB-01-007 (Aux)	14008-03240600 (Main) 14008-03240700 (Aux)	1.3dBi in 2.4GHz 0.9dBi for 5.15~5.25GHz 1.5dBi for 5.25~5.35GHz 2.1dBi for 5.47~5.725GHz 0.6dBi For 5.725~5.850GHz

Note:

- (1) There are the same antenna only difference in Manufacturer.
- (2) INPAQ (P/N: MDA-LB-02-013) and ASUS (P/N: 14008-03240600) both antennas are identical.
INPAQ (P/N: MDA-LB-01-007) and ASUS (P/N: 14008-03240700) both antennas are identical.

1.3 SAR Test Exclusion Calculation

According to KDB Publication 447498 D01, section 4.3.1, per the calculations of item 1 ($\text{Power(mW)}/\text{separation (mm)} \cdot \sqrt{f(\text{GHz})} \leq 3.0$), SAR is required as shown in the table below where calculated values are greater than 3.0 :

NB Mode SAR exclusion calculations for WiFi-SISO and Bluetooth for antenna < 50mm from the user :

Antenna	Tx	Frequency (MHz)	Output Power		Separation distances (mm)					Calculated Threshold Value (≤ 3.0 SAR is not required)				
			dBm	mW	Right	Left	Top	Bottom	Front	Right	Left	Top	Bottom	Front
Main	WiFi	2462	13.50	22	135	193	222	3	213	>50mm	>50mm	>50mm	7.0	>50mm
Main	WiFi	5240	14.50	28	135	193	222	3	213	>50mm	>50mm	>50mm	12.9	>50mm
Main	WiFi	5320	14.50	28	135	193	222	3	213	>50mm	>50mm	>50mm	13.0	>50mm
Main	WiFi	5700	14.50	28	135	193	222	3	213	>50mm	>50mm	>50mm	13.5	>50mm
Main	WiFi	5825	14.50	28	135	193	222	3	213	>50mm	>50mm	>50mm	13.6	>50mm

NB Mode SAR exclusion calculations for WiFi-SISO and Bluetooth for antenna > 50mm from the user :

Antenna	Tx	Frequency (MHz)	Output Power		Separation distances (mm)					Calculated Threshold Value (SAR test exclusion power,mW)				
			dBm	mW	Right	Left	Top	Bottom	Front	Right	Left	Top	Bottom	Front
Main	WiFi	2462	13.50	22	135	193	222	3	213	945.6	1525.6	1815.6	<50mm	1725.6
Main	WiFi	5240	14.50	28	135	193	222	3	213	915.5	1495.5	1785.5	<50mm	1695.5
Main	WiFi	5320	14.50	28	135	193	222	3	213	915.0	1495.0	1785.0	<50mm	1695.0
Main	WiFi	5700	14.50	28	135	193	222	3	213	912.8	1492.8	1782.8	<50mm	1692.8
Main	WiFi	5825	14.50	28	135	193	222	3	213	912.2	1492.2	1782.2	<50mm	1692.2

NB Mode SAR exclusion calculations for WiFi-SISO and Bluetooth for antenna < 50mm from the user:

Antenna	Tx	Frequency (MHz)	Output Power		Separation distances (mm)					Calculated Threshold Value (≤ 3.0 SAR is not required)				
			dBm	mW	Right	Left	Top	Bottom	Front	Right	Left	Top	Bottom	Front
Aux	WiFi	2462	13.50	22	193	135	222	3	213	>50mm	>50mm	>50mm	7.0	>50mm
Aux	WiFi	5240	14.50	28	193	135	222	3	213	>50mm	>50mm	>50mm	12.9	>50mm
Aux	WiFi	5320	14.50	28	193	135	222	3	213	>50mm	>50mm	>50mm	13.0	>50mm
Aux	WiFi	5700	14.50	28	193	135	222	3	213	>50mm	>50mm	>50mm	13.5	>50mm
Aux	WiFi	5825	14.50	28	193	135	222	3	213	>50mm	>50mm	>50mm	13.6	>50mm
Aux	BT	2480	9.5	9	193	135	222	3	213	>50mm	>50mm	>50mm	2.8	>50mm

NB Mode SAR exclusion calculations for WiFi-SISO and Bluetooth for antenna > 50mm from the user:

Antenna	Tx	Frequency (MHz)	Output Power		Separation distances (mm)					Calculated Threshold Value (SAR test exclusion power,mW)				
			dBm	mW	Right	Left	Top	Bottom	Front	Right	Left	Top	Bottom	Front
Aux	WiFi	2462	13.50	22	193	135	222	3	213	1525.6	945.6	1815.6	<50mm	1725.6
Aux	WiFi	5240	14.50	28	193	135	222	3	213	1495.5	915.5	1785.5	<50mm	1695.5
Aux	WiFi	5320	14.50	28	193	135	222	3	213	1495.0	915.0	1785.0	<50mm	1695.0
Aux	WiFi	5700	14.50	28	193	135	222	3	213	1492.8	912.8	1782.8	<50mm	1692.8
Aux	WiFi	5825	14.50	28	193	135	222	3	213	1492.2	912.2	1782.2	<50mm	1692.2
Aux	BT	2480	9.5	9	193	135	222	3	213	1525.3	945.3	1815.3	<50mm	1725.3

PAD Mode SAR exclusion calculations for WiFi-SISO and Bluetooth for antenna < 50mm from the user :

Antenna	Tx	Frequency (MHz)	Output Power		Separation distances (mm)					Calculated Threshold Value (≤ 3.0 SAR is not required)				
			dBm	mW	Back	Right	Left	Top	Bottom	Back	Right	Left	Top	Bottom
Main	WiFi	2462	13.50	22	8	135	193	213	8	4.4	>50mm	>50mm	>50mm	4.4
Main	WiFi	5240	11.50	14	8	135	193	213	8	4.0	>50mm	>50mm	>50mm	4.0
Main	WiFi	5320	11.50	14	8	135	193	213	8	4.1	>50mm	>50mm	>50mm	4.1
Main	WiFi	5700	11.50	14	8	135	193	213	8	4.2	>50mm	>50mm	>50mm	4.2
Main	WiFi	5825	11.50	14	8	135	193	213	8	4.3	>50mm	>50mm	>50mm	4.3

PAD Mode SAR exclusion calculations for WiFi-SISO and Bluetooth for antenna > 50mm from the user :

Antenna	Tx	Frequency (MHz)	Output Power		Separation distances (mm)					Calculated Threshold Value (SAR test exclusion power,mW)				
			dBm	mW	Back	Right	Left	Top	Bottom	Back	Right	Left	Top	Bottom
Main	WiFi	2462	13.50	22	8	135	193	213	8	<50mm	945.6	1525.6	1725.6	<50mm
Main	WiFi	5240	11.50	14	8	135	193	213	8	<50mm	915.5	1495.5	1695.5	<50mm
Main	WiFi	5320	11.50	14	8	135	193	213	8	<50mm	915.0	1495.0	1695.0	<50mm
Main	WiFi	5700	11.50	14	8	135	193	213	8	<50mm	912.8	1492.8	1692.8	<50mm
Main	WiFi	5825	11.50	14	8	135	193	213	8	<50mm	912.2	1492.2	1692.2	<50mm

PAD Mode SAR exclusion calculations for WiFi-SISO and Bluetooth for antenna < 50mm from the user:

Antenna	Tx	Frequency (MHz)	Output Power		Separation distances (mm)					Calculated Threshold Value (≤ 3.0 SAR is not required)				
			dBm	mW	Back	Right	Left	Top	Bottom	Back	Right	Left	Top	Bottom
Aux	WiFi	2462	13.50	22	8	193	135	213	8	4.4	>50mm	>50mm	>50mm	4.4
Aux	WiFi	5240	11.50	14	8	193	135	213	8	4.0	>50mm	>50mm	>50mm	4.0
Aux	WiFi	5320	11.50	14	8	193	135	213	8	4.1	>50mm	>50mm	>50mm	4.1
Aux	WiFi	5700	11.50	14	8	193	135	213	8	4.2	>50mm	>50mm	>50mm	4.2
Aux	WiFi	5825	11.50	14	8	193	135	213	8	4.3	>50mm	>50mm	>50mm	4.3
Aux	BT	2480	9.50	9	8	193	135	213	8	1.8	>50mm	>50mm	>50mm	1.8

PAD Mode SAR exclusion calculations for WiFi-SISO and Bluetooth for antenna > 50mm from the user:

Antenna	Tx	Frequency (MHz)	Output Power		Separation distances (mm)					Calculated Threshold Value (SAR test exclusion power,mW)				
			dBm	mW	Back	Right	Left	Top	Bottom	Back	Right	Left	Top	Bottom
Aux	WiFi	2462	13.50	22	8	193	135	213	8	<50mm	1525.6	945.6	1725.6	<50mm
Aux	WiFi	5240	11.50	14	8	193	135	213	8	<50mm	1495.5	915.5	1695.5	<50mm
Aux	WiFi	5320	11.50	14	8	193	135	213	8	<50mm	1495.0	915.0	1695.0	<50mm
Aux	WiFi	5700	11.50	14	8	193	135	213	8	<50mm	1492.8	912.8	1692.8	<50mm
Aux	WiFi	5825	11.50	14	8	193	135	213	8	<50mm	1492.2	912.2	1692.2	<50mm
Aux	BT	2480	9.50	9	8	193	135	213	8	<50mm	1525.3	945.3	1725.3	<50mm

1.4 Test Environment

Ambient conditions in the laboratory:

Test Date: Feb. 21, 2019

Items	Required	Actual
Temperature (°C)	18-25	22.1± 2
Humidity (%RH)	30-70	49

Test Date: Feb. 22, 2019

Items	Required	Actual
Temperature (°C)	18-25	22.4± 2
Humidity (%RH)	30-70	50

The related certificate for our laboratories about the test site and management system can be downloaded

from DEKRA Testing and Certification Co., Ltd. Web Site:

<http://www.dekra.com.tw/english/about/certificates.aspx?bval=5>

The address and introduction of DEKRA Testing and Certification Co., Ltd. laboratories can be founded in our Web site: http://www.dekra.com.tw/index_en.aspx

Site Description: Accredited by TAF
Accredited Number: 3023

Site Name: DEKRA Testing and Certification Co., Ltd
Site Address: No.5-22, Ruishukeng, Linkou Dist., New Taipei City 24451,
Taiwan, R.O.C.
TEL : 886-2-8601-3788 / FAX : 886-2-8601-3789
E-Mail : info.tw@dekra.com

2. SAR Measurement System

2.1 DASY5 System Description

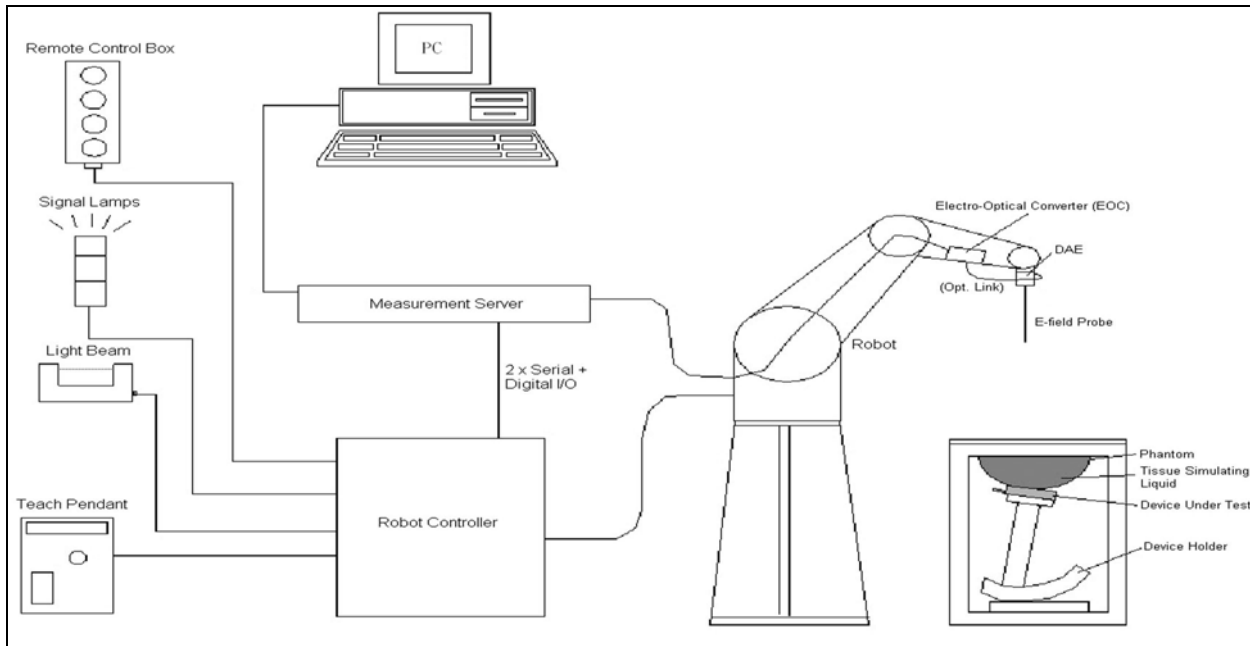

The DASY5 system for performing compliance tests consists of the following items:

- A standard high precision 6-axis robot with controller, teach pendant and software. An arm extension for accommodating the data acquisition electronics (DAE).
- A data acquisition electronics (DAE) which performs the signal amplification, signal multiplexing, AD-conversion, offset measurements, mechanical surface detection, collision detection, etc. The unit is battery powered with standard or rechargeable batteries. The signal is optically transmitted to the EOC.
- The Electro-optical converter (EOC) performs the conversion from optical to electrical signals for the digital communication to the DAE. To use optical surface detection, a special version of the EOC is required. The EOC signal is transmitted to the measurement server.
- The Light Beam used is for probe alignment. This improves the (absolute) accuracy of the probe positioning.
- A computer running WinXP and the DASY5 software.
- Remote control and teach pendant as well as additional circuitry for robot safety such as warning lamps, etc.
- The phantom, the device holder and other accessories according to the targeted measurement.

2.1.1 Applications

Predefined procedures and evaluations for automated compliance testing with all worldwide standards, e.g., IEEE 1528, OET 65, IEC 62209-1, IEC 62209-2, EN 50360, EN 50383 and others.

2.1.2 Area Scans

Area scans are defined prior to the measurement process being executed with a user defined variable spacing between each measurement point (integral) allowing low uncertainty measurements to be conducted. Scans defined for FCC applications utilize a 10mm² step integral, with 1mm interpolation used to locate the peak SAR area used for zoom scan assessments.

When an Area Scan has measured all reachable points, it computes the field maxima found in the scanned area, within a range of the global maximum. The range (in dB) is specified in the standards for compliance testing. For example, a 2 dB range is required in IEEE 1528-2013, EN 50361 and IEC 62209 standards, whereby 3 dB is a requirement when compliance is assessed in accordance with the ARIB standard (Japan).

2.1.3 Zoom Scan (Cube Scan Averaging)

Zoom Scans are used to assess the peak spatial SAR values within a cubic averaging volume containing 1 g and 10 g of simulated tissue. A density of 1000 kg/m³ is used to represent the head and body tissue density and not the phantom liquid density, in order to be consistent with the definition of the liquid dielectric properties, i.e. the side length of the 1 g cube is 10mm, with the side length of the 10 g cube 21,5mm.

The zoom scan integer steps can be user defined so as to reduce uncertainty, but normal practice for typical test applications (including FCC) utilize a physical step of 5x5x7 (8mmx8mmx5mm) providing a volume of 32mm in the X & Y axis, and 30mm in the Z axis.

2.1.4 Uncertainty of Inter-/Extrapolation and Averaging

In order to evaluate the uncertainty of the interpolation, extrapolation and averaged SAR calculation algorithms of the Postprocessor, DASYS5 allows the generation of measurement grids which are artificially predefined by analytically based test functions. Therefore, the grids of area scans and zoom scans can be filled with uncertainty test data, according to the SAR benchmark functions of IEEE 1528. The three analytical functions shown in equations as below are used to describe the possible range of the expected SAR distributions for the tested handsets. The field gradients are covered by the spatially flat

distribution f_1 , the spatially steep distribution f_3 and f_2 accounts for H-field cancellation on the phantom/tissue surface.

$$f_1(x, y, z) = Ae^{-\frac{z}{2a}} \cos^2 \left(\frac{\pi \sqrt{x'^2 + y'^2}}{2 \cdot 5a} \right)$$

$$f_2(x, y, z) = Ae^{-\frac{z}{a}} \frac{a^2}{a^2 + x'^2} \left(3 - e^{-\frac{2z}{a}} \right) \cos^2 \left(\frac{\pi y'}{2 \cdot 3a} \right)$$

$$f_3(x, y, z) = A \frac{a^2}{\frac{a^2}{4} + x'^2 + y'^2} \left(e^{-\frac{2z}{a}} + \frac{a^2}{2(a + 2z)^2} \right)$$

2.2 DASY5 E-Field Probe

The SAR measurement is conducted with the dosimetric probe manufactured by SPEAG. The probe is specially designed and calibrated for use in liquid with high permittivity. The dosimetric probe has special calibration in liquid at different frequency.

SPEAG conducts the probe calibration in compliance with international and national standards (e.g. IEEE 1528, EN 62209-1, IEC 62209, etc.) under ISO 17025. The calibration data are in Appendix D.

2.2.1 Isotropic E-Field Probe Specification

Model	Ex3DV4	
Construction	Symmetrical design with triangular core Built-in shielding against static charges PEEK enclosure material (resistant to organic solvents, e.g., DGBE)	
Frequency	10 MHz to 6 GHz Linearity: ± 0.2 dB (30 MHz to 6 GHz)	
Directivity	± 0.3 dB in HSL (rotation around probe axis) ± 0.5 dB in tissue material (rotation normal to probe axis)	
Dynamic Range	10 μ W/g to 100 mW/g Linearity: ± 0.2 dB (noise: typically < 1 μ W/g)	
Dimensions	Overall length: 330 mm (Tip: 20 mm) Tip diameter: 2.5 mm (Body: 12 mm) Typical distance from probe tip to dipole centers: 1 mm	
Application	High precision dosimetric measurements in any exposure scenario (e.g., very strong gradient fields). Only probe which enables compliance testing for frequencies up to 6 GHz with precision of better 30%.	

2.3 Boundary Detection Unit and Probe Mounting Device

The DASY probes use a precise connector and an additional holder for the probe, consisting of a plastic tube and a flexible silicon ring to center the probe. The connector at the DAE is flexibly mounted and held in the default position with magnets and springs. Two switching systems in the connector mount detect frontal and lateral probe collisions and trigger the necessary software response.



2.4 DATA Acquisition Electronics (DAE) and Measurement Server

The data acquisition electronics (DAE) consists of a highly sensitive electrometer-grade preamplifier with auto-zeroing, a channel and gain-switching multiplexer, a fast 16 bit AD-converter and a command decoder and control logic unit.

Transmission to the measurement server is accomplished through an optical downlink for data and status information as well as an optical uplink for commands and the clock.

The input impedance of the DAE4 is 200M Ohm; the inputs are symmetrical and floating. Common mode rejection is above 80dB.



The DASY5 measurement server is based on a PC/104 CPU board with a 400MHz intel ULV Celeron, 128MB chipdisk and 128MB RAM. The necessary circuits for communication with the DAE electronics box, as well as the 16 bit AD converter system for optical detection and digital I/O interface are contained on the DASY5 I/O board, which is directly connected to the PC/104 bus of the CPU board.



2.5 Robot

The DASY5 system uses the high precision robots TX90 XL type out of the newer series from Stäubli SA (France). For the 6-axis controller DASY5 system, the CS8C robot controller version from Stäubli is used.

The XL robot series have many features that are important for our application:

- High precision (repeatability 0.02 mm)
- High reliability (industrial design)
- Jerk-free straight movements
- Low ELF interference (the closed metallic construction shields against motor control fields)
- 6-axis controller



2.6 Light Beam Unit

The light beam switch allows automatic "tooling" of the probe. During the process, the actual position of the probe tip with respect to the robot arm is measured, as well as the probe length and the horizontal probe offset. The software then corrects all movements, such that the robot coordinates are valid for the probe tip.

The repeatability of this process is better than 0.1 mm. If a position has been taught with an aligned probe, the same position will be reached with another aligned probe within 0.1 mm, even if the other probe has different dimensions. During probe rotations, the probe tip will keep its actual position.



2.7 Device Holder

The DASY5 device holder is designed to cope with different positions given in the standard. It has two scales for the device rotation (with respect to the body axis) and the device inclination (with respect to the line between the ear reference points). The rotation center for both scales is the ear reference point (EPR).

Thus the device needs no repositioning when changing the angles.

The DASY5 device holder has been made out of low-loss POM material having the following dielectric parameters: relative permittivity $\epsilon_r = 3$ and loss tangent $\delta = 0.02$. The amount of dielectric material has been reduced in the closest vicinity of the device, since measurements have suggested that the influence of the clamp on the test results could thus be lowered.



2.8 SAM Twin Phantom

The SAM twin phantom is a fiberglass shell phantom with 2mm shell thickness (except the ear region where shell thickness increases to 6mm). It has three measurement areas:

- Left head
- Right head
- Flat phantom



The bottom plate contains three pair of bolts for locking the device holder. The device holder positions are adjusted to the standard measurement positions in the three sections. A white cover is provided to tap the phantom during off-periods to prevent water evaporation and changes in the liquid parameters. On the phantom top, three reference markers are provided to identify the phantom position with respect to the robot.

3. Tissue Simulating Liquid

3.1 The composition of the tissue simulating liquid

INGREDIENT (% Weight)	2450MHz Body	5200MHz Body	5800MHz Body
Water	73.2	76	75.68
Salt	0.04	0.00	0.00
Sugar	0.00	0.00	0.00
HEC	0.00	0.00	0.00
Preventol	0.00	0.00	0.00
DGBE	26.76	4.44	4.42
Triton X-100	0.00	19.56	19.47

3.2 Tissue Calibration Result

The dielectric parameters of the liquids were verified prior to the SAR evaluation using APREL Dielectric Probe Kit and Agilent E5071C Vector Network Analyzer.

Body Tissue Simulate Measurement				
Frequency [MHz]	Description	Dielectric Parameters		Tissue Temp. [°C]
		ϵ_r	σ [s/m]	
2450 MHz	Reference result ± 5% window	52.7 50.07 to 55.34	1.95 1.85 to 2.05	N/A
	21-Feb-19	51.76	1.96	21.4°C
2412 MHz	Low channel	51.91	1.88	21.4°C
2437 MHz	Mid channel	51.80	1.93	21.4°C
2480 MHz	High channel	51.64	2.01	21.4°C

Body Tissue Simulate Measurement				
Frequency [MHz]	Description	Dielectric Parameters		Tissue Temp. [°C]
		ϵ_r	σ [s/m]	
5200MHz	Reference result $\pm 5\%$ window	49 46.55 to 51.45	5.3 5.03 to 5.56	N/A
	22-Feb-19	49.99	5.32	20.2°C
5210 MHz	Channel 42	49.97	5.33	20.2°C
5230 MHz	Channel 46	49.91	5.35	20.2°C

Body Tissue Simulate Measurement				
Frequency [MHz]	Description	Dielectric Parameters		Tissue Temp. [°C]
		ϵ_r	σ [s/m]	
5300MHz	Reference result $\pm 5\%$ window	48.88 46.43 to 51.32	5.42 5.15 to 5.69	N/A
	22-Feb-19	49.72	5.46	20.2°C
5270 MHz	Low channel	49.80	5.42	20.2°C
5290 MHz	Mid channel	49.75	5.45	20.2°C
5310 MHz	High channel	49.69	5.48	20.2°C

Body Tissue Simulate Measurement				
Frequency [MHz]	Description	Dielectric Parameters		Tissue Temp. [°C]
		ϵ_r	σ [s/m]	
5600MHz	Reference result $\pm 5\%$ window	48.47 46.05 to 50.9	5.77 5.48 to 6.06	N/A
	22-Feb-19	48.90	5.94	20.2°C
5530 MHz	Low channel	49.10	5.82	20.2°C
5610 MHz	Mid channel	48.87	5.94	20.2°C
5690 MHz	High channel	48.66	6.05	20.2°C

Body Tissue Simulate Measurement				
Frequency [MHz]	Description	Dielectric Parameters		Tissue Temp. [°C]
		ϵ_r	σ [s/m]	
5800MHz	Reference result $\pm 5\%$ window	48.2 45.79 to 50.61	6 5.7 to 6.3	N/A
	22-Feb-19	48.37	6.24	20.2°C
5775 MHz	Channel 155	48.44	6.21	20.2°C

3.3 Tissue Dielectric Parameters for Head and Body Phantoms

The head tissue dielectric parameters recommended by the IEEE SCC-34/SC-2 in P1528 have been incorporated in the following table. These head parameters are derived from planar layer models simulating the highest expected SAR for the dielectric properties and tissue thickness variations in a human head. Other head and body tissue parameters that have not been specified in P1528 are derived from the tissue dielectric parameters computed from the 4-Cole-Cole equations described in Reference [12] and extrapolated according to the head parameters specified in P1528.

Target Frequency (MHz)	Head		Body	
	ϵ_r	σ (S/m)	ϵ_r	σ (S/m)
150	52.3	0.76	61.9	0.80
300	45.3	0.87	58.2	0.92
450	43.5	0.87	56.7	0.94
835	41.5	0.90	55.2	0.97
900	41.5	0.97	55.0	1.05
915	41.5	0.98	55.0	1.06
1450	40.5	1.20	54.0	1.30
1610	40.3	1.29	53.8	1.40
1800 – 2000	40.0	1.40	53.3	1.52
2450	39.2	1.80	52.7	1.95
3000	38.5	2.40	52.0	2.73
5800	35.3	5.27	48.2	6.00

(ϵ_r = relative permittivity, σ = conductivity and $\rho = 1000 \text{ kg/m}^3$)

4. SAR Measurement Procedure

4.1 SAR System Check

4.1.1 Dipoles

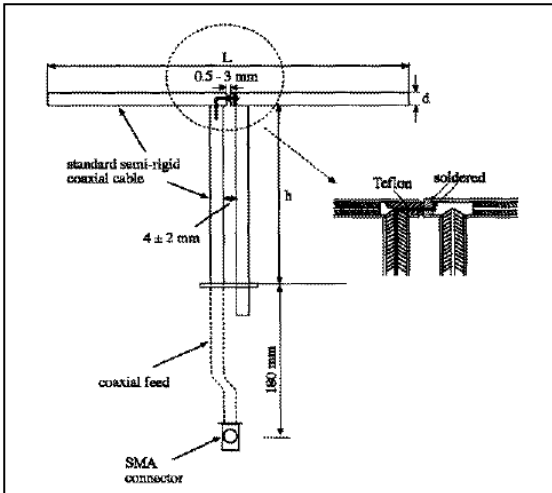

The dipoles used is based on the IEEE-1528 standard, and is complied with mechanical and electrical specifications in line with the requirements of both IEEE and FCC Supplement C. the table below provides details for the mechanical and electrical specifications for the dipoles.

Frequency	L (mm)	h (mm)	d (mm)
2450MHz	51.5	30.4	3.6
5200M~5800MHz	20.6	40.3	3.6

4.1.2 System Check Result

System Performance Check at 2450MHz				
Dipole Kit: D2450V2				
Frequency [MHz]	Description	SAR [w/kg] 1g	SAR [w/kg] 10g	Tissue Temp. [°C]
2450 MHz	Reference result ± 10% window	50.6 45.54 to 55.66	23.9 21.51 to 26.29	N/A
	21-Feb-19	51.6	24.32	21.4°C

Note: (1) The power level is used 250mW
 (2) All SAR values are normalized to 1W forward power.
 (3) The reference result is from Appendix E.

System Performance Check at 5200MHz				
Dipole Kit: D5GHzV2				
Frequency [MHz]	Description	SAR [w/kg] 1g	SAR [w/kg] 10g	Tissue Temp. [°C]
5200 MHz	Reference result ± 10% window	74.7 67.23 to 82.17	21.0 18.90 to 23.10	N/A
	22-Feb-19	73.9	21.8	20.2°C
Note: (1) The power level is used 100mW (2) All SAR values are normalized to 1W forward power. (3) The reference result is from Appendix E.				

System Performance Check at 5300MHz				
Dipole Kit: D5GHzV2				
Frequency [MHz]	Description	SAR [w/kg] 1g	SAR [w/kg] 10g	Tissue Temp. [°C]
5300 MHz	Reference result ± 10% window	77.7 69.93 to 85.47	21.9 19.71 to 24.09	N/A
	22-Feb-19	82.9	22.4	20.2°C
Note: (1) The power level is used 100mW (2) All SAR values are normalized to 1W forward power. (3) The reference result is from Appendix E.				

System Performance Check at 5600MHz				
Dipole Kit: D5GHzV2				
Frequency [MHz]	Description	SAR [w/kg] 1g	SAR [w/kg] 10g	Tissue Temp. [°C]
5600 MHz	Reference result ± 10% window	80.9 72.81 to 88.99	22.6 20.34 to 24.86	N/A
	22-Feb-19	85.9	22.2	20.2°C
Note: (1) The power level is used 100mW (2) All SAR values are normalized to 1W forward power. (3) The reference result is from Appendix E.				

System Performance Check at 5800MHz				
Dipole Kit: D5GHzV2				
Frequency [MHz]	Description	SAR [w/kg] 1g	SAR [w/kg] 10g	Tissue Temp. [°C]
5800 MHz	Reference result ± 10% window	78.3 70.47 to 86.13	21.7 19.53 to 23.87	N/A
	22-Feb-19	78.9	21.8	20.2°C
Note: (1) The power level is used 100mW (2) All SAR values are normalized to 1W forward power. (3) The reference result is from Appendix E.				

4.2 SAR Measurement Procedure

The Dasy5 calculates SAR using the following equation,

$$SAR = \frac{\sigma |E|^2}{\rho}$$

σ : represents the simulated tissue conductivity

ρ : represents the tissue density

The EUT is set to transmit at the required power in line with product specification, at each frequency relating to the LOW, MID, and HIGH channel settings.

Pre-scans are made on the device to establish the location for the transmitting antenna, using a large area scan in either air or tissue simulation fluid.

The EUT is placed against the Universal Phantom where the maximum area scan dimensions are larger than the physical size of the resonating antenna. When the scan size is not large enough to cover the peak SAR distribution, it is modified by either extending the area scan size in both the X and Y directions, or the device is shifted within the predefined area.

The area scan is then run to establish the peak SAR location (interpolated resolution set at 1mm²) which is then used to orient the center of the zoom scan. The zoom scan is then executed and the 1g and 10g averages are derived from the zoom scan volume (interpolated resolution set at 1mm³).

5. SAR Exposure Limits

SAR assessments have been made in line with the requirements of IEEE-1528, FCC Supplement C, and comply with ANSI/IEEE C95.1-1992 “Uncontrolled Environments” limits. These limits apply to a location which is deemed as “Uncontrolled Environment” which can be described as a situation where the general public may be exposed to an RF source with no prior knowledge or control over their exposure.

Limits for General Population/Uncontrolled Exposure (W/kg)

Type Exposure	Uncontrolled Environment Limit
Spatial Peak SAR (1g cube tissue for brain or body)	1.60 W/kg
Spatial Average SAR (whole body)	0.08 W/kg
Spatial Peak SAR (10g for hands, feet, ankles and wrist)	4.00 W/kg

6. Test Equipment List

Instrument	Manufacturer	Model No.	Serial No.	Last Calibration	Next Calibration
Stäubli Robot TX60L	Stäubli	TX60L	F09/5BL1A1/A06	2009/05/18	only once
Controller	Speag	CS8c	N/A	2009/05/18	only once
Reference Dipole 2450MHz	Speag	D2450V2	930	2016/11/15	2019/11/14
Reference Dipole 5GHz	Speag	D5GHzV2	1041	2017/05/26	2020/05/25
SAM Twin Phantom	Speag	QD000 P40 CA	Tp 1515	N/A	N/A
Device Holder	Speag	N/A	N/A	N/A	N/A
Data Acquisition Electronic	Speag	DAE4	1425	2018/11/16	2019/11/15
E-Field Probe	Speag	EX3DV4	3979	2018/11/22	2019/11/21
SAR Software	Speag	DASY52	V52.10.0.1446	N/A	N/A
Apral Dipole Spaccer	Apral	ALS-DS-U	QTK-295	N/A	N/A
Power Amplifier	Mini-Circuit	ZHL-42	D051404-20	N/A	N/A
Directional Coupler	Agilent	87300C	MY44300353	N/A	N/A ¹
Attenuator	Woken	WATT-218FS-10	N/A	N/A	N/A ¹
Attenuator	Mini-Circuit	BW-S20W2+	N/A	N/A	N/A ¹
Vector Network	Agilent	E5071C	MY46106342	2018/09/05	2019/09/04
Signal Generator	Anritsu	MG3694A	041902	2018/08/27	2019/08/26
Power Meter	Anritsu	ML2487A	6K00001447	2018/10/23	2019/10/22
Wide Bandwidth Sensor	Anritsu	MA2411B	1339194	2018/10/23	2019/10/22

Note: 1. System Check, the path loss measured by the network analyzer, includes the signal generator, amplifier, cable, attenuator and directional coupler.

Note:

Per KDB 865664 D01 requirements for dipole calibration, the following are recommended FCC procedures for SAR dipole calibration.

1. After a dipole is damaged and properly repaired to meet required specifications
2. When the measured SAR deviates from the calibrated SAR value by more than 10% due to changes in physical, mechanical, electrical or other relevant dipole conditions;
3. When the most recent return-loss, measured at least annually, deviates by more than 20% from the previous measurement (i.e. 0.2 of the dB value) or not meeting the required -20 dB return-loss specification

	Frequency	Tissue	Return loss	Limit	Verified Date
Calibration	2450	Body	-27.98dB	Within 20%	2016.11.15
Measurement	2450	Body	-28.02dB		2017.11.16
Measurement	2450	Body	-27.79dB		2018.11.13

	Frequency	Tissue	Return loss	Limit	Verified Date
Calibration	5200	Body	-24.00dB	Within 20%	2017.05.26
Measurement	5200	Body	-23.68dB		2018.05.25

	Frequency	Tissue	Return loss	Limit	Verified Date
Calibration	5300	Body	-31.47dB	Within 20%	2017.05.26
Measurement	5300	Body	-28.08dB		2018.05.25

	Frequency	Tissue	Return loss	Limit	Verified Date
Calibration	5600	Body	-24.25dB	Within 20%	2017.05.26
Measurement	5600	Body	-26.47dB		2018.05.25

	Frequency	Tissue	Return loss	Limit	Verified Date
Calibration	5800	Body	-24.72dB	Within 20%	2017.05.26
Measurement	5800	Body	-23.63dB		2018.05.25

4. When the most recent measurement of the real or imaginary parts of the impedance, measured at least annually, deviates by more than 5Ω from the previous measurement

	Frequency	Tissue	Impedance	Limit	Verified Date
Calibration	2450	Body	50.03	Within 5Ω	2016.11.15
Measurement	2450	Body	50.22		2017.11.16
Measurement	2450	Body	50.56		2018.11.13

	Frequency	Tissue	Impedance	Limit	Verified Date
Calibration	5200	Body	49.02	Within 5Ω	2017.05.26
Measurement	5200	Body	49.79		2018.05.25

	Frequency	Tissue	Impedance	Limit	Verified Date
Calibration	5300	Body	48.43	Within 5Ω	2017.05.26
Measurement	5300	Body	51.83		2018.05.25

	Frequency	Tissue	Impedance	Limit	Verified Date
Calibration	5600	Body	56.52	Within 5Ω	2017.05.26
Measurement	5600	Body	52.87		2018.05.25

	Frequency	Tissue	Impedance	Limit	Verified Date
Calibration	5800	Body	56.16	Within 5Ω	2017.05.26
Measurement	5800	Body	56.49		2018.05.25

7. Measurement Uncertainty

DASY5 Uncertainty (According to IEEE 1528-2013)								
Measurement uncertainty for 30 MHz to 3 GHz								
Error Description	Uncert. value	Prob. Dist.	Div.	(ci) 1g	(ci) 10g	Std. Unc. (1g)	Std. Unc. (10g)	(vi) V _{eff}
Measurement System								
Probe Calibration	±6%	N	1	1	1	±6.0%	±6.0%	∞
Axial Isotropy	±4.7%	R	$\sqrt{3}$	0.7	0.7	±1.9%	±1.9%	∞
Hemispherical Isotropy	±9.6%	R	$\sqrt{3}$	0.7	0.7	±3.9%	±3.9%	∞
Boundary Effects	±1.0%	R	$\sqrt{3}$	1	1	±0.6%	±0.6%	∞
Linearity	±4.7%	R	$\sqrt{3}$	1	1	±2.7%	±2.7%	∞
System Detection Limits	±1.0%	R	$\sqrt{3}$	1	1	±0.6%	±0.6%	∞
Modulation Response	±2.4%	R	$\sqrt{3}$	1	1	±1.4%	±1.4%	∞
Readout Electronics	±0.3%	N	1	1	1	±0.3%	±0.3%	∞
Response Time	±0.8%	R	$\sqrt{3}$	1	1	±0.5%	±0.5%	∞
Integration Time	±2.6%	R	$\sqrt{3}$	1	1	±1.5%	±1.5%	∞
RF Ambient Noise	±3.0%	R	$\sqrt{3}$	1	1	±1.7%	±1.7%	∞
RF Ambient Reflections	±3.0%	R	$\sqrt{3}$	1	1	±1.7%	±1.7%	∞
Probe Positioner	±0.4%	R	$\sqrt{3}$	1	1	±0.2%	±0.2%	∞
Probe Positioning	±2.9%	R	$\sqrt{3}$	1	1	±1.7%	±1.7%	∞
Max. SAR Eval.	±4.0%	R	$\sqrt{3}$	1	1	±1.2%	±1.2%	∞
Test Sample Related								
Device Positioning	±2.9%	N	1	1	1	±2.9%	±2.9%	145
Device Holder	±3.6%	N	1	1	1	±3.6%	±3.6%	5
Power Drift	±5.0%	R	$\sqrt{3}$	1	1	±2.9%	±2.9%	∞
Power Scaling	±0%	R	$\sqrt{3}$	1	1	±0.0%	±0.0%	
Phantom and Setup								
Phantom Uncertainty	±6.1%	R	$\sqrt{3}$	1	1	±3.5%	±3.5%	∞
SAR correction	±1.9%	R	$\sqrt{3}$	1	0.84	±1.1%	±0.9%	∞
Liquid Conductivity (meas.)	±2.5%	R	$\sqrt{3}$	0.78	0.71	±1.1%	±1.0%	∞
Liquid Permittivity (meas.)	±2.5%	R	$\sqrt{3}$	0.26	0.26	±0.3%	±0.4%	∞
Temp. unc. - Conductivity	±3.4%	R	$\sqrt{3}$	0.78	0.71	±1.5%	±1.4%	∞
Temp. unc. - Permittivity	±0.4%	R	$\sqrt{3}$	0.23	0.26	±0.1%	±0.1%	∞
Combined Std. Uncertainty						±11.2%	±11.1%	361
Expanded STD Uncertainty						±22.3%	±22.2%	

DASY5 Uncertainty (According to IEEE 1528-2013) Measurement uncertainty for 3GHz to 6 GHz								
Error Description	Uncert. value	Prob. Dist.	Div.	(ci) 1g	(ci) 10g	Std. Unc. (1g)	Std. Unc. (10g)	(vi) V _{eff}
Measurement System								
Probe Calibration	±6.55%	N	1	1	1	±6.55%	±6.55%	∞
Axial Isotropy	±4.7%	R	$\sqrt{3}$	0.7	0.7	±1.9%	±1.9%	∞
Hemispherical Isotropy	±9.6%	R	$\sqrt{3}$	0.7	0.7	±3.9%	±3.9%	∞
Boundary Effects	±2.0%	R	$\sqrt{3}$	1	1	±1.2%	±1.2%	∞
Linearity	±4.7%	R	$\sqrt{3}$	1	1	±2.7%	±2.7%	∞
System Detection Limits	±1.0%	R	$\sqrt{3}$	1	1	±0.6%	±0.6%	∞
Modulation Response	±2.4%	R	$\sqrt{3}$	1	1	±1.4%	±1.4%	∞
Readout Electronics	±0.3%	N	1	1	1	±0.3%	±0.3%	∞
Response Time	±0.8%	R	$\sqrt{3}$	1	1	±0.5%	±0.5%	∞
Integration Time	±2.6%	R	$\sqrt{3}$	1	1	±1.5%	±1.5%	∞
RF Ambient Noise	±3.0%	R	$\sqrt{3}$	1	1	±1.7%	±1.7%	∞
RF Ambient Reflections	±3.0%	R	$\sqrt{3}$	1	1	±1.7%	±1.7%	∞
Probe Positioner	±0.8%	R	$\sqrt{3}$	1	1	±0.5%	±0.5%	∞
Probe Positioning	±6.7%	R	$\sqrt{3}$	1	1	±3.9%	±3.9%	∞
Post-processing	±4.0%	R	$\sqrt{3}$	1	1	±2.3%	±2.3%	∞
Test Sample Related								
Device Positioning	±2.9%	N	1	1	1	±2.9%	±2.9%	145
Device Holder	±3.6%	N	1	1	1	±3.6%	±3.6%	5
Power Drift	±5.0%	R	$\sqrt{3}$	1	1	±2.9%	±2.9%	∞
Power Scaling	±0%	R	$\sqrt{3}$	1	1	±0.0%	±0.0%	
Phantom and Setup								
Phantom Uncertainty	±6.6%	R	$\sqrt{3}$	1	1	±3.8%	±3.8%	∞
SAR correction	±1.9%	R	$\sqrt{3}$	1	1	±1.1%	±0.9%	∞
Liquid Conductivity (meas.)	±2.5%	R	$\sqrt{3}$	1	0.84	±1.1%	±1.0%	∞
Liquid Permittivity (meas.)	±2.5%	R	$\sqrt{3}$	0.26	0.26	±0.3%	±0.4%	∞
Temp. unc. - Conductivity	±3.4%	R	$\sqrt{3}$	0.78	0.71	±1.5%	±1.4%	∞
Temp. unc. - Permittivity	±0.4%	R	$\sqrt{3}$	0.23	0.26	±0.1%	±0.1%	∞
Combined Std. Uncertainty						±12.3%	±12.2%	748
Expanded STD Uncertainty						±24.6%	±24.5%	

8. Conducted Power Measurement (Including tolerance allowed for production unit)

WLAN 2.4G 2TX SISO For NB and PAD

DSSS/OFDM mode specified maximum output power at an antenna port	Standard	Mode	BW	SISO-Main(TX1) CHAIN B				SISO-Aux(TX2) CHAIN A			
				CH	PK Power	AV Target	AV Power	CH	PK Power	AV Target	AV Power
				15.247 (2.4GHz)	b	20	1	15.27	13.5	13.45	1
			6	15.12	13.5	13.35	6	15.26	13.5	13.45	
			11	15.39	13.5	13.46	11	15.15	13.5	13.41	
			12	15.21	13.5	13.49	12	15.21	13.5	13.46	
			13	15.11	13.5	13.37	13	15.21	13.5	13.46	
		g	20	1	18.51	13.5	13.47	1	18.50	13.5	13.50
				6	18.54	13.5	13.47	6	18.31	13.5	13.46
				11	18.52	13.5	13.49	11	18.21	13.5	13.45
				12	18.51	13.5	13.46	12	18.13	13.5	13.44
				13	2.87	-5.5	-5.58	13	1.14	-6	-6.17
		n(HT)	20	1	18.62	13.5	13.48	1	18.46	13.5	13.41
				6	18.47	13.5	13.46	6	18.26	13.5	13.44
				11	18.53	13.5	13.44	11	18.57	13.5	13.41
				12	18.42	13.5	13.48	12	18.23	13	12.90
				13	2.77	-5.5	-5.57	13	1.27	-6.5	-6.51
			40	3	18.63	13.5	13.47	3	18.50	13.5	13.43
				6	18.62	13.5	13.41	6	19.14	13.5	13.49
				9	18.71	13.5	13.47	9	20.16	13.5	13.49
				10	17.13	10	9.99	10	16.81	9.5	9.48
				11	11.06	3.5	3.49	11	13.13	5	4.97

WLAN 5G 2TX SISO For NB																					
OFDM mode specified maximum output power at an antenna port	Standard	Mode	BW	SISO-Main(TX1)			SISO-Aux(TX2)			Standard	Mode	BW	SISO-Main(TX1)			SISO-Aux(TX2)					
				CHAIN B			CHAIN A						CHAIN B			CHAIN A					
				CH	AV	AV	CH	AV	AV				CH	AV	AV	CH	AV	AV	CH	AV	AV
					Target	Power		Target	Power					Target	Power		Target	Power		Target	Power
U-NII-1 (5150~5250MHz)	a	20	36	14.5	14.49	36	14.5	14.49	U-NII-2A (5250~5350MHz)	a	20	52	14.5	14.46	52	14.5	14.47				
			40	14.5	14.44	40	14.5	14.49				56	14.5	14.49	56	14.5	14.44				
			44	14.5	14.47	44	14.5	14.45				60	14.5	14.46	60	14.5	14.49				
			48	14.5	14.41	48	14.5	14.49				64	14.5	14.49	64	14.5	14.49				
			36	14.5	14.43	36	14.5	14.49				52	14.5	14.41	52	14.5	14.49				
	n(HT)	20	40	14.5	14.49	40	14.5	14.40		56	14.5	14.45	56	14.5	14.40						
			44	14.5	14.41	44	14.5	14.42		60	14.5	14.44	60	14.5	14.49						
			48	14.5	14.48	48	14.5	14.45		64	14.5	14.45	64	14.5	14.48						
			38	14.5	14.45	38	14.5	14.40		54	14.5	14.48	54	14.5	14.49						
		40	46	14.5	14.41	46	14.5	14.41		62	14.5	14.47	62	14.5	14.00						
	ac	80	42	14.5	14.42	42	14.5	14.38		ac	80	58	14.5	14.43	58	14.5	14.42				
	U-NII-1 + U-NII-2A										ac	160	50	14.5	14.46	50	14.5	14.48			
	U-NII-2C (5470~5650MHz)	a	20	100	14.5	14.49	100	14.5		14.45	5.65 GHz & U-NII-3 (5725~5850MHz)	a	20	132	14.5	14.48	132	14.5	14.42		
				112	14.5	14.44	112	14.5		14.46				149	14.5	14.47	149	14.5	14.48		
				116	14.5	14.41	116	14.5		14.49				165	14.5	14.49	165	14.5	14.49		
128				14.5	14.44	128	14.5	14.49	132	14.5				14.42	132	14.5	14.41				
100				14.5	14.46	100	14.5	14.42	149	14.5				14.47	149	14.5	14.49				
n(HT)		20	112	14.5	14.49	112	14.5	14.44	165	14.5		14.45	165	14.5	14.43						
			116	14.5	14.49	116	14.5	14.42	134	14.5		14.47	134	14.5	14.42						
			128	14.5	14.49	128	14.5	14.46	151	14.5		14.49	151	14.5	14.41						
			102	14.5	14.45	102	14.5	14.49	159	14.5		14.42	159	14.5	14.40						
		40	110	14.5	14.49	110	14.5	14.49	20	144		14.5	14.42	144	14.5	14.42					
ac		80	118	14.5	14.47	118	14.5	14.47	40	142		14.5	14.42	142	14.5	14.41					
			126	14.5	14.45	126	14.5	14.49	138	14.5		14.44	138	14.5	14.36						
			106	14.5	14.49	106	14.5	14.43	80	155		14.5	14.46	155	14.5	14.41					
		122	14.5	14.45	122	14.5	14.49														
		160	114	12.5	12.48	114	12.5	12.43													

WLAN 5G 2TX MIMO U-NII-1 & U-NII-2A For NB												
Standard	Mode	BW	MIMO-Main(TX1)			MIMO-Aux(TX2)			MIMO Main+Aux			
			CH	AV Target	AV Power	CH	AV Target	AV Power	CH	AV Target	AV Power	
U-NII-1 (5150~5250MHz)	a	20	36	N/A	N/A	36	N/A	N/A	36	N/A	N/A	
			40	N/A	N/A	40	N/A	N/A	40	N/A	N/A	
			44	N/A	N/A	44	N/A	N/A	44	N/A	N/A	
			48	N/A	N/A	48	N/A	N/A	48	N/A	N/A	
	n(HT)	20	36	14.5	14.48	36	14.5	14.45	36	17.5	17.48	
			40	14.5	14.44	40	14.5	14.42	40	17.5	17.44	
			44	14.5	14.49	44	14.5	14.49	44	17.5	17.50	
			48	14.5	14.40	48	14.5	14.47	48	17.5	17.45	
		40	38	14.5	14.49	38	14.5	14.13	38	17.5	17.32	
			46	14.5	14.41	46	14.5	14.48	46	17.5	17.46	
	ac	80	42	10	10.00	42	10	9.42	42	13	12.72	
	U-NII-2A (5250~5350MHz)	a	20	52	N/A	N/A	52	N/A	N/A	52	N/A	N/A
				56	N/A	N/A	56	N/A	N/A	56	N/A	N/A
				60	N/A	N/A	60	N/A	N/A	60	N/A	N/A
64				N/A	N/A	64	N/A	N/A	64	N/A	N/A	
n(HT)		20	52	14.5	14.45	52	14.5	14.45	52	17.5	17.46	
			56	14.5	14.45	56	14.5	14.46	56	17.5	17.47	
			60	14.5	14.42	60	14.5	14.42	60	17.5	17.43	
			64	14.5	14.49	64	14.5	14.45	64	17.5	17.48	
		40	54	14.5	14.48	54	14.5	14.46	54	17.5	17.48	
			62	14.5	14.48	62	14.5	14.11	62	17.5	17.31	
ac		80	58	12.5	12.09	58	12.5	11.94	58	15.5	15.03	
ac		160	50	13.5	13.48	50	13.5	13.40	50	16.5	16.45	

WLAN 5G 2TX MIMO U-NII-2C & U-NII-3 For NB													
OFDM mode specified maximum output power at an antenna port	Standard	Mode	BW	MIMO-Main(TX1)			MIMO-Aux(TX2)			MIMO Main+Aux			
				CHAIN B			CHAIN A						
				CH	AV Target	AV Power	CH	AV Target	AV Power	CH	AV Target	AV Power	
	U-NII-2C (5470~5650MHz)	a	20	100	N/A	N/A	100	N/A	N/A	100	N/A	N/A	
				112	N/A	N/A	112	N/A	N/A	112	N/A	N/A	
				116	N/A	N/A	116	N/A	N/A	116	N/A	N/A	
				128	N/A	N/A	128	N/A	N/A	128	N/A	N/A	
		n(HT)	20	100	14.5	14.49	100	14.5	14.40	100	17.5	17.46	
				112	14.5	14.44	112	14.5	14.49	112	17.5	17.48	
				116	14.5	14.43	116	14.5	14.41	116	17.5	17.43	
				128	14.5	14.49	128	14.5	14.47	128	17.5	17.49	
			40	102	13.5	13.49	102	13.5	13.44	102	16.5	16.48	
				110	14.5	14.48	110	14.5	14.40	110	17.5	17.45	
				118	14.5	14.49	118	14.5	14.49	118	17.5	17.50	
				126	14.5	14.46	126	14.5	14.49	126	17.5	17.49	
		ac	80	106	12	11.93	106	12	10.92	106	15	14.44	
				122	14.5	14.48	122	14.5	14.45	122	17.5	17.48	
			160	114	12.5	12.44	114	12.5	12.23	114	15.5	15.35	
		5.65 GHz & U-NII-3 (5725~5850MHz)	a	20	132	N/A	N/A	132	N/A	N/A	132	N/A	N/A
					149	N/A	N/A	149	N/A	N/A	149	N/A	N/A
					165	N/A	N/A	165	N/A	N/A	165	N/A	N/A
			n(HT)	20	132	14.5	14.47	132	14.5	14.48	132	17.5	17.49
					149	14.5	14.42	149	14.5	14.49	149	17.5	17.47
					165	14.5	14.49	165	14.5	14.45	165	17.5	17.48
				40	134	14.5	14.41	134	14.5	14.43	134	17.5	17.43
					151	14.5	14.46	151	14.5	14.49	151	17.5	17.49
					159	14.5	14.49	159	14.5	14.49	159	17.5	17.50
ac	20		144	14.5	14.42	144	14.5	14.42	144	17.5	17.43		
	40		142	14.5	14.42	142	14.5	14.41	142	17.5	17.43		
	80		138	14.5	14.49	138	14.5	14.42	138	17.5	17.47		
			155	14.5	14.48	155	14.5	13.37	155	17.5	16.94		

WLAN 5G 2TX SISO For PAD																		
	Standard	Mode	BW	SISO-Main(TX1)			SISO-Aux(TX2)			Standard	Mode	BW	SISO-Main(TX1)			SISO-Aux(TX2)		
				CHAIN B			CHAIN A						CHAIN B			CHAIN A		
				CH	AV Target	AV Power	CH	AV Target	AV Power				CH	AV Target	AV Power	CH	AV Target	AV Power
OFDM mode specified maximum output power at an antenna port	U-NII-1 (5150~5250MHz)	a	20	36	11.5	11.47	36	11.5	11.43	U-NII-2A (5250~5350MHz)	a	20	52	11.5	11.48	52	11.5	11.46
				40	11.5	11.45	40	11.5	11.49				56	11.5	11.46	56	11.5	11.46
				44	11.5	11.40	44	11.5	11.43				60	11.5	11.47	60	11.5	11.48
				48	11.5	11.41	48	11.5	11.48				64	11.5	11.49	64	11.5	11.49
		n(HT)	20	36	11.5	11.49	36	11.5	11.49		n(HT)	20	52	11.5	11.48	52	11.5	11.49
				40	11.5	11.42	40	11.5	11.45				56	11.5	11.47	56	11.5	11.42
				44	11.5	11.49	44	11.5	11.43				60	11.5	11.46	60	11.5	11.49
				48	11.5	11.47	48	11.5	11.40				64	11.5	11.40	64	11.5	11.44
		40	38	11.5	11.46	38	11.5	11.41	54		11.5	11.41	54	11.5	11.49			
			46	11.5	11.45	46	11.5	11.44	62		11.5	11.46	62	11.5	11.40			
		ac	80	42	11.5	11.42	42	11.5	11.48		ac	80	58	11.5	11.45	58	11.5	11.46
		U-NII-1 + U-NII-2A										ac	160	50	11.5	11.46	50	11.5
	U-NII-2C (5470~5650MHz)	a	20	100	11.5	11.45	100	11.5	11.47	5.65 GHz & U-NII-3 (5725~5850MHz)	a	20	132	11.5	11.48	132	11.5	11.48
				112	11.5	11.45	112	11.5	11.48				149	11.5	11.47	149	11.5	11.40
				116	11.5	11.44	116	11.5	11.48				165	11.5	11.48	165	11.5	11.48
				128	11.5	11.43	128	11.5	11.47				132	11.5	11.49	132	11.5	11.44
		n(HT)	20	100	11.5	11.47	100	11.5	11.49		n(HT)	20	149	11.5	11.40	149	11.5	11.47
				112	11.5	11.48	112	11.5	11.44				165	11.5	11.42	165	11.5	11.40
116				11.5	11.49	116	11.5	11.45	134				11.5	11.40	134	11.5	11.49	
128				11.5	11.47	128	11.5	11.49	151				11.5	11.44	151	11.5	11.47	
40		102	11.5	11.46	102	11.5	11.47	159	11.5		11.47	159	11.5	11.49				
		110	11.5	11.49	110	11.5	11.43	ac	20		144	11.5	11.49	144	11.5	11.44		
		118	11.5	11.48	118	11.5	11.49	40	142		11.5	11.49	142	11.5	11.43			
ac		80	126	11.5	11.43	126	11.5	11.44	80		138	11.5	11.48	138	11.5	11.46		
			106	11.5	11.49	106	11.5	11.49	155	11.5	11.47	155	11.5	11.47				
			122	11.5	11.47	122	11.5	11.45										
160		114	11.5	11.41	114	11.5	11.38											

WLAN 5G 2TX MIMO U-NII-1 & U-NII-2A For PAD												
OFDM mode specified maximum output power at an antenna port	Standard	Mode	BW	MIMO-Main(TX1) CHAIN B			MIMO-Aux(TX2) CHAIN A			MIMO Main+Aux		
				CH	AV Target	AV Power	CH	AV Target	AV Power	CH	AV Target	AV Power
	U-NII-1 (5150~5250MHz)	a	20	36	N/A	N/A	36	N/A	N/A	36	N/A	N/A
40				N/A	N/A	40	N/A	N/A	40	N/A	N/A	
44				N/A	N/A	44	N/A	N/A	44	N/A	N/A	
48				N/A	N/A	48	N/A	N/A	48	N/A	N/A	
n(HT)		20	36	11.5	11.43	36	11.5	11.43	36	14.5	14.44	
			40	11.5	11.49	40	11.5	11.49	40	14.5	14.50	
			44	11.5	11.45	44	11.5	11.43	44	14.5	14.45	
			48	11.5	11.45	48	11.5	11.49	48	14.5	14.48	
		40	38	11.5	11.47	38	11.5	11.47	38	14.5	14.48	
			46	11.5	11.41	46	11.5	11.48	46	14.5	14.46	
ac		80	42	10	9.97	42	10	9.47	42	13	12.73	
U-NII-2A (5250~5350MHz)		a	20	52	N/A	N/A	52	N/A	N/A	52	N/A	N/A
				56	N/A	N/A	56	N/A	N/A	56	N/A	N/A
				60	N/A	N/A	60	N/A	N/A	60	N/A	N/A
				64	N/A	N/A	64	N/A	N/A	64	N/A	N/A
		n(HT)	20	52	11.5	11.49	52	11.5	11.44	52	14.5	14.48
				56	11.5	11.48	56	11.5	11.42	56	14.5	14.46
	60			11.5	11.47	60	11.5	11.48	60	14.5	14.49	
	64			11.5	11.47	64	11.5	11.47	64	14.5	14.48	
	40		54	11.5	11.44	54	11.5	11.47	54	14.5	14.47	
			62	11.5	11.45	62	11.5	11.49	62	14.5	14.48	
	ac	80	58	11.5	11.45	58	11.5	11.46	58	14.5	14.47	
	ac	160	50	11.5	11.42	50	11.5	11.49	50	14.5	14.47	

WLAN 5G 2TX MIMO U-NII-2C & U-NII-3 For PAD												
	Standard	Mode	BW	MIMO-Main(TX1)			MIMO-Aux(TX2)			MIMO Main+Aux		
				CH	AV Target	AV Power	CH	AV Target	AV Power	CH	AV Target	AV Power
OFDM mode specified maximum output power at an antenna port	U-NII-2C (5470~5650MHz)	a	20	100	N/A	N/A	100	N/A	N/A	100	N/A	N/A
				112	N/A	N/A	112	N/A	N/A	112	N/A	N/A
				116	N/A	N/A	116	N/A	N/A	116	N/A	N/A
				128	N/A	N/A	128	N/A	N/A	128	N/A	N/A
		n(HT)	20	100	11.5	11.44	100	11.5	11.48	100	14.5	14.47
				112	11.5	11.46	112	11.5	11.48	112	14.5	14.48
				116	11.5	11.49	116	11.5	11.47	116	14.5	14.49
				128	11.5	11.42	128	11.5	11.46	128	14.5	14.45
		40	102	11.5	11.45	102	11.5	11.44	102	14.5	14.46	
			110	11.5	11.44	110	11.5	11.49	110	14.5	14.48	
			118	11.5	11.49	118	11.5	11.47	118	14.5	14.49	
			126	11.5	11.42	126	11.5	11.46	126	14.5	14.45	
		ac	80	106	11.5	11.45	106	11.5	10.97	106	14.5	14.22
				122	11.5	11.49	122	11.5	11.48	122	14.5	14.50
			160	11.5	11.44	114	11.5	11.49	114	14.5	14.48	
		5.65 GHz & U-NII-3 (5725~5850MHz)	a	20	132	N/A	N/A	132	N/A	N/A	132	N/A
	149				N/A	N/A	149	N/A	N/A	149	N/A	N/A
	165				N/A	N/A	165	N/A	N/A	165	N/A	N/A
	n(HT)		20	132	11.5	11.47	132	11.5	11.42	132	14.5	14.46
				149	11.5	11.43	149	11.5	11.42	149	14.5	14.44
				165	11.5	11.42	165	11.5	11.47	165	14.5	14.46
	40		134	11.5	11.43	134	11.5	11.46	134	14.5	14.46	
			151	11.5	11.49	151	11.5	11.48	151	14.5	14.50	
			159	11.5	11.48	159	11.5	11.49	159	14.5	14.50	
ac	20		144	11.5	11.49	144	11.5	11.44	144	14.5	14.48	
			40	142	11.5	11.49	142	11.5	11.43	142	14.5	14.47
	80		138	11.5	11.46	138	11.5	11.41	138	14.5	14.45	
		155	11.5	11.43	155	11.5	11.48	155	14.5	14.47		

BT Only Aux

	Standard	Mode	BW	SISO-Main(TX1) CHAIN B				SISO-Aux(TX2) CHAIN A			
				CH	PK Power	AV Target	AV Power	CH	PK Power	AV Target	AV Power
Bluetooth mode maximum output power	15.247 (2.4GHz)	Normal	GFSK	0	N/A	N/A	N/A	0	10.04	9.5	8.85
				39	N/A	N/A	N/A	39	10.48	9.5	9.48
				78	N/A	N/A	N/A	78	10.42	9.5	9.49
		EDR	8DPSK	0	N/A	N/A	N/A	0	9.86	8	7.71
				39	N/A	N/A	N/A	39	10.16	8	7.94
				78	N/A	N/A	N/A	78	10.27	8	7.95
		BLE	GFSK	0	N/A	N/A	N/A	0	7.50	6.5	6.42
				19	N/A	N/A	N/A	19	7.60	6.5	6.41
				39	N/A	N/A	N/A	39	7.51	6.5	6.40

9. Test Results

9.1 SAR Test Results Summary

SAR MEASUREMENT								
Ambient Temperature (°C) : 22.1 ±2					Relative Humidity (%) : 49			
Liquid Temperature (°C) : 21.4 ±2					Depth of Liquid (cm) : >15			
Test Position Body	Antenna Position	Frequency		Conducted Power (dBm)		SAR 1g (W/kg)		Limit (W/kg)
		Channel	MHz	Measurement	Tune-up Limit	Measurement	Tune-up Scaled	
Test Mode: 802.11b - INPAQ Main Antenna								
Bottom(NB)	Fixed	12	2467	13.49	13.5	0.541	0.542	1.6
Back(PAD)	Fixed	1	2412	13.45	13.5	0.578	0.585	1.6
Back(PAD)	Fixed	6	2437	13.35	13.5	0.614	0.635	1.6
Back(PAD)	Fixed	12	2467	13.49	13.5	0.631	0.632	1.6
Bottom(PAD)	Fixed	12	2467	13.49	13.5	0.343	0.344	1.6
Test Mode: 802.11b - INPAQ Aux Antenna								
Bottom(NB)	Fixed	12	2467	13.46	13.5	0.526	0.531	1.6
Back(PAD)	Fixed	1	2412	13.46	13.5	0.565	0.570	1.6
Back(PAD)	Fixed	6	2437	13.45	13.5	0.623	0.630	1.6
Back(PAD)	Fixed	12	2467	13.46	13.5	0.620	0.626	1.6
Bottom(PAD)	Fixed	6	2437	13.46	13.5	0.223	0.225	1.6
Test Mode: BT -1M - INPAQ Aux Antenna								
Back(PAD)	Fixed	78	2480	9.49	9.5	0.340	0.341	1.6
Note : 1. When the highest reported SAR for DSSS is adjusted by the ratio of OFDM to DSSS specified maximum output power and the adjusted SAR is ≤ 1.2 W/kg, SAR is not required. 2. When the reported SAR of the highest measured maximum output power channel for the exposure configuration is ≤ 0.8 W/kg, no further SAR testing is required for 802.11b DSSS in that exposure configuration.								

SAR MEASUREMENT								
Ambient Temperature (°C) : 22.4 ±2				Relative Humidity (%) : 50				
Liquid Temperature (°C) : 20.2 ±2				Depth of Liquid (cm) : >15				
Test Position Body	Antenna Position	Frequency		Conducted Power (dBm)		SAR 1g (W/kg)		Limit (W/kg)
		Channel	MHz	Measurement	Tune-up Limit	Measurement	Tune-up Scaled	
Test Mode: 802.11ac (80M)-5GHz- INPAQ Main Antenna								
Bottom(NB)	Fixed	58	5290	14.43	14.5	0.682	0.693	1.6
Bottom(NB)	Fixed	106	5530	14.49	14.5	1.080	1.082	1.6
Bottom(NB)	Fixed	122	5610	14.45	14.5	1.070	1.082	1.6
Bottom(NB)	Fixed	138	5690	14.44	14.5	1.030	1.044	1.6
Bottom(NB)	Fixed	155	5775	14.46	14.5	0.863	0.871	1.6
Back(PAD)	Fixed	58	5290	11.45	11.5	0.494	0.500	1.6
Back(PAD)	Fixed	106	5530	11.49	11.5	0.651	0.653	1.6
Back(PAD)	Fixed	155	5775	11.47	11.5	0.533	0.537	1.6
Bottom(PAD)	Fixed	58	5290	11.45	11.5	0.717	0.725	1.6
Bottom(PAD)	Fixed	106	5530	11.49	11.5	0.998	1.000	1.6
Bottom(PAD)	Fixed	122	5610	11.47	11.5	1.050	1.057	1.6
Bottom(PAD)	Fixed	138	5690	11.48	11.5	0.991	0.996	1.6
Bottom(PAD)	Fixed	155	5775	11.47	11.5	0.957	0.964	1.6
Test Mode: 802.11ac (80M)-5GHz- INPAQ Aux Antenna								
Bottom(NB)	Fixed	58	5290	14.42	14.5	0.489	0.798	1.6
Bottom(NB)	Fixed	122	5610	14.49	14.5	0.703	0.705	1.6
Bottom(NB)	Fixed	155	5775	14.41	14.5	0.713	0.728	1.6
Back(PAD)	Fixed	58	5290	11.46	11.5	0.530	0.535	1.6
Back(PAD)	Fixed	106	5530	11.49	11.5	0.473	0.474	1.6
Back(PAD)	Fixed	155	5775	11.47	11.5	0.511	0.515	1.6
Bottom(PAD)	Fixed	42	5210	11.48	11.5	0.550	0.553	1.6
Bottom(PAD)	Fixed	58	5290	11.46	11.5	0.805	0.812	1.6
Bottom(PAD)	Fixed	106	5530	11.49	11.5	0.648	0.649	1.6
Bottom(PAD)	Fixed	155	5775	11.47	11.5	0.640	0.644	1.6
Note : 1. When multiple transmission modes (802.11 n) have the same specified maximum output power, largest channel bandwidth, lowest order modulation and lowest data rate, the lowest order 802.11 mode is selected 2. When the reported SAR of the highest measured maximum output power channel for the exposure configuration is ≤ 0.8 W/kg, no further SAR testing is required in that exposure configuration. 3. When the reported SAR of the highest measured maximum U-NII-2A for the exposure configuration is ≤ 1.2 W/kg, SAR is not required for U-NII-1 band.								

9.2 Simultaneous Transmission

Simultaneous Transmission Configurations	
1	WLAN 2.4GHz Main + WLAN 2.4GHz Aux
2	WLAN 2.4GHz Main + BT Aux
3	WLAN 5GHz Main + WLAN 5GHz Aux
4	WLAN 5GHz Main + BT Aux
5	WLAN 5GHz Main + WLAN 5GHz Aux + BT Aux

9.2.1 Simultaneous transmission of MIMO in 802.11 test exclusion considerations

Frequency (GHz)	Test Position (Body)	WLAN Main SAR (W/Kg)	WLAN Aux SAR W/Kg)	Simultaneous Transmission (W/Kg)	Antenna pair in mm	Peak location separation ratio
2.4	Bottom(NB)	0.542	0.531	1.073	N/A	N/A
2.4	Back(PAD)	0.635	0.630	1.265	N/A	N/A
2.4	Bottom(PAD)	0.344	0.225	0.569	N/A	N/A
5	Bottom(NB)	1.082	0.728	1.810	65.19	0.037
5	Back(PAD)	0.653	0.535	1.188	N/A	N/A
5	Bottom(PAD)	1.057	0.812	1.869	63.01	0.041

Note : The sum of value is less than 1.6W/Kg or the ratio is determined by $(SAR1 + SAR2)^{1.5}/R_i$, rounded to two decimal digits, and must be ≤ 0.04 for all antenna pairs in the configuration to qualify for SAR test exclusion.

5G – Bottom(NB)

<input type="checkbox"/> Maxima and position w.r.t. Grid Reference Point associated 1g averages	
<input type="checkbox"/> Zoom Scan (6x6x12) (C:\Users\Administrator\Desktop\PreTest\UX\UX562\Report\FCC\WLAN 5G\802.11ac8...	Max. 1 at (-12.50, 32.50, 0.35) mm 1.08 W/kg
<input type="checkbox"/> Zoom Scan (6x6x12) (C:\Users\Administrator\Desktop\PreTest\UX\UX562\Report\FCC\WLAN 5G\802.11ac8...	Max. 2 at (-7.50, -32.50, 0.37) mm 0.71 W/kg
<input type="checkbox"/> Distances and Separation Ratios	
Max. 1 - Max. 2	Distance [mm]: 65.19

5G - Bottom(PAD)

<input type="checkbox"/> Maxima and position w.r.t. Grid Reference Point associated 1g averages	
<input type="checkbox"/> Zoom Scan (6x6x12) (C:\Users\Administrator\Desktop\PreTest\UX\UX562\Report\FCC\WLAN 5G\802.11ac8...	Max. 1 at (-8.50, -31.50, 0.28) mm 1.05 W/kg
<input type="checkbox"/> Zoom Scan (6x6x12) (C:\Users\Administrator\Desktop\PreTest\UX\UX562\Report\FCC\WLAN 5G\802.11ac8...	Max. 2 at (-7.50, 31.50, 0.32) mm 0.80 W/kg
<input type="checkbox"/> Distances and Separation Ratios	
Max. 1 - Max. 2	Distance [mm]: 63.01

Test Mode: 802.11n (40M)-5GHz MIMO - INPAQ Antenna								
Test Position Body	Antenna Position	Frequency		Conducted Power (dBm)		SAR 1g (W/kg)		Limit (W/kg)
		Channel	MHz	Measurement	Tune-up Limit	Measurement	Tune-up Scaled	
Bottom(NB)-Main	Fixed	46	5230	14.41	14.5	0.684	0.698	1.6
Bottom(NB)-Aux	Fixed	46	5230	14.48	14.5	N/A	N/A	1.6
Bottom(NB)-Main	Fixed	54	5270	14.48	14.5	0.553	0.556	1.6
Bottom(NB)-Aux	Fixed	54	5270	14.46	14.5	N/A	N/A	1.6
Bottom(NB)-Main	Fixed	62	5310	14.48	14.5	0.886	0.890	1.6
Bottom(NB)-Aux	Fixed	62	5310	14.11	14.5	0.671	0.734	1.6
Test Mode: 802.11ac (80M)-5GHz MIMO - INPAQ Antenna								
Bottom(NB)-Main	Fixed	122	5610	14.48	14.5	1.150	1.155	1.6
Bottom(NB)-Aux	Fixed	122	5610	14.45	14.5	N/A	N/A	1.6
Bottom(NB)-Main	Fixed	138	5690	14.49	14.5	1.130	1.133	1.6
Bottom(NB)-Aux	Fixed	138	5690	14.42	14.5	0.770	0.784	1.6
Bottom(NB)-Main	Fixed	155	5775	14.48	14.5	0.759	0.763	1.6
Bottom(NB)-Aux	Fixed	155	5775	13.37	14.5	N/A	N/A	1.6
Bottom(PAD)-Main	Fixed	58	5290	11.45	11.5	0.780	0.789	1.6
Bottom(PAD)-Aux	Fixed	58	5290	11.46	11.5	0.762	0.769	1.6
Bottom(PAD)-Main	Fixed	106	5530	11.45	11.5	0.981	0.992	1.6
Bottom(PAD)-Aux	Fixed	106	5530	10.97	11.5	0.859	0.970	1.6
Bottom(PAD)-Main	Fixed	122	5610	11.49	11.5	0.988	0.990	1.6
Bottom(PAD)-Aux	Fixed	122	5610	11.48	11.5	0.729	0.732	1.6
Bottom(PAD)-Main	Fixed	138	5690	11.46	11.5	0.986	0.995	1.6
Bottom(PAD)-Aux	Fixed	138	5690	11.41	11.5	0.859	0.877	1.6
Bottom(PAD)-Main	Fixed	155	5775	11.43	11.5	0.899	0.914	1.6
Bottom(PAD)-Aux	Fixed	155	5775	11.48	11.5	0.668	0.671	1.6
Note : 1. When the reported SAR of the highest measured maximum output power channel for the exposure configuration is ≤ 0.8 W/kg, no further SAR testing is required in that exposure configuration. 2. When the reported SAR of the highest measured maximum U-NII-2A for the exposure configuration is ≤ 1.2 W/kg, SAR is not required for U-NII-1 band.								

9.2.2.2 simultaneous transmission of Wi-Fi and other wireless technologies

When the sum of SAR is larger than the limit, The ratio is determined by $(SAR1 + SAR2)^{1.5/R_i}$, rounded to two decimal digits, and must be ≤ 0.04 for all antenna pairs in the configuration to qualify for 1-g SAR test exclusion. The estimation result as below:

For DTS Band:

Mode	WLAN Main SAR (W/Kg)	BT SAR (W/Kg)	Simultaneous Transmission (W/Kg)	Antenna pair in mm	Peak location separation ratio
Back(PAD)	0.635	0.341	0.976	N/A	N/A

The sum of value is less than 1.6W/Kg, thus simultaneous SAR testing is not needed.

For U-NII Band:

Mode	WLAN Main SAR (W/Kg)	BT SAR (W/Kg)	Simultaneous Transmission (W/Kg)	Antenna pair in mm	Peak location separation ratio
Bottom(NB)	1.082	0.341	1.423	N/A	N/A

Mode	WLAN MIMO SAR (W/Kg)	Estimated BT SAR (W/Kg)	Simultaneous Transmission (W/Kg)	Antenna pair in mm	Peak location separation ratio
Bottom(NB)	1.155	0.341	1.496	N/A	N/A

The sum of value is less than 1.6W/Kg, thus simultaneous SAR testing is not needed.

10. SAR measurement variability

- 1) Repeated measurement is not required when the original highest measured SAR is < 0.80 W/kg; steps 2) through 4) do not apply.
- 2) When the original highest measured SAR is ≥ 0.80 W/kg, repeat that measurement once.
- 3) Perform a second repeated measurement only if the ratio of largest to smallest SAR for the original and first repeated measurements is > 1.20 or when the original or repeated measurement is ≥ 1.45 W/kg ($\sim 10\%$ from the 1-g SAR limit).
- 4) Perform a third repeated measurement only if the original, first or second repeated measurement is ≥ 1.5 W/kg and the ratio of largest to smallest SAR for the original, first and second repeated measurements is > 1.20 .

Frequency		SAR 1g (W/kg)						
Channel	MHz	Original	First Repeated		Second Repeated		Third Repeated	
			Value	Ratio	Value	Ratio	Value	Ratio
12	2467	0.631	N/A	N/A	N/A	N/A	N/A	N/A
122	5610	1.150	1.080	1.065	N/A	N/A	N/A	N/A

Appendix

Appendix A. SAR System Check Data

Appendix B. SAR measurement Data

Appendix C. Test Setup Photographs & EUT Photographs

Appendix D. Probe Calibration Data

Appendix E. Dipole Calibration Data

Appendix A. SAR System Check Data

Test Laboratory: DEKRA

Date/Time: 2019/02/21

System Performance Check_2450MHz-Body

DUT: Dipole 2450 MHz; Type: D2450V2

Communication System: UID 0, CW; Frequency: 2450 MHz;

Communication System PAR: 0 dB

Medium parameters used: $f = 2450$ MHz; $\sigma = 1.96$ S/m; $\epsilon_r = 51.76$; $\rho = 1000$ kg/m³

Phantom section: Flat Section

Ambient Temperature (°C) : 22.1, Liquid Temperature (°C) : 21.4

Measurement Standard: DASYS (IEEE/IEC/ANSI C63.19-2011)

DASY5 Configuration:

- Probe: EX3DV4 - SN3979; ConvF(7.5, 7.5, 7.5); Calibrated: 2018/11/22;
- Sensor-Surface: 3mm (Mechanical Surface Detection)
- Electronics: DAE4 Sn1425; Calibrated: 2018/11/16
- Phantom: SAM with left table; Type: SAM;
- Measurement SW: DASYS52, Version 52.10 (0); SEMCAD X Version 14.6.10 (7417)

Configuration/2450MHz_Body/Area Scan (9x9x1): Measurement grid: dx=12mm, dy=12mm

Maximum value of SAR (measured) = 14.4 W/kg

Configuration/2450MHz_Body/Zoom Scan (7x7x7) (7x7x7)/Cube 0:

Measurement grid: dx=5mm, dy=5mm, dz=5mm

Reference Value = 85.14 V/m; Power Drift = -0.07 dB

Peak SAR (extrapolated) = 26.3 W/kg

SAR(1 g) = 12.9 W/kg; SAR(10 g) = 6.08 W/kg

Maximum value of SAR (measured) = 14.5 W/kg

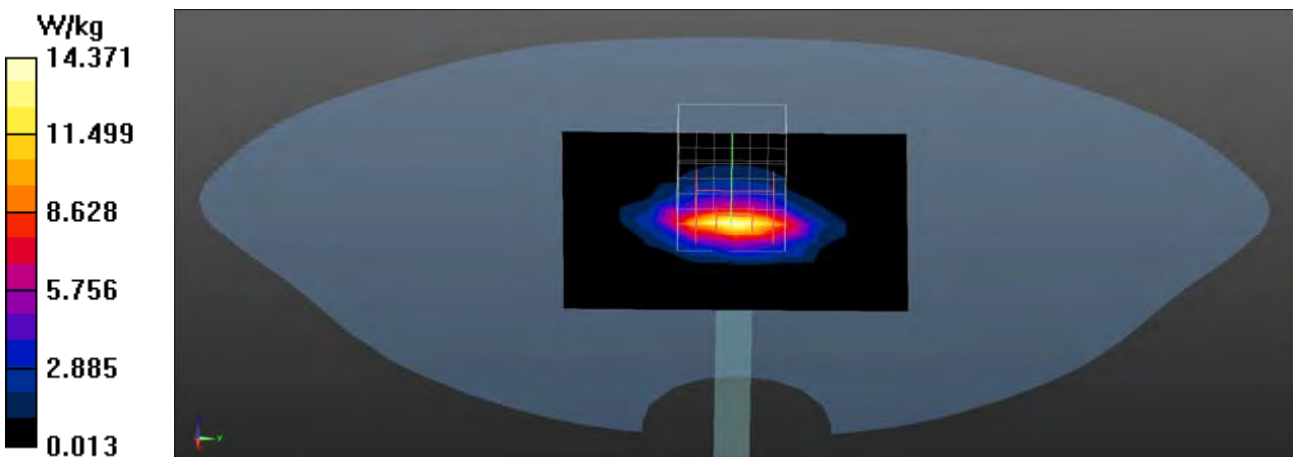

Test Laboratory: DEKRA

Date/Time: 2019/02/22

System Performance Check_5200MHz-Body**DUT: Dipole 5GHz; Type: D5GHzV2**

Communication System: UID 0, CW; Frequency: 5200 MHz;

Communication System PAR: 0 dB

Medium parameters used: $f = 5200$ MHz; $\sigma = 5.32$ S/m; $\epsilon_r = 49.99$; $\rho = 1000$ kg/m³

Phantom section: Flat Section

Ambient Temperature (°C) : 22.4, Liquid Temperature (°C) : 20.2

Measurement Standard: DASYS (IEEE/IEC/ANSI C63.19-2011)

DASY5 Configuration:

- Probe: EX3DV4 - SN3979; ConvF(4.46, 4.46, 4.46); Calibrated: 2018/11/22;
- Sensor-Surface: 1.4mm (Mechanical Surface Detection)
- Electronics: DAE4 Sn1425; Calibrated: 2018/11/16
- Phantom: SAM with right table; Type: SAM;
- Measurement SW: DASY52, Version 52.10 (0); SEMCAD X Version 14.6.10 (7417)

Configuration/5200MHz_Body/Area Scan (8x8x1): Measurement grid: dx=10mm, dy=10mm

Maximum value of SAR (measured) = 10.7 W/kg

Configuration/5200MHz_Body/Zoom Scan (7x7x12), dist=1.4mm**(7x7x12)/Cube 0:** Measurement grid: dx=4mm, dy=4mm, dz=2mm

Reference Value = 68.29 V/m; Power Drift = -0.03 dB

Peak SAR (extrapolated) = 28.7 W/kg

SAR(1 g) = 7.39 W/kg; SAR(10 g) = 2.18 W/kg

Maximum value of SAR (measured) = 17.9 W/kg

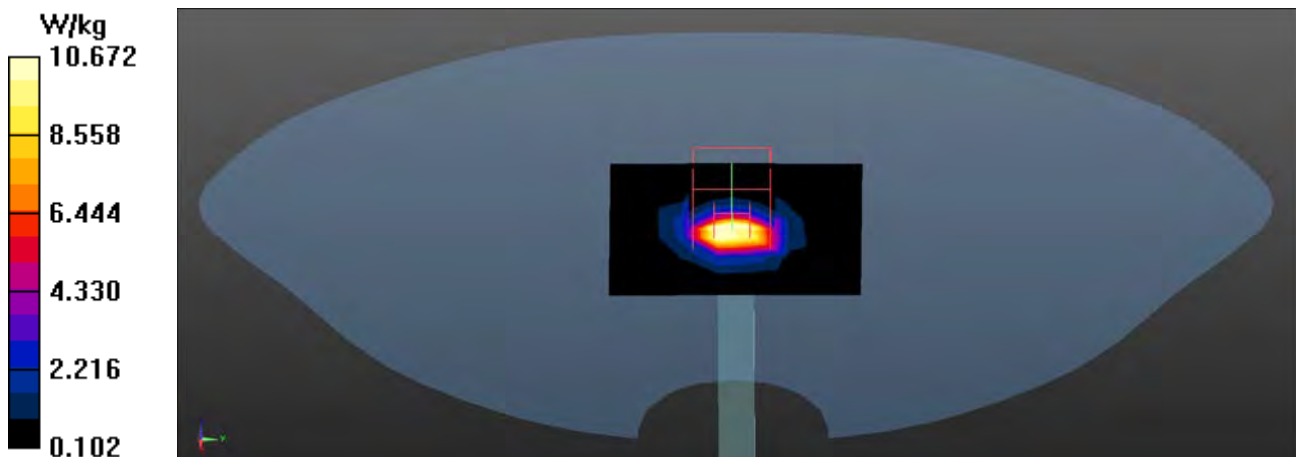

Test Laboratory: DEKRA

Date/Time: 2019/02/22

System Performance Check_5300MHz-Body**DUT: Dipole 5GHz; Type: D5GHzV2**

Communication System: UID 0, CW; Frequency: 5300 MHz;

Communication System PAR: 0 dB

Medium parameters used: $f = 5300$ MHz; $\sigma = 5.46$ S/m; $\epsilon_r = 49.72$; $\rho = 1000$ kg/m³

Phantom section: Flat Section

Ambient Temperature (°C) : 22.4, Liquid Temperature (°C) : 20.2

Measurement Standard: DASYS (IEEE/IEC/ANSI C63.19-2011)

DASY5 Configuration:

- Probe: EX3DV4 - SN3979; ConvF(4.46, 4.46, 4.46); Calibrated: 2018/11/22;
- Sensor-Surface: 1.4mm (Mechanical Surface Detection)
- Electronics: DAE4 Sn1425; Calibrated: 2018/11/16
- Phantom: SAM with right table; Type: SAM;
- Measurement SW: DASYS2, Version 52.10 (0); SEMCAD X Version 14.6.10 (7417)

Configuration/5300MHz_Body/Area Scan (8x8x1): Measurement grid: dx=10mm, dy=10mm

Maximum value of SAR (measured) = 14.3 W/kg

Configuration/5300MHz_Body/Zoom Scan (7x7x12), dist=1.4mm**(7x7x12)/Cube 0:** Measurement grid: dx=4mm, dy=4mm, dz=2mm

Reference Value = 66.68 V/m; Power Drift = 0.05 dB

Peak SAR (extrapolated) = 33.0 W/kg

SAR(1 g) = 8.29 W/kg; SAR(10 g) = 2.24 W/kg

Maximum value of SAR (measured) = 20.3 W/kg

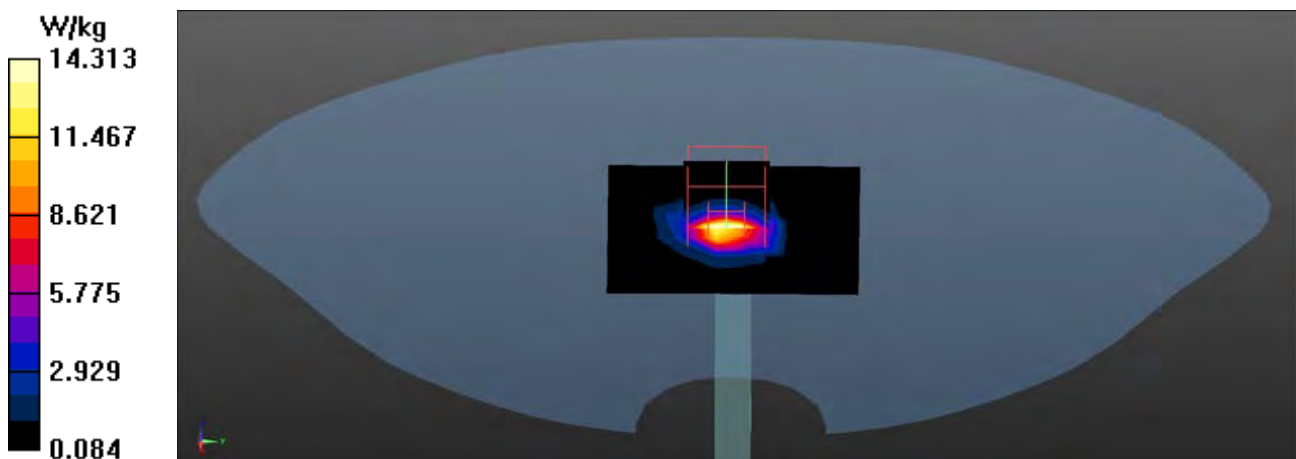

Test Laboratory: DEKRA

Date/Time: 2019/02/22

System Performance Check_5600MHz-Body**DUT: Dipole 5GHz; Type: D5GHzV2**

Communication System: UID 0, CW; Frequency: 5600 MHz;

Communication System PAR: 0 dB

Medium parameters used: $f = 5600$ MHz; $\sigma = 5.94$ S/m; $\epsilon_r = 48.9$; $\rho = 1000$ kg/m³

Phantom section: Flat Section

Ambient Temperature (°C) : 22.4, Liquid Temperature (°C) : 20.2

Measurement Standard: DASYS (IEEE/IEC/ANSI C63.19-2011)

DASY5 Configuration:

- Probe: EX3DV4 - SN3979; ConvF(3.92, 3.92, 3.92); Calibrated: 2018/11/22;
- Sensor-Surface: 1.4mm (Mechanical Surface Detection)
- Electronics: DAE4 Sn1425; Calibrated: 2018/11/16
- Phantom: SAM with right table; Type: SAM;
- Measurement SW: DASYS52, Version 52.10 (0); SEMCAD X Version 14.6.10 (7417)

Configuration/5600MHz_Body/Area Scan (8x8x1): Measurement grid: dx=10mm, dy=10mm

Maximum value of SAR (measured) = 14.2 W/kg

Configuration/5600MHz_Body/Zoom Scan (7x7x12), dist=1.4mm**(7x7x12)/Cube 0:** Measurement grid: dx=4mm, dy=4mm, dz=2mm

Reference Value = 69.79 V/m; Power Drift = -0.12 dB

Peak SAR (extrapolated) = 37.9 W/kg

SAR(1 g) = 8.59 W/kg; SAR(10 g) = 2.22 W/kg

Maximum value of SAR (measured) = 22.1 W/kg

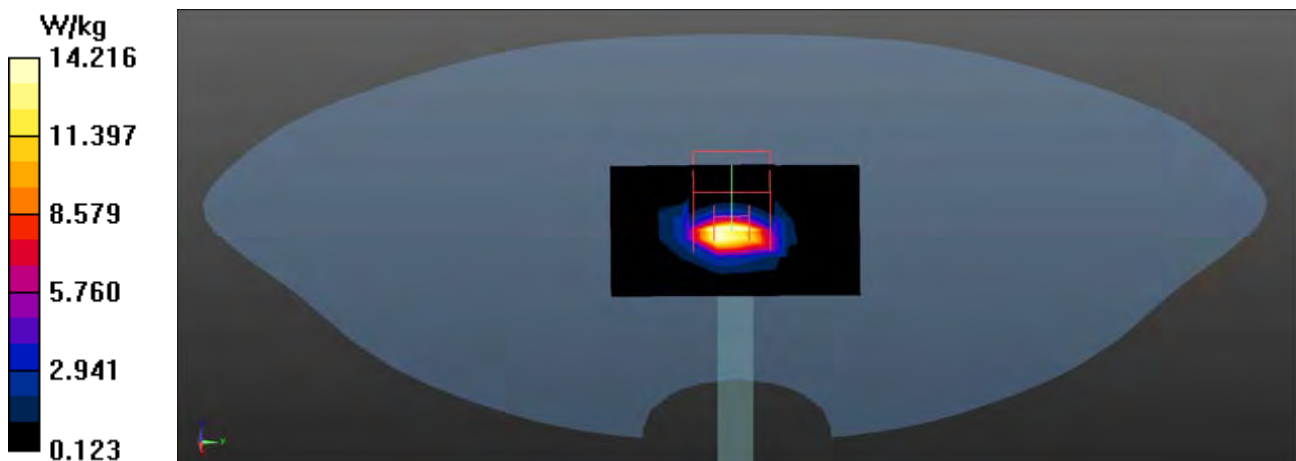

Test Laboratory: DEKRA

Date/Time: 2019/02/22

System Performance Check_5800MHz-Body**DUT: Dipole 5GHz; Type: D5GHzV2**

Communication System: UID 0, CW; Frequency: 5800 MHz;

Communication System PAR: 0 dB

Medium parameters used: $f = 5800$ MHz; $\sigma = 6.24$ S/m; $\epsilon_r = 48.37$; $\rho = 1000$ kg/m³

Phantom section: Flat Section

Ambient Temperature (°C) : 22.4, Liquid Temperature (°C) : 20.2

Measurement Standard: DASYS (IEEE/IEC/ANSI C63.19-2011)

DASY5 Configuration:

- Probe: EX3DV4 - SN3979; ConvF(4.2, 4.2, 4.2); Calibrated: 2018/11/22;
- Sensor-Surface: 1.4mm (Mechanical Surface Detection)
- Electronics: DAE4 Sn1425; Calibrated: 2018/11/16
- Phantom: SAM with right table; Type: SAM;
- Measurement SW: DASYS2, Version 52.10 (0); SEMCAD X Version 14.6.10 (7417)

Configuration/5800MHz_Body/Area Scan (8x8x1): Measurement grid: dx=10mm, dy=10mm

Maximum value of SAR (measured) = 13.7 W/kg

Configuration/5800MHz_Body/Zoom Scan (7x7x12), dist=1.4mm**(7x7x12)/Cube 0:** Measurement grid: dx=4mm, dy=4mm, dz=2mm

Reference Value = 63.74 V/m; Power Drift = -0.13 dB

Peak SAR (extrapolated) = 35.0 W/kg

SAR(1 g) = 7.89 W/kg; SAR(10 g) = 2.18 W/kg

Maximum value of SAR (measured) = 19.6 W/kg

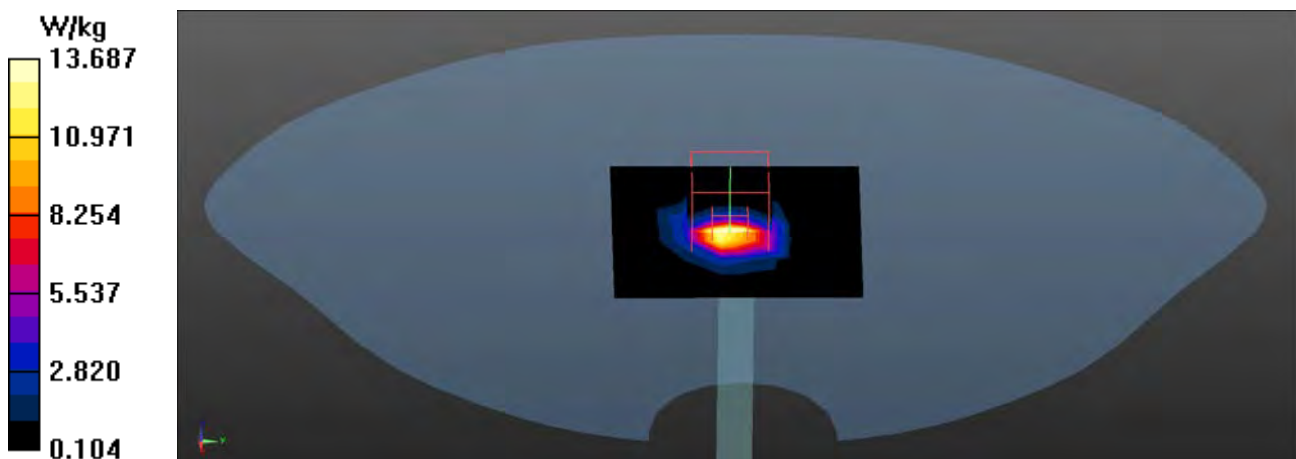

Appendix B. SAR measurement Data

Test Laboratory: DEKRA

Date/Time: 2019/02/21

802.11b_12-Bottom(NB) Main-INPAQ

DUT: ZenBook; Type: UX562F, RX562F, Q546F

Communication System: UID 0, WLAN 2.4G; Frequency: 2467 MHz;

Communication System PAR: 0 dB

Medium parameters used: $f = 2467$ MHz; $\sigma = 1.98$ S/m; $\epsilon_r = 51.7$; $\rho = 1000$ kg/m³

Phantom section: Flat Section

Ambient Temperature (°C) : 22.1, Liquid Temperature (°C) : 21.4

Measurement Standard: DASYS (IEEE/IEC/ANSI C63.19-2011)

DASY5 Configuration:

- Probe: EX3DV4 - SN3979; ConvF(7.5, 7.5, 7.5); Calibrated: 2018/11/22;
- Sensor-Surface: 3mm (Mechanical Surface Detection)
- Electronics: DAE4 Sn1425; Calibrated: 2018/11/16
- Phantom: SAM with left table; Type: SAM;
- Measurement SW: DASYS2, Version 52.10 (0); SEMCAD X Version 14.6.10 (7417)

Configuration/Body/Area Scan (7x8x1): Measurement grid: dx=12mm, dy=12mm
Maximum value of SAR (measured) = 1.00 W/kg

Configuration/Body/Zoom Scan (5x5x7) (5x5x7)/Cube 0: Measurement grid:
dx=8mm, dy=8mm, dz=5mm
Reference Value = 6.629 V/m; Power Drift = -0.01 dB
Peak SAR (extrapolated) = 2.02 W/kg
SAR(1 g) = 0.541 W/kg; SAR(10 g) = 0.243 W/kg
Maximum value of SAR (measured) = 1.18 W/kg

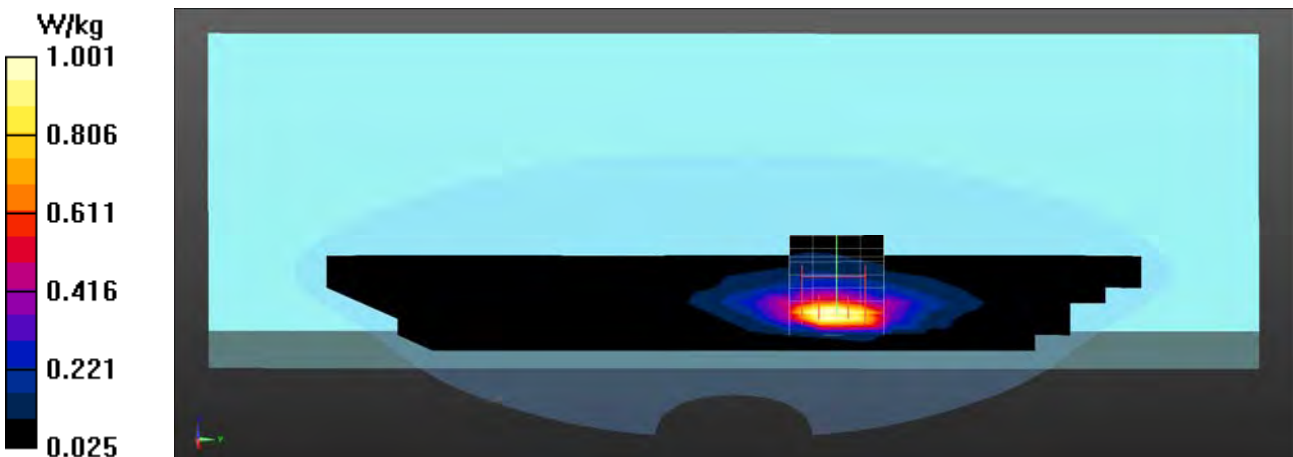

Test Laboratory: DEKRA

Date/Time: 2019/02/21

802.11b_1-Back(PAD) Main-INPAQ**DUT: ZenBook; Type: UX562F, RX562F, Q546F**

Communication System: UID 0, WLAN 2.4G; Frequency: 2412 MHz;

Communication System PAR: 0 dB

Medium parameters used: $f = 2412$ MHz; $\sigma = 1.88$ S/m; $\epsilon_r = 51.91$; $\rho = 1000$ kg/m³

Phantom section: Flat Section

Ambient Temperature (°C) : 22.1, Liquid Temperature (°C) : 21.4

Measurement Standard: DASY5 (IEEE/IEC/ANSI C63.19-2011)

DASY5 Configuration:

- Probe: EX3DV4 - SN3979; ConvF(7.5, 7.5, 7.5); Calibrated: 2018/11/22;
- Sensor-Surface: 3mm (Mechanical Surface Detection)
- Electronics: DAE4 Sn1425; Calibrated: 2018/11/16
- Phantom: SAM with left table; Type: SAM;
- Measurement SW: DASY52, Version 52.10 (0); SEMCAD X Version 14.6.10 (7417)

Configuration/Body/Area Scan (7x8x1): Measurement grid: dx=12mm, dy=12mm
Maximum value of SAR (measured) = 1.08 W/kg**Configuration/Body/Zoom Scan (5x5x7) (5x5x7)/Cube 0:** Measurement grid:
dx=8mm, dy=8mm, dz=5mm

Reference Value = 8.114 V/m; Power Drift = 0.07 dB

Peak SAR (extrapolated) = 2.24 W/kg

SAR(1 g) = 0.578 W/kg; SAR(10 g) = 0.230 W/kg

Maximum value of SAR (measured) = 1.20 W/kg

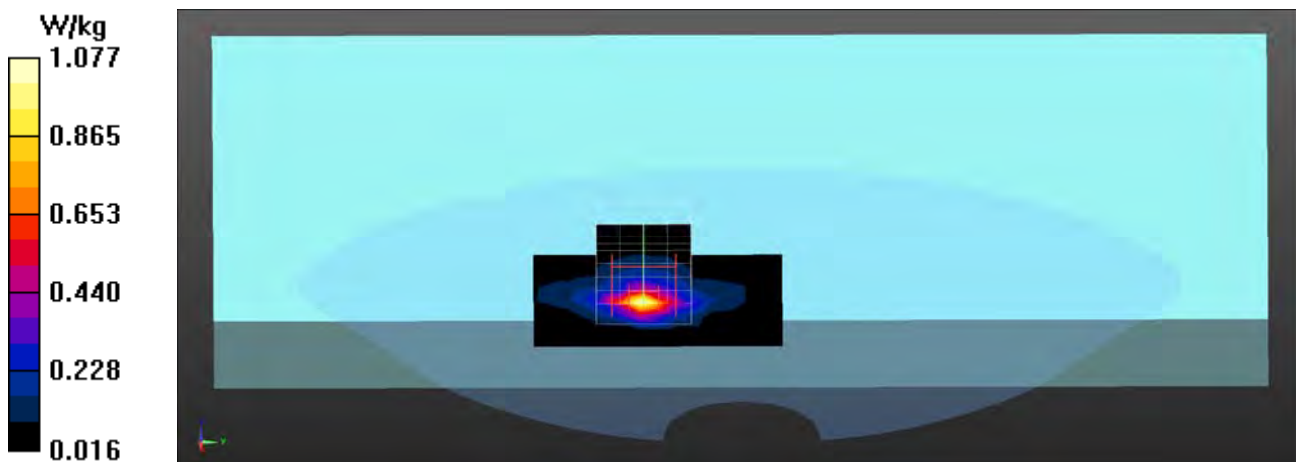

Test Laboratory: DEKRA

Date/Time: 2019/02/21

802.11b_6-Back(PAD) Main-INPAQ**DUT: ZenBook; Type: UX562F, RX562F, Q546F**

Communication System: UID 0, WLAN 2.4G; Frequency: 2437 MHz;

Communication System PAR: 0 dB

Medium parameters used: $f = 2437$ MHz; $\sigma = 1.93$ S/m; $\epsilon_r = 51.8$; $\rho = 1000$ kg/m³

Phantom section: Flat Section

Ambient Temperature (°C) : 22.1, Liquid Temperature (°C) : 21.4

Measurement Standard: DASY5 (IEEE/IEC/ANSI C63.19-2011)

DASY5 Configuration:

- Probe: EX3DV4 - SN3979; ConvF(7.5, 7.5, 7.5); Calibrated: 2018/11/22;
- Sensor-Surface: 3mm (Mechanical Surface Detection)
- Electronics: DAE4 Sn1425; Calibrated: 2018/11/16
- Phantom: SAM with left table; Type: SAM;
- Measurement SW: DASY52, Version 52.10 (0); SEMCAD X Version 14.6.10 (7417)

Configuration/Body/Area Scan (7x26x1): Measurement grid: dx=12mm, dy=12mm
Maximum value of SAR (measured) = 1.05 W/kg**Configuration/Body/Zoom Scan (5x5x7) (5x5x7)/Cube 0:** Measurement grid:
dx=8mm, dy=8mm, dz=5mm

Reference Value = 8.411 V/m; Power Drift = 0.07 dB

Peak SAR (extrapolated) = 2.37 W/kg

SAR(1 g) = 0.614 W/kg; SAR(10 g) = 0.241 W/kg

Maximum value of SAR (measured) = 1.36 W/kg

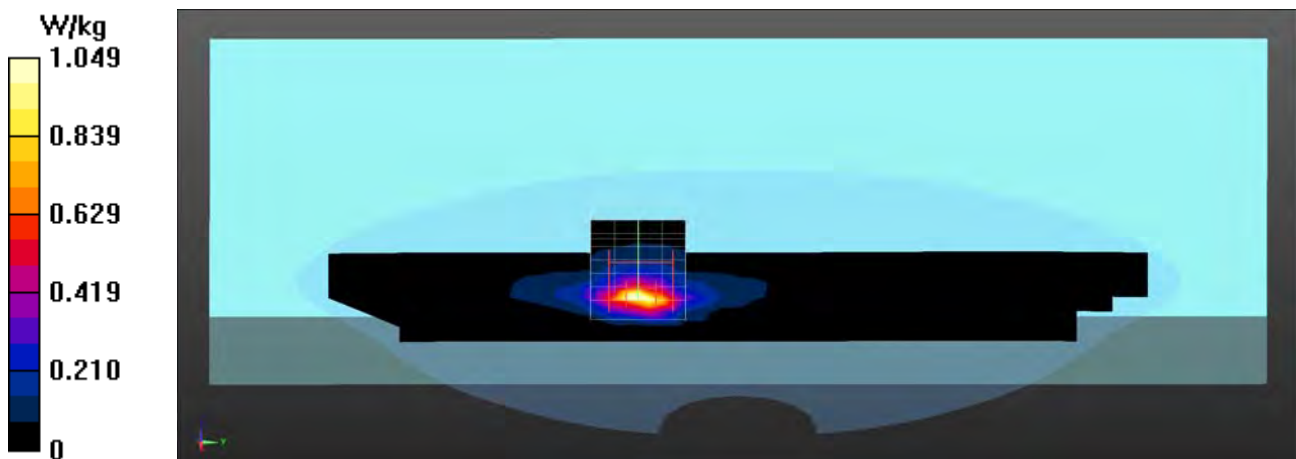

Test Laboratory: DEKRA

Date/Time: 2019/02/21

802.11b_12-Back(PAD) Main-INPAQ**DUT: ZenBook; Type: UX562F, RX562F, Q546F**

Communication System: UID 0, WLAN 2.4G; Frequency: 2467 MHz;

Communication System PAR: 0 dB

Medium parameters used: $f = 2467$ MHz; $\sigma = 1.98$ S/m; $\epsilon_r = 51.7$; $\rho = 1000$ kg/m³

Phantom section: Flat Section

Ambient Temperature (°C) : 22.1, Liquid Temperature (°C) : 21.4

Measurement Standard: DASY5 (IEEE/IEC/ANSI C63.19-2011)

DASY5 Configuration:

- Probe: EX3DV4 - SN3979; ConvF(7.5, 7.5, 7.5); Calibrated: 2018/11/22;
- Sensor-Surface: 3mm (Mechanical Surface Detection)
- Electronics: DAE4 Sn1425; Calibrated: 2018/11/16
- Phantom: SAM with left table; Type: SAM;
- Measurement SW: DASY52, Version 52.10 (0); SEMCAD X Version 14.6.10 (7417)

Configuration/Body/Area Scan (7x8x1): Measurement grid: dx=12mm, dy=12mm
Maximum value of SAR (measured) = 1.23 W/kg**Configuration/Body/Zoom Scan (5x5x7) (5x5x7)/Cube 0:** Measurement grid:
dx=8mm, dy=8mm, dz=5mm

Reference Value = 8.398 V/m; Power Drift = 0.07 dB

Peak SAR (extrapolated) = 2.08 W/kg

SAR(1 g) = 0.631 W/kg; SAR(10 g) = 0.252 W/kg

Maximum value of SAR (measured) = 1.37 W/kg

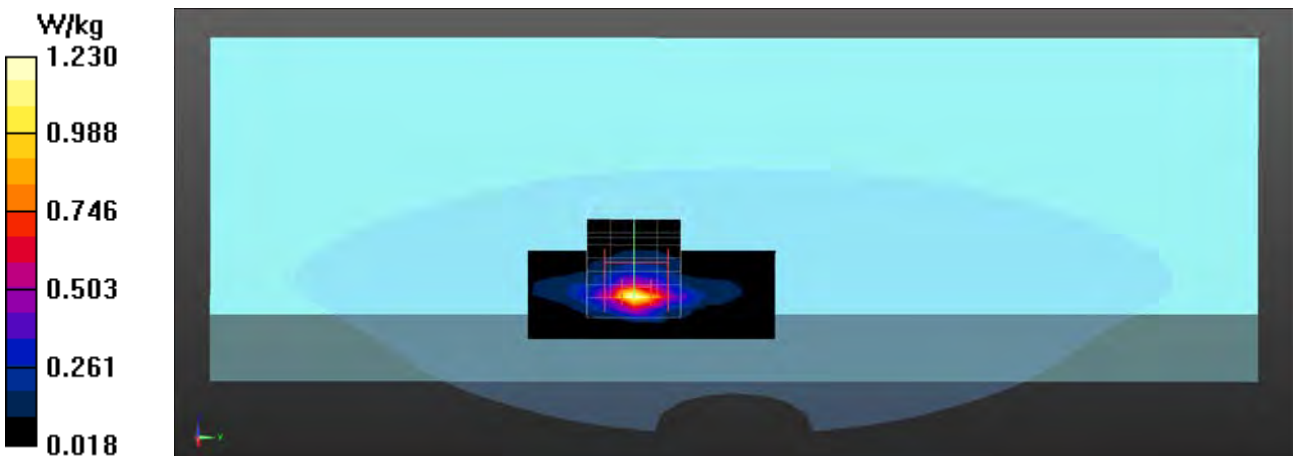

Test Laboratory: DEKRA

Date/Time: 2019/02/21

802.11b_12-Bottom(PAD) Main-INPAQ**DUT: ZenBook; Type: UX562F, RX562F, Q546F**

Communication System: UID 0, WLAN 2.4G; Frequency: 2467 MHz;

Communication System PAR: 0 dB

Medium parameters used: $f = 2467$ MHz; $\sigma = 1.98$ S/m; $\epsilon_r = 51.7$; $\rho = 1000$ kg/m³

Phantom section: Flat Section

Ambient Temperature (°C) : 22.1, Liquid Temperature (°C) : 21.4

Measurement Standard: DASY5 (IEEE/IEC/ANSI C63.19-2011)

DASY5 Configuration:

- Probe: EX3DV4 - SN3979; ConvF(7.5, 7.5, 7.5); Calibrated: 2018/11/22;
- Sensor-Surface: 3mm (Mechanical Surface Detection)
- Electronics: DAE4 Sn1425; Calibrated: 2018/11/16
- Phantom: SAM with left table; Type: SAM;
- Measurement SW: DASY52, Version 52.10 (0); SEMCAD X Version 14.6.10 (7417)

Configuration/Body/Area Scan (7x26x1): Measurement grid: dx=12mm, dy=12mm
Maximum value of SAR (measured) = 0.570 W/kg**Configuration/Body/Zoom Scan (5x5x7) (5x5x7)/Cube 0:** Measurement grid:
dx=8mm, dy=8mm, dz=5mm

Reference Value = 8.396 V/m; Power Drift = -0.06 dB

Peak SAR (extrapolated) = 1.05 W/kg

SAR(1 g) = 0.343 W/kg; SAR(10 g) = 0.165 W/kg

Maximum value of SAR (measured) = 0.657 W/kg

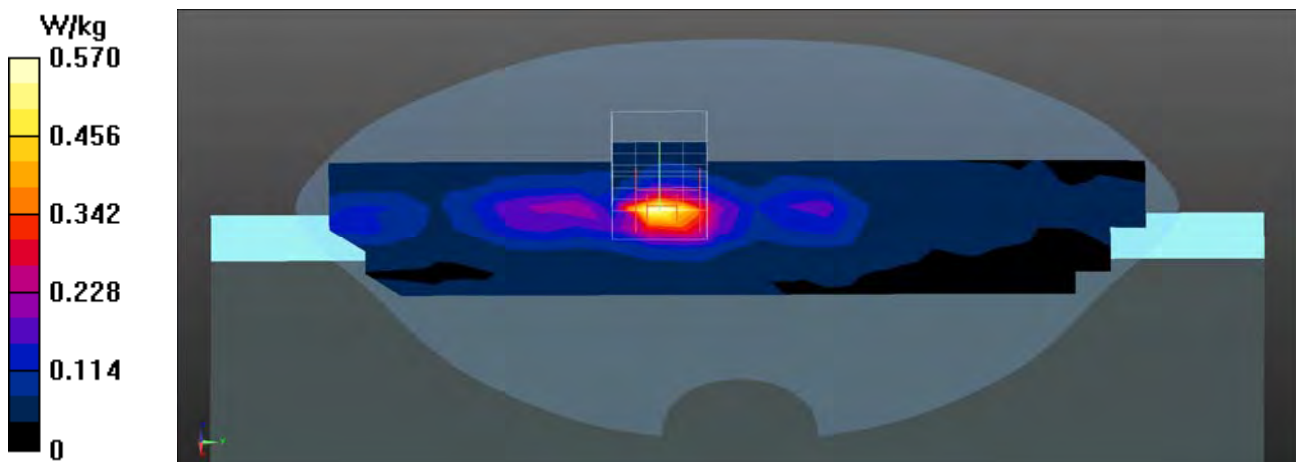

Test Laboratory: DEKRA

Date/Time: 2019/02/21

802.11b_12-Bottom(NB) Aux-INPAQ

DUT: ZenBook; Type: UX562F, RX562F, Q546F

Communication System: UID 0, WLAN 2.4G; Frequency: 2467 MHz;

Communication System PAR: 0 dB

Medium parameters used: $f = 2467$ MHz; $\sigma = 1.98$ S/m; $\epsilon_r = 51.7$; $\rho = 1000$ kg/m³

Phantom section: Flat Section

Ambient Temperature (°C) : 22.1, Liquid Temperature (°C) : 21.4

Measurement Standard: DASYS (IEEE/IEC/ANSI C63.19-2011)

DASY5 Configuration:

- Probe: EX3DV4 - SN3979; ConvF(7.5, 7.5, 7.5); Calibrated: 2018/11/22;
- Sensor-Surface: 3mm (Mechanical Surface Detection)
- Electronics: DAE4 Sn1425; Calibrated: 2018/11/16
- Phantom: SAM with left table; Type: SAM;
- Measurement SW: DASYS2, Version 52.10 (0); SEMCAD X Version 14.6.10 (7417)

Configuration/Body/Area Scan (7x8x1): Measurement grid: dx=12mm, dy=12mm
 Maximum value of SAR (measured) = 0.885 W/kg

Configuration/Body/Zoom Scan (5x5x7) (5x5x7)/Cube 0: Measurement grid:
 dx=8mm, dy=8mm, dz=5mm
 Reference Value = 7.597 V/m; Power Drift = -0.07 dB
 Peak SAR (extrapolated) = 1.92 W/kg
SAR(1 g) = 0.526 W/kg; SAR(10 g) = 0.243 W/kg
 Maximum value of SAR (measured) = 1.12 W/kg

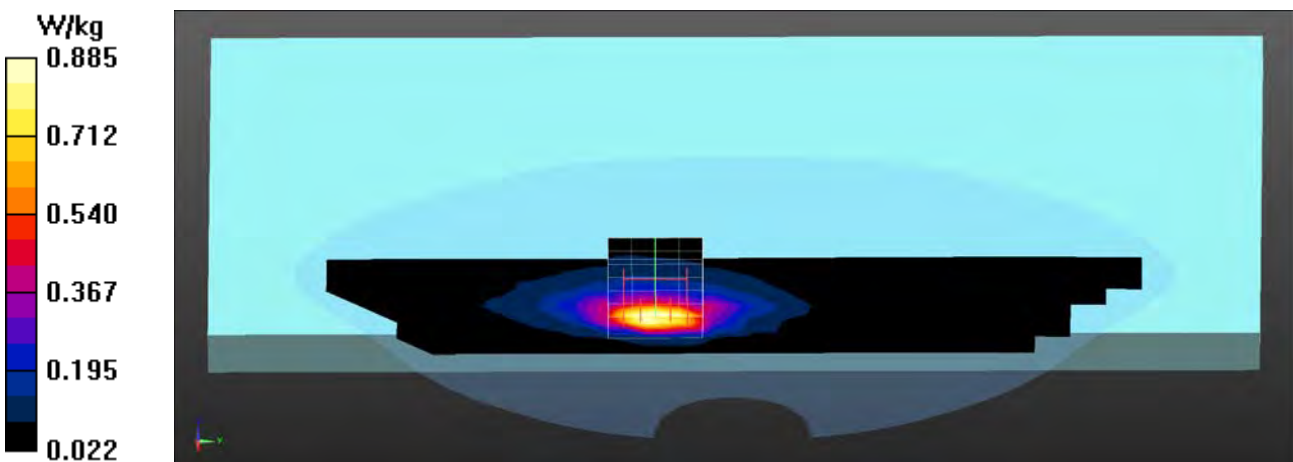

Test Laboratory: DEKRA

Date/Time: 2019/02/21

802.11b_1-Back(PAD) Aux-INPAQ**DUT: ZenBook; Type: UX562F, RX562F, Q546F**

Communication System: UID 0, WLAN 2.4G; Frequency: 2412 MHz;

Communication System PAR: 0 dB

Medium parameters used: $f = 2412$ MHz; $\sigma = 1.88$ S/m; $\epsilon_r = 51.91$; $\rho = 1000$ kg/m³

Phantom section: Flat Section

Ambient Temperature (°C) : 22.1, Liquid Temperature (°C) : 21.4

Measurement Standard: DASYS (IEEE/IEC/ANSI C63.19-2011)

DASY5 Configuration:

- Probe: EX3DV4 - SN3979; ConvF(7.5, 7.5, 7.5); Calibrated: 2018/11/22;
- Sensor-Surface: 3mm (Mechanical Surface Detection)
- Electronics: DAE4 Sn1425; Calibrated: 2018/11/16
- Phantom: SAM with left table; Type: SAM;
- Measurement SW: DASYS2, Version 52.10 (0); SEMCAD X Version 14.6.10 (7417)

Configuration/Body/Area Scan (7x8x1): Measurement grid: dx=12mm, dy=12mm
Maximum value of SAR (measured) = 0.932 W/kg**Configuration/Body/Zoom Scan (5x5x7) (5x5x7)/Cube 0:** Measurement grid:
dx=8mm, dy=8mm, dz=5mm

Reference Value = 9.002 V/m; Power Drift = 0.11 dB

Peak SAR (extrapolated) = 2.13 W/kg

SAR(1 g) = 0.565 W/kg; SAR(10 g) = 0.227 W/kg

Maximum value of SAR (measured) = 1.21 W/kg

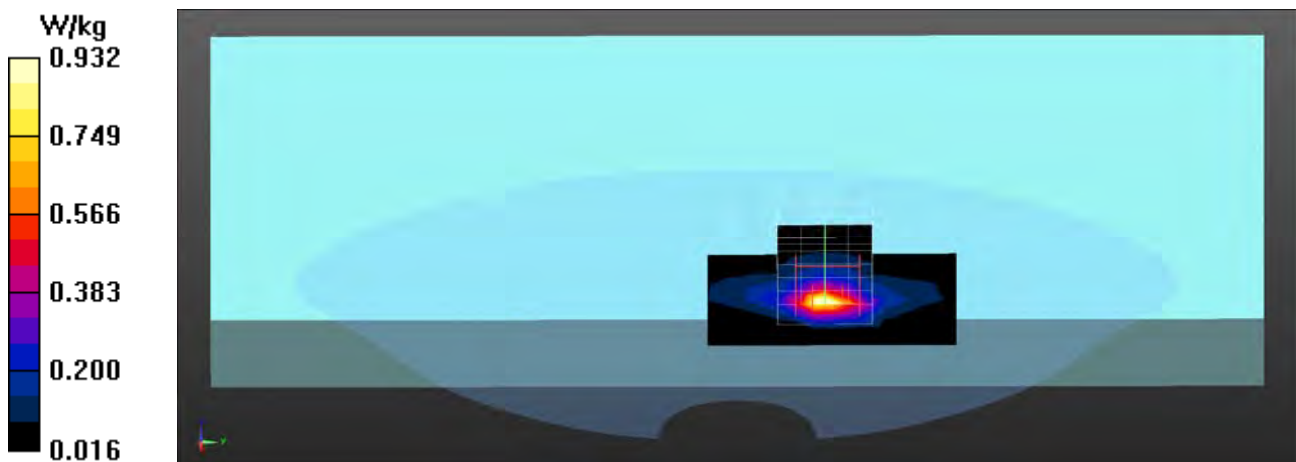

Test Laboratory: DEKRA

Date/Time: 2019/02/21

802.11b_6-Back(PAD) Aux-INPAQ**DUT: ZenBook; Type: UX562F, RX562F, Q546F**

Communication System: UID 0, WLAN 2.4G; Frequency: 2437 MHz;

Communication System PAR: 0 dB

Medium parameters used: $f = 2437$ MHz; $\sigma = 1.93$ S/m; $\epsilon_r = 51.8$; $\rho = 1000$ kg/m³

Phantom section: Flat Section

Ambient Temperature (°C) : 22.1, Liquid Temperature (°C) : 21.4

Measurement Standard: DASY5 (IEEE/IEC/ANSI C63.19-2011)

DASY5 Configuration:

- Probe: EX3DV4 - SN3979; ConvF(7.5, 7.5, 7.5); Calibrated: 2018/11/22;
- Sensor-Surface: 3mm (Mechanical Surface Detection)
- Electronics: DAE4 Sn1425; Calibrated: 2018/11/16
- Phantom: SAM with left table; Type: SAM;
- Measurement SW: DASY52, Version 52.10 (0); SEMCAD X Version 14.6.10 (7417)

Configuration/Body/Area Scan (7x26x1): Measurement grid: dx=12mm, dy=12mm
Maximum value of SAR (measured) = 1.20 W/kg**Configuration/Body/Zoom Scan (5x5x7) (5x5x7)/Cube 0:** Measurement grid:
dx=8mm, dy=8mm, dz=5mm

Reference Value = 9.320 V/m; Power Drift = 0.02 dB

Peak SAR (extrapolated) = 2.83 W/kg

SAR(1 g) = 0.623 W/kg; SAR(10 g) = 0.248 W/kg

Maximum value of SAR (measured) = 1.37 W/kg

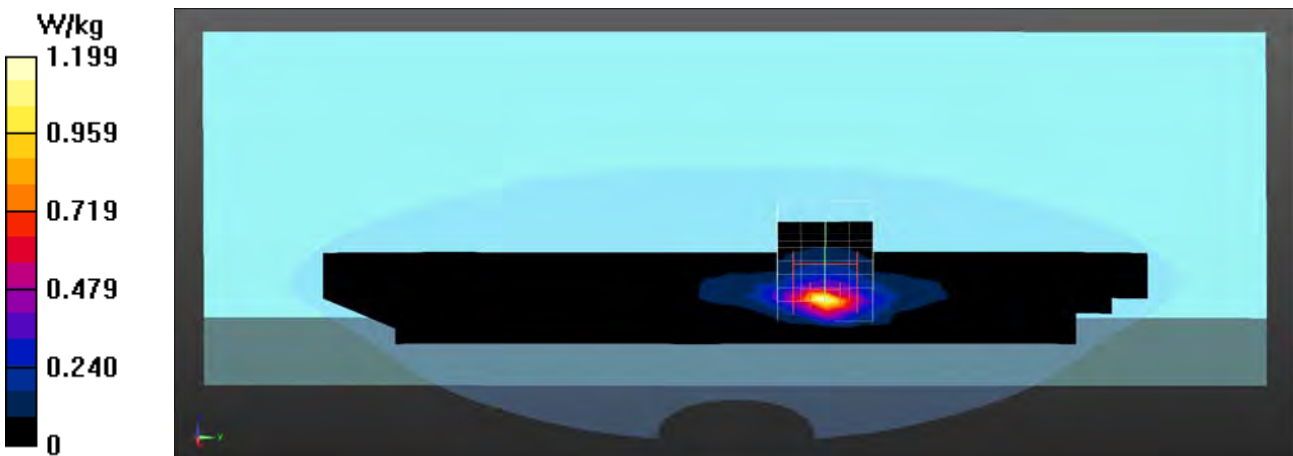

Test Laboratory: DEKRA

Date/Time: 2019/02/21

802.11b_12-Back(PAD) Aux-INPAQ**DUT: ZenBook; Type: UX562F, RX562F, Q546F**

Communication System: UID 0, WLAN 2.4G; Frequency: 2467 MHz;

Communication System PAR: 0 dB

Medium parameters used: $f = 2467$ MHz; $\sigma = 1.98$ S/m; $\epsilon_r = 51.7$; $\rho = 1000$ kg/m³

Phantom section: Flat Section

Ambient Temperature (°C) : 22.1, Liquid Temperature (°C) : 21.4

Measurement Standard: DASY5 (IEEE/IEC/ANSI C63.19-2011)

DASY5 Configuration:

- Probe: EX3DV4 - SN3979; ConvF(7.5, 7.5, 7.5); Calibrated: 2018/11/22;
- Sensor-Surface: 3mm (Mechanical Surface Detection)
- Electronics: DAE4 Sn1425; Calibrated: 2018/11/16
- Phantom: SAM with left table; Type: SAM;
- Measurement SW: DASY52, Version 52.10 (0); SEMCAD X Version 14.6.10 (7417)

Configuration/Body/Area Scan (7x8x1): Measurement grid: dx=12mm, dy=12mm
Maximum value of SAR (measured) = 1.04 W/kg**Configuration/Body/Zoom Scan (5x5x7) (5x5x7)/Cube 0:** Measurement grid:
dx=8mm, dy=8mm, dz=5mm

Reference Value = 9.119 V/m; Power Drift = 0.03 dB

Peak SAR (extrapolated) = 2.36 W/kg

SAR(1 g) = 0.620 W/kg; SAR(10 g) = 0.250 W/kg

Maximum value of SAR (measured) = 1.39 W/kg

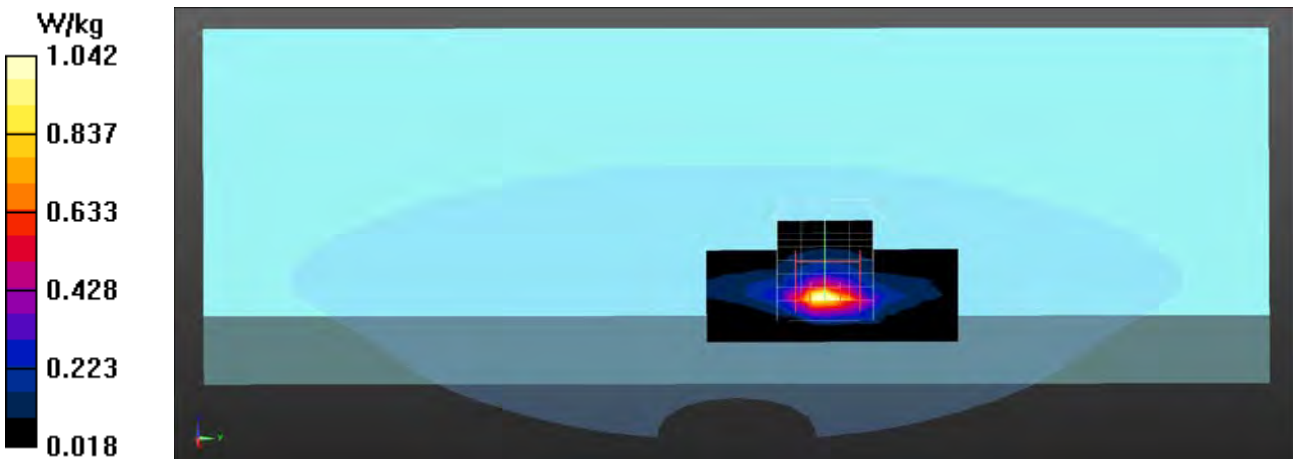

Test Laboratory: DEKRA

Date/Time: 2019/02/21

802.11b_12-Bottom(PAD) Aux-INPAQ**DUT: ZenBook; Type: UX562F, RX562F, Q546F**

Communication System: UID 0, WLAN 2.4G; Frequency: 2467 MHz;

Communication System PAR: 0 dB

Medium parameters used: $f = 2467$ MHz; $\sigma = 1.98$ S/m; $\epsilon_r = 51.7$; $\rho = 1000$ kg/m³

Phantom section: Flat Section

Ambient Temperature (°C) : 22.1, Liquid Temperature (°C) : 21.4

Measurement Standard: DASYS (IEEE/IEC/ANSI C63.19-2011)

DASY5 Configuration:

- Probe: EX3DV4 - SN3979; ConvF(7.5, 7.5, 7.5); Calibrated: 2018/11/22;
- Sensor-Surface: 3mm (Mechanical Surface Detection)
- Electronics: DAE4 Sn1425; Calibrated: 2018/11/16
- Phantom: SAM with left table; Type: SAM;
- Measurement SW: DASYS2, Version 52.10 (0); SEMCAD X Version 14.6.10 (7417)

Configuration/Body/Area Scan (7x26x1): Measurement grid: dx=12mm, dy=12mm
Maximum value of SAR (measured) = 0.335 W/kg**Configuration/Body/Zoom Scan (5x5x7) (5x5x7)/Cube 0:** Measurement grid:
dx=8mm, dy=8mm, dz=5mm

Reference Value = 7.509 V/m; Power Drift = 0.02 dB

Peak SAR (extrapolated) = 0.618 W/kg

SAR(1 g) = 0.223 W/kg; SAR(10 g) = 0.113 W/kg

Maximum value of SAR (measured) = 0.396 W/kg

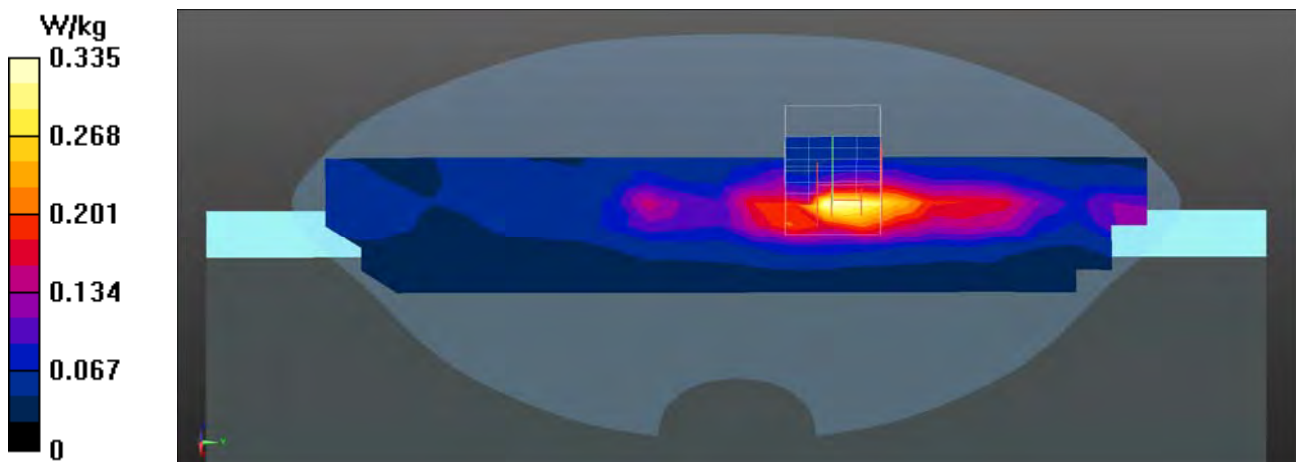

Test Laboratory: DEKRA

Date/Time: 2019/02/21

BT-1M_78-Back(PAD) Aux-INPAQ**DUT: ZenBook; Type: UX562F, RX562F, Q546F**

Communication System: UID 0, BT 1M&3M&BLE; Frequency: 2480 MHz;

Communication System PAR: 0 dB

Medium parameters used: $f = 2480$ MHz; $\sigma = 2.01$ S/m; $\epsilon_r = 51.64$; $\rho = 1000$ kg/m³

Phantom section: Flat Section

Ambient Temperature (°C) : 22.1, Liquid Temperature (°C) : 21.4

Measurement Standard: DASYS (IEEE/IEC/ANSI C63.19-2011)

DASY5 Configuration:

- Probe: EX3DV4 - SN3979; ConvF(7.5, 7.5, 7.5); Calibrated: 2018/11/22;
- Sensor-Surface: 3mm (Mechanical Surface Detection)
- Electronics: DAE4 Sn1425; Calibrated: 2018/11/16
- Phantom: SAM with left table; Type: SAM;
- Measurement SW: DASYS2, Version 52.10 (0); SEMCAD X Version 14.6.10 (7417)

Configuration/Body/Area Scan (7x26x1): Measurement grid: dx=12mm, dy=12mm
Maximum value of SAR (measured) = 0.488 W/kg**Configuration/Body/Zoom Scan (5x5x7) (5x5x7)/Cube 0:** Measurement grid:
dx=8mm, dy=8mm, dz=5mm

Reference Value = 5.503 V/m; Power Drift = 0.03 dB

Peak SAR (extrapolated) = 0.897 W/kg

SAR(1 g) = 0.340 W/kg; SAR(10 g) = 0.143 W/kg

Maximum value of SAR (measured) = 0.492 W/kg

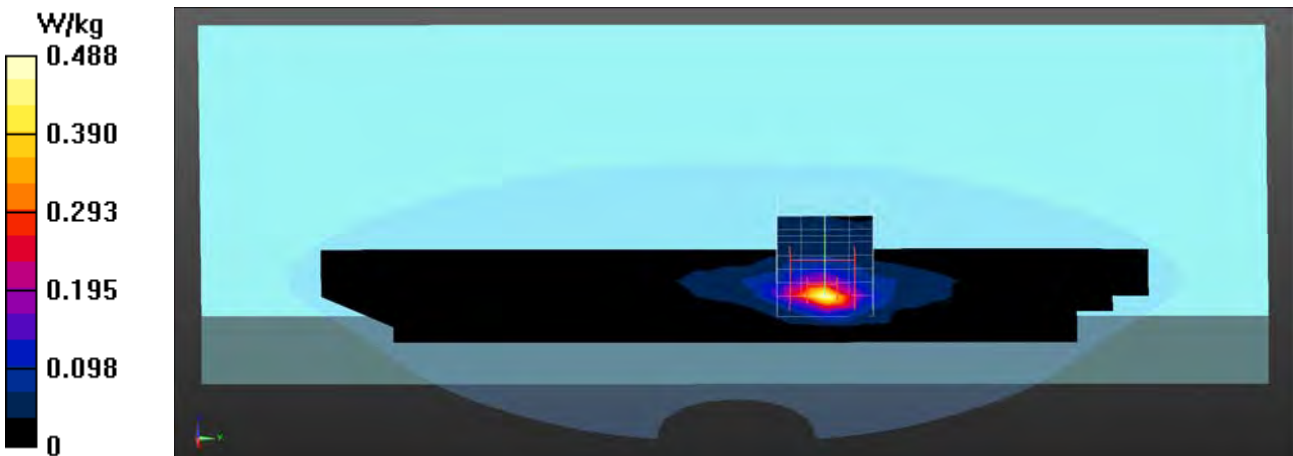

802.11b_Back(PAD) (INPAQ Main Antenna), Z-Axis plot

Channel: 12

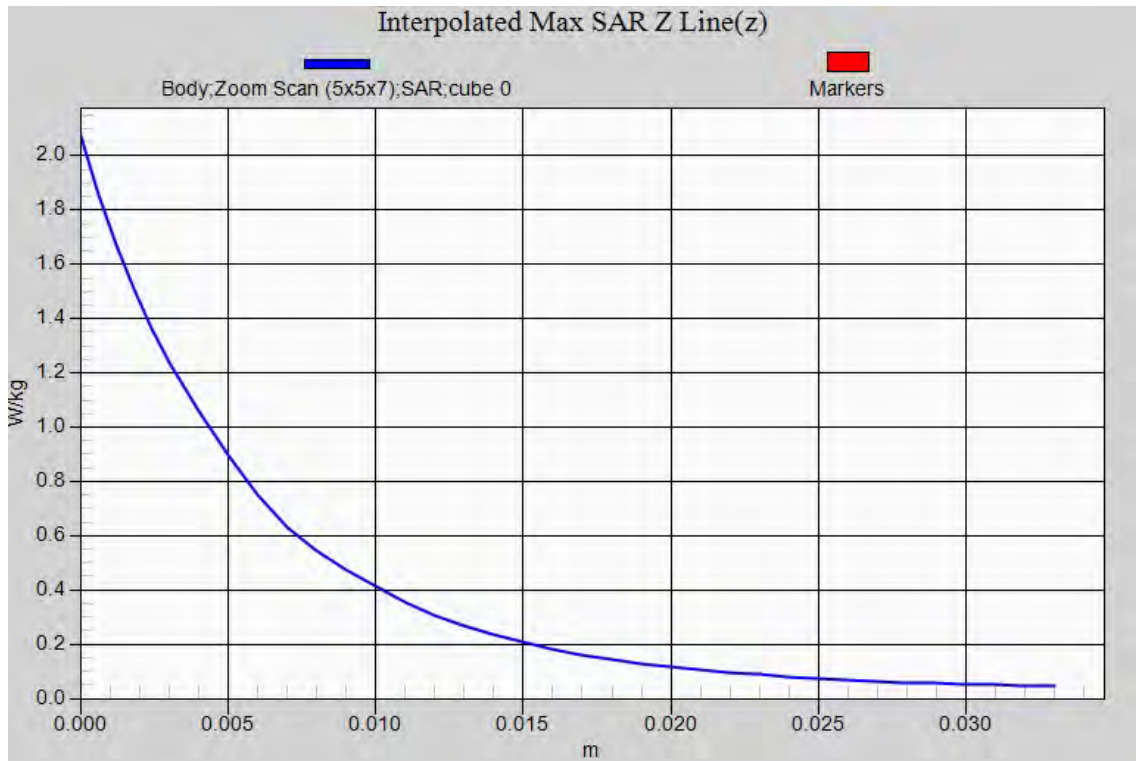

Test Laboratory: DEKRA

Date/Time: 2019/02/22

802.11ac80M_58-Bottom(NB) Main-INPAQ**DUT: ZenBook; Type: UX562F, RX562F, Q546F**

Communication System: UID 0, WLAN 5G; Frequency: 5290 MHz;

Communication System PAR: 0 dB

Medium parameters used: $f = 5290$ MHz; $\sigma = 5.45$ S/m; $\epsilon_r = 49.75$; $\rho = 1000$ kg/m³

Phantom section: Flat Section

Ambient Temperature (°C) : 22.4, Liquid Temperature (°C) : 20.2

Measurement Standard: DASYS (IEEE/IEC/ANSI C63.19-2011)

DASY5 Configuration:

- Probe: EX3DV4 - SN3979; ConvF(4.46, 4.46, 4.46); Calibrated: 2018/11/22;
- Sensor-Surface: 1.4mm (Mechanical Surface Detection)
- Electronics: DAE4 Sn1425; Calibrated: 2018/11/16
- Phantom: SAM with right table; Type: SAM;
- Measurement SW: DASYS2, Version 52.10 (0); SEMCAD X Version 14.6.10 (7417)

Configuration/Body/Area Scan (7x7x1): Measurement grid: dx=10mm, dy=10mm

Maximum value of SAR (measured) = 1.19 W/kg

Configuration/Body/Zoom Scan (6x6x12) (6x6x12)/Cube 0: Measurement grid:

dx=5mm, dy=5mm, dz=2mm

Reference Value = 6.211 V/m; Power Drift = -0.11 dB

Peak SAR (extrapolated) = 2.88 W/kg

SAR(1 g) = 0.682 W/kg; SAR(10 g) = 0.328 W/kg

Maximum value of SAR (measured) = 1.39 W/kg

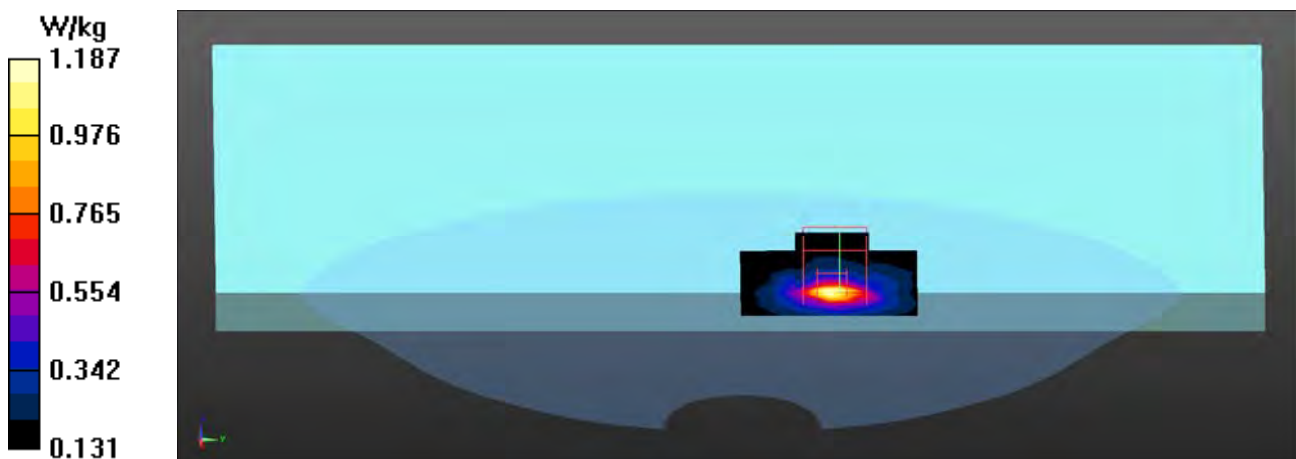

Test Laboratory: DEKRA

Date/Time: 2019/02/22

802.11ac80M_106-Bottom(NB) Main-INPAQ**DUT: ZenBook; Type: UX562F, RX562F, Q546F**

Communication System: UID 0, WLAN 5G; Frequency: 5530 MHz;

Communication System PAR: 0 dB

Medium parameters used: $f = 5530$ MHz; $\sigma = 5.82$ S/m; $\epsilon_r = 49.1$; $\rho = 1000$ kg/m³

Phantom section: Flat Section

Ambient Temperature (°C) : 22.4, Liquid Temperature (°C) : 20.2

Measurement Standard: DASYS (IEEE/IEC/ANSI C63.19-2011)

DASY5 Configuration:

- Probe: EX3DV4 - SN3979; ConvF(3.92, 3.92, 3.92); Calibrated: 2018/11/22;
- Sensor-Surface: 1.4mm (Mechanical Surface Detection)
- Electronics: DAE4 Sn1425; Calibrated: 2018/11/16
- Phantom: SAM with right table; Type: SAM;
- Measurement SW: DASYS2, Version 52.10 (0); SEMCAD X Version 14.6.10 (7417)

Configuration/Body/Area Scan (7x37x1): Measurement grid: dx=10mm, dy=10mm
Maximum value of SAR (measured) = 2.17 W/kg**Configuration/Body/Zoom Scan (6x6x12) (6x6x12)/Cube 0:** Measurement grid:
dx=5mm, dy=5mm, dz=2mm

Reference Value = 6.923 V/m; Power Drift = -0.08 dB

Peak SAR (extrapolated) = 5.35 W/kg

SAR(1 g) = 1.08 W/kg; SAR(10 g) = 0.472 W/kg

Maximum value of SAR (measured) = 2.46 W/kg

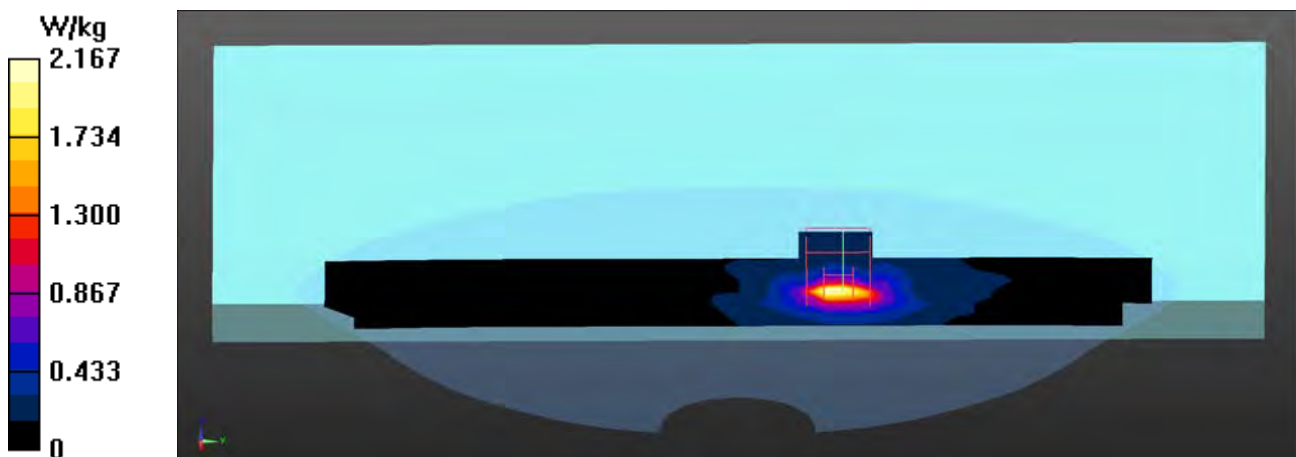

Test Laboratory: DEKRA

Date/Time: 2019/02/22

802.11ac80M_122-Bottom(NB) Main-INPAQ**DUT: ZenBook; Type: UX562F, RX562F, Q546F**

Communication System: UID 0, WLAN 5G; Frequency: 5610 MHz;

Communication System PAR: 0 dB

Medium parameters used: $f = 5610$ MHz; $\sigma = 5.94$ S/m; $\epsilon_r = 48.87$; $\rho = 1000$ kg/m³

Phantom section: Flat Section

Ambient Temperature (°C) : 22.4, Liquid Temperature (°C) : 20.2

Measurement Standard: DASYS (IEEE/IEC/ANSI C63.19-2011)

DASY5 Configuration:

- Probe: EX3DV4 - SN3979; ConvF(3.92, 3.92, 3.92); Calibrated: 2018/11/22;
- Sensor-Surface: 1.4mm (Mechanical Surface Detection)
- Electronics: DAE4 Sn1425; Calibrated: 2018/11/16
- Phantom: SAM with right table; Type: SAM;
- Measurement SW: DASYS2, Version 52.10 (0); SEMCAD X Version 14.6.10 (7417)

Configuration/Body/Area Scan (7x9x1): Measurement grid: dx=10mm, dy=10mm

Maximum value of SAR (measured) = 2.05 W/kg

Configuration/Body/Zoom Scan (6x6x12) (6x6x12)/Cube 0: Measurement grid:

dx=5mm, dy=5mm, dz=2mm

Reference Value = 6.701 V/m; Power Drift = 0.05 dB

Peak SAR (extrapolated) = 5.63 W/kg

SAR(1 g) = 1.07 W/kg; SAR(10 g) = 0.459 W/kg

Maximum value of SAR (measured) = 2.24 W/kg

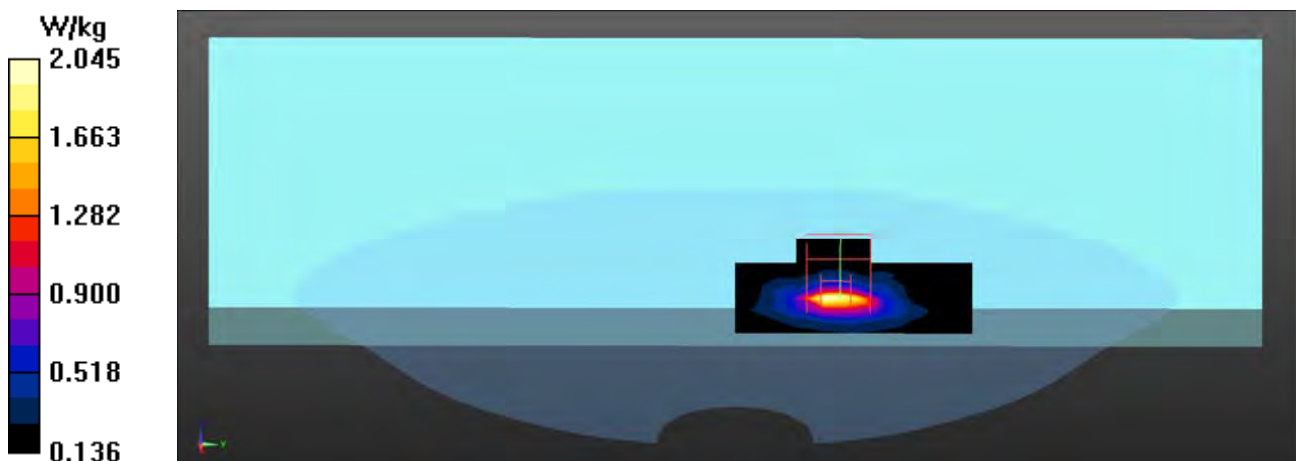

Test Laboratory: DEKRA

Date/Time: 2019/02/22

802.11ac80M_138-Bottom(NB) Main-INPAQ

DUT: ZenBook; Type: UX562F, RX562F, Q546F

Communication System: UID 0, WLAN 5G; Frequency: 5690 MHz;

Communication System PAR: 0 dB

Medium parameters used: $f = 5690 \text{ MHz}$; $\sigma = 6.05 \text{ S/m}$; $\epsilon_r = 48.66$; $\rho = 1000 \text{ kg/m}^3$

Phantom section: Flat Section

Ambient Temperature ($^{\circ}\text{C}$) : 22.4, Liquid Temperature ($^{\circ}\text{C}$) : 20.2

Measurement Standard: DASYS (IEEE/IEC/ANSI C63.19-2011)

DASY5 Configuration:

- Probe: EX3DV4 - SN3979; ConvF(3.92, 3.92, 3.92); Calibrated: 2018/11/22;
- Sensor-Surface: 1.4mm (Mechanical Surface Detection)
- Electronics: DAE4 Sn1425; Calibrated: 2018/11/16
- Phantom: SAM with right table; Type: SAM;
- Measurement SW: DASYS2, Version 52.10 (0); SEMCAD X Version 14.6.10 (7417)

Configuration/Body/Area Scan (7x8x1): Measurement grid: $dx=10\text{mm}$, $dy=10\text{mm}$

Maximum value of SAR (measured) = 1.99 W/kg

Configuration/Body/Zoom Scan (6x6x12) (6x6x12)/Cube 0: Measurement grid:

$dx=5\text{mm}$, $dy=5\text{mm}$, $dz=2\text{mm}$

Reference Value = 6.877 V/m; Power Drift = 0.05 dB

Peak SAR (extrapolated) = 6.23 W/kg

SAR(1 g) = 1.03 W/kg; SAR(10 g) = 0.444 W/kg

Maximum value of SAR (measured) = 2.10 W/kg

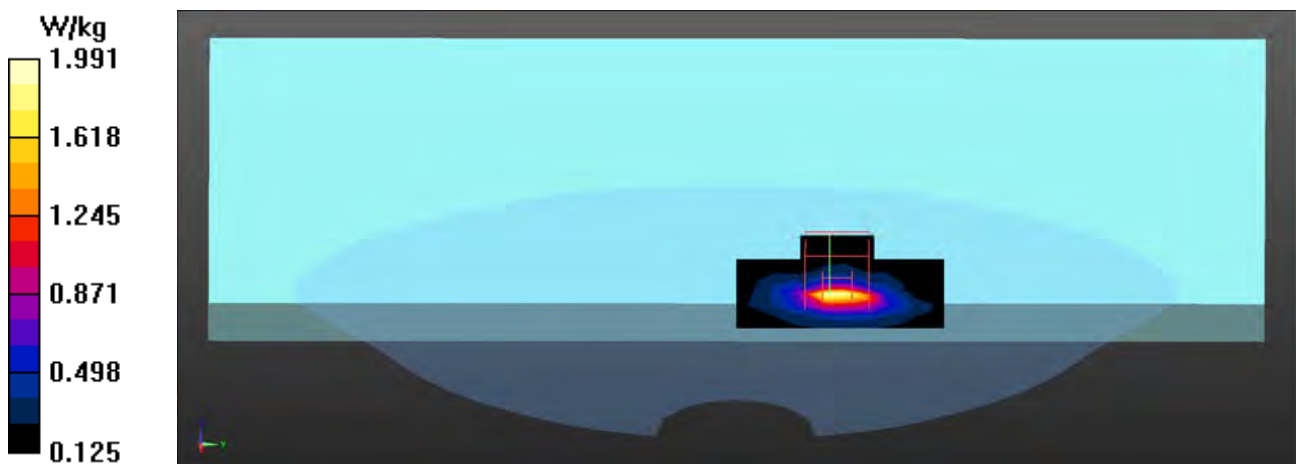

Test Laboratory: DEKRA

Date/Time: 2019/02/22

802.11ac80M_155-Bottom(NB) Main-INPAQ**DUT: ZenBook; Type: UX562F, RX562F, Q546F**

Communication System: UID 0, WLAN 5G; Frequency: 5775 MHz;

Communication System PAR: 0 dB

Medium parameters used: $f = 5775$ MHz; $\sigma = 6.21$ S/m; $\epsilon_r = 48.44$; $\rho = 1000$ kg/m³

Phantom section: Flat Section

Ambient Temperature (°C) : 22.4, Liquid Temperature (°C) : 20.2

Measurement Standard: DASYS (IEEE/IEC/ANSI C63.19-2011)

DASY5 Configuration:

- Probe: EX3DV4 - SN3979; ConvF(4.2, 4.2, 4.2); Calibrated: 2018/11/22;
- Sensor-Surface: 1.4mm (Mechanical Surface Detection)
- Electronics: DAE4 Sn1425; Calibrated: 2018/11/16
- Phantom: SAM with right table; Type: SAM;
- Measurement SW: DASY52, Version 52.10 (0); SEMCAD X Version 14.6.10 (7417)

Configuration/Body/Area Scan (7x9x1): Measurement grid: dx=10mm, dy=10mm

Maximum value of SAR (measured) = 1.71 W/kg

Configuration/Body/Zoom Scan (6x6x12) (6x6x12)/Cube 0: Measurement grid:

dx=5mm, dy=5mm, dz=2mm

Reference Value = 6.954 V/m; Power Drift = 0.15 dB

Peak SAR (extrapolated) = 4.38 W/kg

SAR(1 g) = 0.863 W/kg; SAR(10 g) = 0.373 W/kg

Maximum value of SAR (measured) = 1.77 W/kg

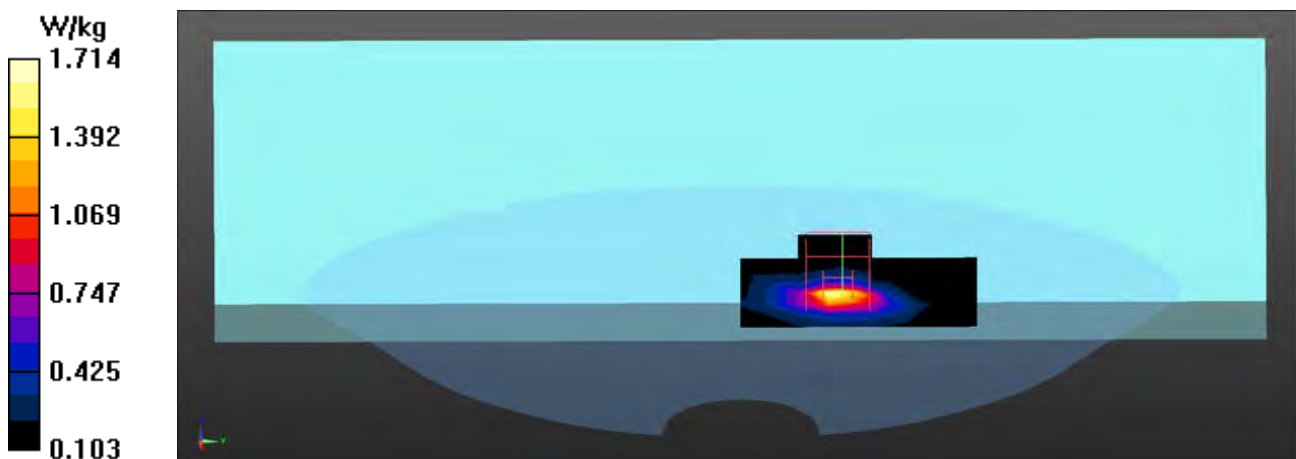

Test Laboratory: DEKRA

Date/Time: 2019/02/22

802.11ac80M_58-Back(PAD) Main-INPAQ**DUT: ZenBook; Type: UX562F, RX562F, Q546F**

Communication System: UID 0, WLAN 5G; Frequency: 5290 MHz;

Communication System PAR: 0 dB

Medium parameters used: $f = 5290$ MHz; $\sigma = 5.45$ S/m; $\epsilon_r = 49.75$; $\rho = 1000$ kg/m³

Phantom section: Flat Section

Ambient Temperature (°C) : 22.4, Liquid Temperature (°C) : 20.2

Measurement Standard: DASYS (IEEE/IEC/ANSI C63.19-2011)

DASY5 Configuration:

- Probe: EX3DV4 - SN3979; ConvF(4.46, 4.46, 4.46); Calibrated: 2018/11/22;
- Sensor-Surface: 1.4mm (Mechanical Surface Detection)
- Electronics: DAE4 Sn1425; Calibrated: 2018/11/16
- Phantom: SAM with right table; Type: SAM;
- Measurement SW: DASYS2, Version 52.10 (0); SEMCAD X Version 14.6.10 (7417)

Configuration/Body/Area Scan (7x8x1): Measurement grid: dx=10mm, dy=10mm

Maximum value of SAR (measured) = 0.993 W/kg

Configuration/Body/Zoom Scan (6x6x12) (6x6x12)/Cube 0: Measurement grid:

dx=5mm, dy=5mm, dz=2mm

Reference Value = 4.503 V/m; Power Drift = 0.08 dB

Peak SAR (extrapolated) = 2.20 W/kg

SAR(1 g) = 0.494 W/kg; SAR(10 g) = 0.237 W/kg

Maximum value of SAR (measured) = 0.977 W/kg

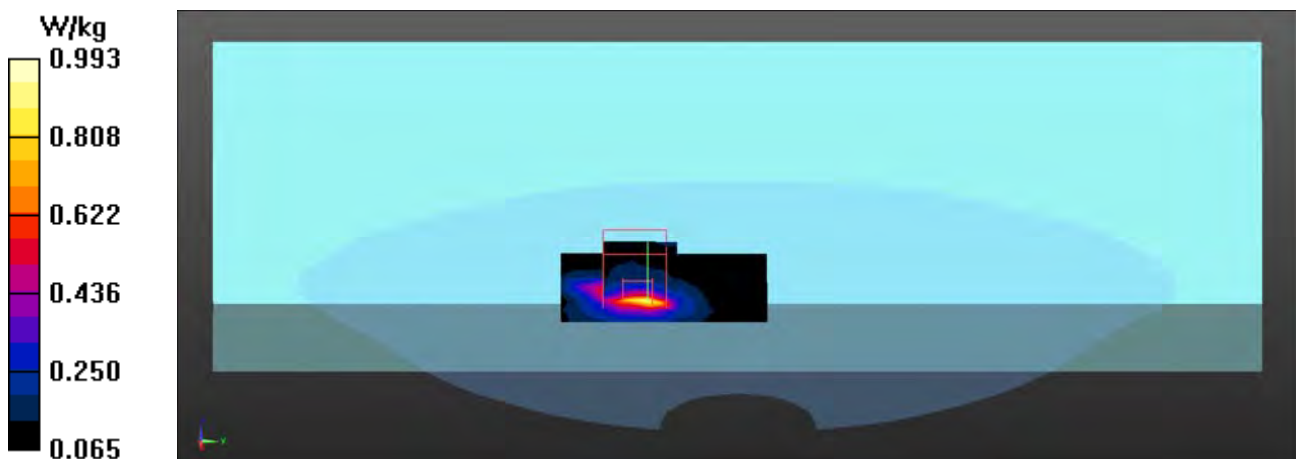

Test Laboratory: DEKRA

Date/Time: 2019/02/22

802.11ac80M_106-Back(PAD) Main-INPAQ**DUT: ZenBook; Type: UX562F, RX562F, Q546F**

Communication System: UID 0, WLAN 5G; Frequency: 5530 MHz;

Communication System PAR: 0 dB

Medium parameters used: $f = 5530$ MHz; $\sigma = 5.82$ S/m; $\epsilon_r = 49.1$; $\rho = 1000$ kg/m³

Phantom section: Flat Section

Ambient Temperature (°C) : 22.4, Liquid Temperature (°C) : 20.2

Measurement Standard: DASYS (IEEE/IEC/ANSI C63.19-2011)

DASY5 Configuration:

- Probe: EX3DV4 - SN3979; ConvF(3.92, 3.92, 3.92); Calibrated: 2018/11/22;
- Sensor-Surface: 1.4mm (Mechanical Surface Detection)
- Electronics: DAE4 Sn1425; Calibrated: 2018/11/16
- Phantom: SAM with right table; Type: SAM;
- Measurement SW: DASYS2, Version 52.10 (0); SEMCAD X Version 14.6.10 (7417)

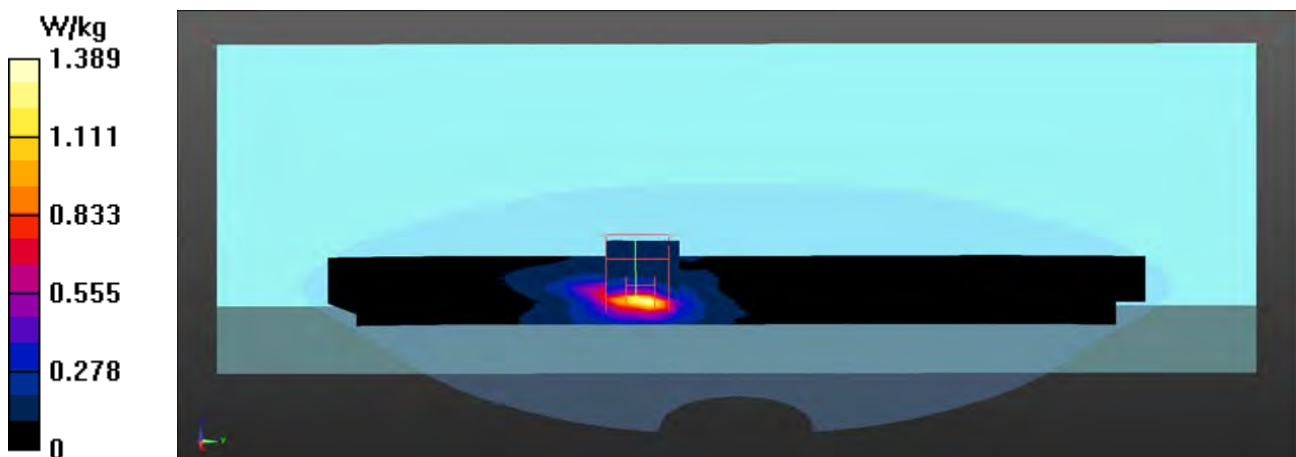
Configuration/Body/Area Scan (7x37x1): Measurement grid: dx=10mm, dy=10mm
Maximum value of SAR (measured) = 1.39 W/kg**Configuration/Body/Zoom Scan (6x6x12) (6x6x12)/Cube 0:** Measurement grid:
dx=5mm, dy=5mm, dz=2mm
Reference Value = 4.642 V/m; Power Drift = 0.03 dB
Peak SAR (extrapolated) = 3.33 W/kg
SAR(1 g) = 0.651 W/kg; SAR(10 g) = 0.291 W/kg
Maximum value of SAR (measured) = 1.46 W/kg

Test Laboratory: DEKRA

Date/Time: 2019/02/22

802.11ac80M_155-Back(PAD) Main-INPAQ**DUT: ZenBook; Type: UX562F, RX562F, Q546F**

Communication System: UID 0, WLAN 5G; Frequency: 5775 MHz;

Communication System PAR: 0 dB

Medium parameters used: $f = 5775$ MHz; $\sigma = 6.21$ S/m; $\epsilon_r = 48.44$; $\rho = 1000$ kg/m³

Phantom section: Flat Section

Ambient Temperature (°C) : 22.4, Liquid Temperature (°C) : 20.2

Measurement Standard: DASYS (IEEE/IEC/ANSI C63.19-2011)

DASY5 Configuration:

- Probe: EX3DV4 - SN3979; ConvF(4.2, 4.2, 4.2); Calibrated: 2018/11/22;
- Sensor-Surface: 1.4mm (Mechanical Surface Detection)
- Electronics: DAE4 Sn1425; Calibrated: 2018/11/16
- Phantom: SAM with right table; Type: SAM;
- Measurement SW: DASYS2, Version 52.10 (0); SEMCAD X Version 14.6.10 (7417)

Configuration/Body/Area Scan (7x8x1): Measurement grid: dx=10mm, dy=10mm

Maximum value of SAR (measured) = 1.17 W/kg

Configuration/Body/Zoom Scan (6x6x12) (6x6x12)/Cube 0: Measurement grid:

dx=5mm, dy=5mm, dz=2mm

Reference Value = 4.981 V/m; Power Drift = -0.14 dB

Peak SAR (extrapolated) = 3.01 W/kg

SAR(1 g) = 0.533 W/kg; SAR(10 g) = 0.266 W/kg

Maximum value of SAR (measured) = 1.12 W/kg

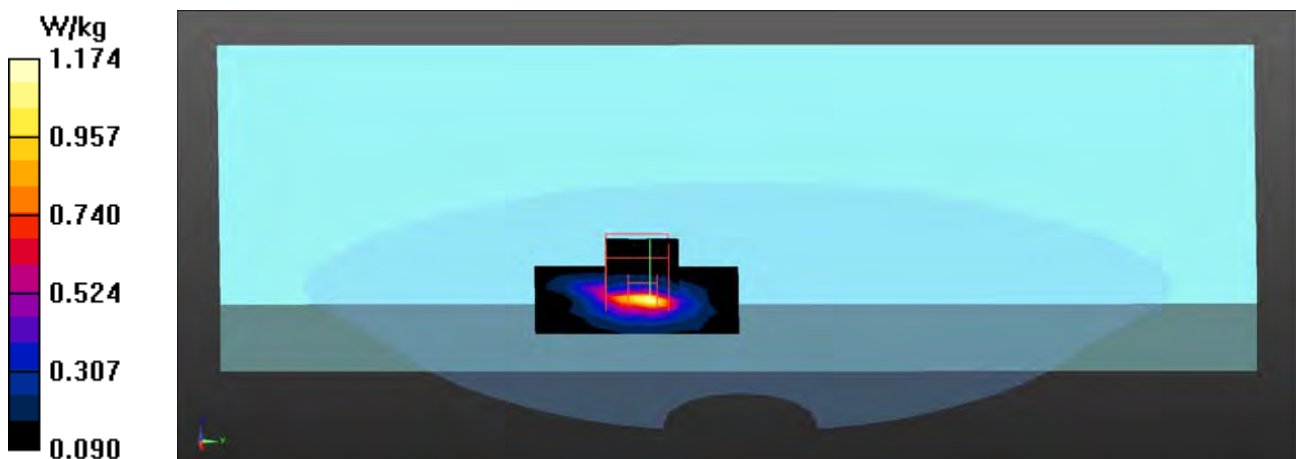

Test Laboratory: DEKRA

Date/Time: 2019/02/22

802.11ac80M_58-Bottom(PAD) Main-INPAQ

DUT: ZenBook; Type: UX562F, RX562F, Q546F

Communication System: UID 0, WLAN 5G; Frequency: 5290 MHz;

Communication System PAR: 0 dB

Medium parameters used: $f = 5290 \text{ MHz}$; $\sigma = 5.45 \text{ S/m}$; $\epsilon_r = 49.75$; $\rho = 1000 \text{ kg/m}^3$

Phantom section: Flat Section

Ambient Temperature ($^{\circ}\text{C}$) : 22.4, Liquid Temperature ($^{\circ}\text{C}$) : 20.2

Measurement Standard: DASYS (IEEE/IEC/ANSI C63.19-2011)

DASY5 Configuration:

- Probe: EX3DV4 - SN3979; ConvF(4.46, 4.46, 4.46); Calibrated: 2018/11/22;
- Sensor-Surface: 1.4mm (Mechanical Surface Detection)
- Electronics: DAE4 Sn1425; Calibrated: 2018/11/16
- Phantom: SAM with right table; Type: SAM;
- Measurement SW: DASYS2, Version 52.10 (0); SEMCAD X Version 14.6.10 (7417)

Configuration/Body/Area Scan (7x8x1): Measurement grid: $dx=10\text{mm}$, $dy=10\text{mm}$

Maximum value of SAR (measured) = 1.51 W/kg

Configuration/Body/Zoom Scan (6x6x12) (6x6x12)/Cube 0: Measurement grid:

$dx=5\text{mm}$, $dy=5\text{mm}$, $dz=2\text{mm}$

Reference Value = 5.763 V/m; Power Drift = 0.15 dB

Peak SAR (extrapolated) = 3.75 W/kg

SAR(1 g) = 0.717 W/kg; SAR(10 g) = 0.305 W/kg

Maximum value of SAR (measured) = 1.64 W/kg

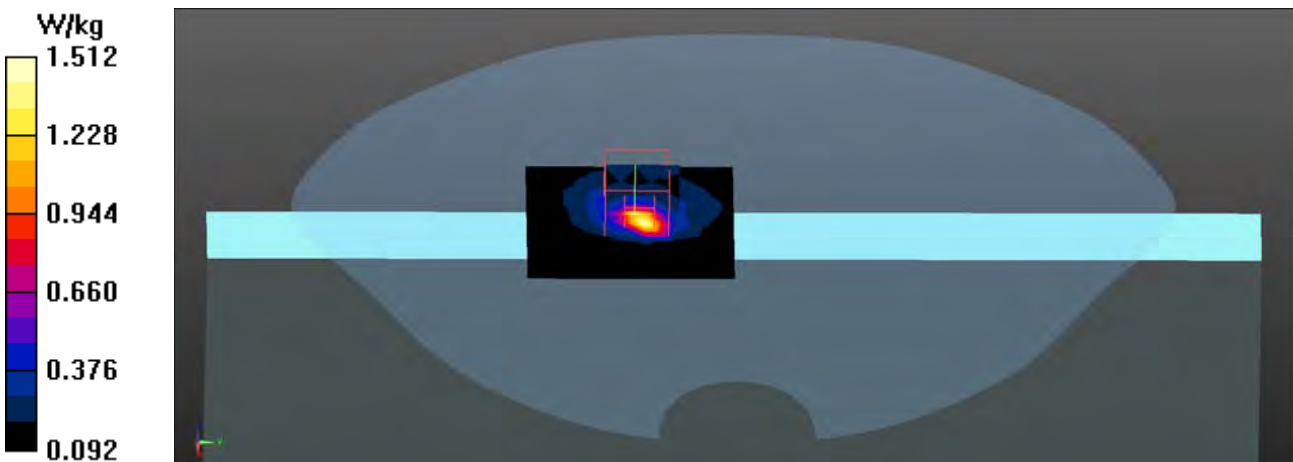

Test Laboratory: DEKRA

Date/Time: 2019/02/22

802.11ac80M_106-Bottom(PAD) Main-INPAQ**DUT: ZenBook; Type: UX562F, RX562F, Q546F**

Communication System: UID 0, WLAN 5G; Frequency: 5530 MHz;

Communication System PAR: 0 dB

Medium parameters used: $f = 5530$ MHz; $\sigma = 5.82$ S/m; $\epsilon_r = 49.1$; $\rho = 1000$ kg/m³

Phantom section: Flat Section

Ambient Temperature (°C) : 22.4, Liquid Temperature (°C) : 20.2

Measurement Standard: DASYS (IEEE/IEC/ANSI C63.19-2011)

DASY5 Configuration:

- Probe: EX3DV4 - SN3979; ConvF(3.92, 3.92, 3.92); Calibrated: 2018/11/22;
- Sensor-Surface: 1.4mm (Mechanical Surface Detection)
- Electronics: DAE4 Sn1425; Calibrated: 2018/11/16
- Phantom: SAM with right table; Type: SAM;
- Measurement SW: DASYS2, Version 52.10 (0); SEMCAD X Version 14.6.10 (7417)

Configuration/Body/Area Scan (7x8x1): Measurement grid: dx=10mm, dy=10mm

Maximum value of SAR (measured) = 2.78 W/kg

Configuration/Body/Zoom Scan (6x6x12) (6x6x12)/Cube 0: Measurement grid:

dx=5mm, dy=5mm, dz=2mm

Reference Value = 5.287 V/m; Power Drift = 0.09 dB

Peak SAR (extrapolated) = 5.66 W/kg

SAR(1 g) = 0.998 W/kg; SAR(10 g) = 0.351 W/kg

Maximum value of SAR (measured) = 2.39 W/kg

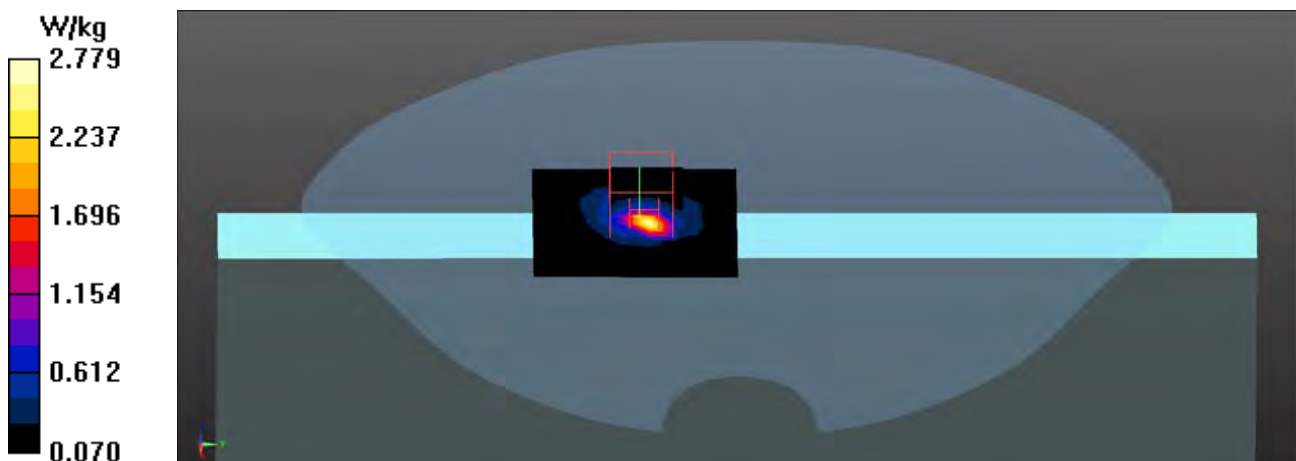

Test Laboratory: DEKRA

Date/Time: 2019/02/22

802.11ac80M_122-Bottom(PAD) Main-INPAQ

DUT: ZenBook; Type: UX562F, RX562F, Q546F

Communication System: UID 0, WLAN 5G; Frequency: 5610 MHz;

Communication System PAR: 0 dB

Medium parameters used: $f = 5610 \text{ MHz}$; $\sigma = 5.94 \text{ S/m}$; $\epsilon_r = 48.87$; $\rho = 1000 \text{ kg/m}^3$

Phantom section: Flat Section

Ambient Temperature ($^{\circ}\text{C}$) : 22.4, Liquid Temperature ($^{\circ}\text{C}$) : 20.2

Measurement Standard: DASYS (IEEE/IEC/ANSI C63.19-2011)

DASY5 Configuration:

- Probe: EX3DV4 - SN3979; ConvF(3.92, 3.92, 3.92); Calibrated: 2018/11/22;
- Sensor-Surface: 1.4mm (Mechanical Surface Detection)
- Electronics: DAE4 Sn1425; Calibrated: 2018/11/16
- Phantom: SAM with right table; Type: SAM;
- Measurement SW: DASYS2, Version 52.10 (0); SEMCAD X Version 14.6.10 (7417)

Configuration/Body/Area Scan (7x37x1): Measurement grid: $dx=10\text{mm}$, $dy=10\text{mm}$
 Maximum value of SAR (measured) = 1.70 W/kg

Configuration/Body/Zoom Scan (6x6x12) (6x6x12)/Cube 0: Measurement grid:
 $dx=5\text{mm}$, $dy=5\text{mm}$, $dz=2\text{mm}$
 Reference Value = 5.556 V/m; Power Drift = 0.02 dB
 Peak SAR (extrapolated) = 6.70 W/kg
SAR(1 g) = 1.05 W/kg; SAR(10 g) = 0.383 W/kg
 Maximum value of SAR (measured) = 2.45 W/kg

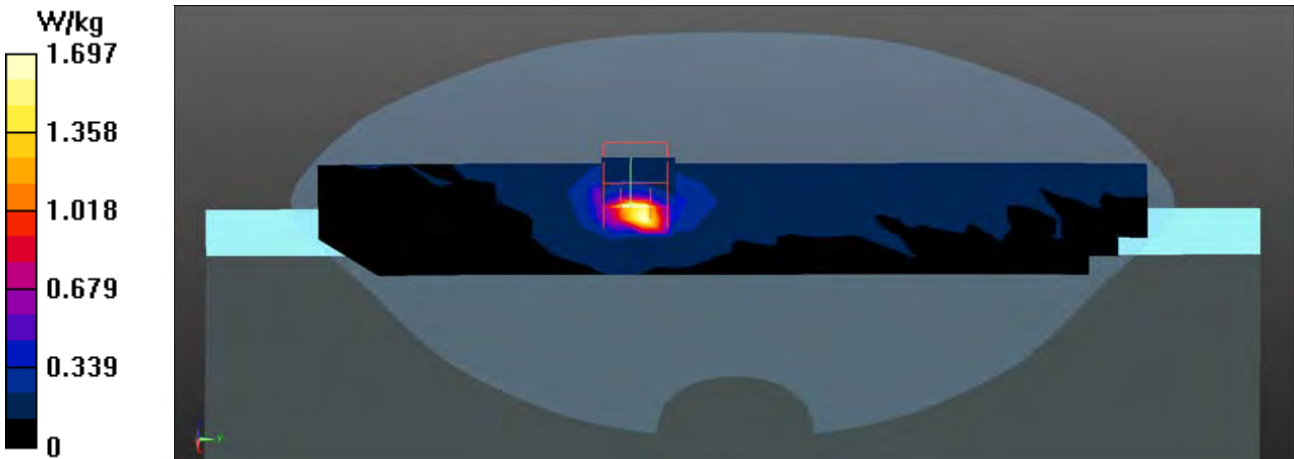

Test Laboratory: DEKRA

Date/Time: 2019/02/22

802.11ac80M_138-Bottom(PAD) Main-INPAQ**DUT: ZenBook; Type: UX562F, RX562F, Q546F**

Communication System: UID 0, WLAN 5G; Frequency: 5690 MHz;

Communication System PAR: 0 dB

Medium parameters used: $f = 5690$ MHz; $\sigma = 6.05$ S/m; $\epsilon_r = 48.66$; $\rho = 1000$ kg/m³

Phantom section: Flat Section

Ambient Temperature (°C) : 22.4, Liquid Temperature (°C) : 20.2

Measurement Standard: DASYS (IEEE/IEC/ANSI C63.19-2011)

DASY5 Configuration:

- Probe: EX3DV4 - SN3979; ConvF(3.92, 3.92, 3.92); Calibrated: 2018/11/22;
- Sensor-Surface: 1.4mm (Mechanical Surface Detection)
- Electronics: DAE4 Sn1425; Calibrated: 2018/11/16
- Phantom: SAM with right table; Type: SAM;
- Measurement SW: DASYS2, Version 52.10 (0); SEMCAD X Version 14.6.10 (7417)

Configuration/Body/Area Scan (7x8x1): Measurement grid: dx=10mm, dy=10mm

Maximum value of SAR (measured) = 2.39 W/kg

Configuration/Body/Zoom Scan (6x6x12) (6x6x12)/Cube 0: Measurement grid:

dx=5mm, dy=5mm, dz=2mm

Reference Value = 5.763 V/m; Power Drift = 0.05 dB

Peak SAR (extrapolated) = 6.37 W/kg

SAR(1 g) = 0.991 W/kg; SAR(10 g) = 0.397 W/kg

Maximum value of SAR (measured) = 2.25 W/kg

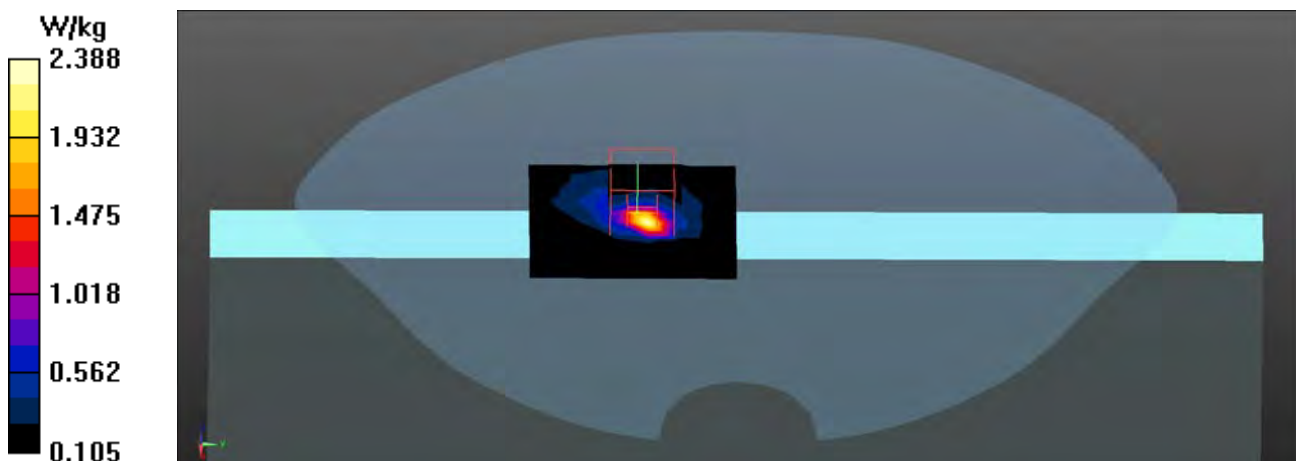

Test Laboratory: DEKRA

Date/Time: 2019/02/22

802.11ac80M_155-Bottom(PAD) Main-INPAQ**DUT: ZenBook; Type: UX562F, RX562F, Q546F**

Communication System: UID 0, WLAN 5G; Frequency: 5775 MHz;

Communication System PAR: 0 dB

Medium parameters used: $f = 5775$ MHz; $\sigma = 6.21$ S/m; $\epsilon_r = 48.44$; $\rho = 1000$ kg/m³

Phantom section: Flat Section

Ambient Temperature (°C) : 22.4, Liquid Temperature (°C) : 20.2

Measurement Standard: DASYS (IEEE/IEC/ANSI C63.19-2011)

DASY5 Configuration:

- Probe: EX3DV4 - SN3979; ConvF(4.2, 4.2, 4.2); Calibrated: 2018/11/22;
- Sensor-Surface: 1.4mm (Mechanical Surface Detection)
- Electronics: DAE4 Sn1425; Calibrated: 2018/11/16
- Phantom: SAM with right table; Type: SAM;
- Measurement SW: DASYS2, Version 52.10 (0); SEMCAD X Version 14.6.10 (7417)

Configuration/Body/Area Scan (7x8x1): Measurement grid: dx=10mm, dy=10mm

Maximum value of SAR (measured) = 1.95 W/kg

Configuration/Body/Zoom Scan (6x6x12) (6x6x12)/Cube 0: Measurement grid:

dx=5mm, dy=5mm, dz=2mm

Reference Value = 5.018 V/m; Power Drift = 0.05 dB

Peak SAR (extrapolated) = 6.04 W/kg

SAR(1 g) = 0.957 W/kg; SAR(10 g) = 0.381 W/kg

Maximum value of SAR (measured) = 2.13 W/kg

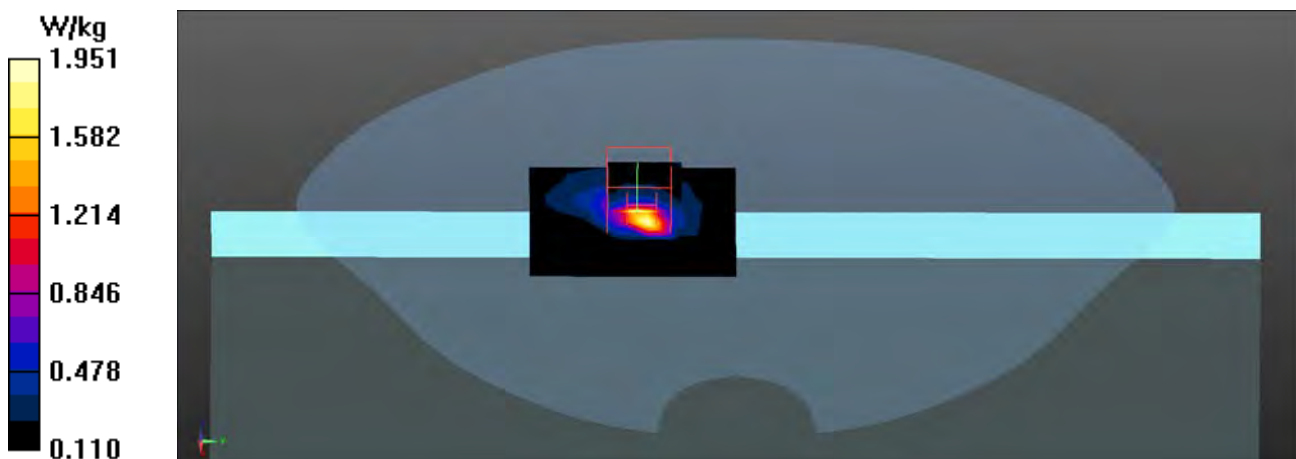

Test Laboratory: DEKRA

Date/Time: 2019/02/22

802.11ac80M_58-Bottom(NB) Aux-INPAQ**DUT: ZenBook; Type: UX562F, RX562F, Q546F**

Communication System: UID 0, WLAN 5G; Frequency: 5290 MHz;

Communication System PAR: 0 dB

Medium parameters used: $f = 5290$ MHz; $\sigma = 5.45$ S/m; $\epsilon_r = 49.75$; $\rho = 1000$ kg/m³

Phantom section: Flat Section

Ambient Temperature (°C) : 22.4, Liquid Temperature (°C) : 20.2

Measurement Standard: DASY5 (IEEE/IEC/ANSI C63.19-2011)

DASY5 Configuration:

- Probe: EX3DV4 - SN3979; ConvF(4.46, 4.46, 4.46); Calibrated: 2018/11/22;
- Sensor-Surface: 1.4mm (Mechanical Surface Detection)
- Electronics: DAE4 Sn1425; Calibrated: 2018/11/16
- Phantom: SAM with right table; Type: SAM;
- Measurement SW: DASY52, Version 52.10 (0); SEMCAD X Version 14.6.10 (7417)

Configuration/Body/Area Scan (7x8x1): Measurement grid: dx=10mm, dy=10mm

Maximum value of SAR (measured) = 0.823 W/kg

Configuration/Body/Zoom Scan (6x6x12) (6x6x12)/Cube 0: Measurement grid:

dx=5mm, dy=5mm, dz=2mm

Reference Value = 5.853 V/m; Power Drift = 0.07 dB

Peak SAR (extrapolated) = 2.38 W/kg

SAR(1 g) = 0.489 W/kg; SAR(10 g) = 0.231 W/kg

Maximum value of SAR (measured) = 0.968 W/kg

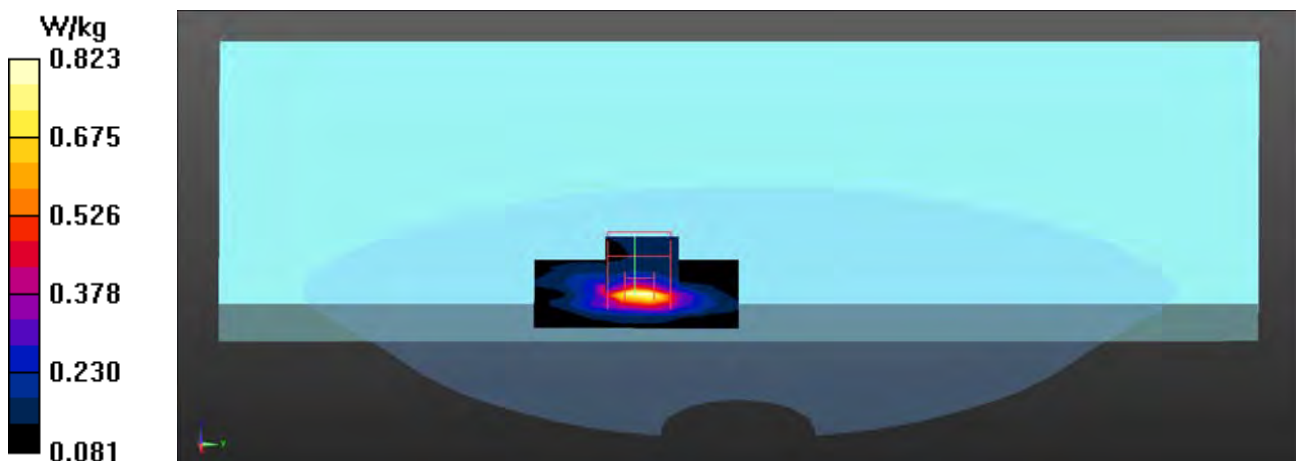

Test Laboratory: DEKRA

Date/Time: 2019/02/22

802.11ac80M_122-Bottom(NB) Aux-INPAQ**DUT: ZenBook; Type: UX562F, RX562F, Q546F**

Communication System: UID 0, WLAN 5G; Frequency: 5610 MHz;

Communication System PAR: 0 dB

Medium parameters used: $f = 5610$ MHz; $\sigma = 5.94$ S/m; $\epsilon_r = 48.87$; $\rho = 1000$ kg/m³

Phantom section: Flat Section

Ambient Temperature (°C) : 22.4, Liquid Temperature (°C) : 20.2

Measurement Standard: DASYS (IEEE/IEC/ANSI C63.19-2011)

DASY5 Configuration:

- Probe: EX3DV4 - SN3979; ConvF(3.92, 3.92, 3.92); Calibrated: 2018/11/22;
- Sensor-Surface: 1.4mm (Mechanical Surface Detection)
- Electronics: DAE4 Sn1425; Calibrated: 2018/11/16
- Phantom: SAM with right table; Type: SAM;
- Measurement SW: DASY52, Version 52.10 (0); SEMCAD X Version 14.6.10 (7417)

Configuration/Body/Area Scan (7x37x1): Measurement grid: dx=10mm, dy=10mm
Maximum value of SAR (measured) = 1.26 W/kg**Configuration/Body/Zoom Scan (6x6x12) (6x6x12)/Cube 0:** Measurement grid:
dx=5mm, dy=5mm, dz=2mm

Reference Value = 7.137 V/m; Power Drift = 0.11 dB

Peak SAR (extrapolated) = 3.85 W/kg

SAR(1 g) = 0.703 W/kg; SAR(10 g) = 0.326 W/kg

Maximum value of SAR (measured) = 1.39 W/kg

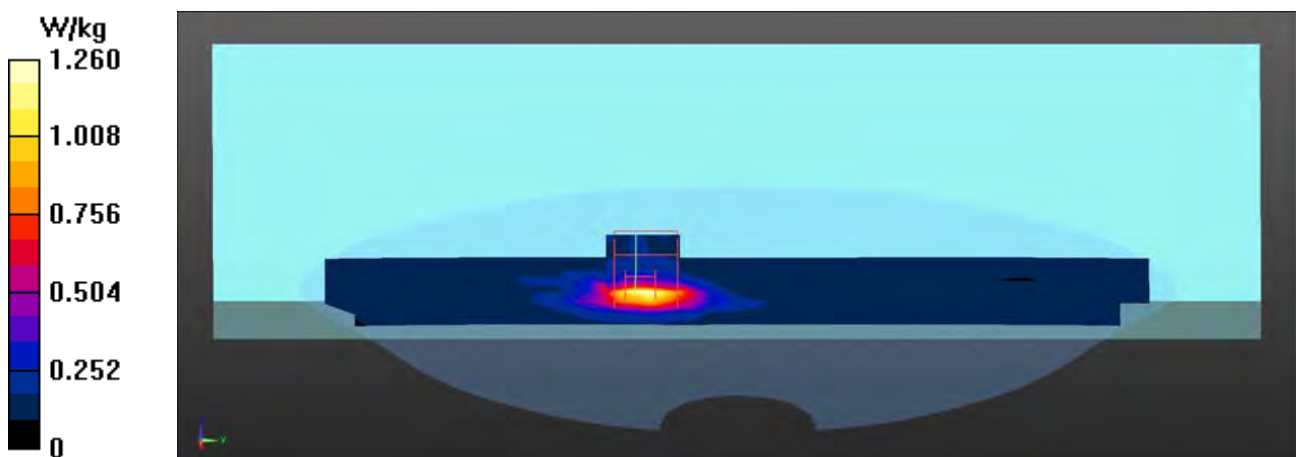

Test Laboratory: DEKRA

Date/Time: 2019/02/22

802.11ac80M_155-Bottom(NB) Aux-INPAQ**DUT: ZenBook; Type: UX562F, RX562F, Q546F**

Communication System: UID 0, WLAN 5G; Frequency: 5775 MHz;

Communication System PAR: 0 dB

Medium parameters used: $f = 5775$ MHz; $\sigma = 6.21$ S/m; $\epsilon_r = 48.44$; $\rho = 1000$ kg/m³

Phantom section: Flat Section

Ambient Temperature (°C) : 22.4, Liquid Temperature (°C) : 20.2

Measurement Standard: DASYS (IEEE/IEC/ANSI C63.19-2011)

DASY5 Configuration:

- Probe: EX3DV4 - SN3979; ConvF(4.2, 4.2, 4.2); Calibrated: 2018/11/22;
- Sensor-Surface: 1.4mm (Mechanical Surface Detection)
- Electronics: DAE4 Sn1425; Calibrated: 2018/11/16
- Phantom: SAM with right table; Type: SAM;
- Measurement SW: DASYS2, Version 52.10 (0); SEMCAD X Version 14.6.10 (7417)

Configuration/Body/Area Scan (7x8x1): Measurement grid: dx=10mm, dy=10mm

Maximum value of SAR (measured) = 1.30 W/kg

Configuration/Body/Zoom Scan (6x6x12) (6x6x12)/Cube 0: Measurement grid:

dx=5mm, dy=5mm, dz=2mm

Reference Value = 7.344 V/m; Power Drift = 0.07 dB

Peak SAR (extrapolated) = 3.28 W/kg

SAR(1 g) = 0.713 W/kg; SAR(10 g) = 0.340 W/kg

Maximum value of SAR (measured) = 1.45 W/kg

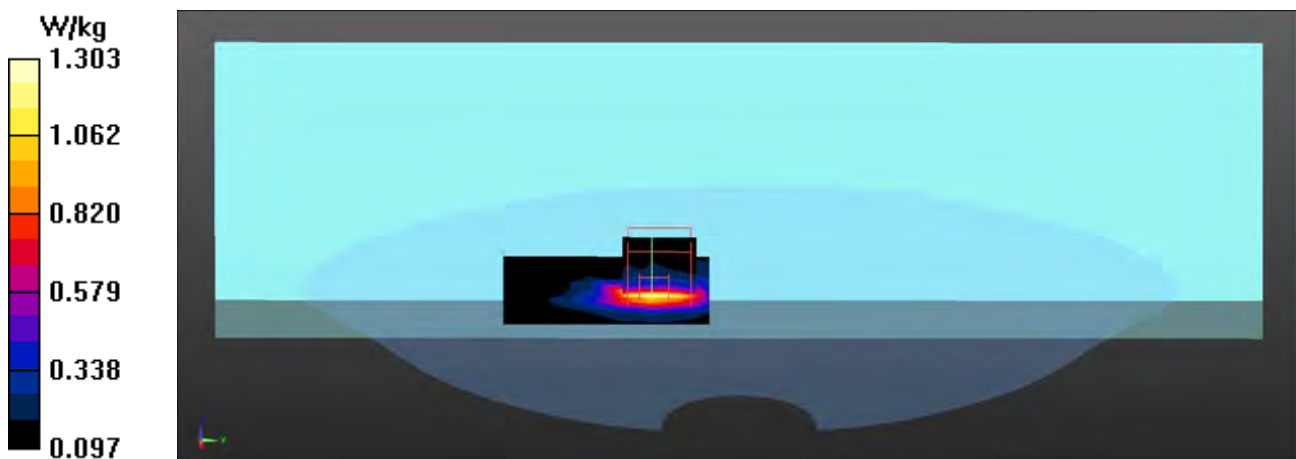

Test Laboratory: DEKRA

Date/Time: 2019/02/22

802.11ac80M_58-Back(PAD) Aux-INPAQ**DUT: ZenBook; Type: UX562F, RX562F, Q546F**

Communication System: UID 0, WLAN 5G; Frequency: 5290 MHz;

Communication System PAR: 0 dB

Medium parameters used: $f = 5290$ MHz; $\sigma = 5.45$ S/m; $\epsilon_r = 49.75$; $\rho = 1000$ kg/m³

Phantom section: Flat Section

Ambient Temperature (°C) : 22.4, Liquid Temperature (°C) : 20.2

Measurement Standard: DASYS (IEEE/IEC/ANSI C63.19-2011)

DASY5 Configuration:

- Probe: EX3DV4 - SN3979; ConvF(4.46, 4.46, 4.46); Calibrated: 2018/11/22;
- Sensor-Surface: 1.4mm (Mechanical Surface Detection)
- Electronics: DAE4 Sn1425; Calibrated: 2018/11/16
- Phantom: SAM with right table; Type: SAM;
- Measurement SW: DASYS2, Version 52.10 (0); SEMCAD X Version 14.6.10 (7417)

Configuration/Body/Area Scan (7x8x1): Measurement grid: dx=10mm, dy=10mm

Maximum value of SAR (measured) = 1.13 W/kg

Configuration/Body/Zoom Scan (6x6x12) (6x6x12)/Cube 0: Measurement grid:

dx=5mm, dy=5mm, dz=2mm

Reference Value = 4.999 V/m; Power Drift = 0.14 dB

Peak SAR (extrapolated) = 2.66 W/kg

SAR(1 g) = 0.530 W/kg; SAR(10 g) = 0.244 W/kg

Maximum value of SAR (measured) = 1.15 W/kg

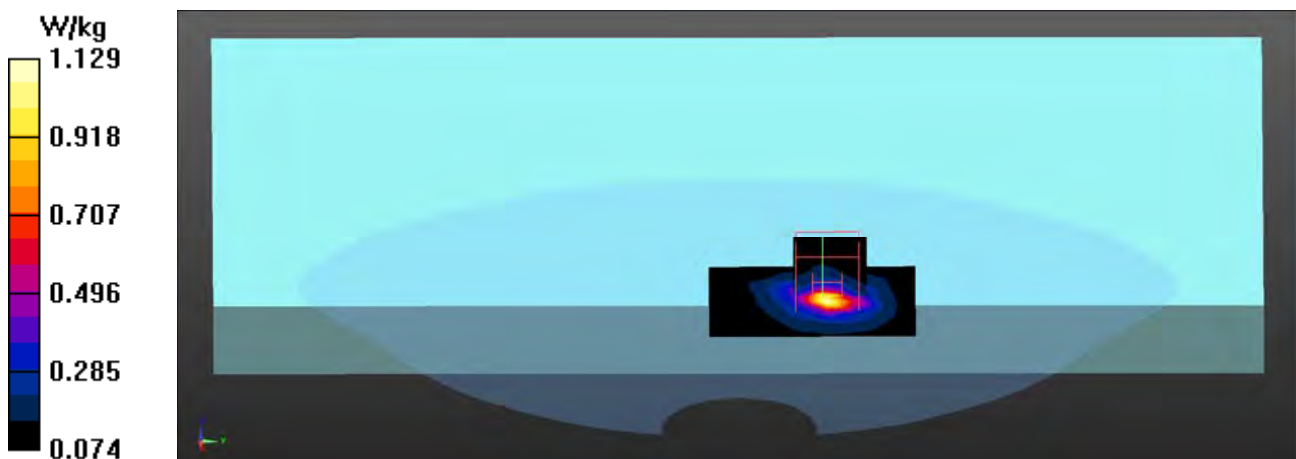

Test Laboratory: DEKRA

Date/Time: 2019/02/22

802.11ac80M_106-Back(PAD) Aux-INPAQ**DUT: ZenBook; Type: UX562F, RX562F, Q546F**

Communication System: UID 0, WLAN 5G; Frequency: 5530 MHz;

Communication System PAR: 0 dB

Medium parameters used: $f = 5530$ MHz; $\sigma = 5.82$ S/m; $\epsilon_r = 49.1$; $\rho = 1000$ kg/m³

Phantom section: Flat Section

Ambient Temperature (°C) : 22.4, Liquid Temperature (°C) : 20.2

Measurement Standard: DASYS (IEEE/IEC/ANSI C63.19-2011)

DASY5 Configuration:

- Probe: EX3DV4 - SN3979; ConvF(3.92, 3.92, 3.92); Calibrated: 2018/11/22;
- Sensor-Surface: 1.4mm (Mechanical Surface Detection)
- Electronics: DAE4 Sn1425; Calibrated: 2018/11/16
- Phantom: SAM with right table; Type: SAM;
- Measurement SW: DASYS2, Version 52.10 (0); SEMCAD X Version 14.6.10 (7417)

Configuration/Body/Area Scan (7x37x1): Measurement grid: dx=10mm, dy=10mm
Maximum value of SAR (measured) = 0.976 W/kg**Configuration/Body/Zoom Scan (6x6x12) (6x6x12)/Cube 0:** Measurement grid:
dx=5mm, dy=5mm, dz=2mm

Reference Value = 5.107 V/m; Power Drift = 0.11 dB

Peak SAR (extrapolated) = 2.48 W/kg

SAR(1 g) = 0.473 W/kg; SAR(10 g) = 0.235 W/kg

Maximum value of SAR (measured) = 0.971 W/kg

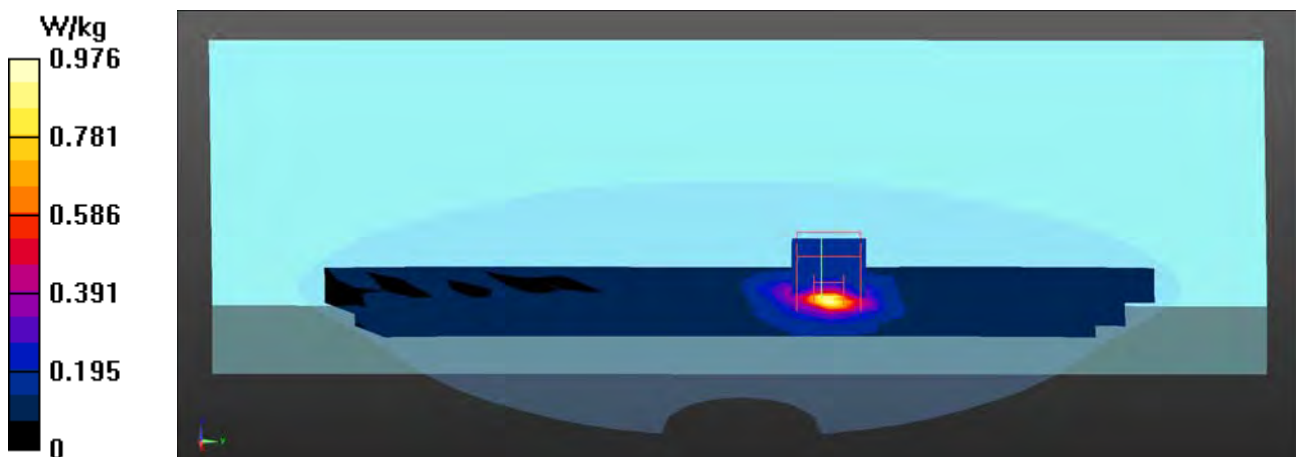

Test Laboratory: DEKRA

Date/Time: 2019/02/22

802.11ac80M_155-Back(PAD) Aux-INPAQ

DUT: ZenBook; Type: UX562F, RX562F, Q546F

Communication System: UID 0, WLAN 5G; Frequency: 5775 MHz;

Communication System PAR: 0 dB

Medium parameters used: $f = 5775 \text{ MHz}$; $\sigma = 6.21 \text{ S/m}$; $\epsilon_r = 48.44$; $\rho = 1000 \text{ kg/m}^3$

Phantom section: Flat Section

Ambient Temperature ($^{\circ}\text{C}$) : 22.4, Liquid Temperature ($^{\circ}\text{C}$) : 20.2

Measurement Standard: DASYS (IEEE/IEC/ANSI C63.19-2011)

DASY5 Configuration:

- Probe: EX3DV4 - SN3979; ConvF(4.2, 4.2, 4.2); Calibrated: 2018/11/22;
- Sensor-Surface: 1.4mm (Mechanical Surface Detection)
- Electronics: DAE4 Sn1425; Calibrated: 2018/11/16
- Phantom: SAM with right table; Type: SAM;
- Measurement SW: DASYS2, Version 52.10 (0); SEMCAD X Version 14.6.10 (7417)

Configuration/Body/Area Scan (7x8x1): Measurement grid: $dx=10\text{mm}$, $dy=10\text{mm}$

Maximum value of SAR (measured) = 1.03 W/kg

Configuration/Body/Zoom Scan (6x6x12) (6x6x12)/Cube 0: Measurement grid:

$dx=5\text{mm}$, $dy=5\text{mm}$, $dz=2\text{mm}$

Reference Value = 5.612 V/m; Power Drift = 0.08 dB

Peak SAR (extrapolated) = 3.22 W/kg

SAR(1 g) = 0.511 W/kg; SAR(10 g) = 0.262 W/kg

Maximum value of SAR (measured) = 1.02 W/kg

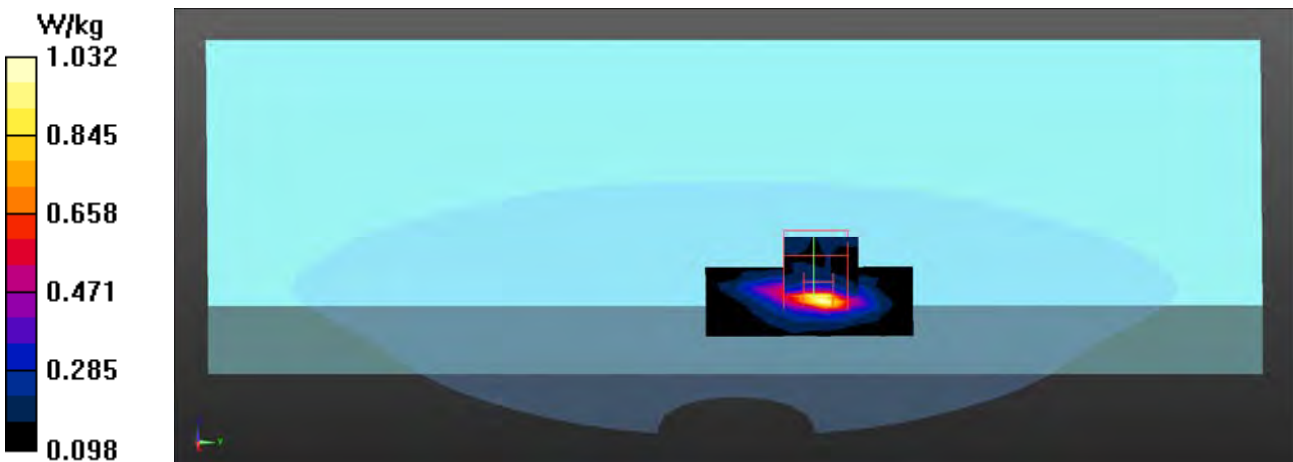

Test Laboratory: DEKRA

Date/Time: 2019/02/22

802.11ac80M_42-Bottom(PAD) Aux-INPAQ**DUT: ZenBook; Type: UX562F, RX562F, Q546F**

Communication System: UID 0, WLAN 5G; Frequency: 5210 MHz;

Communication System PAR: 0 dB

Medium parameters used: $f = 5210$ MHz; $\sigma = 5.33$ S/m; $\epsilon_r = 49.97$; $\rho = 1000$ kg/m³

Phantom section: Flat Section

Ambient Temperature (°C) : 22.4, Liquid Temperature (°C) : 20.2

Measurement Standard: DASYS (IEEE/IEC/ANSI C63.19-2011)

DASY5 Configuration:

- Probe: EX3DV4 - SN3979; ConvF(4.46, 4.46, 4.46); Calibrated: 2018/11/22;
- Sensor-Surface: 1.4mm (Mechanical Surface Detection)
- Electronics: DAE4 Sn1425; Calibrated: 2018/11/16
- Phantom: SAM with right table; Type: SAM;
- Measurement SW: DASYS2, Version 52.10 (0); SEMCAD X Version 14.6.10 (7417)

Configuration/Body/Area Scan (7x8x1): Measurement grid: dx=10mm, dy=10mm

Maximum value of SAR (measured) = 1.16 W/kg

Configuration/Body/Zoom Scan (6x6x12) (6x6x12)/Cube 0: Measurement grid:

dx=5mm, dy=5mm, dz=2mm

Reference Value = 4.033 V/m; Power Drift = 0.11 dB

Peak SAR (extrapolated) = 3.51 W/kg

SAR(1 g) = 0.550 W/kg; SAR(10 g) = 0.212 W/kg

Maximum value of SAR (measured) = 1.11 W/kg

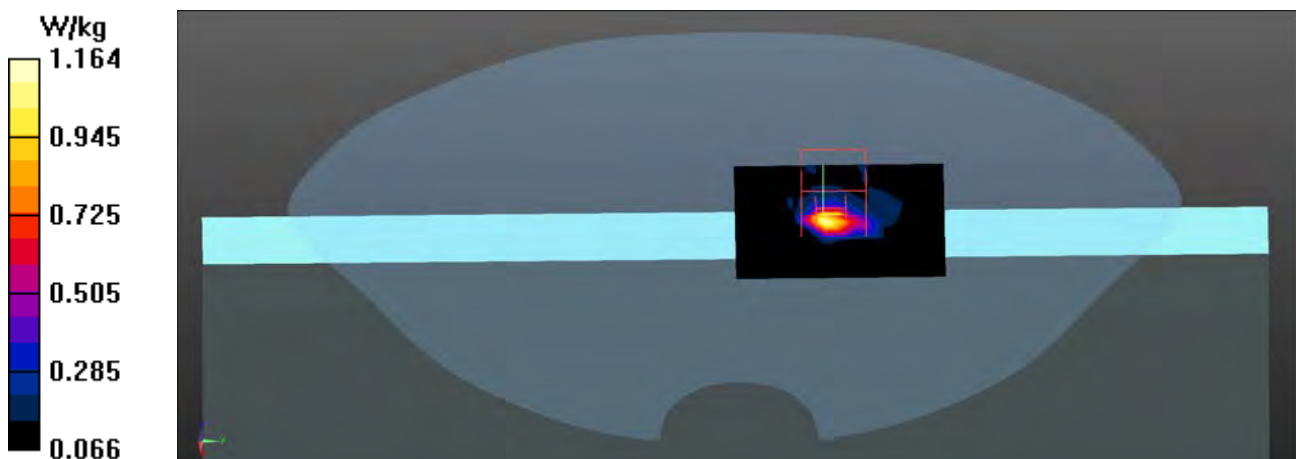

Test Laboratory: DEKRA

Date/Time: 2019/02/22

802.11ac80M_58-Bottom(PAD) Aux-INPAQ

DUT: ZenBook; Type: UX562F, RX562F, Q546F

Communication System: UID 0, WLAN 5G; Frequency: 5290 MHz;

Communication System PAR: 0 dB

Medium parameters used: $f = 5290 \text{ MHz}$; $\sigma = 5.45 \text{ S/m}$; $\epsilon_r = 49.75$; $\rho = 1000 \text{ kg/m}^3$

Phantom section: Flat Section

Ambient Temperature ($^{\circ}\text{C}$) : 22.4, Liquid Temperature ($^{\circ}\text{C}$) : 20.2

Measurement Standard: DASYS (IEEE/IEC/ANSI C63.19-2011)

DASY5 Configuration:

- Probe: EX3DV4 - SN3979; ConvF(4.46, 4.46, 4.46); Calibrated: 2018/11/22;
- Sensor-Surface: 1.4mm (Mechanical Surface Detection)
- Electronics: DAE4 Sn1425; Calibrated: 2018/11/16
- Phantom: SAM with right table; Type: SAM;
- Measurement SW: DASYS2, Version 52.10 (0); SEMCAD X Version 14.6.10 (7417)

Configuration/Body/Area Scan (7x8x1): Measurement grid: $dx=10\text{mm}$, $dy=10\text{mm}$

Maximum value of SAR (measured) = 1.53 W/kg

Configuration/Body/Zoom Scan (6x6x12) (6x6x12)/Cube 0: Measurement grid:

$dx=5\text{mm}$, $dy=5\text{mm}$, $dz=2\text{mm}$

Reference Value = 5.379 V/m; Power Drift = -0.02 dB

Peak SAR (extrapolated) = 4.66 W/kg

SAR(1 g) = 0.805 W/kg; SAR(10 g) = 0.314 W/kg

Maximum value of SAR (measured) = 1.62 W/kg

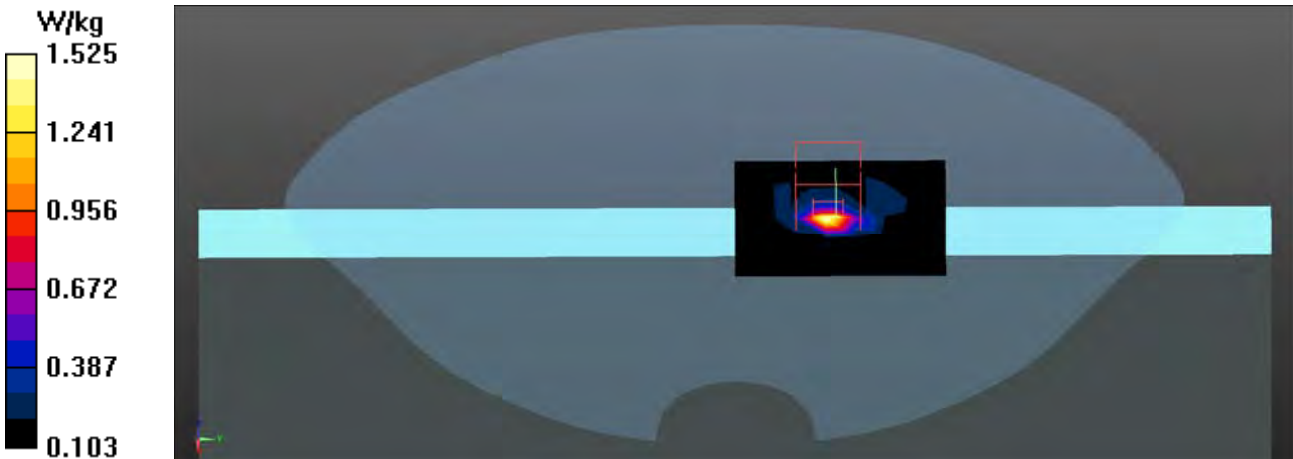

Test Laboratory: DEKRA

Date/Time: 2019/02/22

802.11ac80M_106-Bottom(PAD) Aux-INPAQ**DUT: ZenBook; Type: UX562F, RX562F, Q546F**

Communication System: UID 0, WLAN 5G; Frequency: 5530 MHz;

Communication System PAR: 0 dB

Medium parameters used: $f = 5530$ MHz; $\sigma = 5.82$ S/m; $\epsilon_r = 49.1$; $\rho = 1000$ kg/m³

Phantom section: Flat Section

Ambient Temperature (°C) : 22.4, Liquid Temperature (°C) : 20.2

Measurement Standard: DASYS (IEEE/IEC/ANSI C63.19-2011)

DASY5 Configuration:

- Probe: EX3DV4 - SN3979; ConvF(3.92, 3.92, 3.92); Calibrated: 2018/11/22;
- Sensor-Surface: 1.4mm (Mechanical Surface Detection)
- Electronics: DAE4 Sn1425; Calibrated: 2018/11/16
- Phantom: SAM with right table; Type: SAM;
- Measurement SW: DASYS2, Version 52.10 (0); SEMCAD X Version 14.6.10 (7417)

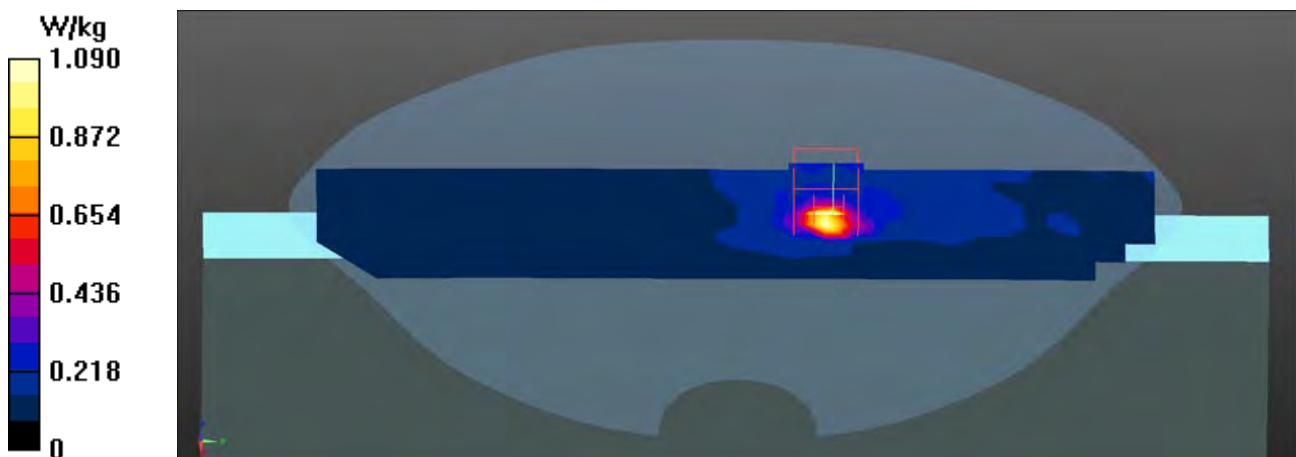
Configuration/Body/Area Scan (7x37x1): Measurement grid: dx=10mm, dy=10mm
Maximum value of SAR (measured) = 1.09 W/kg**Configuration/Body/Zoom Scan (6x6x12) (6x6x12)/Cube 0:** Measurement grid:
dx=5mm, dy=5mm, dz=2mm
Reference Value = 5.886 V/m; Power Drift = -0.16 dB
Peak SAR (extrapolated) = 3.83 W/kg
SAR(1 g) = 0.648 W/kg; SAR(10 g) = 0.300 W/kg
Maximum value of SAR (measured) = 1.36 W/kg

Test Laboratory: DEKRA

Date/Time: 2019/02/22

802.11ac80M_155-Bottom(PAD) Aux-INPAQ**DUT: ZenBook; Type: UX562F, RX562F, Q546F**

Communication System: UID 0, WLAN 5G; Frequency: 5775 MHz;

Communication System PAR: 0 dB

Medium parameters used: $f = 5775$ MHz; $\sigma = 6.21$ S/m; $\epsilon_r = 48.44$; $\rho = 1000$ kg/m³

Phantom section: Flat Section

Ambient Temperature (°C) : 22.4, Liquid Temperature (°C) : 20.2

Measurement Standard: DASYS (IEEE/IEC/ANSI C63.19-2011)

DASY5 Configuration:

- Probe: EX3DV4 - SN3979; ConvF(4.2, 4.2, 4.2); Calibrated: 2018/11/22;
- Sensor-Surface: 1.4mm (Mechanical Surface Detection)
- Electronics: DAE4 Sn1425; Calibrated: 2018/11/16
- Phantom: SAM with right table; Type: SAM;
- Measurement SW: DASYS2, Version 52.10 (0); SEMCAD X Version 14.6.10 (7417)

Configuration/Body/Area Scan (7x8x1): Measurement grid: dx=10mm, dy=10mm

Maximum value of SAR (measured) = 0.941 W/kg

Configuration/Body/Zoom Scan (6x6x12) (6x6x12)/Cube 0: Measurement grid:

dx=5mm, dy=5mm, dz=2mm

Reference Value = 6.286 V/m; Power Drift = -0.01 dB

Peak SAR (extrapolated) = 3.78 W/kg

SAR(1 g) = 0.640 W/kg; SAR(10 g) = 0.322 W/kg

Maximum value of SAR (measured) = 1.32 W/kg

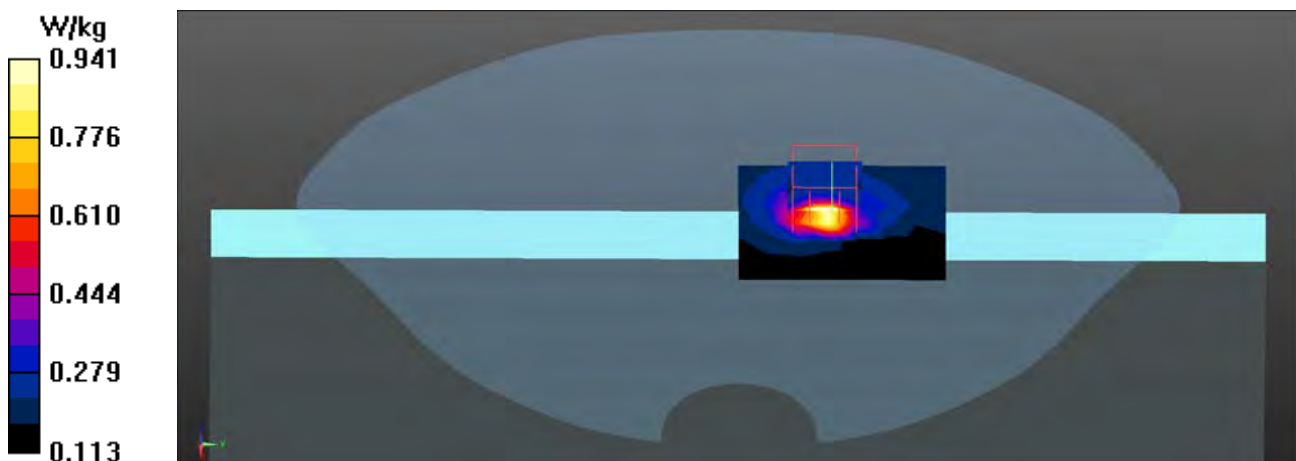

Simultaneous Transmission

Test Laboratory: DEKRA

Date/Time: 2019/02/22

802.11n40M_46-Bottom(NB) MIMO-INPAQ

DUT: ZenBook; Type: UX562F, RX562F, Q546F

Communication System: UID 0, WLAN 5G; Frequency: 5230 MHz;

Communication System PAR: 0 dB

Medium parameters used: $f = 5230$ MHz; $\sigma = 5.35$ S/m; $\epsilon_r = 49.91$; $\rho = 1000$ kg/m³

Phantom section: Flat Section

Ambient Temperature (°C) : 22.4, Liquid Temperature (°C) : 20.2

Measurement Standard: DASY5 (IEEE/IEC/ANSI C63.19-2011)

DASY5 Configuration:

- Probe: EX3DV4 - SN3979; ConvF(4.46, 4.46, 4.46); Calibrated: 2018/11/22;
- Sensor-Surface: 1.4mm (Mechanical Surface Detection)
- Electronics: DAE4 Sn1425; Calibrated: 2018/11/16
- Phantom: SAM with right table; Type: SAM;
- Measurement SW: DASY52, Version 52.10 (0); SEMCAD X Version 14.6.10 (7417)

Configuration/Body/Area Scan (7x13x1): Measurement grid: dx=10mm, dy=10mm
Maximum value of SAR (measured) = 1.39 W/kg

Configuration/Body/Zoom Scan (6x6x12) (6x6x12)/Cube 0: Measurement grid:
dx=5mm, dy=5mm, dz=2mm
Reference Value = 7.076 V/m; Power Drift = 0.14 dB
Peak SAR (extrapolated) = 3.26 W/kg
SAR(1 g) = 0.684 W/kg; SAR(10 g) = 0.285 W/kg
Maximum value of SAR (measured) = 1.57 W/kg

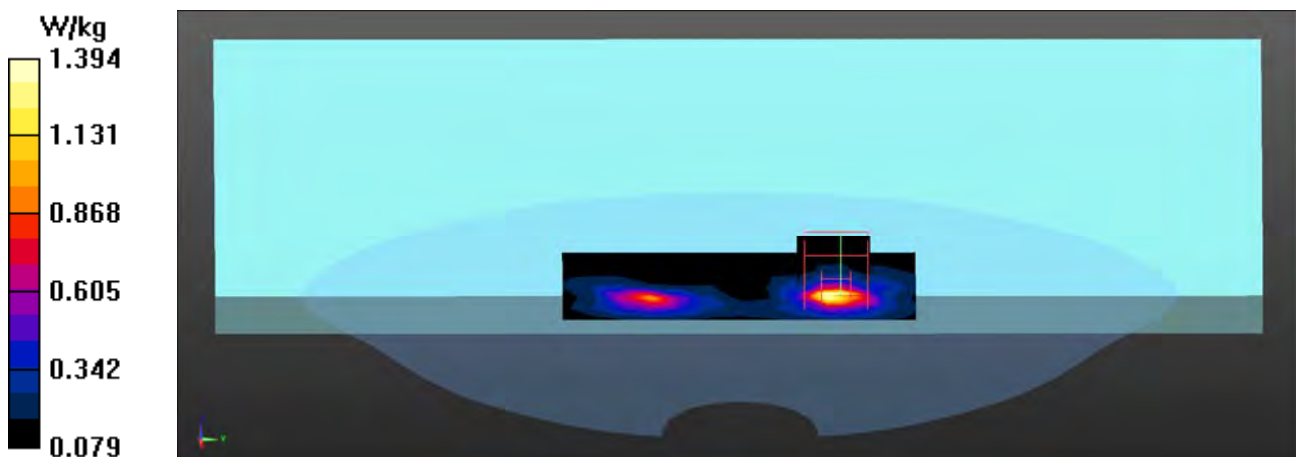

Test Laboratory: DEKRA

Date/Time: 2019/02/22

802.11n40M_54-Bottom(NB) MIMO-INPAQ**DUT: ZenBook; Type: UX562F, RX562F, Q546F**

Communication System: UID 0, WLAN 5G; Frequency: 5270 MHz;

Communication System PAR: 0 dB

Medium parameters used: $f = 5270$ MHz; $\sigma = 5.42$ S/m; $\epsilon_r = 49.8$; $\rho = 1000$ kg/m³

Phantom section: Flat Section

Ambient Temperature (°C) : 22.4, Liquid Temperature (°C) : 20.2

Measurement Standard: DASYS (IEEE/IEC/ANSI C63.19-2011)

DASY5 Configuration:

- Probe: EX3DV4 - SN3979; ConvF(4.46, 4.46, 4.46); Calibrated: 2018/11/22;
- Sensor-Surface: 1.4mm (Mechanical Surface Detection)
- Electronics: DAE4 Sn1425; Calibrated: 2018/11/16
- Phantom: SAM with right table; Type: SAM;
- Measurement SW: DASYS2, Version 52.10 (0); SEMCAD X Version 14.6.10 (7417)

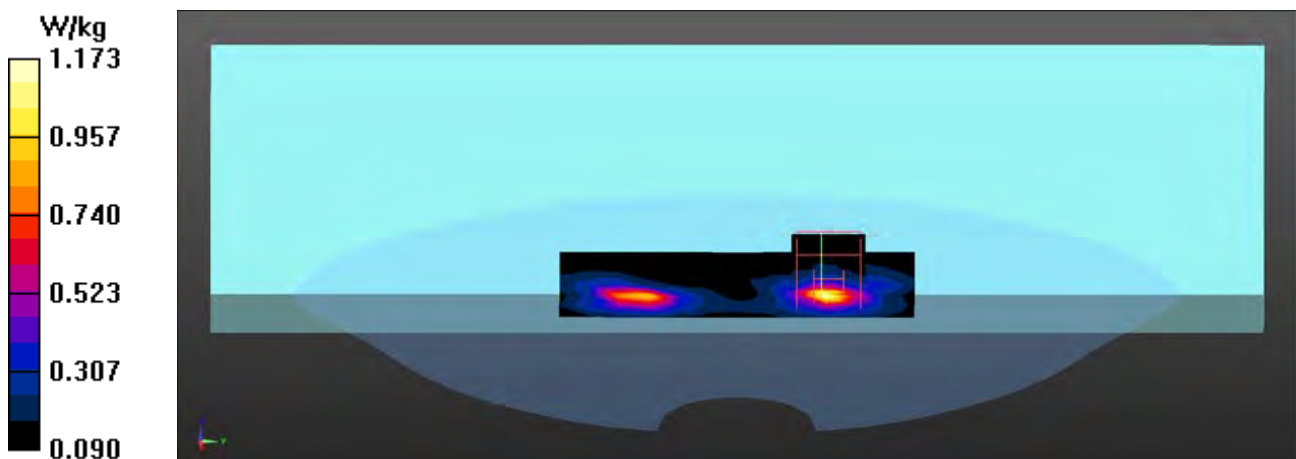
Configuration/Body/Area Scan (7x13x1): Measurement grid: dx=10mm, dy=10mm
Maximum value of SAR (measured) = 1.17 W/kg**Configuration/Body/Zoom Scan (6x6x12) (6x6x12)/Cube 0:** Measurement grid:
dx=5mm, dy=5mm, dz=2mm
Reference Value = 6.945 V/m; Power Drift = 0.09 dB
Peak SAR (extrapolated) = 2.50 W/kg
SAR(1 g) = 0.553 W/kg; SAR(10 g) = 0.260 W/kg
Maximum value of SAR (measured) = 1.15 W/kg

Test Laboratory: DEKRA

Date/Time: 2019/02/22

802.11n40M_62-Bottom(NB) MIMO-INPAQ**DUT: ZenBook; Type: UX562F, RX562F, Q546F**

Communication System: UID 0, WLAN 5G; Frequency: 5310 MHz;

Communication System PAR: 0 dB

Medium parameters used: $f = 5310$ MHz; $\sigma = 5.48$ S/m; $\epsilon_r = 49.69$; $\rho = 1000$ kg/m³

Phantom section: Flat Section

Ambient Temperature (°C) : 22.4, Liquid Temperature (°C) : 20.2

Measurement Standard: DASY5 (IEEE/IEC/ANSI C63.19-2011)

DASY5 Configuration:

- Probe: EX3DV4 - SN3979; ConvF(4.46, 4.46, 4.46); Calibrated: 2018/11/22;
- Sensor-Surface: 1.4mm (Mechanical Surface Detection)
- Electronics: DAE4 Sn1425; Calibrated: 2018/11/16
- Phantom: SAM with right table; Type: SAM;
- Measurement SW: DASY52, Version 52.10 (0); SEMCAD X Version 14.6.10 (7417)

Configuration/Body/Area Scan (7x37x1): Measurement grid: dx=10mm, dy=10mm
Maximum value of SAR (measured) = 1.78 W/kg**Configuration/Body/Zoom Scan (6x6x12) (6x6x12)/Cube 0:** Measurement grid:
dx=5mm, dy=5mm, dz=2mm

Reference Value = 7.646 V/m; Power Drift = 0.08 dB

Peak SAR (extrapolated) = 4.19 W/kg

SAR(1 g) = 0.886 W/kg; SAR(10 g) = 0.361 W/kg

Maximum value of SAR (measured) = 2.11 W/kg

Configuration/Body/Zoom Scan (6x6x12) (6x6x12)/Cube 1: Measurement grid:
dx=5mm, dy=5mm, dz=2mm

Reference Value = 7.646 V/m; Power Drift = 0.08 dB

Peak SAR (extrapolated) = 3.02 W/kg

SAR(1 g) = 0.671 W/kg; SAR(10 g) = 0.314 W/kg

Maximum value of SAR (measured) = 1.54 W/kg

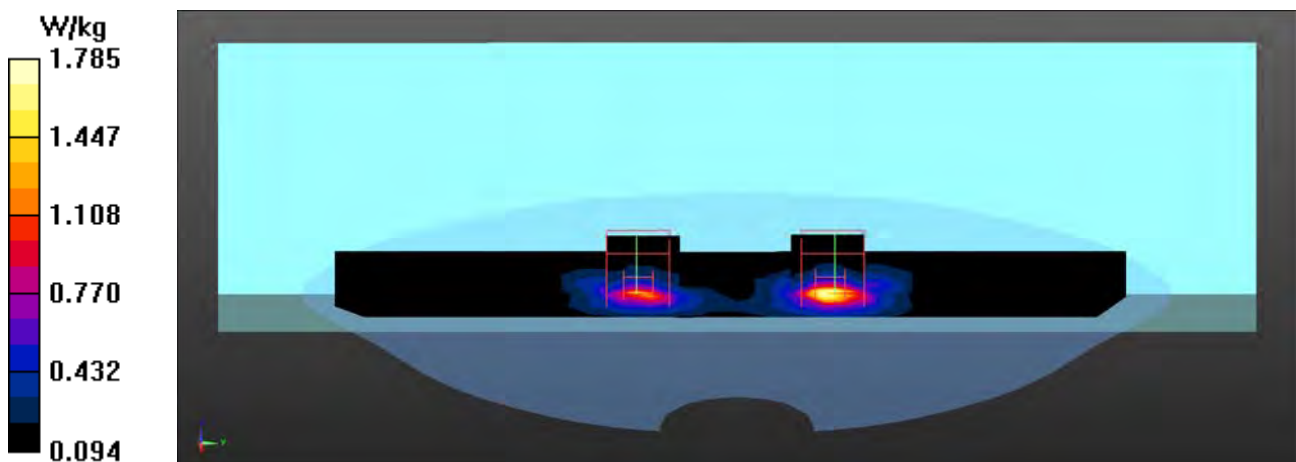

Test Laboratory: DEKRA

Date/Time: 2019/02/22

802.11ac80M_122-Bottom(NB) MIMO-INPAQ**DUT: ZenBook; Type: UX562F, RX562F, Q546F**

Communication System: UID 0, WLAN 5G; Frequency: 5610 MHz;

Communication System PAR: 0 dB

Medium parameters used: $f = 5610$ MHz; $\sigma = 5.94$ S/m; $\epsilon_r = 48.87$; $\rho = 1000$ kg/m³

Phantom section: Flat Section

Ambient Temperature (°C) : 22.4, Liquid Temperature (°C) : 20.2

Measurement Standard: DASYS (IEEE/IEC/ANSI C63.19-2011)

DASY5 Configuration:

- Probe: EX3DV4 - SN3979; ConvF(3.92, 3.92, 3.92); Calibrated: 2018/11/22;
- Sensor-Surface: 1.4mm (Mechanical Surface Detection)
- Electronics: DAE4 Sn1425; Calibrated: 2018/11/16
- Phantom: SAM with right table; Type: SAM;
- Measurement SW: DASYS2, Version 52.10 (0); SEMCAD X Version 14.6.10 (7417)

Configuration/Body/Area Scan (7x13x1): Measurement grid: dx=10mm, dy=10mm
Maximum value of SAR (measured) = 2.38 W/kg**Configuration/Body/Zoom Scan (6x6x12) (6x6x12)/Cube 0:** Measurement grid:
dx=5mm, dy=5mm, dz=2mm

Reference Value = 8.963 V/m; Power Drift = 0.16 dB

Peak SAR (extrapolated) = 6.02 W/kg

SAR(1 g) = 1.15 W/kg; SAR(10 g) = 0.496 W/kg

Maximum value of SAR (measured) = 2.51 W/kg

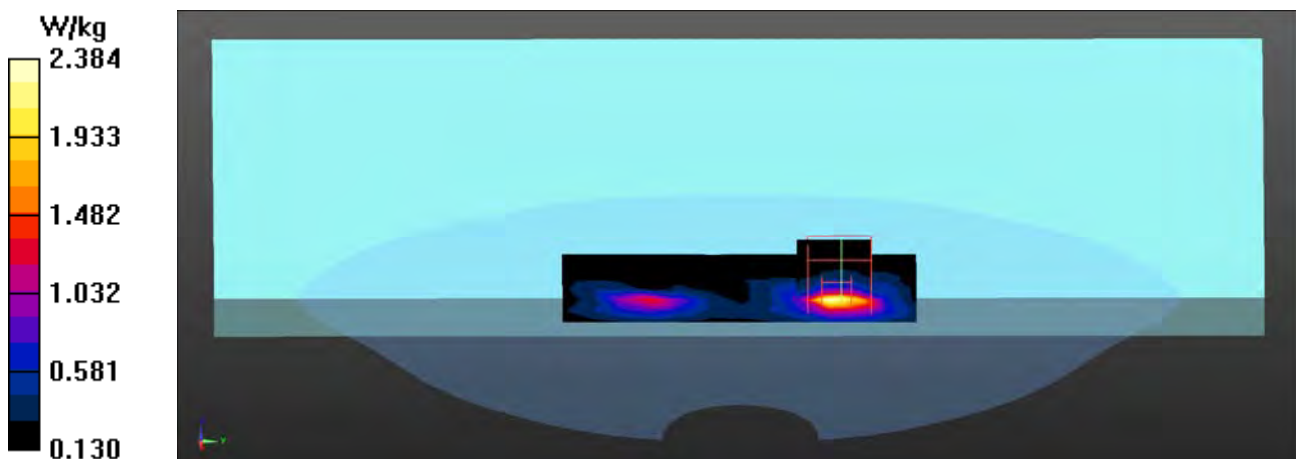

Test Laboratory: DEKRA

Date/Time: 2019/02/22

802.11ac80M_138-Bottom(NB) MIMO-INPAQ**DUT: ZenBook; Type: UX562F, RX562F, Q546F**

Communication System: UID 0, WLAN 5G; Frequency: 5690 MHz;

Communication System PAR: 0 dB

Medium parameters used: $f = 5690$ MHz; $\sigma = 6.05$ S/m; $\epsilon_r = 48.66$; $\rho = 1000$ kg/m³

Phantom section: Flat Section

Ambient Temperature (°C) : 22.4, Liquid Temperature (°C) : 20.2

Measurement Standard: DASYS (IEEE/IEC/ANSI C63.19-2011)

DASY5 Configuration:

- Probe: EX3DV4 - SN3979; ConvF(3.92, 3.92, 3.92); Calibrated: 2018/11/22;
- Sensor-Surface: 1.4mm (Mechanical Surface Detection)
- Electronics: DAE4 Sn1425; Calibrated: 2018/11/16
- Phantom: SAM with right table; Type: SAM;
- Measurement SW: DASYS2, Version 52.10 (0); SEMCAD X Version 14.6.10 (7417)

Configuration/Body/Area Scan (7x13x1): Measurement grid: dx=10mm, dy=10mm
Maximum value of SAR (measured) = 2.34 W/kg**Configuration/Body/Zoom Scan (6x6x12) (6x6x12)/Cube 0:** Measurement grid:
dx=5mm, dy=5mm, dz=2mm

Reference Value = 9.367 V/m; Power Drift = 0.07 dB

Peak SAR (extrapolated) = 6.21 W/kg

SAR(1 g) = 1.13 W/kg; SAR(10 g) = 0.468 W/kg

Maximum value of SAR (measured) = 2.48 W/kg

Configuration/Body/Zoom Scan (6x6x12) (6x6x12)/Cube 1: Measurement grid:
dx=5mm, dy=5mm, dz=2mm

Reference Value = 9.367 V/m; Power Drift = 0.07 dB

Peak SAR (extrapolated) = 4.14 W/kg

SAR(1 g) = 0.770 W/kg; SAR(10 g) = 0.367 W/kg

Maximum value of SAR (measured) = 1.56 W/kg

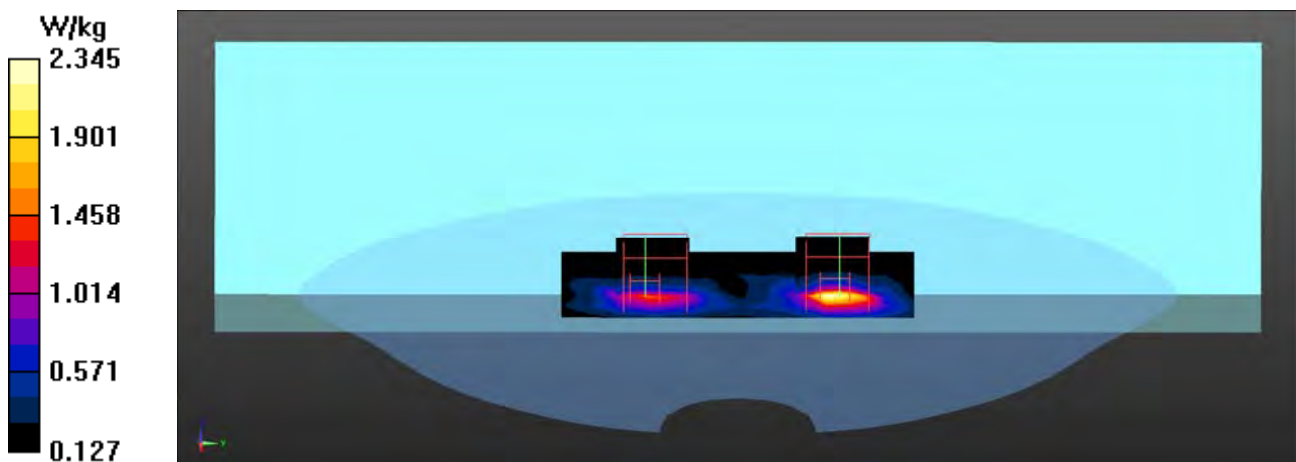

Test Laboratory: DEKRA

Date/Time: 2019/02/22

802.11ac80M_155-Bottom(NB) MIMO-INPAQ**DUT: ZenBook; Type: UX562F, RX562F, Q546F**

Communication System: UID 0, WLAN 5G; Frequency: 5775 MHz;

Communication System PAR: 0 dB

Medium parameters used: $f = 5775$ MHz; $\sigma = 6.21$ S/m; $\epsilon_r = 48.44$; $\rho = 1000$ kg/m³

Phantom section: Flat Section

Ambient Temperature (°C) : 22.4, Liquid Temperature (°C) : 20.2

Measurement Standard: DASYS (IEEE/IEC/ANSI C63.19-2011)

DASY5 Configuration:

- Probe: EX3DV4 - SN3979; ConvF(4.2, 4.2, 4.2); Calibrated: 2018/11/22;
- Sensor-Surface: 1.4mm (Mechanical Surface Detection)
- Electronics: DAE4 Sn1425; Calibrated: 2018/11/16
- Phantom: SAM with right table; Type: SAM;
- Measurement SW: DASY52, Version 52.10 (0); SEMCAD X Version 14.6.10 (7417)

Configuration/Body/Area Scan (7x13x1): Measurement grid: dx=10mm, dy=10mm
Maximum value of SAR (measured) = 1.57 W/kg**Configuration/Body/Zoom Scan (6x6x12) (6x6x12)/Cube 0:** Measurement grid:
dx=5mm, dy=5mm, dz=2mm

Reference Value = 8.461 V/m; Power Drift = 0.04 dB

Peak SAR (extrapolated) = 4.56 W/kg

SAR(1 g) = 0.759 W/kg; SAR(10 g) = 0.346 W/kg

Maximum value of SAR (measured) = 1.52 W/kg

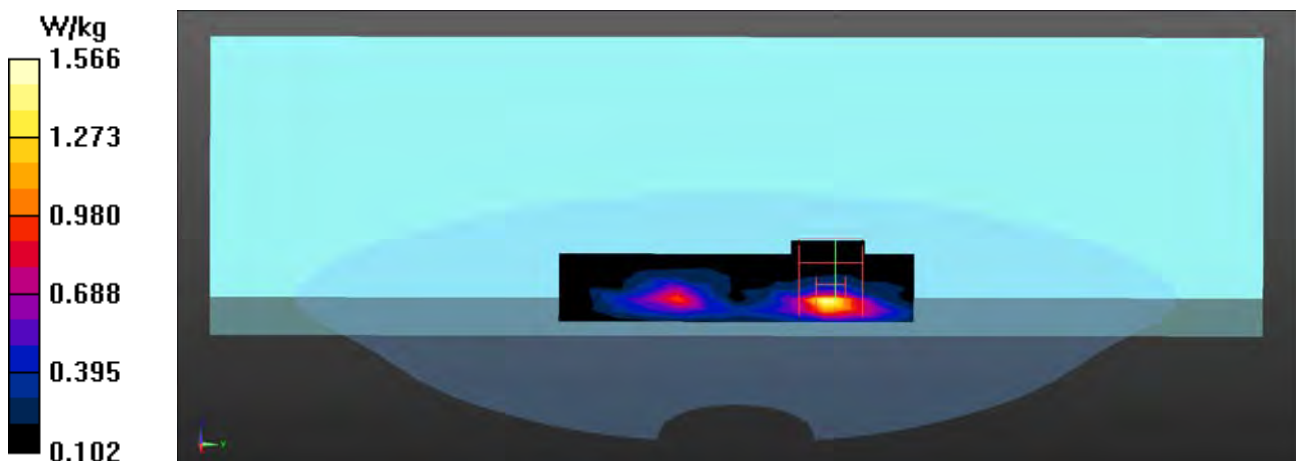

Test Laboratory: DEKRA

Date/Time: 2019/02/22

802.11ac80M_58-Bottom(PAD) MIMO-INPAQ**DUT: ZenBook; Type: UX562F, RX562F, Q546F**

Communication System: UID 0, WLAN 5G; Frequency: 5290 MHz;

Communication System PAR: 0 dB

Medium parameters used: $f = 5290$ MHz; $\sigma = 5.45$ S/m; $\epsilon_r = 49.75$; $\rho = 1000$ kg/m³

Phantom section: Flat Section

Ambient Temperature (°C) : 22.4, Liquid Temperature (°C) : 20.2

Measurement Standard: DASYS (IEEE/IEC/ANSI C63.19-2011)

DASY5 Configuration:

- Probe: EX3DV4 - SN3979; ConvF(4.46, 4.46, 4.46); Calibrated: 2018/11/22;
- Sensor-Surface: 1.4mm (Mechanical Surface Detection)
- Electronics: DAE4 Sn1425; Calibrated: 2018/11/16
- Phantom: SAM with right table; Type: SAM;
- Measurement SW: DASY52, Version 52.10 (0); SEMCAD X Version 14.6.10 (7417)

Configuration/Body/Area Scan (7x15x1): Measurement grid: dx=10mm, dy=10mm
Maximum value of SAR (measured) = 1.83 W/kg**Configuration/Body/Zoom Scan (6x6x12) (6x6x12)/Cube 0:** Measurement grid:
dx=5mm, dy=5mm, dz=2mm

Reference Value = 5.627 V/m; Power Drift = -0.06 dB

Peak SAR (extrapolated) = 4.39 W/kg

SAR(1 g) = 0.780 W/kg; SAR(10 g) = 0.301 W/kg

Maximum value of SAR (measured) = 1.78 W/kg

Configuration/Body/Zoom Scan (6x6x12) (6x6x12)/Cube 1: Measurement grid:
dx=5mm, dy=5mm, dz=2mm

Reference Value = 5.627 V/m; Power Drift = -0.06 dB

Peak SAR (extrapolated) = 4.76 W/kg

SAR(1 g) = 0.762 W/kg; SAR(10 g) = 0.290 W/kg

Maximum value of SAR (measured) = 1.54 W/kg

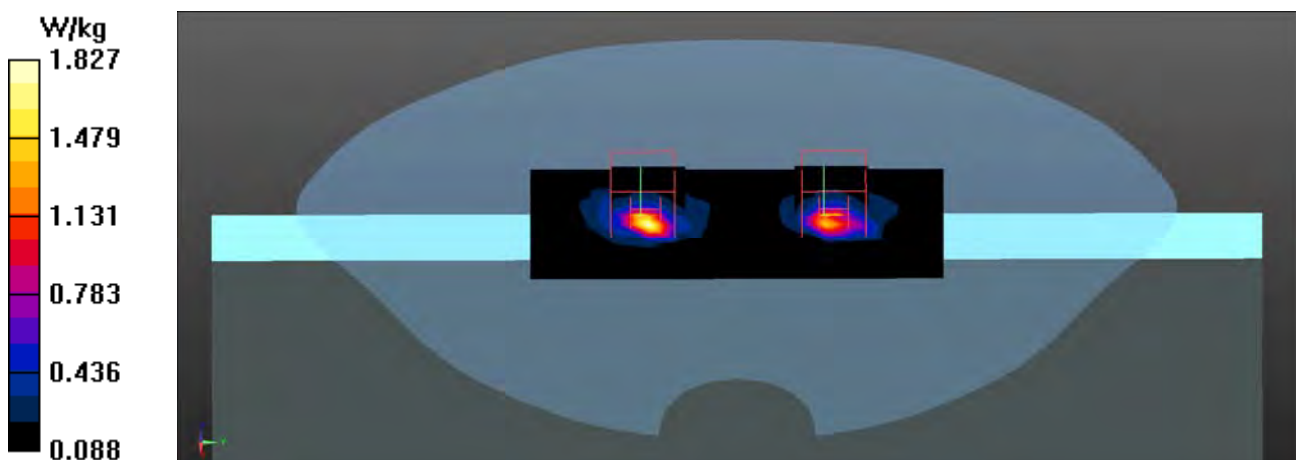

Test Laboratory: DEKRA

Date/Time: 2019/02/22

802.11ac80M_106-Bottom(PAD) MIMO-INPAQ**DUT: ZenBook; Type: UX562F, RX562F, Q546F**

Communication System: UID 0, WLAN 5G; Frequency: 5530 MHz;

Communication System PAR: 0 dB

Medium parameters used: $f = 5530$ MHz; $\sigma = 5.82$ S/m; $\epsilon_r = 49.1$; $\rho = 1000$ kg/m³

Phantom section: Flat Section

Ambient Temperature (°C) : 22.4, Liquid Temperature (°C) : 20.2

Measurement Standard: DASYS (IEEE/IEC/ANSI C63.19-2011)

DASY5 Configuration:

- Probe: EX3DV4 - SN3979; ConvF(3.92, 3.92, 3.92); Calibrated: 2018/11/22;
- Sensor-Surface: 1.4mm (Mechanical Surface Detection)
- Electronics: DAE4 Sn1425; Calibrated: 2018/11/16
- Phantom: SAM with right table; Type: SAM;
- Measurement SW: DASYS2, Version 52.10 (0); SEMCAD X Version 14.6.10 (7417)

Configuration/Body/Area Scan (7x15x1): Measurement grid: dx=10mm, dy=10mm
Maximum value of SAR (measured) = 2.44 W/kg**Configuration/Body/Zoom Scan (6x6x12) (6x6x12)/Cube 0:** Measurement grid:
dx=5mm, dy=5mm, dz=2mm

Reference Value = 6.625 V/m; Power Drift = -0.09 dB

Peak SAR (extrapolated) = 5.83 W/kg

SAR(1 g) = 0.981 W/kg; SAR(10 g) = 0.395 W/kg

Maximum value of SAR (measured) = 2.21 W/kg

Configuration/Body/Zoom Scan (6x6x12) (6x6x12)/Cube 1: Measurement grid:
dx=5mm, dy=5mm, dz=2mm

Reference Value = 6.625 V/m; Power Drift = -0.09 dB

Peak SAR (extrapolated) = 5.87 W/kg

SAR(1 g) = 0.859 W/kg; SAR(10 g) = 0.367 W/kg

Maximum value of SAR (measured) = 1.93 W/kg

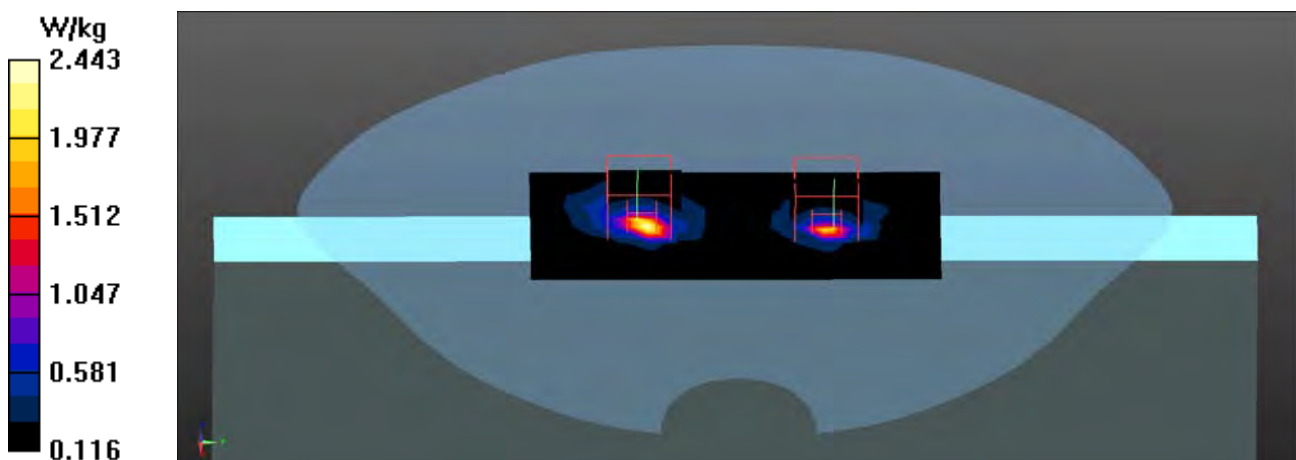

Test Laboratory: DEKRA

Date/Time: 2019/02/22

802.11ac80M_122-Bottom(PAD) MIMO-INPAQ**DUT: ZenBook; Type: UX562F, RX562F, Q546F**

Communication System: UID 0, WLAN 5G; Frequency: 5610 MHz;

Communication System PAR: 0 dB

Medium parameters used: $f = 5610$ MHz; $\sigma = 5.94$ S/m; $\epsilon_r = 48.87$; $\rho = 1000$ kg/m³

Phantom section: Flat Section

Ambient Temperature (°C) : 22.4, Liquid Temperature (°C) : 20.2

Measurement Standard: DASY5 (IEEE/IEC/ANSI C63.19-2011)

DASY5 Configuration:

- Probe: EX3DV4 - SN3979; ConvF(3.92, 3.92, 3.92); Calibrated: 2018/11/22;
- Sensor-Surface: 1.4mm (Mechanical Surface Detection)
- Electronics: DAE4 Sn1425; Calibrated: 2018/11/16
- Phantom: SAM with right table; Type: SAM;
- Measurement SW: DASY52, Version 52.10 (0); SEMCAD X Version 14.6.10 (7417)

Configuration/Body/Area Scan (7x37x1): Measurement grid: dx=10mm, dy=10mm
Maximum value of SAR (measured) = 1.71 W/kg**Configuration/Body/Zoom Scan (6x6x12) (6x6x12)/Cube 0:** Measurement grid:
dx=5mm, dy=5mm, dz=2mm

Reference Value = 6.434 V/m; Power Drift = 0.06 dB

Peak SAR (extrapolated) = 5.67 W/kg

SAR(1 g) = 0.988 W/kg; SAR(10 g) = 0.413 W/kg

Maximum value of SAR (measured) = 2.24 W/kg

Configuration/Body/Zoom Scan (6x6x12) (6x6x12)/Cube 1: Measurement grid:
dx=5mm, dy=5mm, dz=2mm

Reference Value = 6.434 V/m; Power Drift = 0.06 dB

Peak SAR (extrapolated) = 4.09 W/kg

SAR(1 g) = 0.729 W/kg; SAR(10 g) = 0.343 W/kg

Maximum value of SAR (measured) = 1.64 W/kg

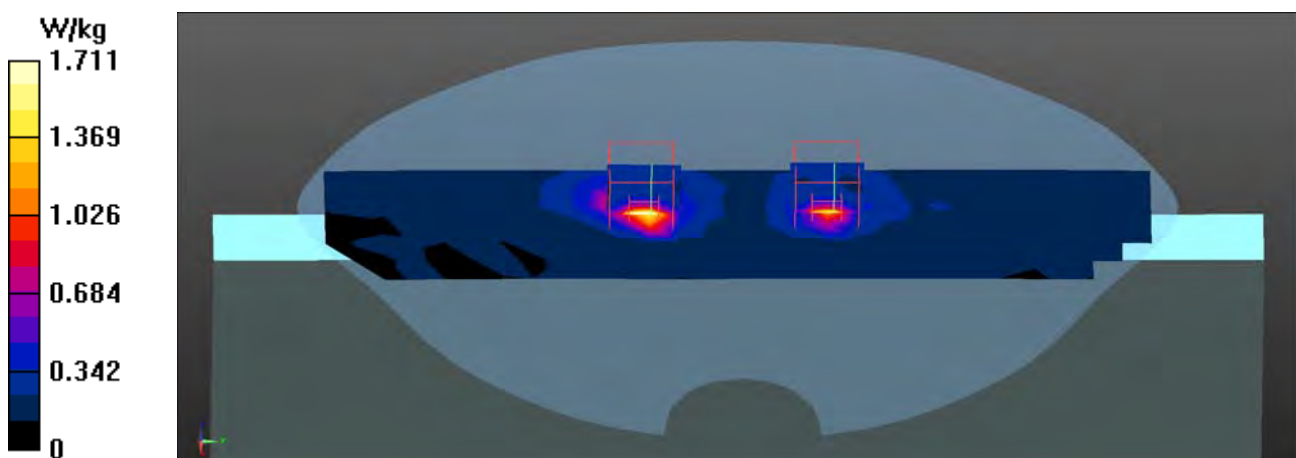

Test Laboratory: DEKRA

Date/Time: 2019/02/22

802.11ac80M_138-Bottom(PAD) MIMO-INPAQ**DUT: ZenBook; Type: UX562F, RX562F, Q546F**

Communication System: UID 0, WLAN 5G; Frequency: 5690 MHz;

Communication System PAR: 0 dB

Medium parameters used: $f = 5690$ MHz; $\sigma = 6.05$ S/m; $\epsilon_r = 48.66$; $\rho = 1000$ kg/m³

Phantom section: Flat Section

Ambient Temperature (°C) : 22.4, Liquid Temperature (°C) : 20.2

Measurement Standard: DASYS (IEEE/IEC/ANSI C63.19-2011)

DASY5 Configuration:

- Probe: EX3DV4 - SN3979; ConvF(3.92, 3.92, 3.92); Calibrated: 2018/11/22;
- Sensor-Surface: 1.4mm (Mechanical Surface Detection)
- Electronics: DAE4 Sn1425; Calibrated: 2018/11/16
- Phantom: SAM with right table; Type: SAM;
- Measurement SW: DASY52, Version 52.10 (0); SEMCAD X Version 14.6.10 (7417)

Configuration/Body/Area Scan (7x15x1): Measurement grid: dx=10mm, dy=10mm
Maximum value of SAR (measured) = 2.44 W/kg**Configuration/Body/Zoom Scan (6x6x12) (6x6x12)/Cube 0:** Measurement grid:
dx=5mm, dy=5mm, dz=2mm

Reference Value = 6.026 V/m; Power Drift = 0.07 dB

Peak SAR (extrapolated) = 6.29 W/kg

SAR(1 g) = 0.986 W/kg; SAR(10 g) = 0.360 W/kg

Maximum value of SAR (measured) = 2.22 W/kg

Configuration/Body/Zoom Scan (6x6x12) (6x6x12)/Cube 1: Measurement grid:
dx=5mm, dy=5mm, dz=2mm

Reference Value = 6.026 V/m; Power Drift = 0.07 dB

Peak SAR (extrapolated) = 5.81 W/kg

SAR(1 g) = 0.859 W/kg; SAR(10 g) = 0.339 W/kg

Maximum value of SAR (measured) = 2.10 W/kg

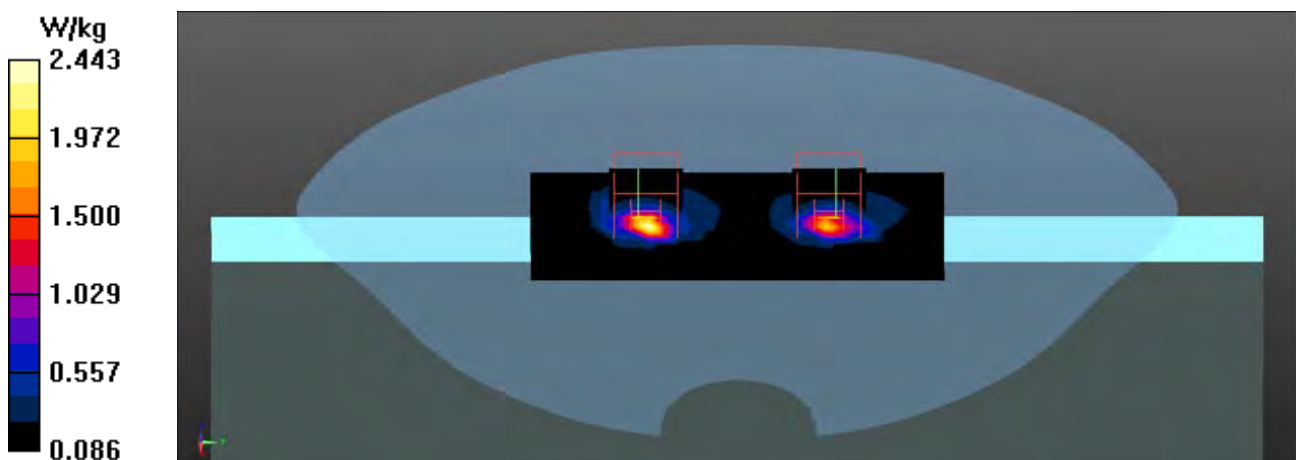

Test Laboratory: DEKRA

Date/Time: 2019/02/22

802.11ac80M_155-Bottom(PAD) MIMO-INPAQ**DUT: ZenBook; Type: UX562F, RX562F, Q546F**

Communication System: UID 0, WLAN 5G; Frequency: 5775 MHz;

Communication System PAR: 0 dB

Medium parameters used: $f = 5775$ MHz; $\sigma = 6.21$ S/m; $\epsilon_r = 48.44$; $\rho = 1000$ kg/m³

Phantom section: Flat Section

Ambient Temperature (°C) : 22.4, Liquid Temperature (°C) : 20.2

Measurement Standard: DASY5 (IEEE/IEC/ANSI C63.19-2011)

DASY5 Configuration:

- Probe: EX3DV4 - SN3979; ConvF(4.2, 4.2, 4.2); Calibrated: 2018/11/22;
- Sensor-Surface: 1.4mm (Mechanical Surface Detection)
- Electronics: DAE4 Sn1425; Calibrated: 2018/11/16
- Phantom: SAM with right table; Type: SAM;
- Measurement SW: DASY52, Version 52.10 (0); SEMCAD X Version 14.6.10 (7417)

Configuration/Body/Area Scan (7x15x1): Measurement grid: dx=10mm, dy=10mm
Maximum value of SAR (measured) = 2.07 W/kg**Configuration/Body/Zoom Scan (6x6x12) (6x6x12)/Cube 0:** Measurement grid:
dx=5mm, dy=5mm, dz=2mm

Reference Value = 5.890 V/m; Power Drift = 0.06 dB

Peak SAR (extrapolated) = 5.85 W/kg

SAR(1 g) = 0.899 W/kg; SAR(10 g) = 0.325 W/kg

Maximum value of SAR (measured) = 1.97 W/kg

Configuration/Body/Zoom Scan (6x6x12) (6x6x12)/Cube 1: Measurement grid:
dx=5mm, dy=5mm, dz=2mm

Reference Value = 5.890 V/m; Power Drift = 0.06 dB

Peak SAR (extrapolated) = 4.02 W/kg

SAR(1 g) = 0.668 W/kg; SAR(10 g) = 0.278 W/kg

Maximum value of SAR (measured) = 1.46 W/kg

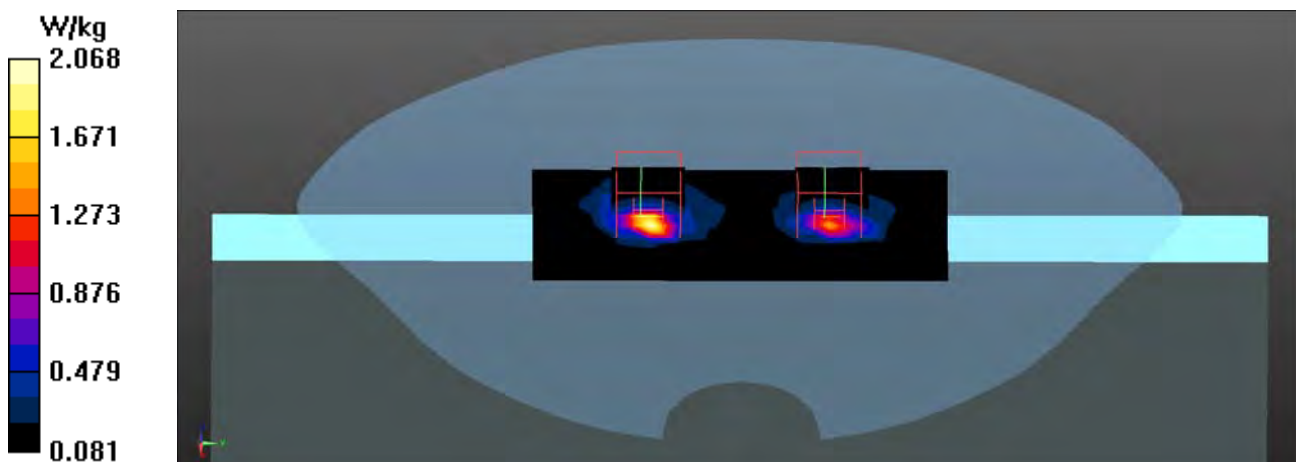

802.11ac80 Bottom(NB) MIMO, Z-Axis plot

Channel: 122

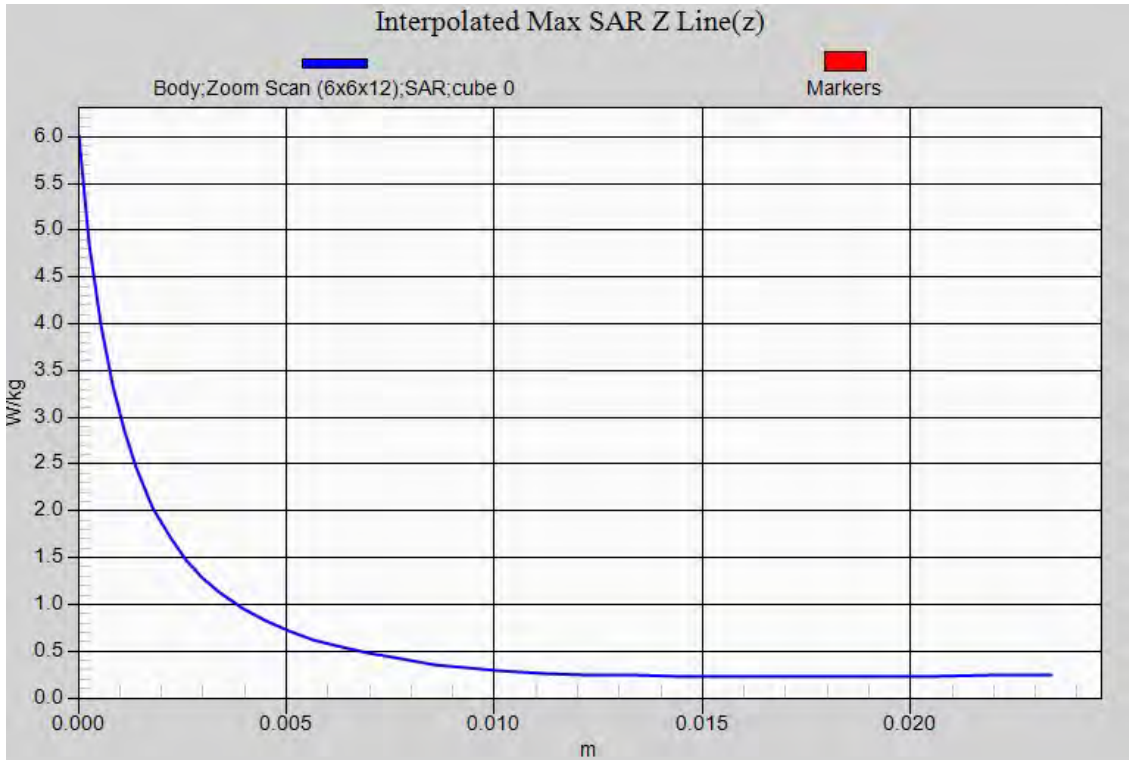

SAR measurement variability

Test Laboratory: DEKRA

Date/Time: 2019/02/22

802.11ac80M_122-Bottom(NB) MIMO-INPAQ-Verify

DUT: ZenBook; Type: UX562F, RX562F, Q546F

Communication System: UID 0, WLAN 5G; Frequency: 5610 MHz;

Communication System PAR: 0 dB

Medium parameters used: $f = 5610$ MHz; $\sigma = 5.94$ S/m; $\epsilon_r = 48.87$; $\rho = 1000$ kg/m³

Phantom section: Flat Section

Ambient Temperature (°C) : 22.4, Liquid Temperature (°C) : 20.2

Measurement Standard: DASYS5 (IEEE/IEC/ANSI C63.19-2011)

DASY5 Configuration:

- Probe: EX3DV4 - SN3979; ConvF(3.92, 3.92, 3.92); Calibrated: 2018/11/22;
- Sensor-Surface: 1.4mm (Mechanical Surface Detection)
- Electronics: DAE4 Sn1425; Calibrated: 2018/11/16
- Phantom: SAM with right table; Type: SAM;
- Measurement SW: DASYS52, Version 52.10 (0); SEMCAD X Version 14.6.10 (7417)

Configuration/Body/Area Scan (7x13x1): Measurement grid: dx=10mm, dy=10mm

Maximum value of SAR (measured) = 4.02 W/kg

Configuration/Body/Zoom Scan (6x6x12) (6x6x12)/Cube 0: Measurement grid:

dx=5mm, dy=5mm, dz=2mm

Reference Value = 9.661 V/m; Power Drift = -0.07 dB

Peak SAR (extrapolated) = 7.57 W/kg

SAR(1 g) = 1.08 W/kg; SAR(10 g) = 0.447 W/kg

Maximum value of SAR (measured) = 2.36 W/kg

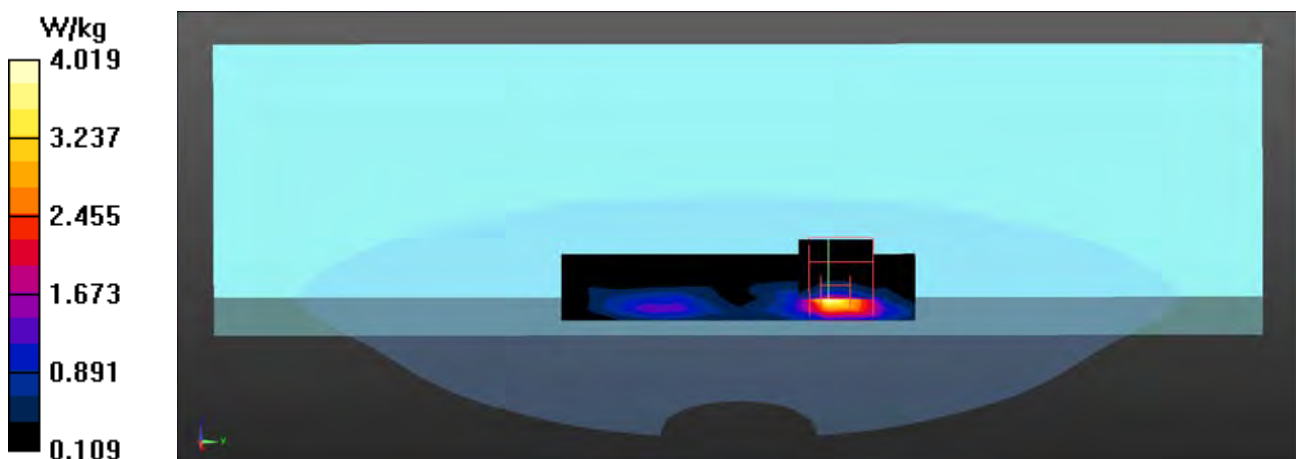



Appendix D. Probe Calibration Data

Object: EX3DV4 - SN:3979

139911

**Calibration Laboratory of
Schmid & Partner
Engineering AG**
Zeughausstrasse 43, 8004 Zurich, Switzerland



S Schweizerischer Kalibrierdienst
C Service suisse d'étalonnage
S Servizio svizzero di taratura
Swiss Calibration Service

Accredited by the Swiss Accreditation Service (SAS)

The Swiss Accreditation Service is one of the signatories to the EA
Multilateral Agreement for the recognition of calibration certificates

Accreditation No.: **SCS 0108**

Client **DEKRA (Auden)**

Certificate No: **EX3-3979_Nov18**

CALIBRATION CERTIFICATE

Object **EX3DV4 - SN:3979**

Calibration procedure(s) **QA CAL-01.v9, QA CAL-14.v4, QA CAL-23.v5, QA CAL-25.v6
Calibration procedure for dosimetric E-field probes**

Calibration date: **November 22, 2018**

This calibration certificate documents the traceability to national standards, which realize the physical units of measurements (SI).
The measurements and the uncertainties with confidence probability are given on the following pages and are part of the certificate.

All calibrations have been conducted in the closed laboratory facility: environment temperature (22 ± 3)°C and humidity < 70%.

Calibration Equipment used (M&TE critical for calibration)

Primary Standards	ID	Cal Date (Certificate No.)	Scheduled Calibration
Power meter NRP	SN: 104778	04-Apr-18 (No. 217-02672/02673)	Apr-19
Power sensor NRP-Z91	SN: 103244	04-Apr-18 (No. 217-02672)	Apr-19
Power sensor NRP-Z91	SN: 103245	04-Apr-18 (No. 217-02673)	Apr-19
Reference 20 dB Attenuator	SN: S5277 (20x)	04-Apr-18 (No. 217-02682)	Apr-19
Reference Probe ES3DV2	SN: 3013	30-Dec-17 (No. ES3-3013_Dec17)	Dec-18
DAE4	SN: 660	21-Dec-17 (No. DAE4-660_Dec17)	Dec-18
Secondary Standards	ID	Check Date (in house)	Scheduled Check
Power meter E4419B	SN: GB41293874	06-Apr-16 (in house check Jun-18)	In house check: Jun-20
Power sensor E4412A	SN: MY41498087	06-Apr-16 (in house check Jun-18)	In house check: Jun-20
Power sensor E4412A	SN: 000110210	06-Apr-16 (in house check Jun-18)	In house check: Jun-20
RF generator HP 8648C	SN: US3642U01700	04-Aug-99 (in house check Jun-18)	In house check: Jun-20
Network Analyzer E8358A	SN: US41080477	31-Mar-14 (in house check Oct-18)	In house check: Oct-19

	Name	Function	Signature
Calibrated by:	Jeton Kastrati	Laboratory Technician	
Approved by:	Katja Pokovic	Technical Manager	
			Issued: November 22, 2018
This calibration certificate shall not be reproduced except in full without written approval of the laboratory.			



Accredited by the Swiss Accreditation Service (SAS)

Accreditation No.: **SCS 0108**

The Swiss Accreditation Service is one of the signatories to the EA
Multilateral Agreement for the recognition of calibration certificates

Glossary:

TSL	tissue simulating liquid
NORM _{x,y,z}	sensitivity in free space
ConvF	sensitivity in TSL / NORM _{x,y,z}
DCP	diode compression point
CF	crest factor (1/duty_cycle) of the RF signal
A, B, C, D	modulation dependent linearization parameters
Polarization φ	φ rotation around probe axis
Polarization ϑ	ϑ rotation around an axis that is in the plane normal to probe axis (at measurement center), i.e., $\vartheta = 0$ is normal to probe axis
Connector Angle	information used in DASY system to align probe sensor X to the robot coordinate system

Calibration is Performed According to the Following Standards:

- IEEE Std 1528-2013, "IEEE Recommended Practice for Determining the Peak Spatial-Averaged Specific Absorption Rate (SAR) in the Human Head from Wireless Communications Devices: Measurement Techniques", June 2013
- IEC 62209-1, "Measurement procedure for the assessment of Specific Absorption Rate (SAR) from hand-held and body-mounted devices used next to the ear (frequency range of 300 MHz to 6 GHz)", July 2016
- IEC 62209-2, "Procedure to determine the Specific Absorption Rate (SAR) for wireless communication devices used in close proximity to the human body (frequency range of 30 MHz to 6 GHz)", March 2010
- KDB 865664, "SAR Measurement Requirements for 100 MHz to 6 GHz"

Methods Applied and Interpretation of Parameters:

- NORM_{x,y,z}**: Assessed for E-field polarization $\vartheta = 0$ ($f \leq 900$ MHz in TEM-cell; $f > 1800$ MHz: R22 waveguide). NORM_{x,y,z} are only intermediate values, i.e., the uncertainties of NORM_{x,y,z} does not affect the E²-field uncertainty inside TSL (see below *ConvF*).
- NORM(f)_{x,y,z}** = NORM_{x,y,z} * *frequency_response* (see Frequency Response Chart). This linearization is implemented in DASY4 software versions later than 4.2. The uncertainty of the frequency response is included in the stated uncertainty of *ConvF*.
- DCP_{x,y,z}**: DCP are numerical linearization parameters assessed based on the data of power sweep with CW signal (no uncertainty required). DCP does not depend on frequency nor media.
- PAR**: PAR is the Peak to Average Ratio that is not calibrated but determined based on the signal characteristics
- A_{x,y,z}; B_{x,y,z}; C_{x,y,z}; D_{x,y,z}; VR_{x,y,z}**: A, B, C, D are numerical linearization parameters assessed based on the data of power sweep for specific modulation signal. The parameters do not depend on frequency nor media. VR is the maximum calibration range expressed in RMS voltage across the diode.
- ConvF and Boundary Effect Parameters**: Assessed in flat phantom using E-field (or Temperature Transfer Standard for $f \leq 800$ MHz) and inside waveguide using analytical field distributions based on power measurements for $f > 800$ MHz. The same setups are used for assessment of the parameters applied for boundary compensation (alpha, depth) of which typical uncertainty values are given. These parameters are used in DASY4 software to improve probe accuracy close to the boundary. The sensitivity in TSL corresponds to NORM_{x,y,z} * *ConvF* whereby the uncertainty corresponds to that given for *ConvF*. A frequency dependent *ConvF* is used in DASY version 4.4 and higher which allows extending the validity from ± 50 MHz to ± 100 MHz.
- Spherical isotropy (3D deviation from isotropy)**: in a field of low gradients realized using a flat phantom exposed by a patch antenna.
- Sensor Offset**: The sensor offset corresponds to the offset of virtual measurement center from the probe tip (on probe axis). No tolerance required.
- Connector Angle**: The angle is assessed using the information gained by determining the NORM_x (no uncertainty required).

Probe EX3DV4

SN:3979

Manufactured: November 5, 2013
Calibrated: November 22, 2018

Calibrated for DASY/EASY Systems
(Note: non-compatible with DASY2 system!)

DASY/EASY - Parameters of Probe: EX3DV4 - SN:3979

Basic Calibration Parameters

	Sensor X	Sensor Y	Sensor Z	Unc (k=2)
Norm ($\mu\text{V}/(\text{V}/\text{m})^2$) ^A	0.46	0.49	0.48	$\pm 10.1 \%$
DCP (mV) ^B	99.4	99.3	100.3	

Modulation Calibration Parameters

UID	Communication System Name		A dB	B dB $\sqrt{\mu\text{V}}$	C	D dB	VR mV	Unc ^E (k=2)
0	CW	X	0.0	0.0	1.0	0.00	142.4	$\pm 3.5 \%$
		Y	0.0	0.0	1.0		136.0	
		Z	0.0	0.0	1.0		135.1	

The reported uncertainty of measurement is stated as the standard uncertainty of measurement multiplied by the coverage factor $k=2$, which for a normal distribution corresponds to a coverage probability of approximately 95%.

^A The uncertainties of Norm X,Y,Z do not affect the E^2 -field uncertainty inside TSL (see Pages 5 and 6).

^B Numerical linearization parameter: uncertainty not required.

^E Uncertainty is determined using the max. deviation from linear response applying rectangular distribution and is expressed for the square of the field value.

DASY/EASY - Parameters of Probe: EX3DV4 - SN:3979

Calibration Parameter Determined in Head Tissue Simulating Media

f (MHz) ^C	Relative Permittivity ^F	Conductivity (S/m) ^F	ConvF X	ConvF Y	ConvF Z	Alpha ^G	Depth ^G (mm)	Unc (k=2)
750	41.9	0.89	10.42	10.42	10.42	0.67	0.81	± 12.0 %
835	41.5	0.90	9.97	9.97	9.97	0.59	0.85	± 12.0 %
900	41.5	0.97	9.70	9.70	9.70	0.41	0.98	± 12.0 %
1450	40.5	1.20	8.52	8.52	8.52	0.37	0.80	± 12.0 %
1640	40.2	1.31	8.38	8.38	8.38	0.39	0.84	± 12.0 %
1750	40.1	1.37	8.37	8.37	8.37	0.44	0.80	± 12.0 %
1900	40.0	1.40	8.01	8.01	8.01	0.36	0.84	± 12.0 %
2000	40.0	1.40	8.03	8.03	8.03	0.38	0.83	± 12.0 %
2300	39.5	1.67	7.48	7.48	7.48	0.35	0.85	± 12.0 %
2450	39.2	1.80	7.33	7.33	7.33	0.43	0.92	± 12.0 %
2600	39.0	1.96	7.18	7.18	7.18	0.43	0.85	± 12.0 %
3500	37.9	2.91	7.08	7.08	7.08	0.26	1.20	± 13.1 %
3700	37.7	3.12	6.97	6.97	6.97	0.25	1.25	± 13.1 %
5250	35.9	4.71	4.80	4.80	4.80	0.40	1.80	± 13.1 %
5600	35.5	5.07	4.53	4.53	4.53	0.40	1.80	± 13.1 %
5800	35.3	5.27	4.45	4.45	4.45	0.40	1.80	± 13.1 %

^C Frequency validity above 300 MHz of ± 100 MHz only applies for DASY v4.4 and higher (see Page 2), else it is restricted to ± 50 MHz. The uncertainty is the RSS of the ConvF uncertainty at calibration frequency and the uncertainty for the indicated frequency band. Frequency validity below 300 MHz is ± 10, 25, 40, 50 and 70 MHz for ConvF assessments at 30, 64, 128, 150 and 220 MHz respectively. Above 5 GHz frequency validity can be extended to ± 110 MHz.

^F At frequencies below 3 GHz, the validity of tissue parameters (ϵ and σ) can be relaxed to ± 10% if liquid compensation formula is applied to measured SAR values. At frequencies above 3 GHz, the validity of tissue parameters (ϵ and σ) is restricted to ± 5%. The uncertainty is the RSS of the ConvF uncertainty for indicated target tissue parameters.

^G Alpha/Depth are determined during calibration. SPEAG warrants that the remaining deviation due to the boundary effect after compensation is always less than ± 1% for frequencies below 3 GHz and below ± 2% for frequencies between 3-6 GHz at any distance larger than half the probe tip diameter from the boundary.

DASY/EASY - Parameters of Probe: EX3DV4 - SN:3979

Calibration Parameter Determined in Body Tissue Simulating Media

f (MHz) ^C	Relative Permittivity ^F	Conductivity (S/m) ^F	ConvF X	ConvF Y	ConvF Z	Alpha ^G	Depth ^G (mm)	Unc (k=2)
750	55.5	0.96	9.83	9.83	9.83	0.51	0.85	± 12.0 %
835	55.2	0.97	9.63	9.63	9.63	0.40	0.94	± 12.0 %
900	55.0	1.05	9.67	9.67	9.67	0.54	0.80	± 12.0 %
1450	54.0	1.30	8.37	8.37	8.37	0.35	0.80	± 12.0 %
1640	53.7	1.42	8.30	8.30	8.30	0.42	0.80	± 12.0 %
1750	53.4	1.49	8.08	8.08	8.08	0.35	0.85	± 12.0 %
1900	53.3	1.52	7.78	7.78	7.78	0.39	0.85	± 12.0 %
2000	53.3	1.52	7.65	7.65	7.65	0.37	0.88	± 12.0 %
2300	52.9	1.81	7.54	7.54	7.54	0.40	0.87	± 12.0 %
2450	52.7	1.95	7.50	7.50	7.50	0.42	0.92	± 12.0 %
2600	52.5	2.16	7.16	7.16	7.16	0.30	1.05	± 12.0 %
3500	51.3	3.31	6.45	6.45	6.45	0.50	0.80	± 13.1 %
3700	51.0	3.55	6.43	6.43	6.43	0.60	0.80	± 13.1 %
5250	48.9	5.36	4.46	4.46	4.46	0.50	1.90	± 13.1 %
5600	48.5	5.77	3.92	3.92	3.92	0.50	1.90	± 13.1 %
5800	48.2	6.00	4.20	4.20	4.20	0.50	1.90	± 13.1 %

^C Frequency validity above 300 MHz of ± 100 MHz only applies for DASY v4.4 and higher (see Page 2), else it is restricted to ± 50 MHz. The uncertainty is the RSS of the ConvF uncertainty at calibration frequency and the uncertainty for the indicated frequency band. Frequency validity below 300 MHz is ± 10, 25, 40, 50 and 70 MHz for ConvF assessments at 30, 64, 128, 150 and 220 MHz respectively. Above 5 GHz frequency validity can be extended to ± 110 MHz.

^F At frequencies below 3 GHz, the validity of tissue parameters (ϵ and σ) can be relaxed to ± 10% if liquid compensation formula is applied to measured SAR values. At frequencies above 3 GHz, the validity of tissue parameters (ϵ and σ) is restricted to ± 5%. The uncertainty is the RSS of the ConvF uncertainty for indicated target tissue parameters.

^G Alpha/Depth are determined during calibration. SPEAG warrants that the remaining deviation due to the boundary effect after compensation is always less than ± 1% for frequencies below 3 GHz and below ± 2% for frequencies between 3-6 GHz at any distance larger than half the probe tip diameter from the boundary.

Frequency Response of E-Field (TEM-Cell:ifi110 EXX, Waveguide: R22)

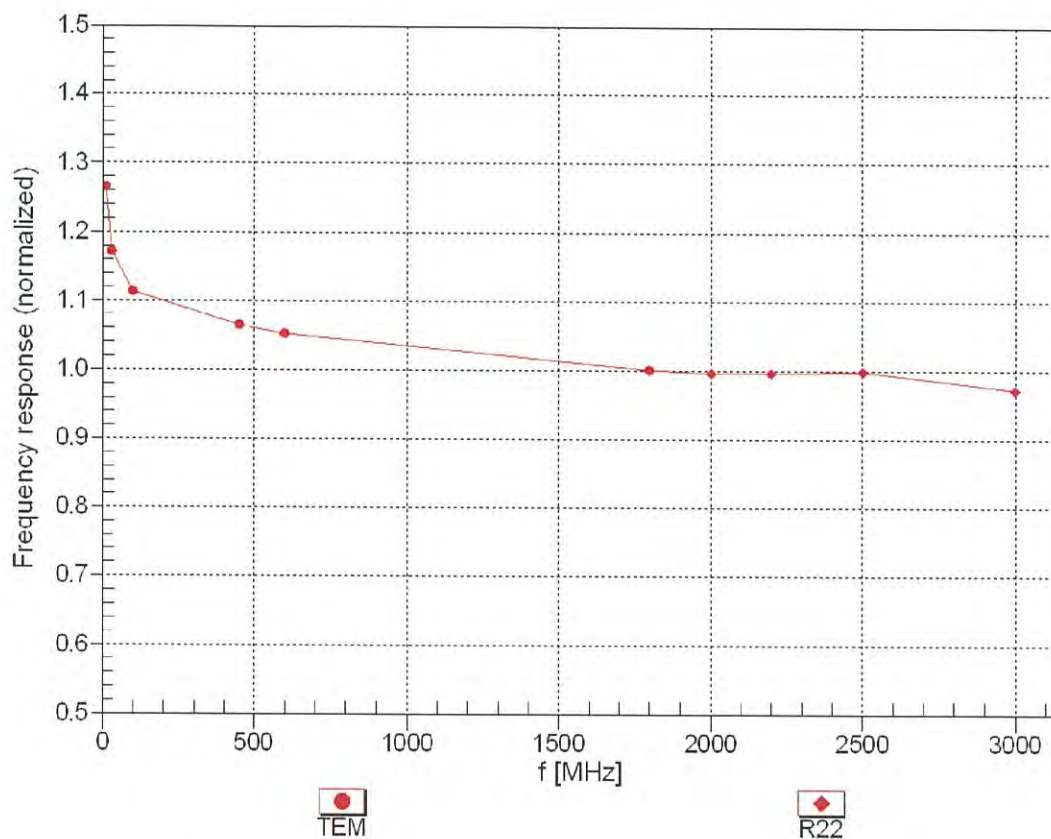

Uncertainty of Frequency Response of E-field: $\pm 6.3\%$ (k=2)

Receiving Pattern (ϕ), $\vartheta = 0^\circ$

f=600 MHz,TEM

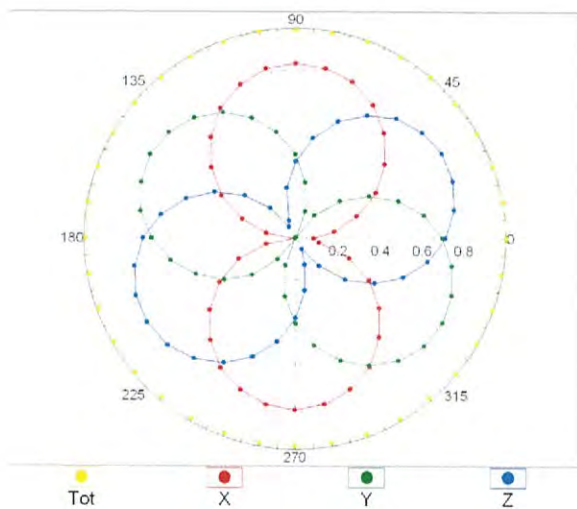

f=1800 MHz,R22

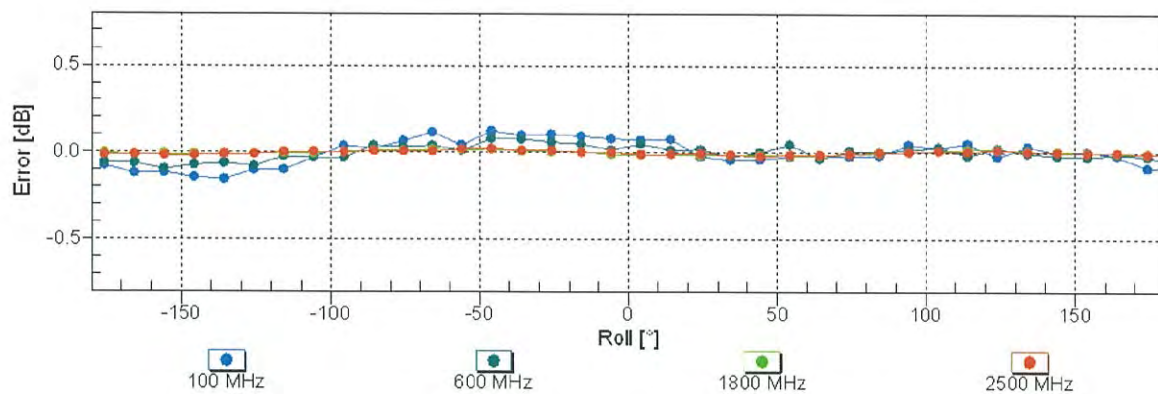
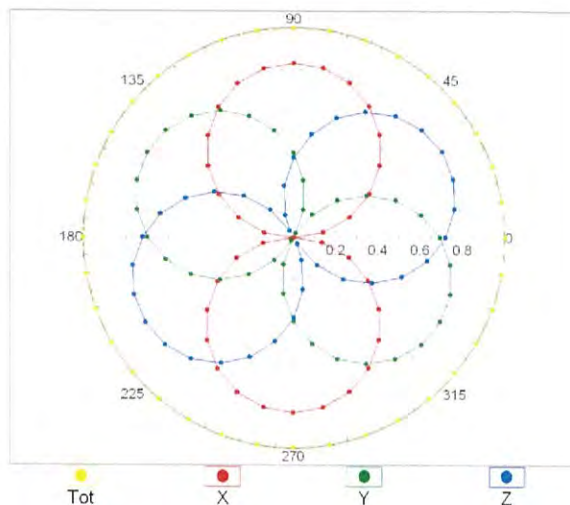

Uncertainty of Axial Isotropy Assessment: $\pm 0.5\%$ ($k=2$)

Dynamic Range $f(SAR_{head})$ (TEM cell, $f_{eval} = 1900$ MHz)

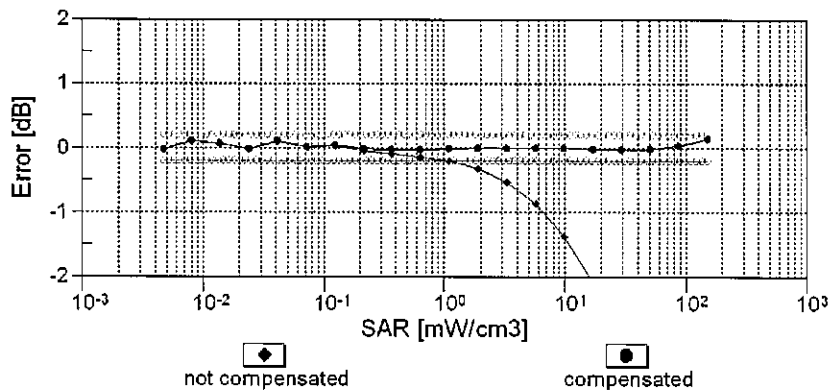
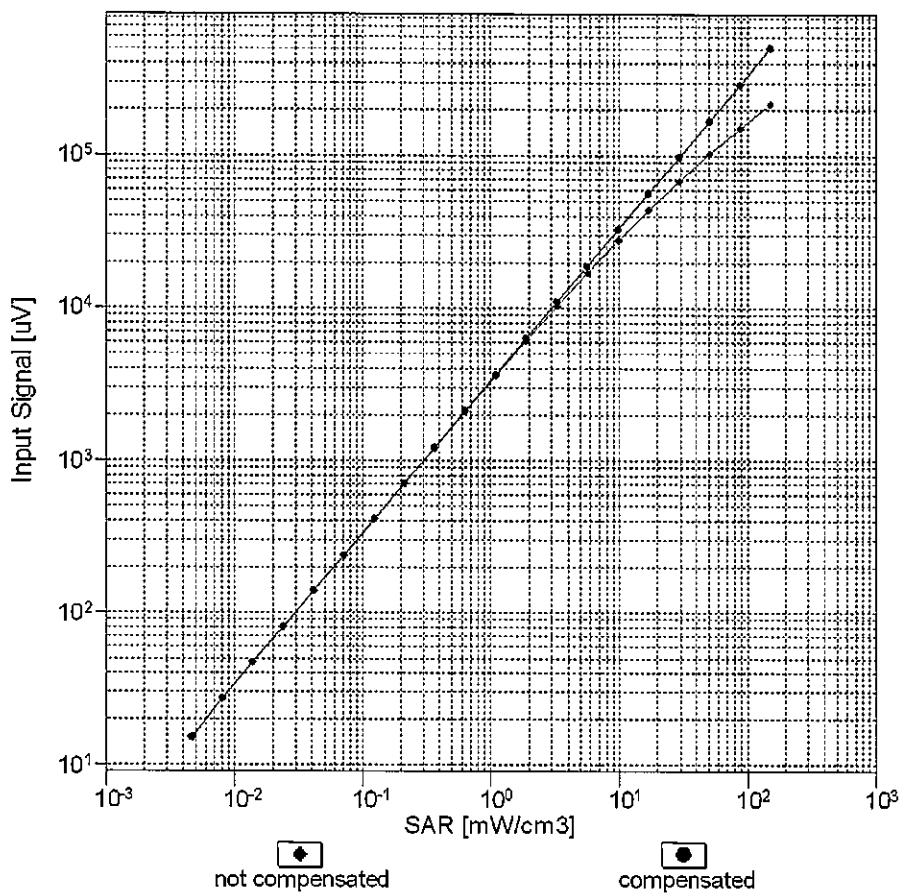

Uncertainty of Linearity Assessment: ± 0.6% (k=2)

Conversion Factor Assessment

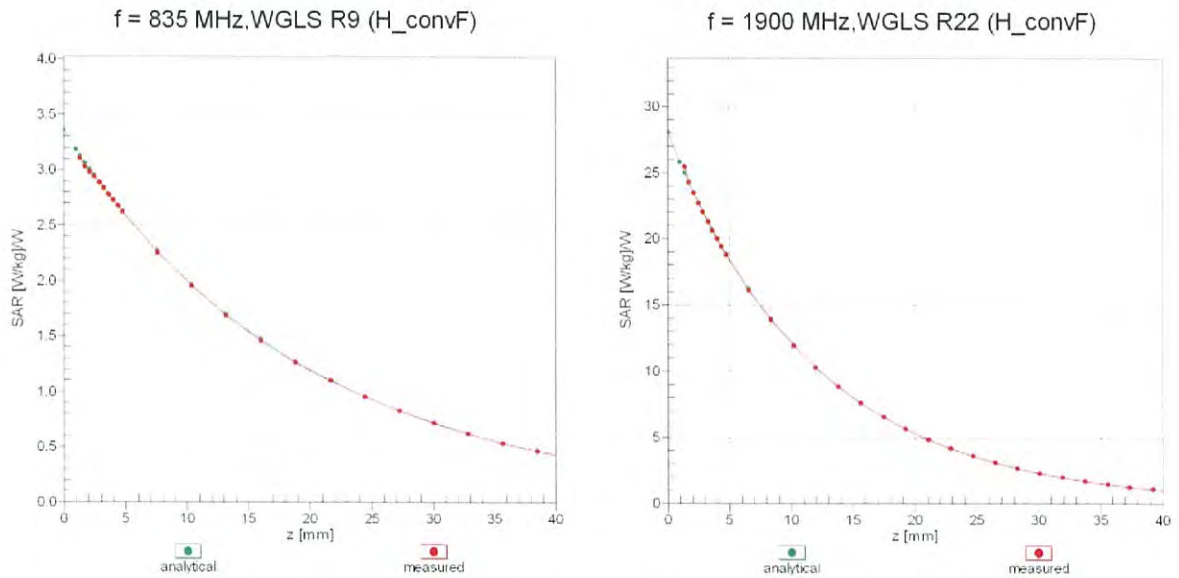

Deviation from Isotropy in Liquid Error (ϕ, θ), f = 900 MHz

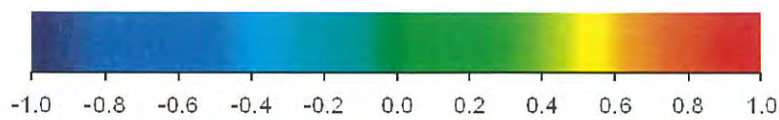
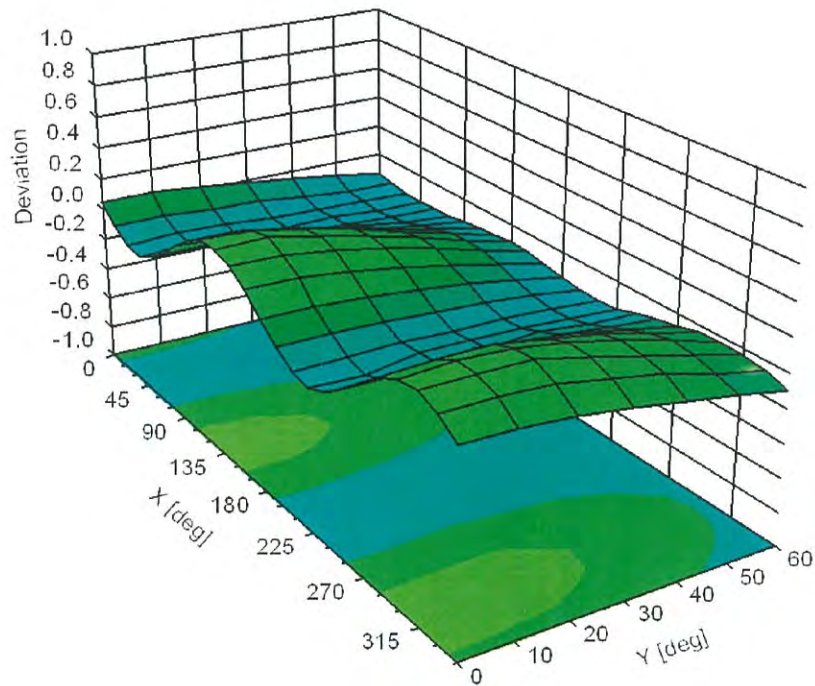

Uncertainty of Spherical Isotropy Assessment: $\pm 2.6\%$ (k=2)

DASY/EASY - Parameters of Probe: EX3DV4 - SN:3979**Other Probe Parameters**

Sensor Arrangement	Triangular
Connector Angle (°)	-45.8
Mechanical Surface Detection Mode	enabled
Optical Surface Detection Mode	disabled
Probe Overall Length	337 mm
Probe Body Diameter	10 mm
Tip Length	9 mm
Tip Diameter	2.5 mm
Probe Tip to Sensor X Calibration Point	1 mm
Probe Tip to Sensor Y Calibration Point	1 mm
Probe Tip to Sensor Z Calibration Point	1 mm
Recommended Measurement Distance from Surface	1.4 mm



Appendix E. Dipole Calibration

Validation Dipole 2450 MHz

M/N: D2450V2

S/N: 930

13984

**Calibration Laboratory of
Schmid & Partner
Engineering AG**
Zeughausstrasse 43, 8004 Zurich, Switzerland



S Schweizerischer Kalibrierdienst
C Service suisse d'étalonnage
S Servizio svizzero di taratura
S Swiss Calibration Service

Accredited by the Swiss Accreditation Service (SAS)
The Swiss Accreditation Service is one of the signatories to the EA
Multilateral Agreement for the recognition of calibration certificates

Accreditation No.: **SCS 0108**

Client **Quietek (Auden)**

Certificate No: **D2450V2-930_Nov16**

CALIBRATION CERTIFICATE

Object **D2450V2 - SN:930**

Calibration procedure(s) **QA CAL-05.v9
Calibration procedure for dipole validation kits above 700 MHz**

Calibration date: **November 15, 2016**

This calibration certificate documents the traceability to national standards, which realize the physical units of measurements (SI).
The measurements and the uncertainties with confidence probability are given on the following pages and are part of the certificate.

All calibrations have been conducted in the closed laboratory facility: environment temperature (22 ± 3)°C and humidity < 70%.

Calibration Equipment used (M&TE critical for calibration)

Primary Standards	ID #	Cal Date (Certificate No.)	Scheduled Calibration
Power meter NRP	SN: 104778	06-Apr-16 (No. 217-02288/02289)	Apr-17
Power sensor NRP-Z91	SN: 103244	06-Apr-16 (No. 217-02288)	Apr-17
Power sensor NRP-Z91	SN: 103245	06-Apr-16 (No. 217-02289)	Apr-17
Reference 20 dB Attenuator	SN: 5058 (20k)	05-Apr-16 (No. 217-02292)	Apr-17
Type-N mismatch combination	SN: 5047.2 / 06327	05-Apr-16 (No. 217-02295)	Apr-17
Reference Probe EX3DV4	SN: 7349	15-Jun-16 (No. EX3-7349_Jun16)	Jun-17
DAE4	SN: 601	30-Dec-15 (No. DAE4-601_Dec15)	Dec-16
Secondary Standards	ID #	Check Date (in house)	Scheduled Check
Power meter EPM-442A	SN: GB37480704	07-Oct-15 (in house check Oct-16)	In house check: Oct-18
Power sensor HP 8481A	SN: US37292783	07-Oct-15 (in house check Oct-16)	In house check: Oct-18
Power sensor HP 8481A	SN: MY41092317	07-Oct-15 (in house check Oct-16)	In house check: Oct-18
RF generator R&S SMT-06	SN: 100972	15-Jun-15 (in house check Oct-16)	In house check: Oct-18
Network Analyzer HP 8753E	SN: US37390585	18-Oct-01 (in house check Oct-16)	In house check: Oct-17

Calibrated by: **Michael Weber** Name: Michael Weber Function: Laboratory Technician

Approved by: **Katja Pokovic** Name: Katja Pokovic Function: Technical Manager

Issued: November 16, 2016

This calibration certificate shall not be reproduced except in full without written approval of the laboratory.



Accredited by the Swiss Accreditation Service (SAS)
The Swiss Accreditation Service is one of the signatories to the EA
Multilateral Agreement for the recognition of calibration certificates

Accreditation No.: **SCS 0108**

Glossary:

TSL tissue simulating liquid
ConvF sensitivity in TSL / NORM x,y,z
N/A not applicable or not measured

Calibration is Performed According to the Following Standards:

- a) IEEE Std 1528-2013, "IEEE Recommended Practice for Determining the Peak Spatial-Averaged Specific Absorption Rate (SAR) in the Human Head from Wireless Communications Devices: Measurement Techniques", June 2013
- b) IEC 62209-1, "Procedure to measure the Specific Absorption Rate (SAR) for hand-held devices used in close proximity to the ear (frequency range of 300 MHz to 3 GHz)", February 2005
- c) IEC 62209-2, "Procedure to determine the Specific Absorption Rate (SAR) for wireless communication devices used in close proximity to the human body (frequency range of 30 MHz to 6 GHz)", March 2010
- d) KDB 865664, "SAR Measurement Requirements for 100 MHz to 6 GHz"

Additional Documentation:

- e) DASY4/5 System Handbook

Methods Applied and Interpretation of Parameters:

- *Measurement Conditions:* Further details are available from the Validation Report at the end of the certificate. All figures stated in the certificate are valid at the frequency indicated.
- *Antenna Parameters with TSL:* The dipole is mounted with the spacer to position its feed point exactly below the center marking of the flat phantom section, with the arms oriented parallel to the body axis.
- *Feed Point Impedance and Return Loss:* These parameters are measured with the dipole positioned under the liquid filled phantom. The impedance stated is transformed from the measurement at the SMA connector to the feed point. The Return Loss ensures low reflected power. No uncertainty required.
- *Electrical Delay:* One-way delay between the SMA connector and the antenna feed point. No uncertainty required.
- *SAR measured:* SAR measured at the stated antenna input power.
- *SAR normalized:* SAR as measured, normalized to an input power of 1 W at the antenna connector.
- *SAR for nominal TSL parameters:* The measured TSL parameters are used to calculate the nominal SAR result.

The reported uncertainty of measurement is stated as the standard uncertainty of measurement multiplied by the coverage factor $k=2$, which for a normal distribution corresponds to a coverage probability of approximately 95%.

Measurement Conditions

DASY system configuration, as far as not given on page 1.

DASY Version	DASY5	V52.8.8
Extrapolation	Advanced Extrapolation	
Phantom	Modular Flat Phantom	
Distance Dipole Center - TSL	10 mm	with Spacer
Zoom Scan Resolution	dx, dy, dz = 5 mm	
Frequency	2450 MHz \pm 1 MHz	

Head TSL parameters

The following parameters and calculations were applied.

	Temperature	Permittivity	Conductivity
Nominal Head TSL parameters	22.0 °C	39.2	1.80 mho/m
Measured Head TSL parameters	(22.0 \pm 0.2) °C	38.1 \pm 6 %	1.87 mho/m \pm 6 %
Head TSL temperature change during test	< 0.5 °C	----	----

SAR result with Head TSL

SAR averaged over 1 cm³ (1 g) of Head TSL	Condition	
SAR measured	250 mW input power	13.0 W/kg
SAR for nominal Head TSL parameters	normalized to 1W	50.7 W/kg \pm 17.0 % (k=2)

SAR averaged over 10 cm³ (10 g) of Head TSL	condition	
SAR measured	250 mW input power	6.04 W/kg
SAR for nominal Head TSL parameters	normalized to 1W	23.8 W/kg \pm 16.5 % (k=2)

Body TSL parameters

The following parameters and calculations were applied.

	Temperature	Permittivity	Conductivity
Nominal Body TSL parameters	22.0 °C	52.7	1.95 mho/m
Measured Body TSL parameters	(22.0 \pm 0.2) °C	51.1 \pm 6 %	2.00 mho/m \pm 6 %
Body TSL temperature change during test	< 0.5 °C	----	----

SAR result with Body TSL

SAR averaged over 1 cm³ (1 g) of Body TSL	Condition	
SAR measured	250 mW input power	12.9 W/kg
SAR for nominal Body TSL parameters	normalized to 1W	50.6 W/kg \pm 17.0 % (k=2)

SAR averaged over 10 cm³ (10 g) of Body TSL	condition	
SAR measured	250 mW input power	6.05 W/kg
SAR for nominal Body TSL parameters	normalized to 1W	23.9 W/kg \pm 16.5 % (k=2)

Appendix (Additional assessments outside the scope of SCS 0108)

Antenna Parameters with Head TSL

Impedance, transformed to feed point	54.9 Ω + 2.2 j Ω
Return Loss	- 25.8 dB

Antenna Parameters with Body TSL

Impedance, transformed to feed point	50.0 Ω + 4.0 j Ω
Return Loss	- 28.0 dB

General Antenna Parameters and Design

Electrical Delay (one direction)	1.157 ns
----------------------------------	----------

After long term use with 100W radiated power, only a slight warming of the dipole near the feedpoint can be measured.

The dipole is made of standard semirigid coaxial cable. The center conductor of the feeding line is directly connected to the second arm of the dipole. The antenna is therefore short-circuited for DC-signals. On some of the dipoles, small end caps are added to the dipole arms in order to improve matching when loaded according to the position as explained in the "Measurement Conditions" paragraph. The SAR data are not affected by this change. The overall dipole length is still according to the Standard.

No excessive force must be applied to the dipole arms, because they might bend or the soldered connections near the feedpoint may be damaged.

Additional EUT Data

Manufactured by	SPEAG
Manufactured on	September 26, 2013

DASY5 Validation Report for Head TSL

Date: 15.11.2016

Test Laboratory: SPEAG, Zurich, Switzerland

DUT: Dipole 2450 MHz; Type: D2450V2; Serial: D2450V2 - SN: 930

Communication System: UID 0 - CW; Frequency: 2450 MHz

Medium parameters used: $f = 2450$ MHz; $\sigma = 1.87$ S/m; $\epsilon_r = 38.1$; $\rho = 1000$ kg/m³

Phantom section: Flat Section

Measurement Standard: DASY5 (IEEE/IEC/ANSI C63.19-2011)

DASY52 Configuration:

- Probe: EX3DV4 - SN7349; ConvF(7.72, 7.72, 7.72); Calibrated: 15.06.2016;
- Sensor-Surface: 1.4mm (Mechanical Surface Detection)
- Electronics: DAE4 Sn601; Calibrated: 30.12.2015
- Phantom: Flat Phantom 5.0 (front); Type: QD000P50AA; Serial: 1001
- DASY52 52.8.8(1258); SEMCAD X 14.6.10(7372)

Dipole Calibration for Head Tissue/Pin=250 mW, d=10mm/Zoom Scan (7x7x7)/Cube 0:

Measurement grid: dx=5mm, dy=5mm, dz=5mm

Reference Value = 112.5 V/m; Power Drift = -0.05 dB

Peak SAR (extrapolated) = 26.5 W/kg

SAR(1 g) = 13 W/kg; SAR(10 g) = 6.04 W/kg

Maximum value of SAR (measured) = 21.5 W/kg

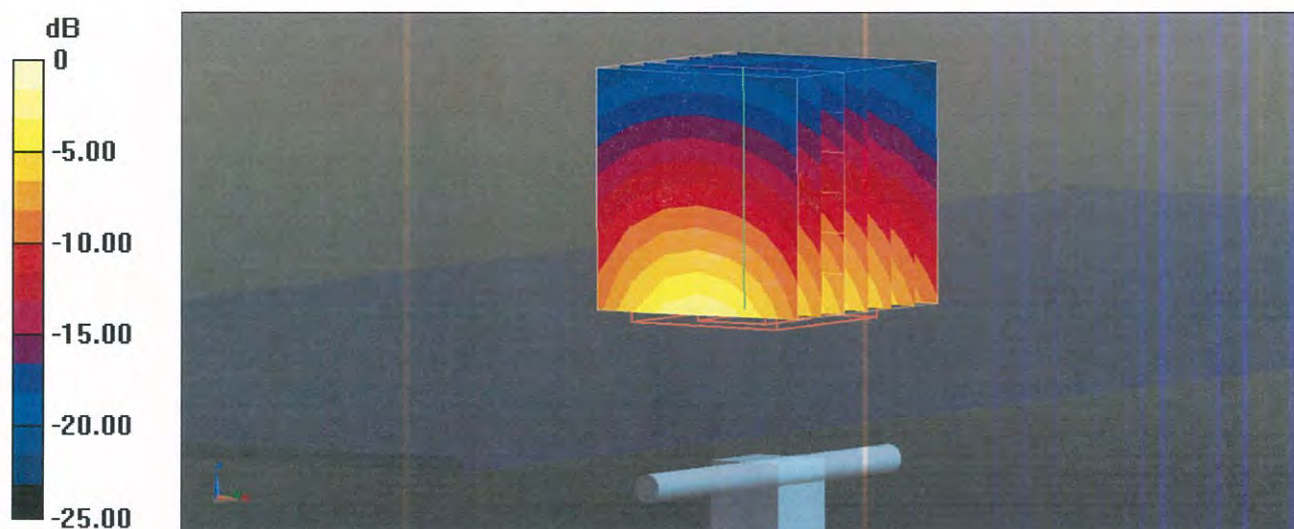

Impedance Measurement Plot for Head TSL

15 Nov 2016 15:28:58

CH1 S11 1 U FS 1: 54.889 Ω 2.1738 Ω 141.21 μH 2 450.000 000 MHz

*
Del

CA

Avg
16

H1d

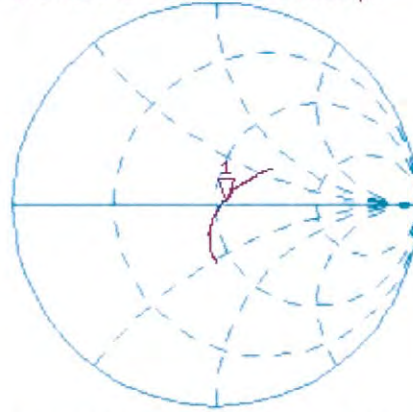

CH2 S11 LOG 5 dB/REF -20 dB 1:-25.846 dB 2 450.000 000 MHz

CA

Avg
16

H1d

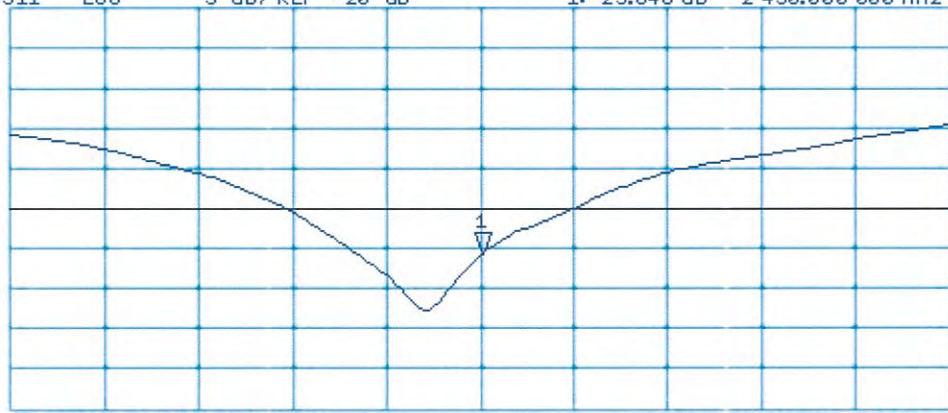

START 2 250.000 000 MHz

STOP 2 650.000 000 MHz

DASY5 Validation Report for Body TSL

Date: 15.11.2016

Test Laboratory: SPEAG, Zurich, Switzerland

DUT: Dipole 2450 MHz; Type: D2450V2; Serial: D2450V2 - SN: 930

Communication System: UID 0 - CW; Frequency: 2450 MHz

Medium parameters used: $f = 2450$ MHz; $\sigma = 2$ S/m; $\epsilon_r = 51.1$; $\rho = 1000$ kg/m³

Phantom section: Flat Section

Measurement Standard: DASY5 (IEEE/IEC/ANSI C63.19-2011)

DASY52 Configuration:

- Probe: EX3DV4 - SN7349; ConvF(7.79, 7.79, 7.79); Calibrated: 15.06.2016;
- Sensor-Surface: 1.4mm (Mechanical Surface Detection)
- Electronics: DAE4 Sn601; Calibrated: 30.12.2015
- Phantom: Flat Phantom 5.0 (back); Type: QD000P50AA; Serial: 1002
- DASY52 52.8.8(1258); SEMCAD X 14.6.10(7372)

Dipole Calibration for Body Tissue/Pin=250 mW, d=10mm/Zoom Scan (7x7x7)/Cube 0:

Measurement grid: dx=5mm, dy=5mm, dz=5mm

Reference Value = 107.4 V/m; Power Drift = -0.02 dB

Peak SAR (extrapolated) = 25.8 W/kg

SAR(1 g) = 12.9 W/kg; SAR(10 g) = 6.05 W/kg

Maximum value of SAR (measured) = 21.2 W/kg

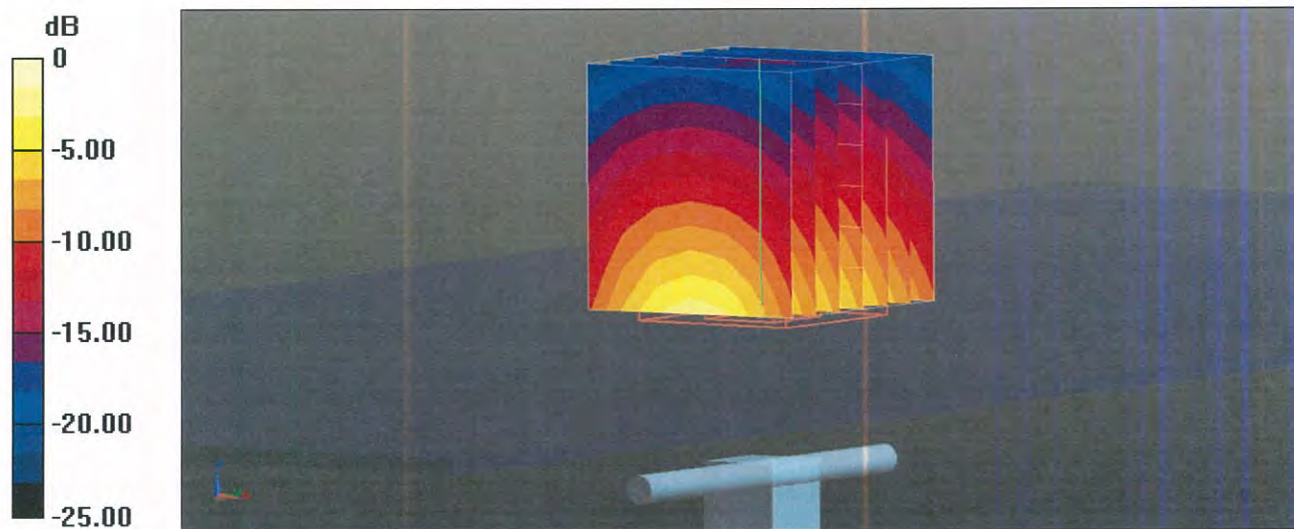

0 dB = 21.2 W/kg = 13.26 dBW/kg

Impedance Measurement Plot for Body TSL

15 Nov 2016 15:28:24

CH1 S11 1 U FS 1: 50.025 Ω 3.9863 Ω 258.96 μH 2 450.000 000 MHz

*
De1

CA

Avg
16

H1d

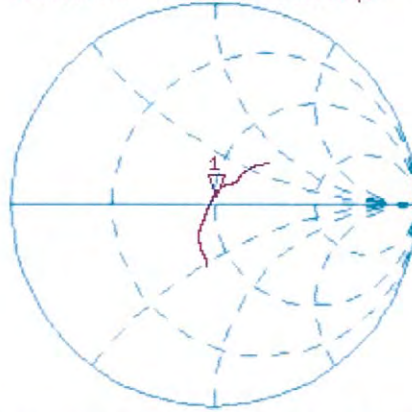

CH2 S11 LOG 5 dB/REF -20 dB 1: -27.983 dB 2 450.000 000 MHz

CA

Avg
16

H1d

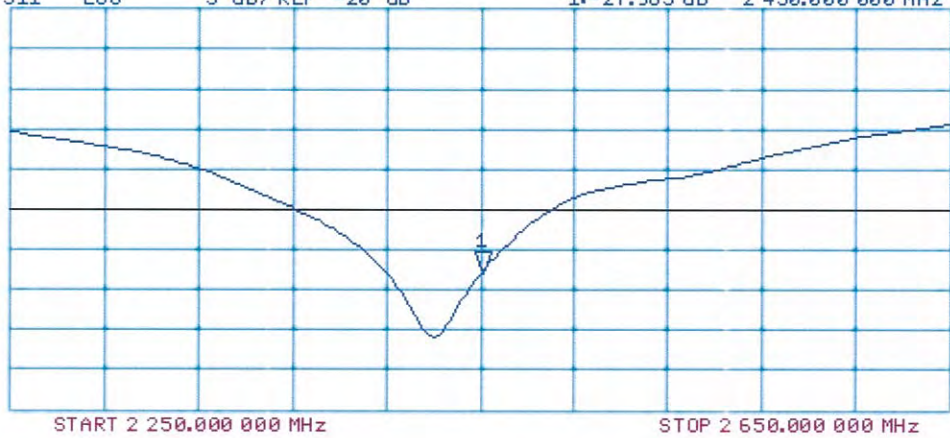



Appendix E. Dipole Calibration

Validation Dipole 5 GHz

M/N: D5GHzV2

S/N: 1041

113211

**Calibration Laboratory of
Schmid & Partner
Engineering AG**
Zeughausstrasse 43, 8004 Zurich, Switzerland



S Schweizerischer Kalibrierdienst
S Service suisse d'étalonnage
C Servizio svizzero di taratura
S Swiss Calibration Service

Accredited by the Swiss Accreditation Service (SAS)
The Swiss Accreditation Service is one of the signatories to the EA
Multilateral Agreement for the recognition of calibration certificates

Accreditation No.: **SCS 0108**

Client **DEKRA (Auden)**

Certificate No: **D5GHzV2-1041_May17**

CALIBRATION CERTIFICATE

Object **D5GHzV2 - SN:1041**

Calibration procedure(s) **QA CAL-22.v2
Calibration procedure for dipole validation kits between 3-6 GHz**

Calibration date: **May 26, 2017**

This calibration certificate documents the traceability to national standards, which realize the physical units of measurements (SI). The measurements and the uncertainties with confidence probability are given on the following pages and are part of the certificate.

All calibrations have been conducted in the closed laboratory facility: environment temperature (22 ± 3)°C and humidity < 70%.

Calibration Equipment used (M&TE critical for calibration)

Primary Standards	ID #	Cal Date (Certificate No.)	Scheduled Calibration
Power meter NRP	SN: 104778	04-Apr-17 (No. 217-02521/02522)	Apr-18
Power sensor NRP-Z91	SN: 103244	04-Apr-17 (No. 217-02521)	Apr-18
Power sensor NRP-Z91	SN: 103245	04-Apr-17 (No. 217-02522)	Apr-18
Reference 20 dB Attenuator	SN: 5058 (20k)	07-Apr-17 (No. 217-02528)	Apr-18
Type-N mismatch combination	SN: 5047.2 / 06327	07-Apr-17 (No. 217-02529)	Apr-18
Reference Probe EX3DV4	SN: 3503	31-Dec-16 (No. EX3-3503_Dec16)	Dec-17
DAE4	SN: 601	28-Mar-17 (No. DAE4-601_Mar17)	Mar-18
Secondary Standards	ID #	Check Date (in house)	Scheduled Check
Power meter EPM-442A	SN: GB37480704	07-Oct-15 (in house check Oct-16)	In house check: Oct-18
Power sensor HP 8481A	SN: US37292783	07-Oct-15 (in house check Oct-16)	In house check: Oct-18
Power sensor HP 8481A	SN: MY41092317	07-Oct-15 (in house check Oct-16)	In house check: Oct-18
RF generator R&S SMT-06	SN: 100972	15-Jun-15 (in house check Oct-16)	In house check: Oct-18
Network Analyzer HP 8753E	SN: US37390585	18-Oct-01 (in house check Oct-16)	In house check: Oct-17

Calibrated by:	Name Johannes Kurikka	Function Laboratory Technician	Signature
Approved by:	Name Katja Pokovic	Function Technical Manager	Signature

Issued: June 14, 2017

This calibration certificate shall not be reproduced except in full without written approval of the laboratory.



Accredited by the Swiss Accreditation Service (SAS)

Accreditation No.: **SCS 0108**

The Swiss Accreditation Service is one of the signatories to the EA Multilateral Agreement for the recognition of calibration certificates

Glossary:

TSL	tissue simulating liquid
ConvF	sensitivity in TSL / NORM x,y,z
N/A	not applicable or not measured

Calibration is Performed According to the Following Standards:

- IEEE Std 1528-2013, "IEEE Recommended Practice for Determining the Peak Spatial-Averaged Specific Absorption Rate (SAR) in the Human Head from Wireless Communications Devices: Measurement Techniques", June 2013
- IEC 62209-1, "Measurement procedure for the assessment of Specific Absorption Rate (SAR) from hand-held and body-mounted devices used next to the ear (frequency range of 300 MHz to 6 GHz)", July 2016
- IEC 62209-2, "Procedure to determine the Specific Absorption Rate (SAR) for wireless communication devices used in close proximity to the human body (frequency range of 30 MHz to 6 GHz)", March 2010
- KDB 865664, "SAR Measurement Requirements for 100 MHz to 6 GHz"

Additional Documentation:

- DASY4/5 System Handbook

Methods Applied and Interpretation of Parameters:

- Measurement Conditions:** Further details are available from the Validation Report at the end of the certificate. All figures stated in the certificate are valid at the frequency indicated.
- Antenna Parameters with TSL:** The dipole is mounted with the spacer to position its feed point exactly below the center marking of the flat phantom section, with the arms oriented parallel to the body axis.
- Feed Point Impedance and Return Loss:** These parameters are measured with the dipole positioned under the liquid filled phantom. The impedance stated is transformed from the measurement at the SMA connector to the feed point. The Return Loss ensures low reflected power. No uncertainty required.
- Electrical Delay:** One-way delay between the SMA connector and the antenna feed point. No uncertainty required.
- SAR measured:** SAR measured at the stated antenna input power.
- SAR normalized:** SAR as measured, normalized to an input power of 1 W at the antenna connector.
- SAR for nominal TSL parameters:** The measured TSL parameters are used to calculate the nominal SAR result.

The reported uncertainty of measurement is stated as the standard uncertainty of measurement multiplied by the coverage factor $k=2$, which for a normal distribution corresponds to a coverage probability of approximately 95%.

Measurement Conditions

DASY system configuration, as far as not given on page 1.

DASY Version	DASY5	V52.10.0
Extrapolation	Advanced Extrapolation	
Phantom	Modular Flat Phantom V5.0	
Distance Dipole Center - TSL	10 mm	with Spacer
Zoom Scan Resolution	dx, dy = 4.0 mm, dz = 1.4 mm	Graded Ratio = 1.4 (Z direction)
Frequency	5200 MHz ± 1 MHz 5300 MHz ± 1 MHz 5500 MHz ± 1 MHz 5600 MHz ± 1 MHz 5800 MHz ± 1 MHz	

Head TSL parameters at 5200 MHz

The following parameters and calculations were applied.

	Temperature	Permittivity	Conductivity
Nominal Head TSL parameters	22.0 °C	36.0	4.66 mho/m
Measured Head TSL parameters	(22.0 ± 0.2) °C	34.8 ± 6 %	4.55 mho/m ± 6 %
Head TSL temperature change during test	< 0.5 °C	----	----

SAR result with Head TSL at 5200 MHz

SAR averaged over 1 cm ³ (1 g) of Head TSL	Condition	
SAR measured	100 mW input power	8.20 W/kg
SAR for nominal Head TSL parameters	normalized to 1W	81.4 W/kg ± 19.9 % (k=2)

SAR averaged over 10 cm ³ (10 g) of Head TSL	condition	
SAR measured	100 mW input power	2.34 W/kg
SAR for nominal Head TSL parameters	normalized to 1W	23.2 W/kg ± 19.5 % (k=2)

Head TSL parameters at 5300 MHz

The following parameters and calculations were applied.

	Temperature	Permittivity	Conductivity
Nominal Head TSL parameters	22.0 °C	35.9	4.76 mho/m
Measured Head TSL parameters	(22.0 ± 0.2) °C	34.7 ± 6 %	4.64 mho/m ± 6 %
Head TSL temperature change during test	< 0.5 °C	----	----

SAR result with Head TSL at 5300 MHz

SAR averaged over 1 cm ³ (1 g) of Head TSL	Condition	
SAR measured	100 mW input power	8.36 W/kg
SAR for nominal Head TSL parameters	normalized to 1W	83.0 W / kg ± 19.9 % (k=2)

SAR averaged over 10 cm ³ (10 g) of Head TSL	condition	
SAR measured	100 mW input power	2.40 W/kg
SAR for nominal Head TSL parameters	normalized to 1W	23.8 W/kg ± 19.5 % (k=2)

Head TSL parameters at 5500 MHz

The following parameters and calculations were applied.

	Temperature	Permittivity	Conductivity
Nominal Head TSL parameters	22.0 °C	35.6	4.96 mho/m
Measured Head TSL parameters	(22.0 ± 0.2) °C	34.4 ± 6 %	4.84 mho/m ± 6 %
Head TSL temperature change during test	< 0.5 °C	----	----

SAR result with Head TSL at 5500 MHz

SAR averaged over 1 cm ³ (1 g) of Head TSL	Condition	
SAR measured	100 mW input power	8.47 W/kg
SAR for nominal Head TSL parameters	normalized to 1W	84.0 W/kg ± 19.9 % (k=2)

SAR averaged over 10 cm ³ (10 g) of Head TSL	condition	
SAR measured	100 mW input power	2.40 W/kg
SAR for nominal Head TSL parameters	normalized to 1W	23.8 W/kg ± 19.5 % (k=2)

Head TSL parameters at 5600 MHz

The following parameters and calculations were applied.

	Temperature	Permittivity	Conductivity
Nominal Head TSL parameters	22.0 °C	35.5	5.07 mho/m
Measured Head TSL parameters	(22.0 ± 0.2) °C	34.2 ± 6 %	4.95 mho/m ± 6 %
Head TSL temperature change during test	< 0.5 °C	----	----

SAR result with Head TSL at 5600 MHz

SAR averaged over 1 cm ³ (1 g) of Head TSL	Condition	
SAR measured	100 mW input power	8.75 W/kg
SAR for nominal Head TSL parameters	normalized to 1W	86.7 W/kg ± 19.9 % (k=2)

SAR averaged over 10 cm ³ (10 g) of Head TSL	condition	
SAR measured	100 mW input power	2.48 W/kg
SAR for nominal Head TSL parameters	normalized to 1W	24.5 W/kg ± 19.5 % (k=2)

Head TSL parameters at 5800 MHz

The following parameters and calculations were applied.

	Temperature	Permittivity	Conductivity
Nominal Head TSL parameters	22.0 °C	35.3	5.27 mho/m
Measured Head TSL parameters	(22.0 ± 0.2) °C	34.0 ± 6 %	5.16 mho/m ± 6 %
Head TSL temperature change during test	< 0.5 °C	----	----

SAR result with Head TSL at 5800 MHz

SAR averaged over 1 cm ³ (1 g) of Head TSL	Condition	
SAR measured	100 mW input power	8.38 W/kg
SAR for nominal Head TSL parameters	normalized to 1W	83.1 W/kg ± 19.9 % (k=2)

SAR averaged over 10 cm ³ (10 g) of Head TSL	condition	
SAR measured	100 mW input power	2.37 W/kg
SAR for nominal Head TSL parameters	normalized to 1W	23.5 W/kg ± 19.5 % (k=2)

Body TSL parameters at 5200 MHz

The following parameters and calculations were applied.

	Temperature	Permittivity	Conductivity
Nominal Body TSL parameters	22.0 °C	49.0	5.30 mho/m
Measured Body TSL parameters	(22.0 ± 0.2) °C	47.6 ± 6 %	5.44 mho/m ± 6 %
Body TSL temperature change during test	< 0.5 °C	----	----

SAR result with Body TSL at 5200 MHz

SAR averaged over 1 cm ³ (1 g) of Body TSL	Condition	
SAR measured	100 mW input power	7.51 W/kg
SAR for nominal Body TSL parameters	normalized to 1W	74.7 W/kg ± 19.9 % (k=2)

SAR averaged over 10 cm ³ (10 g) of Body TSL	condition	
SAR measured	100 mW input power	2.11 W/kg
SAR for nominal Body TSL parameters	normalized to 1W	21.0 W/kg ± 19.5 % (k=2)

Body TSL parameters at 5300 MHz

The following parameters and calculations were applied.

	Temperature	Permittivity	Conductivity
Nominal Body TSL parameters	22.0 °C	48.9	5.42 mho/m
Measured Body TSL parameters	(22.0 ± 0.2) °C	47.4 ± 6 %	5.57 mho/m ± 6 %
Body TSL temperature change during test	< 0.5 °C	----	----

SAR result with Body TSL at 5300 MHz

SAR averaged over 1 cm ³ (1 g) of Body TSL	Condition	
SAR measured	100 mW input power	7.81 W/kg
SAR for nominal Body TSL parameters	normalized to 1W	77.7 W/kg ± 19.9 % (k=2)

SAR averaged over 10 cm ³ (10 g) of Body TSL	condition	
SAR measured	100 mW input power	2.20 W/kg
SAR for nominal Body TSL parameters	normalized to 1W	21.9 W/kg ± 19.5 % (k=2)

Body TSL parameters at 5500 MHz

The following parameters and calculations were applied.

	Temperature	Permittivity	Conductivity
Nominal Body TSL parameters	22.0 °C	48.6	5.65 mho/m
Measured Body TSL parameters	(22.0 ± 0.2) °C	47.0 ± 6 %	5.84 mho/m ± 6 %
Body TSL temperature change during test	< 0.5 °C	----	----

SAR result with Body TSL at 5500 MHz

SAR averaged over 1 cm ³ (1 g) of Body TSL	Condition	
SAR measured	100 mW input power	8.14 W/kg
SAR for nominal Body TSL parameters	normalized to 1W	81.0 W/kg ± 19.9 % (k=2)

SAR averaged over 10 cm ³ (10 g) of Body TSL	condition	
SAR measured	100 mW input power	2.26 W/kg
SAR for nominal Body TSL parameters	normalized to 1W	22.4 W/kg ± 19.5 % (k=2)

Body TSL parameters at 5600 MHz

The following parameters and calculations were applied.

	Temperature	Permittivity	Conductivity
Nominal Body TSL parameters	22.0 °C	48.5	5.77 mho/m
Measured Body TSL parameters	(22.0 ± 0.2) °C	46.9 ± 6 %	5.98 mho/m ± 6 %
Body TSL temperature change during test	< 0.5 °C	----	----

SAR result with Body TSL at 5600 MHz

SAR averaged over 1 cm ³ (1 g) of Body TSL	Condition	
SAR measured	100 mW input power	8.13 W/kg
SAR for nominal Body TSL parameters	normalized to 1W	80.9 W/kg ± 19.9 % (k=2)

SAR averaged over 10 cm ³ (10 g) of Body TSL	condition	
SAR measured	100 mW input power	2.28 W/kg
SAR for nominal Body TSL parameters	normalized to 1W	22.6 W/kg ± 19.5 % (k=2)

Body TSL parameters at 5800 MHz

The following parameters and calculations were applied.

	Temperature	Permittivity	Conductivity
Nominal Body TSL parameters	22.0 °C	48.2	6.00 mho/m
Measured Body TSL parameters	(22.0 ± 0.2) °C	46.5 ± 6 %	6.26 mho/m ± 6 %
Body TSL temperature change during test	< 0.5 °C	----	----

SAR result with Body TSL at 5800 MHz

SAR averaged over 1 cm ³ (1 g) of Body TSL	Condition	
SAR measured	100 mW input power	7.87 W/kg
SAR for nominal Body TSL parameters	normalized to 1W	78.3 W/kg ± 19.9 % (k=2)

SAR averaged over 10 cm ³ (10 g) of Body TSL	condition	
SAR measured	100 mW input power	2.19 W/kg
SAR for nominal Body TSL parameters	normalized to 1W	21.7 W/kg ± 19.5 % (k=2)

Appendix (Additional assessments outside the scope of SCS 0108)

Antenna Parameters with Head TSL at 5200 MHz

Impedance, transformed to feed point	49.8 Ω - 8.3 j Ω
Return Loss	- 21.6 dB

Antenna Parameters with Head TSL at 5300 MHz

Impedance, transformed to feed point	48.0 Ω - 2.8 j Ω
Return Loss	- 29.0 dB

Antenna Parameters with Head TSL at 5500 MHz

Impedance, transformed to feed point	51.0 Ω - 4.4 j Ω
Return Loss	- 26.9 dB

Antenna Parameters with Head TSL at 5600 MHz

Impedance, transformed to feed point	55.2 Ω - 1.6 j Ω
Return Loss	- 25.7 dB

Antenna Parameters with Head TSL at 5800 MHz

Impedance, transformed to feed point	56.2 Ω + 0.5 j Ω
Return Loss	- 24.6 dB

Antenna Parameters with Body TSL at 5200 MHz

Impedance, transformed to feed point	49.0 Ω - 6.2 j Ω
Return Loss	- 24.0 dB

Antenna Parameters with Body TSL at 5300 MHz

Impedance, transformed to feed point	48.4 Ω - 2.1 j Ω
Return Loss	- 31.5 dB

Antenna Parameters with Body TSL at 5500 MHz

Impedance, transformed to feed point	49.9 Ω - 2.3 j Ω
Return Loss	- 32.6 dB

Antenna Parameters with Body TSL at 5600 MHz

Impedance, transformed to feed point	56.5 Ω - 0.4 j Ω
Return Loss	- 24.3 dB

Antenna Parameters with Body TSL at 5800 MHz

Impedance, transformed to feed point	56.2 Ω + 0.1 j Ω
Return Loss	- 24.7 dB

General Antenna Parameters and Design

Electrical Delay (one direction)	1.199 ns
----------------------------------	----------

After long term use with 100W radiated power, only a slight warming of the dipole near the feedpoint can be measured.

The dipole is made of standard semirigid coaxial cable. The center conductor of the feeding line is directly connected to the second arm of the dipole. The antenna is therefore short-circuited for DC-signals. On some of the dipoles, small end caps are added to the dipole arms in order to improve matching when loaded according to the position as explained in the "Measurement Conditions" paragraph. The SAR data are not affected by this change. The overall dipole length is still according to the Standard.

No excessive force must be applied to the dipole arms, because they might bend or the soldered connections near the feedpoint may be damaged.

Additional EUT Data

Manufactured by	SPEAG
Manufactured on	December 30, 2005

DASY5 Validation Report for Head TSL

Date: 19.05.2017

Test Laboratory: SPEAG, Zurich, Switzerland

DUT: Dipole D5GHzV2; Type: D5GHzV2; Serial: D5GHzV2 - SN:1041

Communication System: UID 0 - CW; Frequency: 5200 MHz, Frequency: 5300 MHz, Frequency: 5500 MHz, Frequency: 5600 MHz, Frequency: 5800 MHz

Medium parameters used: $f = 5200$ MHz; $\sigma = 4.55$ S/m; $\epsilon_r = 34.8$; $\rho = 1000$ kg/m³, Medium parameters used: $f = 5300$ MHz; $\sigma = 4.64$ S/m; $\epsilon_r = 34.7$; $\rho = 1000$ kg/m³, Medium parameters used: $f = 5500$ MHz; $\sigma = 4.84$ S/m; $\epsilon_r = 34.4$; $\rho = 1000$ kg/m³, Medium parameters used: $f = 5600$ MHz; $\sigma = 4.95$ S/m; $\epsilon_r = 34.2$; $\rho = 1000$ kg/m³, Medium parameters used: $f = 5800$ MHz; $\sigma = 5.16$ S/m; $\epsilon_r = 34$; $\rho = 1000$ kg/m³

Phantom section: Flat Section

Measurement Standard: DASY5 (IEEE/IEC/ANSI C63.19-2011)

DASY52 Configuration:

- Probe: EX3DV4 - SN3503; ConvF(5.76, 5.76, 5.76); Calibrated: 31.12.2016, ConvF(5.35, 5.35, 5.35); Calibrated: 31.12.2016, ConvF(5.2, 5.2, 5.2); Calibrated: 31.12.2016, ConvF(5.09, 5.09, 5.09); Calibrated: 31.12.2016, ConvF(5.01, 5.01, 5.01); Calibrated: 31.12.2016;
- Sensor-Surface: 1.4mm (Mechanical Surface Detection)
- Electronics: DAE4 Sn601; Calibrated: 28.03.2017
- Phantom: Flat Phantom 5.0 (front); Type: QD000P50AA; Serial: 1001
- DASY52 52.10.0(1446); SEMCAD X 14.6.10(7417)

Dipole Calibration for Head Tissue/Pin=100mW, dist=10mm, f=5200 MHz/Zoom Scan,

dist=1.4mm (8x8x7)/Cube 0: Measurement grid: dx=4mm, dy=4mm, dz=1.4mm

Reference Value = 73.20 V/m; Power Drift = -0.08 dB

Peak SAR (extrapolated) = 30.6 W/kg

SAR(1 g) = 8.2 W/kg; SAR(10 g) = 2.34 W/kg

Maximum value of SAR (measured) = 19.2 W/kg

Dipole Calibration for Head Tissue/Pin=100mW, dist=10mm, f=5300 MHz/Zoom Scan,

dist=1.4mm (8x8x7)/Cube 0: Measurement grid: dx=4mm, dy=4mm, dz=1.4mm

Reference Value = 74.01 V/m; Power Drift = -0.06 dB

Peak SAR (extrapolated) = 30.3 W/kg

SAR(1 g) = 8.36 W/kg; SAR(10 g) = 2.4 W/kg

Maximum value of SAR (measured) = 19.4 W/kg

Dipole Calibration for Head Tissue/Pin=100mW, dist=10mm, f=5500 MHz/Zoom Scan,

dist=1.4mm (8x8x7)/Cube 0: Measurement grid: dx=4mm, dy=4mm, dz=1.4mm

Reference Value = 73.45 V/m; Power Drift = -0.06 dB

Peak SAR (extrapolated) = 33.2 W/kg

SAR(1 g) = 8.47 W/kg; SAR(10 g) = 2.4 W/kg

Maximum value of SAR (measured) = 20.2 W/kg

Dipole Calibration for Head Tissue/Pin=100mW, dist=10mm, f=5600 MHz/Zoom Scan,

dist=1.4mm (8x8x7)/Cube 0: Measurement grid: dx=4mm, dy=4mm, dz=1.4mm

Reference Value = 74.23 V/m; Power Drift = -0.02 dB

Peak SAR (extrapolated) = 34.9 W/kg

SAR(1 g) = 8.75 W/kg; SAR(10 g) = 2.48 W/kg

Maximum value of SAR (measured) = 21.0 W/kg

Dipole Calibration for Head Tissue/Pin=100mW, dist=10mm, f=5800 MHz/Zoom Scan,

dist=1.4mm (8x8x7)/Cube 0: Measurement grid: dx=4mm, dy=4mm, dz=1.4mm

Reference Value = 72.19 V/m; Power Drift = -0.02 dB

Peak SAR (extrapolated) = 34.5 W/kg

SAR(1 g) = 8.38 W/kg; SAR(10 g) = 2.37 W/kg

Maximum value of SAR (measured) = 20.4 W/kg

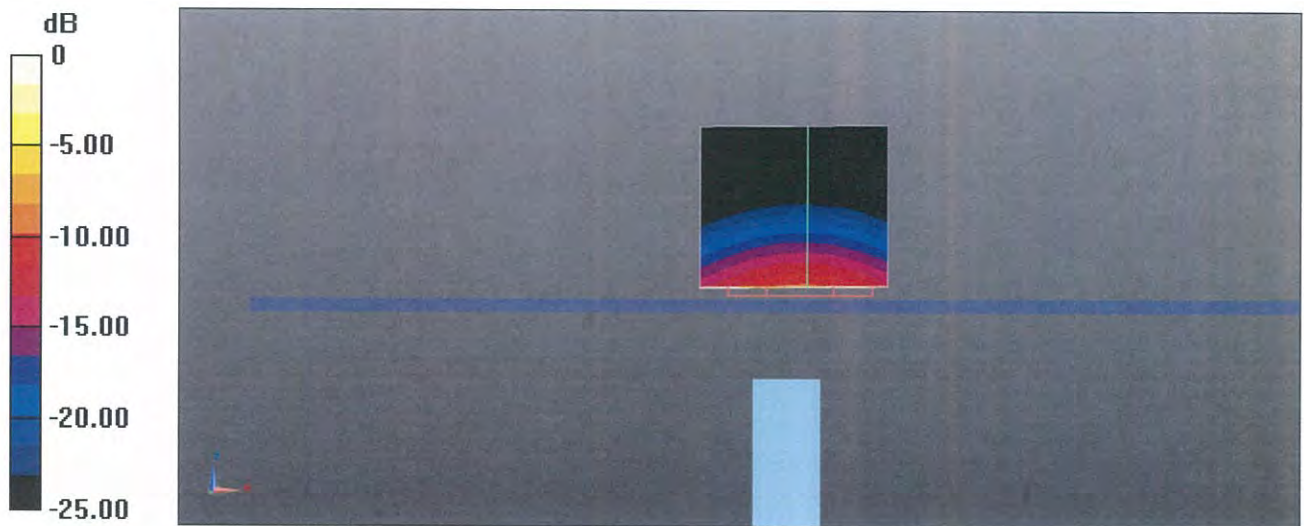

Impedance Measurement Plot for Head TSL

19 May 2017 14:58:37

CH1 S11 1 U FS 1: 49.844 Ω -8.3047 Ω 3.6855 pF 5 200.000 000 MHz

*
De1
Cor
Avg
16
H1d

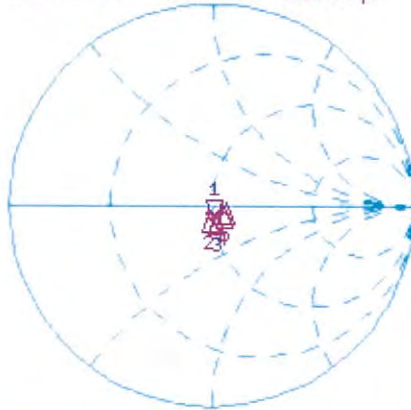

CH1 Markers
2: 47.969 Ω
-2.8145 Ω
5.30000 GHz
3: 51.016 Ω
-4.4473 Ω
5.50000 GHz
4: 55.191 Ω
-1.6074 Ω
5.60000 GHz
5: 56.201 Ω
0.4648 Ω
5.80000 GHz

CH2 S11 LOG 5 dB/REF -20 dB 1: -21.626 dB 5 200.000 000 MHz

Cor
Avg
16
H1d

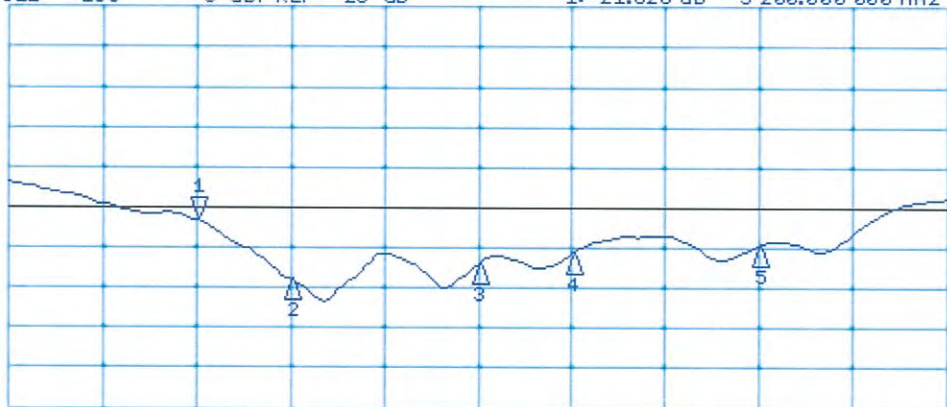

CH2 Markers
2: -29.023 dB
5.30000 GHz
3: -26.913 dB
5.50000 GHz
4: -25.729 dB
5.60000 GHz
5: -24.647 dB
5.80000 GHz

Test Laboratory: SPEAG, Zurich, Switzerland

DUT: Dipole D5GHzV2; Type: D5GHzV2; Serial: D5GHzV2 - SN:1041

Communication System: UID 0 - CW; Frequency: 5200 MHz, Frequency: 5300 MHz, Frequency: 5500 MHz, Frequency: 5600 MHz, Frequency: 5800 MHz

Medium parameters used: $f = 5200$ MHz; $\sigma = 5.44$ S/m; $\epsilon_r = 47.6$; $\rho = 1000$ kg/m³, Medium parameters used: $f = 5300$ MHz; $\sigma = 5.57$ S/m; $\epsilon_r = 47.4$; $\rho = 1000$ kg/m³, Medium parameters used: $f = 5500$ MHz; $\sigma = 5.84$ S/m; $\epsilon_r = 47$; $\rho = 1000$ kg/m³, Medium parameters used: $f = 5600$ MHz; $\sigma = 5.98$ S/m; $\epsilon_r = 46.9$; $\rho = 1000$ kg/m³, Medium parameters used: $f = 5800$ MHz; $\sigma = 6.26$ S/m; $\epsilon_r = 46.5$; $\rho = 1000$ kg/m³

Phantom section: Flat Section

Measurement Standard: DASY5 (IEEE/IEC/ANSI C63.19-2011)

DASY52 Configuration:

- Probe: EX3DV4 - SN3503; ConvF(5.29, 5.29, 5.29); Calibrated: 31.12.2016, ConvF(5.04, 5.04, 5.04); Calibrated: 31.12.2016, ConvF(4.62, 4.62, 4.62); Calibrated: 31.12.2016, ConvF(4.57, 4.57, 4.57); Calibrated: 31.12.2016, ConvF(4.48, 4.48, 4.48); Calibrated: 31.12.2016;
- Sensor-Surface: 1.4mm (Mechanical Surface Detection)
- Electronics: DAE4 Sn601; Calibrated: 28.03.2017
- Phantom: Flat Phantom 5.0 (back); Type: QD 000 P50 AA; Serial: 1002
- DASY52 52.10.0(1446); SEMCAD X 14.6.10(7417)

Dipole Calibration for Body Tissue/Pin=100mW, dist=10mm, f=5200MHz/Zoom Scan,

dist=1.4mm (8x8x7)/Cube 0: Measurement grid: dx=4mm, dy=4mm, dz=1.4mm

Reference Value = 64.73 V/m; Power Drift = -0.02 dB

Peak SAR (extrapolated) = 28.4 W/kg

SAR(1 g) = 7.51 W/kg; SAR(10 g) = 2.11 W/kg

Maximum value of SAR (measured) = 18.0 W/kg

Dipole Calibration for Body Tissue/Pin=100mW, dist=10mm, f=5300 MHz/Zoom Scan,

dist=1.4mm (8x8x7)/Cube 0: Measurement grid: dx=4mm, dy=4mm, dz=1.4mm

Reference Value = 65.52 V/m; Power Drift = -0.01 dB

Peak SAR (extrapolated) = 30.2 W/kg

SAR(1 g) = 7.81 W/kg; SAR(10 g) = 2.2 W/kg

Maximum value of SAR (measured) = 18.7 W/kg

Dipole Calibration for Body Tissue/Pin=100mW, dist=10mm, f=5500 MHz/Zoom Scan,

dist=1.4mm (8x8x7)/Cube 0: Measurement grid: dx=4mm, dy=4mm, dz=1.4mm

Reference Value = 66.13 V/m; Power Drift = -0.01 dB

Peak SAR (extrapolated) = 33.6 W/kg

SAR(1 g) = 8.14 W/kg; SAR(10 g) = 2.26 W/kg

Maximum value of SAR (measured) = 20.1 W/kg

Dipole Calibration for Body Tissue/Pin=100mW, dist=10mm, f=5600 MHz/Zoom Scan,

dist=1.4mm (8x8x7)/Cube 0: Measurement grid: dx=4mm, dy=4mm, dz=1.4mm

Reference Value = 65.80 V/m; Power Drift = -0.03 dB

Peak SAR (extrapolated) = 33.7 W/kg

SAR(1 g) = 8.13 W/kg; SAR(10 g) = 2.28 W/kg

Maximum value of SAR (measured) = 20.0 W/kg

Dipole Calibration for Body Tissue/Pin=100mW, dist=10mm, f=5800 MHz/Zoom Scan,

dist=1.4mm (8x8x7)/Cube 0: Measurement grid: dx=4mm, dy=4mm, dz=1.4mm

Reference Value = 63.89 V/m; Power Drift = -0.02 dB

Peak SAR (extrapolated) = 34.5 W/kg

SAR(1 g) = 7.87 W/kg; SAR(10 g) = 2.19 W/kg

Maximum value of SAR (measured) = 19.9 W/kg

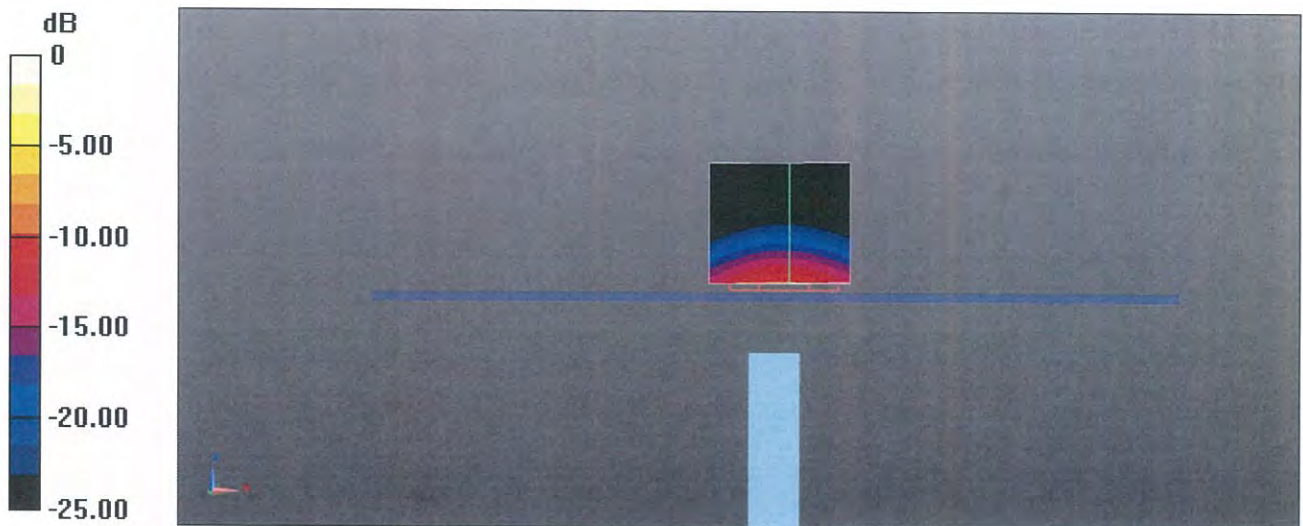

0 dB = 18.0 W/kg = 12.55 dBW/kg

Impedance Measurement Plot for Body TSL

