



FCC DFS TEST REPORT

FCC ID : MSQ-RTAXJ300
Equipment : AX3000 Dual Band Wi-Fi Router, AX5400 Dual Band Wi-Fi Router
Brand Name : ASUS
Model Name : RT-AX58U, RT-AX82U
Applicant : ASUSTeK COMPUTER INC.
4F, No. 150, Li-Te Rd., Peitou, Taipei 112, Taiwan
Manufacturer (1) : Datamax Electronics (DongGuan) Co., Ltd.
Niu Shan Foreign Economic Industrial Park, Dong Cheng District, Dong Guan City, Guang Dong, China
Manufacturer (2) : Compal Networking (KunShan) Co., LTD.
No. 520, Nabbang Rd., Economic & Technical Development Zone Kunshan, Jiangsu Province China
Manufacturer (3) : ARCADYAN TECHNOLOGY (VIETNAM) CO., LTD.
Ba Thien Industrial Park, Ba Hien commune, Binh Xuyen district, Vinh Phuc Province
Standard : 47 CFR FCC Part 15.407

The product was received on Jul. 12, 2019, and testing was started from Jul. 17, 2019 and completed on Aug. 23, 2019. We, SPORTON INTERNATIONAL INC. EMC & Wireless Communications Laboratory, would like to declare that the tested sample has been evaluated in accordance with the procedures given in FCC KDB 905462 D02 UNII DFS Compliance Procedures New Rules v02 and shown compliance with the applicable technical standards.

The report must not be used by the client to claim product certification, approval, or endorsement by TAF or any agency of government.

The test results in this variant report apply exclusively to the tested model / sample. Without written approval of SPORTON INTERNATIONAL INC. EMC & Wireless Communications Laboratory, the test report shall not be reproduced except in full.

Approved by: Sam Chen

SPORTON INTERNATIONAL INC. EMC & Wireless Communications Laboratory

No. 52, Huaya 1st Rd., Guishan Dist., Taoyuan City, Taiwan (R.O.C.)



Table of Contents

History of this test report.....3

Summary of Test Result.....4

1 General Description5

1.1 Information.....5

1.2 Accessories12

1.3 Support Equipment.....12

1.4 Applicable Standards13

1.5 Testing Location Information.....13

2 Test Configuration of EUT.....14

2.1 Test Channel Frequencies Configuration.....14

2.2 The Worst Case Measurement Configuration.....14

3 Dynamic Frequency Selection (DFS) Test Result15

3.1 General DFS Information15

3.2 Radar Test Waveform Calibration.....18

3.3 UNII Detection Bandwidth31

3.4 Channel Availability Check (CAC).....37

3.5 In-service Monitoring41

3.6 Statistical Performance Check56

4 Test Equipment and Calibration Data187

5 Measurement Uncertainty188

Appendix A. Dynamic In-Service Monitoring Test (Zero-Wait CAC)

Appendix B. Test Photos

Photographs of EUT v01



History of this test report

Report No.	Version	Description	Issued Date
FZ952922-01	01	Initial issue of report	Aug. 27, 2019



Summary of Test Result

Report Clause	Ref Std. Clause	Test Items	Result (PASS/FAIL)	Remark
3.3	FCC KDB 905462 7.8.1	DFS: UNII Detection Bandwidth Measurement	PASS	-
3.4	FCC KDB 905462 7.8.2.1	DFS: Initial Channel Availability Check Time	PASS	-
3.4	FCC KDB 905462 7.8.2.2	DFS: Radar Burst at the Beginning of the Channel Availability Check Time	PASS	-
3.4	FCC KDB 905462 7.8.2.3	DFS: Radar Burst at the End of the Channel Availability Check Time	PASS	-
3.5	FCC KDB 905462 7.8.3	DFS: In-Service Monitoring for Channel Move Time (CMT)	PASS	-
3.5	FCC KDB 905462 7.8.3	DFS: In-Service Monitoring for Channel Closing Transmission Time (CCTT)	PASS	-
3.5	FCC KDB 905462 7.8.3	DFS: In-Service Monitoring for Non-Occupancy Period (NOP)	PASS	-
3.6	FCC KDB 905462 7.8.4	DFS: Statistical Performance Check	PASS	-
3.1.4	FCC KDB 905462 8.1	User Access Restrictions	PASS	-
For Bridge mode, that is Slave without radar detection function, only Channel Move Time, Channel Closing Transmission Time and Non-Occupancy Period are required to perform.				

Declaration of Conformity:

The test results with all measurement uncertainty excluded are presented in accordance with the regulation limits or requirements declared by manufacturers.

Comments and Explanations:

The declared of product specification for EUT presented in the report are provided by the manufacturer, and the manufacturer takes all the responsibilities for the accuracy of product specification.

Reviewed by: Sam Chen

Report Producer: Viola Huang



1 General Description

1.1 Information

1.1.1 RF General Information

Specification Items	Description
Frequency Range	5250 MHz – 5350 MHz
Power Type	From power adapter
Channel Bandwidth	20/40/80/160 MHz operating channel bandwidth
Operating Mode	<input checked="" type="checkbox"/> Master (AP Router, Repeater)
	<input type="checkbox"/> Client with radar detection
	<input checked="" type="checkbox"/> Slave without radar detection (Bridge)
Communication Mode	<input checked="" type="checkbox"/> IP Based (Load Based) <input type="checkbox"/> Frame Based
TPC Function	<input checked="" type="checkbox"/> With TPC <input type="checkbox"/> Without TPC
Power-on cycle	For master mode 160MHz: Requires 24.448 seconds to complete its power-on cycle. For slave without radar detection mode NA (No Channel Availability Check Function)
Software / Firmware Version	3.0.0.4.384_6423
<ul style="list-style-type: none"> ◆ 11a, HT20 and HT40 use a combination of OFDM-BPSK, QPSK, 16QAM, 64QAM modulation. ◆ VHT20, VHT40, VHT80 and VHT160 use a combination of OFDM-BPSK, QPSK, 16QAM, 64QAM, 256QAM, 1024QAM modulation. ◆ HEW20, HEW40, HEW80 and HEW160 use a combination of OFDMA-BPSK, QPSK, 16QAM, 64QAM, 256QAM, 1024QAM modulation. ◆ EUT employ a TPC mechanism and TPC have the capability to operate at least 6 dB below highest RF output power. 	

Note: The above information was declared by manufacturer.



TPC Power Result

For 2T1S

Mode	Min Power (dBm)	Max Power (dBm)	Min EIRP (dBm)	Max EIRP (dBm)
802.11a_Nss1,(6Mbps)_2TX	-	-	-	-
5.25-5.35GHz	17.91	23.91	19.84	25.84
802.11ax HEW20-BF_Nss1,(MCS0)_2TX	-	-	-	-
5.25-5.35GHz	17.94	23.94	22.84	28.84
802.11ax HEW40-BF_Nss1,(MCS0)_2TX	-	-	-	-
5.25-5.35GHz	17.97	23.97	22.87	28.87
802.11ax HEW80-BF_Nss1,(MCS0)_2TX	-	-	-	-
5.25-5.35GHz	17.11	23.11	22.01	28.01
802.11ax HEW160-BF_Nss1,(MCS0)_2TX	-	-	-	-
5.25-5.35GHz	12.69	18.69	17.59	23.59

For 2T2S

Mode	Min Power (dBm)	Max Power (dBm)	Min EIRP (dBm)	Max EIRP (dBm)
802.11ax HEW20_Nss2,(MCS0)_2TX	-	-	-	-
5.25-5.35GHz	17.96	23.96	19.85	25.85
802.11ax HEW40_Nss2,(MCS0)_2TX	-	-	-	-
5.25-5.35GHz	17.96	23.96	19.85	25.85
802.11ax HEW80_Nss2,(MCS0)_2TX	-	-	-	-
5.25-5.35GHz	17.91	23.91	19.80	25.80
802.11ax HEW160_Nss2,(MCS0)_2TX	-	-	-	-
5.25-5.35GHz	15.88	21.88	17.77	23.77

For 4T1S

Mode	Min Power (dBm)	Max Power (dBm)	Min EIRP (dBm)	Max EIRP (dBm)
802.11a_Nss1,(6Mbps)_4TX	-	-	-	-
5.25-5.35GHz	16.10	22.10	18.03	24.03
802.11ax HEW20-BF_Nss1,(MCS0)_4TX	-	-	-	-
5.25-5.35GHz	16.05	22.05	23.96	29.96
802.11ax HEW40-BF_Nss1,(MCS0)_4TX	-	-	-	-
5.25-5.35GHz	16.02	22.02	23.93	29.93
802.11ax HEW80-BF_Nss1,(MCS0)_4TX	-	-	-	-
5.25-5.35GHz	15.92	21.92	23.83	29.83
802.11ax HEW160-BF_Nss1,(MCS0)_4TX	-	-	-	-
5.25-5.35GHz	16.04	22.04	23.95	29.95



For 4T2S

Mode	Min Power (dBm)	Max Power (dBm)	Min EIRP (dBm)	Max EIRP (dBm)
802.11ax HEW20-BF_Nss2,(MCS0)_4TX	-	-	-	-
5.25-5.35GHz	17.93	23.93	22.83	28.83
802.11ax HEW40-BF_Nss2,(MCS0)_4TX	-	-	-	-
5.25-5.35GHz	17.86	23.86	22.76	28.76
802.11ax HEW80-BF_Nss2,(MCS0)_4TX	-	-	-	-
5.25-5.35GHz	17.88	23.88	22.78	28.78
802.11ax HEW160-BF_Nss2,(MCS0)_4TX	-	-	-	-
5.25-5.35GHz	16.29	22.29	21.19	27.19



1.1.2 Antenna Information

Set	Ant.	Brand	P/N	Antenna Type	Connector	Gain (dBi)
1	1	PSA	RFDPA161314IMLB701	Dipole Antenna	I-PEX	Note 1
	2	PSA	RFDPA161311IM5B702	Dipole Antenna	I-PEX	
	3	PSA	RFDPA161310IM5B701	Dipole Antenna	I-PEX	
	4	PSA	RFDPA161316IMLB701	Dipole Antenna	I-PEX	
2	1	M.gear	C660-510468-A	Dipole Antenna	I-PEX	
	2	M.gear	C660-510469-A	Dipole Antenna	I-PEX	
	3	M.gear	C660-510470-A	Dipole Antenna	I-PEX	
	4	M.gear	C660-510471-A	Dipole Antenna	I-PEX	
3	1	M.gear	C660-510472-A	Dipole Antenna	I-PEX	
	2	M.gear	C660-510473-A	Dipole Antenna	I-PEX	
	3	M.gear	C660-510474-A	Dipole Antenna	I-PEX	
	4	M.gear	C660-510475-A	Dipole Antenna	I-PEX	
4	1	PSA	RFDPA171314IMLB701	Dipole Antenna	I-PEX	
	2	PSA	RFDPA171311IM5B702	Dipole Antenna	I-PEX	
	3	PSA	RFDPA171310IM5B702	Dipole Antenna	I-PEX	
	4	PSA	RFDPA171316IMLB701	Dipole Antenna	I-PEX	

Note 1:

Set	Ant.	Port			2.4GHz	5GHz Band 1	5GHz Band 2	5GHz Band 4
		2.4G 2TX	5G 2TX	5G 4TX				
1	1	2	-	2	1.71	1.75	1.89	1.70
	2	-	1	1	-	1.93	1.93	1.95
	3	-	2	4	-	1.75	1.85	1.89
	4	1	-	3	1.63	1.92	1.88	1.87
2	1	2	-	2	1.61	1.74	1.84	1.67
	2	-	1	1	-	1.76	1.8	1.87
	3	-	2	4	-	1.66	1.72	1.84
	4	1	-	3	1.6	1.88	1.82	1.86
3	1	2	-	2	1.7	1.71	1.85	1.68
	2	-	1	1	-	1.68	1.73	1.85
	3	-	2	4	-	1.63	1.74	1.77
	4	1	-	3	1.62	1.67	1.74	1.85



Set	Ant.	Port			2.4GHz	5GHz Band 1	5GHz Band 2	5GHz Band 4
		2.4G 2TX	5G 2TX	5G 4TX				
4	1	2	-	2	1.7	1.74	1.74	1.68
	2	-	1	1	-	1.86	1.9	1.9
	3	-	2	4	-	1.48	1.6	1.88
	4	1	-	3	1.61	1.63	1.71	1.86

Note 2: The above information was declared by manufacturer.

Note 3: The EUT has four sets of antennas and there are four antennas for each set.

Set 1~4 are the same type antenna. Only the lowest gain Set 4 antenna was selected to test and record in this report.

For 2.4GHz WLAN function

IEEE 802.11b/g/n/VHT/ax mode (2TX/2RX):

Port 1 and port 2 can be used as transmitting/receiving antenna.

Port 1 and port 2 could transmit/receive simultaneously.

For 5GHz WLAN function

IEEE 802.11a/n/ac/ax mode (2TX, 4TX/4RX):

For 2TX

Port 1 and port 2 can be used as transmitting antenna.

Port 1 and port 2 could transmit simultaneously.

For 4TX, 4RX

Port 1, port 2, port 3 and port 4 can be used as transmitting/receiving antenna.

Port 1, port 2, port 3 and port 4 could transmit/receive simultaneously.



1.1.3 DFS Band Carrier Frequencies

There are four bandwidth systems.

For 20MHz bandwidth systems, use Channel 52, 56, 60, 64

For 40MHz bandwidth systems, use Channel 54, 62

For 80MHz bandwidth systems, use Channel 58

For 160MHz bandwidth systems, use Channel 50

Frequency Band	Channel No.	Frequency	Channel No.	Frequency
5250~5350 MHz Band 2	50	5250 MHz	58	5290 MHz
	52	5260 MHz	60	5300 MHz
	54	5270 MHz	62	5310 MHz
	56	5280 MHz	64	5320 MHz

1.1.4 Table for Multiple Listing

The Equipment and model names in the following table are all refer to the identical product.

Equipment	Model Name	Description
AX3000 Dual Band Wi-Fi Router, AX5400 Dual Band Wi-Fi Router	RT-AX82U, RT-AX58U	All the equipment and models are identical, the different equipment and model names served as marketing strategy.

From the above table, equipment: AX3000 Dual Band Wi-Fi Router and model: RT-AX82U was selected as representative model for the test and its data was recorded in this report.

1.1.5 Table for SKU information

SKU	Material	Housing	Brand	P/N
SKU 1	PJ-45 port was covered by plastic.	There are two different housings.	LAN port : ETSWAP / Mingtek	LAN port : NS773602 / HN36201CG
SKU 2	PJ-45 port was covered by metal.		WAN port : ETSWAP / Mingtek	WAN port: NS771802 / HN18101CG



1.1.6 Table for EUT supports functions

Function	Support Type
AP Router	Master
Bridge	Slave without radar detection
Repeater	Master

Note: After evaluating, there are only Master-AP Router and Slave without radar detection-Bridge were selected to test and record in the report.

1.1.7 Table for Class II Change

This product is an extension of original one reported under Sporton project number: 952922

Below is the table for the change of the product with respect to the original one.

Modifications	Performance Checking
1. Adding Band 2 (5250~5350 MHz) for this device. 2. Adding 160MHz for this device.	All test items



1.2 Accessories

Accessories				
Equipment Name	Brand Name	Model Name	P/N	Rating
Adapter 1	PI	AD2088320	010LF	INPUT: 100-240V ~ 50/60Hz, 0.8A OUTPUT: 19V, 1.75A
Adapter 2	PI	AD2088320	010-5LF	INPUT: 100-240V ~ 50/60Hz, 0.8A OUTPUT: 19V, 1.75A
Other				
RJ-45 cable*1, Non-shielded, 1.5m				

Note: The power adapter 1~ adapter 2 do not affect the test result of DFS tests, so only adapter 1 was tested and recorded in this report.

1.3 Support Equipment

For Master mode

Support Equipment				
No.	Equipment	Brand Name	Model Name	FCC ID
A	Notebook	DELL	E4300	N/A
B	Notebook	DELL	E4300	N/A
C	Device	ASUS	RT-AX82U	N/A

For Slave without radar detection mode

Support Equipment				
No.	Equipment	Brand Name	Model Name	FCC ID
A	Notebook	DELL	E4300	N/A
B	Notebook	DELL	E4300	N/A
C	Device	ASUS	RT-AX58U	N/A



1.4 Applicable Standards

According to the specifications of the manufacturer, the EUT must comply with the requirements of the following standards:

- ♦ FCC KDB 905462 D02 UNII DFS Compliance Procedures New Rules v02

1.5 Testing Location Information

Testing Location				
<input type="checkbox"/>	HWA YA	ADD : No. 52, Huaya 1st Rd., Guishan Dist., Taoyuan City, Taiwan (R.O.C.) TEL : 886-3-327-3456 FAX : 886-3-327-0973		
<input checked="" type="checkbox"/>	JHUBEI	ADD : No.8, Lane 724, Bo-ai St., Jhubei City, HsinChu County 302, Taiwan, R.O.C. TEL : 886-3-656-9065 FAX : 886-3-656-9085		
Test Condition	Test Site No.	Test Engineer	Test Environment	Test Date
DFS Site	DF02-CB	For master: Nyle Chang	26.9~27.9°C / 63~67%	17-Jul-19 ~ 23-Aug-19
		For Slave without radar detection: Kevin Huang	24.6~26.2°C / 60~64%	12-Aug-19

Test site Designation No. TW0006 with FCC
Test site registered number IC 4086B with Industry Canada.



2 Test Configuration of EUT

2.1 Test Channel Frequencies Configuration

Test Channel Frequencies Configuration	
IEEE Std.	Test Channel Freq. (MHz)
802.11ac (VHT20)	5300 MHz
802.11ac (VHT40)	5310 MHz
802.11ac (VHT80)	5290 MHz
802.11ac (VHT160), 802.11ax (HEW160)	5250 MHz

2.2 The Worst Case Measurement Configuration

The Worst Case Mode for Following Conformance Tests	
Tests Item	Dynamic Frequency Selection (DFS)
Test Condition	Radiated measurement The EUT shall be configured to operate at the highest transmitter output power setting. If more than one antenna assembly is intended for this power setting, the gain of the antenna assembly with the lowest gain shall be used. The DFS radar test signals have been aligned to the direction corresponding to the EUT's maximum antenna gain.
Modulation Mode	1 Master mode (AP Router)
	802.11ac (VHT20), 802.11ac (VHT40), 802.11ac (VHT80), 802.11ac (VHT160), 802.11ax (HEW160)
	2 Slave without radar detection mode (Bridge)
	802.11ax (HEW160)

Note:The EUT only uses in Z axis.



3 Dynamic Frequency Selection (DFS) Test Result

3.1 General DFS Information

3.1.1 DFS Parameters

Table D.1: DFS requirement values	
Parameter	Value
Non-occupancy period	Minimum 30 minutes
Channel Availability Check Time	60 seconds
Channel Move Time	10 seconds (Note 1).
Channel Closing Transmission Time	200 milliseconds + an aggregate of 60 milliseconds over remaining 10 second periods. (Notes 1 and 2).
U-NII Detection Bandwidth	Minimum 100% of the 99% power bandwidth (Note 3).

Note 1: Channel Move Time and the Channel Closing Transmission Time should be performed with Radar Type 0. The measurement timing begins at the end of the Radar Type 0 burst.

Note 2: The Channel Closing Transmission Time is comprised of 200 milliseconds starting at the beginning of the Channel Move Time plus any additional intermittent control signals required to facilitate Channel changes (an aggregate of 60 milliseconds) during the remainder of the 10 second period. The aggregate duration of control signals will not count quiet periods in between transmissions.

Note 3: During the U-NII Detection Bandwidth detection test, radar type 0 is used and for each frequency step the minimum percentage of detection is 90%. Measurements are performed with no data traffic.

Table D.2: Interference threshold values	
Maximum Transmit Power	Value (see note)
EIRP ≥ 200 mW	-64 dBm
EIRP < 200 mW and PSD < 10dBm/MHz	-62 dBm
EIRP < 200 mW and PSD ≥ 10dBm/MHz	-64 dBm

Note 1: This is the level at the input of the receiver assuming a 0 dBi receive antenna.

Note 2: Throughout these test procedures an additional 1 dB has been added to the amplitude of the test transmission waveforms to account for variations in measurement equipment. This will ensure that the test signal is at or above the detection threshold level to trigger a DFS response.

Note3: EIRP is based on the highest antenna gain. For MIMO devices refer to KDB Publication 662911D01.



3.1.2 Applicability of DFS Requirements Prior to Use of a Channel

Requirement	DFS Operational mode		
	Master	Slave without radar detection	Client with radar detection
<i>Non-Occupancy Period</i>	Yes	Not required	Yes
<i>DFS Detection Threshold</i>	Yes	Not required	Yes
<i>Channel Availability Check Time</i>	Yes	Not required	Not required
<i>U-NII Detection Bandwidth</i>	Yes	Not required	Yes

3.1.3 Applicability of DFS Requirements during Normal Operation

Requirement	DFS Operational mode		
	Master	Slave without radar detection	Client with radar detection
<i>DFS Detection Threshold</i>	Yes	Not required	Yes
<i>Channel Closing Transmission Time</i>	Yes	Yes	Yes
<i>Channel Move Time</i>	Yes	Yes	Yes
<i>U-NII Detection Bandwidth</i>	Yes	Not required	Yes

Additional requirements for devices with multiple bandwidth modes	Master Device or Client with Radar Detection	Slave without radar detection
U-NII Detection Bandwidth and Statistical Performance Check	All BW modes must be tested	Not required
Channel Move Time and Channel Closing Transmission Time	Test using widest BW mode available	Test using the widest BW mode available for the link
All other tests	Any single BW mode	Not required

Note: Frequencies selected for statistical performance check (Section 7.8.4) should include several frequencies within the radar detection bandwidth and frequencies near the edge of the radar detection bandwidth. For 802.11 devices it is suggested to select frequencies in each of the bonded 20 MHz channels and the channel center frequency.



3.1.4 User Access Restrictions

User Access Restrictions	
<input checked="" type="checkbox"/>	DFS controls (hardware or software) related to radar detection are NOT accessible to the user. Manufacturer statement confirming that information regarding the parameters of the detected Radar Waveforms is not available to the end user.

3.1.5 Channel Loading/Data Streaming

<input type="checkbox"/>	The data file (MPEG-4) has been transmitting in a streaming mode.
<input checked="" type="checkbox"/>	Software to ping the client is permitted to simulate data transfer with random ping intervals.
<input checked="" type="checkbox"/>	Minimum channel loading of approximately 17%.
<input type="checkbox"/>	Unicast protocol has been used.



3.2 Radar Test Waveform Calibration

3.2.1 Short Pulse Radar Test Waveforms

Radar Type	Pulse Width (µsec)	PRI (µsec)	Number of Pulses	Minimum Percentage of Successful Detection	Minimum Trials
0	1	1428	18	See Note 1	See Note 1
1A	1	15 unique PRI in KDB 905462 D02 Table 5a	$\text{Roundup}\left\{\left(\frac{1}{360}\right) \times \left(\frac{19 \times 10^6}{PRI}\right)\right\}$	60%	15
1B	1	15 unique PRI within 518-3066, Excluding 1A PRI		60%	15
2	1-5	150-230	23-29	60%	30
3	6-10	200-500	16-18	60%	30
4	11-20	200-500	12-16	60%	30
Aggregate (Radar Types 1-4)				80%	120
Note 1: Short Pulse Radar Type 0 should be used for the detection bandwidth test, channel move time, and channel closing time tests.					

A minimum of 30 unique waveforms are required for each of the short pulse radar types 1 through 4. If more than 30 waveforms are used for short pulse radar types 1 through 4, then each additional waveform must also be unique and not repeated from the previous waveforms. The aggregate is the average of the percentage of successful detections of short pulse radar types 1-4.

3.2.2 Long Pulse Radar Test Waveform

Radar Type	Pulse Width (µsec)	Chirp Width (MHz)	PRI (µsec)	Number of Pulses per Burst	Number of Bursts	Minimum Percentage of Successful Detection	Minimum Trials
5	50-100	5-20	1000-2000	1-3	8-20	80%	30

Each waveform is defined as follows:

- The transmission period for the Long Pulse Radar test signal is 12 seconds.
- There are a total of 8 to 20 Bursts in the 12 second period, with the number of Bursts being randomly chosen. This number is Burst Count.
- Each Burst consists of 1 to 3 pulses, with the number of pulses being randomly chosen. Each Burst within the 12 second sequence may have a different number of pulses.
- The pulse width is between 50 and 100 microseconds, with the pulse width being randomly chosen. Each pulse within a Burst will have the same pulse width. Pulses in different Bursts may have different pulse widths.
- Each pulse has a linear FM chirp between 5 and 20 MHz, with the chirp width being randomly chosen. Each pulse within a transmission period will have the same chirp width. The chirp is centered on the pulse. For



example, with a radar frequency of 5300 MHz and a 20 MHz chirped signal, the chirp starts at 5290 MHz and ends at 5310 MHz.

- ♦ If more than one pulse is present in a Burst, the time between the pulses will be between 1000 and 2000 microseconds, with the time being randomly chosen. If three pulses are present in a Burst, the time between the first and second pulses is chosen independently of the time between the second and third pulses.
- ♦ The 12 second transmission period is divided into even intervals. The number of intervals is equal to Burst Count. Each interval is of length (12,000,000 / Burst Count) microseconds. Each interval contains one Burst. The start time for the Burst, relative to the beginning of the interval, is between 1 and [(12,000,000 / Burst Count) - (Total Burst Length) + (One Random PRI Interval)] microseconds, with the start time being randomly chosen. The step interval for the start time is 1 microsecond. The start time for each Burst is chosen independently.

3.2.3 Frequency Hopping Radar Test Waveform

Radar Type	Pulse Width (µsec)	PRI (µsec)	Pulses per Hop	Hopping Rate (kHz)	Hopping Sequence Length (ms)	Minimum Percentage of Successful Detection	Minimum Trials
6	1	333	9	0.333	300	70%	30

The FCC Type 6 waveform uses a static waveform with 100 bursts in the instruments ARB. In addition, the RF list mode is operated with a list containing 100 frequencies from a randomly generated list and it had be ensured that at least one of the random frequencies falls into the UNII Detection Bandwidth of the DUT. Each burst from the waveform file initiates a trigger pulse at the beginning that switches the RF list from one item to the next one.

3.2.4 DFS Threshold Level

DFS Threshold Level	
DFS Threshold level: -63 dBm	<input type="checkbox"/> at the antenna connector
	<input checked="" type="checkbox"/> in front of the antenna
The Interference Radar Detection Threshold Level is is $-64 \text{ dBm} + 0 [\text{dBi}] + 1 \text{ dB} = -63 \text{ dBm}$. That had been taken into account the output power range and antenna gain.	

3.2.5 Calibration Setup

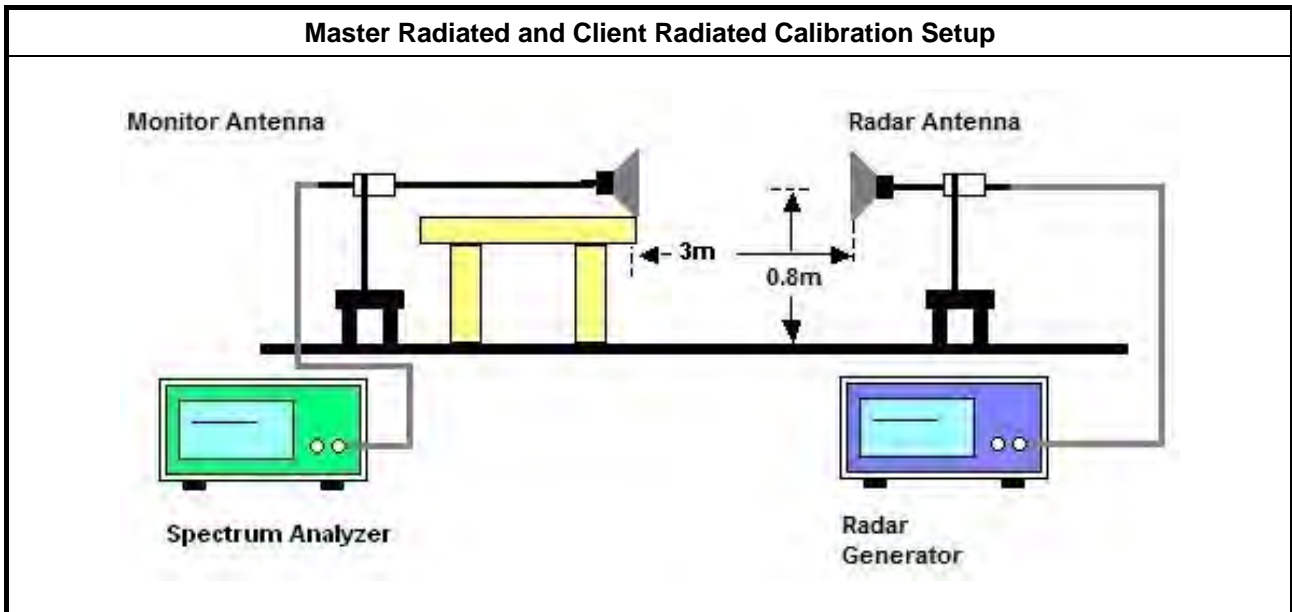



3.2.6 Radar Waveform calibration Plot

For Master mode

Test Frequency: 5250 MHz

Radar #0 DFS detection threshold level

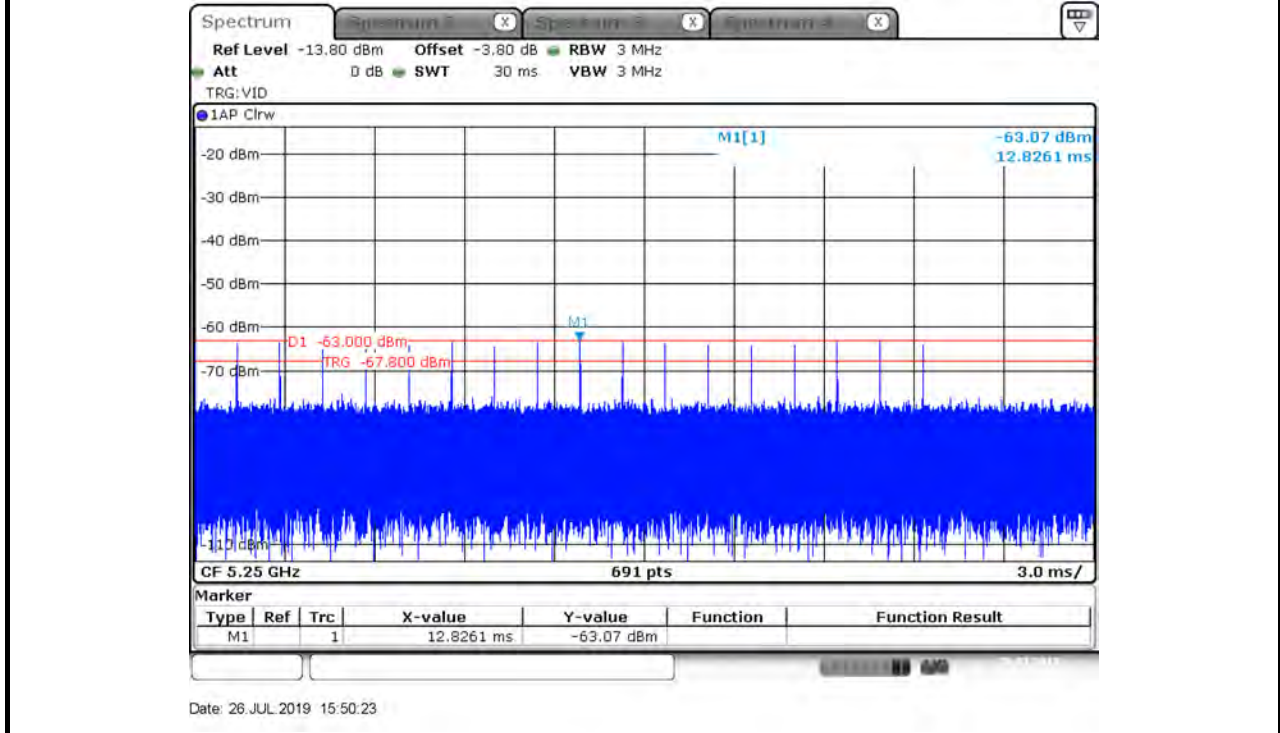



Radar #1 DFS detection threshold level

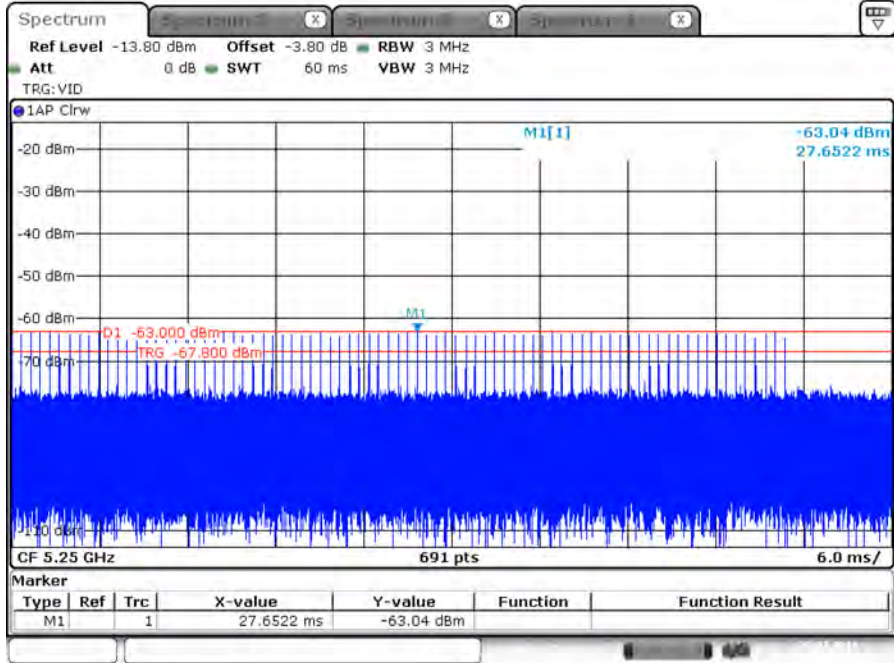

Date: 26 JUL 2019 15:50:54

Radar #2 DFS detection threshold level

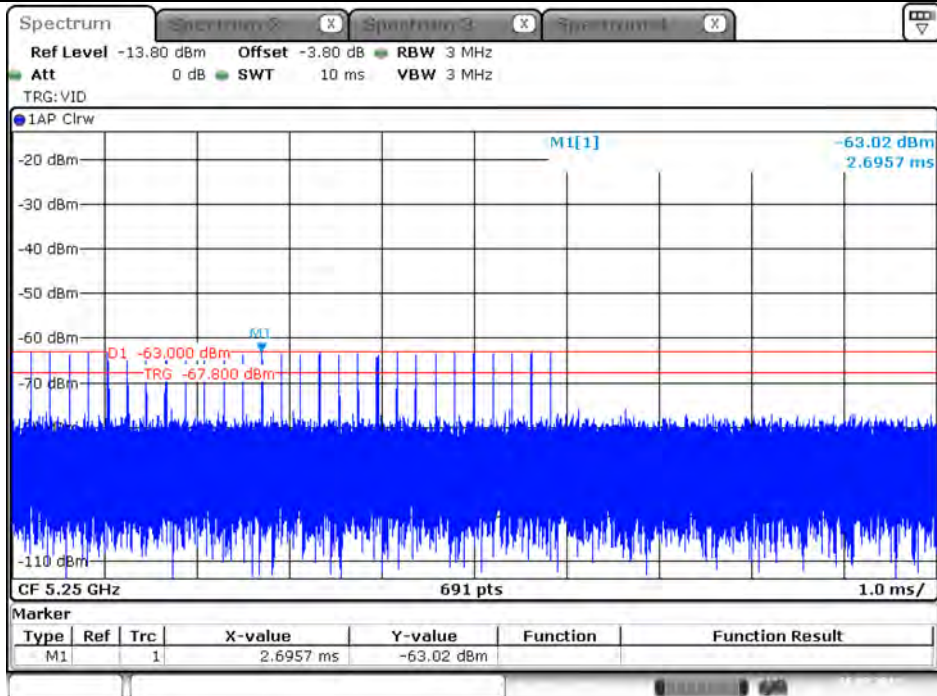

Date: 26 JUL 2019 15:51:24



Radar #3 DFS detection threshold level

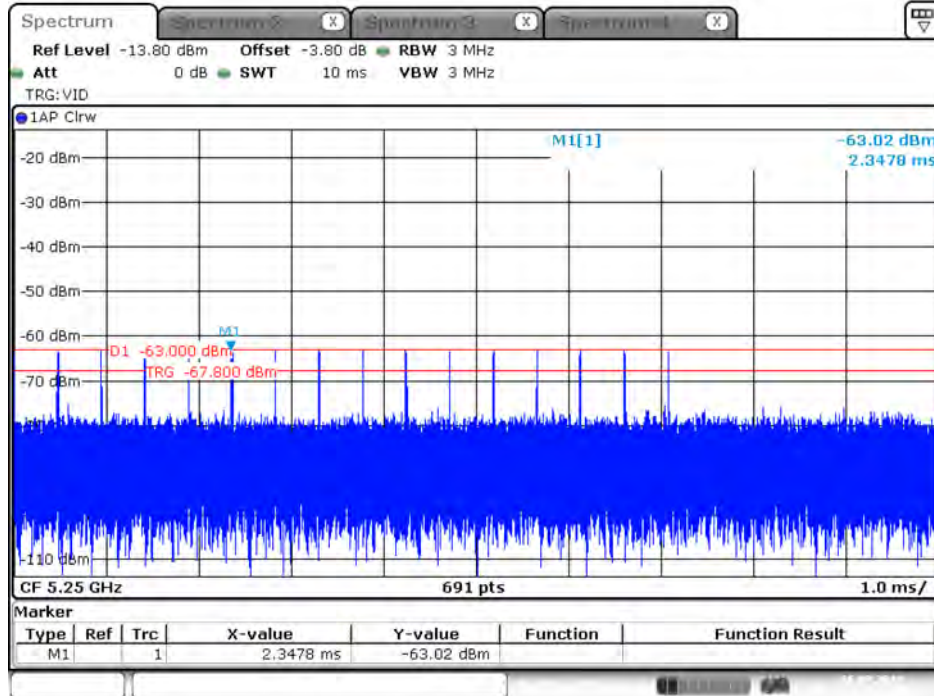

Date: 26 JUL 2019 15:52:05

Radar #4 DFS detection threshold level

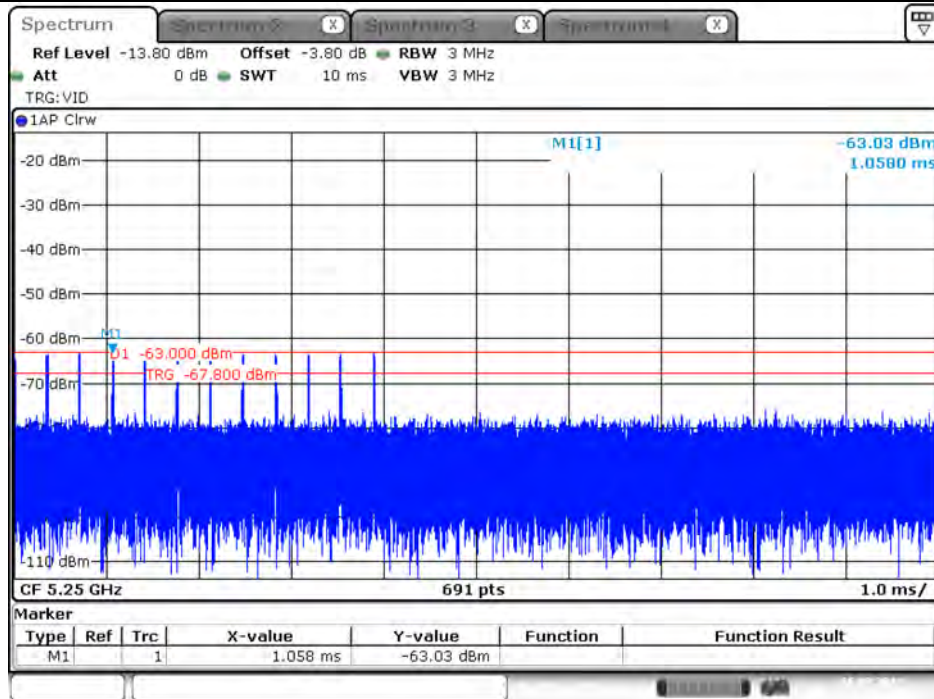

Date: 26 JUL 2019 15:53:00



Radar #5 DFS detection threshold level

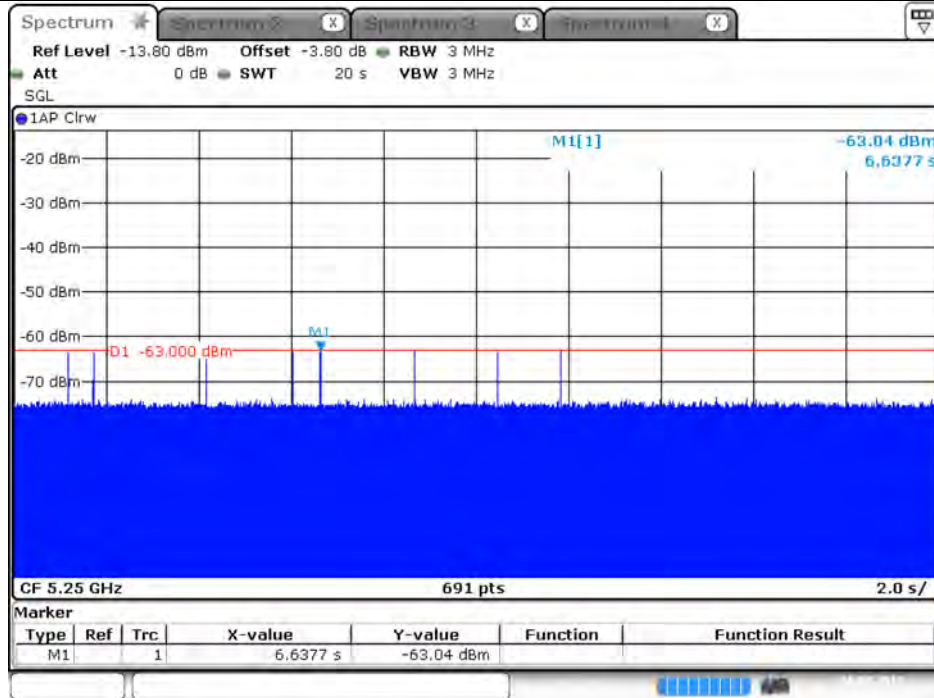

Date: 26 JUL 2019 15:47:38

Radar #6 DFS detection threshold level

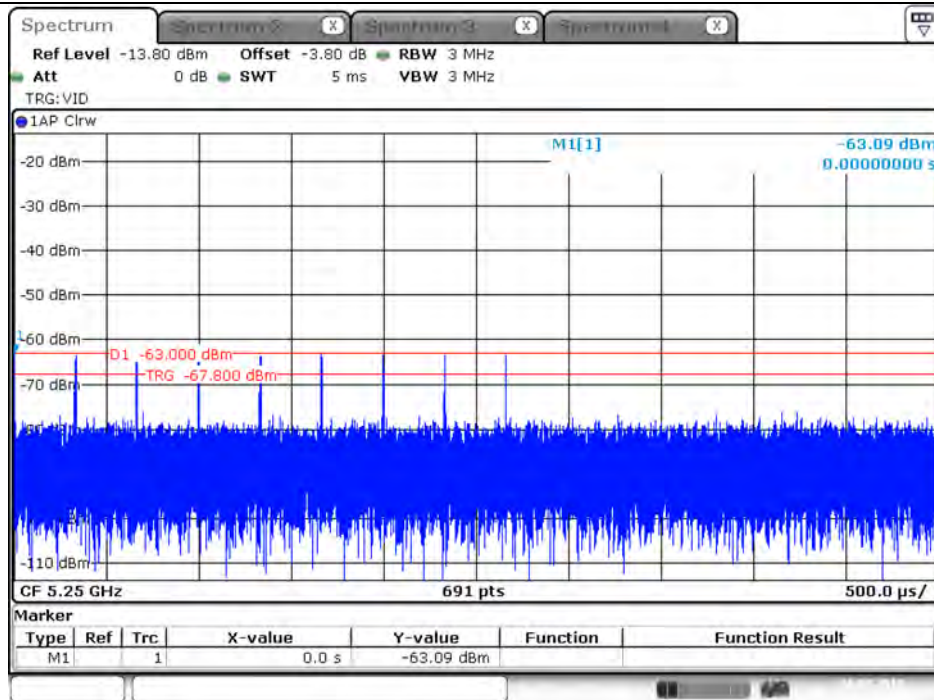

Date: 26 JUL 2019 15:49:28



For Slave without radar detection

Test Frequency: 5250 MHz

Radar #0 DFS detection threshold level

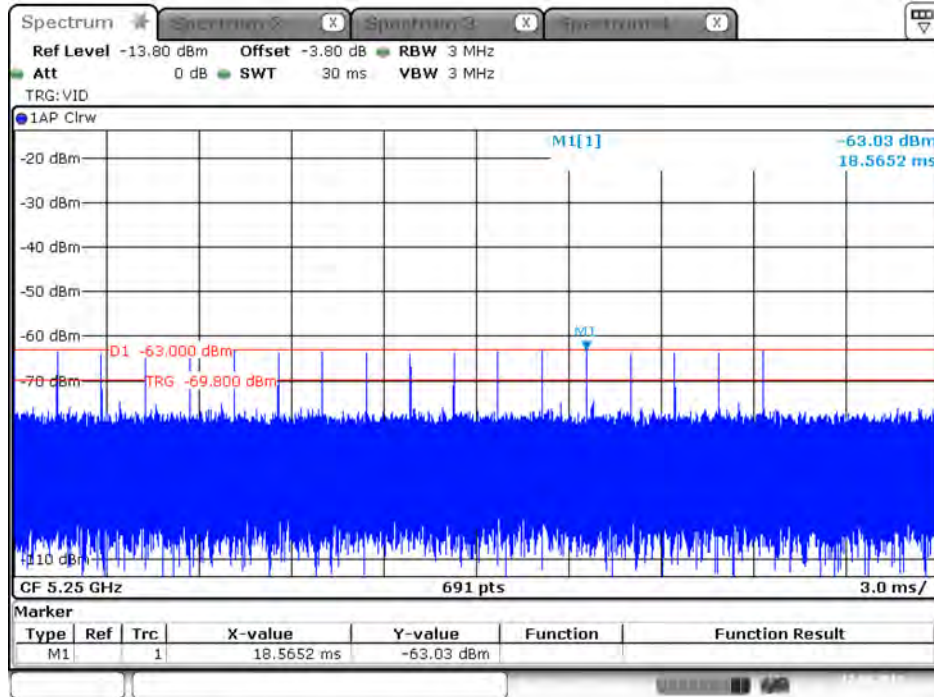

Date: 12.AUG.2019 22:02:00

3.2.7 Test Setup

A spectrum analyzer is used as a monitor to verify that the EUT has vacated the Channel within the (Channel Closing Transmission Time and Channel Move Time, and does not transmit on a Channel during the Non-Occupancy Period after the detection and Channel move.

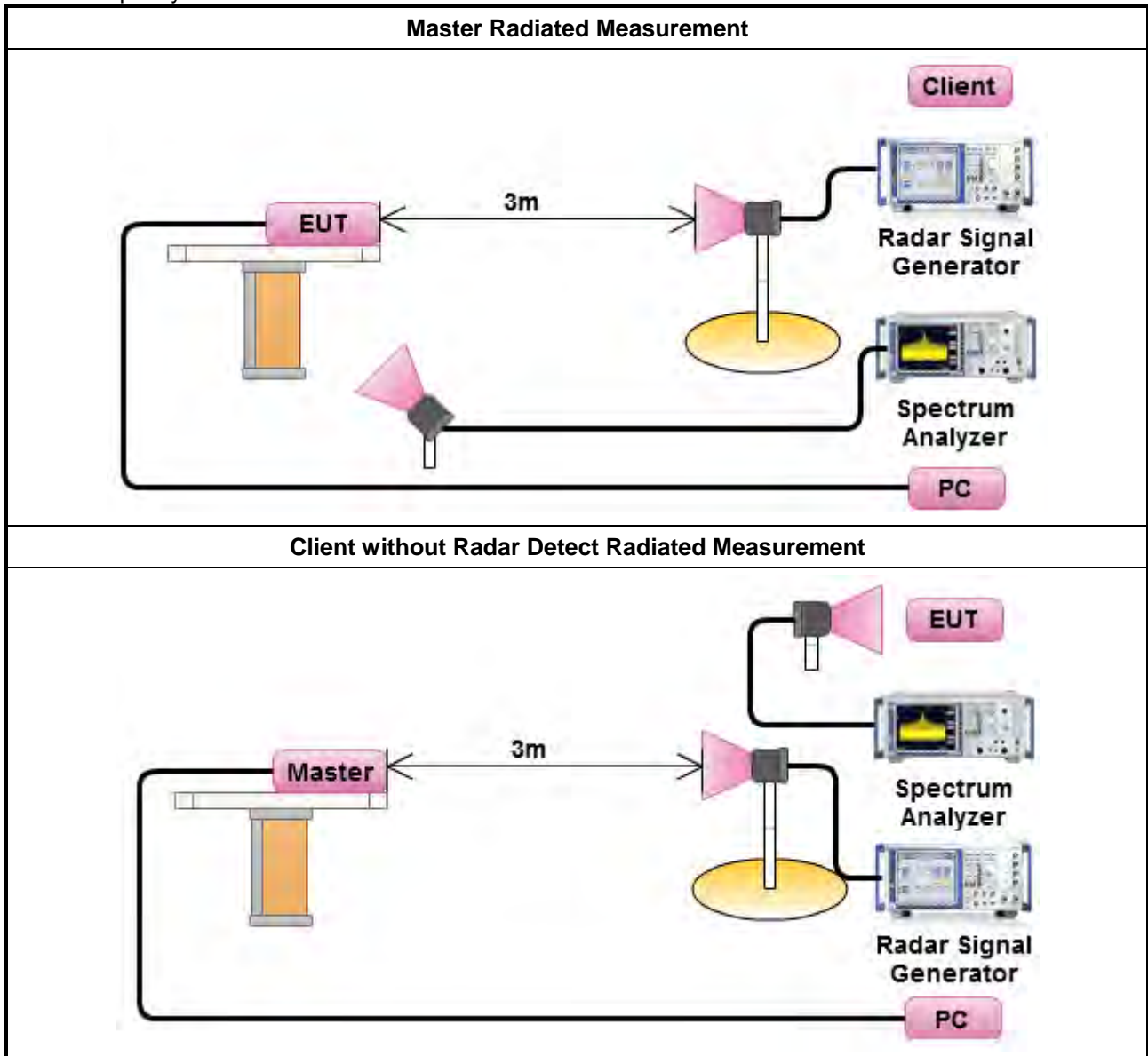



3.2.8 Data traffic Plot

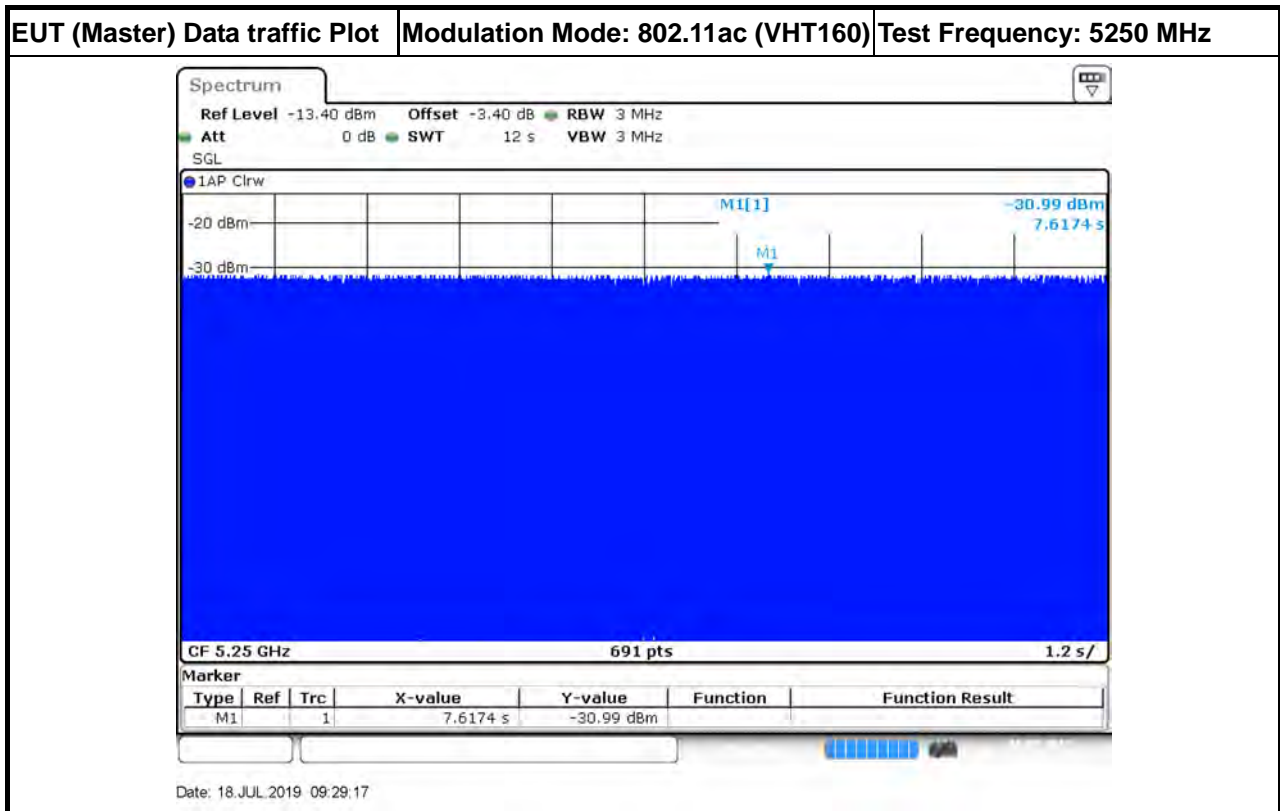

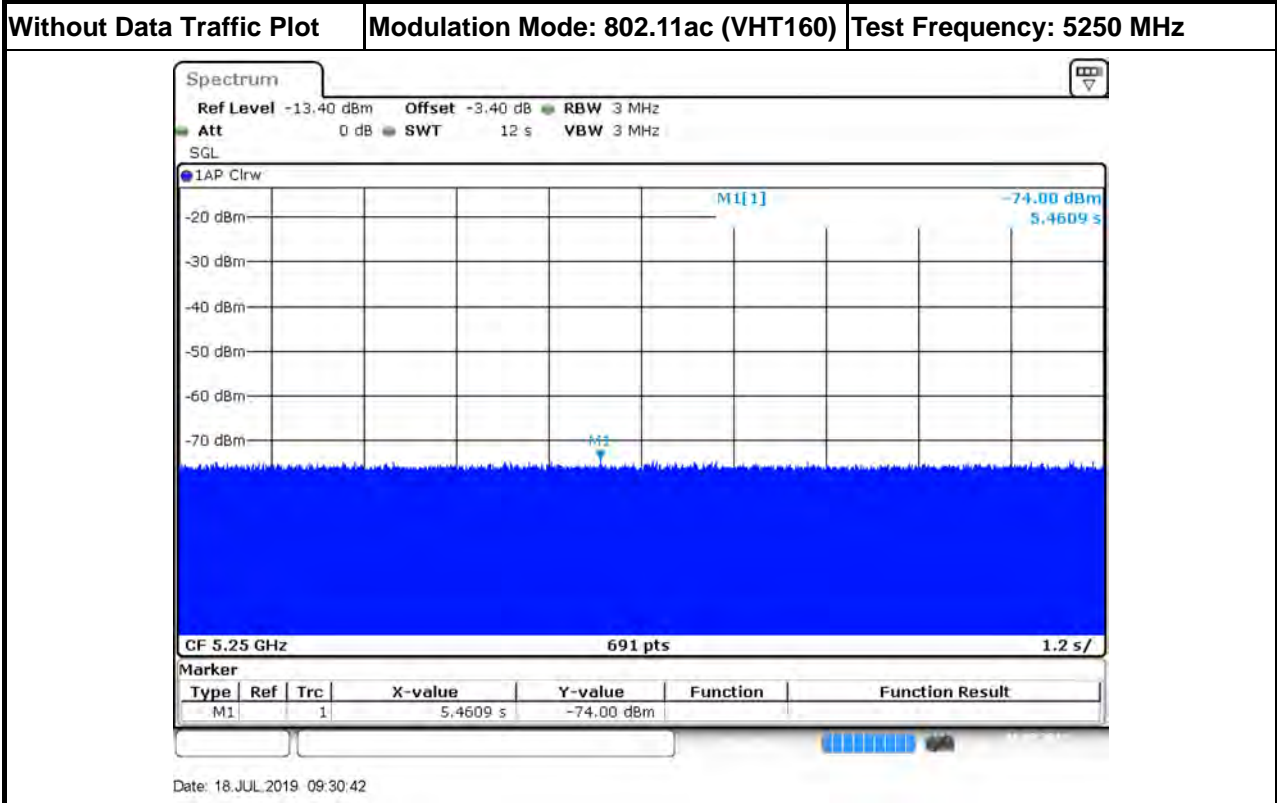
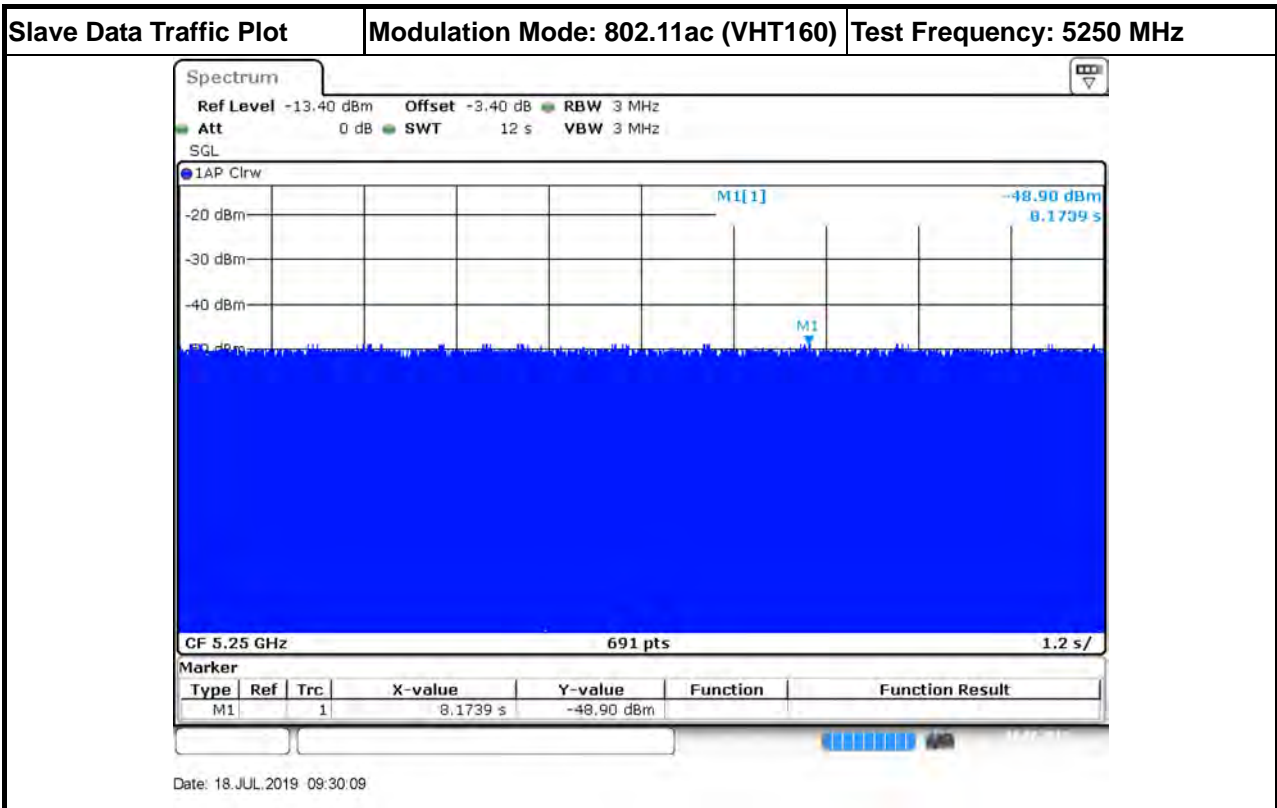

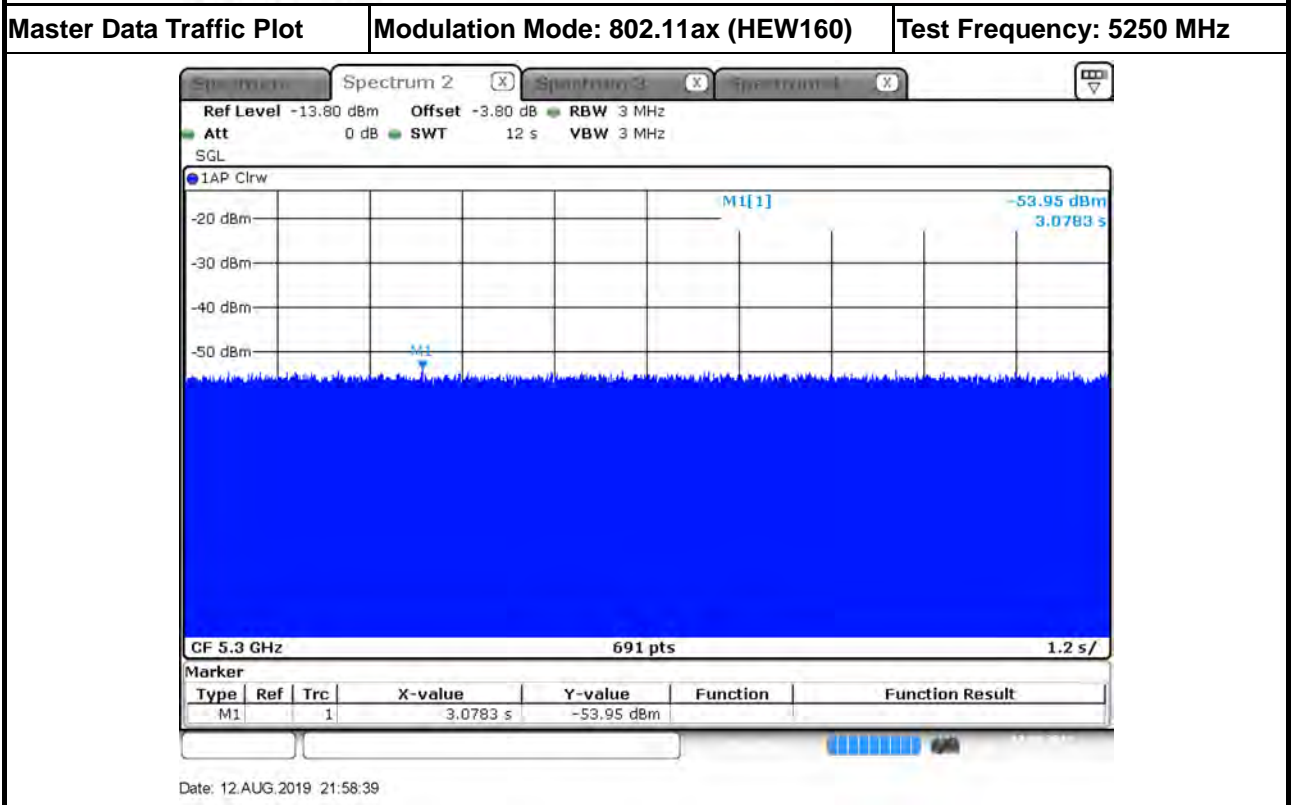
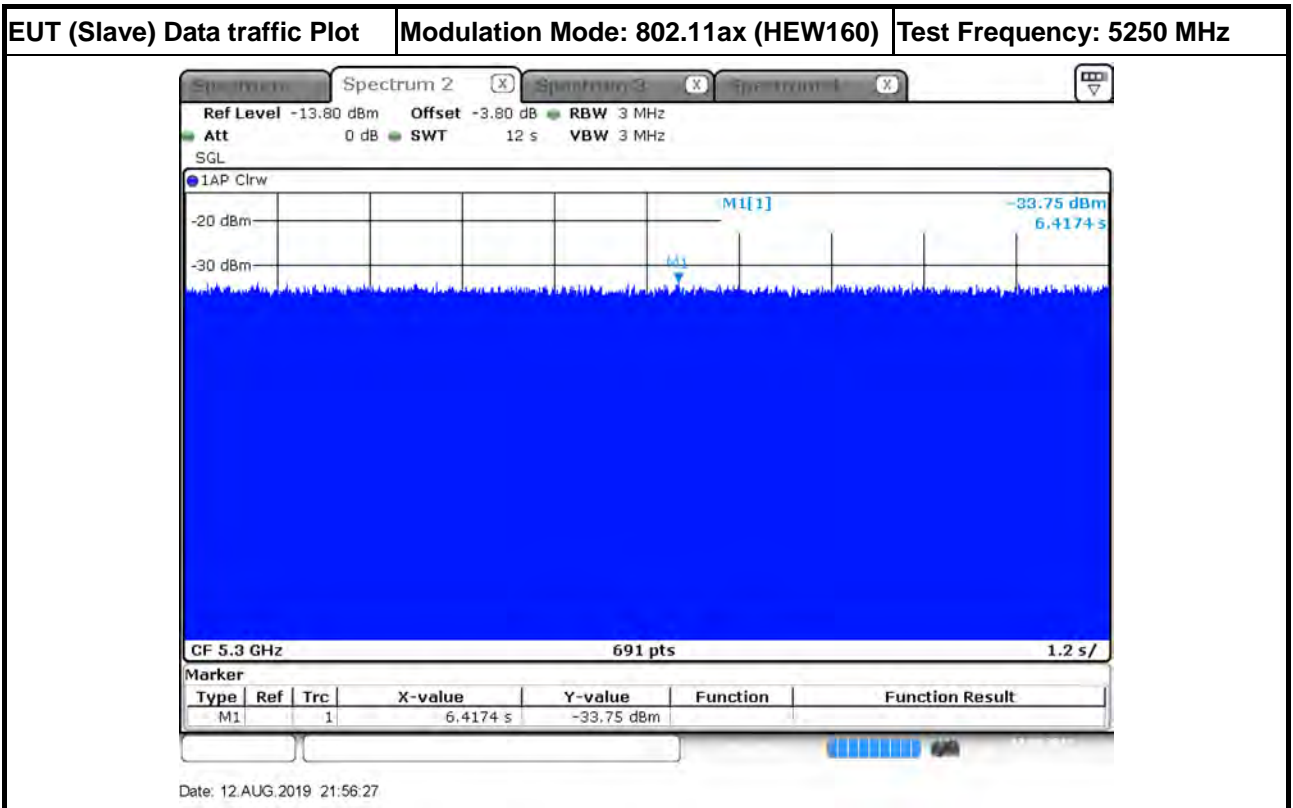

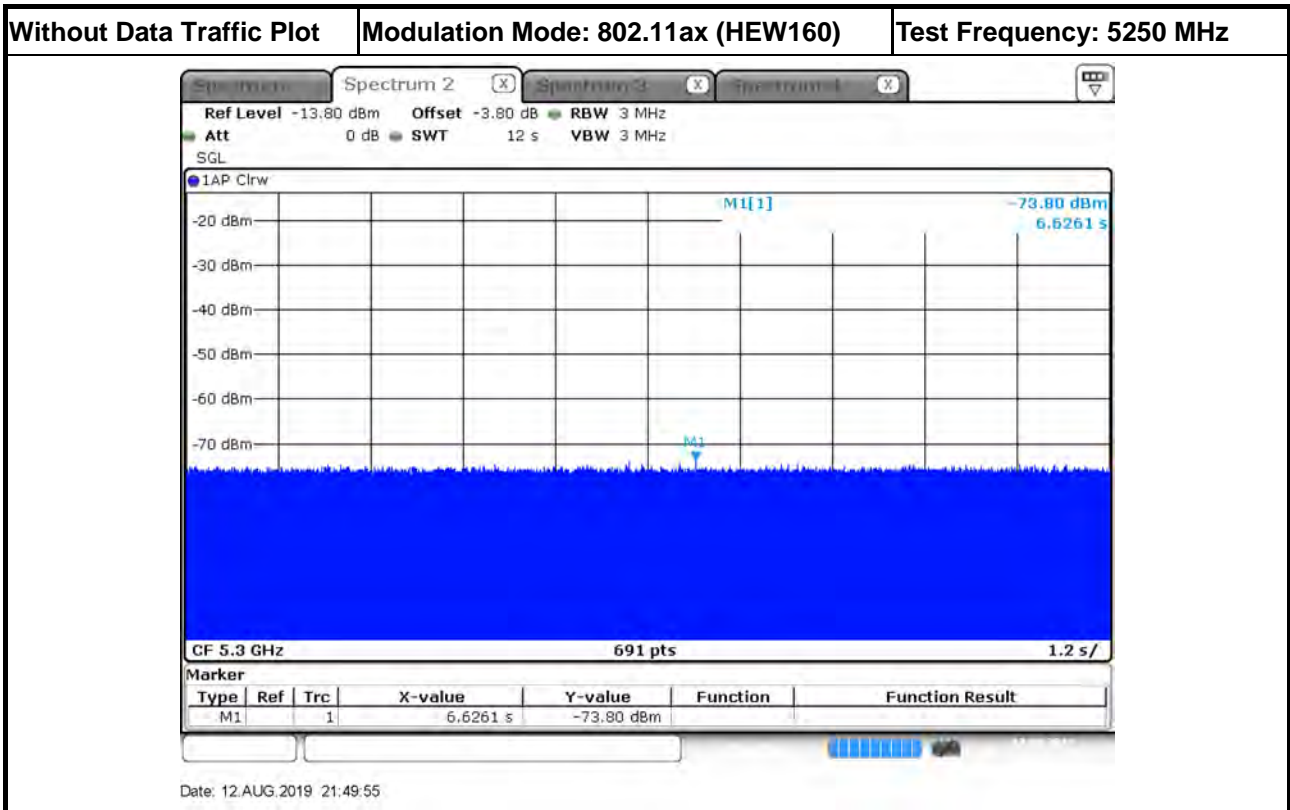

Note: The device operating in channel 50 bandwidth 160MHz monitoring on channel 60 since the control single is on channel 60.



3.3 UNII Detection Bandwidth

3.3.1 UNII Detection Bandwidth Limit

For Master mode

Channel Bandwidth (MHz)	Frequency (MHz)	99% Occupied Bandwidth (MHz)	UNII Detection Bandwidth Min. Limit (MHz)
802.11ac (VHT20)	5300 MHz	17.887	18
802.11ac (VHT40)	5310 MHz	37.047	38
802.11ac (VHT80)	5290 MHz	76.121	77
802.11ac (VHT160)	5250 MHz	77.279	78
802.11ax (HEW160)	5250 MHz	78.148	79

UNII Detection Bandwidth is minimum 100% of the 99% power bandwidth. A single radar Burst is generated for a minimum of 10 trials, and the response of the UUT is noted. The UUT must detect the Radar Waveform 90% or more of the time.

3.3.2 Measuring Instruments

Refer a test equipment and calibration data table in this test report.

3.3.3 Test Procedures

Test Method	
<input checked="" type="checkbox"/>	During the U-NII Detection Bandwidth detection test, radar type 0 is used and for each frequency step the minimum percentage of detection is 90 percent. Measurements are performed with no data traffic. The EUT is set up as a standalone device (no associated Client and no traffic). The radar frequency is increased in 1 MHz steps, repeating the above test sequence, until the detection rate falls below 90%. The highest frequency at which detection is greater than or equal to 90% is denoted as F_H . The radar frequency is decreased in 1 MHz steps, repeating the above test sequence, until the detection rate falls below 90%. The lowest frequency at which detection is greater than or equal to 90% is denoted as F_L . UNII Detection Bandwidth = $F_H - F_L$.



3.3.4 Test Result of UNII Detection Bandwidth

For Master mode

EUT Frequency= 5300 MHz												
Channel Bandwidth (MHz)	802.11ac (VHT20)											
Radar Frequency (MHz)	DFS Detection Trials (1=Detection, 0= No Detection)										Detection Rate (%)	
	1	2	3	4	5	6	7	8	9	10		
5290	0	0	0	0	0	0	0	0	0	0	0	0%
5291(FL)	1	0	1	1	1	1	1	1	1	1	1	90%
5292	1	1	1	1	1	1	1	1	1	1	1	100%
5293	1	1	1	1	1	1	1	1	1	1	1	100%
5294	1	1	1	1	1	1	1	1	1	1	1	100%
5295	1	1	1	1	1	1	1	1	1	1	1	100%
5300	1	1	1	1	1	1	1	1	1	1	1	100%
5305	1	1	1	1	1	1	1	1	1	1	1	100%
5306	1	1	1	1	1	1	1	1	1	1	1	100%
5307	1	1	1	1	1	1	1	1	1	1	1	100%
5308	1	1	1	1	1	1	1	1	1	1	1	100%
5309(FH)	1	1	1	0	1	1	1	1	1	1	1	90%
5310	0	0	0	0	0	0	0	0	0	0	0	0%
Radar Type 0-Detection Bandwidth (MHz) = (FH-FL) = (5309MHz-5291MHz)=											18	
UNII Detection Bandwidth Min. Limit (MHz) =											18	
Test Result											Complied	



EUT Frequency= 5310 MHz												
Channel Bandwidth (MHz)	802.11ac (VHT40)											
Radar Frequency (MHz)	DFS Detection Trials (1=Detection, 0= No Detection)										Detection Rate (%)	
	1	2	3	4	5	6	7	8	9	10		
5290	0	0	0	0	0	0	0	0	0	0	0	0%
5291(FL)	1	1	1	1	1	1	0	1	1	1	1	90%
5292	1	1	1	1	1	1	1	1	1	1	1	100%
5293	1	1	1	1	1	1	1	1	1	1	1	100%
5294	1	1	1	1	1	1	1	1	1	1	1	100%
5295	1	1	1	1	1	1	1	1	1	1	1	100%
5300	1	1	1	1	1	1	1	1	1	1	1	100%
5305	1	1	1	1	1	1	1	1	1	1	1	100%
5310	1	1	1	1	1	1	1	1	1	1	1	100%
5315	1	1	1	1	1	1	1	1	1	1	1	100%
5320	1	1	1	1	1	1	1	1	1	1	1	100%
5325	1	1	1	1	1	1	1	1	1	1	1	100%
5326	1	1	1	1	1	1	1	1	1	1	1	100%
5327	1	1	1	1	1	1	1	1	1	1	1	100%
5328	1	1	1	1	1	1	1	1	1	1	1	100%
5329(FH)	1	1	1	1	1	0	1	1	1	1	1	90%
5330	0	0	0	0	0	0	0	0	0	0	0	0%
Radar Type 0-Detection Bandwidth (MHz) = (FH-FL) = (5329MHz-5291MHz)=											38	
UNII Detection Bandwidth Min. Limit (MHz) =											38	
Test Result											Complied	



EUT Frequency= 5290 MHz											
Channel Bandwidth (MHz)	802.11ac (VHT80)										
Radar Frequency (MHz)	DFS Detection Trials (1=Detection, 0= No Detection)										Detection Rate (%)
	1	2	3	4	5	6	7	8	9	10	
5250	0	0	0	0	0	0	0	0	0	0	0%
5251(FL)	1	1	1	1	1	0	1	1	1	1	90%
5252	1	1	1	1	1	1	1	1	1	1	100%
5255	1	1	1	1	1	1	1	1	1	1	100%
5260	1	1	1	1	1	1	1	1	1	1	100%
5265	1	1	1	1	1	1	1	1	1	1	100%
5270	1	1	1	1	1	1	1	1	1	1	100%
5275	1	1	1	1	1	1	1	1	1	1	100%
5280	1	1	1	1	1	1	1	1	1	1	100%
5285	1	1	1	1	1	1	1	1	1	1	100%
5290	1	1	1	1	1	1	1	1	1	1	100%
5295	1	1	1	1	1	1	1	1	1	1	100%
5300	1	1	1	1	1	1	1	1	1	1	100%
5305	1	1	1	1	1	1	1	1	1	1	100%
5310	1	1	1	1	1	1	1	1	1	1	100%
5315	1	1	1	1	1	1	1	1	1	1	100%
5320	1	1	1	1	1	1	1	1	1	1	100%
5325	1	1	1	1	1	1	1	1	1	1	100%
5328	1	1	1	1	1	1	1	1	1	1	100%
5329(FH)	1	1	1	1	0	1	1	1	1	1	90%
5330	0	0	0	0	0	0	0	0	0	0	0%
Radar Type 0-Detection Bandwidth (MHz) = (FH-FL) = (5329MHz-5251MHz)=											78
UNII Detection Bandwidth Min. Limit (MHz) =											77
Test Result											Complied



EUT Frequency= 5250 MHz											
Channel Bandwidth (MHz)	802.11ac (VHT160)										
Radar Frequency (MHz)	DFS Detection Trials (1=Detection, 0= No Detection)										Detection Rate (%)
	1	2	3	4	5	6	7	8	9	10	
5249	0	0	0	0	0	0	0	0	0	0	0%
5250(FL)	1	1	1	1	1	1	0	1	1	1	90%
5255	1	1	1	1	1	1	1	1	1	1	100%
5260	1	1	1	1	1	1	1	1	1	1	100%
5265	1	1	1	1	1	1	1	1	1	1	100%
5270	1	1	1	1	1	1	1	1	1	1	100%
5275	1	1	1	1	1	1	1	1	1	1	100%
5280	1	1	1	1	1	1	1	1	1	1	100%
5285	1	1	1	1	1	1	1	1	1	1	100%
5290	1	1	1	1	1	1	1	1	1	1	100%
5295	1	1	1	1	1	1	1	1	1	1	100%
5300	1	1	1	1	1	1	1	1	1	1	100%
5305	1	1	1	1	1	1	1	1	1	1	100%
5310	1	1	1	1	1	1	1	1	1	1	100%
5315	1	1	1	1	1	1	1	1	1	1	100%
5320	1	1	1	1	1	1	1	1	1	1	100%
5325	1	1	1	1	1	1	1	1	1	1	100%
5326	1	1	1	1	1	1	1	1	1	1	100%
5327	1	1	1	1	1	1	1	1	1	1	100%
5328	1	1	1	1	1	1	1	1	1	1	100%
5329(FH)	1	1	1	1	0	1	1	1	1	1	90%
5330	0	0	0	0	0	0	0	0	0	0	0%
Radar Type 0-Detection Bandwidth (MHz) = (FH-FL) = (5329MHz-5250MHz)=											79
UNII Detection Bandwidth Min. Limit (MHz) =											78
Test Result											Complied



EUT Frequency= 5250 MHz												
Channel Bandwidth (MHz)	802.11ax (HEW160)											
Radar Frequency (MHz)	DFS Detection Trials (1=Detection, 0= No Detection)										Detection Rate (%)	
	1	2	3	4	5	6	7	8	9	10		
5249	0	0	0	0	0	0	0	0	0	0	0	0%
5250(FL)	1	1	1	1	1	1	0	1	1	1	1	90%
5255	1	1	1	1	1	1	1	1	1	1	1	100%
5260	1	1	1	1	1	1	1	1	1	1	1	100%
5265	1	1	1	1	1	1	1	1	1	1	1	100%
5270	1	1	1	1	1	1	1	1	1	1	1	100%
5275	1	1	1	1	1	1	1	1	1	1	1	100%
5280	1	1	1	1	1	1	1	1	1	1	1	100%
5285	1	1	1	1	1	1	1	1	1	1	1	100%
5290	1	1	1	1	1	1	1	1	1	1	1	100%
5295	1	1	1	1	1	1	1	1	1	1	1	100%
5300	1	1	1	1	1	1	1	1	1	1	1	100%
5305	1	1	1	1	1	1	1	1	1	1	1	100%
5310	1	1	1	1	1	1	1	1	1	1	1	100%
5315	1	1	1	1	1	1	1	1	1	1	1	100%
5320	1	1	1	1	1	1	1	1	1	1	1	100%
5325	1	1	1	1	1	1	1	1	1	1	1	100%
5326	1	1	1	1	1	1	1	1	1	1	1	100%
5327	1	1	1	1	1	1	1	1	1	1	1	100%
5328	1	1	1	1	1	1	1	1	1	1	1	100%
5329(FH)	1	1	1	1	0	1	1	1	1	1	1	90%
5330	0	0	0	0	0	0	0	0	0	0	0	0
Radar Type 0-Detection Bandwidth (MHz) = (FH-FL) = (5329MHz-5250MHz)=											79	
UNII Detection Bandwidth Min. Limit (MHz) =											79	
Test Result											Complied	



3.4 Channel Availability Check (CAC)

3.4.1 Channel Availability Check Limit

Channel Availability Check Limit	
<input checked="" type="checkbox"/>	The EUT shall perform a Channel Availability Check to ensure that there is no radar operating on the channel. After power-up sequence, receive at least 1 minute (60 sec) on the intended operating frequency.

3.4.2 Measuring Instruments

Refer a test equipment and calibration data table in this test report.

3.4.3 Test Procedures

Test Method	
<input checked="" type="checkbox"/>	For Initial Channel Availability Check Time. The EUT does not emit beacon, control, or data signals on the test Channel until the power-up sequence has been completed and the UNII device checks for Radar Waveforms for one minute on the test Channel. This test does not use any Radar Waveforms.
<input checked="" type="checkbox"/>	For Radar Burst at the Beginning of the Channel Availability Check Time. To verify successful radar detection on the selected Channel during a period equal to the Beginning of the Channel Availability Check Time.
<input checked="" type="checkbox"/>	For Radar Burst at the End of the Channel Availability Check Time. To verify successful radar detection on the selected Channel during a period equal to the End of the Channel Availability Check Time.



3.4.4 Test Result of Initial Channel Availability Check Time

For Master mode

Modulation Mode	Freq.	Radar Test Signal
802.11ac (VHT160)	5250 MHz	N/A

The EUT does not transmit any beacon or data transmissions until at least 1 minute after the completion of the power-on cycle (24.448 sec). The initial CAC time of the EUT is indicated by marker 1 (24.448 sec). Initial beacons/data transmissions are indicated by marker 2 (84.448 sec).

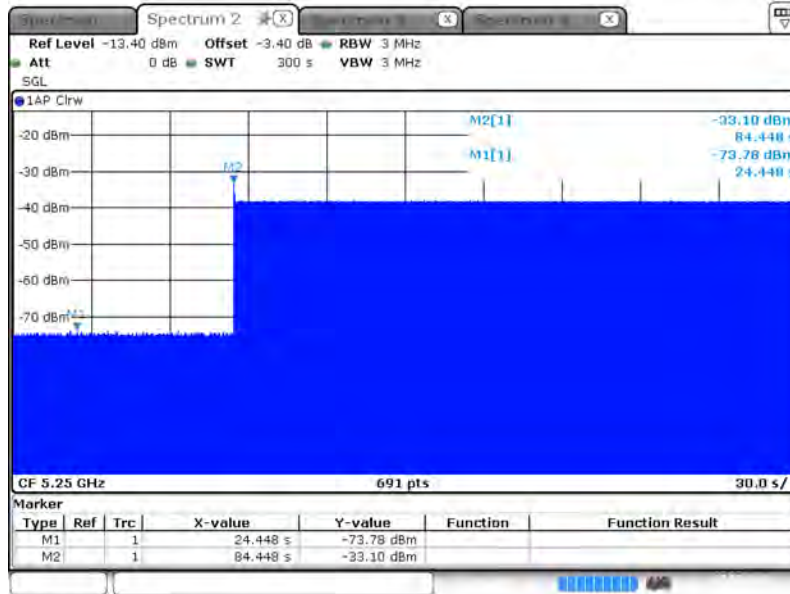

Date: 17.JUL.2019. 20:48:47

Test Result	Complied
--------------------	-----------------



3.4.5 Test Result of Radar Burst at the Beginning of the Channel Availability Check Time

For Master mode

Modulation Mode	Freq. (MHz)	Radar Type Signal
802.11ac (VHT160)	5250 MHz	0

Visual indication on the EUT of successful detection of the radar Burst will be recorded and reported. Observation of emissions will continue for 273.478 seconds after the radar Burst has been generated. Verify that during the 300 seconds measurement window no EUT transmissions occurred.

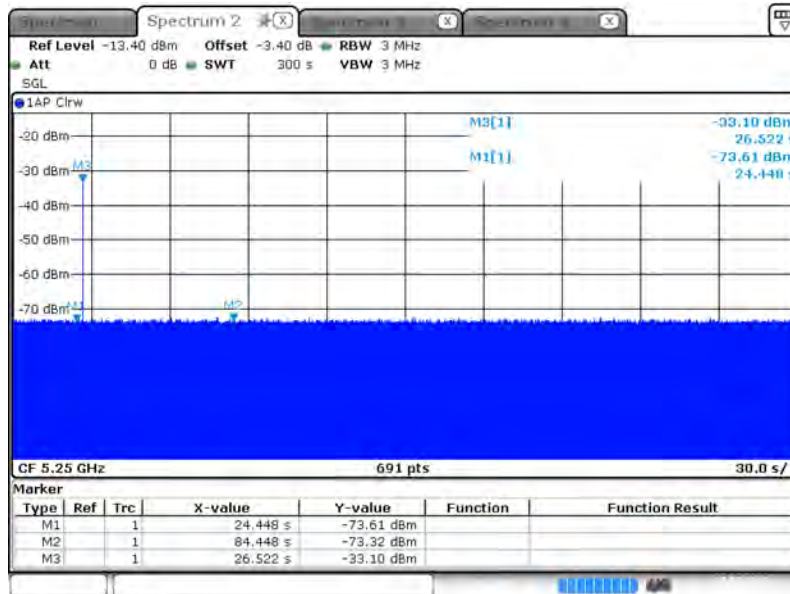

Date: 17 JUL 2019 21:23:28

Test Result	Complied
--------------------	-----------------



3.4.6 Test Result of Radar Burst at the End of the Channel Availability Check Time For Master mode

Modulation Mode	Freq. (MHz)	Radar Type Signal
802.11ac (VHT160)	5250 MHz	0

Visual indication on the EUT of successful detection of the radar Burst will be recorded and reported. Observation of emissions will continue for 217.826 seconds after the radar Burst has been generated. Verify that during the 300 seconds measurement window no EUT transmissions occurred.

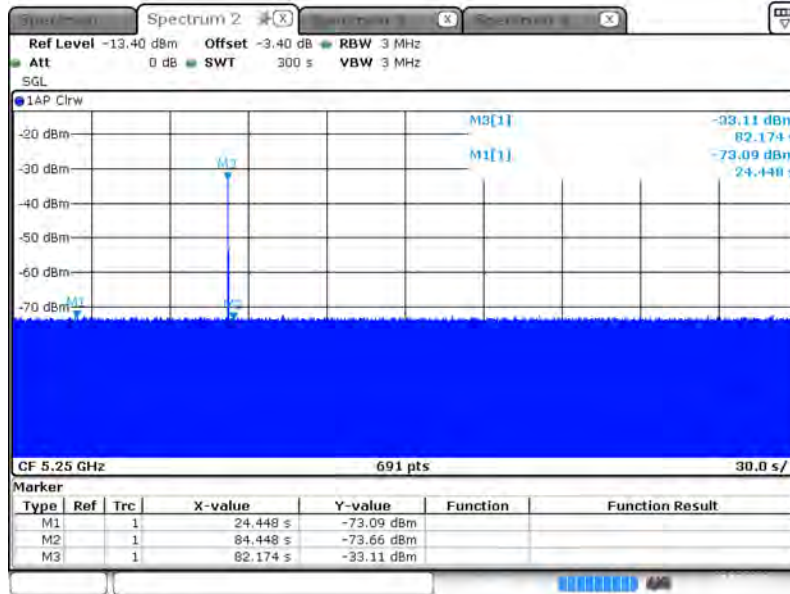

Date: 17.JUL.2019 21:14:18

Test Result	Complied
--------------------	-----------------



3.5 In-service Monitoring

3.5.1 In-service Monitoring Limit

In-service Monitoring Limit	
Channel Move Time	10 sec
Channel Closing Transmission Time	200 ms + an aggregate of 60 ms over remaining 10 sec periods.
Non-occupancy period	Minimum 30 minutes

3.5.2 Measuring Instruments

Refer a test equipment and calibration data table in this test report.

3.5.3 Test Procedures

Test Method	
<input checked="" type="checkbox"/>	Verified during In-Service Monitoring; Channel Closing Transmission Time, Channel Move Time. Client Device will associate with the EUT. Observe the transmissions of the EUT at the end of the radar Burst on the Operating Channel for duration greater than 10 seconds. Measure and record the transmissions from the EUT during the observation time (Channel Move Time). Compare the Channel Move Time and Channel Closing Transmission Time limits.
<input checked="" type="checkbox"/>	Verified during In-Service Monitoring; Channel Closing Transmission Time, Channel Move Time. One 12 sec plot needs to be reported for the Short Pulse Radar Types 0. And zoom-in a 60 ms plot verified channel closing time for the aggregate transmission time starting from 200ms after the end of the radar signal to the completion of the channel move.
<input checked="" type="checkbox"/>	Verified during In-Service Monitoring; Non-Occupancy Period. Client Device will associate with the EUT. Observe the transmissions of the EUT at the end of the radar Burst on the Operating Channel for duration greater than 10 seconds. Measure and record the transmissions from the EUT during the observation time (Non-Occupancy Period). Compare the Non-Occupancy Period limits.



3.5.4 Test Result of Channel Move Time

For Master mode

Modulation Mode: 802.11ac (VHT160)

Parameter	Test Result	Limit
	Type 0	
Test Channel (MHz)	5250 MHz	-
Channel Move Time (sec.)	0.834	< 10s

Modulation Mode: 802.11ax (HEW160)

Parameter	Test Result	Limit
	Type 0	
Test Channel (MHz)	5250 MHz	-
Channel Move Time (sec.)	0.887	< 10s

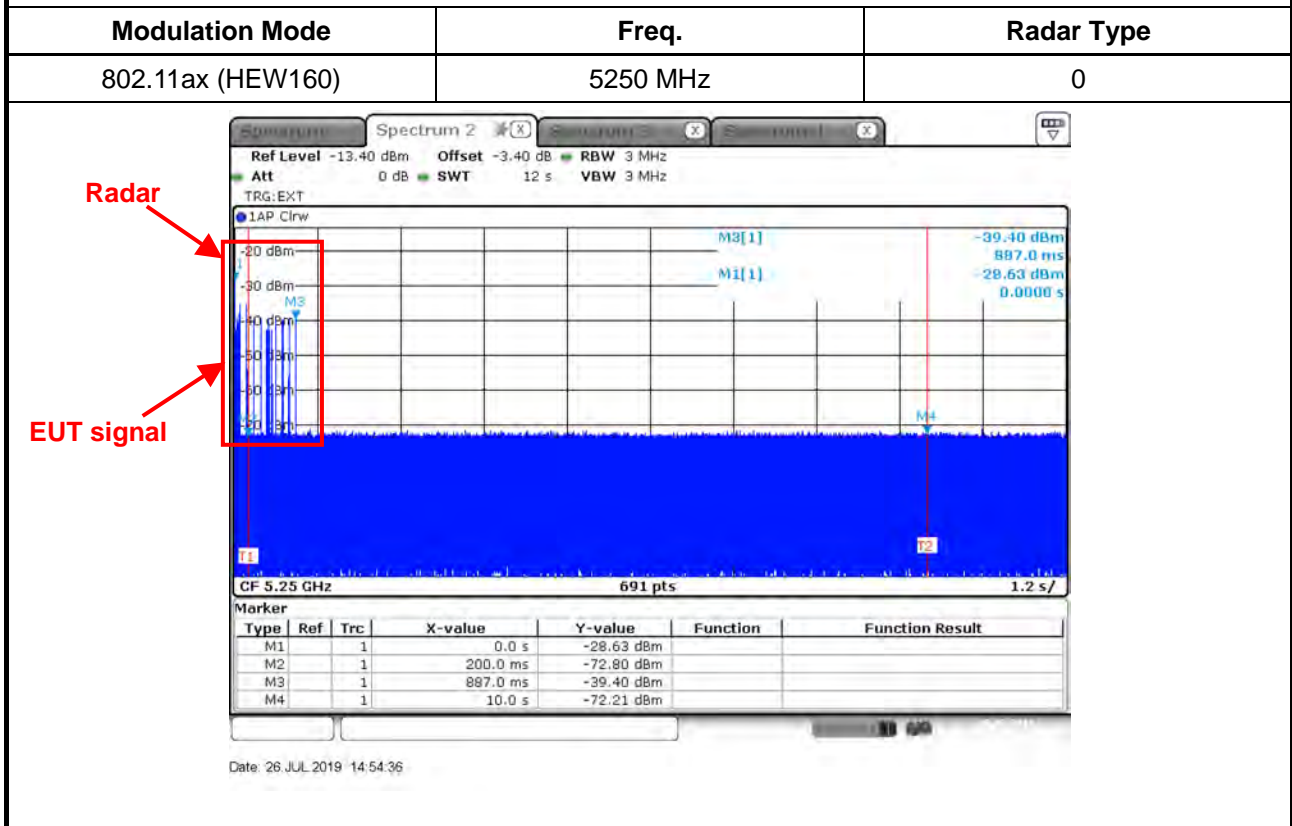
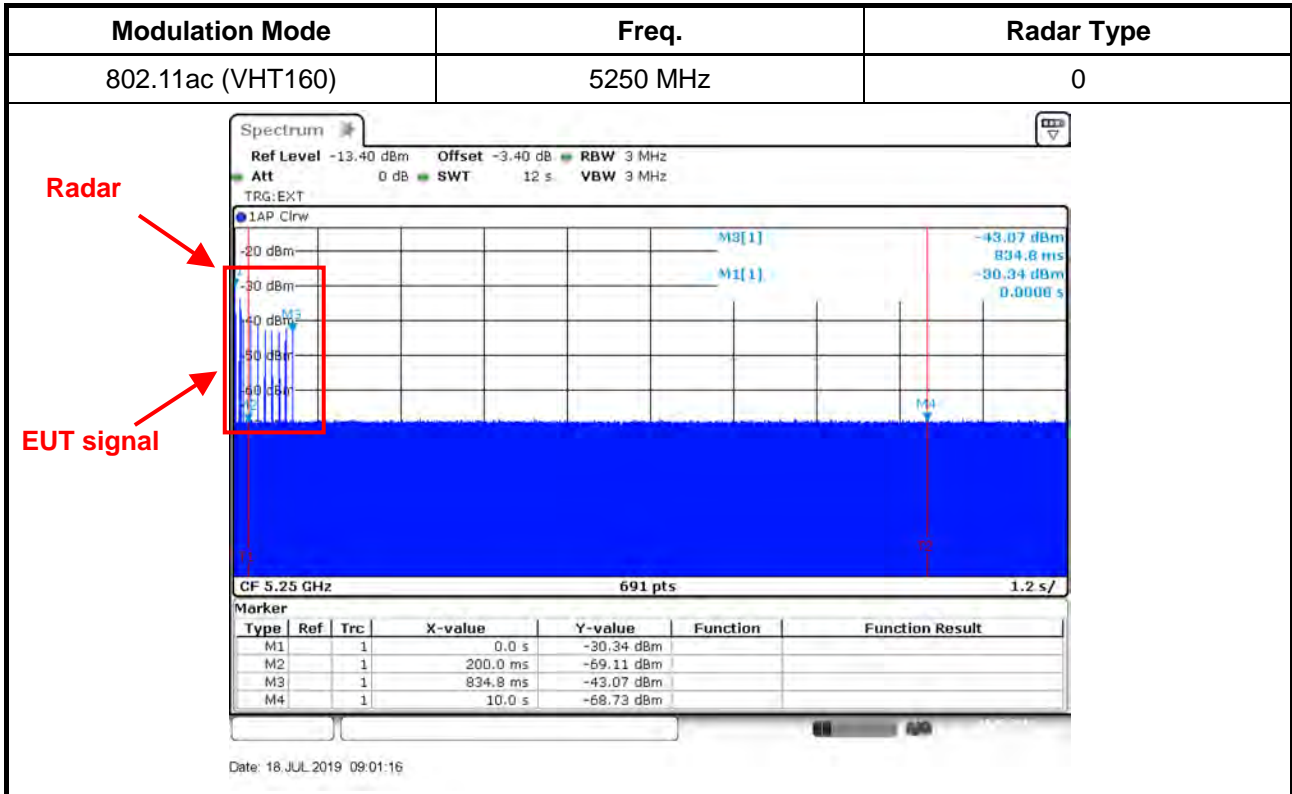



For Slave without radar detection mode

Modulation Mode: 802.11ax (HEW160)

Parameter	Test Result	Limit
	Type 0	
Test Channel (MHz)	5250 MHz	-
Channel Move Time (sec.)	0.052	< 10s

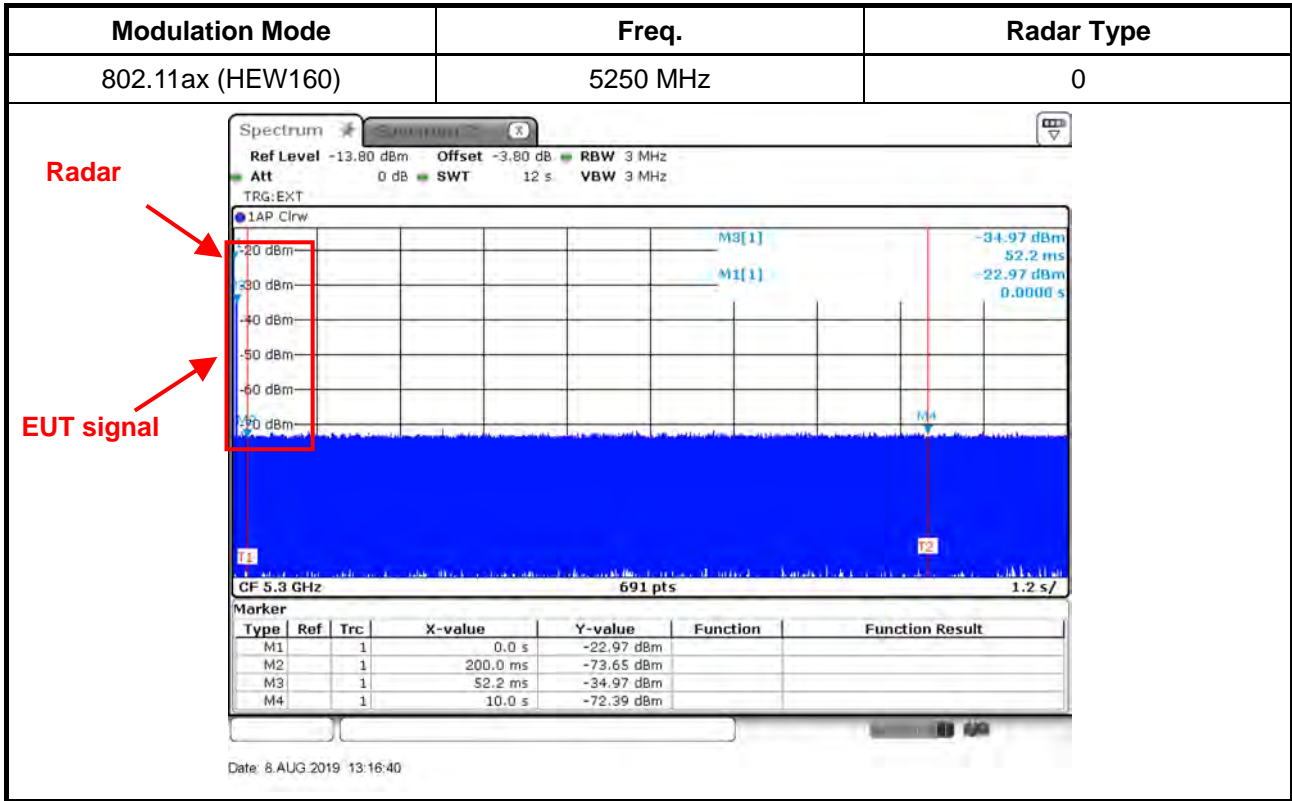



3.5.5 Test Result of Channel Closing Transmission Time

For Master mode

Modulation Mode: 802.11ac (VHT160)

Parameter	Test Result	Limit
	Type 0	
Test Channel (MHz)	5250 MHz	-
Channel Closing Transmission Time (ms) (Note)	23.188	< 60ms

Modulation Mode: 802.11ax (HEW160)

Parameter	Test Result	Limit
	Type 0	
Test Channel (MHz)	5250 MHz	-
Channel Closing Transmission Time (ms) (Note)	34.782	< 60ms

Note: The Channel Closing Transmission Time is comprised of 200 milliseconds starting at the beginning of the Channel Move Time plus any additional intermittent control signals required to facilitate a Channel move (an aggregate of 60 milliseconds) during the remainder of the 10 seconds period. The aggregate duration of control signals will not count quiet periods in between transmissions.



For Master mode

Modulation Mode	Freq.	Radar Type
802.11ac (VHT160)	5250 MHz	0

Channel Closing Transmission Time is comprised of 200 ms starting at the beginning of the Channel Move Time plus 60ms additional intermittent control signals

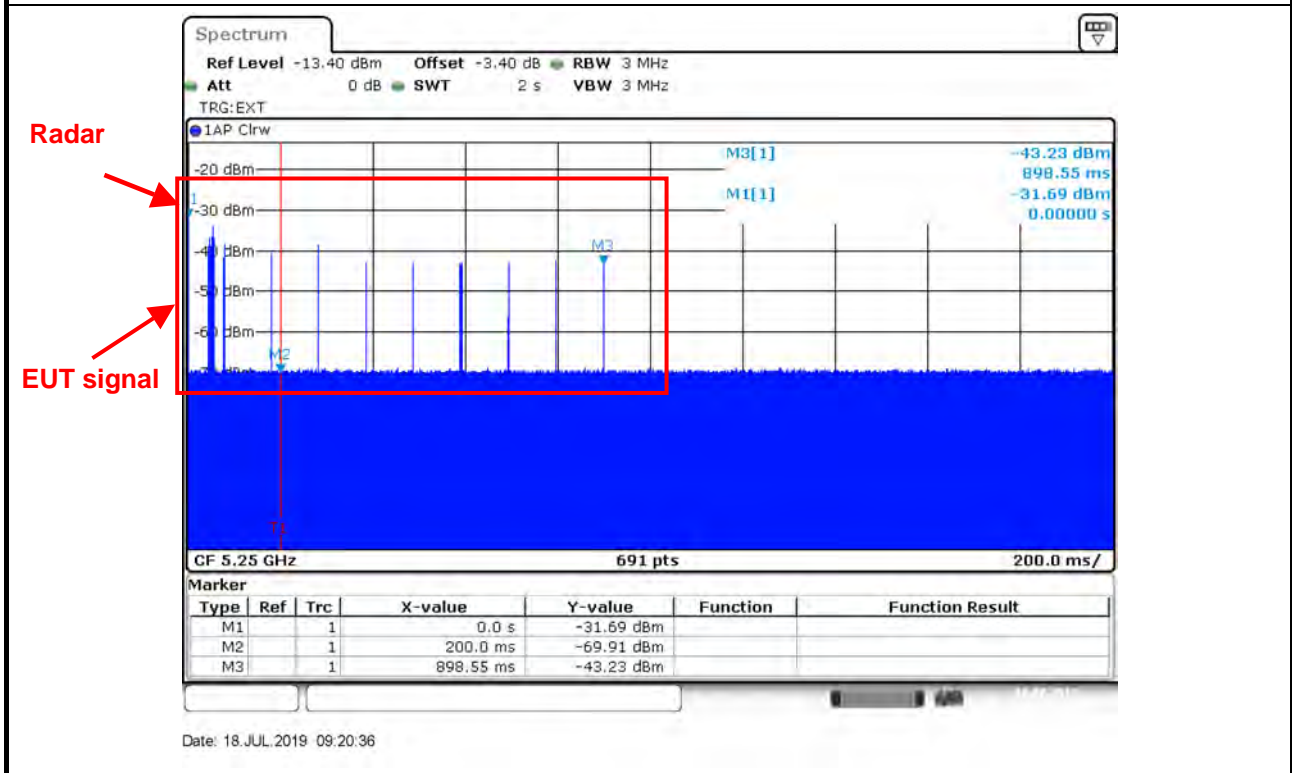

Dwell is the dwell time per spectrum analyzer sampling bin.

S is the sweep time

B is the number of spectrum analyzer sampling bins

C is the intermittent control signals of Channel Closing Transmission Time

N is the number of spectrum analyzer sampling bins (intermittent control signals) showing a U-NII transmission

$$\text{Dwell (2.899 ms)} = \text{S (2000 ms)} / \text{B (690)}$$

$$\text{C (23.188 ms)} = \text{N (8)} \times \text{Dwell (2.899 ms)}$$



Modulation Mode	Freq.	Radar Type
802.11ax (HEW160)	5250 MHz	0

Channel Closing Transmission Time is comprised of 200 ms starting at the beginning of the Channel Move Time plus 60ms additional intermittent control signals

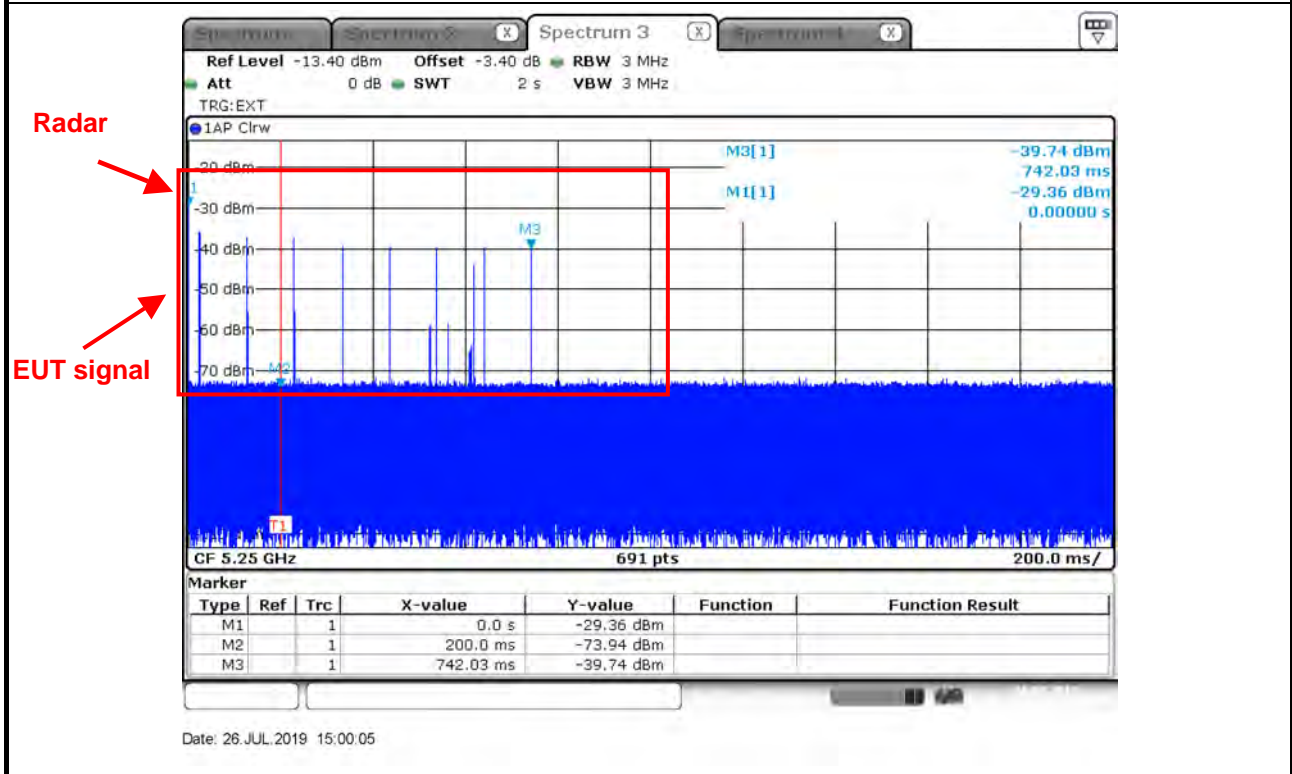

Dwell is the dwell time per spectrum analyzer sampling bin.

S is the sweep time

B is the number of spectrum analyzer sampling bins

C is the intermittent control signals of Channel Closing Transmission Time

N is the number of spectrum analyzer sampling bins (intermittent control signals) showing a U-NII transmission

Dwell (2.899 ms) = S (2000 ms) / B (690)

C (34.782 ms) = N (8) X Dwell (2.899 ms)



For Slave without radar detection mode

Modulation Mode: 802.11ax (HEW160)

Parameter	Test Result	Limit
	Type 0	
Test Channel (MHz)	5250 MHz	-
Channel Closing Transmission Time (ms) (Note)	0.000	< 60ms

Note: The Channel Closing Transmission Time is comprised of 200 milliseconds starting at the beginning of the Channel Move Time plus any additional intermittent control signals required to facilitate a Channel move (an aggregate of 60 milliseconds) during the remainder of the 10 seconds period. The aggregate duration of control signals will not count quiet periods in between transmissions.



Modulation Mode	Freq.	Radar Type
802.11ax (HEW160)	5250 MHz	0

Channel Closing Transmission Time is comprised of 200 ms starting at the beginning of the Channel Move Time plus 60ms additional intermittent control signals

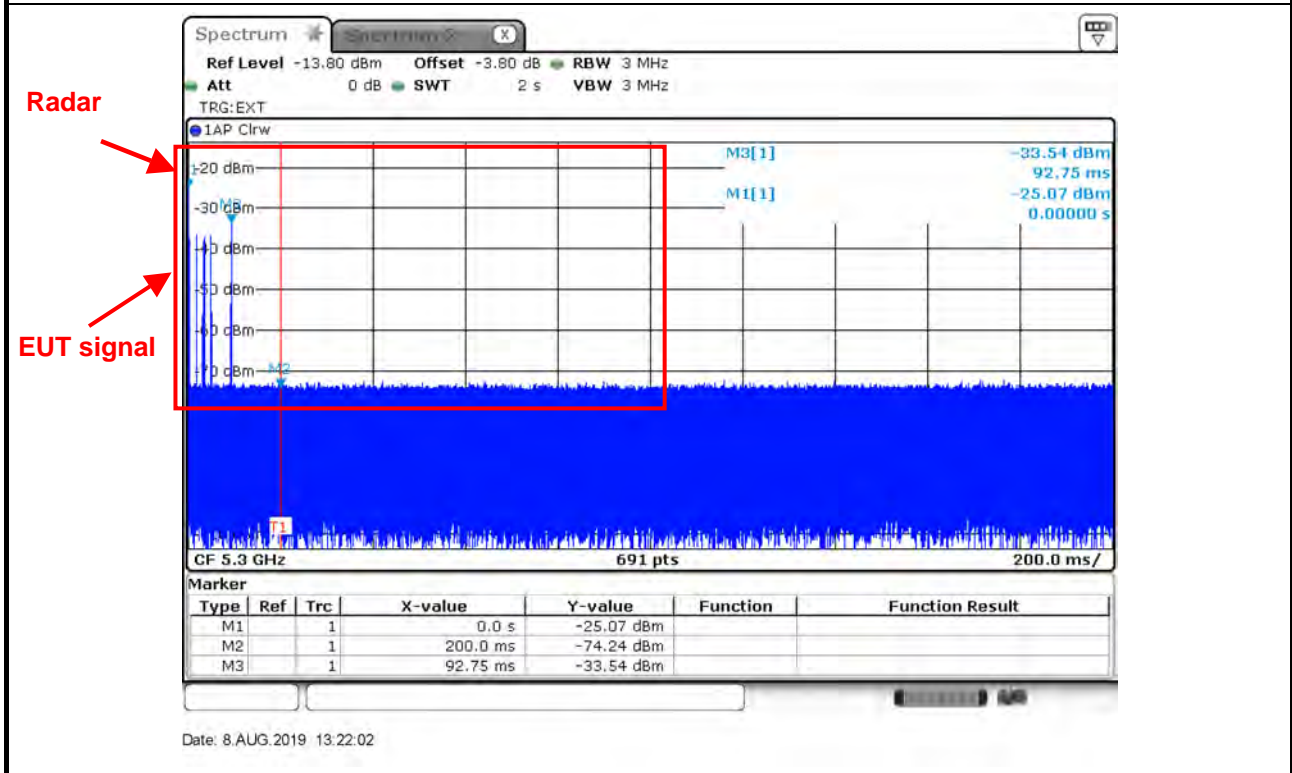

Dwell is the dwell time per spectrum analyzer sampling bin.

S is the sweep time

B is the number of spectrum analyzer sampling bins

C is the intermittent control signals of Channel Closing Transmission Time

N is the number of spectrum analyzer sampling bins (intermittent control signals) showing a U-NII transmission

$$\text{Dwell (2.899 ms)} = S (2000 \text{ ms}) / B (690)$$

$$C (0 \text{ ms}) = N (0) \times \text{Dwell (2.899 ms)}$$



3.5.6 Test Result of Non-Occupancy Period

For Master mode

Modulation Mode: 802.11ac (VHT160)

Parameter	Test Result	Limit
	Type 0	
Test Channel (MHz)	5250 MHz	-
Non-Occupancy Period (min.)	≥ 30	≥ 30 min



For Master mode

Modulation Mode	Freq.
802.11ac (VHT160)	5250 MHz

Non-Occupancy Period

During the 30 minutes observation time, UUT did not make any transmissions on a channel after a radar signal was detected on that channel by either the Channel Availability Check or the In-Service Monitoring.

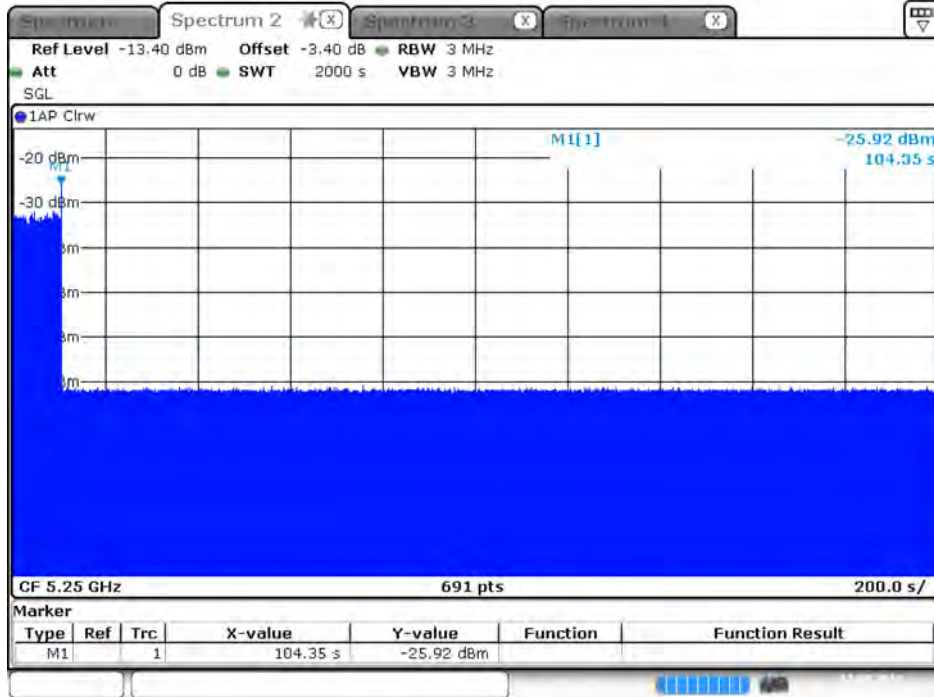

Date: 17.JUL.2019 22:08:47



**For Slave without radar detection mode
Modulation Mode: 802.11ax (HEW160)**

Parameter	Test Result	Limit
	Type 0	
Test Channel (MHz)	5250 MHz	-
Non-Occupancy Period (min.)	≥ 30	≥ 30 min



For Slave without radar detection mdoe

Modulation Mode	Freq.
802.11ax (HEW160)	5250 MHz

Non-Occupancy Period

During the 30 minutes observation time, UUT did not make any transmissions on a channel after a radar signal was detected on that channel by either the Channel Availability Check or the In-Service Monitoring.

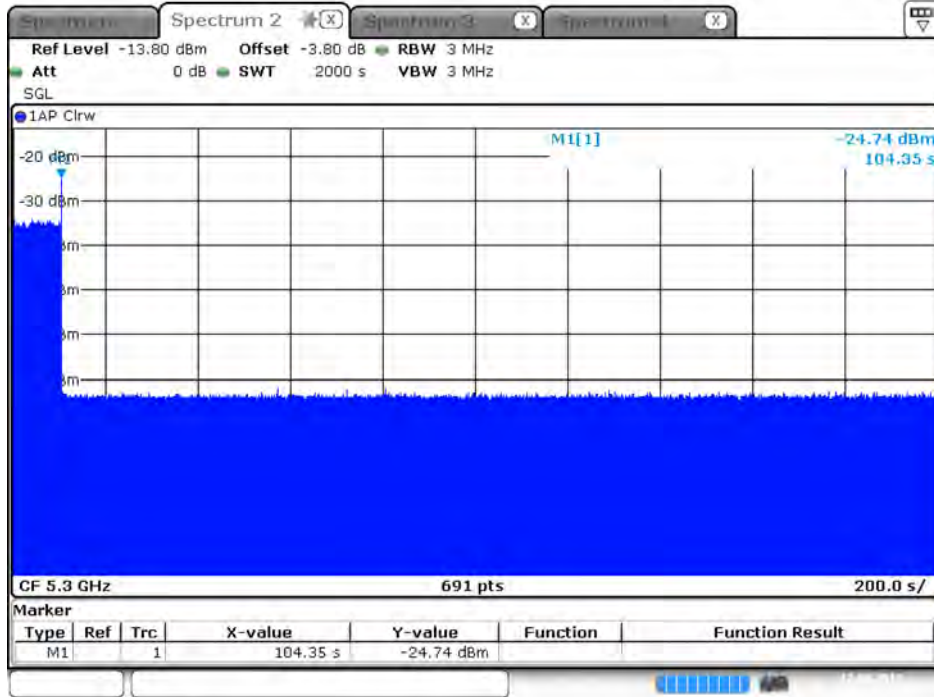

Date: 12.AUG.2019 21:47:46



Non-associated test

Master was off.

During the 30 minutes observation time, The UUT did not make any transmissions in the DFS band after UUT power up.

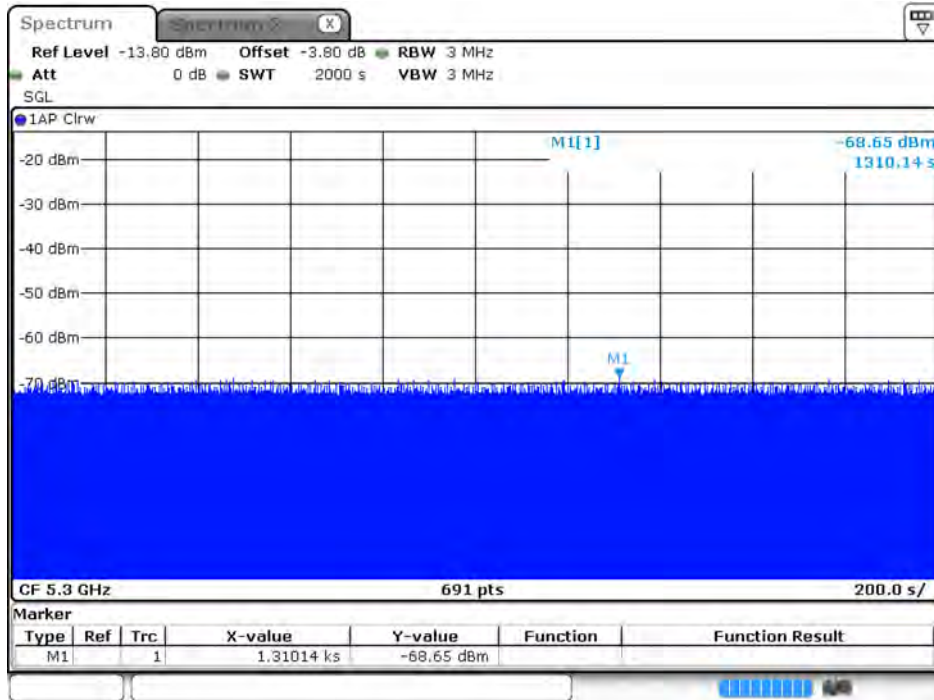

Date: 8.AUG.2019 14:42:41



3.6 Statistical Performance Check

3.6.1 Statistical Performance Check Limit

Radar Type	Minimum Percentage of Successful Detection (Pd)	Minimum Trials
1	60%	30
2	60%	30
3	60%	30
4	60%	30
Aggregate (Radar Types 1-4)	80%	120
5	80%	30
6	70%	30

The percentage of successful detection is calculated by:

$$\frac{\text{TotalWaveformDetections}}{\text{TotalWaveformTrails}} \times 100 = \text{Probability of Detection Radar Waveform}$$

In addition an aggregate minimum percentage of successful detection across all Short Pulse Radar Types 1-4 is required and is calculated as follows:

$$\frac{Pd1 + Pd2 + Pd3 + Pd4}{4}$$

3.6.2 Measuring Instruments

Refer a test equipment and calibration data table in this test report.

3.6.3 Test Procedures

Test Method
<input checked="" type="checkbox"/> For Statistical Performance Check test. Demonstrating a minimum channel loading of approximately 17% or greater of the test. Observe the transmissions of the UUT at the end of the Burst on the Operating Channel for duration greater than 10 seconds for Short Pulse Radar Types 1-4 and 6 to ensure detection occurs. Then Observe the transmissions of the UUT at the end of the Burst on the Operating Channel for duration greater than 22 seconds for Long Pulse Radar Type 5 to ensure detection occurs. The device can utilize a test mode to demonstrate when detection occurs to prevent the need to reset the device between trial runs.



3.6.4 Test Result of Statistical Performance Check

For Master mode

Modulation Mode: 802.11ac (VHT20)

Type 1 Radar Statistical Performance

Trial #	Test Freq. (MHz)	Pulse Repetition Frequency Number	Pulse Repetition Frequency (Pulse Per Second)	PRI (us)	1=Detection 0=No Detection
1	5303	1	1930.5	518	1
2	5304	23	326.2	3066	1
3	5305	19	1139.0	878	1
4	5304	12	1355.0	738	1
5	5300	4	1730.1	578	1
6	5309	8	1519.8	658	1
7	5291	15	1253.1	798	1
8	5305	6	1618.1	618	1
9	5291	14	1285.3	778	1
10	5309	3	1792.1	558	1
11	5304	13	1319.3	758	1
12	5298	9	1474.9	678	1
13	5299	7	1567.4	638	1
14	5304	17	1193.3	838	1
15	5299	10	1432.7	698	1
16	5292	-	1692.0	591	1
17	5303	-	328.1	3048	1
18	5298	-	373.4	2678	1
19	5300	-	574.4	1741	1
20	5304	-	1216.5	822	0
21	5292	-	801.3	1248	1
22	5294	-	488.5	2047	1
23	5296	-	956.0	1046	1
24	5299	-	517.6	1932	1
25	5306	-	1422.5	703	1
26	5291	-	542.0	1845	1
27	5296	-	741.3	1349	1
28	5293	-	881.8	1134	1
29	5305	-	427.4	2340	1
30	5294	-	628.9	1590	1
Detection Percentage (%)					96.667
Limit					60%
Test Result					Complied



Type 2 Radar Statistical Performance

Trial #	Test Freq. (MHz)	Pulse Width (us)	PRI (us)	Pulses / Burst	1=Detection 0=No Detection
1	5303	2.6	221	23	1
2	5304	4.6	198	27	1
3	5305	1.1	184	29	1
4	5304	4.8	203	24	1
5	5300	2.4	162	25	1
6	5309	3.4	204	28	1
7	5291	2.3	170	27	0
8	5305	3.5	184	23	1
9	5291	4.9	150	27	1
10	5309	4.6	211	29	1
11	5304	2.9	158	23	1
12	5298	2.6	226	27	1
13	5299	1.6	204	26	1
14	5304	3.9	181	25	0
15	5299	4.6	202	24	1
16	5292	4.1	194	27	1
17	5303	2.3	193	28	1
18	5298	3.9	173	29	1
19	5300	4.3	188	23	1
20	5304	1.5	215	26	0
21	5292	4.9	227	27	1
22	5294	1.1	199	23	1
23	5296	4.5	155	29	1
24	5299	4.0	190	27	1
25	5306	2.4	151	23	0
26	5291	2.5	180	28	1
27	5296	2.5	228	23	1
28	5293	2.5	203	25	1
29	5305	1.5	188	25	1
30	5294	1.9	217	24	1
Detection Percentage (%)					86.667
Limit					60%
Test Result					Complied



Type 3 Radar Statistical Performance

Trial #	Test Freq. (MHz)	Pulse Width (us)	PRI (us)	Pulses / Burst	1=Detection ; 0=No Detection
1	5303	8.0	205	16	1
2	5304	6.7	382	18	1
3	5305	8.6	418	16	0
4	5304	9.4	351	17	1
5	5300	7.4	383	18	1
6	5309	9.8	232	16	1
7	5291	9.1	377	17	1
8	5305	9.6	457	16	1
9	5291	8.0	471	18	0
10	5309	9.0	304	18	1
11	5304	8.0	316	17	1
12	5298	9.8	325	16	1
13	5299	8.0	409	17	1
14	5304	9.9	200	17	1
15	5299	8.8	458	16	1
16	5292	8.0	232	18	1
17	5303	8.3	250	16	0
18	5298	8.7	270	16	1
19	5300	7.7	350	17	1
20	5304	7.1	230	16	1
21	5292	7.3	416	18	1
22	5294	7.6	498	18	0
23	5296	7.3	286	17	1
24	5299	7.3	287	16	1
25	5306	7.5	462	17	1
26	5291	6.2	300	17	1
27	5296	6.4	323	18	1
28	5293	7.1	420	16	1
29	5305	7.2	395	18	1
30	5294	8.4	377	16	1
Detection Percentage (%)					86.667
Limit					60%
Test Result					Complied



Type 4 Radar Statistical Performance

<i>Trial #</i>	<i>Test Freq. (MHz)</i>	<i>Pulse Width (us)</i>	<i>PRI (us)</i>	<i>Pulses / Burst</i>	<i>1=Detection 0=No Detection</i>
1	5303	18.0	242	15	1
2	5304	19.9	279	12	1
3	5305	12.9	487	14	1
4	5304	15.0	452	13	1
5	5300	16.3	230	12	1
6	5309	19.8	238	13	1
7	5291	18.2	420	16	1
8	5305	16.3	452	15	0
9	5291	14.2	495	12	1
10	5309	17.8	228	16	1
11	5304	19.1	211	16	1
12	5298	18.4	283	15	1
13	5299	11.8	411	12	1
14	5304	14.2	284	13	1
15	5299	13.9	202	12	1
16	5292	17.8	340	14	1
17	5303	15.6	290	16	1
18	5298	14.6	250	16	0
19	5300	14.4	484	15	1
20	5304	18.9	387	13	1
21	5292	11.1	348	15	1
22	5294	13.8	291	16	1
23	5296	14.3	295	12	1
24	5299	12.5	300	12	1
25	5306	12.5	322	14	1
26	5291	12.5	383	13	1
27	5296	15.7	322	16	0
28	5293	19.8	469	13	1
29	5305	18.6	406	15	0
30	5294	15.9	238	14	1
Detection Percentage (%)					86.667
Limit					60%
Test Result					Complied



Total Type 1~4 Radar Statistical Performance

Radar Type #	Detection Percentage (%)
1	96.667
2	86.667
3	86.667
4	86.667
Aggregate (Radar Types 1-4)	89.167
Limit	80%
Test Result	Complied



Type 5 Radar Statistical Performance

Center Freq. (MHz)	Low Edge (MHz)	High Edge (MHz)	VSG Freq. (MHz)	Detection
Trial	Chirp	Offset		
1	5	2	5300	0
2	20	8	5300	1
3	7	2.8	5300	1
4	8	3.2	5300	1
5	9	3.6	5300	1
6	10	4	5300	1
7	11	4.4	5300	1
8	12	4.8	5300	1
9	13	5.2	5300	1
10	14	5.6	5300	1
11	15	6	5297	1
12	16	6.4	5297	1
13	17	6.8	5298	1
14	20	8	5299	1
15	19	7.6	5299	0
16	18	7.2	5298	0
17	17	6.8	5298	1
18	16	6.4	5297	1
19	15	6	5297	0
20	14	5.6	5297	1
21	13	5.2	5304	1
22	12	4.8	5304	1
23	11	4.4	5305	1
24	10	4	5305	1
25	9	3.6	5305	1
26	8	3.2	5306	1
27	18	7.2	5302	1
28	19	7.6	5301	1
29	20	8	5301	1
30	5	2	5307	1
Total				26
Detection Percentage (%)				86.667%
Limit				80%
Test Result				Complied



Trial Number							1
Number of Bursts in Trial							8
Chirp Center Frequency							5300
Burst	No. of Pulses	Pulse Width (us)	Chirp Width (MHz)	Pulse 1-to-2 Spacing (us)	Pulse 2-to-3 Spacing (us)	Starting Location Within Interval (ms)	
1	1	62.1	5	-	-	1091	
2	2	56	5	1729	-	133	
3	2	91.3	5	1230	-	1057	
4	3	50.7	5	1762	1616	1442	
5	2	92.6	5	1723	-	544	
6	2	87.3	5	1302	-	1089	
7	2	59.5	5	1291	-	1374	
8	2	52.2	5	1653	-	1237	
Detection Check (1=Detection; 0=No Detection)							0

Trial Number							2
Number of Bursts in Trial							9
Chirp Center Frequency							5300
Burst	No. of Pulses	Pulse Width (us)	Chirp Width (MHz)	Pulse 1-to-2 Spacing (us)	Pulse 2-to-3 Spacing (us)	Starting Location Within Interval (ms)	
1	3	90	20	1007	1326	30	
2	2	73.7	20	1785	-	979	
3	1	78.1	20	-	-	683	
4	2	92.4	20	1281	-	950	
5	1	61.2	20	-	-	612	
6	3	67.2	20	1525	1870	17	
7	1	78.5	20	-	-	429	
8	2	60.3	20	1931	-	936	
9	3	92.9	20	1403	1476	548	
Detection Check (1=Detection; 0=No Detection)							1



Trial Number							3
Number of Bursts in Trial							10
Chirp Center Frequency							5300
Burst	No. of Pulses	Pulse Width (us)	Chirp Width (MHz)	Pulse 1-to-2 Spacing (us)	Pulse 2-to-3 Spacing (us)	Starting Location Within Interval (ms)	
1	3	63.4	7	1574	1607	801	
2	1	98	7	-	-	966	
3	1	58.7	7	-	-	185	
4	1	88	7	-	-	1012	
5	3	79.5	7	1562	1370	943	
6	3	57.1	7	1900	1188	686	
7	2	64.4	7	1090	-	599	
8	1	78.7	7	-	-	1089	
9	1	69.3	7	-	-	188	
10	3	55.3	7	1375	1691	933	
Detection Check (1=Detection; 0=No Detection)							1

Trial Number							4
Number of Bursts in Trial							11
Chirp Center Frequency							5300
Burst	No. of Pulses	Pulse Width (us)	Chirp Width (MHz)	Pulse 1-to-2 Spacing (us)	Pulse 2-to-3 Spacing (us)	Starting Location Within Interval (ms)	
1	2	74.3	8	1642	-	24	
2	1	83.1	8	-	-	985	
3	2	59.5	8	1680	-	988	
4	2	59.8	8	1786	-	800	
5	2	77.6	8	1617	-	339	
6	2	79.9	8	1553	-	1040	
7	1	56	8	-	-	544	
8	3	71.4	8	1406	1927	452	
9	1	97.4	8	-	-	204	
10	2	98.3	8	1037	-	926	
11	1	63.6	8	-	-	1052	
Detection Check (1=Detection; 0=No Detection)							1



Trial Number							5
Number of Bursts in Trial							12
Chirp Center Frequency							5300
Burst	No. of Pulses	Pulse Width (us)	Chirp Width (MHz)	Pulse 1-to-2 Spacing (us)	Pulse 2-to-3 Spacing (us)	Starting Location Within Interval (ms)	
1	1	50	9	-	-	557	
2	2	62.5	9	1731	-	567	
3	2	55.4	9	1070	-	460	
4	1	65.7	9	-	-	4	
5	2	58	9	1512	-	64	
6	2	60.9	9	1230	-	650	
7	3	89.6	9	1598	1738	235	
8	3	84.4	9	1271	1617	873	
9	3	72.3	9	1498	1321	901	
10	1	58.9	9	-	-	663	
11	2	74.8	9	1584	-	919	
12	1	71.8	9	-	-	375	
Detection Check (1=Detection; 0=No Detection)							1

Trial Number							6
Number of Bursts in Trial							13
Chirp Center Frequency							5300
Burst	No. of Pulses	Pulse Width (us)	Chirp Width (MHz)	Pulse 1-to-2 Spacing (us)	Pulse 2-to-3 Spacing (us)	Starting Location Within Interval (ms)	
1	2	88.1	10	1257	-	846	
2	1	58.7	10	-	-	725	
3	2	97.1	10	1037	-	30	
4	3	83.1	10	1029	1106	490	
5	1	62.1	10	-	-	262	
6	2	71.4	10	1058	-	283	
7	2	86.3	10	1867	-	49	
8	3	77.3	10	1418	1876	634	
9	1	78.9	10	-	-	304	
10	3	79.2	10	1055	1572	564	
11	3	52	10	1582	1836	852	
12	3	56.5	10	1195	1542	525	
13	3	100	10	1638	1729	750	
Detection Check (1=Detection; 0=No Detection)							1



Trial Number							7
Number of Bursts in Trial							14
Chirp Center Frequency							5300
Burst	No. of Pulses	Pulse Width (us)	Chirp Width (MHz)	Pulse 1-to-2 Spacing (us)	Pulse 2-to-3 Spacing (us)	Starting Location Within Interval (ms)	
1	2	92.7	11	1208	-	231	
2	2	81.3	11	1144	-	804	
3	2	60.4	11	1555	-	34	
4	2	62.1	11	1320	-	427	
5	1	50	11	-	-	577	
6	3	65.9	11	1020	1365	3	
7	2	73.8	11	1308	-	51	
8	2	74.3	11	1143	-	360	
9	1	62.9	11	-	-	394	
10	2	74.8	11	1404	-	317	
11	2	69.7	11	1309	-	532	
12	2	69.8	11	1688	-	339	
13	2	77.4	11	1857	-	381	
14	1	55.1	11	-	-	426	
Detection Check (1=Detection; 0=No Detection)							1

Trial Number							8
Number of Bursts in Trial							15
Chirp Center Frequency							5300
Burst	No. of Pulses	Pulse Width (us)	Chirp Width (MHz)	Pulse 1-to-2 Spacing (us)	Pulse 2-to-3 Spacing (us)	Starting Location Within Interval (ms)	
1	1	91.7	12	-	-	776	
2	2	90	12	1196	-	187	
3	3	92.3	12	1486	1853	448	
4	2	66.8	12	1545	-	702	
5	1	64	12	-	-	403	
6	3	95.4	12	1123	1473	230	
7	3	66.8	12	1867	1401	604	
8	3	67.7	12	1472	1397	38	
9	1	68.2	12	-	-	735	
10	2	82.2	12	1297	-	610	
11	1	92.1	12	-	-	618	
12	2	57	12	1764	-	705	
13	2	58.5	12	1310	-	22	
14	3	85.5	12	1630	1447	641	
15	2	82.2	12	1371	-	109	
Detection Check (1=Detection; 0=No Detection)							1



Trial Number			9			
Number of Bursts in Trial			16			
Chirp Center Frequency			5300			
Burst	No. of Pulses	Pulse Width (us)	Chirp Width (MHz)	Pulse 1-to-2 Spacing (us)	Pulse 2-to-3 Spacing (us)	Starting Location Within Interval (ms)
1	2	74.4	13	1707	-	442
2	2	63.6	13	1725	-	280
3	2	71.3	13	1704	-	459
4	3	77.6	13	1063	1405	197
5	3	65.2	13	1731	1294	101
6	3	55.1	13	1109	1549	17
7	2	96.8	13	1034	-	131
8	3	80.8	13	1533	1051	365
9	1	60.4	13	-	-	222
10	2	61.8	13	1312	-	371
11	2	71.3	13	1657	-	33
12	2	98.1	13	1024	-	291
13	1	57.9	13	-	-	188
14	1	91.8	13	-	-	163
15	2	56.7	13	1259	-	426
16	2	89.7	13	1690	-	606
Detection Check (1=Detection; 0=No Detection)						1



Trial Number			10			
Number of Bursts in Trial			17			
Chirp Center Frequency			5300			
Burst	No. of Pulses	Pulse Width (us)	Chirp Width (MHz)	Pulse 1-to-2 Spacing (us)	Pulse 2-to-3 Spacing (us)	Starting Location Within Interval (ms)
1	2	74.4	14	1107	-	462
2	1	87.6	14	-	-	653
3	2	61.7	14	1741	-	457
4	2	57.5	14	1566	-	388
5	2	66.1	14	1855	-	63
6	3	70.1	14	1044	1012	136
7	1	66.4	14	-	-	343
8	1	59.2	14	-	-	349
9	2	88.3	14	1240	-	362
10	1	64.7	14	-	-	221
11	2	73	14	1703	-	144
12	2	81.7	14	1450	-	671
13	3	70.1	14	1741	1278	320
14	1	63.6	14	-	-	196
15	1	58.7	14	-	-	413
16	2	65.9	14	1478	-	170
17	1	72.7	14	-	-	564
Detection Check (1=Detection; 0=No Detection)						1



Trial Number			11			
Number of Bursts in Trial			18			
Chirp Center Frequency			5297			
Burst	No. of Pulses	Pulse Width (us)	Chirp Width (MHz)	Pulse 1-to-2 Spacing (us)	Pulse 2-to-3 Spacing (us)	Starting Location Within Interval (ms)
1	2	72.1	15	1193	-	130
2	3	76.3	15	1484	1390	114
3	1	86.1	15	-	-	14
4	1	73.2	15	-	-	604
5	1	81.2	15	-	-	548
6	2	99.5	15	1398	-	173
7	1	93.9	15	-	-	262
8	2	75.9	15	1921	-	38
9	3	79.2	15	1100	1429	84
10	3	77	15	1166	1799	610
11	1	91.8	15	-	-	339
12	3	56.8	15	1330	1556	580
13	2	83.1	15	1556	-	295
14	2	63	15	1552	-	156
15	1	65.7	15	-	-	439
16	1	64.5	15	-	-	188
17	1	88.5	15	-	-	419
18	1	60.6	15	-	-	205
Detection Check (1=Detection; 0=No Detection)						1



Trial Number			12			
Number of Bursts in Trial			19			
Chirp Center Frequency			5297			
Burst	No. of Pulses	Pulse Width (us)	Chirp Width (MHz)	Pulse 1-to-2 Spacing (us)	Pulse 2-to-3 Spacing (us)	Starting Location Within Interval (ms)
1	2	90.5	16	1299	-	381
2	2	88.4	16	1418	-	327
3	2	53.7	16	1055	-	536
4	1	80.5	16	-	-	285
5	1	50.4	16	-	-	398
6	2	61.2	16	1749	-	439
7	2	78.8	16	1065	-	129
8	3	75	16	1748	1820	325
9	2	96.7	16	1254	-	440
10	3	76.3	16	1848	1106	397
11	1	73.3	16	-	-	232
12	2	92.4	16	1317	-	91
13	2	92.4	16	1854	-	256
14	3	64.4	16	1240	1634	582
15	2	67.3	16	1473	-	117
16	2	84.1	16	1795	-	202
17	1	80.9	16	-	-	135
18	1	74.6	16	-	-	396
19	2	97.6	16	1805	-	615
Detection Check (1=Detection; 0=No Detection)						1



Trial Number							13
Number of Bursts in Trial							20
Chirp Center Frequency							5298
Burst	No. of Pulses	Pulse Width (us)	Chirp Width (MHz)	Pulse 1-to-2 Spacing (us)	Pulse 2-to-3 Spacing (us)	Starting Location Within Interval (ms)	
1	2	66.1	17	1417	-	388	
2	2	86.7	17	1693	-	348	
3	2	70.5	17	1263	-	215	
4	2	78	17	1446	-	28	
5	2	66	17	1185	-	585	
6	2	80.6	17	1855	-	65	
7	1	95.5	17	-	-	92	
8	1	98.8	17	-	-	68	
9	3	64.3	17	1641	1108	517	
10	1	75.1	17	-	-	121	
11	2	72.6	17	1499	-	448	
12	1	60.3	17	-	-	567	
13	2	54.9	17	1056	-	245	
14	2	98.8	17	1023	-	584	
15	2	60.9	17	1243	-	579	
16	2	62.7	17	1226	-	464	
17	1	80.1	17	-	-	89	
18	2	70.9	17	1711	-	153	
19	1	90.7	17	-	-	282	
20	1	98.9	17	-	-	71	
Detection Check (1=Detection; 0=No Detection)							1

Trial Number							14
Number of Bursts in Trial							8
Chirp Center Frequency							5299
Burst	No. of Pulses	Pulse Width (us)	Chirp Width (MHz)	Pulse 1-to-2 Spacing (us)	Pulse 2-to-3 Spacing (us)	Starting Location Within Interval (ms)	
1	2	67.5	20	1542	-	947	
2	3	83.6	20	1272	1696	124	
3	2	93.2	20	1877	-	701	
4	1	55.6	20	-	-	1123	
5	3	84.2	20	1733	1619	756	
6	3	69.1	20	1612	1071	1	
7	2	66.9	20	1905	-	7	
8	3	86.8	20	1697	1621	1082	
Detection Check (1=Detection; 0=No Detection)							1



Trial Number							15
Number of Bursts in Trial							9
Chirp Center Frequency							5299
Burst	No. of Pulses	Pulse Width (us)	Chirp Width (MHz)	Pulse 1-to-2 Spacing (us)	Pulse 2-to-3 Spacing (us)	Starting Location Within Interval (ms)	
1	2	62.2	19	1571	-	949	
2	2	85	19	1669	-	189	
3	2	64.5	19	1505	-	176	
4	2	50.4	19	1325	-	538	
5	2	66.1	19	1483	-	908	
6	2	71.2	19	1110	-	1017	
7	3	53.7	19	1445	1677	492	
8	3	62.5	19	1596	1341	349	
9	3	62	19	1929	1221	1105	
Detection Check (1=Detection; 0=No Detection)							0

Trial Number							16
Number of Bursts in Trial							10
Chirp Center Frequency							5298
Burst	No. of Pulses	Pulse Width (us)	Chirp Width (MHz)	Pulse 1-to-2 Spacing (us)	Pulse 2-to-3 Spacing (us)	Starting Location Within Interval (ms)	
1	2	80.5	18	1910	-	284	
2	2	64.2	18	1661	-	751	
3	2	90.1	18	1041	-	491	
4	2	69.8	18	1495	-	107	
5	1	73.1	18	-	-	490	
6	3	77.2	18	1418	1145	1155	
7	3	52.6	18	1732	1787	772	
8	2	71.4	18	1562	-	121	
9	2	89.8	18	1491	-	89	
10	2	76.4	18	1355	-	615	
Detection Check (1=Detection; 0=No Detection)							0



Trial Number							17
Number of Bursts in Trial							11
Chirp Center Frequency							5298
Burst	No. of Pulses	Pulse Width (us)	Chirp Width (MHz)	Pulse 1-to-2 Spacing (us)	Pulse 2-to-3 Spacing (us)	Starting Location Within Interval (ms)	
1	2	51.2	17	1236	-	740	
2	1	71.7	17	-	-	941	
3	2	74.7	17	1164	-	370	
4	2	50.9	17	1919	-	371	
5	2	65.2	17	1206	-	1033	
6	2	98	17	1182	-	346	
7	2	58.7	17	1612	-	639	
8	1	63.8	17	-	-	1056	
9	3	86.3	17	1545	1065	205	
10	1	94.4	17	-	-	753	
11	3	88.5	17	1699	1319	58	
Detection Check (1=Detection; 0=No Detection)							1

Trial Number							18
Number of Bursts in Trial							12
Chirp Center Frequency							5297
Burst	No. of Pulses	Pulse Width (us)	Chirp Width (MHz)	Pulse 1-to-2 Spacing (us)	Pulse 2-to-3 Spacing (us)	Starting Location Within Interval (ms)	
1	2	88.7	16	1405	-	448	
2	3	90.2	16	1544	1235	621	
3	1	96.5	16	-	-	512	
4	2	80.5	16	1090	-	321	
5	2	63.7	16	1268	-	798	
6	1	53.4	16	-	-	809	
7	2	52.3	16	1043	-	301	
8	3	54.7	16	1701	1104	796	
9	3	75.6	16	1923	1729	669	
10	2	59.2	16	1244	-	369	
11	1	56.3	16	-	-	51	
12	2	87.8	16	1608	-	733	
Detection Check (1=Detection; 0=No Detection)							1



Trial Number							19
Number of Bursts in Trial							13
Chirp Center Frequency							5297
Burst	No. of Pulses	Pulse Width (us)	Chirp Width (MHz)	Pulse 1-to-2 Spacing (us)	Pulse 2-to-3 Spacing (us)	Starting Location Within Interval (ms)	
1	2	68.2	15	1104	-	229	
2	2	58.4	15	1627	-	488	
3	3	74.7	15	1861	1015	137	
4	2	58.2	15	1593	-	520	
5	1	51.6	15	-	-	799	
6	2	94.7	15	1469	-	43	
7	2	70.7	15	1091	-	126	
8	2	82.9	15	1472	-	607	
9	3	62.7	15	1168	1453	527	
10	2	63.1	15	1529	-	143	
11	1	96.1	15	-	-	176	
12	2	57	15	1457	-	882	
13	3	95.6	15	1707	1501	214	
Detection Check (1=Detection; 0=No Detection)							0

Trial Number							20
Number of Bursts in Trial							14
Chirp Center Frequency							5297
Burst	No. of Pulses	Pulse Width (us)	Chirp Width (MHz)	Pulse 1-to-2 Spacing (us)	Pulse 2-to-3 Spacing (us)	Starting Location Within Interval (ms)	
1	1	95.7	14	-	-	117	
2	1	93.1	14	-	-	720	
3	1	55.8	14	-	-	297	
4	1	76.7	14	-	-	284	
5	2	68	14	1686	-	472	
6	3	94.1	14	1796	1393	264	
7	2	53.9	14	1293	-	525	
8	1	99.3	14	-	-	155	
9	2	73.3	14	1458	-	65	
10	2	93.3	14	1196	-	451	
11	3	55.8	14	1895	1034	243	
12	1	66.4	14	-	-	228	
13	2	65.6	14	1732	-	746	
14	2	76.5	14	1187	-	522	
Detection Check (1=Detection; 0=No Detection)							1



Trial Number							21
Number of Bursts in Trial							15
Chirp Center Frequency							5304
Burst	No. of Pulses	Pulse Width (us)	Chirp Width (MHz)	Pulse 1-to-2 Spacing (us)	Pulse 2-to-3 Spacing (us)	Starting Location Within Interval (ms)	
1	1	85.1	13	-	-	565	
2	2	72.5	13	1648	-	211	
3	1	67.5	13	-	-	348	
4	2	56.1	13	1360	-	156	
5	1	71.1	13	-	-	718	
6	2	93.1	13	1391	-	400	
7	1	56.5	13	-	-	482	
8	1	63.8	13	-	-	703	
9	2	67.4	13	1727	-	780	
10	1	52.3	13	-	-	102	
11	3	62.4	13	1228	1715	304	
12	2	53.3	13	1630	-	57	
13	2	83.1	13	1205	-	768	
14	2	93.7	13	1085	-	461	
15	2	90.7	13	1297	-	746	
Detection Check (1=Detection; 0=No Detection)							1

Trial Number							22
Number of Bursts in Trial							16
Chirp Center Frequency							5304
Burst	No. of Pulses	Pulse Width (us)	Chirp Width (MHz)	Pulse 1-to-2 Spacing (us)	Pulse 2-to-3 Spacing (us)	Starting Location Within Interval (ms)	
1	2	98.8	12	1439	-	95	
2	1	54.5	12	-	-	676	
3	2	80.5	12	1360	-	8	
4	2	55.9	12	1906	-	373	
5	2	72.1	12	1623	-	254	
6	2	84.4	12	1604	-	480	
7	1	78.5	12	-	-	663	
8	1	88	12	-	-	314	
9	2	74.7	12	1157	-	596	
10	2	97.1	12	1673	-	264	
11	1	81.6	12	-	-	740	
12	1	83.6	12	-	-	163	
13	3	87.6	12	1757	1322	628	
14	2	58.5	12	1372	-	132	
15	3	91.8	12	1767	1183	106	
16	2	58.8	12	1432	-	659	
Detection Check (1=Detection; 0=No Detection)							1



Trial Number			23			
Number of Bursts in Trial			17			
Chirp Center Frequency			5305			
Burst	No. of Pulses	Pulse Width (us)	Chirp Width (MHz)	Pulse 1-to-2 Spacing (us)	Pulse 2-to-3 Spacing (us)	Starting Location Within Interval (ms)
1	1	96	11	-	-	284
2	2	92.5	11	1241	-	488
3	2	89.5	11	1347	-	76
4	2	74.8	11	1607	-	688
5	2	60.6	11	1523	-	28
6	2	71.5	11	1659	-	383
7	2	71.1	11	1454	-	182
8	1	98.7	11	-	-	20
9	2	85.1	11	1770	-	576
10	2	89.2	11	1086	-	410
11	2	60.7	11	1101	-	458
12	2	75.2	11	1719	-	348
13	2	75.7	11	1799	-	481
14	3	56.7	11	1132	1884	587
15	2	65	11	1885	-	480
16	2	64.6	11	1910	-	195
17	3	69.9	11	1410	1190	396
Detection Check (1=Detection; 0=No Detection)						1



Trial Number			24			
Number of Bursts in Trial			18			
Chirp Center Frequency			5305			
Burst	No. of Pulses	Pulse Width (us)	Chirp Width (MHz)	Pulse 1-to-2 Spacing (us)	Pulse 2-to-3 Spacing (us)	Starting Location Within Interval (ms)
1	3	83.8	10	1290	1021	536
2	2	66.9	10	1112	-	44
3	3	91	10	1220	1504	611
4	2	86.1	10	1678	-	456
5	3	65.5	10	1928	1222	330
6	1	62.6	10	-	-	297
7	3	68.7	10	1505	1200	351
8	3	59.2	10	1452	1114	230
9	1	73.9	10	-	-	222
10	1	77.2	10	-	-	57
11	2	96.4	10	1357	-	399
12	2	99.9	10	1173	-	299
13	2	99.9	10	1520	-	464
14	1	86.7	10	-	-	294
15	1	92.6	10	-	-	653
16	1	77.1	10	-	-	550
17	2	81.1	10	1664	-	566
18	3	68.4	10	1536	1309	580
Detection Check (1=Detection; 0=No Detection)						1



Trial Number			25			
Number of Bursts in Trial			19			
Chirp Center Frequency			5305			
Burst	No. of Pulses	Pulse Width (us)	Chirp Width (MHz)	Pulse 1-to-2 Spacing (us)	Pulse 2-to-3 Spacing (us)	Starting Location Within Interval (ms)
1	3	68.2	9	1723	1868	471
2	3	83.7	9	1711	1405	368
3	2	69.7	9	1781	-	425
4	1	59.7	9	-	-	440
5	2	96.7	9	1484	-	123
6	2	95.8	9	1319	-	261
7	3	71.3	9	1095	1354	332
8	3	53.2	9	1527	1427	427
9	2	69.5	9	1771	-	397
10	3	63.9	9	1075	1447	67
11	2	93.4	9	1783	-	174
12	2	77.3	9	1564	-	17
13	2	73.1	9	1294	-	216
14	1	77.4	9	-	-	292
15	3	57.2	9	1722	1886	619
16	2	68.7	9	1629	-	233
17	1	60.8	9	-	-	226
18	3	69.7	9	1128	1224	599
19	1	62.2	9	-	-	433
Detection Check (1=Detection; 0=No Detection)						1



Trial Number							26
Number of Bursts in Trial							20
Chirp Center Frequency							5306
Burst	No. of Pulses	Pulse Width (us)	Chirp Width (MHz)	Pulse 1-to-2 Spacing (us)	Pulse 2-to-3 Spacing (us)	Starting Location Within Interval (ms)	
1	1	80.5	8	-	-	90	
2	3	62.6	8	1406	1343	319	
3	3	85.6	8	1190	1529	384	
4	2	83.9	8	1208	-	567	
5	2	92.4	8	1488	-	234	
6	2	54	8	1529	-	535	
7	3	81.3	8	1501	1812	325	
8	1	98.5	8	-	-	532	
9	1	85.8	8	-	-	272	
10	2	84.7	8	1593	-	182	
11	2	83.3	8	1705	-	134	
12	2	79.8	8	1567	-	286	
13	1	77.9	8	-	-	368	
14	3	98.4	8	1510	1569	290	
15	2	79.9	8	1588	-	231	
16	3	78	8	1140	1353	353	
17	3	55.2	8	1700	1327	53	
18	3	71.9	8	1081	1224	44	
19	1	62	8	-	-	298	
20	3	70.5	8	1888	1442	529	
Detection Check (1=Detection; 0=No Detection)							1

Trial Number							27
Number of Bursts in Trial							8
Chirp Center Frequency							5302
Burst	No. of Pulses	Pulse Width (us)	Chirp Width (MHz)	Pulse 1-to-2 Spacing (us)	Pulse 2-to-3 Spacing (us)	Starting Location Within Interval (ms)	
1	2	69.1	18	1076	-	1436	
2	2	62.1	18	1688	-	22	
3	2	94.8	18	1891	-	897	
4	1	75.8	18	-	-	1186	
5	2	65.4	18	1713	-	589	
6	2	97.7	18	1292	-	614	
7	3	98.1	18	1670	1711	506	
8	2	85.4	18	1672	-	776	
Detection Check (1=Detection; 0=No Detection)							1



Trial Number							28
Number of Bursts in Trial							9
Chirp Center Frequency							5301
Burst	No. of Pulses	Pulse Width (us)	Chirp Width (MHz)	Pulse 1-to-2 Spacing (us)	Pulse 2-to-3 Spacing (us)	Starting Location Within Interval (ms)	
1	3	82	19	1233	1713	679	
2	3	87.7	19	1554	1123	473	
3	2	98.9	19	1518	-	869	
4	1	55	19	-	-	719	
5	1	93.6	19	-	-	902	
6	2	58.7	19	1641	-	1243	
7	2	88.7	19	1387	-	410	
8	1	60.3	19	-	-	1154	
9	1	97.7	19	-	-	512	
Detection Check (1=Detection; 0=No Detection)							1

Trial Number							29
Number of Bursts in Trial							10
Chirp Center Frequency							5301
Burst	No. of Pulses	Pulse Width (us)	Chirp Width (MHz)	Pulse 1-to-2 Spacing (us)	Pulse 2-to-3 Spacing (us)	Starting Location Within Interval (ms)	
1	1	69.6	20	-	-	1131	
2	1	74.5	20	-	-	290	
3	1	60.9	20	-	-	895	
4	1	74.6	20	-	-	202	
5	2	99.3	20	1501	-	139	
6	2	95.3	20	1065	-	854	
7	2	91.9	20	1722	-	219	
8	2	51	20	1285	-	57	
9	2	87.7	20	1747	-	141	
10	1	87.2	20	-	-	596	
Detection Check (1=Detection; 0=No Detection)							1



Trial Number		30				
Number of Bursts in Trial		11				
Chirp Center Frequency		5307				
Burst	No. of Pulses	Pulse Width (us)	Chirp Width (MHz)	Pulse 1-to-2 Spacing (us)	Pulse 2-to-3 Spacing (us)	Starting Location Within Interval (ms)
1	3	59.9	5	1901	1196	935
2	2	77.1	5	1590	-	1038
3	2	62.7	5	1227	-	690
4	1	77.1	5	-	-	547
5	3	99.8	5	1798	1790	551
6	2	61.5	5	1135	-	876
7	2	77.5	5	1583	-	448
8	2	57.3	5	1890	-	736
9	2	53.5	5	1757	-	362
10	1	66.6	5	-	-	836
11	3	80.7	5	1811	1289	410
Detection Check (1=Detection; 0=No Detection)						1



Type 6 Radar Statistical Performance

Trial #	Test Freq. (MHz)	Pulses / Hop	Pulse Width (us)	PRI (us)	1=Detection 0=No Detection
1	5300	9	1	333	1
2	5300	9	1	333	1
3	5300	9	1	333	1
4	5300	9	1	333	1
5	5300	9	1	333	1
6	5300	9	1	333	1
7	5300	9	1	333	1
8	5300	9	1	333	1
9	5300	9	1	333	1
10	5300	9	1	333	1
11	5300	9	1	333	1
12	5300	9	1	333	1
13	5300	9	1	333	1
14	5300	9	1	333	1
15	5300	9	1	333	1
16	5300	9	1	333	1
17	5300	9	1	333	1
18	5300	9	1	333	1
19	5300	9	1	333	1
20	5300	9	1	333	1
21	5300	9	1	333	1
22	5300	9	1	333	1
23	5300	9	1	333	1
24	5300	9	1	333	1
25	5300	9	1	333	1
26	5300	9	1	333	1
27	5300	9	1	333	1
28	5300	9	1	333	1
29	5300	9	1	333	1
30	5300	9	1	333	1
Detection Percentage (%)					100.00
Limit					70%
Test Result					Complied



Modulation Mode: 802.11ac (VHT40)

Type 1 Radar Statistical Performance

Trial #	Test Freq. (MHz)	Pulse Repetition Frequency Number	Pulse Repetition Frequency (Pulse Per Second)	PRI (us)	1=Detection 0=No Detection
1	5316	1	1930.5	518	1
2	5306	23	326.2	3066	0
3	5322	19	1139.0	878	1
4	5298	12	1355.0	738	1
5	5297	4	1730.1	578	1
6	5307	8	1519.8	658	1
7	5320	15	1253.1	798	1
8	5302	6	1618.1	618	0
9	5324	14	1285.3	778	1
10	5321	3	1792.1	558	1
11	5296	13	1319.3	758	1
12	5295	9	1474.9	678	1
13	5323	7	1567.4	638	1
14	5309	17	1193.3	838	1
15	5309	10	1432.7	698	1
16	5325	-	1692.0	591	1
17	5322	-	328.1	3048	1
18	5322	-	373.4	2678	1
19	5294	-	574.4	1741	1
20	5312	-	1216.5	822	1
21	5311	-	801.3	1248	1
22	5305	-	488.5	2047	1
23	5298	-	956.0	1046	1
24	5310	-	517.6	1932	1
25	5317	-	1422.5	703	1
26	5292	-	542.0	1845	1
27	5307	-	741.3	1349	1
28	5315	-	881.8	1134	1
29	5292	-	427.4	2340	1
30	5320	-	628.9	1590	1
Detection Percentage (%)					93.333
Limit					60%
Test Result					Complied



Type 2 Radar Statistical Performance

Trial #	Test Freq. (MHz)	Pulse Width (us)	PRI (us)	Pulses / Burst	1=Detection 0=No Detection
1	5327	2.6	221	23	1
2	5315	4.6	198	27	0
3	5300	1.1	184	29	1
4	5293	4.8	203	24	0
5	5320	2.4	162	25	1
6	5310	3.4	204	28	1
7	5296	2.3	170	27	1
8	5325	3.5	184	23	1
9	5300	4.9	150	27	0
10	5318	4.6	211	29	1
11	5328	2.9	158	23	1
12	5291	2.6	226	27	1
13	5306	1.6	204	26	1
14	5300	3.9	181	25	1
15	5308	4.6	202	24	1
16	5311	4.1	194	27	1
17	5291	2.3	193	28	1
18	5311	3.9	173	29	1
19	5304	4.3	188	23	1
20	5320	1.5	215	26	1
21	5293	4.9	227	27	1
22	5314	1.1	199	23	1
23	5293	4.5	155	29	1
24	5314	4.0	190	27	1
25	5328	2.4	151	23	1
26	5313	2.5	180	28	1
27	5297	2.5	228	23	1
28	5321	2.5	203	25	1
29	5307	1.5	188	25	1
30	5329	1.9	217	24	1
Detection Percentage (%)					90.000
Limit					60%
Test Result					Complied



Type 3 Radar Statistical Performance

Trial #	Test Freq. (MHz)	Pulse Width (us)	PRI (us)	Pulses / Burst	1=Detection 0=No Detection
1	5316	8.0	205	16	1
2	5329	6.7	382	18	1
3	5314	8.6	418	16	1
4	5305	9.4	351	17	1
5	5293	7.4	383	18	1
6	5292	9.8	232	16	1
7	5323	9.1	377	17	1
8	5324	9.6	457	16	1
9	5325	8.0	471	18	1
10	5317	9.0	304	18	1
11	5318	8.0	316	17	0
12	5296	9.8	325	16	1
13	5294	8.0	409	17	0
14	5317	9.9	200	17	1
15	5322	8.8	458	16	1
16	5310	8.0	232	18	1
17	5313	8.3	250	16	1
18	5307	8.7	270	16	1
19	5299	7.7	350	17	1
20	5328	7.1	230	16	1
21	5321	7.3	416	18	1
22	5326	7.6	498	18	1
23	5323	7.3	286	17	1
24	5319	7.3	287	16	1
25	5310	7.5	462	17	1
26	5327	6.2	300	17	1
27	5292	6.4	323	18	1
28	5300	7.1	420	16	1
29	5295	7.2	395	18	1
30	5308	8.4	377	16	1
Detection Percentage (%)					93.333
Limit					60%
Test Result					Complied



Type 4 Radar Statistical Performance

Trial #	Test Freq. (MHz)	Pulse Width (us)	PRI (us)	Pulses / Burst	1=Detection 0=No Detection
1	5291	18.0	242	15	1
2	5310	19.9	279	12	1
3	5306	12.9	487	14	1
4	5316	15.0	452	13	0
5	5303	16.3	230	12	1
6	5327	19.8	238	13	1
7	5308	18.2	420	16	1
8	5295	16.3	452	15	1
9	5319	14.2	495	12	1
10	5315	17.8	228	16	1
11	5329	19.1	211	16	1
12	5318	18.4	283	15	1
13	5328	11.8	411	12	1
14	5296	14.2	284	13	1
15	5298	13.9	202	12	1
16	5328	17.8	340	14	0
17	5301	15.6	290	16	1
18	5307	14.6	250	16	1
19	5301	14.4	484	15	1
20	5319	18.9	387	13	1
21	5308	11.1	348	15	1
22	5292	13.8	291	16	1
23	5296	14.3	295	12	1
24	5302	12.5	300	12	1
25	5318	12.5	322	14	0
26	5291	12.5	383	13	1
27	5325	15.7	322	16	0
28	5304	19.8	469	13	1
29	5322	18.6	406	15	1
30	5316	15.9	238	14	1
Detection Percentage (%)					86.667
Limit					60%
Test Result					Complied



Total Type 1~4 Radar Statistical Performance

Radar Type #	Detection Percentage (%)
1	93.333
2	90.000
3	93.333
4	86.667
Aggregate (Radar Types 1-4)	90.833
Limit	80%
Test Result	Complied



Type 5 Radar Statistical Performance

Center Freq. (MHz)	Low Edge (MHz)	High Edge (MHz)	VSG Freq. (MHz)	Detection
Trial	Chirp	Offset		
1	5	2	5310	1
2	20	8	5310	1
3	7	2.8	5310	1
4	8	3.2	5310	1
5	9	3.6	5310	1
6	10	4	5310	1
7	11	4.4	5310	1
8	12	4.8	5310	0
9	13	5.2	5310	1
10	14	5.6	5310	1
11	15	6	5297	1
12	16	6.4	5297	1
13	17	6.8	5298	1
14	20	8	5299	1
15	19	7.6	5299	1
16	18	7.2	5298	1
17	17	6.8	5298	0
18	16	6.4	5297	1
19	15	6	5297	1
20	14	5.6	5297	1
21	13	5.2	5324	1
22	12	4.8	5324	1
23	11	4.4	5325	1
24	10	4	5325	1
25	9	3.6	5325	1
26	8	3.2	5326	1
27	18	7.2	5322	0
28	19	7.6	5321	1
29	20	8	5321	1
30	5	2	5327	1
Total				27
Detection Percentage (%)				90%
Limit				80%
Test Result				Complied



Trial Number							1
Number of Bursts in Trial							8
Chirp Center Frequency							5310
Burst	No. of Pulses	Pulse Width (us)	Chirp Width (MHz)	Pulse 1-to-2 Spacing (us)	Pulse 2-to-3 Spacing (us)	Starting Location Within Interval (ms)	
1	1	62.1	5	-	-	1091	
2	2	56	5	1729	-	133	
3	2	91.3	5	1230	-	1057	
4	3	50.7	5	1762	1616	1442	
5	2	92.6	5	1723	-	544	
6	2	87.3	5	1302	-	1089	
7	2	59.5	5	1291	-	1374	
8	2	52.2	5	1653	-	1237	
Detection Check (1=Detection; 0=No Detection)							1

Trial Number							2
Number of Bursts in Trial							9
Chirp Center Frequency							5310
Burst	No. of Pulses	Pulse Width (us)	Chirp Width (MHz)	Pulse 1-to-2 Spacing (us)	Pulse 2-to-3 Spacing (us)	Starting Location Within Interval (ms)	
1	3	90	20	1007	1326	30	
2	2	73.7	20	1785	-	979	
3	1	78.1	20	-	-	683	
4	2	92.4	20	1281	-	950	
5	1	61.2	20	-	-	612	
6	3	67.2	20	1525	1870	17	
7	1	78.5	20	-	-	429	
8	2	60.3	20	1931	-	936	
9	3	92.9	20	1403	1476	548	
Detection Check (1=Detection; 0=No Detection)							1



Trial Number							3
Number of Bursts in Trial							10
Chirp Center Frequency							5310
Burst	No. of Pulses	Pulse Width (us)	Chirp Width (MHz)	Pulse 1-to-2 Spacing (us)	Pulse 2-to-3 Spacing (us)	Starting Location Within Interval (ms)	
1	3	63.4	7	1574	1607	801	
2	1	98	7	-	-	966	
3	1	58.7	7	-	-	185	
4	1	88	7	-	-	1012	
5	3	79.5	7	1562	1370	943	
6	3	57.1	7	1900	1188	686	
7	2	64.4	7	1090	-	599	
8	1	78.7	7	-	-	1089	
9	1	69.3	7	-	-	188	
10	3	55.3	7	1375	1691	933	
Detection Check (1=Detection; 0=No Detection)							1

Trial Number							4
Number of Bursts in Trial							11
Chirp Center Frequency							5310
Burst	No. of Pulses	Pulse Width (us)	Chirp Width (MHz)	Pulse 1-to-2 Spacing (us)	Pulse 2-to-3 Spacing (us)	Starting Location Within Interval (ms)	
1	2	74.3	8	1642	-	24	
2	1	83.1	8	-	-	985	
3	2	59.5	8	1680	-	988	
4	2	59.8	8	1786	-	800	
5	2	77.6	8	1617	-	339	
6	2	79.9	8	1553	-	1040	
7	1	56	8	-	-	544	
8	3	71.4	8	1406	1927	452	
9	1	97.4	8	-	-	204	
10	2	98.3	8	1037	-	926	
11	1	63.6	8	-	-	1052	
Detection Check (1=Detection; 0=No Detection)							1



Trial Number							5
Number of Bursts in Trial							12
Chirp Center Frequency							5310
Burst	No. of Pulses	Pulse Width (us)	Chirp Width (MHz)	Pulse 1-to-2 Spacing (us)	Pulse 2-to-3 Spacing (us)	Starting Location Within Interval (ms)	
1	1	50	9	-	-	557	
2	2	62.5	9	1731	-	567	
3	2	55.4	9	1070	-	460	
4	1	65.7	9	-	-	4	
5	2	58	9	1512	-	64	
6	2	60.9	9	1230	-	650	
7	3	89.6	9	1598	1738	235	
8	3	84.4	9	1271	1617	873	
9	3	72.3	9	1498	1321	901	
10	1	58.9	9	-	-	663	
11	2	74.8	9	1584	-	919	
12	1	71.8	9	-	-	375	
Detection Check (1=Detection; 0=No Detection)							1

Trial Number							6
Number of Bursts in Trial							13
Chirp Center Frequency							5310
Burst	No. of Pulses	Pulse Width (us)	Chirp Width (MHz)	Pulse 1-to-2 Spacing (us)	Pulse 2-to-3 Spacing (us)	Starting Location Within Interval (ms)	
1	2	88.1	10	1257	-	846	
2	1	58.7	10	-	-	725	
3	2	97.1	10	1037	-	30	
4	3	83.1	10	1029	1106	490	
5	1	62.1	10	-	-	262	
6	2	71.4	10	1058	-	283	
7	2	86.3	10	1867	-	49	
8	3	77.3	10	1418	1876	634	
9	1	78.9	10	-	-	304	
10	3	79.2	10	1055	1572	564	
11	3	52	10	1582	1836	852	
12	3	56.5	10	1195	1542	525	
13	3	100	10	1638	1729	750	
Detection Check (1=Detection; 0=No Detection)							1



Trial Number							7
Number of Bursts in Trial							14
Chirp Center Frequency							5310
Burst	No. of Pulses	Pulse Width (us)	Chirp Width (MHz)	Pulse 1-to-2 Spacing (us)	Pulse 2-to-3 Spacing (us)	Starting Location Within Interval (ms)	
1	2	92.7	11	1208	-	231	
2	2	81.3	11	1144	-	804	
3	2	60.4	11	1555	-	34	
4	2	62.1	11	1320	-	427	
5	1	50	11	-	-	577	
6	3	65.9	11	1020	1365	3	
7	2	73.8	11	1308	-	51	
8	2	74.3	11	1143	-	360	
9	1	62.9	11	-	-	394	
10	2	74.8	11	1404	-	317	
11	2	69.7	11	1309	-	532	
12	2	69.8	11	1688	-	339	
13	2	77.4	11	1857	-	381	
14	1	55.1	11	-	-	426	
Detection Check (1=Detection; 0=No Detection)							1

Trial Number							8
Number of Bursts in Trial							15
Chirp Center Frequency							5310
Burst	No. of Pulses	Pulse Width (us)	Chirp Width (MHz)	Pulse 1-to-2 Spacing (us)	Pulse 2-to-3 Spacing (us)	Starting Location Within Interval (ms)	
1	1	91.7	12	-	-	776	
2	2	90	12	1196	-	187	
3	3	92.3	12	1486	1853	448	
4	2	66.8	12	1545	-	702	
5	1	64	12	-	-	403	
6	3	95.4	12	1123	1473	230	
7	3	66.8	12	1867	1401	604	
8	3	67.7	12	1472	1397	38	
9	1	68.2	12	-	-	735	
10	2	82.2	12	1297	-	610	
11	1	92.1	12	-	-	618	
12	2	57	12	1764	-	705	
13	2	58.5	12	1310	-	22	
14	3	85.5	12	1630	1447	641	
15	2	82.2	12	1371	-	109	
Detection Check (1=Detection; 0=No Detection)							0



Trial Number			9			
Number of Bursts in Trial			16			
Chirp Center Frequency			5310			
Burst	No. of Pulses	Pulse Width (us)	Chirp Width (MHz)	Pulse 1-to-2 Spacing (us)	Pulse 2-to-3 Spacing (us)	Starting Location Within Interval (ms)
1	2	74.4	13	1707	-	442
2	2	63.6	13	1725	-	280
3	2	71.3	13	1704	-	459
4	3	77.6	13	1063	1405	197
5	3	65.2	13	1731	1294	101
6	3	55.1	13	1109	1549	17
7	2	96.8	13	1034	-	131
8	3	80.8	13	1533	1051	365
9	1	60.4	13	-	-	222
10	2	61.8	13	1312	-	371
11	2	71.3	13	1657	-	33
12	2	98.1	13	1024	-	291
13	1	57.9	13	-	-	188
14	1	91.8	13	-	-	163
15	2	56.7	13	1259	-	426
16	2	89.7	13	1690	-	606
Detection Check (1=Detection; 0=No Detection)						1



Trial Number			10			
Number of Bursts in Trial			17			
Chirp Center Frequency			5310			
Burst	No. of Pulses	Pulse Width (us)	Chirp Width (MHz)	Pulse 1-to-2 Spacing (us)	Pulse 2-to-3 Spacing (us)	Starting Location Within Interval (ms)
1	2	74.4	14	1107	-	462
2	1	87.6	14	-	-	653
3	2	61.7	14	1741	-	457
4	2	57.5	14	1566	-	388
5	2	66.1	14	1855	-	63
6	3	70.1	14	1044	1012	136
7	1	66.4	14	-	-	343
8	1	59.2	14	-	-	349
9	2	88.3	14	1240	-	362
10	1	64.7	14	-	-	221
11	2	73	14	1703	-	144
12	2	81.7	14	1450	-	671
13	3	70.1	14	1741	1278	320
14	1	63.6	14	-	-	196
15	1	58.7	14	-	-	413
16	2	65.9	14	1478	-	170
17	1	72.7	14	-	-	564
Detection Check (1=Detection; 0=No Detection)						1



Trial Number			11			
Number of Bursts in Trial			18			
Chirp Center Frequency			5297			
Burst	No. of Pulses	Pulse Width (us)	Chirp Width (MHz)	Pulse 1-to-2 Spacing (us)	Pulse 2-to-3 Spacing (us)	Starting Location Within Interval (ms)
1	2	72.1	15	1193	-	130
2	3	76.3	15	1484	1390	114
3	1	86.1	15	-	-	14
4	1	73.2	15	-	-	604
5	1	81.2	15	-	-	548
6	2	99.5	15	1398	-	173
7	1	93.9	15	-	-	262
8	2	75.9	15	1921	-	38
9	3	79.2	15	1100	1429	84
10	3	77	15	1166	1799	610
11	1	91.8	15	-	-	339
12	3	56.8	15	1330	1556	580
13	2	83.1	15	1556	-	295
14	2	63	15	1552	-	156
15	1	65.7	15	-	-	439
16	1	64.5	15	-	-	188
17	1	88.5	15	-	-	419
18	1	60.6	15	-	-	205
Detection Check (1=Detection; 0=No Detection)						1



Trial Number			12			
Number of Bursts in Trial			19			
Chirp Center Frequency			5297			
Burst	No. of Pulses	Pulse Width (us)	Chirp Width (MHz)	Pulse 1-to-2 Spacing (us)	Pulse 2-to-3 Spacing (us)	Starting Location Within Interval (ms)
1	2	90.5	16	1299	-	381
2	2	88.4	16	1418	-	327
3	2	53.7	16	1055	-	536
4	1	80.5	16	-	-	285
5	1	50.4	16	-	-	398
6	2	61.2	16	1749	-	439
7	2	78.8	16	1065	-	129
8	3	75	16	1748	1820	325
9	2	96.7	16	1254	-	440
10	3	76.3	16	1848	1106	397
11	1	73.3	16	-	-	232
12	2	92.4	16	1317	-	91
13	2	92.4	16	1854	-	256
14	3	64.4	16	1240	1634	582
15	2	67.3	16	1473	-	117
16	2	84.1	16	1795	-	202
17	1	80.9	16	-	-	135
18	1	74.6	16	-	-	396
19	2	97.6	16	1805	-	615
Detection Check (1=Detection; 0=No Detection)						1



Trial Number							13
Number of Bursts in Trial							20
Chirp Center Frequency							5298
Burst	No. of Pulses	Pulse Width (us)	Chirp Width (MHz)	Pulse 1-to-2 Spacing (us)	Pulse 2-to-3 Spacing (us)	Starting Location Within Interval (ms)	
1	2	66.1	17	1417	-	388	
2	2	86.7	17	1693	-	348	
3	2	70.5	17	1263	-	215	
4	2	78	17	1446	-	28	
5	2	66	17	1185	-	585	
6	2	80.6	17	1855	-	65	
7	1	95.5	17	-	-	92	
8	1	98.8	17	-	-	68	
9	3	64.3	17	1641	1108	517	
10	1	75.1	17	-	-	121	
11	2	72.6	17	1499	-	448	
12	1	60.3	17	-	-	567	
13	2	54.9	17	1056	-	245	
14	2	98.8	17	1023	-	584	
15	2	60.9	17	1243	-	579	
16	2	62.7	17	1226	-	464	
17	1	80.1	17	-	-	89	
18	2	70.9	17	1711	-	153	
19	1	90.7	17	-	-	282	
20	1	98.9	17	-	-	71	
Detection Check (1=Detection; 0=No Detection)							1

Trial Number							14
Number of Bursts in Trial							8
Chirp Center Frequency							5299
Burst	No. of Pulses	Pulse Width (us)	Chirp Width (MHz)	Pulse 1-to-2 Spacing (us)	Pulse 2-to-3 Spacing (us)	Starting Location Within Interval (ms)	
1	2	67.5	20	1542	-	947	
2	3	83.6	20	1272	1696	124	
3	2	93.2	20	1877	-	701	
4	1	55.6	20	-	-	1123	
5	3	84.2	20	1733	1619	756	
6	3	69.1	20	1612	1071	1	
7	2	66.9	20	1905	-	7	
8	3	86.8	20	1697	1621	1082	
Detection Check (1=Detection; 0=No Detection)							1



Trial Number							15
Number of Bursts in Trial							9
Chirp Center Frequency							5299
Burst	No. of Pulses	Pulse Width (us)	Chirp Width (MHz)	Pulse 1-to-2 Spacing (us)	Pulse 2-to-3 Spacing (us)	Starting Location Within Interval (ms)	
1	2	62.2	19	1571	-	949	
2	2	85	19	1669	-	189	
3	2	64.5	19	1505	-	176	
4	2	50.4	19	1325	-	538	
5	2	66.1	19	1483	-	908	
6	2	71.2	19	1110	-	1017	
7	3	53.7	19	1445	1677	492	
8	3	62.5	19	1596	1341	349	
9	3	62	19	1929	1221	1105	
Detection Check (1=Detection; 0=No Detection)							1

Trial Number							16
Number of Bursts in Trial							10
Chirp Center Frequency							5298
Burst	No. of Pulses	Pulse Width (us)	Chirp Width (MHz)	Pulse 1-to-2 Spacing (us)	Pulse 2-to-3 Spacing (us)	Starting Location Within Interval (ms)	
1	2	80.5	18	1910	-	284	
2	2	64.2	18	1661	-	751	
3	2	90.1	18	1041	-	491	
4	2	69.8	18	1495	-	107	
5	1	73.1	18	-	-	490	
6	3	77.2	18	1418	1145	1155	
7	3	52.6	18	1732	1787	772	
8	2	71.4	18	1562	-	121	
9	2	89.8	18	1491	-	89	
10	2	76.4	18	1355	-	615	
Detection Check (1=Detection; 0=No Detection)							1



Trial Number							17
Number of Bursts in Trial							11
Chirp Center Frequency							5298
Burst	No. of Pulses	Pulse Width (us)	Chirp Width (MHz)	Pulse 1-to-2 Spacing (us)	Pulse 2-to-3 Spacing (us)	Starting Location Within Interval (ms)	
1	2	51.2	17	1236	-	740	
2	1	71.7	17	-	-	941	
3	2	74.7	17	1164	-	370	
4	2	50.9	17	1919	-	371	
5	2	65.2	17	1206	-	1033	
6	2	98	17	1182	-	346	
7	2	58.7	17	1612	-	639	
8	1	63.8	17	-	-	1056	
9	3	86.3	17	1545	1065	205	
10	1	94.4	17	-	-	753	
11	3	88.5	17	1699	1319	58	
Detection Check (1=Detection; 0=No Detection)							0

Trial Number							18
Number of Bursts in Trial							12
Chirp Center Frequency							5297
Burst	No. of Pulses	Pulse Width (us)	Chirp Width (MHz)	Pulse 1-to-2 Spacing (us)	Pulse 2-to-3 Spacing (us)	Starting Location Within Interval (ms)	
1	2	88.7	16	1405	-	448	
2	3	90.2	16	1544	1235	621	
3	1	96.5	16	-	-	512	
4	2	80.5	16	1090	-	321	
5	2	63.7	16	1268	-	798	
6	1	53.4	16	-	-	809	
7	2	52.3	16	1043	-	301	
8	3	54.7	16	1701	1104	796	
9	3	75.6	16	1923	1729	669	
10	2	59.2	16	1244	-	369	
11	1	56.3	16	-	-	51	
12	2	87.8	16	1608	-	733	
Detection Check (1=Detection; 0=No Detection)							1



Trial Number							19
Number of Bursts in Trial							13
Chirp Center Frequency							5297
Burst	No. of Pulses	Pulse Width (us)	Chirp Width (MHz)	Pulse 1-to-2 Spacing (us)	Pulse 2-to-3 Spacing (us)	Starting Location Within Interval (ms)	
1	2	68.2	15	1104	-	229	
2	2	58.4	15	1627	-	488	
3	3	74.7	15	1861	1015	137	
4	2	58.2	15	1593	-	520	
5	1	51.6	15	-	-	799	
6	2	94.7	15	1469	-	43	
7	2	70.7	15	1091	-	126	
8	2	82.9	15	1472	-	607	
9	3	62.7	15	1168	1453	527	
10	2	63.1	15	1529	-	143	
11	1	96.1	15	-	-	176	
12	2	57	15	1457	-	882	
13	3	95.6	15	1707	1501	214	
Detection Check (1=Detection; 0=No Detection)							1

Trial Number							20
Number of Bursts in Trial							14
Chirp Center Frequency							5297
Burst	No. of Pulses	Pulse Width (us)	Chirp Width (MHz)	Pulse 1-to-2 Spacing (us)	Pulse 2-to-3 Spacing (us)	Starting Location Within Interval (ms)	
1	1	95.7	14	-	-	117	
2	1	93.1	14	-	-	720	
3	1	55.8	14	-	-	297	
4	1	76.7	14	-	-	284	
5	2	68	14	1686	-	472	
6	3	94.1	14	1796	1393	264	
7	2	53.9	14	1293	-	525	
8	1	99.3	14	-	-	155	
9	2	73.3	14	1458	-	65	
10	2	93.3	14	1196	-	451	
11	3	55.8	14	1895	1034	243	
12	1	66.4	14	-	-	228	
13	2	65.6	14	1732	-	746	
14	2	76.5	14	1187	-	522	
Detection Check (1=Detection; 0=No Detection)							1



Trial Number							21
Number of Bursts in Trial							15
Chirp Center Frequency							5324
Burst	No. of Pulses	Pulse Width (us)	Chirp Width (MHz)	Pulse 1-to-2 Spacing (us)	Pulse 2-to-3 Spacing (us)	Starting Location Within Interval (ms)	
1	1	85.1	13	-	-	565	
2	2	72.5	13	1648	-	211	
3	1	67.5	13	-	-	348	
4	2	56.1	13	1360	-	156	
5	1	71.1	13	-	-	718	
6	2	93.1	13	1391	-	400	
7	1	56.5	13	-	-	482	
8	1	63.8	13	-	-	703	
9	2	67.4	13	1727	-	780	
10	1	52.3	13	-	-	102	
11	3	62.4	13	1228	1715	304	
12	2	53.3	13	1630	-	57	
13	2	83.1	13	1205	-	768	
14	2	93.7	13	1085	-	461	
15	2	90.7	13	1297	-	746	
Detection Check (1=Detection; 0=No Detection)							1

Trial Number							22
Number of Bursts in Trial							16
Chirp Center Frequency							5324
Burst	No. of Pulses	Pulse Width (us)	Chirp Width (MHz)	Pulse 1-to-2 Spacing (us)	Pulse 2-to-3 Spacing (us)	Starting Location Within Interval (ms)	
1	2	98.8	12	1439	-	95	
2	1	54.5	12	-	-	676	
3	2	80.5	12	1360	-	8	
4	2	55.9	12	1906	-	373	
5	2	72.1	12	1623	-	254	
6	2	84.4	12	1604	-	480	
7	1	78.5	12	-	-	663	
8	1	88	12	-	-	314	
9	2	74.7	12	1157	-	596	
10	2	97.1	12	1673	-	264	
11	1	81.6	12	-	-	740	
12	1	83.6	12	-	-	163	
13	3	87.6	12	1757	1322	628	
14	2	58.5	12	1372	-	132	
15	3	91.8	12	1767	1183	106	
16	2	58.8	12	1432	-	659	
Detection Check (1=Detection; 0=No Detection)							1



Trial Number			23			
Number of Bursts in Trial			17			
Chirp Center Frequency			5325			
Burst	No. of Pulses	Pulse Width (us)	Chirp Width (MHz)	Pulse 1-to-2 Spacing (us)	Pulse 2-to-3 Spacing (us)	Starting Location Within Interval (ms)
1	1	96	11	-	-	284
2	2	92.5	11	1241	-	488
3	2	89.5	11	1347	-	76
4	2	74.8	11	1607	-	688
5	2	60.6	11	1523	-	28
6	2	71.5	11	1659	-	383
7	2	71.1	11	1454	-	182
8	1	98.7	11	-	-	20
9	2	85.1	11	1770	-	576
10	2	89.2	11	1086	-	410
11	2	60.7	11	1101	-	458
12	2	75.2	11	1719	-	348
13	2	75.7	11	1799	-	481
14	3	56.7	11	1132	1884	587
15	2	65	11	1885	-	480
16	2	64.6	11	1910	-	195
17	3	69.9	11	1410	1190	396
Detection Check (1=Detection; 0=No Detection)						1



Trial Number			24			
Number of Bursts in Trial			18			
Chirp Center Frequency			5325			
Burst	No. of Pulses	Pulse Width (us)	Chirp Width (MHz)	Pulse 1-to-2 Spacing (us)	Pulse 2-to-3 Spacing (us)	Starting Location Within Interval (ms)
1	3	83.8	10	1290	1021	536
2	2	66.9	10	1112	-	44
3	3	91	10	1220	1504	611
4	2	86.1	10	1678	-	456
5	3	65.5	10	1928	1222	330
6	1	62.6	10	-	-	297
7	3	68.7	10	1505	1200	351
8	3	59.2	10	1452	1114	230
9	1	73.9	10	-	-	222
10	1	77.2	10	-	-	57
11	2	96.4	10	1357	-	399
12	2	99.9	10	1173	-	299
13	2	99.9	10	1520	-	464
14	1	86.7	10	-	-	294
15	1	92.6	10	-	-	653
16	1	77.1	10	-	-	550
17	2	81.1	10	1664	-	566
18	3	68.4	10	1536	1309	580
Detection Check (1=Detection; 0=No Detection)						1



Trial Number			25			
Number of Bursts in Trial			19			
Chirp Center Frequency			5325			
Burst	No. of Pulses	Pulse Width (us)	Chirp Width (MHz)	Pulse 1-to-2 Spacing (us)	Pulse 2-to-3 Spacing (us)	Starting Location Within Interval (ms)
1	3	68.2	9	1723	1868	471
2	3	83.7	9	1711	1405	368
3	2	69.7	9	1781	-	425
4	1	59.7	9	-	-	440
5	2	96.7	9	1484	-	123
6	2	95.8	9	1319	-	261
7	3	71.3	9	1095	1354	332
8	3	53.2	9	1527	1427	427
9	2	69.5	9	1771	-	397
10	3	63.9	9	1075	1447	67
11	2	93.4	9	1783	-	174
12	2	77.3	9	1564	-	17
13	2	73.1	9	1294	-	216
14	1	77.4	9	-	-	292
15	3	57.2	9	1722	1886	619
16	2	68.7	9	1629	-	233
17	1	60.8	9	-	-	226
18	3	69.7	9	1128	1224	599
19	1	62.2	9	-	-	433
Detection Check (1=Detection; 0=No Detection)						1



Trial Number							26
Number of Bursts in Trial							20
Chirp Center Frequency							5326
Burst	No. of Pulses	Pulse Width (us)	Chirp Width (MHz)	Pulse 1-to-2 Spacing (us)	Pulse 2-to-3 Spacing (us)	Starting Location Within Interval (ms)	
1	1	80.5	8	-	-	90	
2	3	62.6	8	1406	1343	319	
3	3	85.6	8	1190	1529	384	
4	2	83.9	8	1208	-	567	
5	2	92.4	8	1488	-	234	
6	2	54	8	1529	-	535	
7	3	81.3	8	1501	1812	325	
8	1	98.5	8	-	-	532	
9	1	85.8	8	-	-	272	
10	2	84.7	8	1593	-	182	
11	2	83.3	8	1705	-	134	
12	2	79.8	8	1567	-	286	
13	1	77.9	8	-	-	368	
14	3	98.4	8	1510	1569	290	
15	2	79.9	8	1588	-	231	
16	3	78	8	1140	1353	353	
17	3	55.2	8	1700	1327	53	
18	3	71.9	8	1081	1224	44	
19	1	62	8	-	-	298	
20	3	70.5	8	1888	1442	529	
Detection Check (1=Detection; 0=No Detection)							1

Trial Number							27
Number of Bursts in Trial							8
Chirp Center Frequency							5322
Burst	No. of Pulses	Pulse Width (us)	Chirp Width (MHz)	Pulse 1-to-2 Spacing (us)	Pulse 2-to-3 Spacing (us)	Starting Location Within Interval (ms)	
1	2	69.1	18	1076	-	1436	
2	2	62.1	18	1688	-	22	
3	2	94.8	18	1891	-	897	
4	1	75.8	18	-	-	1186	
5	2	65.4	18	1713	-	589	
6	2	97.7	18	1292	-	614	
7	3	98.1	18	1670	1711	506	
8	2	85.4	18	1672	-	776	
Detection Check (1=Detection; 0=No Detection)							0



Trial Number							28
Number of Bursts in Trial							9
Chirp Center Frequency							5321
Burst	No. of Pulses	Pulse Width (us)	Chirp Width (MHz)	Pulse 1-to-2 Spacing (us)	Pulse 2-to-3 Spacing (us)	Starting Location Within Interval (ms)	
1	3	82	19	1233	1713	679	
2	3	87.7	19	1554	1123	473	
3	2	98.9	19	1518	-	869	
4	1	55	19	-	-	719	
5	1	93.6	19	-	-	902	
6	2	58.7	19	1641	-	1243	
7	2	88.7	19	1387	-	410	
8	1	60.3	19	-	-	1154	
9	1	97.7	19	-	-	512	
Detection Check (1=Detection; 0=No Detection)							1

Trial Number							29
Number of Bursts in Trial							10
Chirp Center Frequency							5321
Burst	No. of Pulses	Pulse Width (us)	Chirp Width (MHz)	Pulse 1-to-2 Spacing (us)	Pulse 2-to-3 Spacing (us)	Starting Location Within Interval (ms)	
1	1	69.6	20	-	-	1131	
2	1	74.5	20	-	-	290	
3	1	60.9	20	-	-	895	
4	1	74.6	20	-	-	202	
5	2	99.3	20	1501	-	139	
6	2	95.3	20	1065	-	854	
7	2	91.9	20	1722	-	219	
8	2	51	20	1285	-	57	
9	2	87.7	20	1747	-	141	
10	1	87.2	20	-	-	596	
Detection Check (1=Detection; 0=No Detection)							1



Trial Number		30				
Number of Bursts in Trial		11				
Chirp Center Frequency		5327				
Burst	No. of Pulses	Pulse Width (us)	Chirp Width (MHz)	Pulse 1-to-2 Spacing (us)	Pulse 2-to-3 Spacing (us)	Starting Location Within Interval (ms)
1	3	59.9	5	1901	1196	935
2	2	77.1	5	1590	-	1038
3	2	62.7	5	1227	-	690
4	1	77.1	5	-	-	547
5	3	99.8	5	1798	1790	551
6	2	61.5	5	1135	-	876
7	2	77.5	5	1583	-	448
8	2	57.3	5	1890	-	736
9	2	53.5	5	1757	-	362
10	1	66.6	5	-	-	836
11	3	80.7	5	1811	1289	410
Detection Check (1=Detection; 0=No Detection)						1



Type 6 Radar Statistical Performance

Trial #	Test Freq. (MHz)	Pulses / Hop	Pulse Width (us)	PRI (us)	1=Detection 0=No Detection
1	5310	9	1	333	1
2	5310	9	1	333	1
3	5310	9	1	333	1
4	5310	9	1	333	1
5	5310	9	1	333	1
6	5310	9	1	333	1
7	5310	9	1	333	1
8	5310	9	1	333	1
9	5310	9	1	333	1
10	5310	9	1	333	1
11	5310	9	1	333	1
12	5310	9	1	333	1
13	5310	9	1	333	1
14	5310	9	1	333	1
15	5310	9	1	333	1
16	5310	9	1	333	1
17	5310	9	1	333	1
18	5310	9	1	333	1
19	5310	9	1	333	1
20	5310	9	1	333	1
21	5310	9	1	333	1
22	5310	9	1	333	1
23	5310	9	1	333	1
24	5310	9	1	333	1
25	5310	9	1	333	1
26	5310	9	1	333	1
27	5310	9	1	333	1
28	5310	9	1	333	0
29	5310	9	1	333	1
30	5310	9	1	333	1
Detection Percentage (%)					96.667
Limit					70%
Test Result					Complied



Modulation Mode: 802.11ac (VHT80)

Type 1 Radar Statistical Performance

Trial #	Test Freq. (MHz)	Pulse Repetition Frequency Number	Pulse Repetition Frequency (Pulse Per Second)	PRI (us)	1=Detection 0=No Detection
1	5281	1	1930.5	518	1
2	5279	23	326.2	3066	1
3	5305	19	1139.0	878	1
4	5325	12	1355.0	738	1
5	5255	4	1730.1	578	1
6	5276	8	1519.8	658	1
7	5326	15	1253.1	798	1
8	5319	6	1618.1	618	1
9	5270	14	1285.3	778	1
10	5291	3	1792.1	558	1
11	5260	13	1319.3	758	1
12	5269	9	1474.9	678	1
13	5306	7	1567.4	638	1
14	5277	17	1193.3	838	1
15	5255	10	1432.7	698	1
16	5280	-	1692.0	591	0
17	5301	-	328.1	3048	1
18	5257	-	373.4	2678	1
19	5268	-	574.4	1741	1
20	5280	-	1216.5	822	1
21	5317	-	801.3	1248	1
22	5273	-	488.5	2047	1
23	5274	-	956.0	1046	1
24	5313	-	517.6	1932	1
25	5290	-	1422.5	703	1
26	5300	-	542.0	1845	1
27	5255	-	741.3	1349	1
28	5274	-	881.8	1134	1
29	5311	-	427.4	2340	1
30	5307	-	628.9	1590	1
Detection Percentage (%)					96.667
Limit					60%
Test Result					Complied



Type 2 Radar Statistical Performance

Trial #	Test Freq. (MHz)	Pulse Width (us)	PRI (us)	Pulses / Burst	1=Detection 0=No Detection
1	5257	2.6	221	23	1
2	5281	4.6	198	27	1
3	5259	1.1	184	29	1
4	5284	4.8	203	24	1
5	5304	2.4	162	25	1
6	5278	3.4	204	28	1
7	5260	2.3	170	27	1
8	5328	3.5	184	23	1
9	5273	4.9	150	27	1
10	5276	4.6	211	29	0
11	5253	2.9	158	23	1
12	5281	2.6	226	27	1
13	5261	1.6	204	26	1
14	5295	3.9	181	25	1
15	5275	4.6	202	24	1
16	5257	4.1	194	27	1
17	5300	2.3	193	28	0
18	5272	3.9	173	29	1
19	5293	4.3	188	23	1
20	5300	1.5	215	26	1
21	5324	4.9	227	27	1
22	5279	1.1	199	23	0
23	5299	4.5	155	29	1
24	5262	4.0	190	27	1
25	5323	2.4	151	23	0
26	5278	2.5	180	28	1
27	5296	2.5	228	23	1
28	5301	2.5	203	25	1
29	5293	1.5	188	25	1
30	5318	1.9	217	24	1
Detection Percentage (%)					86.667
Limit					60%
Test Result					Complied



Type 3 Radar Statistical Performance

Trial #	Test Freq. (MHz)	Pulse Width (us)	PRI (us)	Pulses / Burst	1=Detection 0=No Detection
1	5302	8.0	205	16	1
2	5267	6.7	382	18	1
3	5262	8.6	418	16	1
4	5320	9.4	351	17	1
5	5260	7.4	383	18	1
6	5291	9.8	232	16	1
7	5293	9.1	377	17	1
8	5267	9.6	457	16	1
9	5293	8.0	471	18	1
10	5273	9.0	304	18	1
11	5312	8.0	316	17	0
12	5297	9.8	325	16	1
13	5286	8.0	409	17	1
14	5316	9.9	200	17	1
15	5320	8.8	458	16	1
16	5287	8.0	232	18	0
17	5294	8.3	250	16	1
18	5310	8.7	270	16	1
19	5283	7.7	350	17	1
20	5252	7.1	230	16	1
21	5326	7.3	416	18	1
22	5311	7.6	498	18	1
23	5255	7.3	286	17	1
24	5256	7.3	287	16	0
25	5261	7.5	462	17	1
26	5293	6.2	300	17	1
27	5316	6.4	323	18	1
28	5327	7.1	420	16	1
29	5309	7.2	395	18	1
30	5298	8.4	377	16	1
Detection Percentage (%)					90.000
Limit					60%
Test Result					Complied



Type 4 Radar Statistical Performance

Trial #	Test Freq. (MHz)	Pulse Width (us)	PRI (us)	Pulses / Burst	1=Detection 0=No Detection
1	5292	18.0	242	15	1
2	5281	19.9	279	12	1
3	5253	12.9	487	14	1
4	5317	15.0	452	13	1
5	5282	16.3	230	12	1
6	5314	19.8	238	13	1
7	5269	18.2	420	16	1
8	5309	16.3	452	15	1
9	5261	14.2	495	12	0
10	5276	17.8	228	16	1
11	5324	19.1	211	16	1
12	5265	18.4	283	15	1
13	5291	11.8	411	12	1
14	5308	14.2	284	13	0
15	5292	13.9	202	12	1
16	5316	17.8	340	14	1
17	5310	15.6	290	16	1
18	5278	14.6	250	16	1
19	5311	14.4	484	15	1
20	5257	18.9	387	13	1
21	5316	11.1	348	15	0
22	5263	13.8	291	16	1
23	5263	14.3	295	12	1
24	5258	12.5	300	12	1
25	5277	12.5	322	14	1
26	5323	12.5	383	13	1
27	5262	15.7	322	16	1
28	5287	19.8	469	13	1
29	5264	18.6	406	15	1
30	5304	15.9	238	14	1
Detection Percentage (%)					90.000
Limit					60%
Test Result					Complied



Total Type 1~4 Radar Statistical Performance

Radar Type #	Detection Percentage (%)
1	96.667
2	86.667
3	90.000
4	90.000
Aggregate (Radar Types 1-4)	90.833
Limit	80%
Test Result	Complied



Type 5 Radar Statistical Performance

Center Freq. (MHz)	Low Edge (MHz)	High Edge (MHz)	VSG Freq. (MHz)	Detection
Trial	Chirp	Offset		
1	5	2	5290	1
2	20	8	5290	1
3	7	2.8	5290	1
4	8	3.2	5290	1
5	9	3.6	5290	1
6	10	4	5290	1
7	11	4.4	5290	1
8	12	4.8	5290	1
9	13	5.2	5290	1
10	14	5.6	5290	1
11	15	6	5297	1
12	16	6.4	5297	1
13	17	6.8	5298	1
14	20	8	5299	1
15	19	7.6	5299	0
16	18	7.2	5298	1
17	17	6.8	5298	0
18	16	6.4	5297	1
19	15	6	5297	1
20	14	5.6	5297	1
21	13	5.2	5324	1
22	12	4.8	5324	1
23	11	4.4	5325	1
24	10	4	5325	1
25	9	3.6	5325	1
26	8	3.2	5326	1
27	18	7.2	5322	1
28	19	7.6	5321	0
29	20	8	5321	1
30	5	2	5327	1
Total				27
Detection Percentage (%)				90%
Limit				80%
Test Result				Complied



Trial Number							1
Number of Bursts in Trial							8
Chirp Center Frequency							5290
Burst	No. of Pulses	Pulse Width (us)	Chirp Width (MHz)	Pulse 1-to-2 Spacing (us)	Pulse 2-to-3 Spacing (us)	Starting Location Within Interval (ms)	
1	1	62.1	5	-	-	1091	
2	2	56	5	1729	-	133	
3	2	91.3	5	1230	-	1057	
4	3	50.7	5	1762	1616	1442	
5	2	92.6	5	1723	-	544	
6	2	87.3	5	1302	-	1089	
7	2	59.5	5	1291	-	1374	
8	2	52.2	5	1653	-	1237	
Detection Check (1=Detection; 0=No Detection)							1

Trial Number							2
Number of Bursts in Trial							9
Chirp Center Frequency							5290
Burst	No. of Pulses	Pulse Width (us)	Chirp Width (MHz)	Pulse 1-to-2 Spacing (us)	Pulse 2-to-3 Spacing (us)	Starting Location Within Interval (ms)	
1	3	90	20	1007	1326	30	
2	2	73.7	20	1785	-	979	
3	1	78.1	20	-	-	683	
4	2	92.4	20	1281	-	950	
5	1	61.2	20	-	-	612	
6	3	67.2	20	1525	1870	17	
7	1	78.5	20	-	-	429	
8	2	60.3	20	1931	-	936	
9	3	92.9	20	1403	1476	548	
Detection Check (1=Detection; 0=No Detection)							1



Trial Number							3
Number of Bursts in Trial							10
Chirp Center Frequency							5290
Burst	No. of Pulses	Pulse Width (us)	Chirp Width (MHz)	Pulse 1-to-2 Spacing (us)	Pulse 2-to-3 Spacing (us)	Starting Location Within Interval (ms)	
1	3	63.4	7	1574	1607	801	
2	1	98	7	-	-	966	
3	1	58.7	7	-	-	185	
4	1	88	7	-	-	1012	
5	3	79.5	7	1562	1370	943	
6	3	57.1	7	1900	1188	686	
7	2	64.4	7	1090	-	599	
8	1	78.7	7	-	-	1089	
9	1	69.3	7	-	-	188	
10	3	55.3	7	1375	1691	933	
Detection Check (1=Detection; 0=No Detection)							1

Trial Number							4
Number of Bursts in Trial							11
Chirp Center Frequency							5290
Burst	No. of Pulses	Pulse Width (us)	Chirp Width (MHz)	Pulse 1-to-2 Spacing (us)	Pulse 2-to-3 Spacing (us)	Starting Location Within Interval (ms)	
1	2	74.3	8	1642	-	24	
2	1	83.1	8	-	-	985	
3	2	59.5	8	1680	-	988	
4	2	59.8	8	1786	-	800	
5	2	77.6	8	1617	-	339	
6	2	79.9	8	1553	-	1040	
7	1	56	8	-	-	544	
8	3	71.4	8	1406	1927	452	
9	1	97.4	8	-	-	204	
10	2	98.3	8	1037	-	926	
11	1	63.6	8	-	-	1052	
Detection Check (1=Detection; 0=No Detection)							1



Trial Number							5
Number of Bursts in Trial							12
Chirp Center Frequency							5290
Burst	No. of Pulses	Pulse Width (us)	Chirp Width (MHz)	Pulse 1-to-2 Spacing (us)	Pulse 2-to-3 Spacing (us)	Starting Location Within Interval (ms)	
1	1	50	9	-	-	557	
2	2	62.5	9	1731	-	567	
3	2	55.4	9	1070	-	460	
4	1	65.7	9	-	-	4	
5	2	58	9	1512	-	64	
6	2	60.9	9	1230	-	650	
7	3	89.6	9	1598	1738	235	
8	3	84.4	9	1271	1617	873	
9	3	72.3	9	1498	1321	901	
10	1	58.9	9	-	-	663	
11	2	74.8	9	1584	-	919	
12	1	71.8	9	-	-	375	
Detection Check (1=Detection; 0=No Detection)							1

Trial Number							6
Number of Bursts in Trial							13
Chirp Center Frequency							5290
Burst	No. of Pulses	Pulse Width (us)	Chirp Width (MHz)	Pulse 1-to-2 Spacing (us)	Pulse 2-to-3 Spacing (us)	Starting Location Within Interval (ms)	
1	2	88.1	10	1257	-	846	
2	1	58.7	10	-	-	725	
3	2	97.1	10	1037	-	30	
4	3	83.1	10	1029	1106	490	
5	1	62.1	10	-	-	262	
6	2	71.4	10	1058	-	283	
7	2	86.3	10	1867	-	49	
8	3	77.3	10	1418	1876	634	
9	1	78.9	10	-	-	304	
10	3	79.2	10	1055	1572	564	
11	3	52	10	1582	1836	852	
12	3	56.5	10	1195	1542	525	
13	3	100	10	1638	1729	750	
Detection Check (1=Detection; 0=No Detection)							1



Trial Number							7
Number of Bursts in Trial							14
Chirp Center Frequency							5290
Burst	No. of Pulses	Pulse Width (us)	Chirp Width (MHz)	Pulse 1-to-2 Spacing (us)	Pulse 2-to-3 Spacing (us)	Starting Location Within Interval (ms)	
1	2	92.7	11	1208	-	231	
2	2	81.3	11	1144	-	804	
3	2	60.4	11	1555	-	34	
4	2	62.1	11	1320	-	427	
5	1	50	11	-	-	577	
6	3	65.9	11	1020	1365	3	
7	2	73.8	11	1308	-	51	
8	2	74.3	11	1143	-	360	
9	1	62.9	11	-	-	394	
10	2	74.8	11	1404	-	317	
11	2	69.7	11	1309	-	532	
12	2	69.8	11	1688	-	339	
13	2	77.4	11	1857	-	381	
14	1	55.1	11	-	-	426	
Detection Check (1=Detection; 0=No Detection)							1

Trial Number							8
Number of Bursts in Trial							15
Chirp Center Frequency							5290
Burst	No. of Pulses	Pulse Width (us)	Chirp Width (MHz)	Pulse 1-to-2 Spacing (us)	Pulse 2-to-3 Spacing (us)	Starting Location Within Interval (ms)	
1	1	91.7	12	-	-	776	
2	2	90	12	1196	-	187	
3	3	92.3	12	1486	1853	448	
4	2	66.8	12	1545	-	702	
5	1	64	12	-	-	403	
6	3	95.4	12	1123	1473	230	
7	3	66.8	12	1867	1401	604	
8	3	67.7	12	1472	1397	38	
9	1	68.2	12	-	-	735	
10	2	82.2	12	1297	-	610	
11	1	92.1	12	-	-	618	
12	2	57	12	1764	-	705	
13	2	58.5	12	1310	-	22	
14	3	85.5	12	1630	1447	641	
15	2	82.2	12	1371	-	109	
Detection Check (1=Detection; 0=No Detection)							1



Trial Number			9			
Number of Bursts in Trial			16			
Chirp Center Frequency			5290			
Burst	No. of Pulses	Pulse Width (us)	Chirp Width (MHz)	Pulse 1-to-2 Spacing (us)	Pulse 2-to-3 Spacing (us)	Starting Location Within Interval (ms)
1	2	74.4	13	1707	-	442
2	2	63.6	13	1725	-	280
3	2	71.3	13	1704	-	459
4	3	77.6	13	1063	1405	197
5	3	65.2	13	1731	1294	101
6	3	55.1	13	1109	1549	17
7	2	96.8	13	1034	-	131
8	3	80.8	13	1533	1051	365
9	1	60.4	13	-	-	222
10	2	61.8	13	1312	-	371
11	2	71.3	13	1657	-	33
12	2	98.1	13	1024	-	291
13	1	57.9	13	-	-	188
14	1	91.8	13	-	-	163
15	2	56.7	13	1259	-	426
16	2	89.7	13	1690	-	606
Detection Check (1=Detection; 0=No Detection)						1



Trial Number			10			
Number of Bursts in Trial			17			
Chirp Center Frequency			5290			
Burst	No. of Pulses	Pulse Width (us)	Chirp Width (MHz)	Pulse 1-to-2 Spacing (us)	Pulse 2-to-3 Spacing (us)	Starting Location Within Interval (ms)
1	2	74.4	14	1107	-	462
2	1	87.6	14	-	-	653
3	2	61.7	14	1741	-	457
4	2	57.5	14	1566	-	388
5	2	66.1	14	1855	-	63
6	3	70.1	14	1044	1012	136
7	1	66.4	14	-	-	343
8	1	59.2	14	-	-	349
9	2	88.3	14	1240	-	362
10	1	64.7	14	-	-	221
11	2	73	14	1703	-	144
12	2	81.7	14	1450	-	671
13	3	70.1	14	1741	1278	320
14	1	63.6	14	-	-	196
15	1	58.7	14	-	-	413
16	2	65.9	14	1478	-	170
17	1	72.7	14	-	-	564
Detection Check (1=Detection; 0=No Detection)						1



Trial Number			11			
Number of Bursts in Trial			18			
Chirp Center Frequency			5297			
Burst	No. of Pulses	Pulse Width (us)	Chirp Width (MHz)	Pulse 1-to-2 Spacing (us)	Pulse 2-to-3 Spacing (us)	Starting Location Within Interval (ms)
1	2	72.1	15	1193	-	130
2	3	76.3	15	1484	1390	114
3	1	86.1	15	-	-	14
4	1	73.2	15	-	-	604
5	1	81.2	15	-	-	548
6	2	99.5	15	1398	-	173
7	1	93.9	15	-	-	262
8	2	75.9	15	1921	-	38
9	3	79.2	15	1100	1429	84
10	3	77	15	1166	1799	610
11	1	91.8	15	-	-	339
12	3	56.8	15	1330	1556	580
13	2	83.1	15	1556	-	295
14	2	63	15	1552	-	156
15	1	65.7	15	-	-	439
16	1	64.5	15	-	-	188
17	1	88.5	15	-	-	419
18	1	60.6	15	-	-	205
Detection Check (1=Detection; 0=No Detection)						1



Trial Number			12			
Number of Bursts in Trial			19			
Chirp Center Frequency			5297			
Burst	No. of Pulses	Pulse Width (us)	Chirp Width (MHz)	Pulse 1-to-2 Spacing (us)	Pulse 2-to-3 Spacing (us)	Starting Location Within Interval (ms)
1	2	90.5	16	1299	-	381
2	2	88.4	16	1418	-	327
3	2	53.7	16	1055	-	536
4	1	80.5	16	-	-	285
5	1	50.4	16	-	-	398
6	2	61.2	16	1749	-	439
7	2	78.8	16	1065	-	129
8	3	75	16	1748	1820	325
9	2	96.7	16	1254	-	440
10	3	76.3	16	1848	1106	397
11	1	73.3	16	-	-	232
12	2	92.4	16	1317	-	91
13	2	92.4	16	1854	-	256
14	3	64.4	16	1240	1634	582
15	2	67.3	16	1473	-	117
16	2	84.1	16	1795	-	202
17	1	80.9	16	-	-	135
18	1	74.6	16	-	-	396
19	2	97.6	16	1805	-	615
Detection Check (1=Detection; 0=No Detection)						1



Trial Number							13
Number of Bursts in Trial							20
Chirp Center Frequency							5298
Burst	No. of Pulses	Pulse Width (us)	Chirp Width (MHz)	Pulse 1-to-2 Spacing (us)	Pulse 2-to-3 Spacing (us)	Starting Location Within Interval (ms)	
1	2	66.1	17	1417	-	388	
2	2	86.7	17	1693	-	348	
3	2	70.5	17	1263	-	215	
4	2	78	17	1446	-	28	
5	2	66	17	1185	-	585	
6	2	80.6	17	1855	-	65	
7	1	95.5	17	-	-	92	
8	1	98.8	17	-	-	68	
9	3	64.3	17	1641	1108	517	
10	1	75.1	17	-	-	121	
11	2	72.6	17	1499	-	448	
12	1	60.3	17	-	-	567	
13	2	54.9	17	1056	-	245	
14	2	98.8	17	1023	-	584	
15	2	60.9	17	1243	-	579	
16	2	62.7	17	1226	-	464	
17	1	80.1	17	-	-	89	
18	2	70.9	17	1711	-	153	
19	1	90.7	17	-	-	282	
20	1	98.9	17	-	-	71	
Detection Check (1=Detection; 0=No Detection)							1

Trial Number							14
Number of Bursts in Trial							8
Chirp Center Frequency							5299
Burst	No. of Pulses	Pulse Width (us)	Chirp Width (MHz)	Pulse 1-to-2 Spacing (us)	Pulse 2-to-3 Spacing (us)	Starting Location Within Interval (ms)	
1	2	67.5	20	1542	-	947	
2	3	83.6	20	1272	1696	124	
3	2	93.2	20	1877	-	701	
4	1	55.6	20	-	-	1123	
5	3	84.2	20	1733	1619	756	
6	3	69.1	20	1612	1071	1	
7	2	66.9	20	1905	-	7	
8	3	86.8	20	1697	1621	1082	
Detection Check (1=Detection; 0=No Detection)							1



Trial Number							15
Number of Bursts in Trial							9
Chirp Center Frequency							5299
Burst	No. of Pulses	Pulse Width (us)	Chirp Width (MHz)	Pulse 1-to-2 Spacing (us)	Pulse 2-to-3 Spacing (us)	Starting Location Within Interval (ms)	
1	2	62.2	19	1571	-	949	
2	2	85	19	1669	-	189	
3	2	64.5	19	1505	-	176	
4	2	50.4	19	1325	-	538	
5	2	66.1	19	1483	-	908	
6	2	71.2	19	1110	-	1017	
7	3	53.7	19	1445	1677	492	
8	3	62.5	19	1596	1341	349	
9	3	62	19	1929	1221	1105	
Detection Check (1=Detection; 0=No Detection)							0

Trial Number							16
Number of Bursts in Trial							10
Chirp Center Frequency							5298
Burst	No. of Pulses	Pulse Width (us)	Chirp Width (MHz)	Pulse 1-to-2 Spacing (us)	Pulse 2-to-3 Spacing (us)	Starting Location Within Interval (ms)	
1	2	80.5	18	1910	-	284	
2	2	64.2	18	1661	-	751	
3	2	90.1	18	1041	-	491	
4	2	69.8	18	1495	-	107	
5	1	73.1	18	-	-	490	
6	3	77.2	18	1418	1145	1155	
7	3	52.6	18	1732	1787	772	
8	2	71.4	18	1562	-	121	
9	2	89.8	18	1491	-	89	
10	2	76.4	18	1355	-	615	
Detection Check (1=Detection; 0=No Detection)							1



Trial Number							17
Number of Bursts in Trial							11
Chirp Center Frequency							5298
Burst	No. of Pulses	Pulse Width (us)	Chirp Width (MHz)	Pulse 1-to-2 Spacing (us)	Pulse 2-to-3 Spacing (us)	Starting Location Within Interval (ms)	
1	2	51.2	17	1236	-	740	
2	1	71.7	17	-	-	941	
3	2	74.7	17	1164	-	370	
4	2	50.9	17	1919	-	371	
5	2	65.2	17	1206	-	1033	
6	2	98	17	1182	-	346	
7	2	58.7	17	1612	-	639	
8	1	63.8	17	-	-	1056	
9	3	86.3	17	1545	1065	205	
10	1	94.4	17	-	-	753	
11	3	88.5	17	1699	1319	58	
Detection Check (1=Detection; 0=No Detection)							0

Trial Number							18
Number of Bursts in Trial							12
Chirp Center Frequency							5297
Burst	No. of Pulses	Pulse Width (us)	Chirp Width (MHz)	Pulse 1-to-2 Spacing (us)	Pulse 2-to-3 Spacing (us)	Starting Location Within Interval (ms)	
1	2	88.7	16	1405	-	448	
2	3	90.2	16	1544	1235	621	
3	1	96.5	16	-	-	512	
4	2	80.5	16	1090	-	321	
5	2	63.7	16	1268	-	798	
6	1	53.4	16	-	-	809	
7	2	52.3	16	1043	-	301	
8	3	54.7	16	1701	1104	796	
9	3	75.6	16	1923	1729	669	
10	2	59.2	16	1244	-	369	
11	1	56.3	16	-	-	51	
12	2	87.8	16	1608	-	733	
Detection Check (1=Detection; 0=No Detection)							1



Trial Number							19
Number of Bursts in Trial							13
Chirp Center Frequency							5297
Burst	No. of Pulses	Pulse Width (us)	Chirp Width (MHz)	Pulse 1-to-2 Spacing (us)	Pulse 2-to-3 Spacing (us)	Starting Location Within Interval (ms)	
1	2	68.2	15	1104	-	229	
2	2	58.4	15	1627	-	488	
3	3	74.7	15	1861	1015	137	
4	2	58.2	15	1593	-	520	
5	1	51.6	15	-	-	799	
6	2	94.7	15	1469	-	43	
7	2	70.7	15	1091	-	126	
8	2	82.9	15	1472	-	607	
9	3	62.7	15	1168	1453	527	
10	2	63.1	15	1529	-	143	
11	1	96.1	15	-	-	176	
12	2	57	15	1457	-	882	
13	3	95.6	15	1707	1501	214	
Detection Check (1=Detection; 0=No Detection)							1

Trial Number							20
Number of Bursts in Trial							14
Chirp Center Frequency							5297
Burst	No. of Pulses	Pulse Width (us)	Chirp Width (MHz)	Pulse 1-to-2 Spacing (us)	Pulse 2-to-3 Spacing (us)	Starting Location Within Interval (ms)	
1	1	95.7	14	-	-	117	
2	1	93.1	14	-	-	720	
3	1	55.8	14	-	-	297	
4	1	76.7	14	-	-	284	
5	2	68	14	1686	-	472	
6	3	94.1	14	1796	1393	264	
7	2	53.9	14	1293	-	525	
8	1	99.3	14	-	-	155	
9	2	73.3	14	1458	-	65	
10	2	93.3	14	1196	-	451	
11	3	55.8	14	1895	1034	243	
12	1	66.4	14	-	-	228	
13	2	65.6	14	1732	-	746	
14	2	76.5	14	1187	-	522	
Detection Check (1=Detection; 0=No Detection)							1



Trial Number							21
Number of Bursts in Trial							15
Chirp Center Frequency							5324
Burst	No. of Pulses	Pulse Width (us)	Chirp Width (MHz)	Pulse 1-to-2 Spacing (us)	Pulse 2-to-3 Spacing (us)	Starting Location Within Interval (ms)	
1	1	85.1	13	-	-	565	
2	2	72.5	13	1648	-	211	
3	1	67.5	13	-	-	348	
4	2	56.1	13	1360	-	156	
5	1	71.1	13	-	-	718	
6	2	93.1	13	1391	-	400	
7	1	56.5	13	-	-	482	
8	1	63.8	13	-	-	703	
9	2	67.4	13	1727	-	780	
10	1	52.3	13	-	-	102	
11	3	62.4	13	1228	1715	304	
12	2	53.3	13	1630	-	57	
13	2	83.1	13	1205	-	768	
14	2	93.7	13	1085	-	461	
15	2	90.7	13	1297	-	746	
Detection Check (1=Detection; 0=No Detection)							1

Trial Number							22
Number of Bursts in Trial							16
Chirp Center Frequency							5324
Burst	No. of Pulses	Pulse Width (us)	Chirp Width (MHz)	Pulse 1-to-2 Spacing (us)	Pulse 2-to-3 Spacing (us)	Starting Location Within Interval (ms)	
1	2	98.8	12	1439	-	95	
2	1	54.5	12	-	-	676	
3	2	80.5	12	1360	-	8	
4	2	55.9	12	1906	-	373	
5	2	72.1	12	1623	-	254	
6	2	84.4	12	1604	-	480	
7	1	78.5	12	-	-	663	
8	1	88	12	-	-	314	
9	2	74.7	12	1157	-	596	
10	2	97.1	12	1673	-	264	
11	1	81.6	12	-	-	740	
12	1	83.6	12	-	-	163	
13	3	87.6	12	1757	1322	628	
14	2	58.5	12	1372	-	132	
15	3	91.8	12	1767	1183	106	
16	2	58.8	12	1432	-	659	
Detection Check (1=Detection; 0=No Detection)							1



Trial Number			23			
Number of Bursts in Trial			17			
Chirp Center Frequency			5325			
Burst	No. of Pulses	Pulse Width (us)	Chirp Width (MHz)	Pulse 1-to-2 Spacing (us)	Pulse 2-to-3 Spacing (us)	Starting Location Within Interval (ms)
1	1	96	11	-	-	284
2	2	92.5	11	1241	-	488
3	2	89.5	11	1347	-	76
4	2	74.8	11	1607	-	688
5	2	60.6	11	1523	-	28
6	2	71.5	11	1659	-	383
7	2	71.1	11	1454	-	182
8	1	98.7	11	-	-	20
9	2	85.1	11	1770	-	576
10	2	89.2	11	1086	-	410
11	2	60.7	11	1101	-	458
12	2	75.2	11	1719	-	348
13	2	75.7	11	1799	-	481
14	3	56.7	11	1132	1884	587
15	2	65	11	1885	-	480
16	2	64.6	11	1910	-	195
17	3	69.9	11	1410	1190	396
Detection Check (1=Detection; 0=No Detection)						1



Trial Number			24			
Number of Bursts in Trial			18			
Chirp Center Frequency			5325			
Burst	No. of Pulses	Pulse Width (us)	Chirp Width (MHz)	Pulse 1-to-2 Spacing (us)	Pulse 2-to-3 Spacing (us)	Starting Location Within Interval (ms)
1	3	83.8	10	1290	1021	536
2	2	66.9	10	1112	-	44
3	3	91	10	1220	1504	611
4	2	86.1	10	1678	-	456
5	3	65.5	10	1928	1222	330
6	1	62.6	10	-	-	297
7	3	68.7	10	1505	1200	351
8	3	59.2	10	1452	1114	230
9	1	73.9	10	-	-	222
10	1	77.2	10	-	-	57
11	2	96.4	10	1357	-	399
12	2	99.9	10	1173	-	299
13	2	99.9	10	1520	-	464
14	1	86.7	10	-	-	294
15	1	92.6	10	-	-	653
16	1	77.1	10	-	-	550
17	2	81.1	10	1664	-	566
18	3	68.4	10	1536	1309	580
Detection Check (1=Detection; 0=No Detection)						1



Trial Number			25			
Number of Bursts in Trial			19			
Chirp Center Frequency			5325			
Burst	No. of Pulses	Pulse Width (us)	Chirp Width (MHz)	Pulse 1-to-2 Spacing (us)	Pulse 2-to-3 Spacing (us)	Starting Location Within Interval (ms)
1	3	68.2	9	1723	1868	471
2	3	83.7	9	1711	1405	368
3	2	69.7	9	1781	-	425
4	1	59.7	9	-	-	440
5	2	96.7	9	1484	-	123
6	2	95.8	9	1319	-	261
7	3	71.3	9	1095	1354	332
8	3	53.2	9	1527	1427	427
9	2	69.5	9	1771	-	397
10	3	63.9	9	1075	1447	67
11	2	93.4	9	1783	-	174
12	2	77.3	9	1564	-	17
13	2	73.1	9	1294	-	216
14	1	77.4	9	-	-	292
15	3	57.2	9	1722	1886	619
16	2	68.7	9	1629	-	233
17	1	60.8	9	-	-	226
18	3	69.7	9	1128	1224	599
19	1	62.2	9	-	-	433
Detection Check (1=Detection; 0=No Detection)						1



Trial Number							26
Number of Bursts in Trial							20
Chirp Center Frequency							5326
Burst	No. of Pulses	Pulse Width (us)	Chirp Width (MHz)	Pulse 1-to-2 Spacing (us)	Pulse 2-to-3 Spacing (us)	Starting Location Within Interval (ms)	
1	1	80.5	8	-	-	90	
2	3	62.6	8	1406	1343	319	
3	3	85.6	8	1190	1529	384	
4	2	83.9	8	1208	-	567	
5	2	92.4	8	1488	-	234	
6	2	54	8	1529	-	535	
7	3	81.3	8	1501	1812	325	
8	1	98.5	8	-	-	532	
9	1	85.8	8	-	-	272	
10	2	84.7	8	1593	-	182	
11	2	83.3	8	1705	-	134	
12	2	79.8	8	1567	-	286	
13	1	77.9	8	-	-	368	
14	3	98.4	8	1510	1569	290	
15	2	79.9	8	1588	-	231	
16	3	78	8	1140	1353	353	
17	3	55.2	8	1700	1327	53	
18	3	71.9	8	1081	1224	44	
19	1	62	8	-	-	298	
20	3	70.5	8	1888	1442	529	
Detection Check (1=Detection; 0=No Detection)							1

Trial Number							27
Number of Bursts in Trial							8
Chirp Center Frequency							5322
Burst	No. of Pulses	Pulse Width (us)	Chirp Width (MHz)	Pulse 1-to-2 Spacing (us)	Pulse 2-to-3 Spacing (us)	Starting Location Within Interval (ms)	
1	2	69.1	18	1076	-	1436	
2	2	62.1	18	1688	-	22	
3	2	94.8	18	1891	-	897	
4	1	75.8	18	-	-	1186	
5	2	65.4	18	1713	-	589	
6	2	97.7	18	1292	-	614	
7	3	98.1	18	1670	1711	506	
8	2	85.4	18	1672	-	776	
Detection Check (1=Detection; 0=No Detection)							1



Trial Number							28
Number of Bursts in Trial							9
Chirp Center Frequency							5321
Burst	No. of Pulses	Pulse Width (us)	Chirp Width (MHz)	Pulse 1-to-2 Spacing (us)	Pulse 2-to-3 Spacing (us)	Starting Location Within Interval (ms)	
1	3	82	19	1233	1713	679	
2	3	87.7	19	1554	1123	473	
3	2	98.9	19	1518	-	869	
4	1	55	19	-	-	719	
5	1	93.6	19	-	-	902	
6	2	58.7	19	1641	-	1243	
7	2	88.7	19	1387	-	410	
8	1	60.3	19	-	-	1154	
9	1	97.7	19	-	-	512	
Detection Check (1=Detection; 0=No Detection)							0

Trial Number							29
Number of Bursts in Trial							10
Chirp Center Frequency							5321
Burst	No. of Pulses	Pulse Width (us)	Chirp Width (MHz)	Pulse 1-to-2 Spacing (us)	Pulse 2-to-3 Spacing (us)	Starting Location Within Interval (ms)	
1	1	69.6	20	-	-	1131	
2	1	74.5	20	-	-	290	
3	1	60.9	20	-	-	895	
4	1	74.6	20	-	-	202	
5	2	99.3	20	1501	-	139	
6	2	95.3	20	1065	-	854	
7	2	91.9	20	1722	-	219	
8	2	51	20	1285	-	57	
9	2	87.7	20	1747	-	141	
10	1	87.2	20	-	-	596	
Detection Check (1=Detection; 0=No Detection)							1



Trial Number		30				
Number of Bursts in Trial		11				
Chirp Center Frequency		5327				
Burst	No. of Pulses	Pulse Width (us)	Chirp Width (MHz)	Pulse 1-to-2 Spacing (us)	Pulse 2-to-3 Spacing (us)	Starting Location Within Interval (ms)
1	3	59.9	5	1901	1196	935
2	2	77.1	5	1590	-	1038
3	2	62.7	5	1227	-	690
4	1	77.1	5	-	-	547
5	3	99.8	5	1798	1790	551
6	2	61.5	5	1135	-	876
7	2	77.5	5	1583	-	448
8	2	57.3	5	1890	-	736
9	2	53.5	5	1757	-	362
10	1	66.6	5	-	-	836
11	3	80.7	5	1811	1289	410
Detection Check (1=Detection; 0=No Detection)						1



Type 6 Radar Statistical Performance

Trial #	Test Freq. (MHz)	Pulses / Hop	Pulse Width (us)	PRI (us)	1=Detection 0=No Detection
1	5290	9	1	333	1
2	5290	9	1	333	1
3	5290	9	1	333	1
4	5290	9	1	333	1
5	5290	9	1	333	1
6	5290	9	1	333	1
7	5290	9	1	333	1
8	5290	9	1	333	1
9	5290	9	1	333	1
10	5290	9	1	333	1
11	5290	9	1	333	1
12	5290	9	1	333	1
13	5290	9	1	333	1
14	5290	9	1	333	1
15	5290	9	1	333	1
16	5290	9	1	333	1
17	5290	9	1	333	1
18	5290	9	1	333	1
19	5290	9	1	333	1
20	5290	9	1	333	0
21	5290	9	1	333	1
22	5290	9	1	333	1
23	5290	9	1	333	1
24	5290	9	1	333	1
25	5290	9	1	333	1
26	5290	9	1	333	1
27	5290	9	1	333	1
28	5290	9	1	333	1
29	5290	9	1	333	1
30	5290	9	1	333	1
Detection Percentage (%)					96.667
Limit					70%
Test Result					Complied



Modulation Mode: 802.11ac (VHT160)

Type 1 Radar Statistical Performance

Trial #	Test Freq. (MHz)	Pulse Repetition Frequency Number	Pulse Repetition Frequency (Pulse Per Second)	PRI (us)	1=Detection 0=No Detection
1	5252	1	1930.5	518	1
2	5271	23	326.2	3066	1
3	5304	19	1139.0	878	1
4	5313	12	1355.0	738	1
5	5296	4	1730.1	578	1
6	5327	8	1519.8	658	1
7	5250	15	1253.1	798	1
8	5286	6	1618.1	618	1
9	5315	14	1285.3	778	1
10	5311	3	1792.1	558	1
11	5289	13	1319.3	758	0
12	5266	9	1474.9	678	1
13	5306	7	1567.4	638	1
14	5320	17	1193.3	838	0
15	5262	10	1432.7	698	1
16	5326	-	1692.0	591	1
17	5306	-	328.1	3048	1
18	5270	-	373.4	2678	1
19	5266	-	574.4	1741	1
20	5283	-	1216.5	822	1
21	5322	-	801.3	1248	1
22	5264	-	488.5	2047	0
23	5315	-	956.0	1046	1
24	5272	-	517.6	1932	1
25	5291	-	1422.5	703	1
26	5287	-	542.0	1845	1
27	5305	-	741.3	1349	1
28	5329	-	881.8	1134	1
29	5258	-	427.4	2340	1
30	5279	-	628.9	1590	1
Detection Percentage (%)					90.000
Limit					60%
Test Result					Complied



Type 2 Radar Statistical Performance

Trial #	Test Freq. (MHz)	Pulse Width (us)	PRI (us)	Pulses / Burst	1=Detection 0=No Detection
1	5252	2.6	221	23	1
2	5271	4.6	198	27	1
3	5304	1.1	184	29	1
4	5313	4.8	203	24	1
5	5296	2.4	162	25	1
6	5327	3.4	204	28	0
7	5250	2.3	170	27	1
8	5286	3.5	184	23	1
9	5315	4.9	150	27	1
10	5311	4.6	211	29	0
11	5289	2.9	158	23	1
12	5266	2.6	226	27	1
13	5306	1.6	204	26	1
14	5320	3.9	181	25	1
15	5262	4.6	202	24	1
16	5326	4.1	194	27	0
17	5306	2.3	193	28	1
18	5270	3.9	173	29	1
19	5266	4.3	188	23	1
20	5283	1.5	215	26	1
21	5322	4.9	227	27	1
22	5264	1.1	199	23	1
23	5315	4.5	155	29	1
24	5272	4.0	190	27	1
25	5291	2.4	151	23	1
26	5287	2.5	180	28	1
27	5305	2.5	228	23	1
28	5329	2.5	203	25	1
29	5258	1.5	188	25	1
30	5279	1.9	217	24	1
Detection Percentage (%)					90.000
Limit					60%
Test Result					Complied



Type 3 Radar Statistical Performance

Trial #	Test Freq. (MHz)	Pulse Width (us)	PRI (us)	Pulses / Burst	1=Detection 0=No Detection
1	5252	8.0	205	16	1
2	5271	6.7	382	18	1
3	5304	8.6	418	16	1
4	5313	9.4	351	17	1
5	5296	7.4	383	18	0
6	5327	9.8	232	16	1
7	5250	9.1	377	17	1
8	5286	9.6	457	16	1
9	5315	8.0	471	18	1
10	5311	9.0	304	18	1
11	5289	8.0	316	17	0
12	5266	9.8	325	16	1
13	5306	8.0	409	17	1
14	5320	9.9	200	17	1
15	5262	8.8	458	16	1
16	5326	8.0	232	18	1
17	5306	8.3	250	16	1
18	5270	8.7	270	16	0
19	5266	7.7	350	17	1
20	5283	7.1	230	16	1
21	5322	7.3	416	18	1
22	5264	7.6	498	18	1
23	5315	7.3	286	17	1
24	5272	7.3	287	16	1
25	5291	7.5	462	17	0
26	5287	6.2	300	17	1
27	5305	6.4	323	18	1
28	5329	7.1	420	16	1
29	5258	7.2	395	18	1
30	5279	8.4	377	16	1
Detection Percentage (%)					86.667
Limit					60%
Test Result					Complied



Type 4 Radar Statistical Performance

Trial #	Test Freq. (MHz)	Pulse Width (us)	PRI (us)	Pulses / Burst	1=Detection 0=No Detection
1	5252	18.0	242	15	1
2	5271	19.9	279	12	1
3	5304	12.9	487	14	1
4	5313	15.0	452	13	1
5	5296	16.3	230	12	1
6	5327	19.8	238	13	1
7	5250	18.2	420	16	1
8	5286	16.3	452	15	1
9	5315	14.2	495	12	1
10	5311	17.8	228	16	1
11	5289	19.1	211	16	1
12	5266	18.4	283	15	0
13	5306	11.8	411	12	1
14	5320	14.2	284	13	1
15	5262	13.9	202	12	1
16	5326	17.8	340	14	0
17	5306	15.6	290	16	1
18	5270	14.6	250	16	1
19	5266	14.4	484	15	1
20	5283	18.9	387	13	1
21	5322	11.1	348	15	0
22	5264	13.8	291	16	1
23	5315	14.3	295	12	1
24	5272	12.5	300	12	1
25	5291	12.5	322	14	0
26	5287	12.5	383	13	1
27	5305	15.7	322	16	1
28	5329	19.8	469	13	1
29	5258	18.6	406	15	1
30	5279	15.9	238	14	1
Detection Percentage (%)					86.667
Limit					60%
Test Result					Complied



Total Type 1~4 Radar Statistical Performance

Radar Type #	Detection Percentage (%)
1	90.000
2	90.000
3	86.667
4	86.667
Aggregate (Radar Types 1-4)	88.333
Limit	80%
Test Result	Complied



Type 5 Radar Statistical Performance

Center Freq. (MHz)	High Edge (MHz)	VSG Freq. (MHz)	Detection
5250	5329		
Trial	Offset		
1	2.0	5327	1
2	8.0	5321	1
3	2.8	5326.2	1
4	3.2	5325.8	1
5	3.6	5325.4	1
6	4.0	5325	1
7	4.4	5324.6	0
8	4.8	5324.2	1
9	5.2	5323.8	1
10	5.6	5323.4	1
11	6.0	5323	1
12	6.4	5323	1
13	6.8	5322	1
14	8.0	5321	1
15	7.6	5321	1
16	7.2	5322	1
17	6.8	5322	1
18	6.4	5323	1
19	6.0	5323	0
20	5.6	5323	1
21	5.2	5324	0
22	4.8	5324	1
23	4.4	5325	1
24	4.0	5325	1
25	3.6	5325	1
26	3.2	5326	1
27	7.2	5322	1
28	7.6	5321	1
29	8.0	5321	1
30	2.0	5327	1
Total			27
Detection Percentage (%)			90%
Limit			80%
Test Result			Complied



Trial Number							1
Number of Bursts in Trial							8
Chirp Center Frequency							5327
Burst	No. of Pulses	Pulse Width (us)	Chirp Width (MHz)	Pulse 1-to-2 Spacing (us)	Pulse 2-to-3 Spacing (us)	Starting Location Within Interval (ms)	
1	1	62.1	5	-	-	1091	
2	2	56	5	1729	-	133	
3	2	91.3	5	1230	-	1057	
4	3	50.7	5	1762	1616	1442	
5	2	92.6	5	1723	-	544	
6	2	87.3	5	1302	-	1089	
7	2	59.5	5	1291	-	1374	
8	2	52.2	5	1653	-	1237	
Detection Check (1=Detection; 0=No Detection)							1

Trial Number							2
Number of Bursts in Trial							9
Chirp Center Frequency							5321
Burst	No. of Pulses	Pulse Width (us)	Chirp Width (MHz)	Pulse 1-to-2 Spacing (us)	Pulse 2-to-3 Spacing (us)	Starting Location Within Interval (ms)	
1	3	90	20	1007	1326	30	
2	2	73.7	20	1785	-	979	
3	1	78.1	20	-	-	683	
4	2	92.4	20	1281	-	950	
5	1	61.2	20	-	-	612	
6	3	67.2	20	1525	1870	17	
7	1	78.5	20	-	-	429	
8	2	60.3	20	1931	-	936	
9	3	92.9	20	1403	1476	548	
Detection Check (1=Detection; 0=No Detection)							1



Trial Number							3
Number of Bursts in Trial							10
Chirp Center Frequency							5326.2
Burst	No. of Pulses	Pulse Width (us)	Chirp Width (MHz)	Pulse 1-to-2 Spacing (us)	Pulse 2-to-3 Spacing (us)	Starting Location Within Interval (ms)	
1	3	63.4	7	1574	1607	801	
2	1	98	7	-	-	966	
3	1	58.7	7	-	-	185	
4	1	88	7	-	-	1012	
5	3	79.5	7	1562	1370	943	
6	3	57.1	7	1900	1188	686	
7	2	64.4	7	1090	-	599	
8	1	78.7	7	-	-	1089	
9	1	69.3	7	-	-	188	
10	3	55.3	7	1375	1691	933	
Detection Check (1=Detection; 0=No Detection)							1

Trial Number							4
Number of Bursts in Trial							11
Chirp Center Frequency							5325.8
Burst	No. of Pulses	Pulse Width (us)	Chirp Width (MHz)	Pulse 1-to-2 Spacing (us)	Pulse 2-to-3 Spacing (us)	Starting Location Within Interval (ms)	
1	2	74.3	8	1642	-	24	
2	1	83.1	8	-	-	985	
3	2	59.5	8	1680	-	988	
4	2	59.8	8	1786	-	800	
5	2	77.6	8	1617	-	339	
6	2	79.9	8	1553	-	1040	
7	1	56	8	-	-	544	
8	3	71.4	8	1406	1927	452	
9	1	97.4	8	-	-	204	
10	2	98.3	8	1037	-	926	
11	1	63.6	8	-	-	1052	
Detection Check (1=Detection; 0=No Detection)							1



Trial Number		5				
Number of Bursts in Trial		12				
Chirp Center Frequency		5325.4				
Burst	No. of Pulses	Pulse Width (us)	Chirp Width (MHz)	Pulse 1-to-2 Spacing (us)	Pulse 2-to-3 Spacing (us)	Starting Location Within Interval (ms)
1	1	50	9	-	-	557
2	2	62.5	9	1731	-	567
3	2	55.4	9	1070	-	460
4	1	65.7	9	-	-	4
5	2	58	9	1512	-	64
6	2	60.9	9	1230	-	650
7	3	89.6	9	1598	1738	235
8	3	84.4	9	1271	1617	873
9	3	72.3	9	1498	1321	901
10	1	58.9	9	-	-	663
11	2	74.8	9	1584	-	919
12	1	71.8	9	-	-	375
Detection Check (1=Detection; 0=No Detection)						1

Trial Number		6				
Number of Bursts in Trial		13				
Chirp Center Frequency		5325				
Burst	No. of Pulses	Pulse Width (us)	Chirp Width (MHz)	Pulse 1-to-2 Spacing (us)	Pulse 2-to-3 Spacing (us)	Starting Location Within Interval (ms)
1	2	88.1	10	1257	-	846
2	1	58.7	10	-	-	725
3	2	97.1	10	1037	-	30
4	3	83.1	10	1029	1106	490
5	1	62.1	10	-	-	262
6	2	71.4	10	1058	-	283
7	2	86.3	10	1867	-	49
8	3	77.3	10	1418	1876	634
9	1	78.9	10	-	-	304
10	3	79.2	10	1055	1572	564
11	3	52	10	1582	1836	852
12	3	56.5	10	1195	1542	525
13	3	100	10	1638	1729	750
Detection Check (1=Detection; 0=No Detection)						1



Trial Number							7
Number of Bursts in Trial							14
Chirp Center Frequency							5324.6
Burst	No. of Pulses	Pulse Width (us)	Chirp Width (MHz)	Pulse 1-to-2 Spacing (us)	Pulse 2-to-3 Spacing (us)	Starting Location Within Interval (ms)	
1	2	92.7	11	1208	-	231	
2	2	81.3	11	1144	-	804	
3	2	60.4	11	1555	-	34	
4	2	62.1	11	1320	-	427	
5	1	50	11	-	-	577	
6	3	65.9	11	1020	1365	3	
7	2	73.8	11	1308	-	51	
8	2	74.3	11	1143	-	360	
9	1	62.9	11	-	-	394	
10	2	74.8	11	1404	-	317	
11	2	69.7	11	1309	-	532	
12	2	69.8	11	1688	-	339	
13	2	77.4	11	1857	-	381	
14	1	55.1	11	-	-	426	
Detection Check (1=Detection; 0=No Detection)							0

Trial Number							8
Number of Bursts in Trial							15
Chirp Center Frequency							5324.2
Burst	No. of Pulses	Pulse Width (us)	Chirp Width (MHz)	Pulse 1-to-2 Spacing (us)	Pulse 2-to-3 Spacing (us)	Starting Location Within Interval (ms)	
1	1	91.7	12	-	-	776	
2	2	90	12	1196	-	187	
3	3	92.3	12	1486	1853	448	
4	2	66.8	12	1545	-	702	
5	1	64	12	-	-	403	
6	3	95.4	12	1123	1473	230	
7	3	66.8	12	1867	1401	604	
8	3	67.7	12	1472	1397	38	
9	1	68.2	12	-	-	735	
10	2	82.2	12	1297	-	610	
11	1	92.1	12	-	-	618	
12	2	57	12	1764	-	705	
13	2	58.5	12	1310	-	22	
14	3	85.5	12	1630	1447	641	
15	2	82.2	12	1371	-	109	
Detection Check (1=Detection; 0=No Detection)							1



Trial Number			9			
Number of Bursts in Trial			16			
Chirp Center Frequency			5323.8			
Burst	No. of Pulses	Pulse Width (us)	Chirp Width (MHz)	Pulse 1-to-2 Spacing (us)	Pulse 2-to-3 Spacing (us)	Starting Location Within Interval (ms)
1	2	74.4	13	1707	-	442
2	2	63.6	13	1725	-	280
3	2	71.3	13	1704	-	459
4	3	77.6	13	1063	1405	197
5	3	65.2	13	1731	1294	101
6	3	55.1	13	1109	1549	17
7	2	96.8	13	1034	-	131
8	3	80.8	13	1533	1051	365
9	1	60.4	13	-	-	222
10	2	61.8	13	1312	-	371
11	2	71.3	13	1657	-	33
12	2	98.1	13	1024	-	291
13	1	57.9	13	-	-	188
14	1	91.8	13	-	-	163
15	2	56.7	13	1259	-	426
16	2	89.7	13	1690	-	606
Detection Check (1=Detection; 0=No Detection)						1



Trial Number			10			
Number of Bursts in Trial			17			
Chirp Center Frequency			5323.4			
Burst	No. of Pulses	Pulse Width (us)	Chirp Width (MHz)	Pulse 1-to-2 Spacing (us)	Pulse 2-to-3 Spacing (us)	Starting Location Within Interval (ms)
1	2	74.4	14	1107	-	462
2	1	87.6	14	-	-	653
3	2	61.7	14	1741	-	457
4	2	57.5	14	1566	-	388
5	2	66.1	14	1855	-	63
6	3	70.1	14	1044	1012	136
7	1	66.4	14	-	-	343
8	1	59.2	14	-	-	349
9	2	88.3	14	1240	-	362
10	1	64.7	14	-	-	221
11	2	73	14	1703	-	144
12	2	81.7	14	1450	-	671
13	3	70.1	14	1741	1278	320
14	1	63.6	14	-	-	196
15	1	58.7	14	-	-	413
16	2	65.9	14	1478	-	170
17	1	72.7	14	-	-	564
Detection Check (1=Detection; 0=No Detection)						1



Trial Number			11			
Number of Bursts in Trial			18			
Chirp Center Frequency			5323			
Burst	No. of Pulses	Pulse Width (us)	Chirp Width (MHz)	Pulse 1-to-2 Spacing (us)	Pulse 2-to-3 Spacing (us)	Starting Location Within Interval (ms)
1	2	72.1	15	1193	-	130
2	3	76.3	15	1484	1390	114
3	1	86.1	15	-	-	14
4	1	73.2	15	-	-	604
5	1	81.2	15	-	-	548
6	2	99.5	15	1398	-	173
7	1	93.9	15	-	-	262
8	2	75.9	15	1921	-	38
9	3	79.2	15	1100	1429	84
10	3	77	15	1166	1799	610
11	1	91.8	15	-	-	339
12	3	56.8	15	1330	1556	580
13	2	83.1	15	1556	-	295
14	2	63	15	1552	-	156
15	1	65.7	15	-	-	439
16	1	64.5	15	-	-	188
17	1	88.5	15	-	-	419
18	1	60.6	15	-	-	205
Detection Check (1=Detection; 0=No Detection)						1



Trial Number			12			
Number of Bursts in Trial			19			
Chirp Center Frequency			5323			
Burst	No. of Pulses	Pulse Width (us)	Chirp Width (MHz)	Pulse 1-to-2 Spacing (us)	Pulse 2-to-3 Spacing (us)	Starting Location Within Interval (ms)
1	2	90.5	16	1299	-	381
2	2	88.4	16	1418	-	327
3	2	53.7	16	1055	-	536
4	1	80.5	16	-	-	285
5	1	50.4	16	-	-	398
6	2	61.2	16	1749	-	439
7	2	78.8	16	1065	-	129
8	3	75	16	1748	1820	325
9	2	96.7	16	1254	-	440
10	3	76.3	16	1848	1106	397
11	1	73.3	16	-	-	232
12	2	92.4	16	1317	-	91
13	2	92.4	16	1854	-	256
14	3	64.4	16	1240	1634	582
15	2	67.3	16	1473	-	117
16	2	84.1	16	1795	-	202
17	1	80.9	16	-	-	135
18	1	74.6	16	-	-	396
19	2	97.6	16	1805	-	615
Detection Check (1=Detection; 0=No Detection)						1



Trial Number							13
Number of Bursts in Trial							20
Chirp Center Frequency							5322
Burst	No. of Pulses	Pulse Width (us)	Chirp Width (MHz)	Pulse 1-to-2 Spacing (us)	Pulse 2-to-3 Spacing (us)	Starting Location Within Interval (ms)	
1	2	66.1	17	1417	-	388	
2	2	86.7	17	1693	-	348	
3	2	70.5	17	1263	-	215	
4	2	78	17	1446	-	28	
5	2	66	17	1185	-	585	
6	2	80.6	17	1855	-	65	
7	1	95.5	17	-	-	92	
8	1	98.8	17	-	-	68	
9	3	64.3	17	1641	1108	517	
10	1	75.1	17	-	-	121	
11	2	72.6	17	1499	-	448	
12	1	60.3	17	-	-	567	
13	2	54.9	17	1056	-	245	
14	2	98.8	17	1023	-	584	
15	2	60.9	17	1243	-	579	
16	2	62.7	17	1226	-	464	
17	1	80.1	17	-	-	89	
18	2	70.9	17	1711	-	153	
19	1	90.7	17	-	-	282	
20	1	98.9	17	-	-	71	
Detection Check (1=Detection; 0=No Detection)							1

Trial Number							14
Number of Bursts in Trial							8
Chirp Center Frequency							5321
Burst	No. of Pulses	Pulse Width (us)	Chirp Width (MHz)	Pulse 1-to-2 Spacing (us)	Pulse 2-to-3 Spacing (us)	Starting Location Within Interval (ms)	
1	2	67.5	20	1542	-	947	
2	3	83.6	20	1272	1696	124	
3	2	93.2	20	1877	-	701	
4	1	55.6	20	-	-	1123	
5	3	84.2	20	1733	1619	756	
6	3	69.1	20	1612	1071	1	
7	2	66.9	20	1905	-	7	
8	3	86.8	20	1697	1621	1082	
Detection Check (1=Detection; 0=No Detection)							1



Trial Number							15
Number of Bursts in Trial							9
Chirp Center Frequency							5321
Burst	No. of Pulses	Pulse Width (us)	Chirp Width (MHz)	Pulse 1-to-2 Spacing (us)	Pulse 2-to-3 Spacing (us)	Starting Location Within Interval (ms)	
1	2	62.2	19	1571	-	949	
2	2	85	19	1669	-	189	
3	2	64.5	19	1505	-	176	
4	2	50.4	19	1325	-	538	
5	2	66.1	19	1483	-	908	
6	2	71.2	19	1110	-	1017	
7	3	53.7	19	1445	1677	492	
8	3	62.5	19	1596	1341	349	
9	3	62	19	1929	1221	1105	
Detection Check (1=Detection; 0=No Detection)							1

Trial Number							16
Number of Bursts in Trial							10
Chirp Center Frequency							5322
Burst	No. of Pulses	Pulse Width (us)	Chirp Width (MHz)	Pulse 1-to-2 Spacing (us)	Pulse 2-to-3 Spacing (us)	Starting Location Within Interval (ms)	
1	2	80.5	18	1910	-	284	
2	2	64.2	18	1661	-	751	
3	2	90.1	18	1041	-	491	
4	2	69.8	18	1495	-	107	
5	1	73.1	18	-	-	490	
6	3	77.2	18	1418	1145	1155	
7	3	52.6	18	1732	1787	772	
8	2	71.4	18	1562	-	121	
9	2	89.8	18	1491	-	89	
10	2	76.4	18	1355	-	615	
Detection Check (1=Detection; 0=No Detection)							1



Trial Number							17
Number of Bursts in Trial							11
Chirp Center Frequency							5322
Burst	No. of Pulses	Pulse Width (us)	Chirp Width (MHz)	Pulse 1-to-2 Spacing (us)	Pulse 2-to-3 Spacing (us)	Starting Location Within Interval (ms)	
1	2	51.2	17	1236	-	740	
2	1	71.7	17	-	-	941	
3	2	74.7	17	1164	-	370	
4	2	50.9	17	1919	-	371	
5	2	65.2	17	1206	-	1033	
6	2	98	17	1182	-	346	
7	2	58.7	17	1612	-	639	
8	1	63.8	17	-	-	1056	
9	3	86.3	17	1545	1065	205	
10	1	94.4	17	-	-	753	
11	3	88.5	17	1699	1319	58	
Detection Check (1=Detection; 0=No Detection)							1

Trial Number							18
Number of Bursts in Trial							12
Chirp Center Frequency							5323
Burst	No. of Pulses	Pulse Width (us)	Chirp Width (MHz)	Pulse 1-to-2 Spacing (us)	Pulse 2-to-3 Spacing (us)	Starting Location Within Interval (ms)	
1	2	88.7	16	1405	-	448	
2	3	90.2	16	1544	1235	621	
3	1	96.5	16	-	-	512	
4	2	80.5	16	1090	-	321	
5	2	63.7	16	1268	-	798	
6	1	53.4	16	-	-	809	
7	2	52.3	16	1043	-	301	
8	3	54.7	16	1701	1104	796	
9	3	75.6	16	1923	1729	669	
10	2	59.2	16	1244	-	369	
11	1	56.3	16	-	-	51	
12	2	87.8	16	1608	-	733	
Detection Check (1=Detection; 0=No Detection)							1



Trial Number							19
Number of Bursts in Trial							13
Chirp Center Frequency							5323
Burst	No. of Pulses	Pulse Width (us)	Chirp Width (MHz)	Pulse 1-to-2 Spacing (us)	Pulse 2-to-3 Spacing (us)	Starting Location Within Interval (ms)	
1	2	68.2	15	1104	-	229	
2	2	58.4	15	1627	-	488	
3	3	74.7	15	1861	1015	137	
4	2	58.2	15	1593	-	520	
5	1	51.6	15	-	-	799	
6	2	94.7	15	1469	-	43	
7	2	70.7	15	1091	-	126	
8	2	82.9	15	1472	-	607	
9	3	62.7	15	1168	1453	527	
10	2	63.1	15	1529	-	143	
11	1	96.1	15	-	-	176	
12	2	57	15	1457	-	882	
13	3	95.6	15	1707	1501	214	
Detection Check (1=Detection; 0=No Detection)							0

Trial Number							20
Number of Bursts in Trial							14
Chirp Center Frequency							5323
Burst	No. of Pulses	Pulse Width (us)	Chirp Width (MHz)	Pulse 1-to-2 Spacing (us)	Pulse 2-to-3 Spacing (us)	Starting Location Within Interval (ms)	
1	1	95.7	14	-	-	117	
2	1	93.1	14	-	-	720	
3	1	55.8	14	-	-	297	
4	1	76.7	14	-	-	284	
5	2	68	14	1686	-	472	
6	3	94.1	14	1796	1393	264	
7	2	53.9	14	1293	-	525	
8	1	99.3	14	-	-	155	
9	2	73.3	14	1458	-	65	
10	2	93.3	14	1196	-	451	
11	3	55.8	14	1895	1034	243	
12	1	66.4	14	-	-	228	
13	2	65.6	14	1732	-	746	
14	2	76.5	14	1187	-	522	
Detection Check (1=Detection; 0=No Detection)							1



Trial Number							21
Number of Bursts in Trial							15
Chirp Center Frequency							5324
Burst	No. of Pulses	Pulse Width (us)	Chirp Width (MHz)	Pulse 1-to-2 Spacing (us)	Pulse 2-to-3 Spacing (us)	Starting Location Within Interval (ms)	
1	1	85.1	13	-	-	565	
2	2	72.5	13	1648	-	211	
3	1	67.5	13	-	-	348	
4	2	56.1	13	1360	-	156	
5	1	71.1	13	-	-	718	
6	2	93.1	13	1391	-	400	
7	1	56.5	13	-	-	482	
8	1	63.8	13	-	-	703	
9	2	67.4	13	1727	-	780	
10	1	52.3	13	-	-	102	
11	3	62.4	13	1228	1715	304	
12	2	53.3	13	1630	-	57	
13	2	83.1	13	1205	-	768	
14	2	93.7	13	1085	-	461	
15	2	90.7	13	1297	-	746	
Detection Check (1=Detection; 0=No Detection)							0

Trial Number							22
Number of Bursts in Trial							16
Chirp Center Frequency							5324
Burst	No. of Pulses	Pulse Width (us)	Chirp Width (MHz)	Pulse 1-to-2 Spacing (us)	Pulse 2-to-3 Spacing (us)	Starting Location Within Interval (ms)	
1	2	98.8	12	1439	-	95	
2	1	54.5	12	-	-	676	
3	2	80.5	12	1360	-	8	
4	2	55.9	12	1906	-	373	
5	2	72.1	12	1623	-	254	
6	2	84.4	12	1604	-	480	
7	1	78.5	12	-	-	663	
8	1	88	12	-	-	314	
9	2	74.7	12	1157	-	596	
10	2	97.1	12	1673	-	264	
11	1	81.6	12	-	-	740	
12	1	83.6	12	-	-	163	
13	3	87.6	12	1757	1322	628	
14	2	58.5	12	1372	-	132	
15	3	91.8	12	1767	1183	106	
16	2	58.8	12	1432	-	659	
Detection Check (1=Detection; 0=No Detection)							1



Trial Number			23			
Number of Bursts in Trial			17			
Chirp Center Frequency			5325			
Burst	No. of Pulses	Pulse Width (us)	Chirp Width (MHz)	Pulse 1-to-2 Spacing (us)	Pulse 2-to-3 Spacing (us)	Starting Location Within Interval (ms)
1	1	96	11	-	-	284
2	2	92.5	11	1241	-	488
3	2	89.5	11	1347	-	76
4	2	74.8	11	1607	-	688
5	2	60.6	11	1523	-	28
6	2	71.5	11	1659	-	383
7	2	71.1	11	1454	-	182
8	1	98.7	11	-	-	20
9	2	85.1	11	1770	-	576
10	2	89.2	11	1086	-	410
11	2	60.7	11	1101	-	458
12	2	75.2	11	1719	-	348
13	2	75.7	11	1799	-	481
14	3	56.7	11	1132	1884	587
15	2	65	11	1885	-	480
16	2	64.6	11	1910	-	195
17	3	69.9	11	1410	1190	396
Detection Check (1=Detection; 0=No Detection)						1



Trial Number			24			
Number of Bursts in Trial			18			
Chirp Center Frequency			5325			
Burst	No. of Pulses	Pulse Width (us)	Chirp Width (MHz)	Pulse 1-to-2 Spacing (us)	Pulse 2-to-3 Spacing (us)	Starting Location Within Interval (ms)
1	3	83.8	10	1290	1021	536
2	2	66.9	10	1112	-	44
3	3	91	10	1220	1504	611
4	2	86.1	10	1678	-	456
5	3	65.5	10	1928	1222	330
6	1	62.6	10	-	-	297
7	3	68.7	10	1505	1200	351
8	3	59.2	10	1452	1114	230
9	1	73.9	10	-	-	222
10	1	77.2	10	-	-	57
11	2	96.4	10	1357	-	399
12	2	99.9	10	1173	-	299
13	2	99.9	10	1520	-	464
14	1	86.7	10	-	-	294
15	1	92.6	10	-	-	653
16	1	77.1	10	-	-	550
17	2	81.1	10	1664	-	566
18	3	68.4	10	1536	1309	580
Detection Check (1=Detection; 0=No Detection)						1



Trial Number			25			
Number of Bursts in Trial			19			
Chirp Center Frequency			5325			
Burst	No. of Pulses	Pulse Width (us)	Chirp Width (MHz)	Pulse 1-to-2 Spacing (us)	Pulse 2-to-3 Spacing (us)	Starting Location Within Interval (ms)
1	3	68.2	9	1723	1868	471
2	3	83.7	9	1711	1405	368
3	2	69.7	9	1781	-	425
4	1	59.7	9	-	-	440
5	2	96.7	9	1484	-	123
6	2	95.8	9	1319	-	261
7	3	71.3	9	1095	1354	332
8	3	53.2	9	1527	1427	427
9	2	69.5	9	1771	-	397
10	3	63.9	9	1075	1447	67
11	2	93.4	9	1783	-	174
12	2	77.3	9	1564	-	17
13	2	73.1	9	1294	-	216
14	1	77.4	9	-	-	292
15	3	57.2	9	1722	1886	619
16	2	68.7	9	1629	-	233
17	1	60.8	9	-	-	226
18	3	69.7	9	1128	1224	599
19	1	62.2	9	-	-	433
Detection Check (1=Detection; 0=No Detection)						1



Trial Number							26
Number of Bursts in Trial							20
Chirp Center Frequency							5326
Burst	No. of Pulses	Pulse Width (us)	Chirp Width (MHz)	Pulse 1-to-2 Spacing (us)	Pulse 2-to-3 Spacing (us)	Starting Location Within Interval (ms)	
1	1	80.5	8	-	-	90	
2	3	62.6	8	1406	1343	319	
3	3	85.6	8	1190	1529	384	
4	2	83.9	8	1208	-	567	
5	2	92.4	8	1488	-	234	
6	2	54	8	1529	-	535	
7	3	81.3	8	1501	1812	325	
8	1	98.5	8	-	-	532	
9	1	85.8	8	-	-	272	
10	2	84.7	8	1593	-	182	
11	2	83.3	8	1705	-	134	
12	2	79.8	8	1567	-	286	
13	1	77.9	8	-	-	368	
14	3	98.4	8	1510	1569	290	
15	2	79.9	8	1588	-	231	
16	3	78	8	1140	1353	353	
17	3	55.2	8	1700	1327	53	
18	3	71.9	8	1081	1224	44	
19	1	62	8	-	-	298	
20	3	70.5	8	1888	1442	529	
Detection Check (1=Detection; 0=No Detection)							1

Trial Number							27
Number of Bursts in Trial							8
Chirp Center Frequency							5322
Burst	No. of Pulses	Pulse Width (us)	Chirp Width (MHz)	Pulse 1-to-2 Spacing (us)	Pulse 2-to-3 Spacing (us)	Starting Location Within Interval (ms)	
1	2	69.1	18	1076	-	1436	
2	2	62.1	18	1688	-	22	
3	2	94.8	18	1891	-	897	
4	1	75.8	18	-	-	1186	
5	2	65.4	18	1713	-	589	
6	2	97.7	18	1292	-	614	
7	3	98.1	18	1670	1711	506	
8	2	85.4	18	1672	-	776	
Detection Check (1=Detection; 0=No Detection)							1



Trial Number							28
Number of Bursts in Trial							9
Chirp Center Frequency							5321
Burst	No. of Pulses	Pulse Width (us)	Chirp Width (MHz)	Pulse 1-to-2 Spacing (us)	Pulse 2-to-3 Spacing (us)	Starting Location Within Interval (ms)	
1	3	82	19	1233	1713	679	
2	3	87.7	19	1554	1123	473	
3	2	98.9	19	1518	-	869	
4	1	55	19	-	-	719	
5	1	93.6	19	-	-	902	
6	2	58.7	19	1641	-	1243	
7	2	88.7	19	1387	-	410	
8	1	60.3	19	-	-	1154	
9	1	97.7	19	-	-	512	
Detection Check (1=Detection; 0=No Detection)							1

Trial Number							29
Number of Bursts in Trial							10
Chirp Center Frequency							5321
Burst	No. of Pulses	Pulse Width (us)	Chirp Width (MHz)	Pulse 1-to-2 Spacing (us)	Pulse 2-to-3 Spacing (us)	Starting Location Within Interval (ms)	
1	1	69.6	20	-	-	1131	
2	1	74.5	20	-	-	290	
3	1	60.9	20	-	-	895	
4	1	74.6	20	-	-	202	
5	2	99.3	20	1501	-	139	
6	2	95.3	20	1065	-	854	
7	2	91.9	20	1722	-	219	
8	2	51	20	1285	-	57	
9	2	87.7	20	1747	-	141	
10	1	87.2	20	-	-	596	
Detection Check (1=Detection; 0=No Detection)							1



Trial Number		30				
Number of Bursts in Trial		11				
Chirp Center Frequency		5327				
Burst	No. of Pulses	Pulse Width (us)	Chirp Width (MHz)	Pulse 1-to-2 Spacing (us)	Pulse 2-to-3 Spacing (us)	Starting Location Within Interval (ms)
1	3	59.9	5	1901	1196	935
2	2	77.1	5	1590	-	1038
3	2	62.7	5	1227	-	690
4	1	77.1	5	-	-	547
5	3	99.8	5	1798	1790	551
6	2	61.5	5	1135	-	876
7	2	77.5	5	1583	-	448
8	2	57.3	5	1890	-	736
9	2	53.5	5	1757	-	362
10	1	66.6	5	-	-	836
11	3	80.7	5	1811	1289	410
Detection Check (1=Detection; 0=No Detection)						1



Type 6 Radar Statistical Performance

Trial #	Test Freq. (MHz)	Pulses / Hop	Pulse Width (us)	PRI (us)	1=Detection 0=No Detection
1	5250	9	1	333	1
2	5250	9	1	333	1
3	5250	9	1	333	1
4	5250	9	1	333	1
5	5250	9	1	333	1
6	5250	9	1	333	1
7	5250	9	1	333	1
8	5250	9	1	333	1
9	5250	9	1	333	1
10	5250	9	1	333	1
11	5250	9	1	333	1
12	5250	9	1	333	1
13	5250	9	1	333	1
14	5250	9	1	333	1
15	5250	9	1	333	1
16	5250	9	1	333	1
17	5250	9	1	333	1
18	5250	9	1	333	0
19	5250	9	1	333	1
20	5250	9	1	333	1
21	5250	9	1	333	1
22	5250	9	1	333	1
23	5250	9	1	333	1
24	5250	9	1	333	1
25	5250	9	1	333	1
26	5250	9	1	333	1
27	5250	9	1	333	1
28	5250	9	1	333	1
29	5250	9	1	333	1
30	5250	9	1	333	1
Detection Percentage (%)					96.667
Limit					70%
Test Result					Complied



Modulation Mode: 802.11ax (HEW160)

Type 1 Radar Statistical Performance

Trial #	Test Freq. (MHz)	Pulse Repetition Frequency Number	Pulse Repetition Frequency (Pulse Per Second)	PRI (us)	1=Detection 0=No Detection
1	5322	1	1930.5	518	1
2	5325	23	326.2	3066	1
3	5318	19	1139.0	878	1
4	5272	12	1355.0	738	1
5	5319	4	1730.1	578	1
6	5316	8	1519.8	658	1
7	5283	15	1253.1	798	0
8	5294	6	1618.1	618	1
9	5254	14	1285.3	778	1
10	5266	3	1792.1	558	1
11	5260	13	1319.3	758	0
12	5327	9	1474.9	678	1
13	5312	7	1567.4	638	1
14	5285	17	1193.3	838	1
15	5277	10	1432.7	698	0
16	5319	-	1692.0	591	1
17	5285	-	328.1	3048	1
18	5326	-	373.4	2678	1
19	5294	-	574.4	1741	1
20	5305	-	1216.5	822	1
21	5267	-	801.3	1248	1
22	5292	-	488.5	2047	1
23	5294	-	956.0	1046	1
24	5270	-	517.6	1932	1
25	5318	-	1422.5	703	1
26	5304	-	542.0	1845	1
27	5317	-	741.3	1349	1
28	5314	-	881.8	1134	1
29	5261	-	427.4	2340	1
30	5254	-	628.9	1590	1
Detection Percentage (%)					90.000
Limit					60%
Test Result					Complied



Type 2 Radar Statistical Performance

Trial #	Test Freq. (MHz)	Pulse Width (us)	PRI (us)	Pulses / Burst	1=Detection 0=No Detection
1	5309	2.6	221	23	1
2	5304	4.6	198	27	1
3	5304	1.1	184	29	1
4	5301	4.8	203	24	1
5	5325	2.4	162	25	1
6	5320	3.4	204	28	1
7	5313	2.3	170	27	1
8	5328	3.5	184	23	0
9	5328	4.9	150	27	1
10	5291	4.6	211	29	1
11	5294	2.9	158	23	1
12	5308	2.6	226	27	1
13	5304	1.6	204	26	1
14	5295	3.9	181	25	1
15	5327	4.6	202	24	1
16	5317	4.1	194	27	1
17	5322	2.3	193	28	1
18	5299	3.9	173	29	1
19	5324	4.3	188	23	0
20	5251	1.5	215	26	1
21	5318	4.9	227	27	1
22	5317	1.1	199	23	1
23	5312	4.5	155	29	0
24	5307	4.0	190	27	1
25	5298	2.4	151	23	1
26	5317	2.5	180	28	1
27	5318	2.5	228	23	1
28	5309	2.5	203	25	1
29	5324	1.5	188	25	1
30	5323	1.9	217	24	1
Detection Percentage (%)					90.000
Limit					60%
Test Result					Complied



Type 3 Radar Statistical Performance

Trial #	Test Freq. (MHz)	Pulse Width (us)	PRI (us)	Pulses / Burst	1=Detection 0=No Detection
1	5267	8.0	205	16	1
2	5271	6.7	382	18	1
3	5319	8.6	418	16	1
4	5309	9.4	351	17	1
5	5291	7.4	383	18	1
6	5288	9.8	232	16	1
7	5312	9.1	377	17	1
8	5290	9.6	457	16	0
9	5313	8.0	471	18	1
10	5328	9.0	304	18	1
11	5251	8.0	316	17	1
12	5263	9.8	325	16	1
13	5264	8.0	409	17	1
14	5274	9.9	200	17	1
15	5257	8.8	458	16	1
16	5307	8.0	232	18	1
17	5314	8.3	250	16	1
18	5270	8.7	270	16	1
19	5316	7.7	350	17	0
20	5277	7.1	230	16	1
21	5296	7.3	416	18	1
22	5324	7.6	498	18	1
23	5320	7.3	286	17	1
24	5275	7.3	287	16	1
25	5266	7.5	462	17	1
26	5308	6.2	300	17	1
27	5261	6.4	323	18	1
28	5262	7.1	420	16	1
29	5293	7.2	395	18	1
30	5263	8.4	377	16	1
Detection Percentage (%)					93.333
Limit					60%
Test Result					Complied



Type 4 Radar Statistical Performance

Trial #	Test Freq. (MHz)	Pulse Width (us)	PRI (us)	Pulses / Burst	1=Detection 0=No Detection
1	5292	18.0	242	15	1
2	5323	19.9	279	12	1
3	5300	12.9	487	14	1
4	5250	15.0	452	13	1
5	5280	16.3	230	12	1
6	5251	19.8	238	13	1
7	5279	18.2	420	16	1
8	5270	16.3	452	15	1
9	5324	14.2	495	12	1
10	5280	17.8	228	16	1
11	5315	19.1	211	16	1
12	5322	18.4	283	15	1
13	5282	11.8	411	12	1
14	5293	14.2	284	13	1
15	5284	13.9	202	12	1
16	5325	17.8	340	14	1
17	5254	15.6	290	16	1
18	5250	14.6	250	16	0
19	5275	14.4	484	15	1
20	5289	18.9	387	13	1
21	5275	11.1	348	15	1
22	5322	13.8	291	16	1
23	5270	14.3	295	12	1
24	5317	12.5	300	12	1
25	5264	12.5	322	14	1
26	5323	12.5	383	13	1
27	5305	15.7	322	16	1
28	5274	19.8	469	13	1
29	5295	18.6	406	15	1
30	5281	15.9	238	14	1
Detection Percentage (%)					96.667
Limit					60%
Test Result					Complied



Total Type 1~4 Radar Statistical Performance

Radar Type #	Detection Percentage (%)
1	90.000
2	90.000
3	93.333
4	96.667
Aggregate (Radar Types 1-4)	92.500
Limit	80%
Test Result	Complied



Type 5 Radar Statistical Performance

Center Freq. (MHz)	High Edge (MHz)	VSG Freq. (MHz)	Detection
5250	5329		
Trial	Offset		
1	2	5327	1
2	8	5321	1
3	2.8	5326	1
4	3.2	5326	1
5	3.6	5325	1
6	4	5325	1
7	4.4	5325	1
8	4.8	5324	1
9	5.2	5324	1
10	5.6	5323	1
11	6	5323	1
12	6.4	5323	1
13	6.8	5322	1
14	8	5321	1
15	7.6	5321	1
16	7.2	5322	1
17	6.8	5322	0
18	6.4	5323	1
19	6	5323	1
20	5.6	5323	1
21	5.2	5324	1
22	4.8	5324	1
23	4.4	5325	1
24	4	5325	1
25	3.6	5325	1
26	3.2	5326	1
27	7.2	5322	1
28	7.6	5321	1
29	8	5321	0
30	2	5327	1
Total			28
Detection Percentage (%)			93.333%
Limit			80%
Test Result			Complied



Trial Number							1
Number of Bursts in Trial							8
Chirp Center Frequency							5327
Burst	No. of Pulses	Pulse Width (us)	Chirp Width (MHz)	Pulse 1-to-2 Spacing (us)	Pulse 2-to-3 Spacing (us)	Starting Location Within Interval (ms)	
1	1	62.1	5	-	-	1091	
2	2	56	5	1729	-	133	
3	2	91.3	5	1230	-	1057	
4	3	50.7	5	1762	1616	1442	
5	2	92.6	5	1723	-	544	
6	2	87.3	5	1302	-	1089	
7	2	59.5	5	1291	-	1374	
8	2	52.2	5	1653	-	1237	
Detection Check (1=Detection; 0=No Detection)							1

Trial Number							2
Number of Bursts in Trial							9
Chirp Center Frequency							5321
Burst	No. of Pulses	Pulse Width (us)	Chirp Width (MHz)	Pulse 1-to-2 Spacing (us)	Pulse 2-to-3 Spacing (us)	Starting Location Within Interval (ms)	
1	3	90	20	1007	1326	30	
2	2	73.7	20	1785	-	979	
3	1	78.1	20	-	-	683	
4	2	92.4	20	1281	-	950	
5	1	61.2	20	-	-	612	
6	3	67.2	20	1525	1870	17	
7	1	78.5	20	-	-	429	
8	2	60.3	20	1931	-	936	
9	3	92.9	20	1403	1476	548	
Detection Check (1=Detection; 0=No Detection)							1



Trial Number							3
Number of Bursts in Trial							10
Chirp Center Frequency							5326.2
Burst	No. of Pulses	Pulse Width (us)	Chirp Width (MHz)	Pulse 1-to-2 Spacing (us)	Pulse 2-to-3 Spacing (us)	Starting Location Within Interval (ms)	
1	3	63.4	7	1574	1607	801	
2	1	98	7	-	-	966	
3	1	58.7	7	-	-	185	
4	1	88	7	-	-	1012	
5	3	79.5	7	1562	1370	943	
6	3	57.1	7	1900	1188	686	
7	2	64.4	7	1090	-	599	
8	1	78.7	7	-	-	1089	
9	1	69.3	7	-	-	188	
10	3	55.3	7	1375	1691	933	
Detection Check (1=Detection; 0=No Detection)							1

Trial Number							4
Number of Bursts in Trial							11
Chirp Center Frequency							5325.8
Burst	No. of Pulses	Pulse Width (us)	Chirp Width (MHz)	Pulse 1-to-2 Spacing (us)	Pulse 2-to-3 Spacing (us)	Starting Location Within Interval (ms)	
1	2	74.3	8	1642	-	24	
2	1	83.1	8	-	-	985	
3	2	59.5	8	1680	-	988	
4	2	59.8	8	1786	-	800	
5	2	77.6	8	1617	-	339	
6	2	79.9	8	1553	-	1040	
7	1	56	8	-	-	544	
8	3	71.4	8	1406	1927	452	
9	1	97.4	8	-	-	204	
10	2	98.3	8	1037	-	926	
11	1	63.6	8	-	-	1052	
Detection Check (1=Detection; 0=No Detection)							1



Trial Number							5
Number of Bursts in Trial							12
Chirp Center Frequency							5325.4
Burst	No. of Pulses	Pulse Width (us)	Chirp Width (MHz)	Pulse 1-to-2 Spacing (us)	Pulse 2-to-3 Spacing (us)	Starting Location Within Interval (ms)	
1	1	50	9	-	-	557	
2	2	62.5	9	1731	-	567	
3	2	55.4	9	1070	-	460	
4	1	65.7	9	-	-	4	
5	2	58	9	1512	-	64	
6	2	60.9	9	1230	-	650	
7	3	89.6	9	1598	1738	235	
8	3	84.4	9	1271	1617	873	
9	3	72.3	9	1498	1321	901	
10	1	58.9	9	-	-	663	
11	2	74.8	9	1584	-	919	
12	1	71.8	9	-	-	375	
Detection Check (1=Detection; 0=No Detection)							1

Trial Number							6
Number of Bursts in Trial							13
Chirp Center Frequency							5325
Burst	No. of Pulses	Pulse Width (us)	Chirp Width (MHz)	Pulse 1-to-2 Spacing (us)	Pulse 2-to-3 Spacing (us)	Starting Location Within Interval (ms)	
1	2	88.1	10	1257	-	846	
2	1	58.7	10	-	-	725	
3	2	97.1	10	1037	-	30	
4	3	83.1	10	1029	1106	490	
5	1	62.1	10	-	-	262	
6	2	71.4	10	1058	-	283	
7	2	86.3	10	1867	-	49	
8	3	77.3	10	1418	1876	634	
9	1	78.9	10	-	-	304	
10	3	79.2	10	1055	1572	564	
11	3	52	10	1582	1836	852	
12	3	56.5	10	1195	1542	525	
13	3	100	10	1638	1729	750	
Detection Check (1=Detection; 0=No Detection)							1



Trial Number							7
Number of Bursts in Trial							14
Chirp Center Frequency							5324.6
Burst	No. of Pulses	Pulse Width (us)	Chirp Width (MHz)	Pulse 1-to-2 Spacing (us)	Pulse 2-to-3 Spacing (us)	Starting Location Within Interval (ms)	
1	2	92.7	11	1208	-	231	
2	2	81.3	11	1144	-	804	
3	2	60.4	11	1555	-	34	
4	2	62.1	11	1320	-	427	
5	1	50	11	-	-	577	
6	3	65.9	11	1020	1365	3	
7	2	73.8	11	1308	-	51	
8	2	74.3	11	1143	-	360	
9	1	62.9	11	-	-	394	
10	2	74.8	11	1404	-	317	
11	2	69.7	11	1309	-	532	
12	2	69.8	11	1688	-	339	
13	2	77.4	11	1857	-	381	
14	1	55.1	11	-	-	426	
Detection Check (1=Detection; 0=No Detection)							1

Trial Number							8
Number of Bursts in Trial							15
Chirp Center Frequency							5324.2
Burst	No. of Pulses	Pulse Width (us)	Chirp Width (MHz)	Pulse 1-to-2 Spacing (us)	Pulse 2-to-3 Spacing (us)	Starting Location Within Interval (ms)	
1	1	91.7	12	-	-	776	
2	2	90	12	1196	-	187	
3	3	92.3	12	1486	1853	448	
4	2	66.8	12	1545	-	702	
5	1	64	12	-	-	403	
6	3	95.4	12	1123	1473	230	
7	3	66.8	12	1867	1401	604	
8	3	67.7	12	1472	1397	38	
9	1	68.2	12	-	-	735	
10	2	82.2	12	1297	-	610	
11	1	92.1	12	-	-	618	
12	2	57	12	1764	-	705	
13	2	58.5	12	1310	-	22	
14	3	85.5	12	1630	1447	641	
15	2	82.2	12	1371	-	109	
Detection Check (1=Detection; 0=No Detection)							1



Trial Number			9			
Number of Bursts in Trial			16			
Chirp Center Frequency			5323.8			
Burst	No. of Pulses	Pulse Width (us)	Chirp Width (MHz)	Pulse 1-to-2 Spacing (us)	Pulse 2-to-3 Spacing (us)	Starting Location Within Interval (ms)
1	2	74.4	13	1707	-	442
2	2	63.6	13	1725	-	280
3	2	71.3	13	1704	-	459
4	3	77.6	13	1063	1405	197
5	3	65.2	13	1731	1294	101
6	3	55.1	13	1109	1549	17
7	2	96.8	13	1034	-	131
8	3	80.8	13	1533	1051	365
9	1	60.4	13	-	-	222
10	2	61.8	13	1312	-	371
11	2	71.3	13	1657	-	33
12	2	98.1	13	1024	-	291
13	1	57.9	13	-	-	188
14	1	91.8	13	-	-	163
15	2	56.7	13	1259	-	426
16	2	89.7	13	1690	-	606
Detection Check (1=Detection; 0=No Detection)						1



Trial Number			10			
Number of Bursts in Trial			17			
Chirp Center Frequency			5323.4			
Burst	No. of Pulses	Pulse Width (us)	Chirp Width (MHz)	Pulse 1-to-2 Spacing (us)	Pulse 2-to-3 Spacing (us)	Starting Location Within Interval (ms)
1	2	74.4	14	1107	-	462
2	1	87.6	14	-	-	653
3	2	61.7	14	1741	-	457
4	2	57.5	14	1566	-	388
5	2	66.1	14	1855	-	63
6	3	70.1	14	1044	1012	136
7	1	66.4	14	-	-	343
8	1	59.2	14	-	-	349
9	2	88.3	14	1240	-	362
10	1	64.7	14	-	-	221
11	2	73	14	1703	-	144
12	2	81.7	14	1450	-	671
13	3	70.1	14	1741	1278	320
14	1	63.6	14	-	-	196
15	1	58.7	14	-	-	413
16	2	65.9	14	1478	-	170
17	1	72.7	14	-	-	564
Detection Check (1=Detection; 0=No Detection)						1



Trial Number		11				
Number of Bursts in Trial		18				
Chirp Center Frequency		5323				
Burst	No. of Pulses	Pulse Width (us)	Chirp Width (MHz)	Pulse 1-to-2 Spacing (us)	Pulse 2-to-3 Spacing (us)	Starting Location Within Interval (ms)
1	2	72.1	15	1193	-	130
2	3	76.3	15	1484	1390	114
3	1	86.1	15	-	-	14
4	1	73.2	15	-	-	604
5	1	81.2	15	-	-	548
6	2	99.5	15	1398	-	173
7	1	93.9	15	-	-	262
8	2	75.9	15	1921	-	38
9	3	79.2	15	1100	1429	84
10	3	77	15	1166	1799	610
11	1	91.8	15	-	-	339
12	3	56.8	15	1330	1556	580
13	2	83.1	15	1556	-	295
14	2	63	15	1552	-	156
15	1	65.7	15	-	-	439
16	1	64.5	15	-	-	188
17	1	88.5	15	-	-	419
18	1	60.6	15	-	-	205
Detection Check (1=Detection; 0=No Detection)						1



Trial Number			12			
Number of Bursts in Trial			19			
Chirp Center Frequency			5323			
Burst	No. of Pulses	Pulse Width (us)	Chirp Width (MHz)	Pulse 1-to-2 Spacing (us)	Pulse 2-to-3 Spacing (us)	Starting Location Within Interval (ms)
1	2	90.5	16	1299	-	381
2	2	88.4	16	1418	-	327
3	2	53.7	16	1055	-	536
4	1	80.5	16	-	-	285
5	1	50.4	16	-	-	398
6	2	61.2	16	1749	-	439
7	2	78.8	16	1065	-	129
8	3	75	16	1748	1820	325
9	2	96.7	16	1254	-	440
10	3	76.3	16	1848	1106	397
11	1	73.3	16	-	-	232
12	2	92.4	16	1317	-	91
13	2	92.4	16	1854	-	256
14	3	64.4	16	1240	1634	582
15	2	67.3	16	1473	-	117
16	2	84.1	16	1795	-	202
17	1	80.9	16	-	-	135
18	1	74.6	16	-	-	396
19	2	97.6	16	1805	-	615
Detection Check (1=Detection; 0=No Detection)						1



Trial Number							13
Number of Bursts in Trial							20
Chirp Center Frequency							5322
Burst	No. of Pulses	Pulse Width (us)	Chirp Width (MHz)	Pulse 1-to-2 Spacing (us)	Pulse 2-to-3 Spacing (us)	Starting Location Within Interval (ms)	
1	2	66.1	17	1417	-	388	
2	2	86.7	17	1693	-	348	
3	2	70.5	17	1263	-	215	
4	2	78	17	1446	-	28	
5	2	66	17	1185	-	585	
6	2	80.6	17	1855	-	65	
7	1	95.5	17	-	-	92	
8	1	98.8	17	-	-	68	
9	3	64.3	17	1641	1108	517	
10	1	75.1	17	-	-	121	
11	2	72.6	17	1499	-	448	
12	1	60.3	17	-	-	567	
13	2	54.9	17	1056	-	245	
14	2	98.8	17	1023	-	584	
15	2	60.9	17	1243	-	579	
16	2	62.7	17	1226	-	464	
17	1	80.1	17	-	-	89	
18	2	70.9	17	1711	-	153	
19	1	90.7	17	-	-	282	
20	1	98.9	17	-	-	71	
Detection Check (1=Detection; 0=No Detection)							1

Trial Number							14
Number of Bursts in Trial							8
Chirp Center Frequency							5321
Burst	No. of Pulses	Pulse Width (us)	Chirp Width (MHz)	Pulse 1-to-2 Spacing (us)	Pulse 2-to-3 Spacing (us)	Starting Location Within Interval (ms)	
1	2	67.5	20	1542	-	947	
2	3	83.6	20	1272	1696	124	
3	2	93.2	20	1877	-	701	
4	1	55.6	20	-	-	1123	
5	3	84.2	20	1733	1619	756	
6	3	69.1	20	1612	1071	1	
7	2	66.9	20	1905	-	7	
8	3	86.8	20	1697	1621	1082	
Detection Check (1=Detection; 0=No Detection)							1



Trial Number							15
Number of Bursts in Trial							9
Chirp Center Frequency							5321
Burst	No. of Pulses	Pulse Width (us)	Chirp Width (MHz)	Pulse 1-to-2 Spacing (us)	Pulse 2-to-3 Spacing (us)	Starting Location Within Interval (ms)	
1	2	62.2	19	1571	-	949	
2	2	85	19	1669	-	189	
3	2	64.5	19	1505	-	176	
4	2	50.4	19	1325	-	538	
5	2	66.1	19	1483	-	908	
6	2	71.2	19	1110	-	1017	
7	3	53.7	19	1445	1677	492	
8	3	62.5	19	1596	1341	349	
9	3	62	19	1929	1221	1105	
Detection Check (1=Detection; 0=No Detection)							1

Trial Number							16
Number of Bursts in Trial							10
Chirp Center Frequency							5322
Burst	No. of Pulses	Pulse Width (us)	Chirp Width (MHz)	Pulse 1-to-2 Spacing (us)	Pulse 2-to-3 Spacing (us)	Starting Location Within Interval (ms)	
1	2	80.5	18	1910	-	284	
2	2	64.2	18	1661	-	751	
3	2	90.1	18	1041	-	491	
4	2	69.8	18	1495	-	107	
5	1	73.1	18	-	-	490	
6	3	77.2	18	1418	1145	1155	
7	3	52.6	18	1732	1787	772	
8	2	71.4	18	1562	-	121	
9	2	89.8	18	1491	-	89	
10	2	76.4	18	1355	-	615	
Detection Check (1=Detection; 0=No Detection)							1



Trial Number							17
Number of Bursts in Trial							11
Chirp Center Frequency							5322
Burst	No. of Pulses	Pulse Width (us)	Chirp Width (MHz)	Pulse 1-to-2 Spacing (us)	Pulse 2-to-3 Spacing (us)	Starting Location Within Interval (ms)	
1	2	51.2	17	1236	-	740	
2	1	71.7	17	-	-	941	
3	2	74.7	17	1164	-	370	
4	2	50.9	17	1919	-	371	
5	2	65.2	17	1206	-	1033	
6	2	98	17	1182	-	346	
7	2	58.7	17	1612	-	639	
8	1	63.8	17	-	-	1056	
9	3	86.3	17	1545	1065	205	
10	1	94.4	17	-	-	753	
11	3	88.5	17	1699	1319	58	
Detection Check (1=Detection; 0=No Detection)							0

Trial Number							18
Number of Bursts in Trial							12
Chirp Center Frequency							5323
Burst	No. of Pulses	Pulse Width (us)	Chirp Width (MHz)	Pulse 1-to-2 Spacing (us)	Pulse 2-to-3 Spacing (us)	Starting Location Within Interval (ms)	
1	2	88.7	16	1405	-	448	
2	3	90.2	16	1544	1235	621	
3	1	96.5	16	-	-	512	
4	2	80.5	16	1090	-	321	
5	2	63.7	16	1268	-	798	
6	1	53.4	16	-	-	809	
7	2	52.3	16	1043	-	301	
8	3	54.7	16	1701	1104	796	
9	3	75.6	16	1923	1729	669	
10	2	59.2	16	1244	-	369	
11	1	56.3	16	-	-	51	
12	2	87.8	16	1608	-	733	
Detection Check (1=Detection; 0=No Detection)							1



Trial Number							19
Number of Bursts in Trial							13
Chirp Center Frequency							5323
Burst	No. of Pulses	Pulse Width (us)	Chirp Width (MHz)	Pulse 1-to-2 Spacing (us)	Pulse 2-to-3 Spacing (us)	Starting Location Within Interval (ms)	
1	2	68.2	15	1104	-	229	
2	2	58.4	15	1627	-	488	
3	3	74.7	15	1861	1015	137	
4	2	58.2	15	1593	-	520	
5	1	51.6	15	-	-	799	
6	2	94.7	15	1469	-	43	
7	2	70.7	15	1091	-	126	
8	2	82.9	15	1472	-	607	
9	3	62.7	15	1168	1453	527	
10	2	63.1	15	1529	-	143	
11	1	96.1	15	-	-	176	
12	2	57	15	1457	-	882	
13	3	95.6	15	1707	1501	214	
Detection Check (1=Detection; 0=No Detection)							1

Trial Number							20
Number of Bursts in Trial							14
Chirp Center Frequency							5323
Burst	No. of Pulses	Pulse Width (us)	Chirp Width (MHz)	Pulse 1-to-2 Spacing (us)	Pulse 2-to-3 Spacing (us)	Starting Location Within Interval (ms)	
1	1	95.7	14	-	-	117	
2	1	93.1	14	-	-	720	
3	1	55.8	14	-	-	297	
4	1	76.7	14	-	-	284	
5	2	68	14	1686	-	472	
6	3	94.1	14	1796	1393	264	
7	2	53.9	14	1293	-	525	
8	1	99.3	14	-	-	155	
9	2	73.3	14	1458	-	65	
10	2	93.3	14	1196	-	451	
11	3	55.8	14	1895	1034	243	
12	1	66.4	14	-	-	228	
13	2	65.6	14	1732	-	746	
14	2	76.5	14	1187	-	522	
Detection Check (1=Detection; 0=No Detection)							1



Trial Number							21
Number of Bursts in Trial							15
Chirp Center Frequency							5324
Burst	No. of Pulses	Pulse Width (us)	Chirp Width (MHz)	Pulse 1-to-2 Spacing (us)	Pulse 2-to-3 Spacing (us)	Starting Location Within Interval (ms)	
1	1	85.1	13	-	-	565	
2	2	72.5	13	1648	-	211	
3	1	67.5	13	-	-	348	
4	2	56.1	13	1360	-	156	
5	1	71.1	13	-	-	718	
6	2	93.1	13	1391	-	400	
7	1	56.5	13	-	-	482	
8	1	63.8	13	-	-	703	
9	2	67.4	13	1727	-	780	
10	1	52.3	13	-	-	102	
11	3	62.4	13	1228	1715	304	
12	2	53.3	13	1630	-	57	
13	2	83.1	13	1205	-	768	
14	2	93.7	13	1085	-	461	
15	2	90.7	13	1297	-	746	
Detection Check (1=Detection; 0=No Detection)							1

Trial Number							22
Number of Bursts in Trial							16
Chirp Center Frequency							5324
Burst	No. of Pulses	Pulse Width (us)	Chirp Width (MHz)	Pulse 1-to-2 Spacing (us)	Pulse 2-to-3 Spacing (us)	Starting Location Within Interval (ms)	
1	2	98.8	12	1439	-	95	
2	1	54.5	12	-	-	676	
3	2	80.5	12	1360	-	8	
4	2	55.9	12	1906	-	373	
5	2	72.1	12	1623	-	254	
6	2	84.4	12	1604	-	480	
7	1	78.5	12	-	-	663	
8	1	88	12	-	-	314	
9	2	74.7	12	1157	-	596	
10	2	97.1	12	1673	-	264	
11	1	81.6	12	-	-	740	
12	1	83.6	12	-	-	163	
13	3	87.6	12	1757	1322	628	
14	2	58.5	12	1372	-	132	
15	3	91.8	12	1767	1183	106	
16	2	58.8	12	1432	-	659	
Detection Check (1=Detection; 0=No Detection)							1



Trial Number			23			
Number of Bursts in Trial			17			
Chirp Center Frequency			5325			
Burst	No. of Pulses	Pulse Width (us)	Chirp Width (MHz)	Pulse 1-to-2 Spacing (us)	Pulse 2-to-3 Spacing (us)	Starting Location Within Interval (ms)
1	1	96	11	-	-	284
2	2	92.5	11	1241	-	488
3	2	89.5	11	1347	-	76
4	2	74.8	11	1607	-	688
5	2	60.6	11	1523	-	28
6	2	71.5	11	1659	-	383
7	2	71.1	11	1454	-	182
8	1	98.7	11	-	-	20
9	2	85.1	11	1770	-	576
10	2	89.2	11	1086	-	410
11	2	60.7	11	1101	-	458
12	2	75.2	11	1719	-	348
13	2	75.7	11	1799	-	481
14	3	56.7	11	1132	1884	587
15	2	65	11	1885	-	480
16	2	64.6	11	1910	-	195
17	3	69.9	11	1410	1190	396
Detection Check (1=Detection; 0=No Detection)						1



Trial Number			24			
Number of Bursts in Trial			18			
Chirp Center Frequency			5325			
Burst	No. of Pulses	Pulse Width (us)	Chirp Width (MHz)	Pulse 1-to-2 Spacing (us)	Pulse 2-to-3 Spacing (us)	Starting Location Within Interval (ms)
1	3	83.8	10	1290	1021	536
2	2	66.9	10	1112	-	44
3	3	91	10	1220	1504	611
4	2	86.1	10	1678	-	456
5	3	65.5	10	1928	1222	330
6	1	62.6	10	-	-	297
7	3	68.7	10	1505	1200	351
8	3	59.2	10	1452	1114	230
9	1	73.9	10	-	-	222
10	1	77.2	10	-	-	57
11	2	96.4	10	1357	-	399
12	2	99.9	10	1173	-	299
13	2	99.9	10	1520	-	464
14	1	86.7	10	-	-	294
15	1	92.6	10	-	-	653
16	1	77.1	10	-	-	550
17	2	81.1	10	1664	-	566
18	3	68.4	10	1536	1309	580
Detection Check (1=Detection; 0=No Detection)						1



Trial Number			25			
Number of Bursts in Trial			19			
Chirp Center Frequency			5325			
Burst	No. of Pulses	Pulse Width (us)	Chirp Width (MHz)	Pulse 1-to-2 Spacing (us)	Pulse 2-to-3 Spacing (us)	Starting Location Within Interval (ms)
1	3	68.2	9	1723	1868	471
2	3	83.7	9	1711	1405	368
3	2	69.7	9	1781	-	425
4	1	59.7	9	-	-	440
5	2	96.7	9	1484	-	123
6	2	95.8	9	1319	-	261
7	3	71.3	9	1095	1354	332
8	3	53.2	9	1527	1427	427
9	2	69.5	9	1771	-	397
10	3	63.9	9	1075	1447	67
11	2	93.4	9	1783	-	174
12	2	77.3	9	1564	-	17
13	2	73.1	9	1294	-	216
14	1	77.4	9	-	-	292
15	3	57.2	9	1722	1886	619
16	2	68.7	9	1629	-	233
17	1	60.8	9	-	-	226
18	3	69.7	9	1128	1224	599
19	1	62.2	9	-	-	433
Detection Check (1=Detection; 0=No Detection)						1



Trial Number							26
Number of Bursts in Trial							20
Chirp Center Frequency							5326
Burst	No. of Pulses	Pulse Width (us)	Chirp Width (MHz)	Pulse 1-to-2 Spacing (us)	Pulse 2-to-3 Spacing (us)	Starting Location Within Interval (ms)	
1	1	80.5	8	-	-	90	
2	3	62.6	8	1406	1343	319	
3	3	85.6	8	1190	1529	384	
4	2	83.9	8	1208	-	567	
5	2	92.4	8	1488	-	234	
6	2	54	8	1529	-	535	
7	3	81.3	8	1501	1812	325	
8	1	98.5	8	-	-	532	
9	1	85.8	8	-	-	272	
10	2	84.7	8	1593	-	182	
11	2	83.3	8	1705	-	134	
12	2	79.8	8	1567	-	286	
13	1	77.9	8	-	-	368	
14	3	98.4	8	1510	1569	290	
15	2	79.9	8	1588	-	231	
16	3	78	8	1140	1353	353	
17	3	55.2	8	1700	1327	53	
18	3	71.9	8	1081	1224	44	
19	1	62	8	-	-	298	
20	3	70.5	8	1888	1442	529	
Detection Check (1=Detection; 0=No Detection)							1

Trial Number							27
Number of Bursts in Trial							8
Chirp Center Frequency							5322
Burst	No. of Pulses	Pulse Width (us)	Chirp Width (MHz)	Pulse 1-to-2 Spacing (us)	Pulse 2-to-3 Spacing (us)	Starting Location Within Interval (ms)	
1	2	69.1	18	1076	-	1436	
2	2	62.1	18	1688	-	22	
3	2	94.8	18	1891	-	897	
4	1	75.8	18	-	-	1186	
5	2	65.4	18	1713	-	589	
6	2	97.7	18	1292	-	614	
7	3	98.1	18	1670	1711	506	
8	2	85.4	18	1672	-	776	
Detection Check (1=Detection; 0=No Detection)							1



Trial Number							28
Number of Bursts in Trial							9
Chirp Center Frequency							5321
Burst	No. of Pulses	Pulse Width (us)	Chirp Width (MHz)	Pulse 1-to-2 Spacing (us)	Pulse 2-to-3 Spacing (us)	Starting Location Within Interval (ms)	
1	3	82	19	1233	1713	679	
2	3	87.7	19	1554	1123	473	
3	2	98.9	19	1518	-	869	
4	1	55	19	-	-	719	
5	1	93.6	19	-	-	902	
6	2	58.7	19	1641	-	1243	
7	2	88.7	19	1387	-	410	
8	1	60.3	19	-	-	1154	
9	1	97.7	19	-	-	512	
Detection Check (1=Detection; 0=No Detection)							1

Trial Number							29
Number of Bursts in Trial							10
Chirp Center Frequency							5321
Burst	No. of Pulses	Pulse Width (us)	Chirp Width (MHz)	Pulse 1-to-2 Spacing (us)	Pulse 2-to-3 Spacing (us)	Starting Location Within Interval (ms)	
1	1	69.6	20	-	-	1131	
2	1	74.5	20	-	-	290	
3	1	60.9	20	-	-	895	
4	1	74.6	20	-	-	202	
5	2	99.3	20	1501	-	139	
6	2	95.3	20	1065	-	854	
7	2	91.9	20	1722	-	219	
8	2	51	20	1285	-	57	
9	2	87.7	20	1747	-	141	
10	1	87.2	20	-	-	596	
Detection Check (1=Detection; 0=No Detection)							0



Trial Number		30				
Number of Bursts in Trial		11				
Chirp Center Frequency		5327				
Burst	No. of Pulses	Pulse Width (us)	Chirp Width (MHz)	Pulse 1-to-2 Spacing (us)	Pulse 2-to-3 Spacing (us)	Starting Location Within Interval (ms)
1	3	59.9	5	1901	1196	935
2	2	77.1	5	1590	-	1038
3	2	62.7	5	1227	-	690
4	1	77.1	5	-	-	547
5	3	99.8	5	1798	1790	551
6	2	61.5	5	1135	-	876
7	2	77.5	5	1583	-	448
8	2	57.3	5	1890	-	736
9	2	53.5	5	1757	-	362
10	1	66.6	5	-	-	836
11	3	80.7	5	1811	1289	410
Detection Check (1=Detection; 0=No Detection)						1



Type 6 Radar Statistical Performance

Trial #	Test Freq. (MHz)	Pulses / Hop	Pulse Width (us)	PRI (us)	1=Detection 0=No Detection
1	5250	9	1	333	1
2	5250	9	1	333	1
3	5250	9	1	333	1
4	5250	9	1	333	1
5	5250	9	1	333	1
6	5250	9	1	333	1
7	5250	9	1	333	1
8	5250	9	1	333	1
9	5250	9	1	333	1
10	5250	9	1	333	1
11	5250	9	1	333	1
12	5250	9	1	333	1
13	5250	9	1	333	1
14	5250	9	1	333	1
15	5250	9	1	333	1
16	5250	9	1	333	1
17	5250	9	1	333	1
18	5250	9	1	333	1
19	5250	9	1	333	1
20	5250	9	1	333	0
21	5250	9	1	333	1
22	5250	9	1	333	1
23	5250	9	1	333	1
24	5250	9	1	333	1
25	5250	9	1	333	1
26	5250	9	1	333	1
27	5250	9	1	333	1
28	5250	9	1	333	1
29	5250	9	1	333	1
30	5250	9	1	333	1
Detection Percentage (%)					96.667
Limit					70%
Test Result					Complied



4 Test Equipment and Calibration Data

Instrument	Manufacturer	Model No.	Serial No.	Characteristics	Calibration Date	Calibration Due Date	Remark
Spectrum Analyzer	R&S	FSV40	101026	9kHz~40GHz	Sep. 28, 2018	Sep. 27, 2019	Radiated (DF02-CB)
Vector Signal generator	R&S	SMU200A	105352	25MHz-6GHz	Nov. 01, 2018	Oct. 31, 2019	Radiated (DF02-CB)
Horn Antenna	SCHWARZBECK	BBHA 9120 D	BBHA 9120 D 1370	1GHz~18GHz	Jun. 03, 2019	Jun. 02, 2020	Radiated (DF02-CB)
Horn Antenna	COM-POWER	AH-118	071028	1GHz ~ 18GHz	Jun. 21, 2019	Jun. 20, 2020	Radiated (DF02-CB)
RF Power Divider	Woken	2 Way	DFS02-DV-01	2GHz ~ 18GHz	Oct. 08, 2018	Oct. 07, 2019	Radiated (DF02-CB)
RF Power Divider	Woken	2Way	DFS02-DV-03	2GHz ~ 18GHz	Oct. 08, 2018	Oct. 07, 2019	Radiated (DF02-CB)
RF Power Divider	Woken	4 Way	DFS02-DV-02	2GHz ~ 18GHz	Oct. 08, 2018	Oct. 07, 2019	Radiated (DF02-CB)
RF Cable-high	Woken	RG402	High Cable-64	1 GHz – 18 GHz	Oct. 08, 2018	Oct. 07, 2019	Radiated (DF02-CB)
RF Cable-high	Woken	RG402	High Cable-65	1 GHz – 18 GHz	Oct. 08, 2018	Oct. 07, 2019	Radiated (DF02-CB)

Note: Calibration Interval of instruments listed above is one year.



5 Measurement Uncertainty

Test Items	Uncertainty	Remark
Radiated Emission	3.4 dB	Confidence levels of 95%

Appendix A. Dynamic In-Service Monitoring Test (Zero-Wait CAC)

1. Dynamic In-Service Monitoring (Zero-Wait CAC)

1.1. Measuring Instruments

Refer a test equipment and calibration data table in this test report.

1.2. Test Procedure

Pre-clearing a DFS channel for zero time switching from a non-DFS channel

Before the operation channel moves from non-DFS channels to DFS channels for zero time switching, one minute CAC should be performed on the targeted switching channel to make sure no radar presence. When CAC completed with no radar presence, channel move to targeted channel immediately. If radar detected at any time during CAC, EUT stays on the original non-DFS channel.

1.3. Test Setup

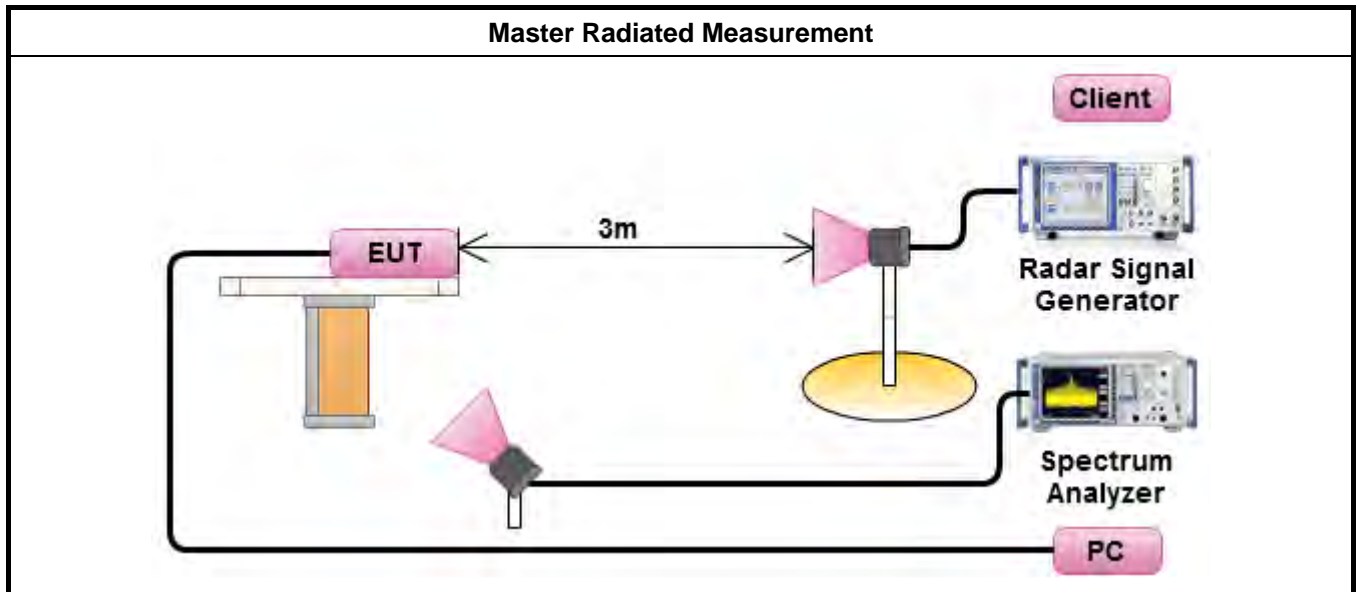

Test Channel Frequencies Configuration	
IEEE Std.	Test Channel Freq. (MHz)
802.11ac (VHT80)	5290 MHz

1.4. Test Result of Dynamic In-Service Monitoring

Dynamic In-Service Monitoring Test Result						
Detection Threshold Level (dBm)			-63			
Modulation Mode	Operation Freq.(MHz)	Targeted Channel Freq.(MHz)	Radar Test Signal (#)	Nr of Times Triggered (# out of 20)	Detection Probability (%)	Detection Probability Limit (%)
802.11ac (VHT80)	5210	5290	0	19	95%	60

Initial CAC – Zero Wait

Modulation Mode	Zero-Wait Freq.	Radar Type
802.11ac (VHT80)	5290 MHz	0

The EUT does not transmit any beacon or data transmissions until at least 1 minute after the completion of the power-on cycle (0.435 sec). The initial CAC time of the EUT is indicated by marker 1 (0.435 sec). Initial beacons/data transmissions are indicated by marker 2 (60.435 sec).

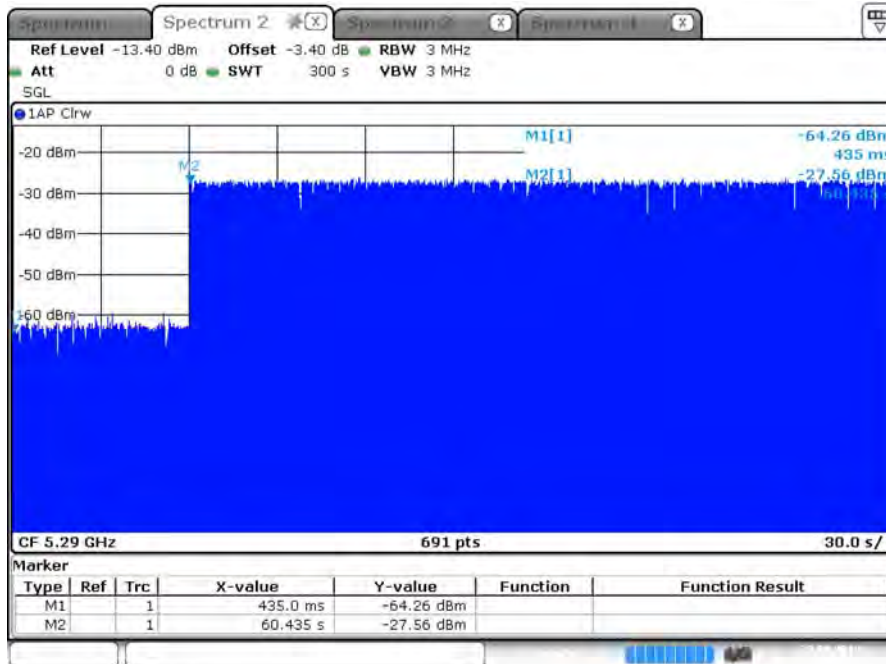

Date: 23 AUG 2019 15:05:23

Begin CAC – Zero Wait

Modulation Mode	Zero-Wait Freq.	Radar Type
802.11ac (VHT80)	5290 MHz	0

Visual indication on the EUT of successful detection of the radar Burst will be recorded and reported. Observation of emissions will continue for 297.391 seconds after the radar Burst has been generated. Verify that during the 300 seconds measurement window no EUT transmissions occurred.

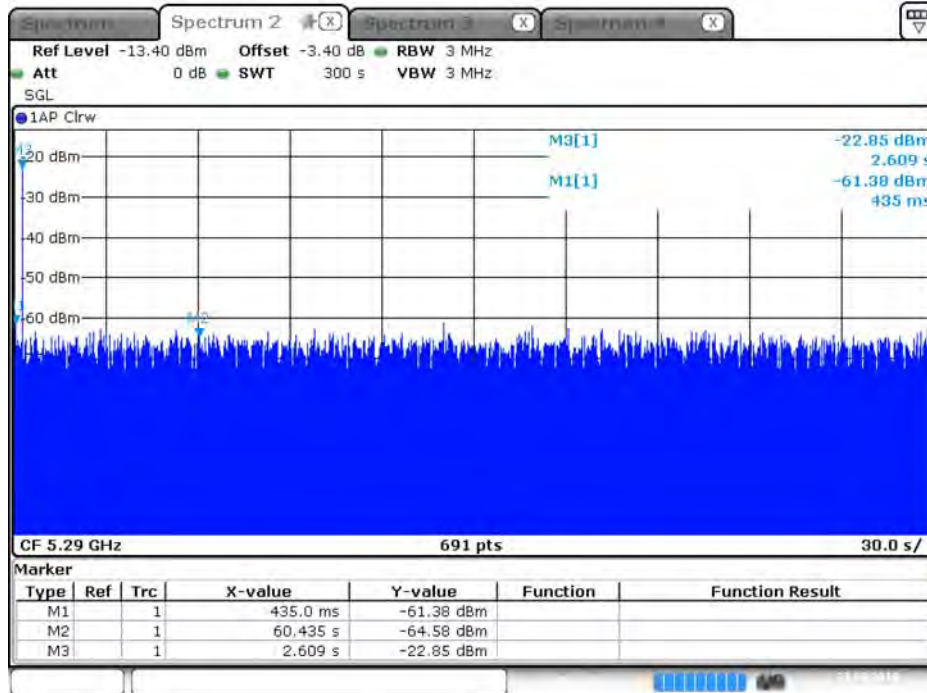

Date: 23.AUG.2019 15:43:33

End CAC – Zero Wait

Modulation Mode	Zero-Wait Freq.	Radar Type
802.11ac (VHT80)	5290 MHz	0

Visual indication on the EUT of successful detection of the radar Burst will be recorded and reported. Observation of emissions will continue for 241.304 seconds after the radar Burst has been generated. Verify that during the 300 seconds measurement window no EUT transmissions occurred.

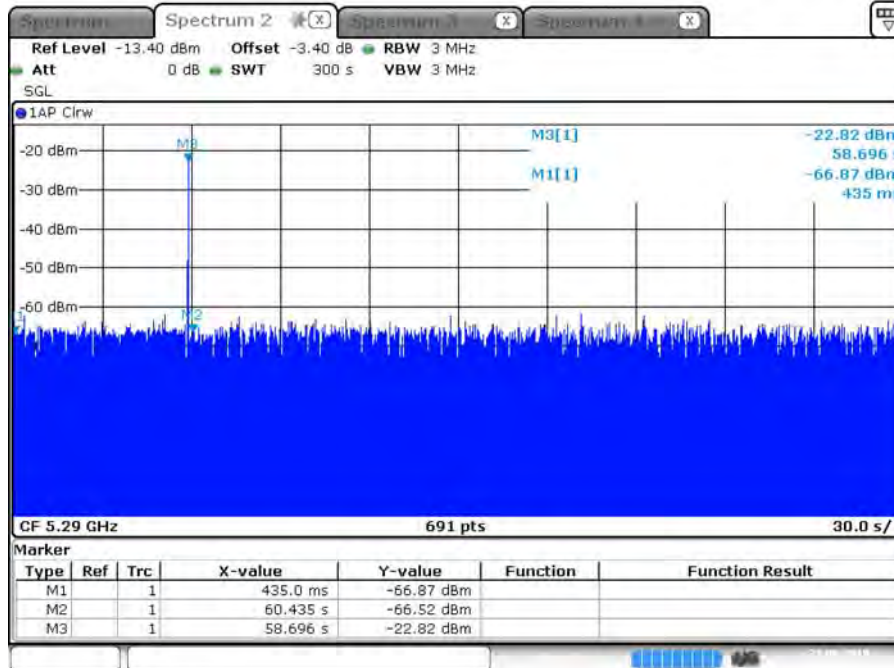

Date: 23.AUG.2019 15:52:47