



A Test Lab Techno Corp.

Changan Lab : No. 140 -1, Changan Street, Bade City, Taoyuan County, Taiwan R.O.C.
Tel : 886-3-271-0188 / Fax : 886-3-271-0190

P22 & P24 Test Report



Test Report No.	: 0810FR11
Applicant	: XAC Automation Corporation
Manufacturer	: XAC Automation Corporation
Model Name	: Portable Terminal
Trade Mark	: FDC
Model Number	: FD-400
FCC ID	: MQT-FD400
Dates of Test	: Oct. 14 ~ Oct. 22, 2008
Test Specification	: 47 CFR Part 22H, 24E & and 24, ANSI/TIA-603-C-2004
Location of Test Lab.	: Chang-an Lab.

1. The test operations have to be performed with cautious behavior, the test results are as attached.
2. The test results are under chamber environment of A Test Lab Techno Corp. A Test Lab Techno Corp. does not assume responsibility for any conclusions and generalizations drawn from the test results with regard to other specimens or samples.
3. The measurement report has to be written approval of A Test Lab Techno Corp. It may only be reproduced or published in full.

Country Huang 20081023

Measurement Center Manager

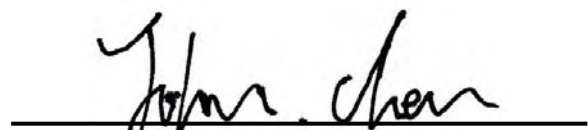
John Cheng 20081023

Testing Engineer



Contents

1. General Information	3
2. Test Configuration of Equipment under Test	5
2.1 Test Manner.....	5
2.2 Test Mode.....	5
2.3 Connection Diagram of Test System	7
2.4 Ancillary Equipment List.....	7
3. General Information of Test Site.....	8
3.1 Test Voltage.....	8
3.2 Test in Compliance with.....	8
3.3 Frequency Range Investigated	8
3.4 Test Distance.....	8
4. Test Data and Test Result.....	9
4.1 List of Measurements and Examinations	9
4.2 RF Output Power.....	10
4.3 ERP / EIRP Measurement.....	13
4.4 Occupied Bandwidth and Band Edge Measurement.....	20
4.5 Conducted Emission	46
4.6 Field Strength of Spurious Radiation	52
4.7 Frequency Stability (Temperature Variation)	78
4.8 Frequency Stability (Voltage Variation).....	81
4.9 AC Power Conducted Emissions Requirements	83
5. List of Measurement Equipments.....	91
6. Uncertainty Evaluation	92



1. General Information

Applicant :

XAC Automation Corporation

4F., NO.30, INDUSTRY E. RD. IX, SCIENCE-BASED INDUSTRIAL PARK, HSIN-CHU, Taiwan, R.O.C.

Manufacturer	: XAC Automation Corporation 4F., NO.30, INDUSTRY E. RD. IX, SCIENCE-BASED INDUSTRIAL PARK, HSIN-CHU, Taiwan, R.O.C
Product Name	: Portable Terminal
Trade Mark	: FDC
Model Number	: FD-400
FCC ID	: MQT-FD400
IMEI No	: 352678014485913
Hardware Version	: B06
Software Version	: 1109
Antenna Type	: Internal Antenna
Antenna Gain	: 1.0 dBi
TX Frequency	: 824 - 849 MHz (GSM 850) 1850 - 1910 MHz (PCS 1900) 826 - 847 MHz (WCDMA Band V) 1852 - 1908 MHz (WCDMA Band II)
RX Frequency	: 869 - 894 MHz (GSM 850) 1930 - 1990 MHz (PCS 1900) 871 - 892 MHz (WCDMA Band V) 1932 - 1988 MHz (WCDMA Band II)



Maximum Output Power to Antenna	: 30.96	dBm	(GPRS/EGPRS 850)
(Conducted)	27.60	dBm	(GPRS/EGPRS 1900)
	26.82	dBm	(WCDMA /HSDPA Band V)
	26.91	dBm	(WCDMA/HSDPA Band II)
Max. ERP/EIRP Power	: 1.299 W / 31.14	dBm ERP	(GPRS 850)
	0.370 W / 25.68	dBm ERP	(EGPRS 850)
	1.302 W / 31.15	dBm EIRP	(GPRS 1900)
	0.572 W / 27.58	dBm EIRP	(EGPRS 1900)
	0.312 W / 24.94	dBm ERP	(WCDMA Band V)
	0.401 W / 26.03	dBm EIRP	(WCDMA Band II)
Type of Emission	: GPRS 850	: 244KGXW	
	EGPRS 850	: 258KG7W	
	GPRS 1900	: 245KGXW	
	EGPRS 1900	: 257KG7W	
	WCDMA Band V	: 4M15F9W	
	WCDMA Band II	: 4M15F9W	
Power Rating (DC , Voltage and Current of RF element or PA)	: 12Vdc / 3.33A		
Digital Modulation Emission	: GMSK(GSM 850 / PCS1900)		
	QPSK(WCDMA Band V / WCDMA Band II)		
Power Supply Type	: AC Adapter		
DC Power Cord	: 1.8 meter, Cigarette Plug		
Adapter	: LI SHIN INTERNATIONAL ENTERPRISE COPR. / LSE0107A1240		
DUT Stage	: Production Unit		



2. Test Configuration of Equipment under Test

2.1 Test Manner

1. The spurious emission measurements were carried out in semi-anechoic chamber with 3-meter test range.
2. During all testing, EUT is in link mode with base station emulator at maximum power level. (PCL=5 for GSM 850 or PCL=0 for PCS 1900)
3. Frequency range investigated: radiated emission 30 MHz to 9000 MHz for GSM850; 30MHz to 19000 MHz for PCS 1900.

2.2 Test Mode

Preliminary tests were performed in different data mode to find the worst case. The data mode shown in the table below is the worst-case rate (Blue color). Investigation has been done on all the possible configurations for searching the worst cases. The following table is a list of the test modes shown in this test report.

Output power (Peak Power)					
Channel		Frequency (MHz)	Conducted Power (dBm)	Worst Case	
GPRS 850	Lowest 128	824.20	30.95	<input type="checkbox"/>	
	Middle 190	836.40	30.96	<input checked="" type="checkbox"/>	
	Highest 251	848.80	30.90	<input type="checkbox"/>	
EGPRS 850	3Down2Up	Lowest 128	26.25	<input type="checkbox"/>	
		Middle 190	26.21	<input type="checkbox"/>	
		Highest 251	26.09	<input type="checkbox"/>	



Output power (Peak Power)						
Channel		Frequency (MHz)		Conducted Power (dBm)	Worst Case	
GPRS 1900	Lowest	512	1850.20	27.60	■	
	Middle	661	1880.00	27.51	□	
	Highest	810	1909.80	27.45	□	
EGPRS 19050	3Down2Up	Lowest	512	1850.20	27.51	□
		Middle	661	1880.00	27.45	□
		Highest	810	1909.80	24.90	□

Output power (Peak Power)					
Channel		Frequency (MHz)		Conducted Power (dBm)	Worst Case
WCDMA Band V	Lowest	4132	826.40	26.00	□
	Middle	4182	836.40	26.25	□
	Highest	4233	846.40	26.02	□
HSDPA Band V	Lowest	4132	826.40	26.57	□
	Middle	4182	836.40	26.82	■
	Highest	4233	846.40	26.60	□

Output power (Peak Power)					
Channel		Frequency (MHz)		Conducted Power (dBm)	Worst Case
WCDMA Band II	Lowest	9262	1852.40	25.60	□
	Middle	9400	1880.00	26.41	□
	Highest	9538	1907.60	25.55	□
HSDPA Band II	Lowest	9262	1852.40	26.13	□
	Middle	9400	1880.00	26.91	■
	Highest	9538	1907.60	26.60	□

2.3 Connection Diagram of Test System

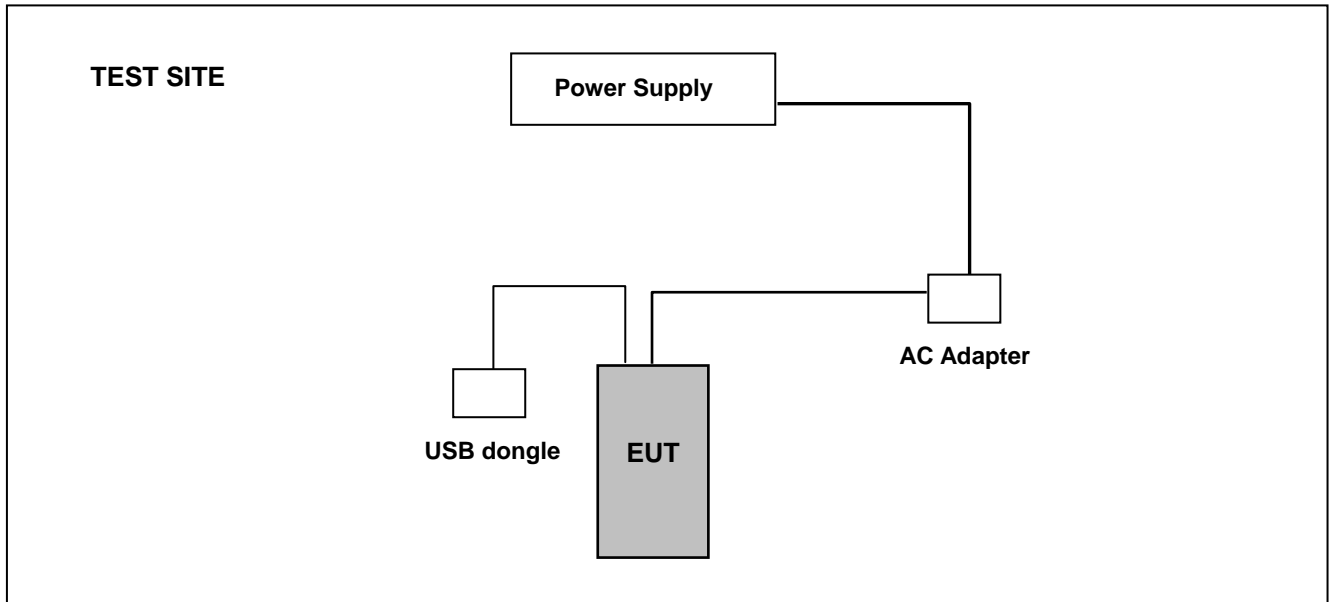

During EMI testing (LINK) the EUT (Portable Terminal)'s Power port was connected to AC Adapter. EUT (Portable Terminal)'s USB port connected to USB dongle.

2.4 Ancillary Equipment List

1. Base Station(R&S) CMU200 106656
2. Power Supply (GW) 12P3A H281001



3. General Information of Test Site

Test Site Location: No. 140 -1, Changan Street, Bade City, Taoyuan County, Taiwan R.O.C.
TEL: 886-3-271-0188 FAX: 886-3-271-0190

Registration Number : 854525
Designation Number : TW1330

The chamber meets the characteristics of ANSI C63.4-2006. This site is on file with the FCC.

3.1 Test Voltage

DC 12 Vdc / 3.33 A

3.2 Test in Compliance with

47 CFR Part 22H, 24E and Part 2. and 24, ANSI/TIA-603-C-2004

3.3 Frequency Range Investigated

1. Radiation: from 30 MHz to 9000 MHz for GSM 850.
2. Radiation: from 30 MHz to 19000 MHz for PCS 1900.
3. Radiation: from 30 MHz to 9000 MHz for WCDMA Band V.
4. Radiation: from 30 MHz to 19000 MHz for WCDMA Band II.

3.4 Test Distance

The test distance of radiated emission from antenna to EUT is 3 m.



4. Test Data and Test Result

4.1 List of Measurements and Examinations

FCC Rule	DESCRIPTION OF TEST	Result	Section
§ 2.1046	RF Output Power	Passed	4.2
§ 22.913 § 24.232	ERP / EIRP	Passed	4.3
§ 2.1049 § 22.917 § 24.238(b)	Occupied Bandwidth & Band Edge Measurement	Passed	4.4
§ 2.1051	Conducted Emission	Passed	4.5
§ 2.1053	Field Strength of Spurious Radiation	Passed	4.6
§ 2.1055 § 22.355 § 24.235	Frequency Stability vs. Temperature	Passed	4.7
§ 2.1055 § 22.355 § 24.235	Frequency Stability vs. Voltage	Passed	4.8
§ 15.207	AC Power Conducted Emissions Requirements	Passed	4.9

4.2 RF Output Power

4.2.1 Measurement Instruments :

As described in chapter 5 of this test report.

4.2.2 Test Procedure :

The measurement is made according to ANSI/TIA-603-C-2004 as follows:

1. The transmitter output was connected to power meter and base station through power divider.
2. Set base station for EUT at GSM 850: PCL=5 and PCS 1900: PCL=0.
3. Set base station for EUT at WCDMA Band V and WCDMA Band II, power level was set to maximum.
4. Select lowest, middle, and highest channels for each band.

4.2.3 Test Setup Layout :

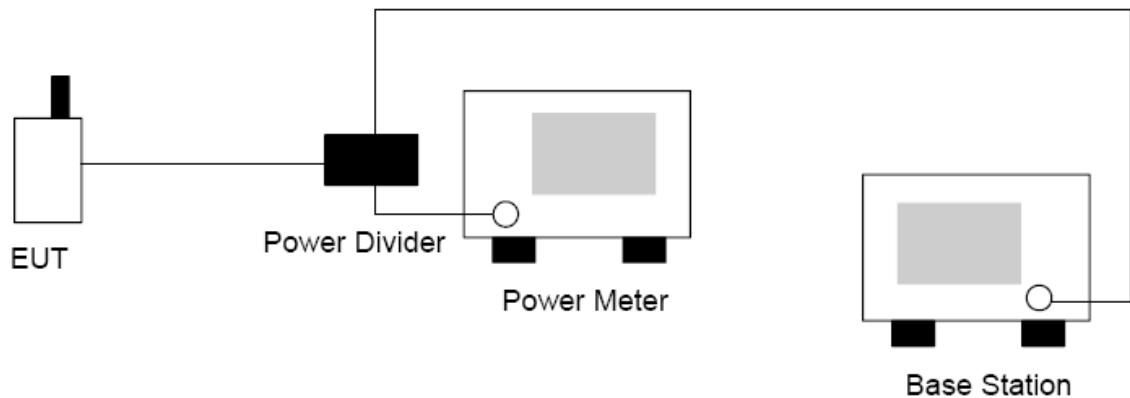



4.2.4 Test Result :

Bands	Channel	Frequency (MHz)		Conducted Power (dBm)	Conducted Power (Watts)
GPRS 850	128	Low	824.2	30.95	1.245
	190	Mid	836.4	30.96	1.247
	251	High	848.8	30.90	1.230

Note: The testing result was used peak detector.

Bands	Channel	Frequency (MHz)		Conducted Power (dBm)	Conducted Power (Watts)
EGPRS 850	128	Low	824.2	26.25	0.422
	190	Mid	836.4	26.21	0.418
	251	High	848.8	26.09	0.406

Note: The testing result was used peak detector.

Bands	Channel	Frequency (MHz)		Conducted Power (dBm)	Conducted Power (Watts)
PCS 1900	512	Low	1850.2	27.60	0.575
	661	Mid	1880.0	27.51	0.564
	810	High	1909.8	27.45	0.556

Note: The testing result was used peak detector.

Bands	Channel	Frequency (MHz)		Conducted Power (dBm)	Conducted Power (Watts)
GPRS 1900	512	Low	1850.2	24.90	0.309
	661	Mid	1880.0	24.80	0.302
	810	High	1909.8	25.00	0.316

Note: The testing result was used peak detector.



Bands	Channel	Frequency (MHz)		Conducted Power (dBm)	Conducted Power (Watts)
WCDMA Band V	4132	Low	826.4	26.00	0.398
	4182	Mid	836.4	26.25	0.422
	4233	High	846.4	26.02	0.400

Note: The testing result was used peak detector.

Bands	Channel	Frequency (MHz)		Conducted Power (dBm)	Conducted Power (Watts)
HSDPA Band V	4132	Low	826.4	26.57	0.454
	4182	Mid	836.4	26.82	0.481
	4233	High	846.4	26.60	0.457

Note: The testing result was used peak detector.

Bands	Channel	Frequency (MHz)		Conducted Power (dBm)	Conducted Power (Watts)
WCDMA Band II	9262	Low	1852.4	25.60	0.363
	9400	Mid	1880.0	26.41	0.438
	9538	High	1907.6	25.55	0.359

Note: The testing result was used peak detector.

Bands	Channel	Frequency (MHz)		Conducted Power (dBm)	Conducted Power (Watts)
HSDPA Band II	9262	Low	1852.4	26.13	0.410
	9400	Mid	1880.0	26.91	0.491
	9538	High	1907.6	26.60	0.457

Note: The testing result was used peak detector.



4.3 ERP / EIRP Measurement

Equivalent isotropic radiated power measurements by substitution method according to ANSI/TIA/EIA-603-B-2002.

4.3.1 Measurement Instruments

As described in chapter 5 of this test report.

4.3.2 Test Procedure

The phone was tested in an anechoic chamber with a 3-axis position system that permits taking complete spherical scans of the EUT's 3-axis radiation patterns. For all tests, the phone was supported in a free space type environment, vertically oriented in the chamber. Tests were done for GSM 850 three frequencies (824.2, 836.6 and 848.8 MHz) and GSM 1900 three frequencies (1850.2, 1880.00, and 1909.80 MHz).

GSM measurements were made with the phone placed in a call using the CMU200 mobile station test set. The phone was weakly coupled to the test set and configured to transmit in full data rate mode.

The radiated power was measured using ETS-LINDGREN OTA Chamber in "Peak" mode. From these measurements, the software calculates the angle at which maximum radiated power occurs for each case, and the radiated power at this angle was extracted from the data.

Each individual data point in a radiated power or sensitivity measurement is referred to as the effective isotropic radiated power or effective isotropic sensitivity. That is, the desired information is how the measured quantity relates to the same quantity from an isotropic radiator. Thus, the reference measurement must relate the power received or transmitted at the EUT test equipment (spectrum analyzer or communication tester) back to the power transmitted or received at a theoretical isotropic radiator. The total path loss then, is just the difference in dB between the power transmitted or received at the isotropic radiator and that seen at the test equipment (see follow Figure 1).

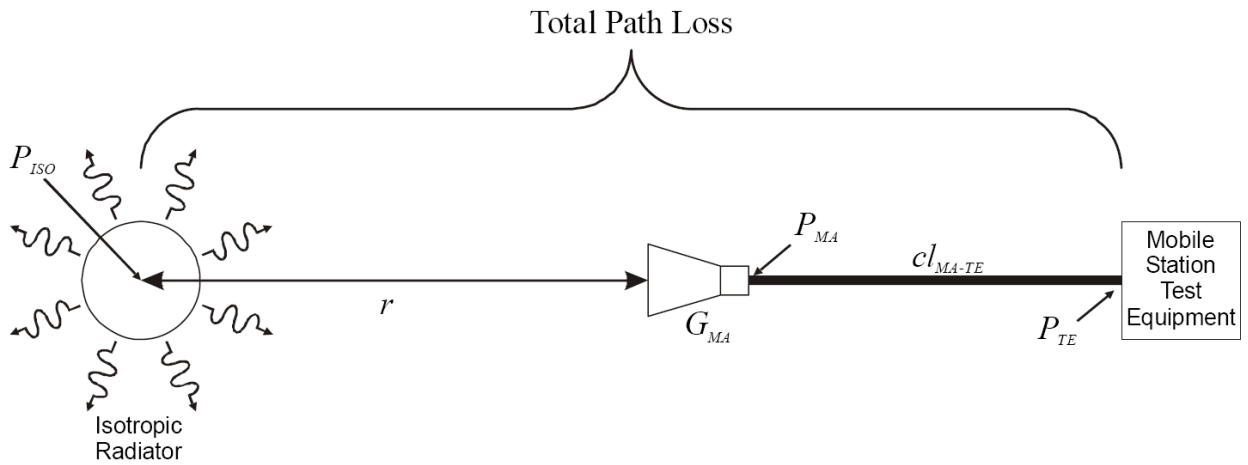

Figure 1. THEORETICAL CASE FOR DETERMINING PATH LOSS

In equation form, this becomes:

Equation 1

$$PL = P_{ISO} - P_{TE},$$

where PL is the total path loss, P_{ISO} is the power radiated by the theoretical isotropic radiator, and P_{TE} is the power received at the test equipment port. As can be seen in Figure 1, this quantity includes the range path loss due to the range length r , the gain of the measurement antenna, and any loss terms associated with the cabling, connections, amplifiers, splitters, etc. between the measurement antenna and the test equipment port.

Figure 2 shows a typical real world configuration for measuring the path loss. In this case, a reference antenna with known gain is used in place of the theoretical isotropic source. The path loss may then be determined from the power into the reference antenna by adding the gain of the reference antenna.

That is:

Equation 2

$$P_{ISO} = P_{RA} + G_{RA},$$

where P_{RA} is the power radiated by reference antenna, and G_{RA} is the gain of the reference antenna, so that:

Equation 3

$$PL = P_{RA} + G_{RA} - P_{TE},$$

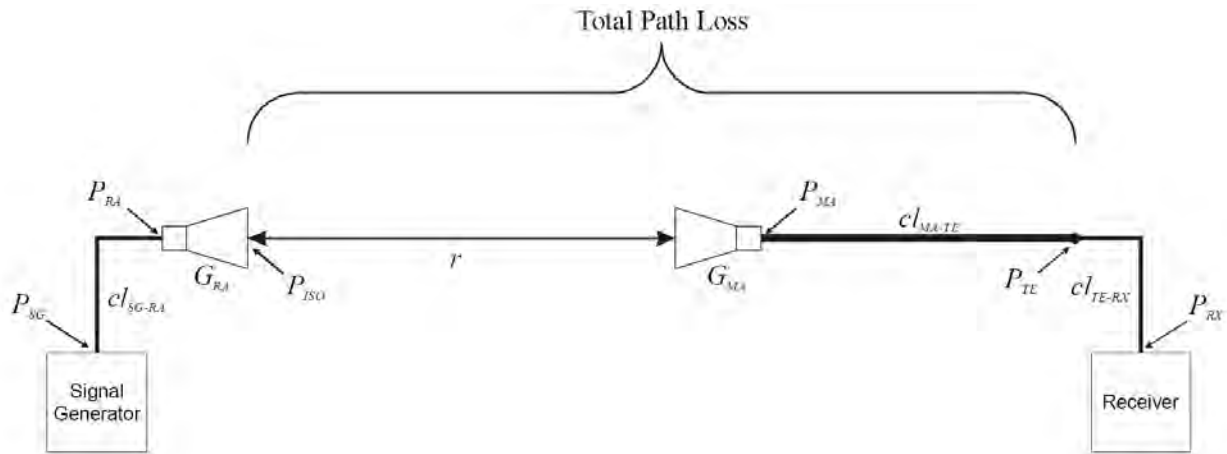

Figure 2. TYPICAL CONFIGURATION FOR MEASURING PATH LOSS

In order to determine P_{RA} , it is necessary to perform a cable reference measurement to remove the effects of the cable loss between signal generator and reference antenna, and between the test equipment port and the receiver. This establishes a reference point at the input to the reference antenna. Figure 3 illustrates the cable reference measurement configuration. Assuming the power level at the signal generator is fixed, it is easy to show that the difference between P_{RA} and P_{TE} in Figure 2 is given by:

Equation 4

$$P_{RA} - P_{TE} = P_{RX}' - P_{RX},$$

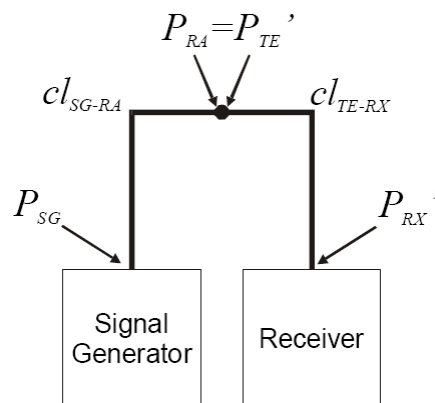

Figure 3. CABLE REFERENCE CALIBRATION CONFIGURATION

Where P_{RX} is the power measured at the receiver during the cable reference test, and P_{RX} is the power measured at the receiver during the range path loss measurement in Figure 2. Thus, the path loss is then just given by:

Equation 5

$$PL = G_{RA} + P_{RX}' - P_{RX}$$

$$EIRP = P_t + P_L$$

P_t = Often referred to as antenna output power

4.3.3 Test Setup Layout of ERP/EIRP

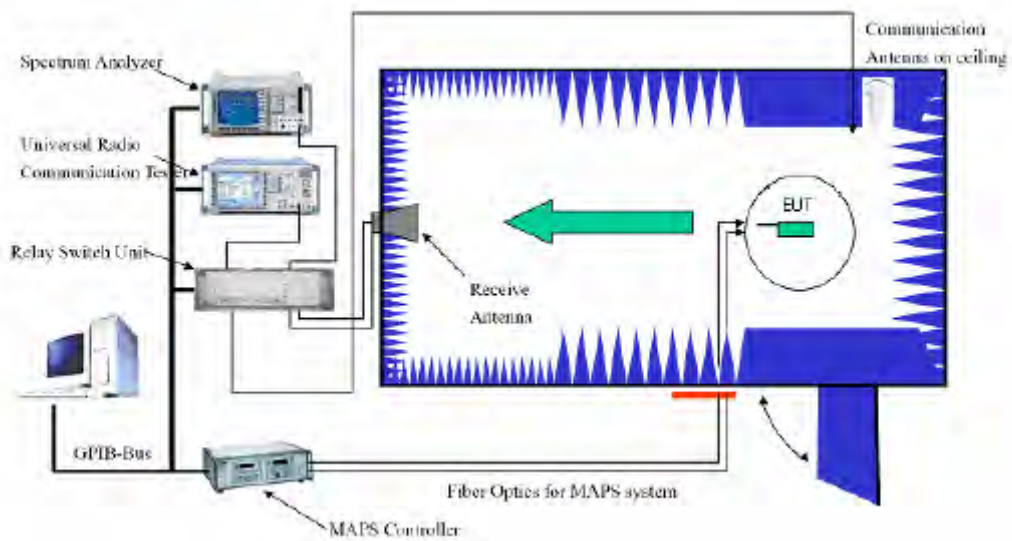



4.3.4 Test Result

GPRS 850 Radiated Power ERP				
Maximum Output Power				
Frequency (MHz)	Read Level (dBm)	Correction factor (dBm)	ERP (dBm)	ERP (W)
824.20	79.94	-48.80	31.14	1.299
836.40	78.79	-48.80	29.99	0.997
848.80	78.45	-48.80	29.65	0.922

EGPRS 850 Radiated Power ERP				
Maximum Output Power				
Frequency (MHz)	Read Level (dBm)	Correction factor (dBm)	ERP (dBm)	ERP (W)
824.20	74.48	-48.80	25.68	0.370
836.40	73.55	-48.80	24.75	0.298
848.80	73.04	-48.80	24.24	0.266

Note:

1. ERP/EIRP = Read Level + Correction factor.
2. For CDMA signals, a peak detector is used, with RBW = VBW = 3 MHz.
3. For WCDMA signals, a peak detector is used with RBW = VBW = 5MHz.
4. For AMPS, GSM, and NADC TDMA signals, a peak detector is used, with RBW = VBW= 1 MHz.



GPRS 1900 Radiated Power EIRP				
Maximum Output Power				
Frequency (MHz)	Read Level (dBm)	Correction factor (dBm)	EIRP (dBm)	EIRP (W)
1850.20	85.15	-54.00	31.15	1.302
1880.00	85.98	-55.60	30.38	1.091
1909.80	86.65	-56.90	29.75	0.943

EGPRS 1900 Radiated Power EIRP				
Maximum Output Power				
Frequency (MHz)	Read Level (dBm)	Correction factor (dBm)	EIRP (dBm)	EIRP (W)
1850.20	81.58	-54.00	27.58	0.572
1880.00	82.41	-55.60	26.81	0.480
1909.80	83.09	-56.90	26.19	0.416

Note:

1. ERP/EIRP = Read Level + Correction factor.
2. For CDMA signals, a peak detector is used, with RBW = VBW = 3 MHz.
3. For WCDMA signals, a peak detector is used with RBW = VBW = 5MHz.
4. For AMPS, GSM, and NADC TDMA signals, a peak detector is used, with RBW = VBW= 1 MHz.



WCDMA Band V Radiated Power ERP				
Maximum Output Power				
Frequency (MHz)	Read Level (dBm)	Correction factor (dBm)	ERP (dBm)	ERP (W)
826.40	71.59	-48.80	22.79	0.190
836.40	71.40	-48.80	22.60	0.182
846.60	73.74	-48.80	24.94	0.312

WCDMA Band II Radiated Power EIRP				
Maximum Output Power				
Frequency (MHz)	Read Level (dBm)	Correction factor (dBm)	EIRP (dBm)	EIRP (W)
1852.40	79.61	-54.00	25.61	0.364
1880.00	81.63	-55.60	26.03	0.401
1907.60	81.79	-56.90	24.89	0.308

Note:

1. ERP/EIRP = Read Level + Correction factor.
2. For CDMA signals, a peak detector is used, with RBW = VBW = 3 MHz.
3. For WCDMA signals, a peak detector is used with RBW = VBW = 5MHz.
4. For AMPS, GSM, and NADC TDMA signals, a peak detector is used, with RBW = VBW= 1 MHz.

4.4 Occupied Bandwidth and Band Edge Measurement

4.4.1 Measurement Instruments

As described in chapter 5 of this test report.

4.4.2 Test Procedure

The measurement is made according to FCC rules part 22 and 24:

1. The EUT was connected to Spectrum Analyzer and Base Station via power divider.
2. The occupied bandwidth of middle channel for the highest and lowest RF powers was measured.
3. The band edge of low and high channels for the highest RF powers within the transmitting frequency band were measured. Setting RBW as roughly $BW/100$.
4. The band edge setting:
 - a. $RB=3$ kHz; $VB=3$ kHz for GSM 850 and PCS 1900.
 - b. $RB=100$ kHz; $VB=100$ kHz for WCDMA Band V and WCDMA Band II.

4.4.3 Test Setup Layout

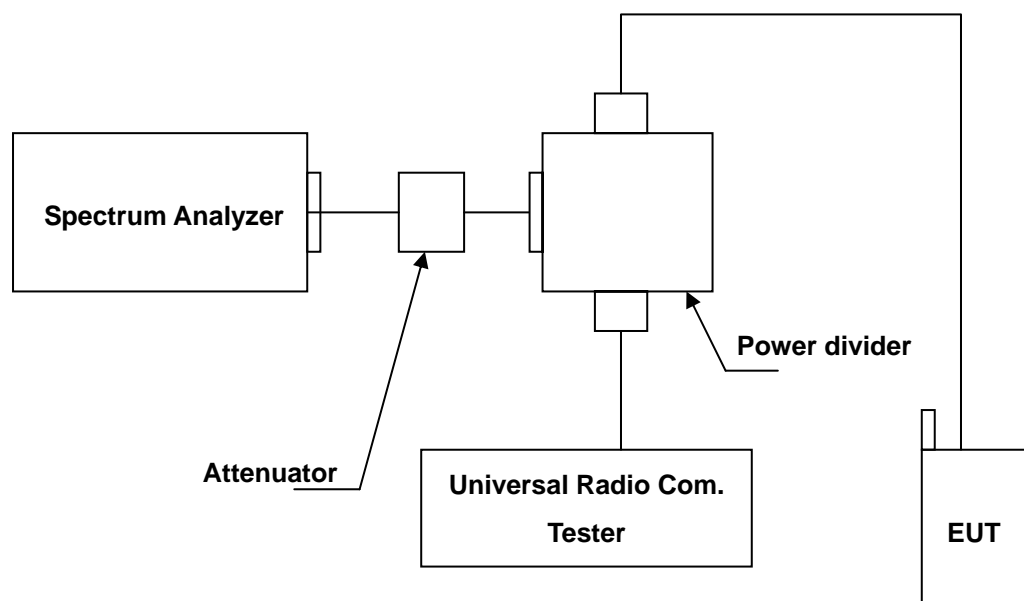



4.4.4 Occupied Bandwidth Test Result

GPRS 850		
Channel	Frequency (MHz)	Output Power - 26 dBc Bandwidth (kHz)
128	824.2	242.3823
190	836.6	242.3979
251	848.8	244.4115
RB:3KHz , VBW:10KHz		

EGPRS 850 (3Down2Up)		
Channel	Frequency (MHz)	Output Power - 26 dBc Bandwidth (kHz)
128	824.2	258.2066
190	836.6	257.6635
251	848.8	258.3249
RB:3KHz , VBW:10KHz		



GPRS 1900		
Channel	Frequency (MHz)	Output Power - 26 dBc Bandwidth (kHz)
512	1850.2	243.0637
661	1880.0	245.5327
810	1909.8	243.3276
RB:3KHz , VBW:10KHz		

EGPRS 1900 (3Down2Up)		
Channel	Frequency (MHz)	Output Power - 26 dBc Bandwidth (kHz)
512	1850.2	252.6812
661	1880.0	257.5285
810	1909.8	254.2602
RB:3KHz , VBW:10KHz		



WCDMA Band V		
Channel	Frequency (MHz)	Output Power - 26 dBc Bandwidth (MHz)
4132	826.4	4.1419
4182	836.4	4.1405
4233	846.6	4.1590
RB:30KHz , VBW:300KHz		

WCDMA Band II		
Channel	Frequency (MHz)	Output Power - 26 dBc Bandwidth (MHz)
9262	1852.4	4.1475
9400	1880.0	4.1467
9538	1907.6	4.1513
RB:30KHz , VBW:300KHz		



Test Mode: GPRS 850 CH128 99% Occupied Bandwidth

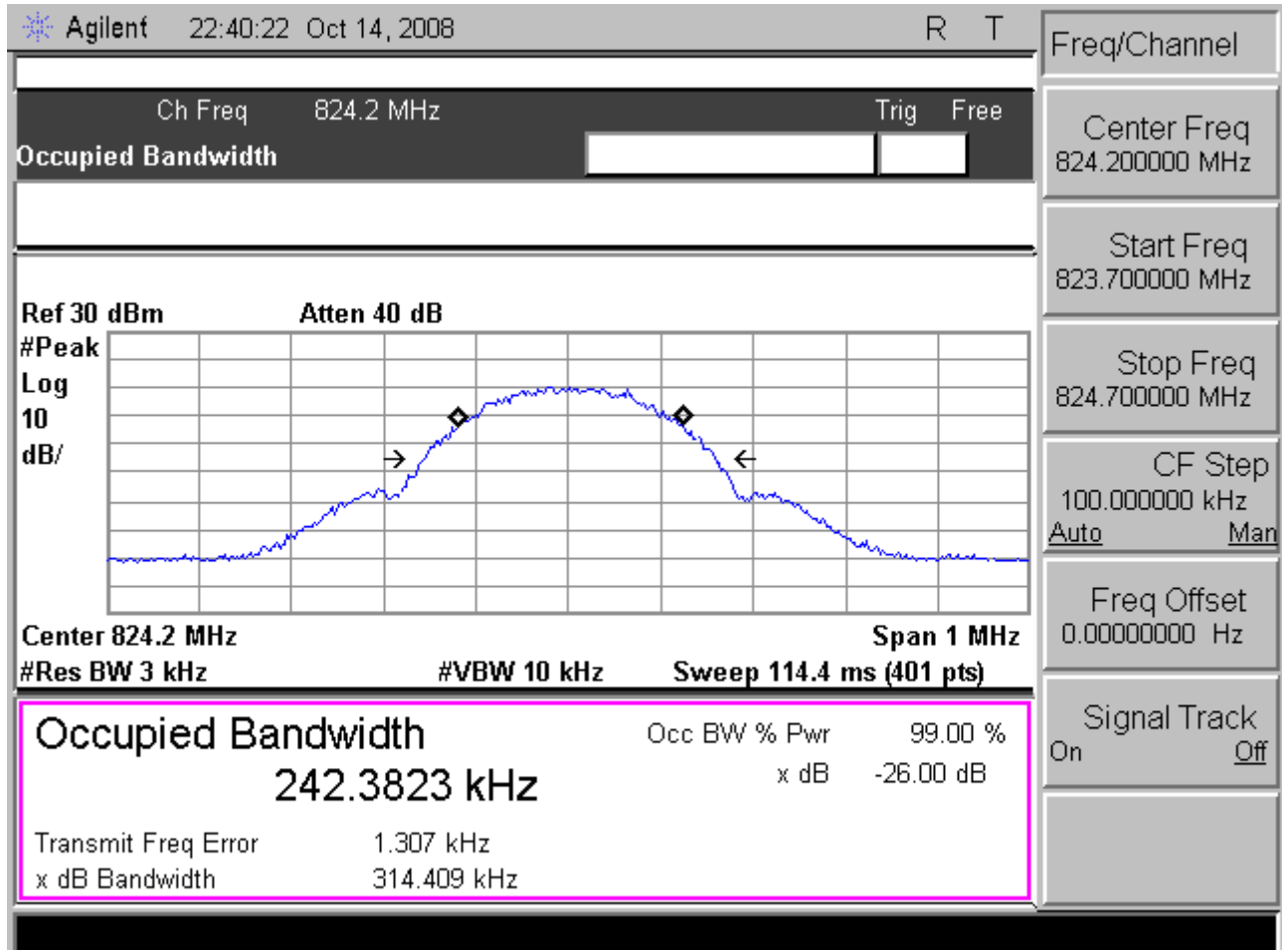



Test Mode: GPRS 850 CH190 99% Occupied Bandwidth

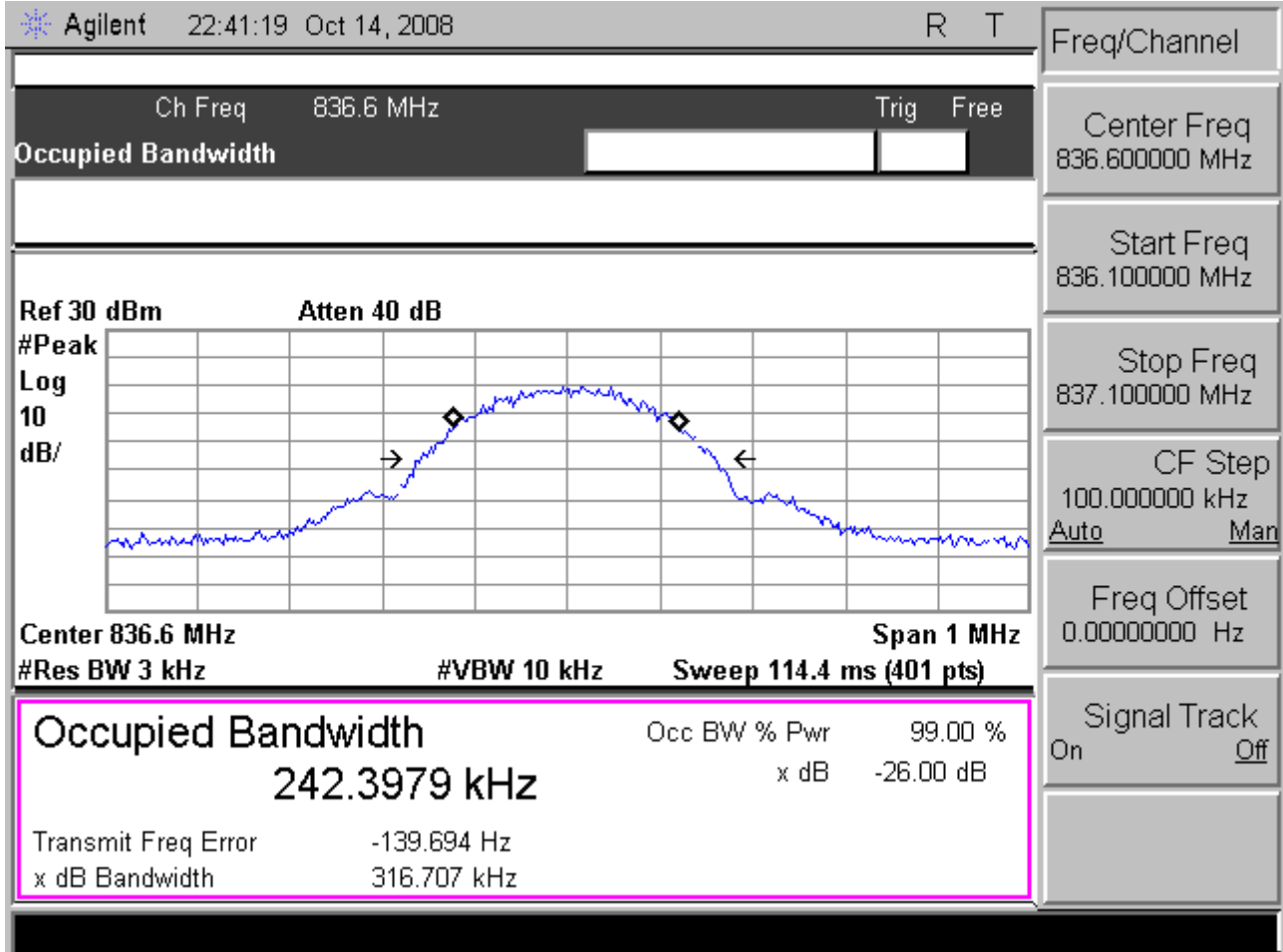



Test Mode: GPRS 850 CH251 99% Occupied Bandwidth

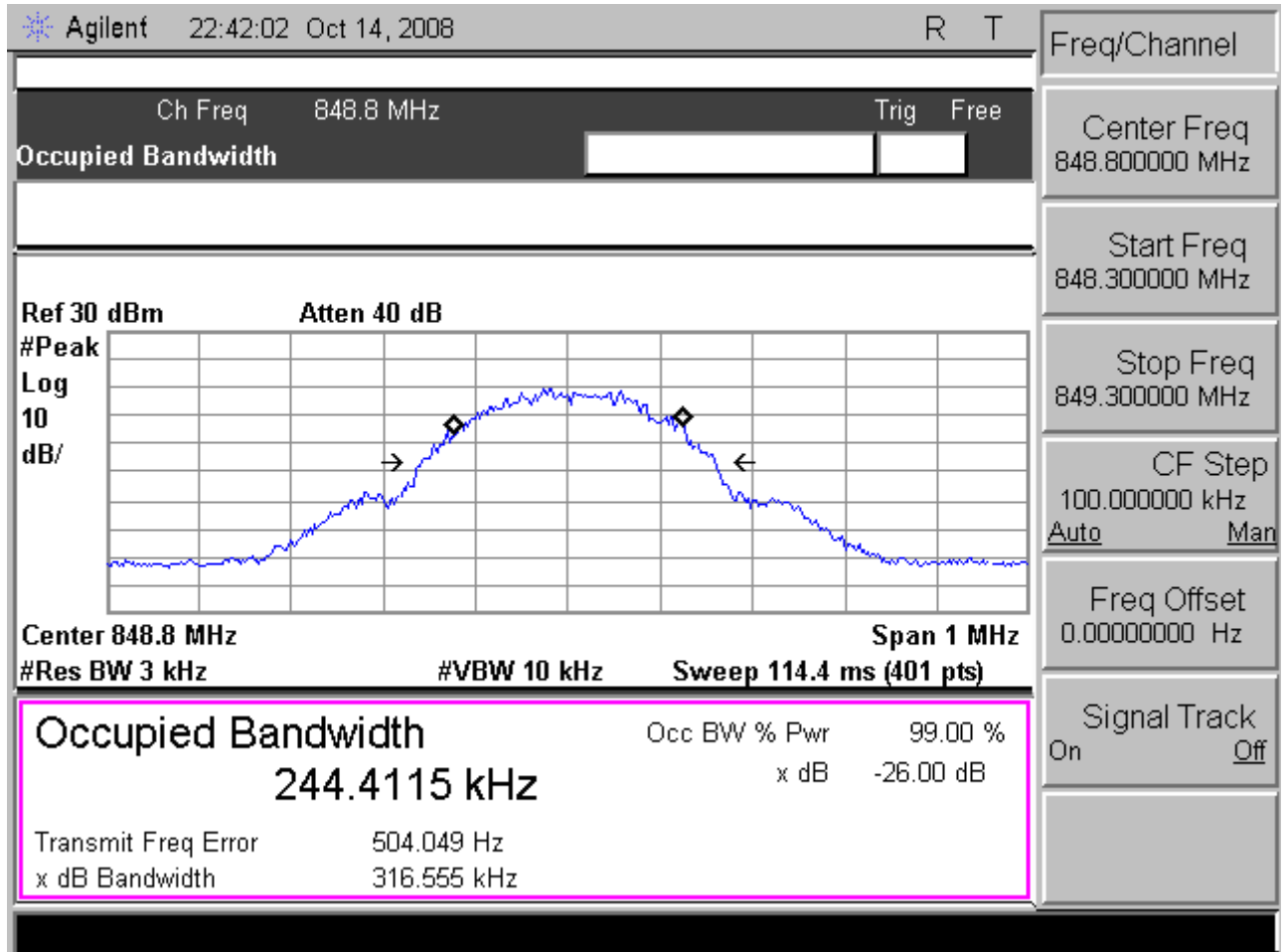



Test Mode: EGPRS 850 CH128 99% Occupied Bandwidth

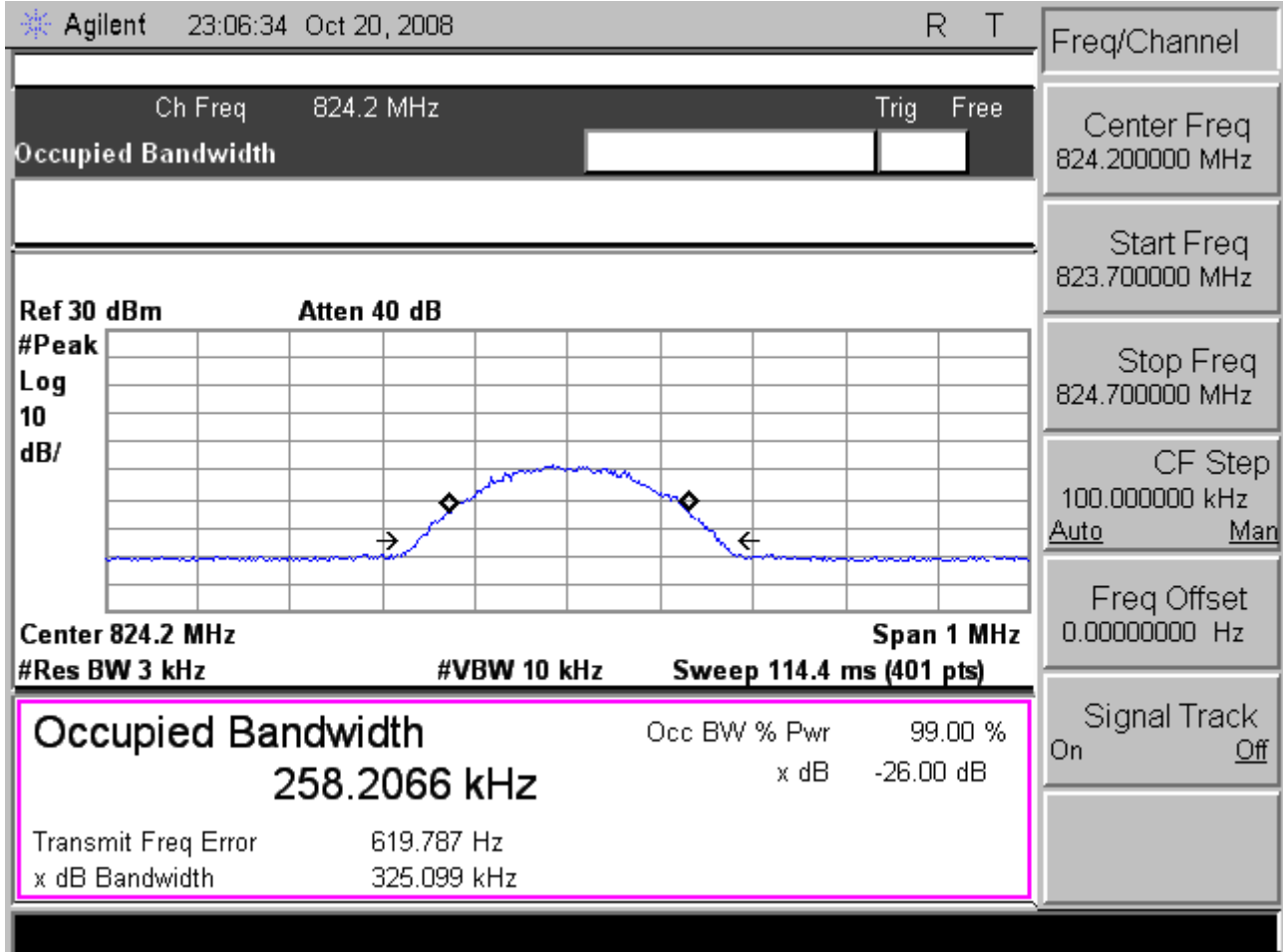



Test Mode: EGPRS 850 CH190 99% Occupied Bandwidth

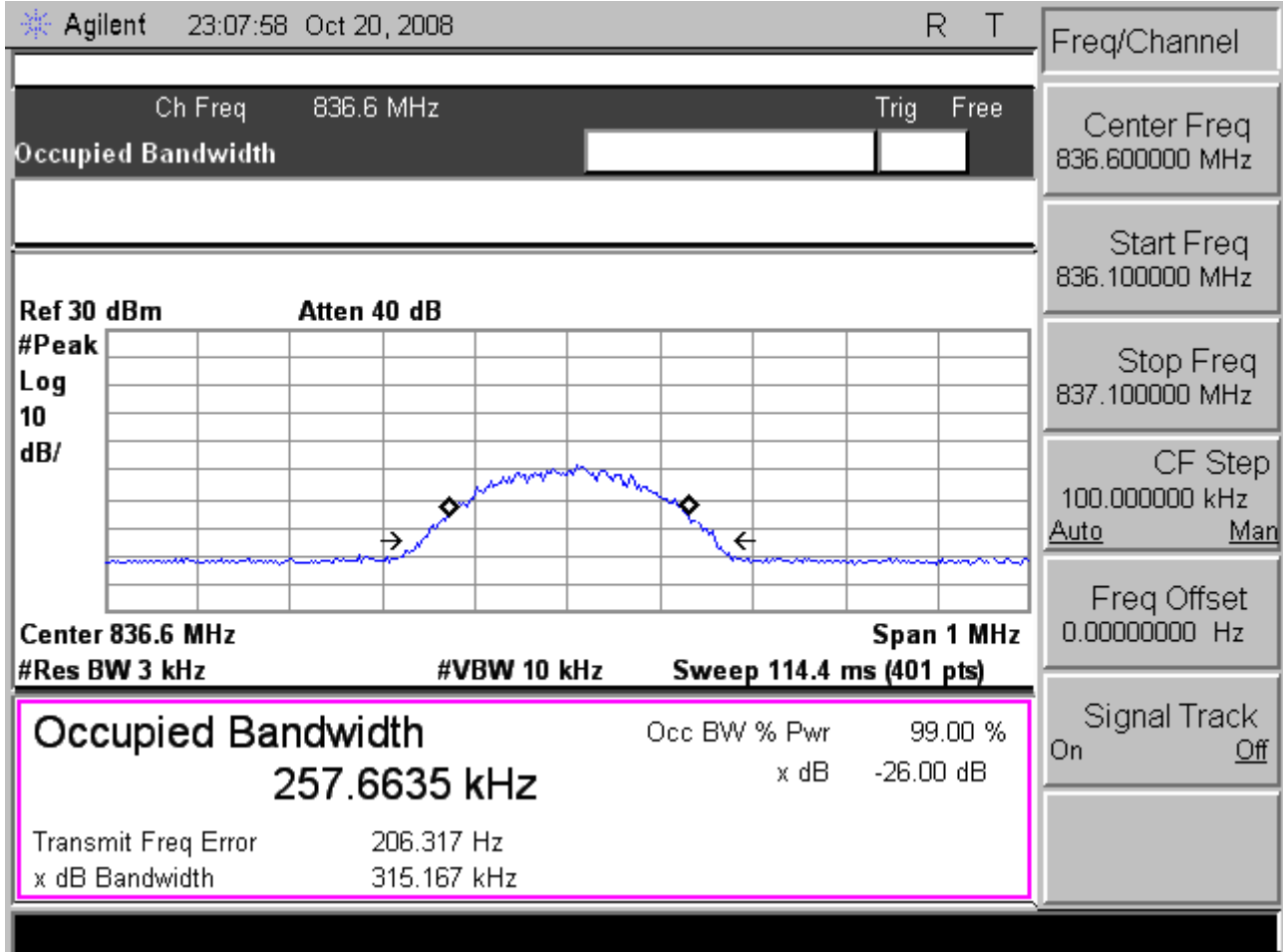



Test Mode: EGPRS 850 CH251 99% Occupied Bandwidth

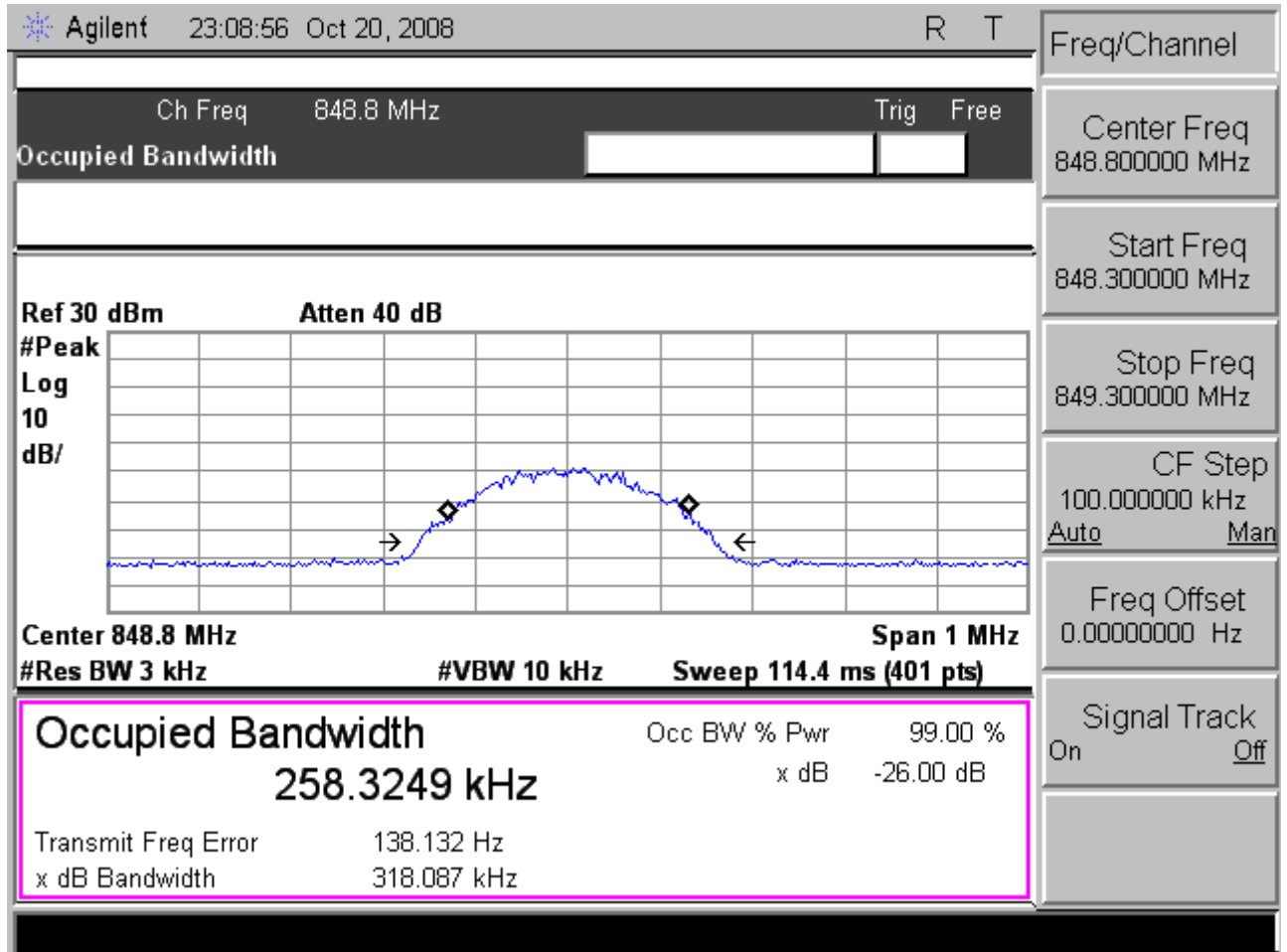



Test Mode: GPRS 1900 CH512 99% Occupied Bandwidth

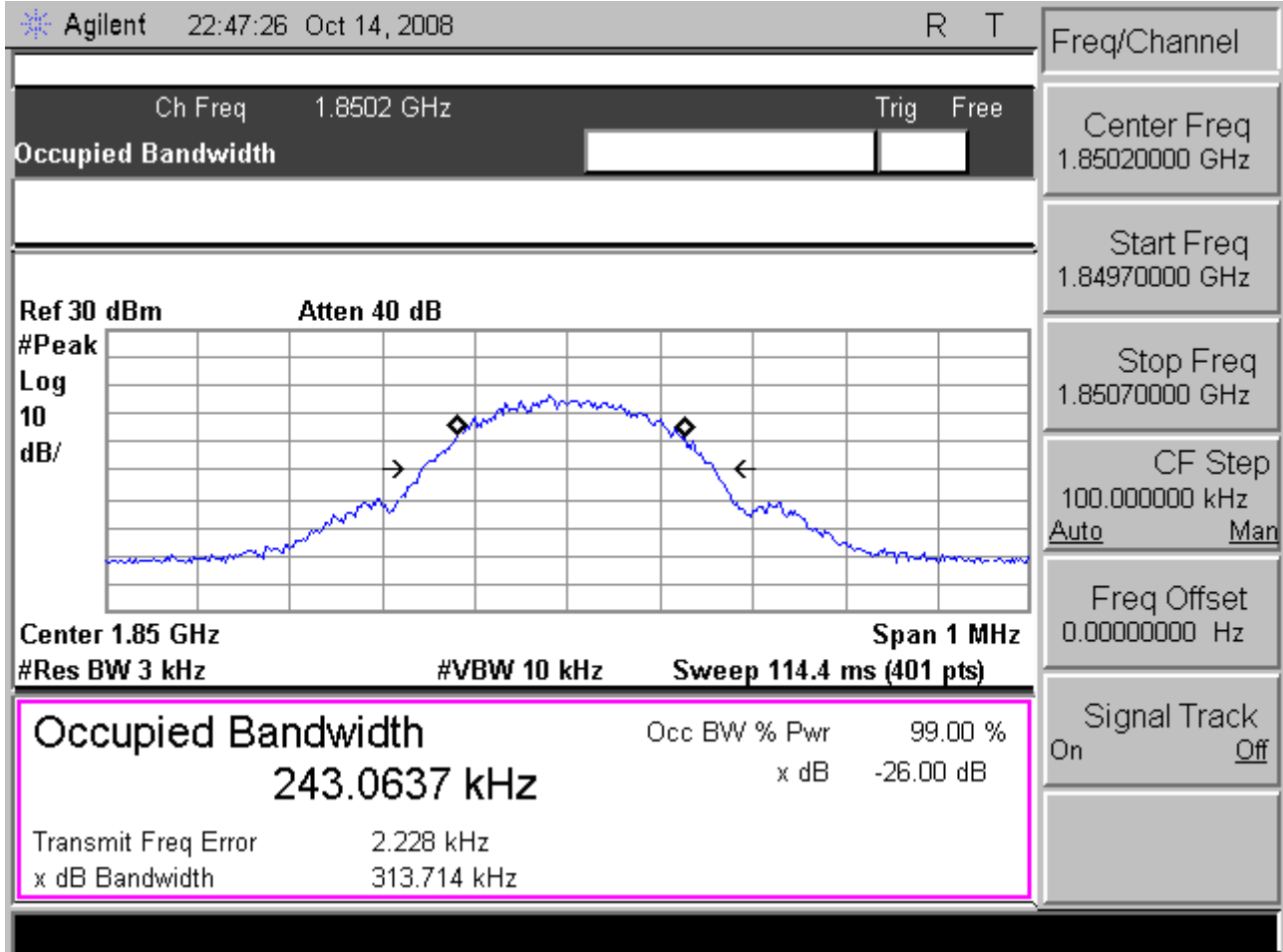



Test Mode: GPRS 1900 CH661 99% Occupied Bandwidth

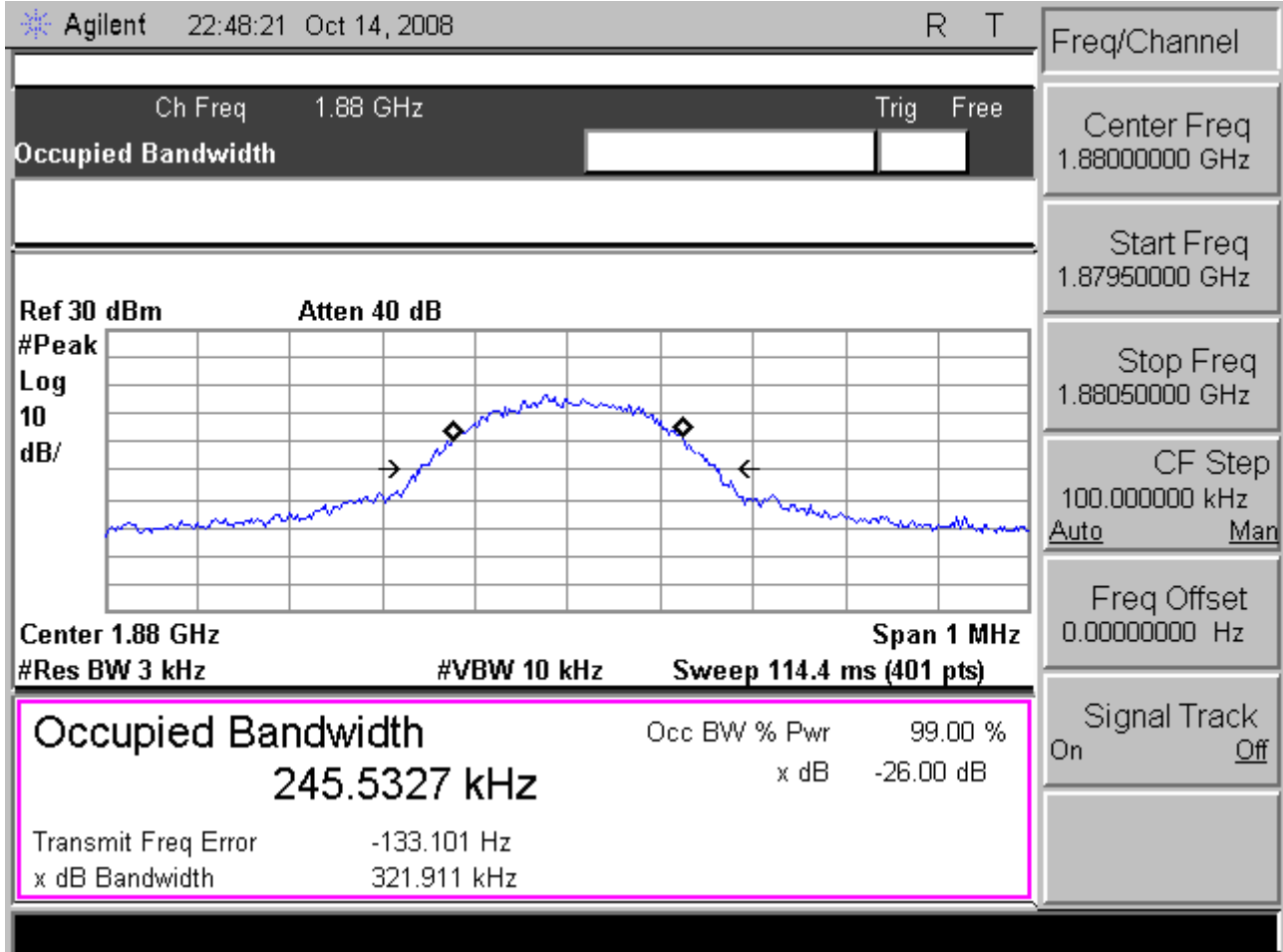



Test Mode: GPRS 1900 CH810 99% Occupied Bandwidth

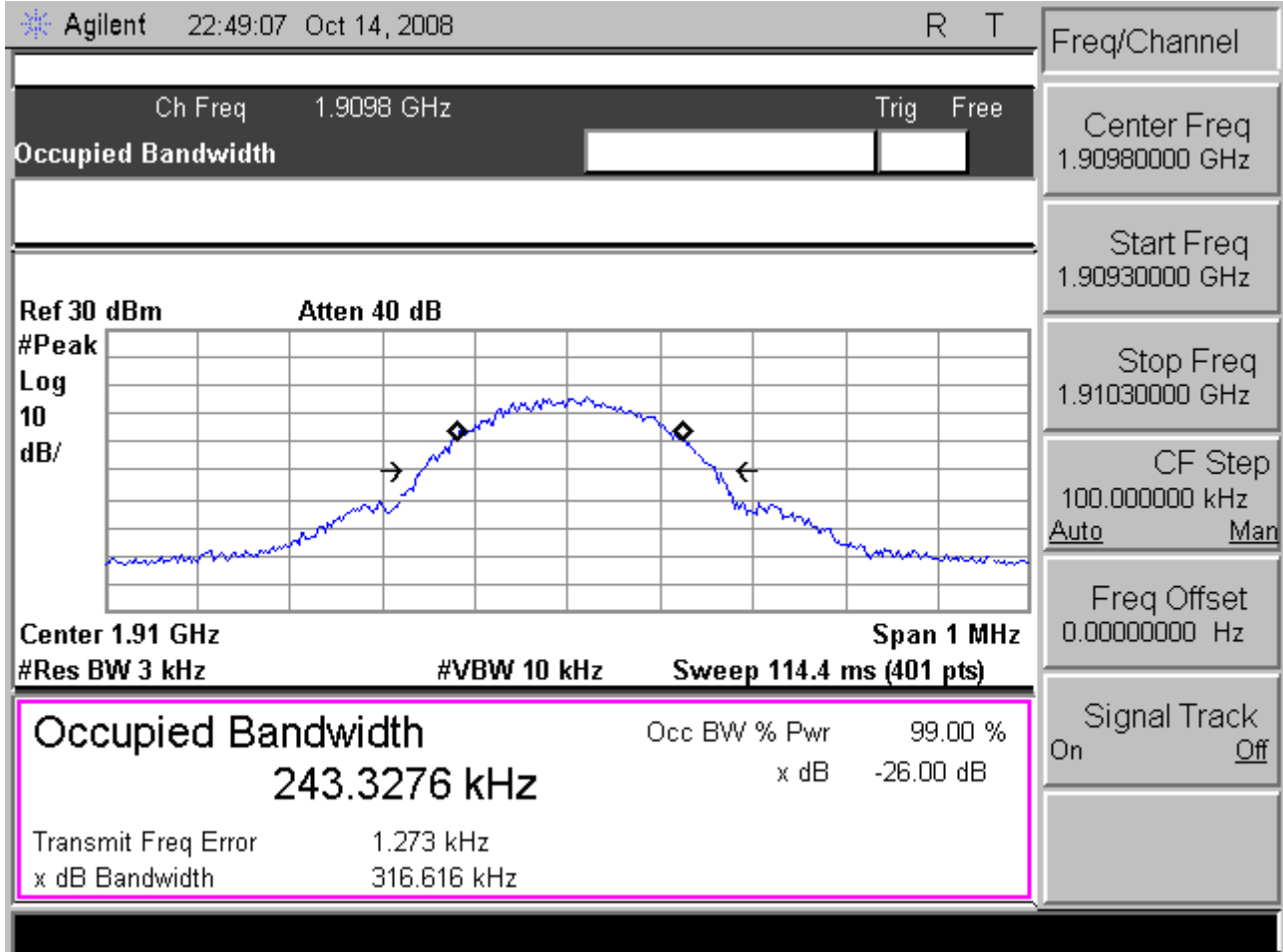



Test Mode: EGPRS 1900 CH512 99% Occupied Bandwidth

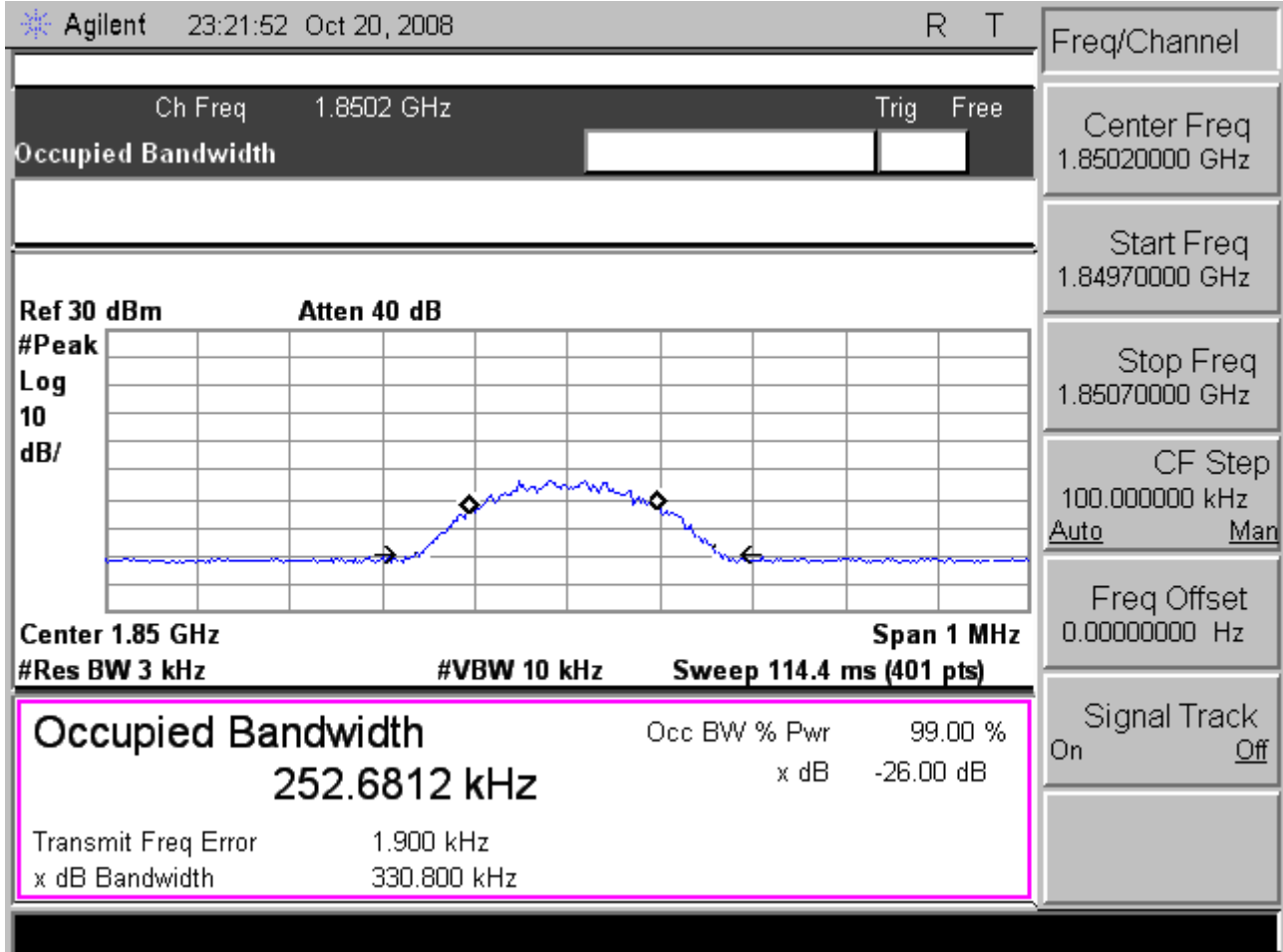



Test Mode: EGPRS 1900 CH661 99% Occupied Bandwidth

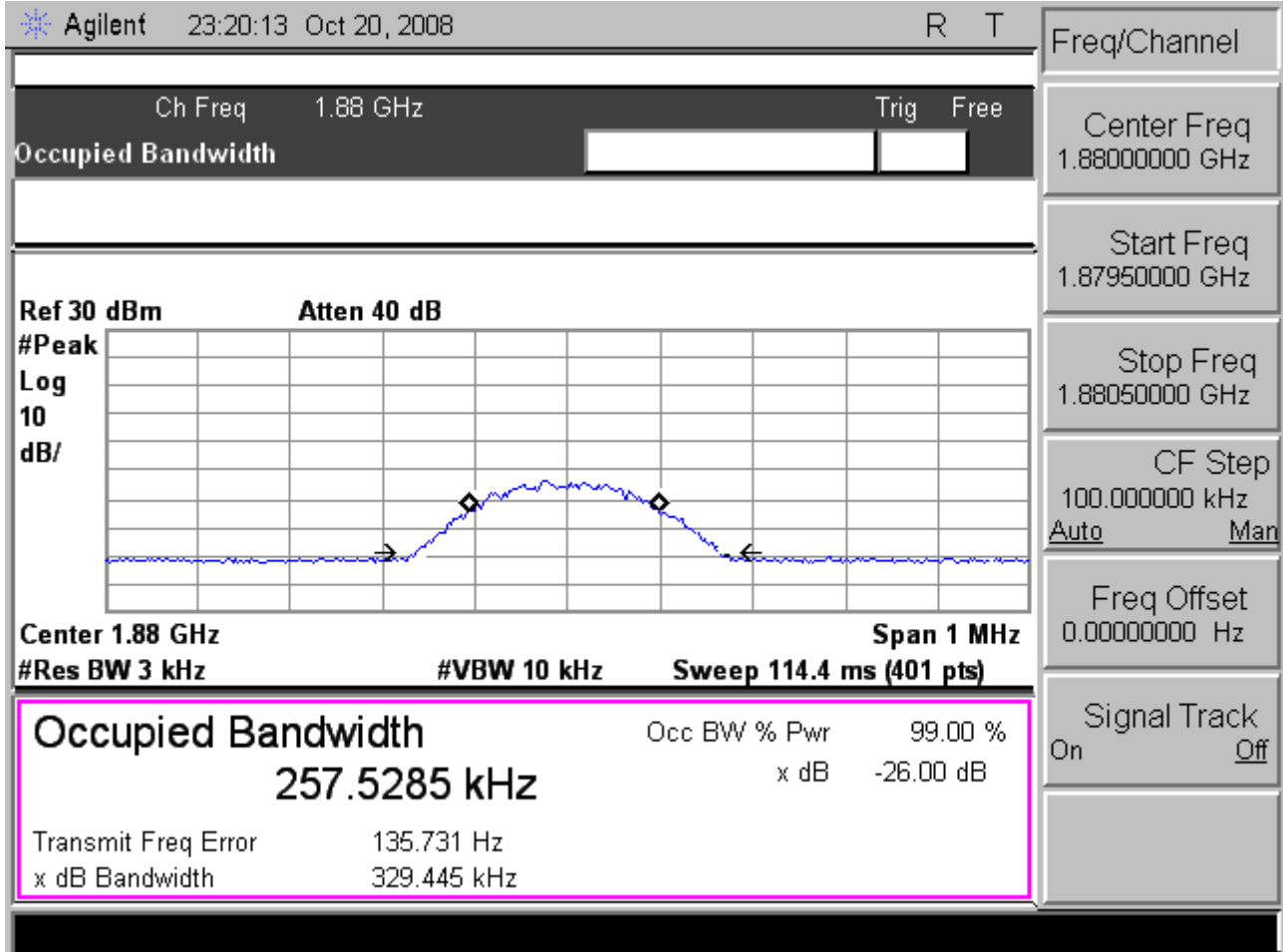



Test Mode: EGPRS 1900 CH810 99% Occupied Bandwidth

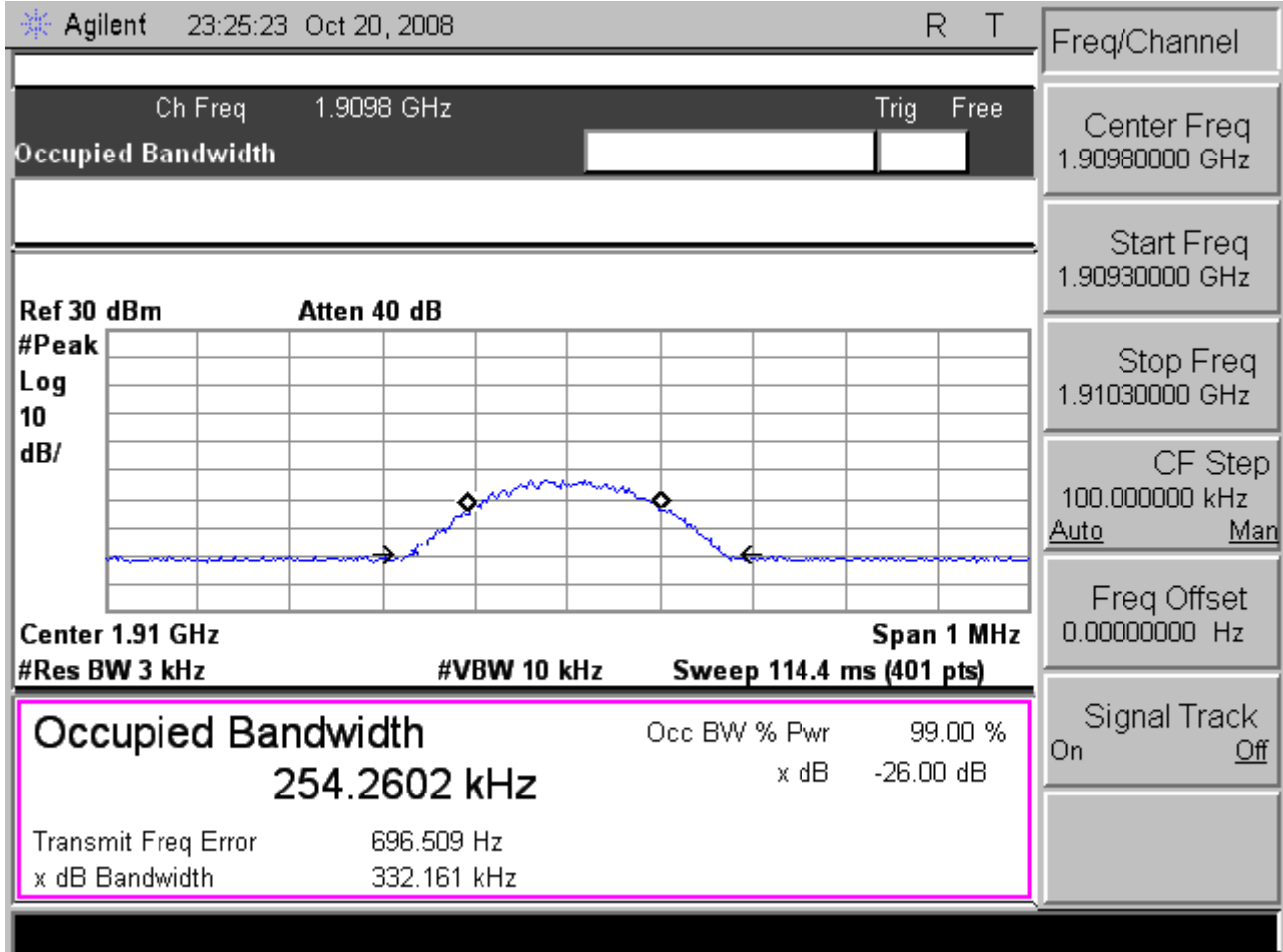



Test Mode: WCDMA Band V CH4132 99% Occupied Bandwidth

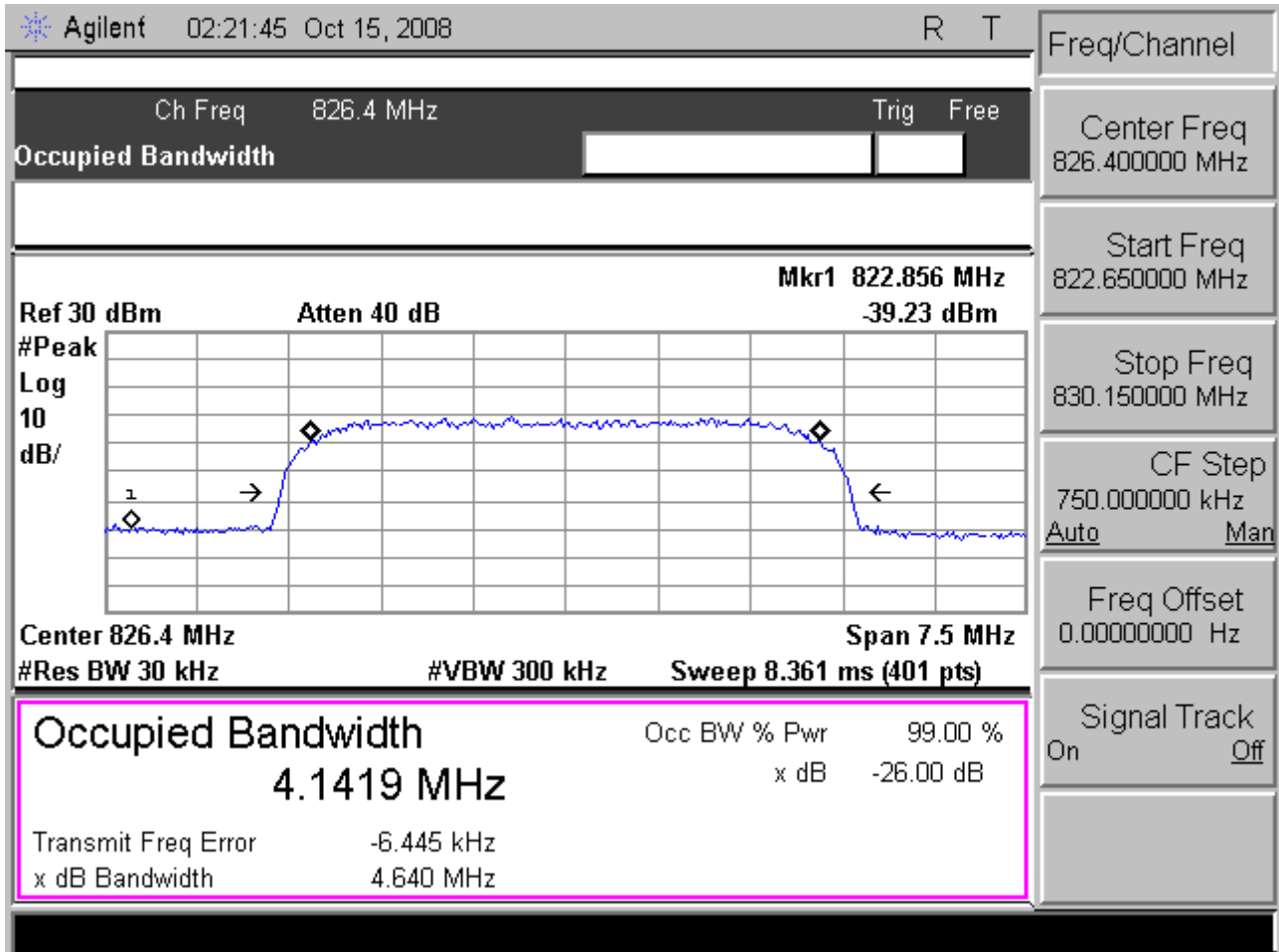



Test Mode: WCDMA Band V CH4182 99% Occupied Bandwidth

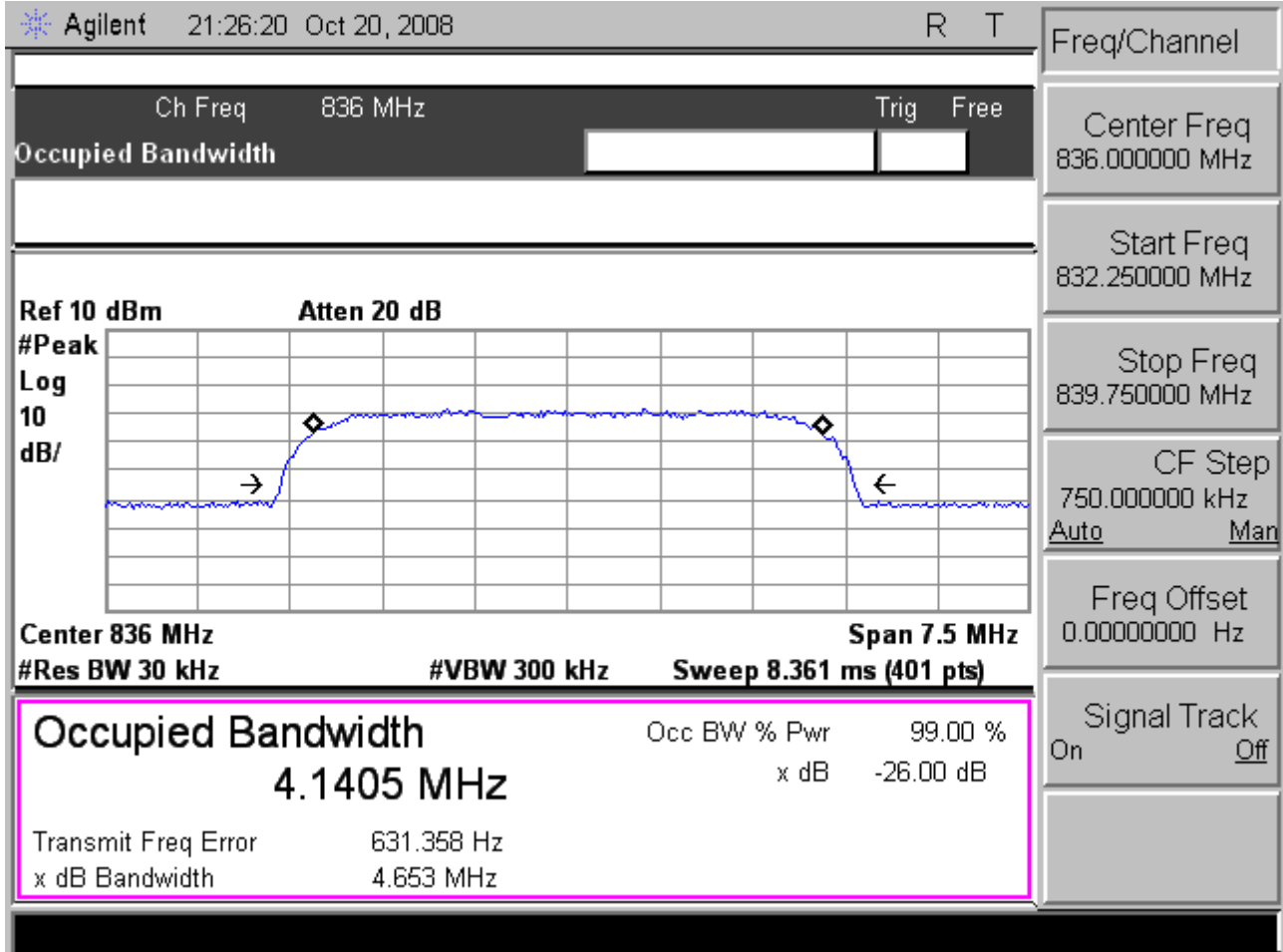



Test Mode: WCDMA Band V CH4233 99% Occupied Bandwidth

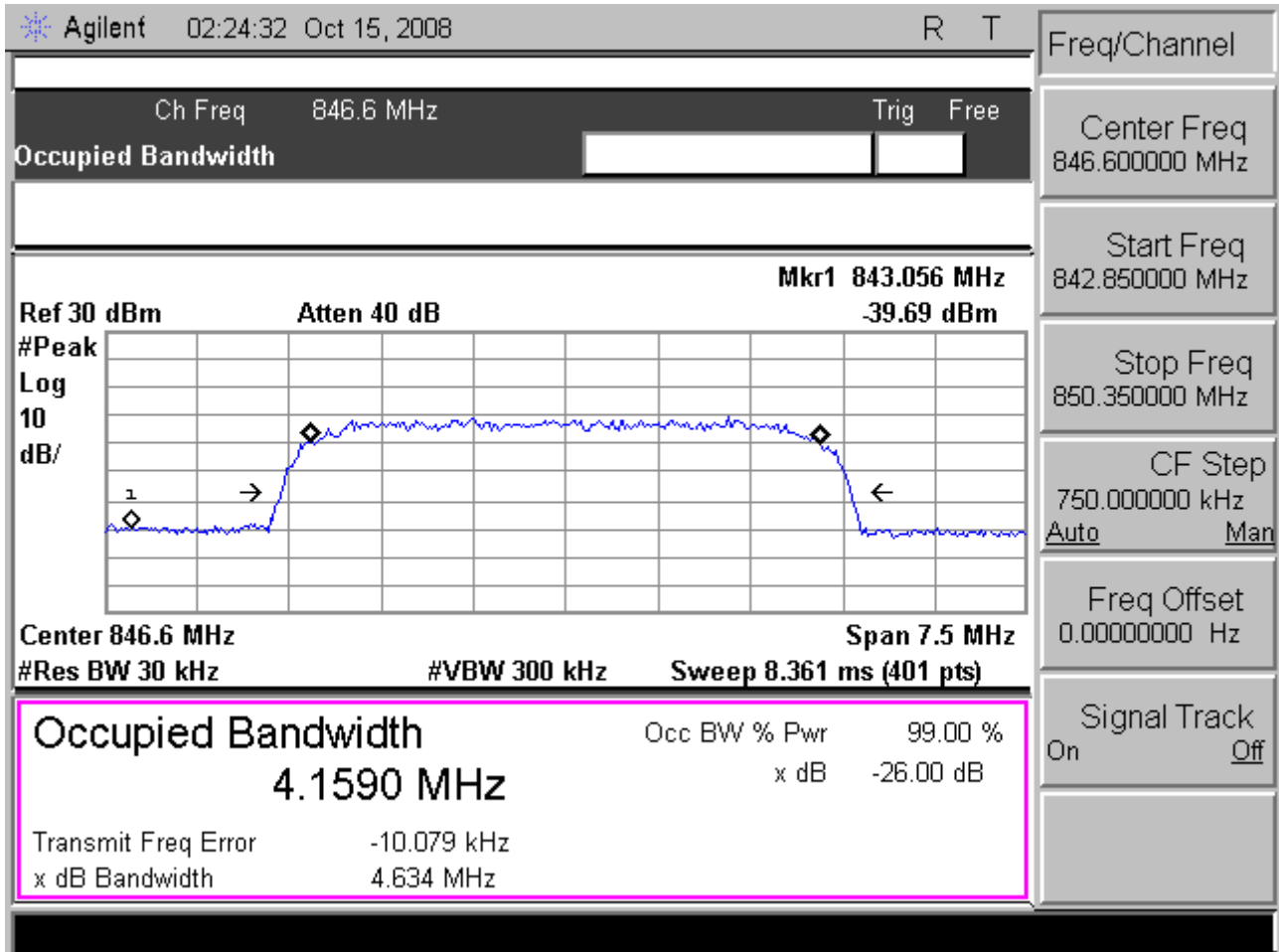



Test Mode: WCDMA Band II CH9262 99% Occupied Bandwidth

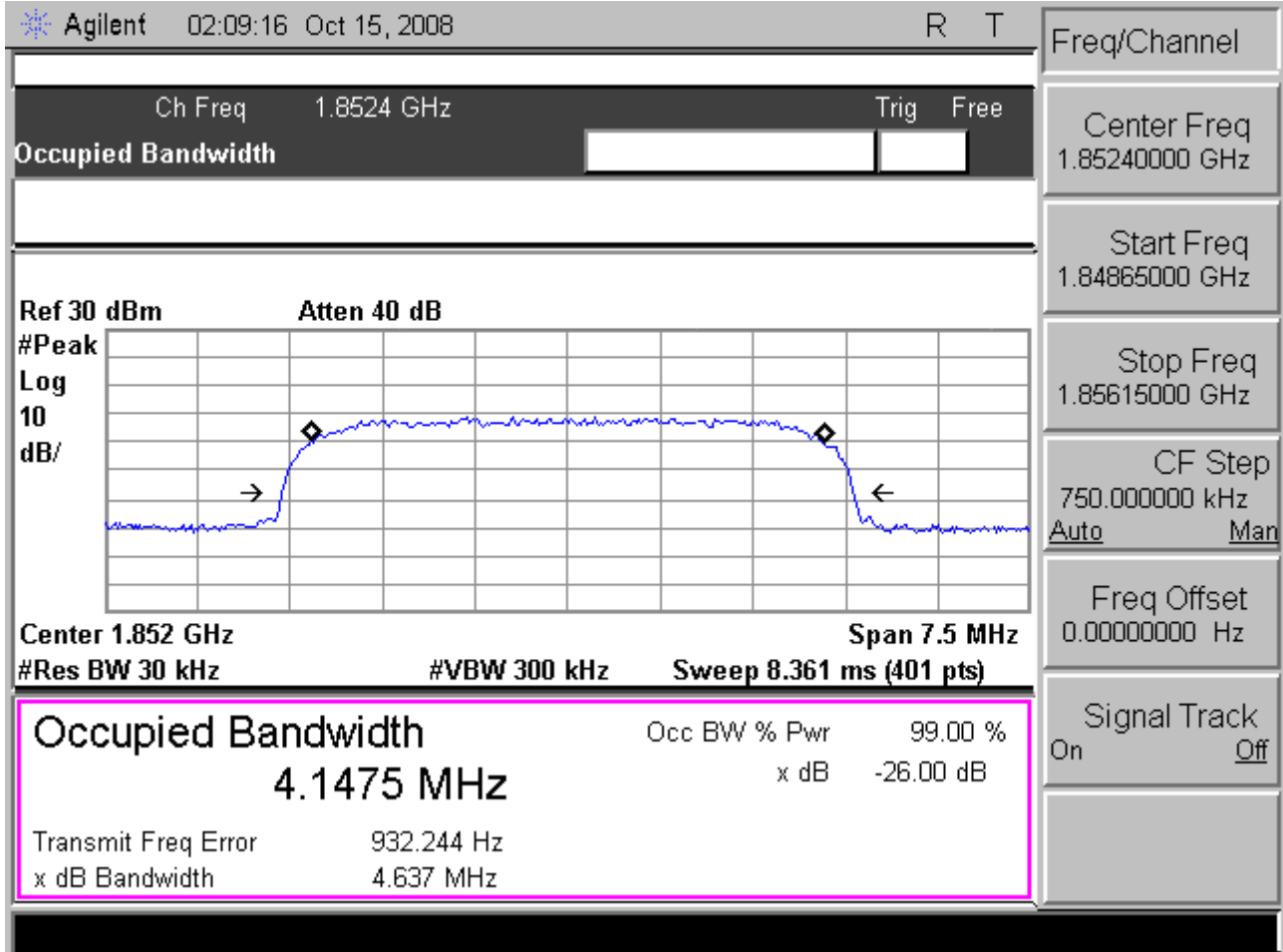



Test Mode: WCDMA Band II CH9400 99% Occupied Bandwidth

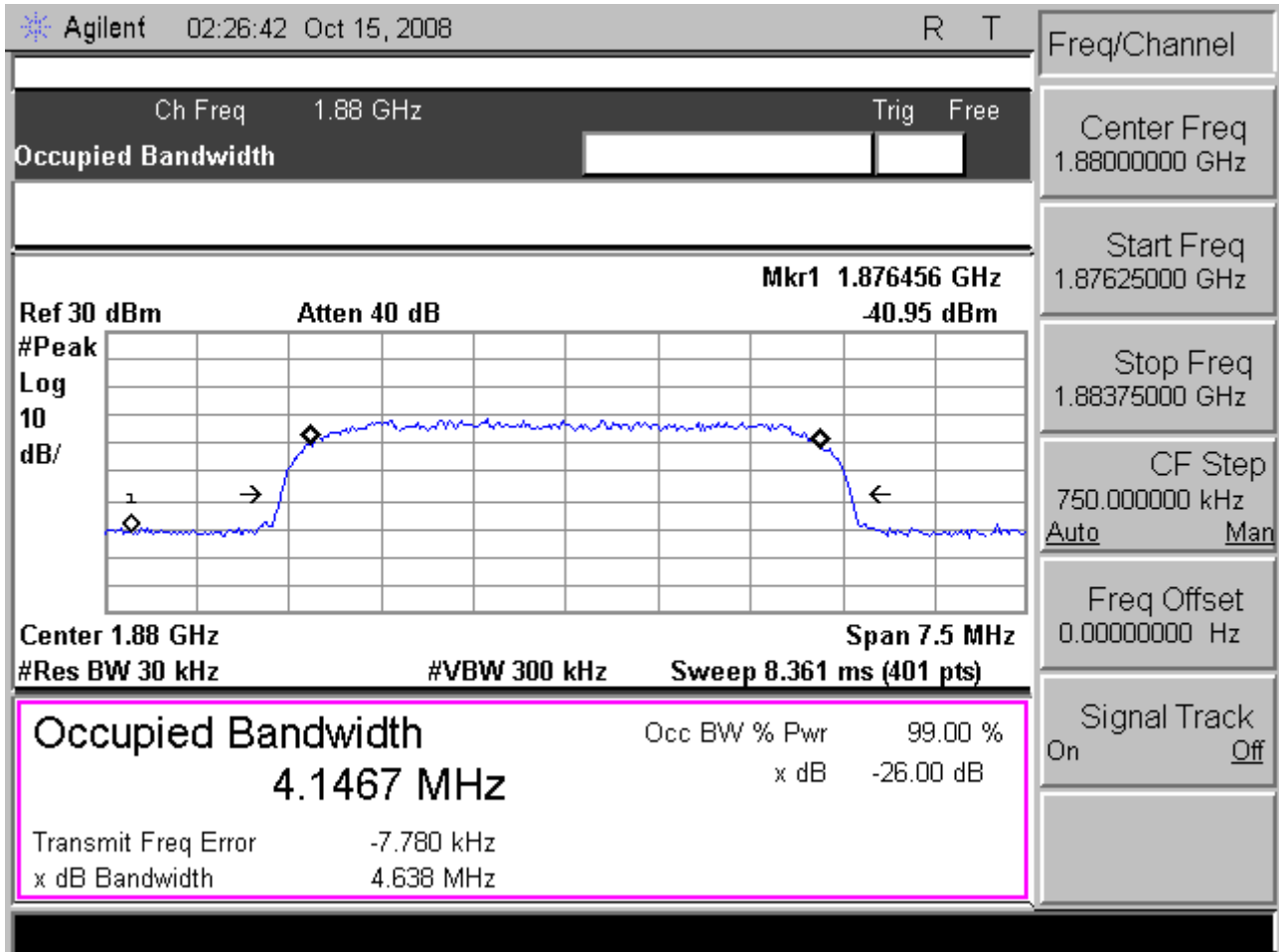



Test Mode: WCDMA Band II CH9538 99% Occupied Bandwidth

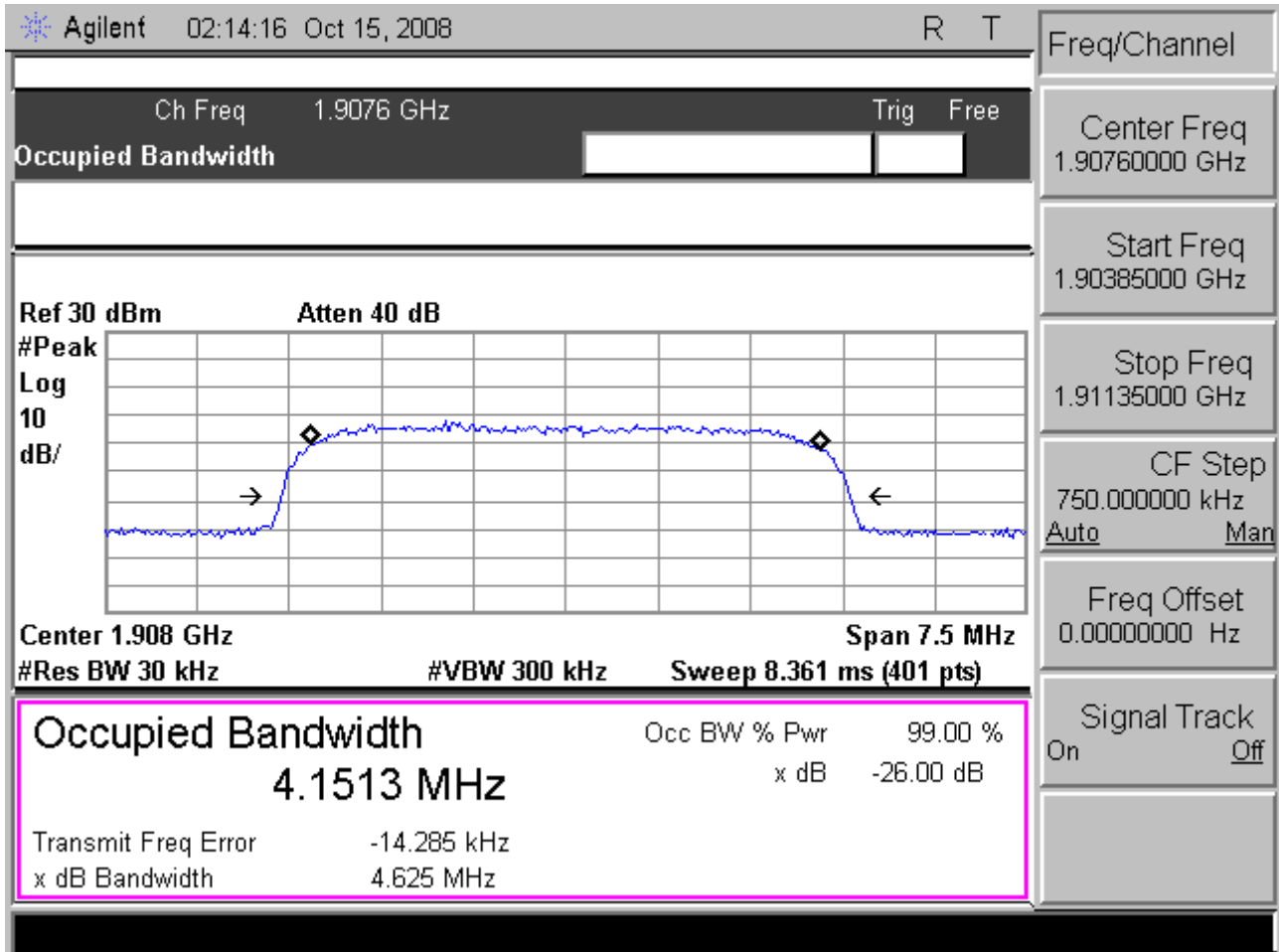



4.4.5 Band Edge Test Result

GPRS 850				
Band	Channel	Frequency (MHz)	Bandwidth (dBm)	Limit (dBm)
Lower	128	823.9974	-16.20	-13
Higher	251	849.0225	-17.06	-13

Please refer to next pager of detail testing data.



File :FD400(CH128)

Data :#1

Date: 2008/10/15

Time: 下午 09:06:27

30.0 dBm

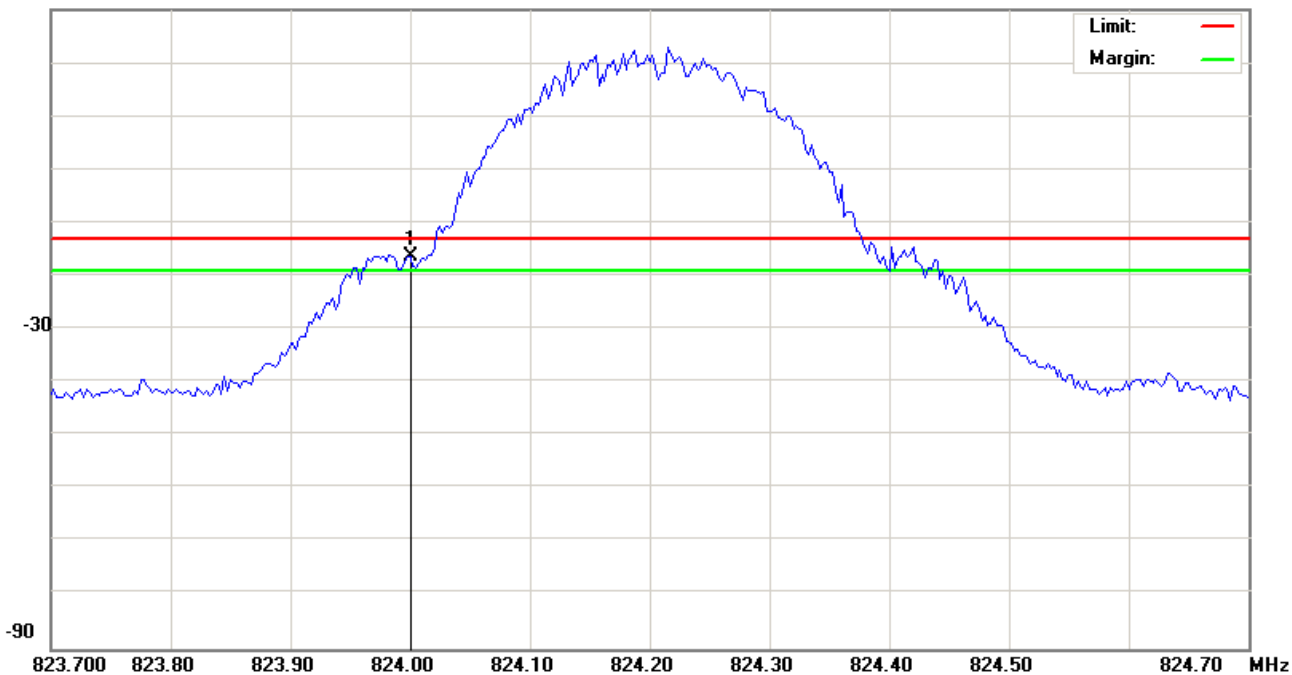

Site Polarization: **Conducted po** Temperature: 26 °C
 Limit: FCC Part 22 conducted(9k-12.75G) Power: AC 110V/60Hz Humidity: 55 %
 EUT: Distance:
 M/N: 08-0252-SEO
 Mode: GSM850(GPRS)
 Note: CH128
 加10db衰減器

No.	Mk.	Freq. MHz	Reading Level dBm	Correct Factor dB	Measure- ment dBm	Limit dBm	Over dB	Antenna Height cm	Table Degree degree	Comment
1	*	824.0000	-29.38	13.18	-16.20	-13.00	-3.20	peak		

*:Maximum data x:Over limit !:over margin

●Reference Only



File :FD400(CH251)

Data :#1

Date: 2008/10/15

Time: 下午 09:29:01

30.0 dBm

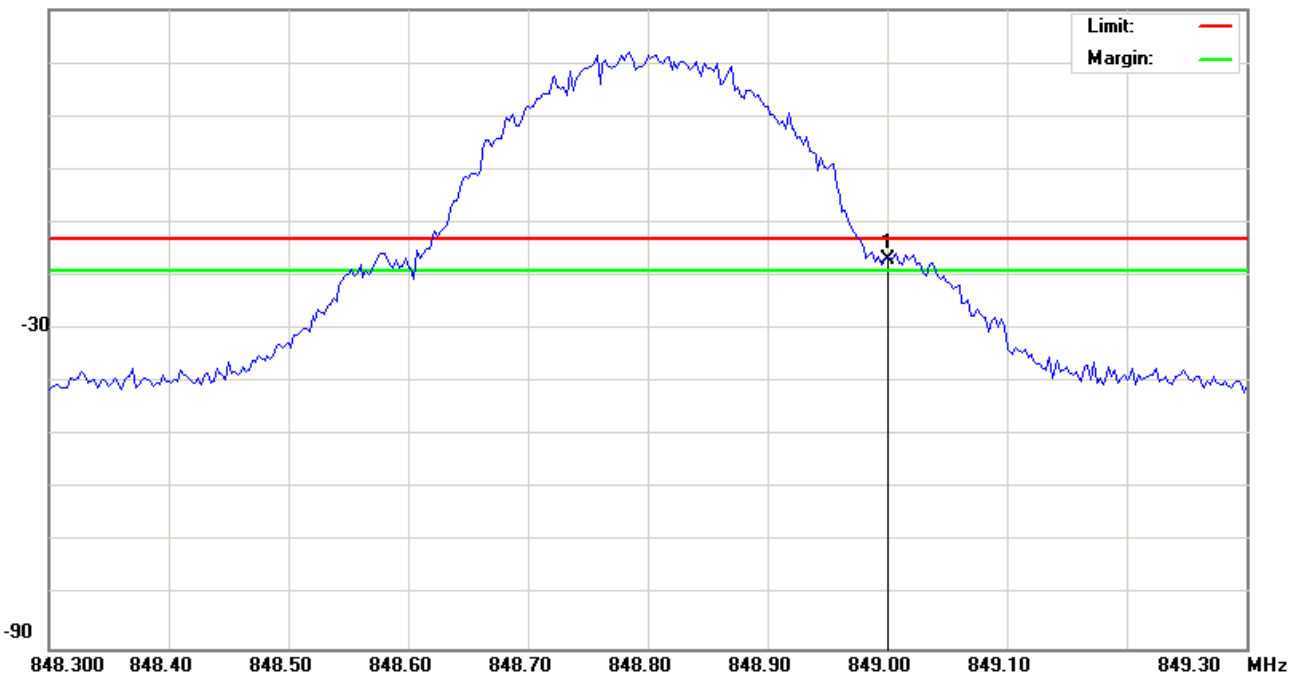

Site Polarization: **Conducted po** Temperature: 26 °C
 Limit: FCC Part 22 conducted(9k-12.75G) Power: AC 110V/60Hz Humidity: 55 %
 EUT: Distance:
 M/N: 08-0252-SEO
 Mode: GSM850(GPRS)
 Note: CH251
 加10db衰减器

No.	Mk.	Freq.	Reading Level	Correct Factor	Measurement	Limit	Over	Antenna Height	Table Degree		
		MHz	dBm	dB	dBm	dBm	dB	Detector	cm	degree	Comment
1	*	849.0000	-30.31	13.25	-17.06	-13.00	-4.06	peak			

*:Maximum data x:Over limit !:over margin

●Reference Only



GPRS 1900				
Band	Channel	Frequency (MHz)	Bandwidth (dBm)	Limit (dBm)
Lower	512	1849.980	-22.53	-13
Higher	810	1910.020	-20.30	-13

Please refer to next pager of detail testing data.



File :FD400(CH512)

Data :#1

Date: 2008/10/15

Time: 下午 09:50:03

30.0 dBm

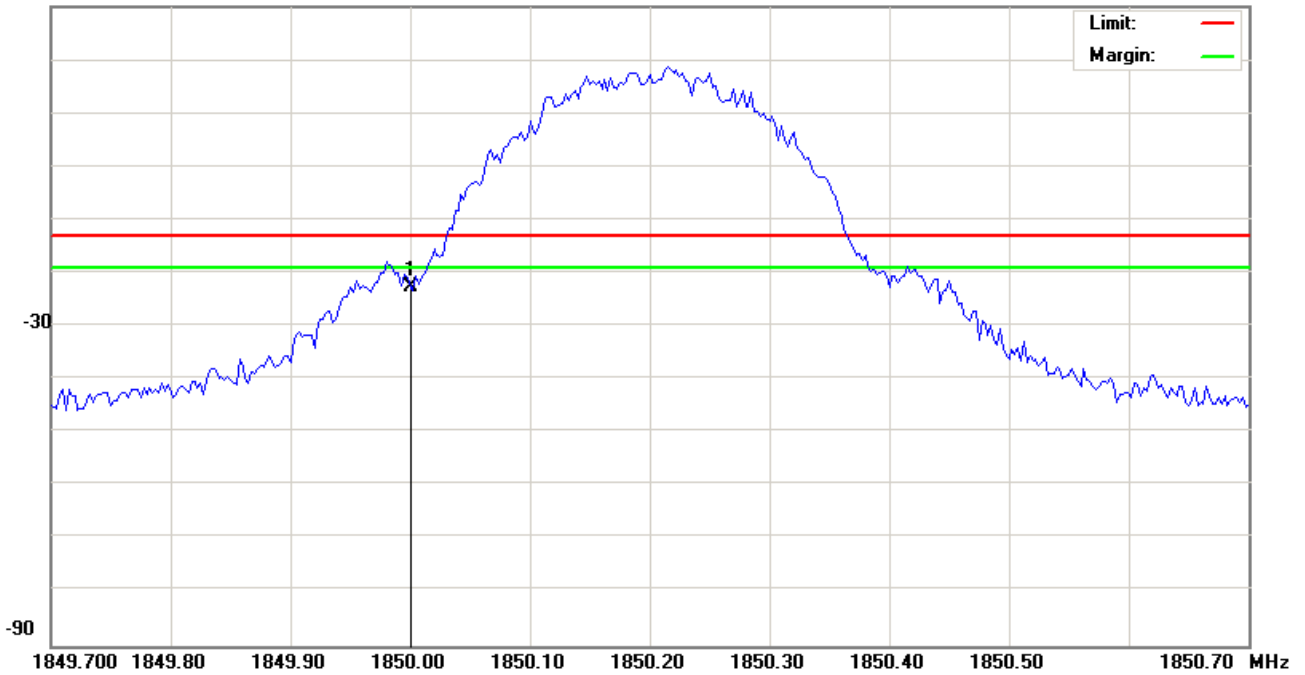

Site Polarization: **Conducted po** Temperature: 26 °C
 Limit: FCC Part 24 conducted(9k-12.75G) Power: AC 110V/60Hz Humidity: 55 %
 EUT: Distance:
 M/N: 08-0252-SEO
 Mode: PCS1900(GPRS)
 Note: CH512
 加10db衰减器

No.	Mk.	Freq. MHz	Reading Level dBm	Correct Factor dB	Measure- ment dBm	Limit dBm	Over dB	Antenna Height cm	Table Degree degree	Comment
1	*	1850.000	-26.79	4.26	-22.53	-13.00	-9.53	peak		

*:Maximum data x:Over limit !:over margin

●Reference Only



File :FD400(CH885)
30.0 dBm

Data :#1

Date: 2008/10/15

Time: 下午 09:55:06

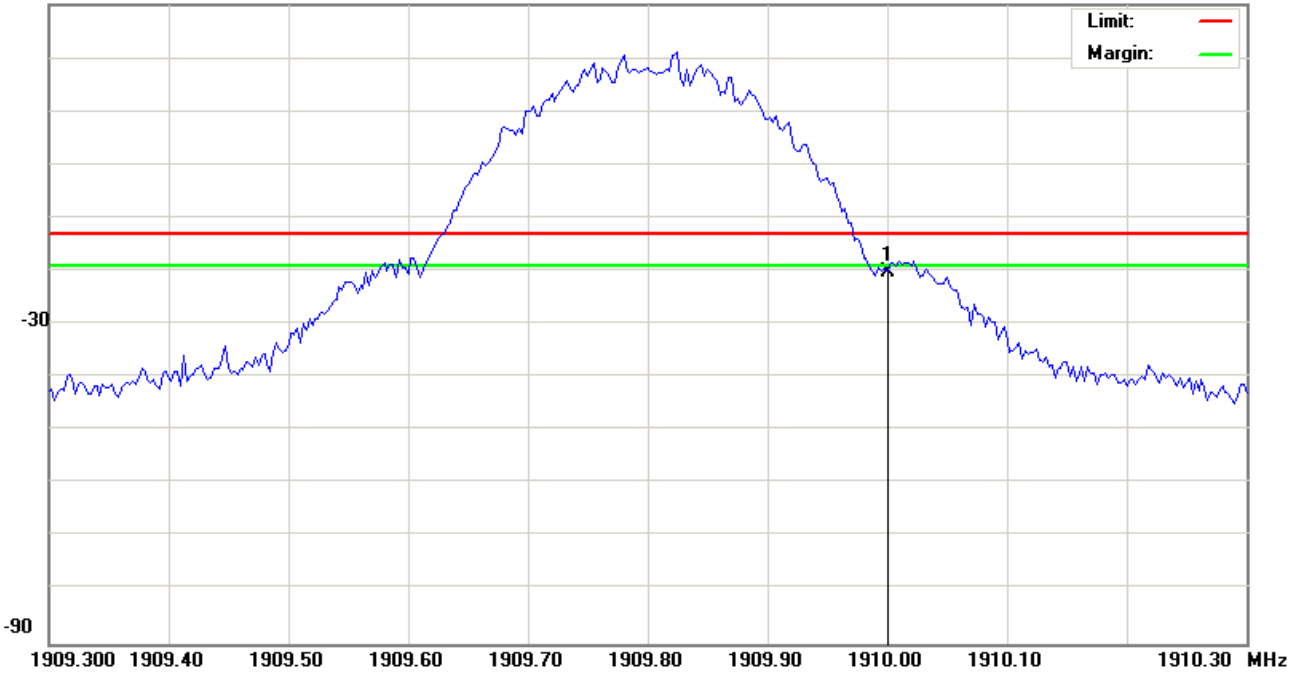

Site Polarization: **Conducted po** Temperature: 26 °C
 Limit: FCC Part 24 conducted(9k-12.75G) Power: AC 110V/60Hz Humidity: 55 %
 EUT: Distance:
 M/N: 08-0252-SEO
 Mode: PCS1900(GPRS)
 Note: CH810
 加10db衰减器

No.	Mk.	Freq.	Reading Level	Correct Factor	Measurement	Limit	Over	Antenna Height	Table Degree	Detector	Comment
		MHz	dBm	dB	dBm	dBm	dB	cm	degree		
1	*	1910.000	-26.00	5.70	-20.30	-13.00	-7.30			peak	

*:Maximum data x:Over limit !:over margin

●Reference Only



WCDMA Band V				
Band	Channel	Frequency (MHz)	Bandwidth (dBm)	Limit (dBm)
Lower	4132	824.000	-43.77	-13
Higher	4233	849.000	-47.77	-13

Please refer to next pager of detail testing data.



File :FD400(CH4132)
30.0 dBm

Data :#1

Date: 2008/10/15

Time: 下午 08:28:44

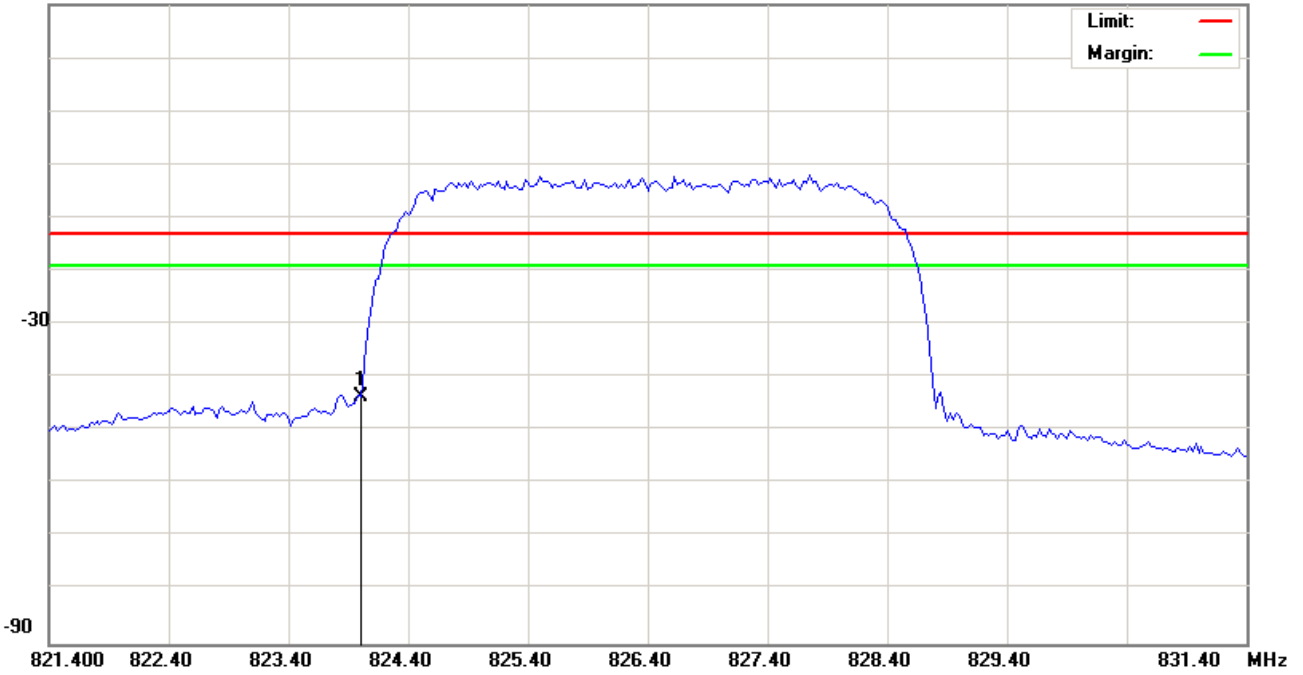

Site: Polarization: **Conducted po** Temperature: 26 °C
 Limit: FCC Part 24 conducted(9k-12.75G) Power: AC 110V/60Hz Humidity: 55 %
 EUT: Distance:
 M/N: 08-0252-SEO
 Mode: WCDMA(BANDV)
 Note: CH4132

No.	Mk.	Freq. MHz	Reading Level dBm	Correct Factor dB	Measure- ment dBm	Limit dBm	Over dB	Antenna Height cm	Table Degree degree	Comment
1	*	824.0000	-43.77	0.00	-43.77	-13.00	-30.77			peak

*:Maximum data x:Over limit !:over margin

●Reference Only



File :FD400(CH4233)
30.0 dBm

Data :#1

Date: 2008/10/15

Time: 下午 08:30:29

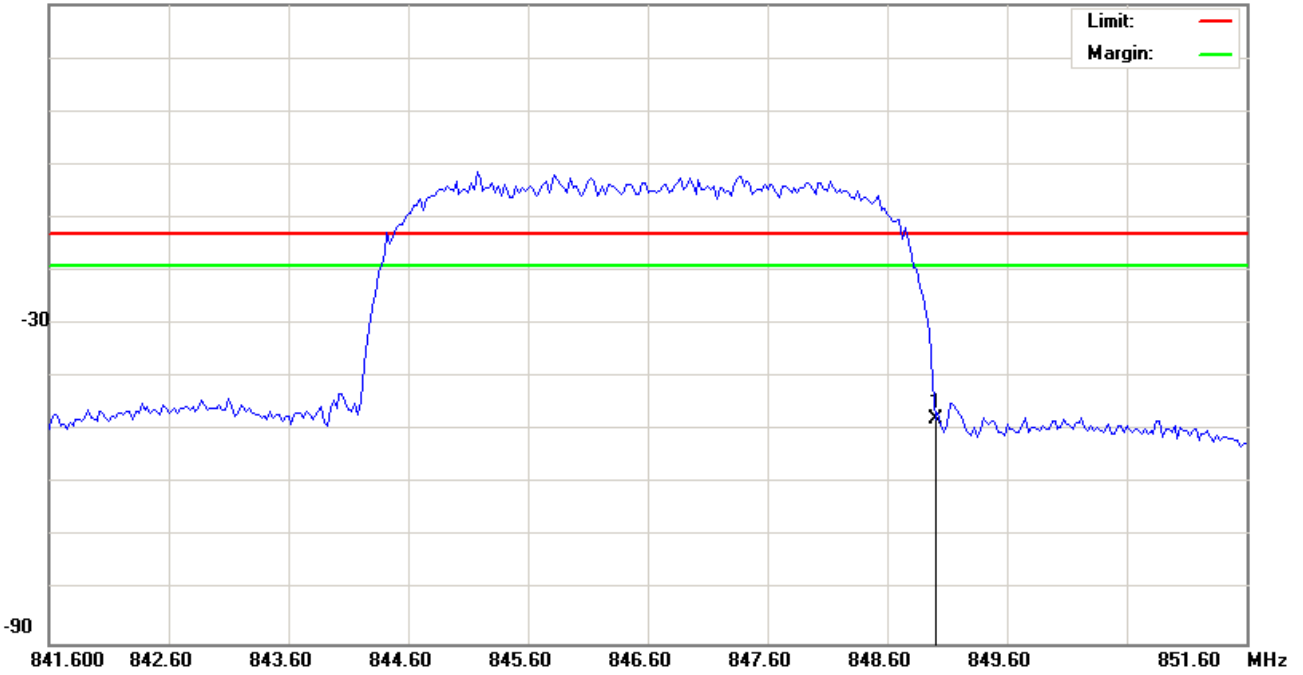

Site: Polarization: **Conducted po** Temperature: 26 °C
 Limit: FCC Part 24 conducted(9k-12.75G) Power: AC 110V/60Hz Humidity: 55 %
 EUT: Distance:
 M/N: 08-0252-SEO
 Mode: WCDMA(BANDV)
 Note: CH4132

No.	Mk.	Freq. MHz	Reading Level dBm	Correct Factor dB	Measure- ment dBm	Limit dBm	Over dB	Antenna Height cm	Table Degree	Detector	Comment
1	*	849.0000	-47.77	0.00	-47.77	-13.00	-34.77			peak	

*:Maximum data x:Over limit !:over margin

●Reference Only



WCDMA Band II				
Band	Channel	Frequency (MHz)	Bandwidth (dBm)	Limit (dBm)
Lower	9262	1850.000	-36.14	-13
Higher	9538	1910.000	-37.76	-13

Please refer to next pager of detail testing data.



File :FD400(CH9262)
30.0 dBm

Data :#1

Date: 2008/10/15

Time: 下午 08:06:41

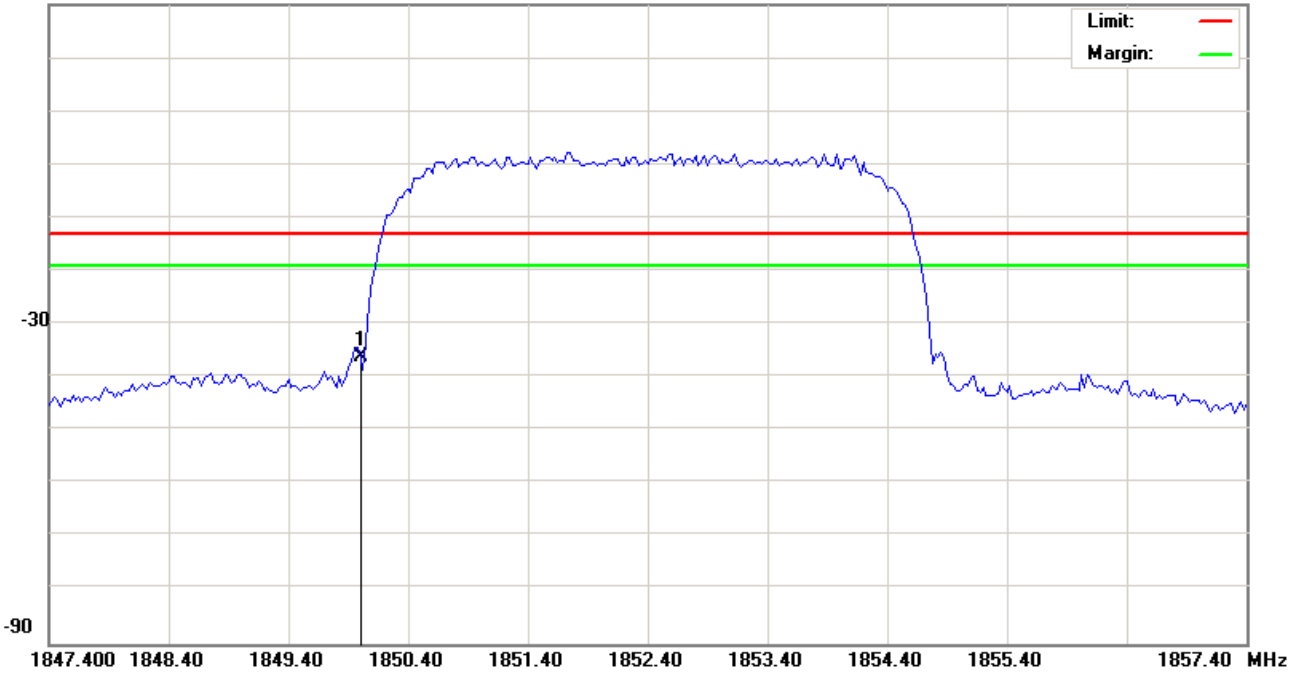

Site Polarization: **Conducted po** Temperature: 26 °C
 Limit: FCC Part 24 conducted(9k-12.75G) Power: AC 110V/60Hz Humidity: 55 %
 EUT: Distance:
 M/N: 08-0252-SEO
 Mode: WCDMA(BANDII)
 Note: CH512
 加10db衰減器

No.	Mk.	Freq. MHz	Reading Level dBm	Correct Factor dB	Measure- ment dBm	Limit dBm	Over dB	Antenna Height cm	Table Degree degree	Comment
1	*	1850.000	-40.40	4.26	-36.14	-13.00	-23.14			peak

*:Maximum data x:Over limit !:over margin

●Reference Only



File :FD400(CH9538)
30.0 dBm

Data :#1

Date: 2008/10/15

Time: 下午 08:21:32

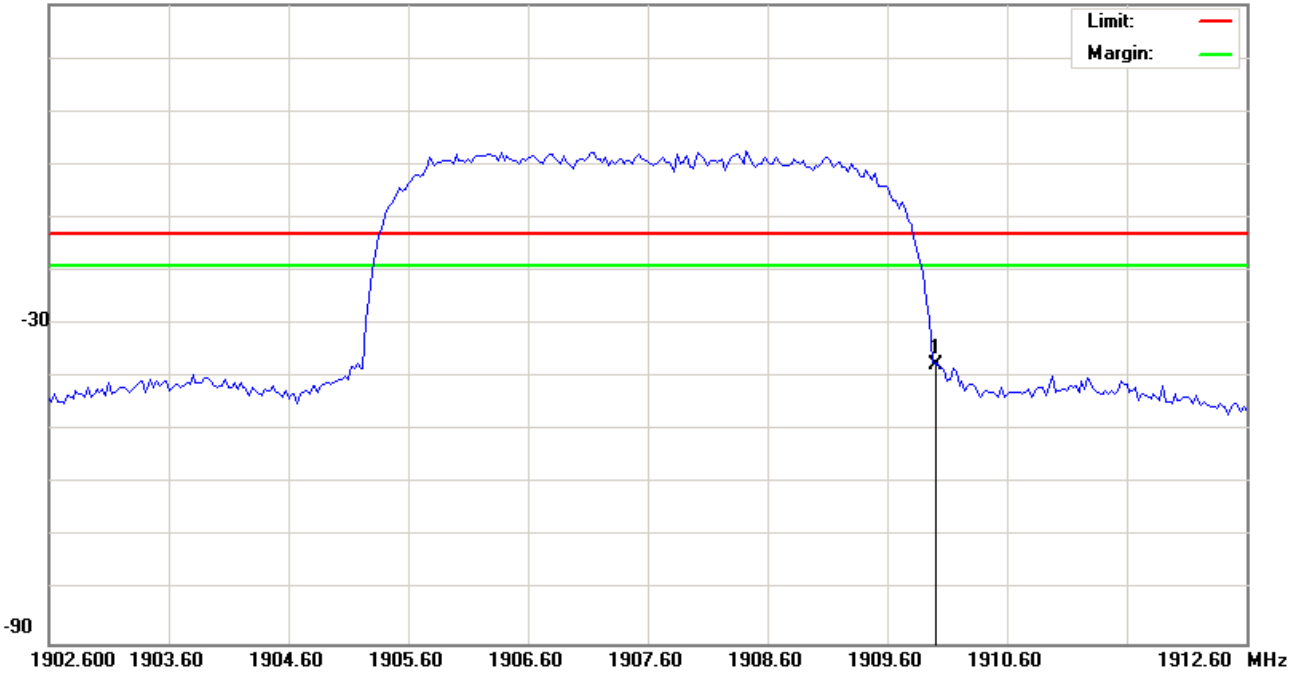

Site Polarization: **Conducted po** Temperature: 26 °C
 Limit: FCC Part 24 conducted(9k-12.75G) Power: AC 110V/60Hz Humidity: 55 %
 EUT: Distance:
 M/N: 08-0252-SEO
 Mode: WCDMA(BANDII)
 Note: CH512
 加10db衰減器

No.	Mk.	Freq. MHz	Reading Level dBm	Correct Factor dB	Measure- ment dBm	Limit dBm	Over dB	Antenna Height cm	Table Degree degree	Comment
1	*	1910.000	-43.46	5.70	-37.76	-13.00	-24.76	peak		

*:Maximum data x:Over limit !:over margin

●Reference Only

4.5 Conducted Emission

4.5.1 Measurement Instruments

As described in chapter 5 of this test report.

4.5.2 Test Procedure

1. The EUT was connected to Spectrum Analyzer and Base Station via power divider.
2. The middle channel for the highest RF power within the transmitting frequency was measured.
3. The conducted spurious emission for the whole frequency range was taken.
4. Test setting at GSM 850 RB>100 kHz, VB>100 kHz; PCS 1900 RB>1MHz, VB>1MHz.

4.5.3 Test Setup Layout

Below 2.8GHz

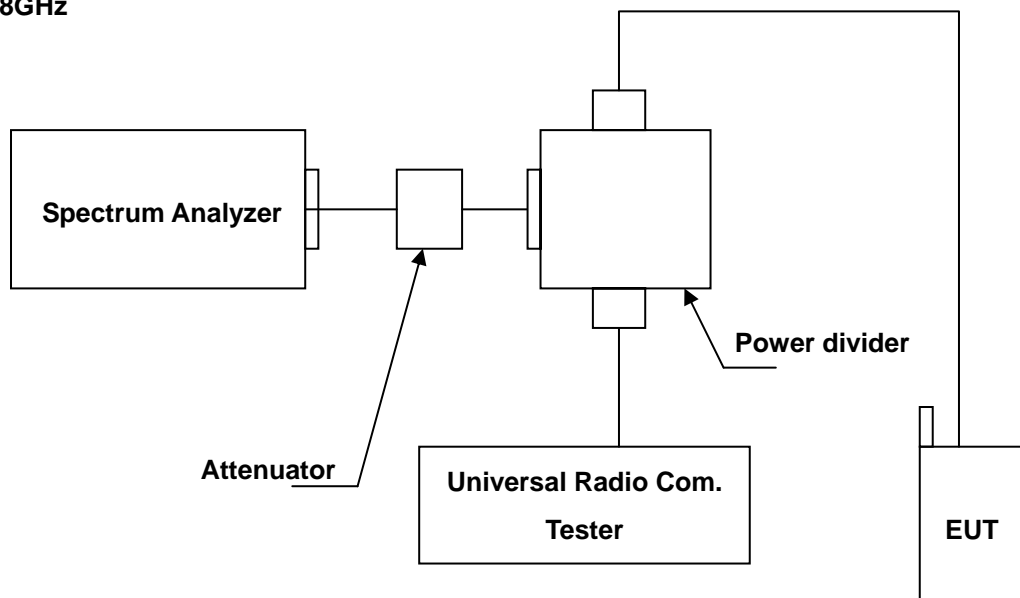

Above 2.8GHz

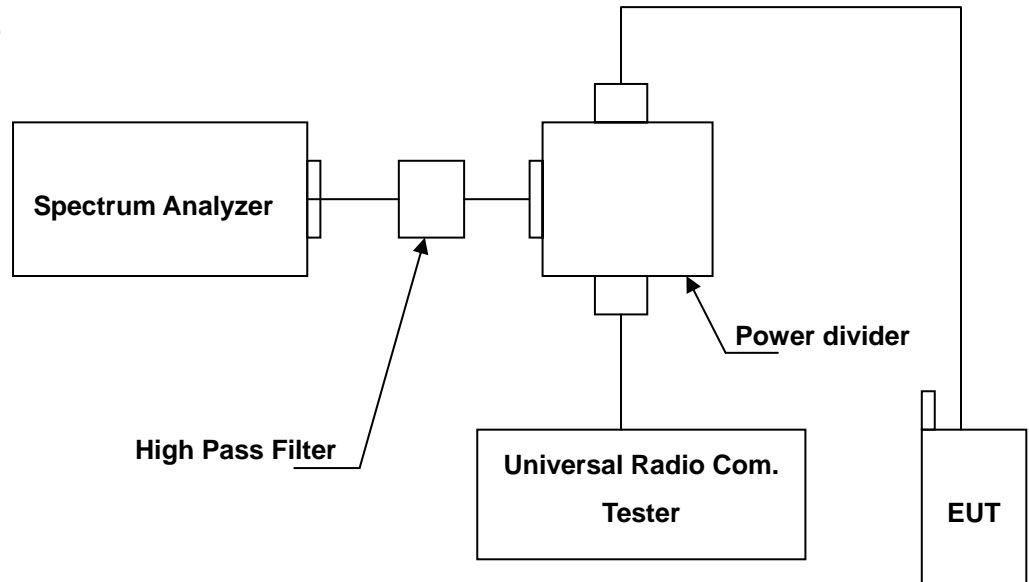



4.5.4 Test Result

4.5.4.1 GPRS 850 Test Result

Applicant : XAC Automation Corporation
Model No : FD-400
EUT : Portable Terminal
Test Mode : GPRS 850 (Low CH128 / Middle CH190 / High CH 251)
Test Date : 10/15/2008

Please refer to next pager of detail testing data.

Note: Amplitude= Reading Amplitude + Factor (Cable loss + Filter Amplitude= Insertion loss)
(Auto calculate in spectrum analyzer)



File :FD400(CH128)

Data :#1

Date: 2008/10/15

Time: 上午 01:13:35

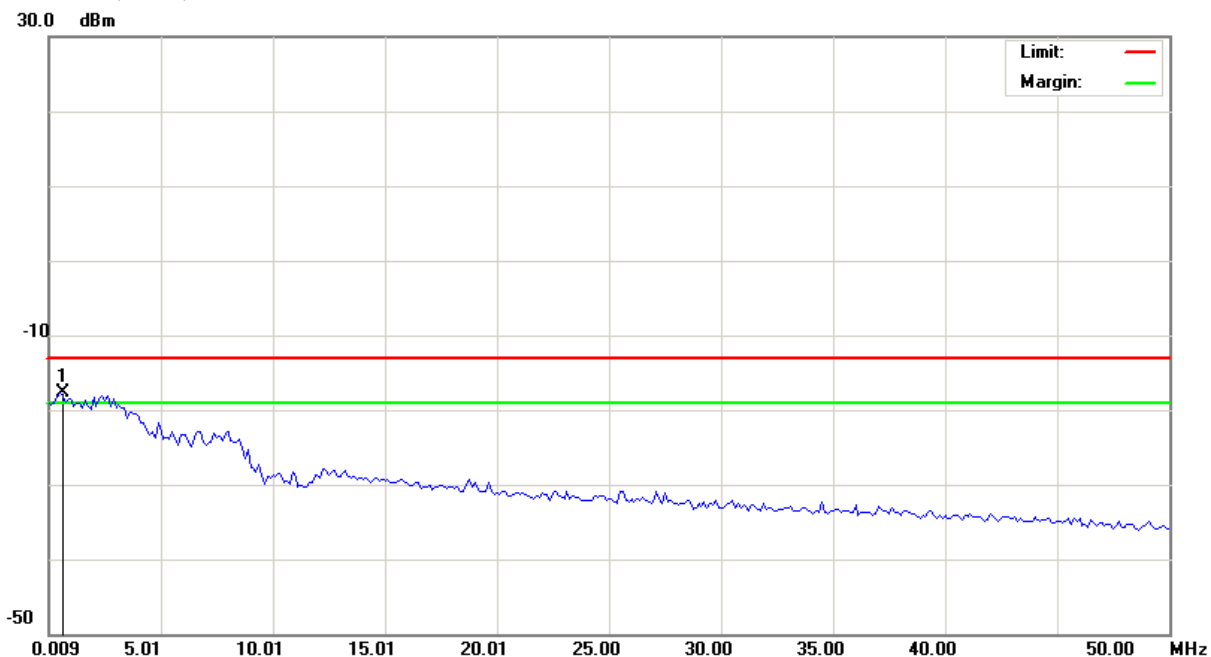

Site Polarization: **Conducted po** Temperature: 26 °C
 Limit: FCC Part 22 conducted(9k-12.75G) Power: AC 110V/60Hz Humidity: 55 %
 EUT: Distance:
 M/N: 08-0252-SEO
 Mode: GSM850(GPRS)
 Note: CH128
 加Notch(3TNF-800)

No.	Mk.	Freq.	Reading Level	Correct Factor	Measurement	Limit	Over	Antenna Height	Table Degree	Detector	Comment
		MHz	dBm	dB	dBm	dBm	dB	cm	degree		
1	*	0.5090	-49.67	32.02	-17.65	-13.00	-4.65			peak	

*:Maximum data x:Over limit !:over margin

●Reference Only



File :FD400(CH128)

Data :#2

Date: 2008/10/15

Time: 上午 01:13:56

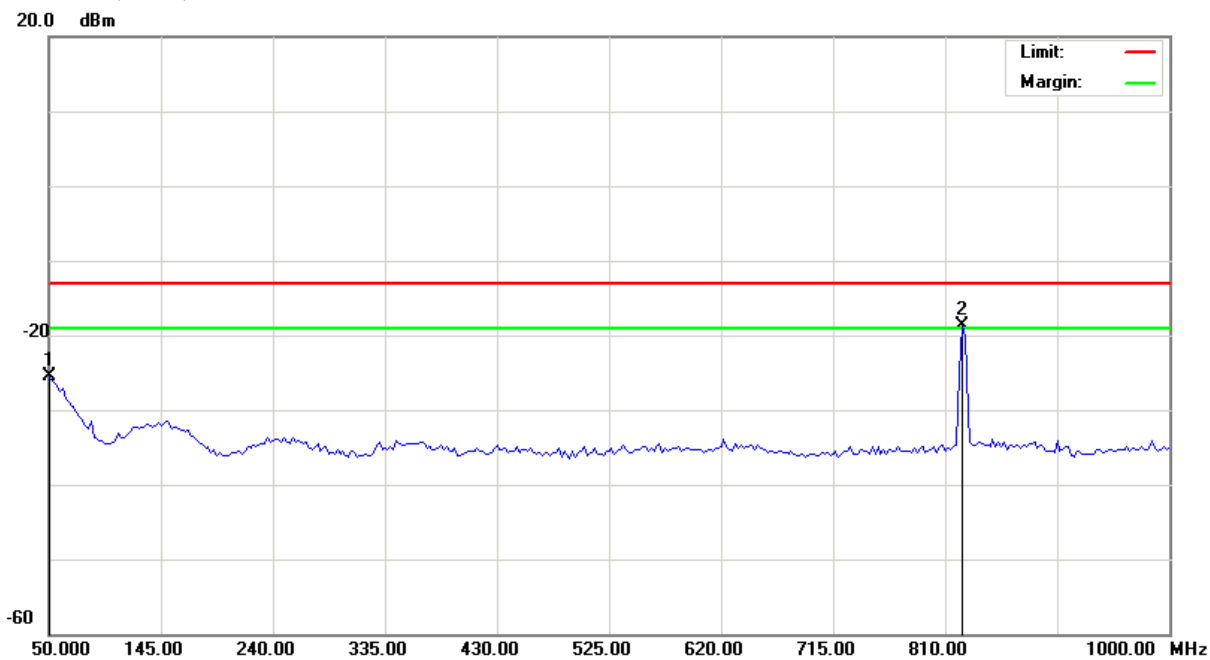

Site Polarization: **Conducted po** Temperature: 26 °C
 Limit: FCC Part 22 conducted(9k-12.75G) Power: AC 110V/60Hz Humidity: 55 %
 EUT: Distance:
 M/N: 08-0252-SEO
 Mode: GSM850(GPRS)
 Note: CH128
 加Notch(3TNF-800)

No.	Mk.	Freq.	Reading Level	Correct Factor	Measurement	Limit	Over	Antenna Height	Table Degree	Comment
		MHz	dBm	dB	dBm	dBm	dB	cm	degree	
1		50.0000	-40.15	14.69	-25.46	-13.00	-12.46	peak		
2	*	824.2500	-22.61	3.84	-18.77	-13.00	-5.77	peak		Main Frequency

*:Maximum data x:Over limit !:over margin

●Reference Only



File :FD400(CH128)

Data :#3

Date: 2008/10/15

Time: 上午 01:39:13

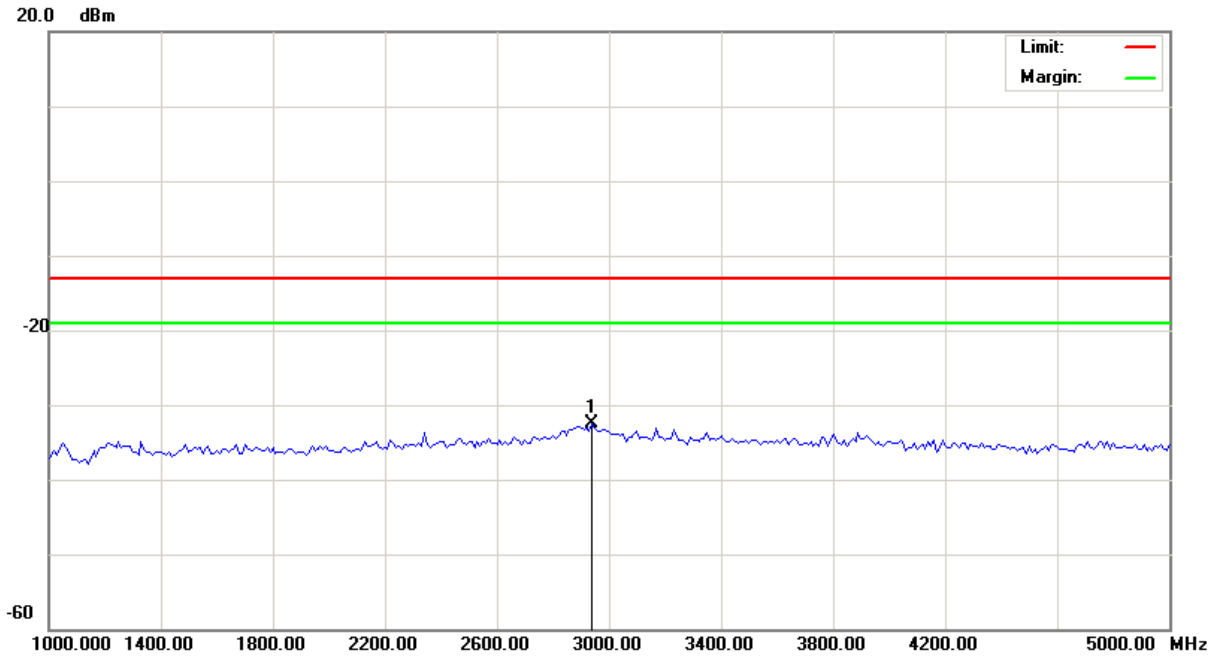

Site Polarization: **Conducted po** Temperature: 26 °C
 Limit: FCC Part 22 conducted(9k-12.75G) Power: AC 110V/60Hz Humidity: 55 %
 EUT: Distance:
 M/N: 08-0252-SEO
 Mode: GSM850(GPRS)
 Note: CH128

No.	Mk.	Freq.	Reading Level	Correct Factor	Measurement	Limit	Over	Antenna Height	Table Degree	Comment
		MHz	dBm	dB	dBm	dBm	dB	cm	degree	
1	*	2940.000	-37.04	4.62	-32.42	-13.00	-19.42	peak		

*:Maximum data x:Over limit !:over margin

●Reference Only



File :FD400(CH128)

Data :#4

Date: 2008/10/15

Time: 上午 01:39:34

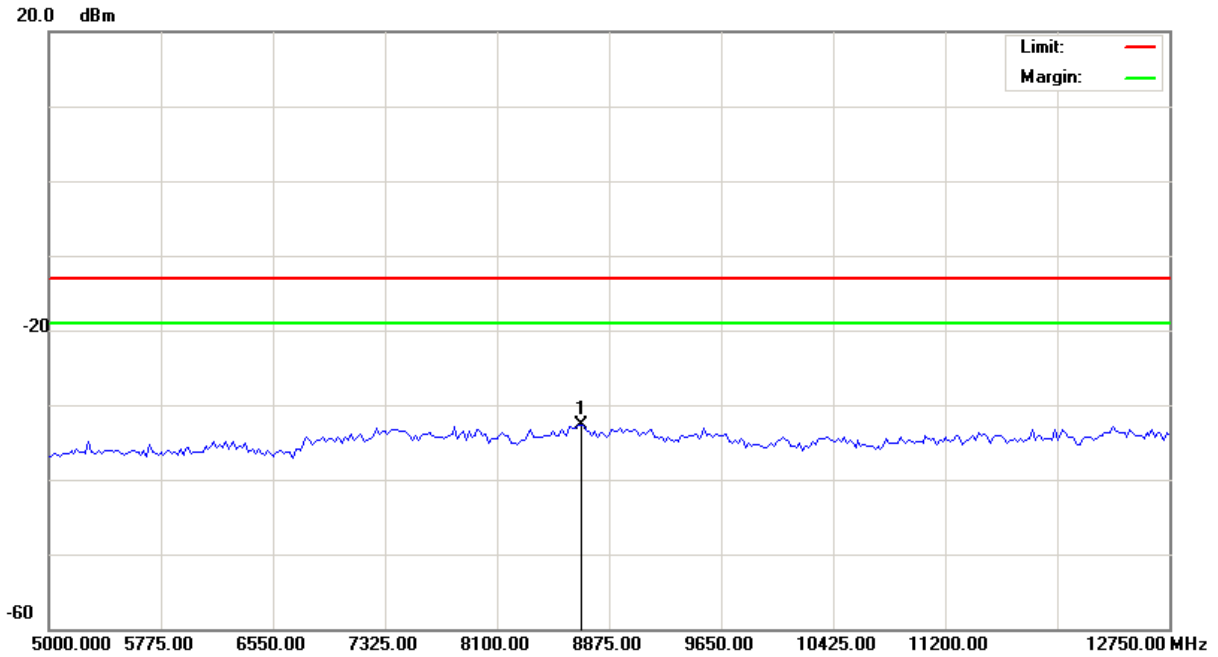

Site Polarization: **Conducted po** Temperature: 26 °C
 Limit: FCC Part 22 conducted(9k-12.75G) Power: AC 110V/60Hz Humidity: 55 %
 EUT: Distance:
 M/N: 08-0252-SEO
 Mode: GSM850(GPRS)
 Note: CH128

No.	Mk.	Freq.	Reading Level	Correct Factor	Measurement	Limit	Over	Antenna Height	Table Degree	Detector	Comment
		MHz	dBm	dB	dBm	dBm	dB	cm	degree		
1	*	8681.250	-38.17	5.52	-32.65	-13.00	-19.65			peak	

*:Maximum data x:Over limit !:over margin

●Reference Only



File :FD400(CH190)

Data :#1

Date: 2008/10/15

Time: 上午 01:15:27

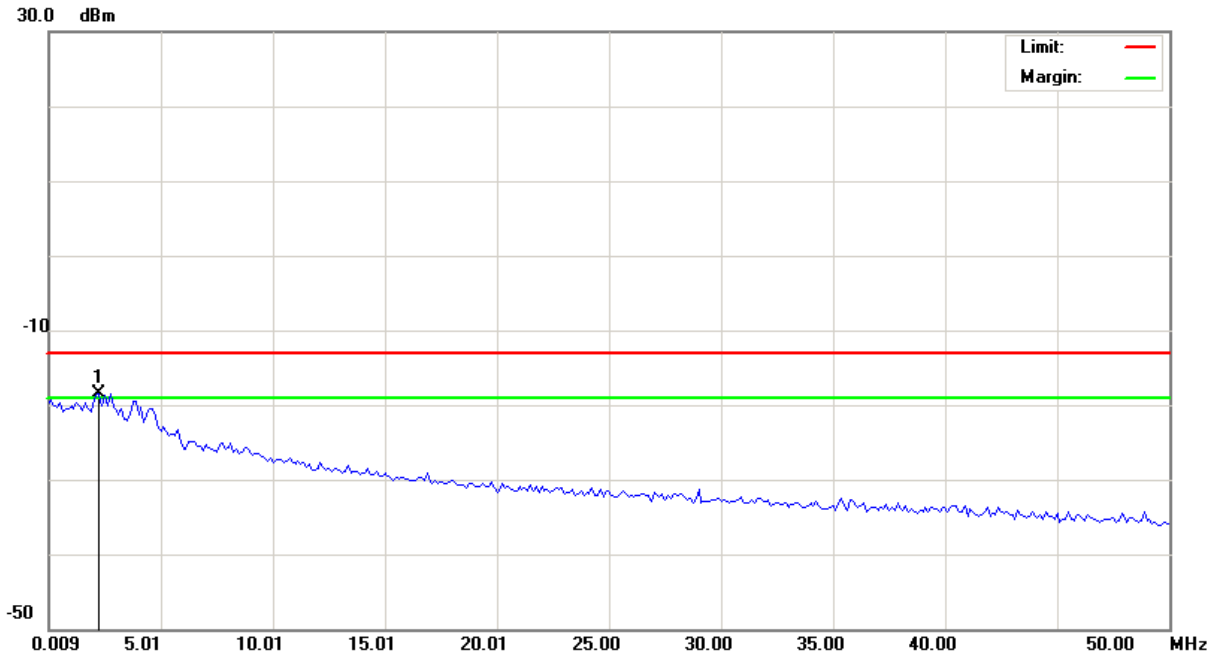

Site Polarization: **Conducted po** Temperature: 26 °C
 Limit: FCC Part 22 conducted(9k-12.75G) Power: AC 110V/60Hz Humidity: 55 %
 EUT: Distance:
 M/N: 08-0252-SEO
 Mode: GSM850(GPRS)
 Note: CH190
 加Notch(3TNF-800)

No.	Mk.	Freq.	Reading Level	Correct Factor	Measurement	Limit	Over	Antenna Height	Table Degree	
		MHz	dBm	dB	dBm	dBm	dB	cm	degree	Comment
1	*	2.2585	-49.59	31.14	-18.45	-13.00	-5.45	peak		

*:Maximum data x:Over limit !:over margin

●Reference Only



File :FD400(CH190)

Data :#2

Date: 2008/10/15

Time: 上午 01:15:48

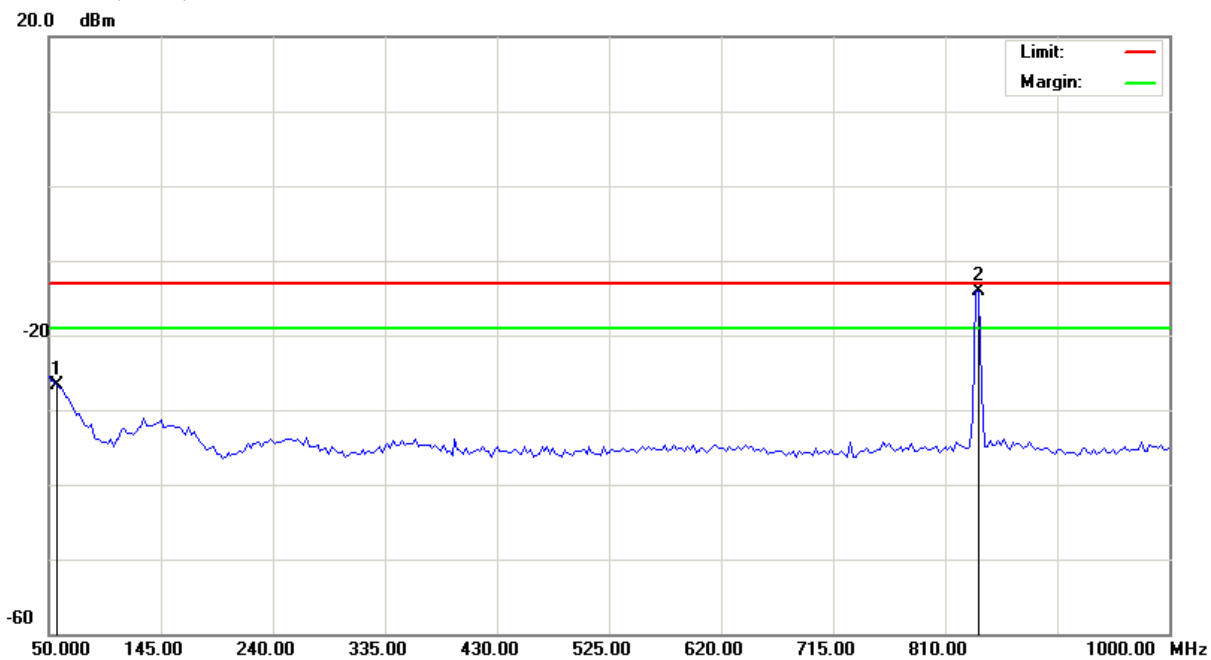

Site Polarization: **Conducted po** Temperature: 26 °C
 Limit: FCC Part 22 conducted(9k-12.75G) Power: AC 110V/60Hz Humidity: 55 %
 EUT: Distance:
 M/N: 08-0252-SEO
 Mode: GSM850(GPRS)
 Note: CH190
 加口Notch(3TNF-800)

No.	Mk.	Freq.	Reading Level	Correct Factor	Measurement	Limit	Over	Antenna Height	Table Degree	
		MHz	dBm	dB	dBm	dBm	dB	cm	degree	Comment
1		57.1250	-40.07	13.41	-26.66	-13.00	-13.66	peak		
2	*	838.5000	-18.01	3.97	-14.04	-13.00	-1.04	peak		Main Frequency

*:Maximum data x:Over limit !:over margin

●Reference Only



File :FD400(CH190)

Data :#3

Date: 2008/10/15

Time: 上午 01:40:15

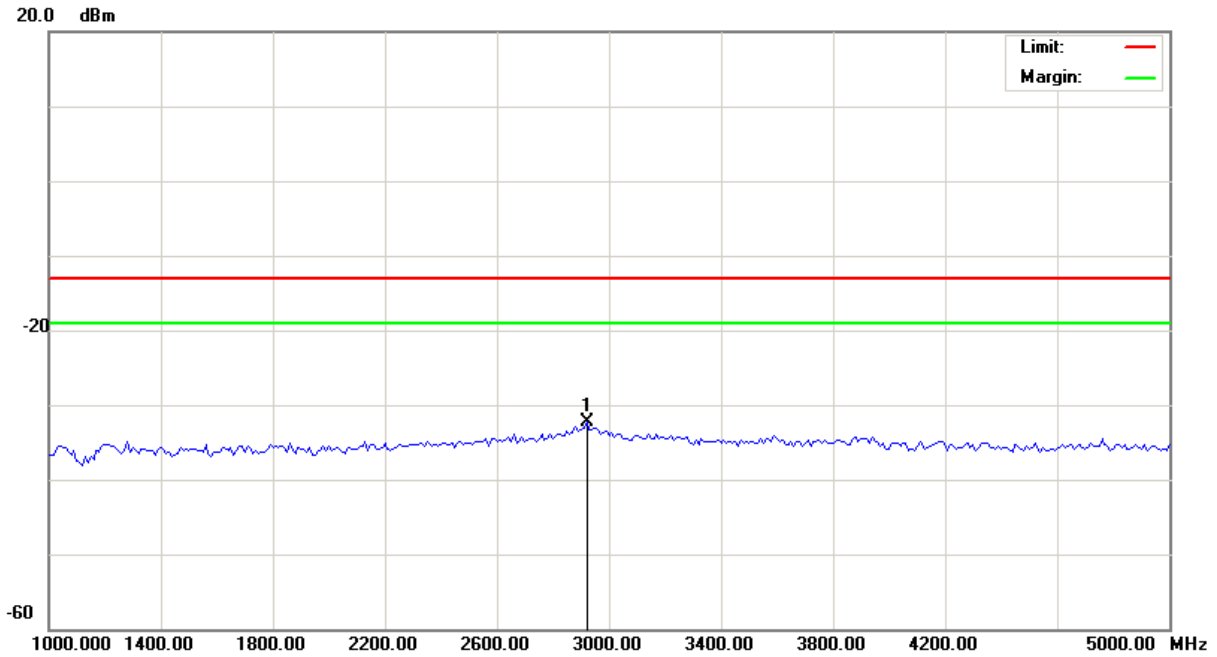

Site Polarization: **Conducted po** Temperature: 26 °C
 Limit: FCC Part 22 conducted(9k-12.75G) Power: AC 110V/60Hz Humidity: 55 %
 EUT: Distance:
 M/N: 08-0252-SEO
 Mode: GSM850(GPRS)
 Note: CH190

No.	Mk.	Freq.	Reading Level	Correct Factor	Measurement	Limit	Over	Antenna Height	Table Degree	Comment
		MHz	dBm	dB	dBm	dBm	dB	cm	degree	
1	*	2920.000	-36.94	4.69	-32.25	-13.00	-19.25	peak		

*:Maximum data x:Over limit !:over margin

●Reference Only



File :FD400(CH190)

Data :#4

Date: 2008/10/15

Time: 上午 01:40:36

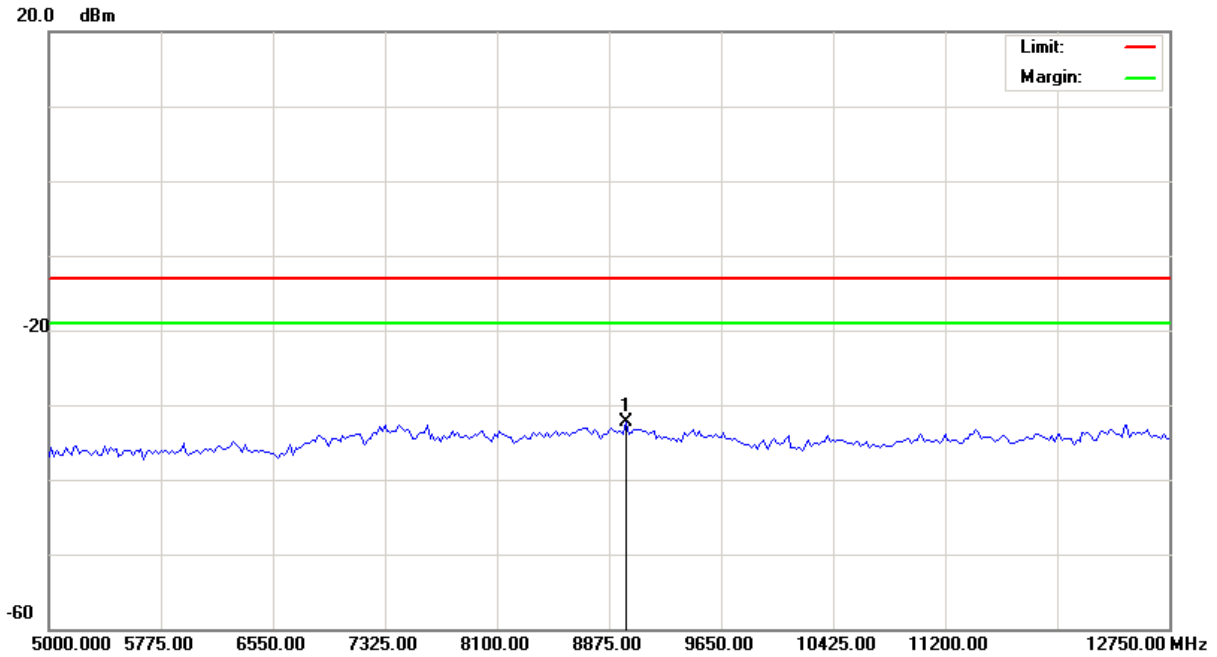

Site Polarization: **Conducted po** Temperature: 26 °C
 Limit: FCC Part 22 conducted(9k-12.75G) Power: AC 110V/60Hz Humidity: 55 %
 EUT: Distance:
 M/N: 08-0252-SEO
 Mode: GSM850(GPRS)
 Note: CH190

No.	Mk.	Freq.	Reading Level	Correct Factor	Measurement	Limit	Over	Antenna Height	Table Degree	Detector	Comment
		MHz	dBm	dB	dBm	dBm	dB	cm	degree		
1	*	8991.250	-37.91	5.54	-32.37	-13.00	-19.37			peak	

*:Maximum data x:Over limit !:over margin

●Reference Only



File :FD400(CH251)

Data :#1

Date: 2008/10/15

Time: 上午 01:17:05

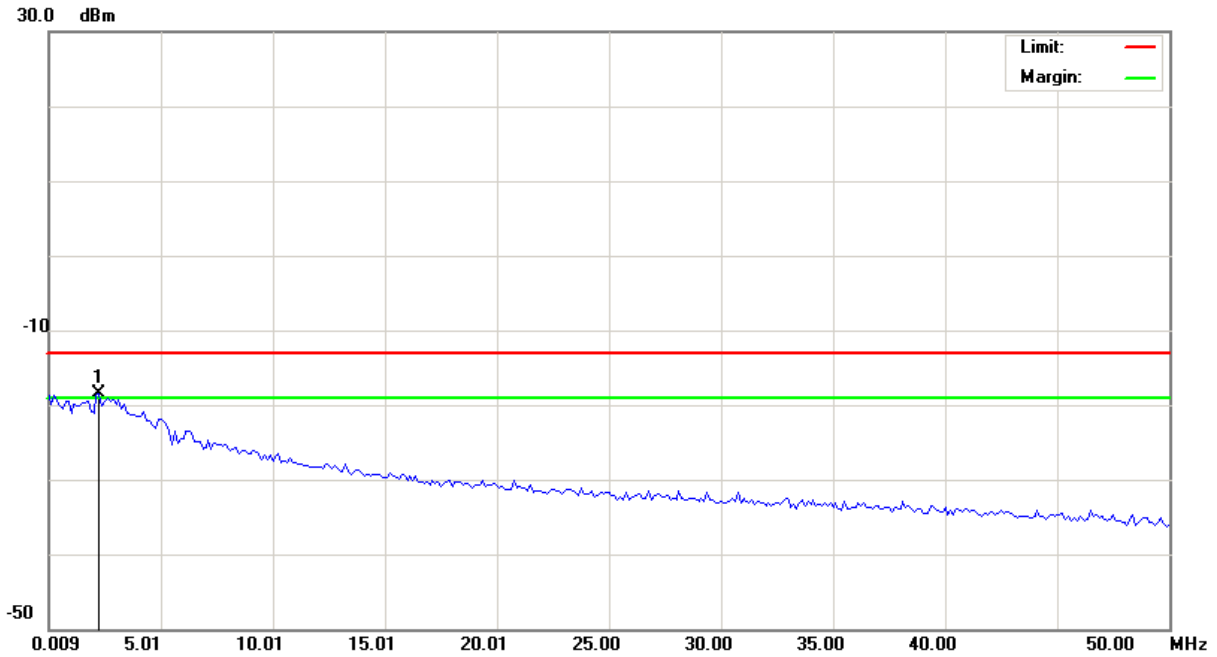

Site: Polarization: **Conducted po** Temperature: 26 °C
 Limit: FCC Part 22 conducted(9k-12.75G) Power: AC 110V/60Hz Humidity: 55 %
 EUT: Distance:
 M/N: 08-0252-SEO
 Mode: GSM850(GPRS)
 Note: CH251
 加Notch(3TNF-800)

No.	Mk.	Freq.	Reading Level	Correct Factor	Measurement	Limit	Over	Antenna Height	Table Degree	Detector	Comment
		MHz	dBm	dB	dBm	dBm	dB	cm	degree		
1	*	2.2585	-49.56	31.14	-18.42	-13.00	-5.42			peak	

*:Maximum data x:Over limit !:over margin

●Reference Only



File :FD400(CH251)

Data :#2

Date: 2008/10/15

Time: 上午 01:17:25

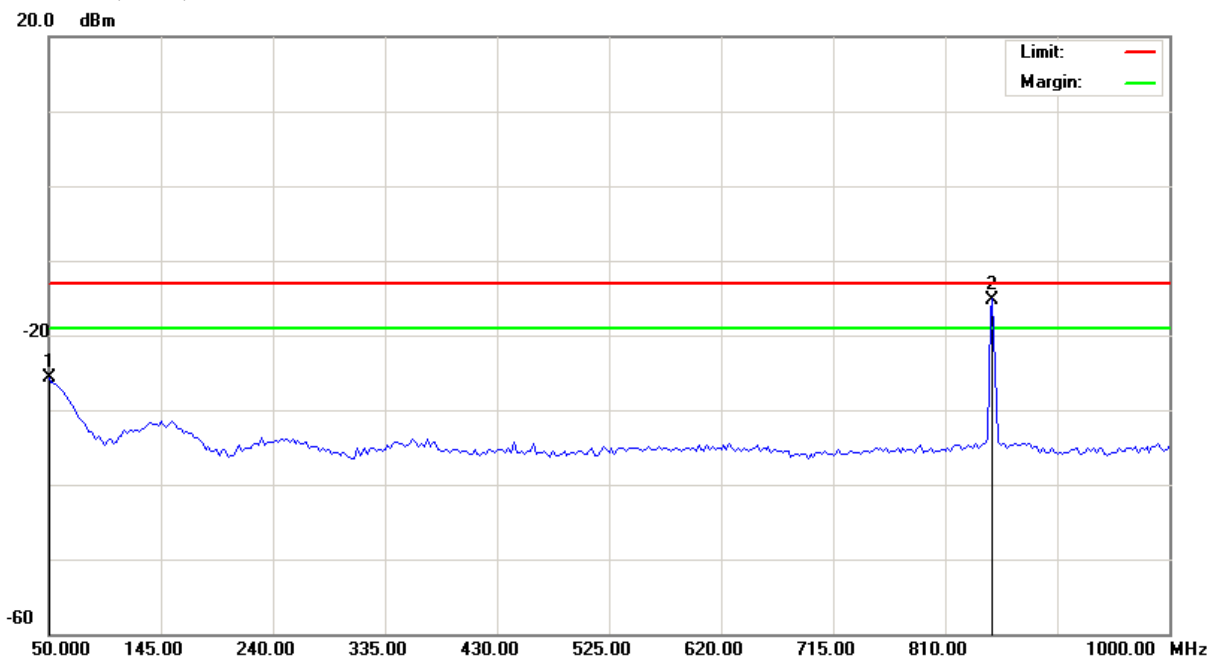

Site Polarization: **Conducted po** Temperature: 26 °C
 Limit: FCC Part 22 conducted(9k-12.75G) Power: AC 110V/60Hz Humidity: 55 %
 EUT: Distance:
 M/N: 08-0252-SEO
 Mode: GSM850(GPRS)
 Note: CH251
 加口Notch(3TNF-800)

No.	Mk.	Freq.	Reading Level	Correct Factor	Measurement	Limit	Over	Antenna Height	Table Degree	
		MHz	dBm	dB	dBm	dBm	dB	cm	degree	Comment
1		50.0000	-40.41	14.69	-25.72	-13.00	-12.72	peak		
2	*	850.3750	-19.18	3.98	-15.20	-13.00	-2.20	peak		Main Frequency

*:Maximum data x:Over limit !:over margin

●Reference Only



File :FD400(CH251)

Data :#3

Date: 2008/10/15

Time: 上午 01:41:16

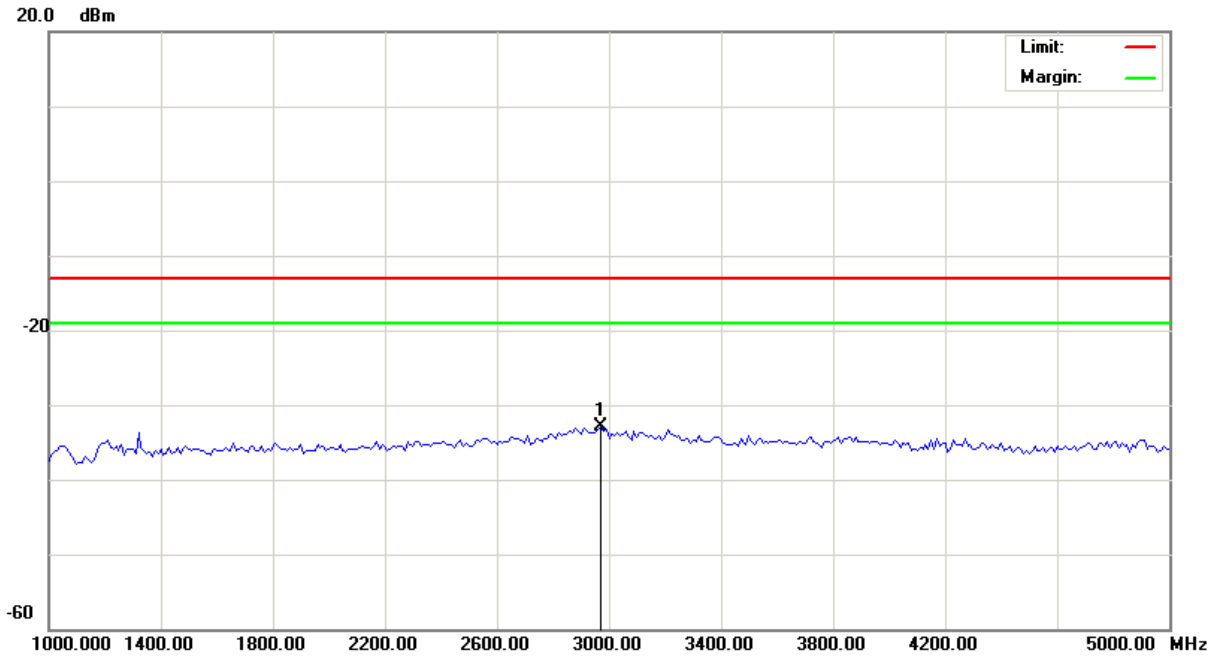

Site Polarization: **Conducted po** Temperature: 26 °C
 Limit: FCC Part 22 conducted(9k-12.75G) Power: AC 110V/60Hz Humidity: 55 %
 EUT: Distance:
 M/N: 08-0252-SEO
 Mode: GSM850(GPRS)
 Note: CH251

No.	Mk.	Freq.	Reading Level	Correct Factor	Measurement	Limit	Over	Antenna Height	Table Degree	Detector	Comment
		MHz	dBm	dB	dBm	dBm	dB	cm	degree		
1	*	2970.000	-37.47	4.56	-32.91	-13.00	-19.91			peak	

*:Maximum data x:Over limit !:over margin

●Reference Only



File :FD400(CH251)

Data :#4

Date: 2008/10/15

Time: 上午 01:41:37

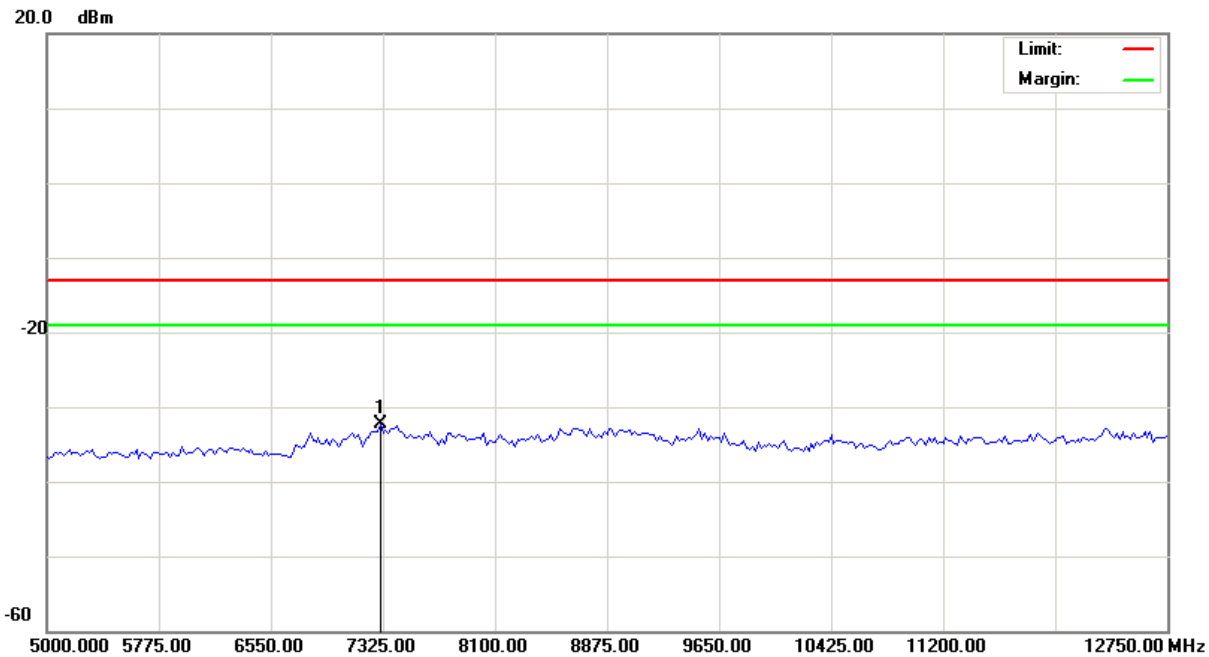

Site Polarization: **Conducted po** Temperature: 26 °C
 Limit: FCC Part 22 conducted(9k-12.75G) Power: AC 110V/60Hz Humidity: 55 %
 EUT: Distance:
 M/N: 08-0252-SEO
 Mode: GSM850(GPRS)
 Note: CH251

No.	Mk.	Freq.	Reading Level	Correct Factor	Measurement	Limit	Over	Antenna Height	Table Degree	
		MHz	dBm	dB	dBm	dBm	dB	cm	degree	Comment
1	*	7305.625	-37.45	5.15	-32.30	-13.00	-19.30	peak		

*:Maximum data x:Over limit !:over margin

●Reference Only



4.5.4.2 GPRS 1900 Test Result

Applicant : XAC Automation Corporation
Model No : FD-400
EUT : Portable Terminal
Test Mode : GPRS 1900 (Low CH512 / Middle CH661 / High CH 810)
Test Date : 10/14~15/2008

Please refer to next pager of detail testing data.

Note: Amplitude= Reading Amplitude + Factor (Cable loss + Filter Amplitude= Insertion loss)
(Auto calculate in spectrum analyzer)



File :FD400(CH512)

Data :#1

Date: 2008/10/14

Time: 下午 11:38:44

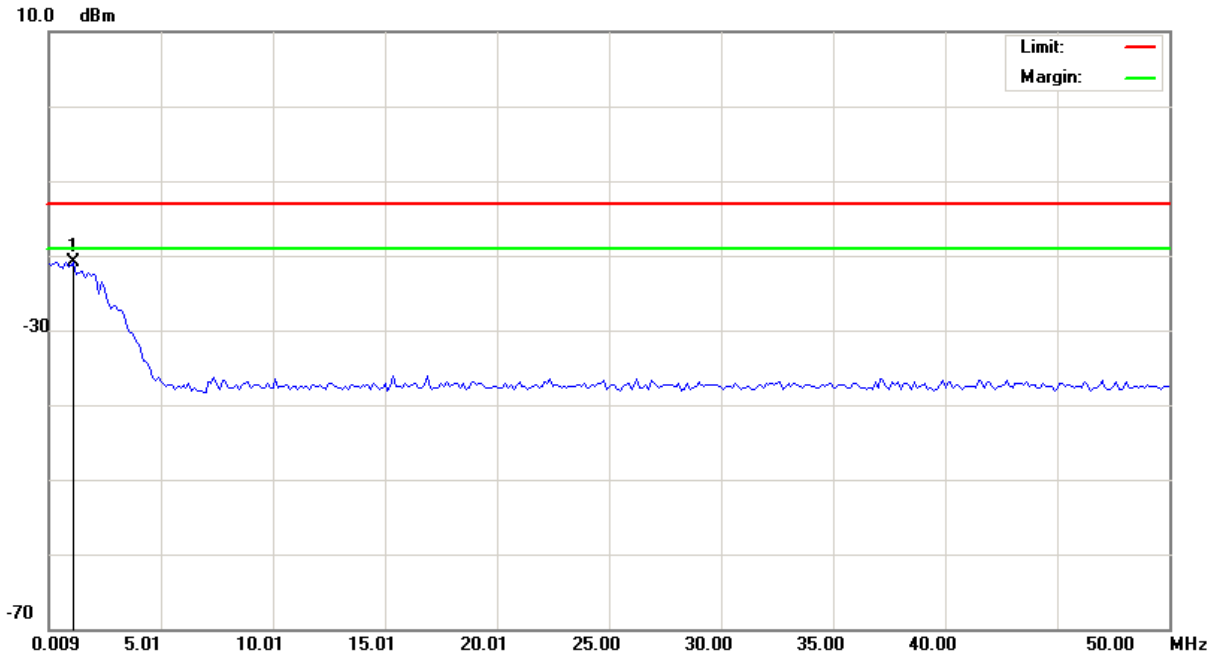

Site Polarization: **Conducted po** Temperature: 26 °C
 Limit: FCC Part 24 conducted(9k-12.75G) Power: AC 110V/60Hz Humidity: 55 %
 EUT: Distance:
 M/N: 08-0252-SEO
 Mode: PCS1900(GPRS)
 Note: CH512
 加10db衰减器

No.	Mk.	Freq.	Reading Level	Correct Factor	Measurement	Limit	Over	Antenna Height	Table Degree	
		MHz	dBm	dB	dBm	dBm	dB	cm	degree	Comment
1	*	1.1334	-33.42	12.56	-20.86	-13.00	-7.86			peak

*:Maximum data x:Over limit !:over margin

●Reference Only



File :FD400(CH512)

Data :#2

Date: 2008/10/14

Time: 下午 11:39:04

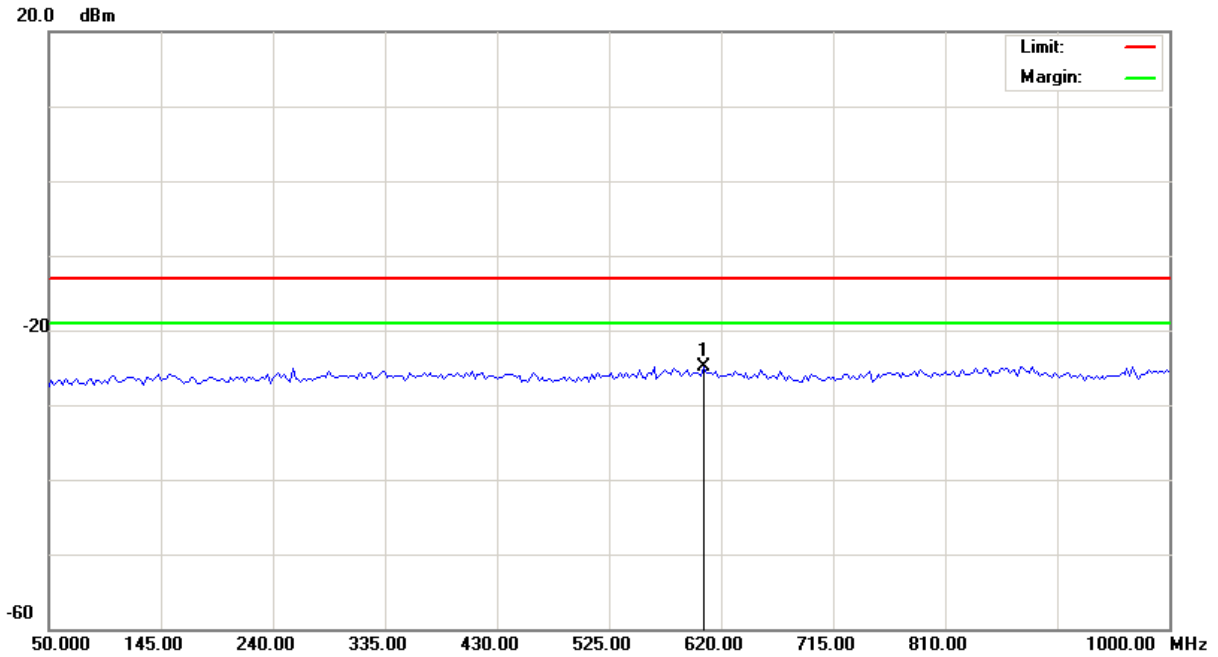

Site Polarization: **Conducted po** Temperature: 26 °C
 Limit: FCC Part 24 conducted(9k-12.75G) Power: AC 110V/60Hz Humidity: 55 %
 EUT: Distance:
 M/N: 08-0252-SEO
 Mode: PCS1900(GPRS)
 Note: CH512
 加10db衰减器

No.	Mk.	Freq.	Reading Level	Correct Factor	Measurement	Limit	Over	Antenna Height	Table Degree	
		MHz	dBm	dB	dBm	dBm	dB	cm	degree	Comment
1	*	605.7500	-37.98	13.16	-24.82	-13.00	-11.82	peak		

*:Maximum data x:Over limit !:over margin

●Reference Only



File :FD400(CH512)

Data :#3

Date: 2008/10/14

Time: 下午 11:49:36

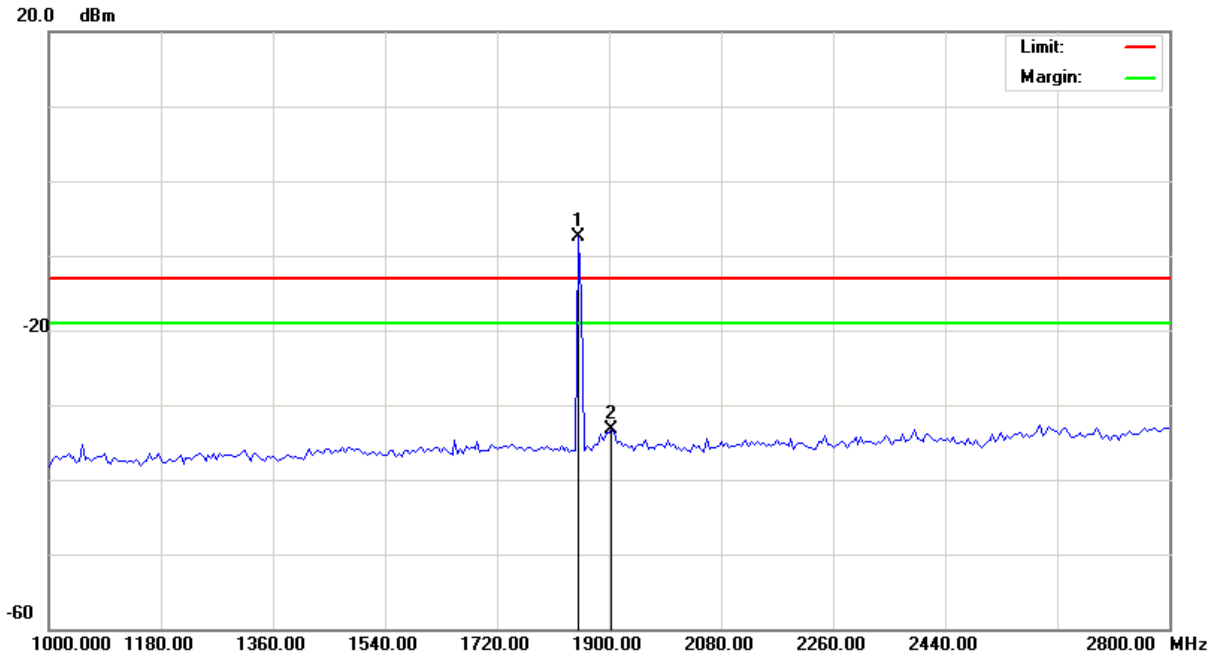

Site Polarization: **Conducted po** Temperature: 26 °C
 Limit: FCC Part 24 conducted(9k-12.75G) Power: AC 110V/60Hz Humidity: 55 %
 EUT: Distance:
 M/N: 08-0252-SEO
 Mode: PCS1900(GPRS)
 Note: CH512
 加口Notch(5TNF-1700)

No.	Mk.	Freq.	Reading Level	Correct Factor	Measurement	Limit	Over	Antenna Height	Table Degree	Comment
		MHz	dBm	dB	dBm	dBm	dB	Detector	cm	degree
1	*	1850.500	-11.72	4.26	-7.46	-13.00	5.54	peak		Main Frequency
2		1904.500	-39.59	6.21	-33.38	-13.00	-20.38	peak		

*:Maximum data x:Over limit !:over margin

●Reference Only



File :FD400(CH512)

Data :#4

Date: 2008/10/15

Time: 上午 01:30:59

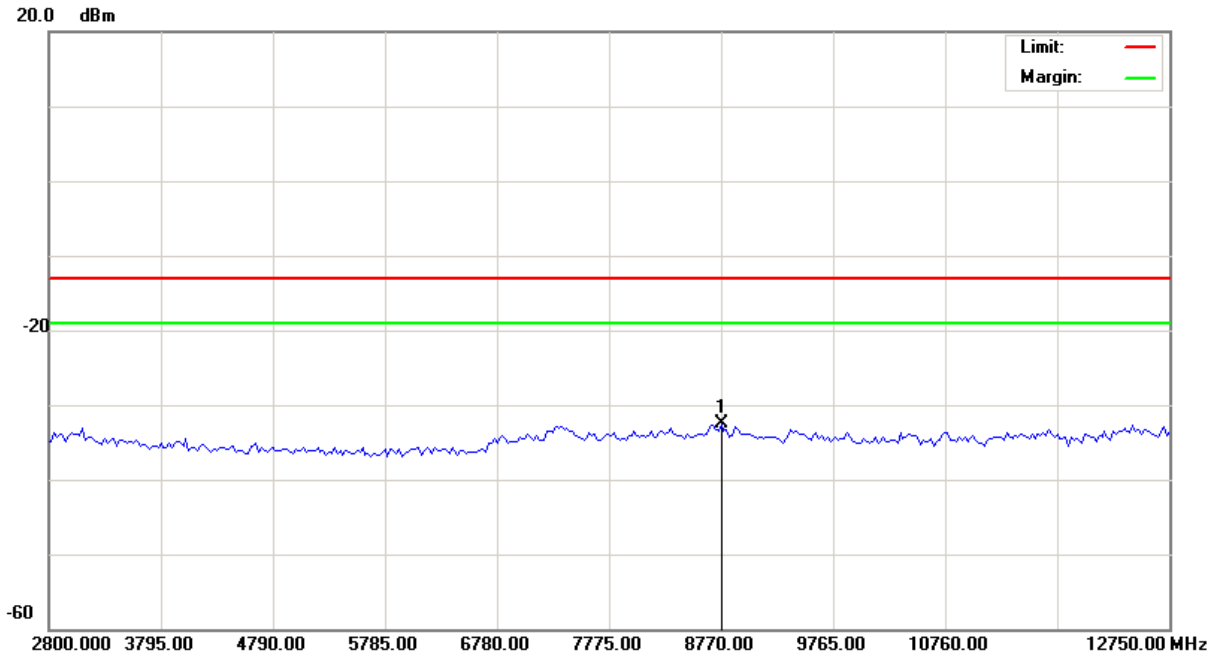

Site Polarization: **Conducted po** Temperature: 26 °C
 Limit: FCC Part 24 conducted(9k-12.75G) Power: AC 110V/60Hz Humidity: 55 %
 EUT: Distance:
 M/N: 08-0252-SEO
 Mode: PCS1900(GPRS)
 Note: CH512

No.	Mk.	Freq.	Reading Level	Correct Factor	Measurement	Limit	Over	Antenna Height	Table Degree	
		MHz	dBm	dB	dBm	dBm	dB	cm	degree	Comment
1	*	8770.000	-38.23	5.68	-32.55	-13.00	-19.55			peak

*:Maximum data x:Over limit !:over margin

●Reference Only



File :FD400(CH512)

Data :#5

Date: 2008/10/15

Time: 上午 01:31:20

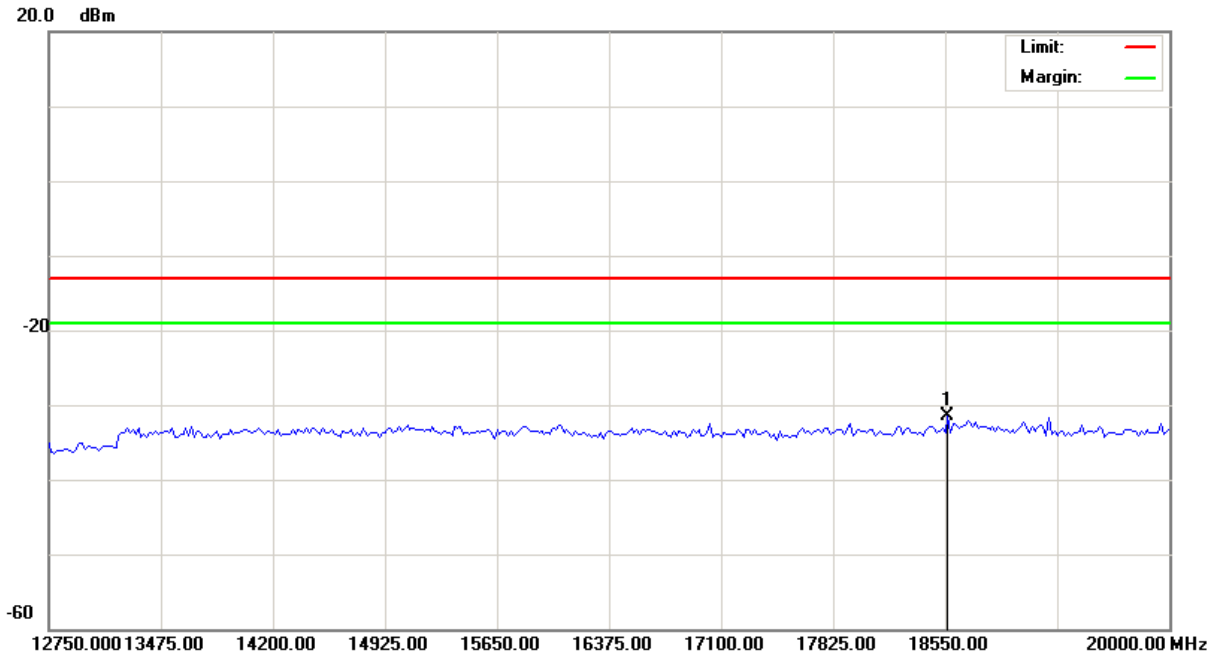

Site Polarization: **Conducted po** Temperature: 26 °C
 Limit: FCC Part 24 conducted(9k-12.75G) Power: AC 110V/60Hz Humidity: 55 %
 EUT: Distance:
 M/N: 08-0252-SEO
 Mode: PCS1900(GPRS)
 Note: CH512

No.	Mk.	Freq.	Reading Level	Correct Factor	Measurement	Limit	Over	Antenna Height	Table Degree	Comment
		MHz	dBm	dB	dBm	dBm	dB	cm	degree	
1	*	18568.12	-38.54	7.03	-31.51	-13.00	-18.51	peak		

*:Maximum data x:Over limit !:over margin

●Reference Only



File :FD400(CH661)

Data :#1

Date: 2008/10/14

Time: 下午 11:40:28

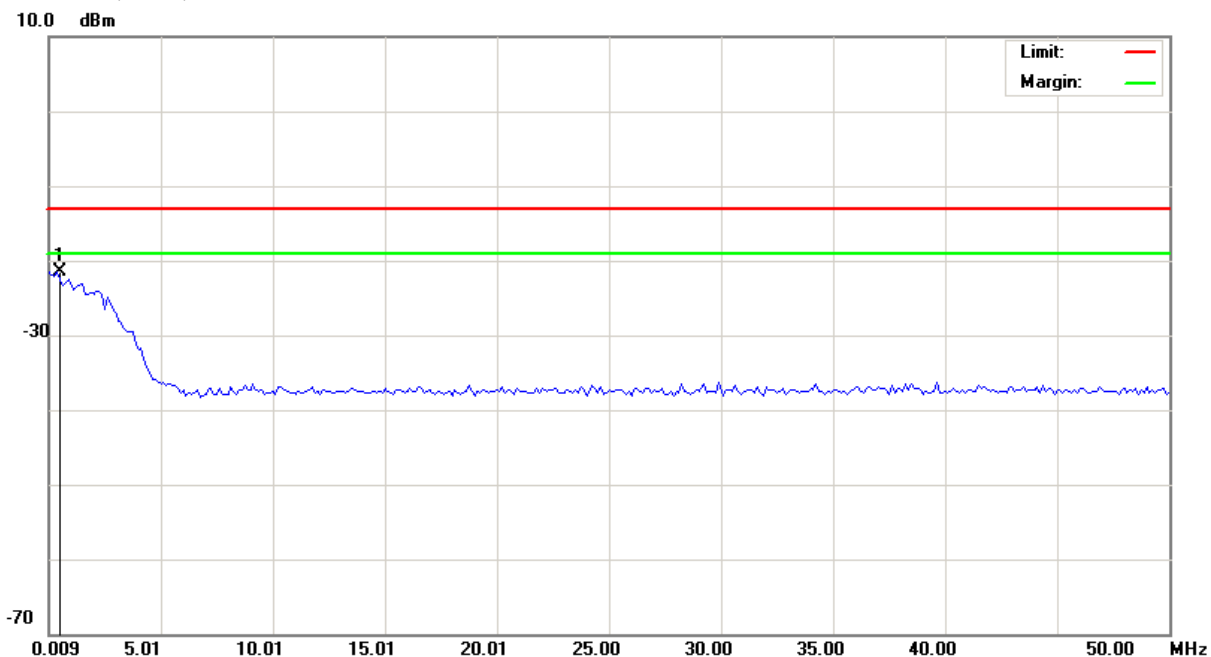

Site Polarization: **Conducted po** Temperature: 26 °C
 Limit: FCC Part 24 conducted(9k-12.75G) Power: AC 110V/60Hz Humidity: 55 %
 EUT: Distance:
 M/N: 08-0252-SEO
 Mode: PCS1900(GPRS)
 Note: CH661
 加10db衰减器

No.	Mk.	Freq.	Reading Level	Correct Factor	Measurement	Limit	Over	Antenna Height	Table Degree	
		MHz	dBm	dB	dBm	dBm	dB	cm	degree	Comment
1	*	0.3840	-34.29	12.78	-21.51	-13.00	-8.51			peak

*:Maximum data x:Over limit !:over margin

●Reference Only



File :FD400(CH661)

Data :#2

Date: 2008/10/14

Time: 下午 11:40:49

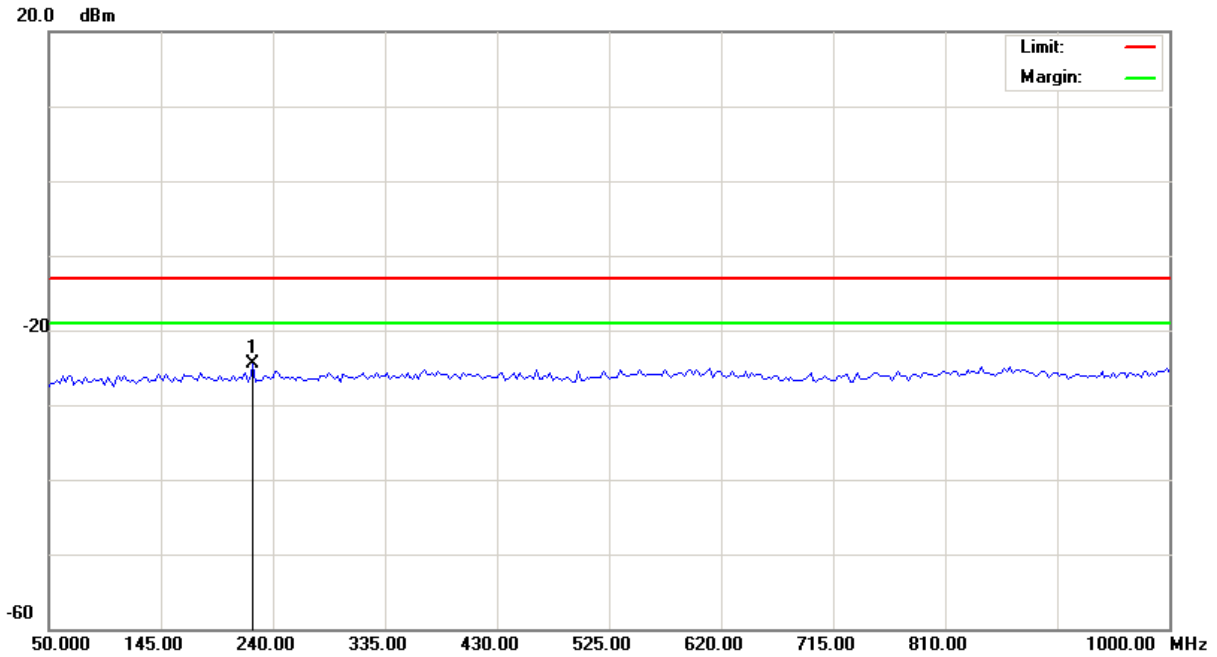

Site Polarization: **Conducted po** Temperature: 26 °C
 Limit: FCC Part 24 conducted(9k-12.75G) Power: AC 110V/60Hz Humidity: 55 %
 EUT: Distance:
 M/N: 08-0252-SEO
 Mode: PCS1900(GPRS)
 Note: CH661
 加10db衰减器

No.	Mk.	Freq.	Reading Level	Correct Factor	Measurement	Limit	Over	Antenna Height	Table Degree	
		MHz	dBm	dB	dBm	dBm	dB	cm	degree	Comment
1	*	223.3750	-37.79	13.25	-24.54	-13.00	-11.54	peak		

*:Maximum data x:Over limit !:over margin

●Reference Only



File :FD400(CH661)

Data :#3

Date: 2008/10/15

Time: 上午 12:57:36

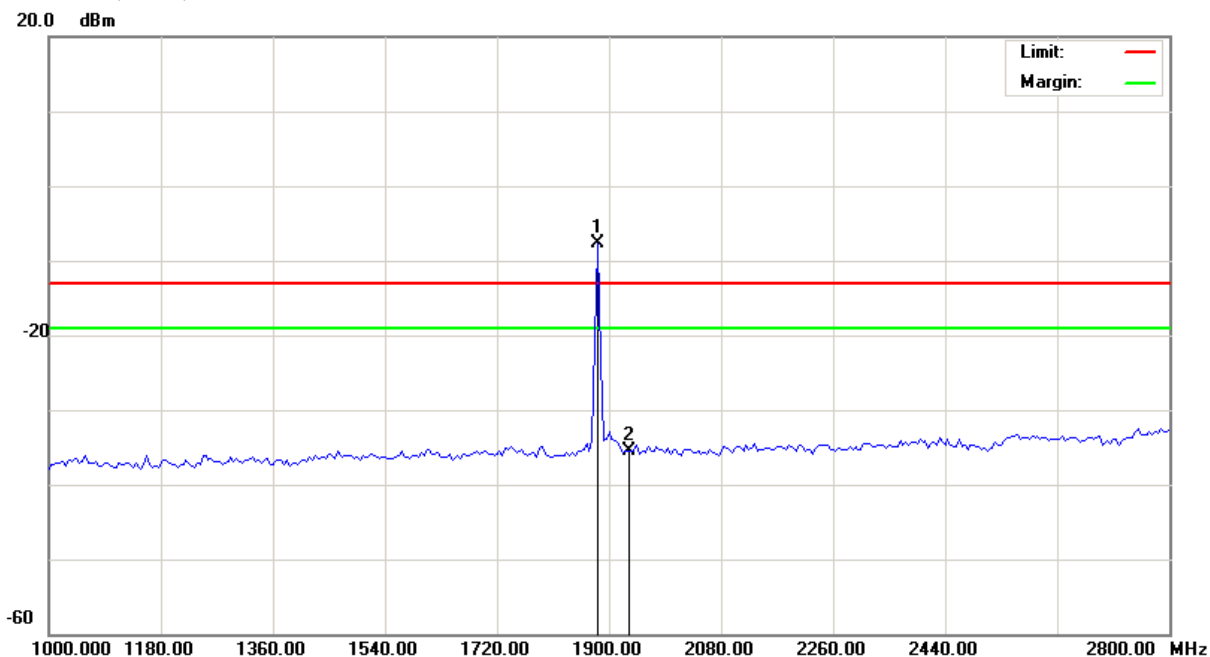

Site Polarization: **Conducted po** Temperature: 26 °C
 Limit: FCC Part 24 conducted(9k-12.75G) Power: AC 110V/60Hz Humidity: 55 %
 EUT: Distance:
 M/N: 08-0252-SEO
 Mode: PCS1900(GPRS)
 Note: CH661(1880MHz)
 加口Notch(5TNF-1700)

No.	Mk.	Freq.	Reading Level	Correct Factor	Measurement	Limit	Over	Antenna Height	Table Degree	Comment
		MHz	dBm	dB	dBm	dBm	dB	cm	degree	
1	*	1882.000	-12.59	4.83	-7.76	-13.00	5.24	peak		Main Frequency
2		1931.500	-40.17	4.68	-35.49	-13.00	-22.49	peak		

*:Maximum data x:Over limit !:over margin

●Reference Only



File :FD400(CH661)

Data :#4

Date: 2008/10/15

Time: 上午 01:32:08

20.0 dBm

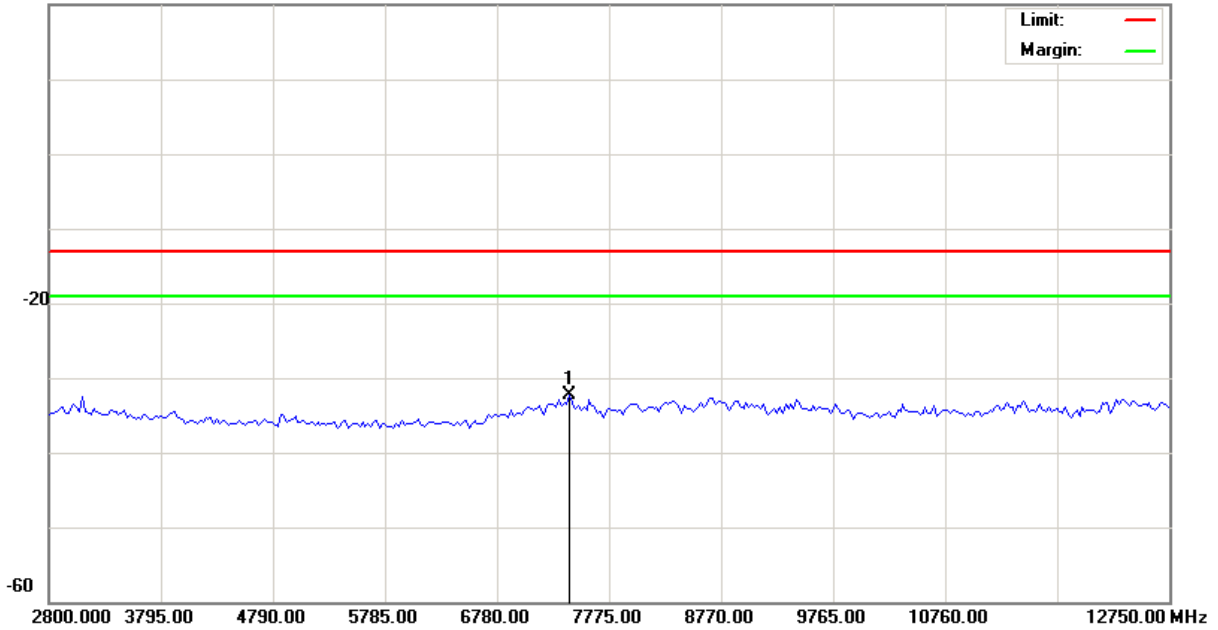

Site	Polarization: Conducted po	Temperature: 26 °C
Limit: FCC Part 24 conducted(9k-12.75G)	Power: AC 110V/60Hz	Humidity: 55 %
EUT:	Distance:	
M/N: 08-0252-SEO		
Mode: PCS1900(GPRS)		
Note: CH661		

No.	Mk.	Freq.	Reading Level	Correct Factor	Measurement	Limit	Over	Antenna Height	Table Degree	
		MHz	dBm	dB	dBm	dBm	dB	cm	degree	Comment
1	*	7426.750	-37.45	5.15	-32.30	-13.00	-19.30			peak

*:Maximum data x:Over limit !:over margin

●Reference Only



File :FD400(CH661)

Data :#5

Date: 2008/10/15

Time: 上午 01:32:30

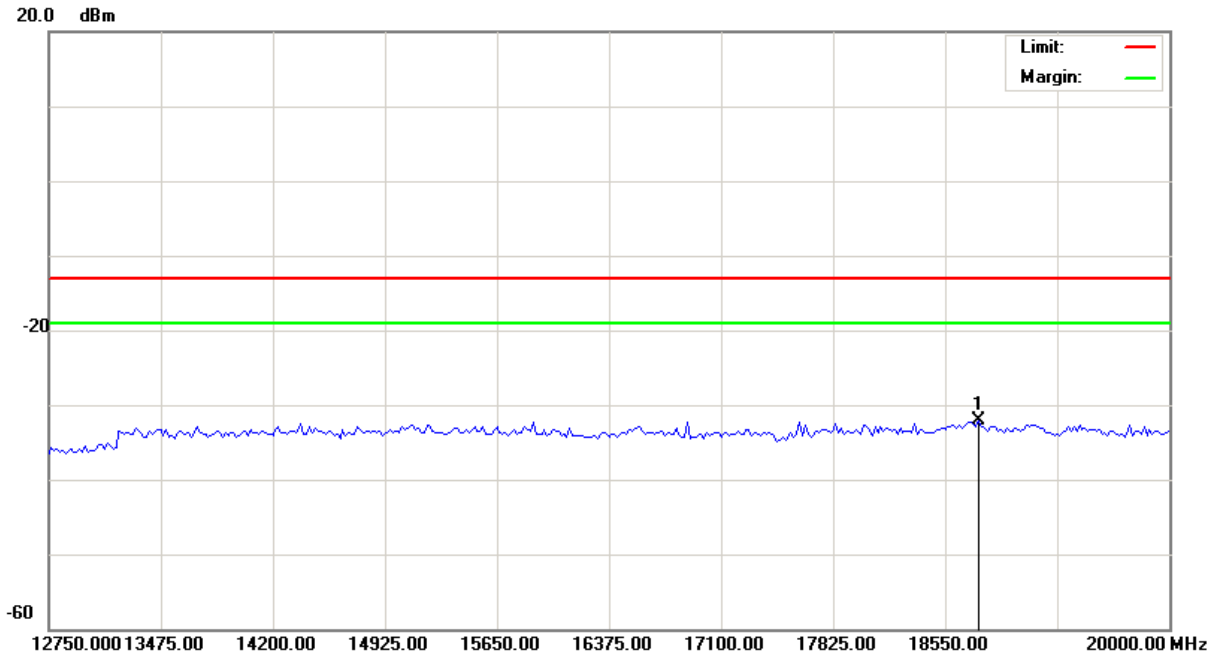

Site Polarization: **Conducted po** Temperature: 26 °C
 Limit: FCC Part 24 conducted(9k-12.75G) Power: AC 110V/60Hz Humidity: 55 %
 EUT: Distance:
 M/N: 08-0252-SEO
 Mode: PCS1900(GPRS)
 Note: CH661

No.	Mk.	Freq.	Reading Level	Correct Factor	Measurement	Limit	Over	Antenna Height	Table Degree	Comment
		MHz	dBm	dB	dBm	dBm	dB	cm	degree	
1	*	18767.50	-39.24	7.09	-32.15	-13.00	-19.15	peak		

*:Maximum data x:Over limit !:over margin

●Reference Only



File :FD400(CH810)

Data :#1

Date: 2008/10/14

Time: 下午 11:41:36

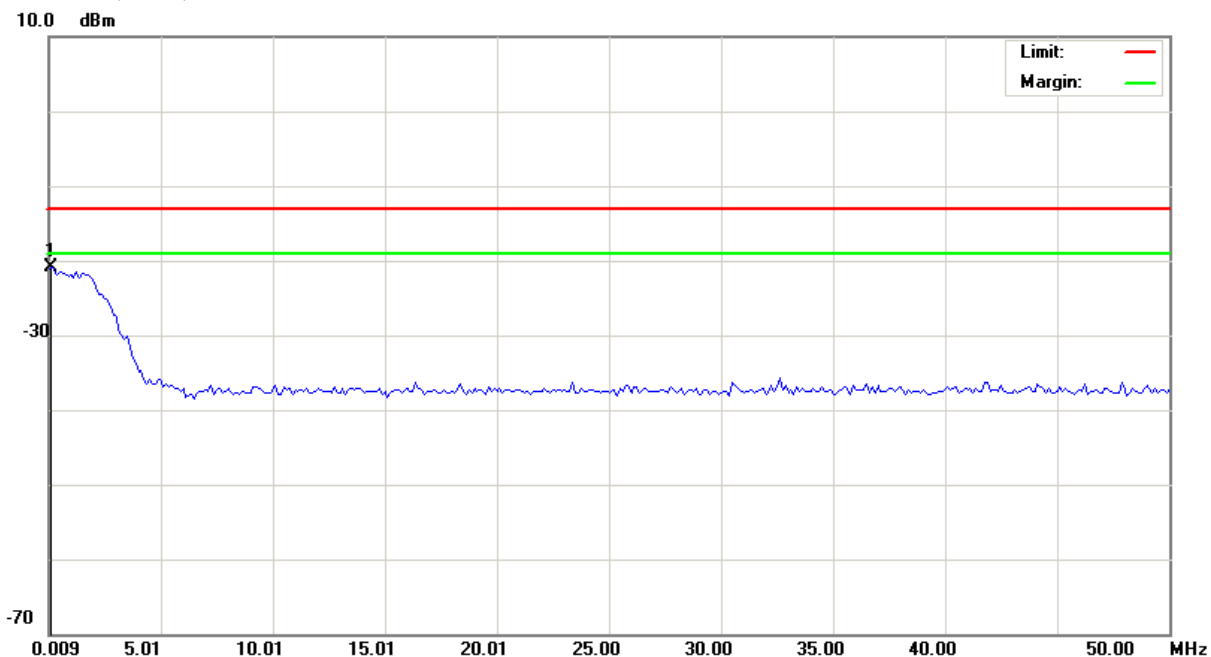

Site Polarization: **Conducted po** Temperature: 26 °C
 Limit: FCC Part 24 conducted(9k-12.75G) Power: AC 110V/60Hz Humidity: 55 %
 EUT: Distance:
 M/N: 08-0252-SEO
 Mode: PCS1900(GPRS)
 Note: CH810
 加10db衰减器

No.	Mk.	Freq.	Reading Level	Correct Factor	Measurement	Limit	Over	Antenna Height	Table Degree	
		MHz	dBm	dB	dBm	dBm	dB	cm	degree	Comment
1	*	0.1340	-33.30	12.48	-20.82	-13.00	-7.82			peak

*:Maximum data x:Over limit !:over margin

●Reference Only



File :FD400(CH810)

Data :#2

Date: 2008/10/14

Time: 下午 11:41:57

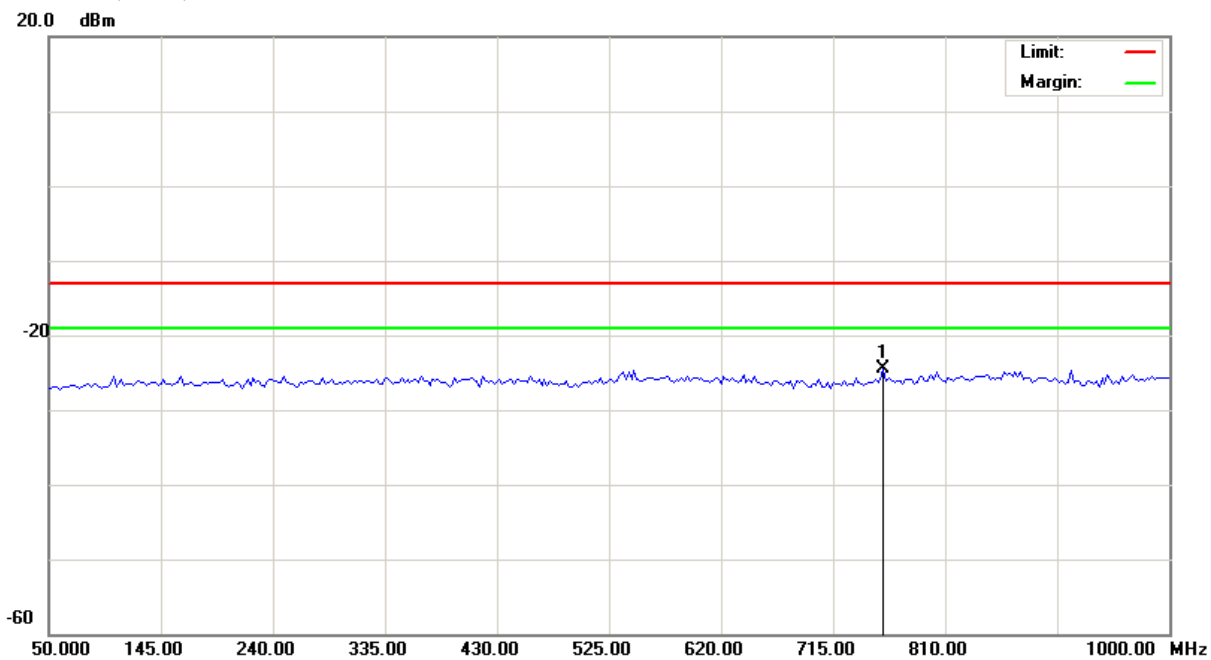

Site Polarization: **Conducted po** Temperature: 26 °C
 Limit: FCC Part 24 conducted(9k-12.75G) Power: AC 110V/60Hz Humidity: 55 %
 EUT: Distance:
 M/N: 08-0252-SEO
 Mode: PCS1900(GPRS)
 Note: CH810
 加10db衰减器

No.	Mk.	Freq.	Reading Level	Correct Factor	Measurement	Limit	Over	Antenna Height	Table Degree	
		MHz	dBm	dB	dBm	dBm	dB	cm	degree	Comment
1	*	757.7500	-37.68	13.16	-24.52	-13.00	-11.52	peak		

*:Maximum data x:Over limit !:over margin

●Reference Only



File :FD400(CH810)

Data :#3

Date: 2008/10/15

Time: 上午 01:01:15

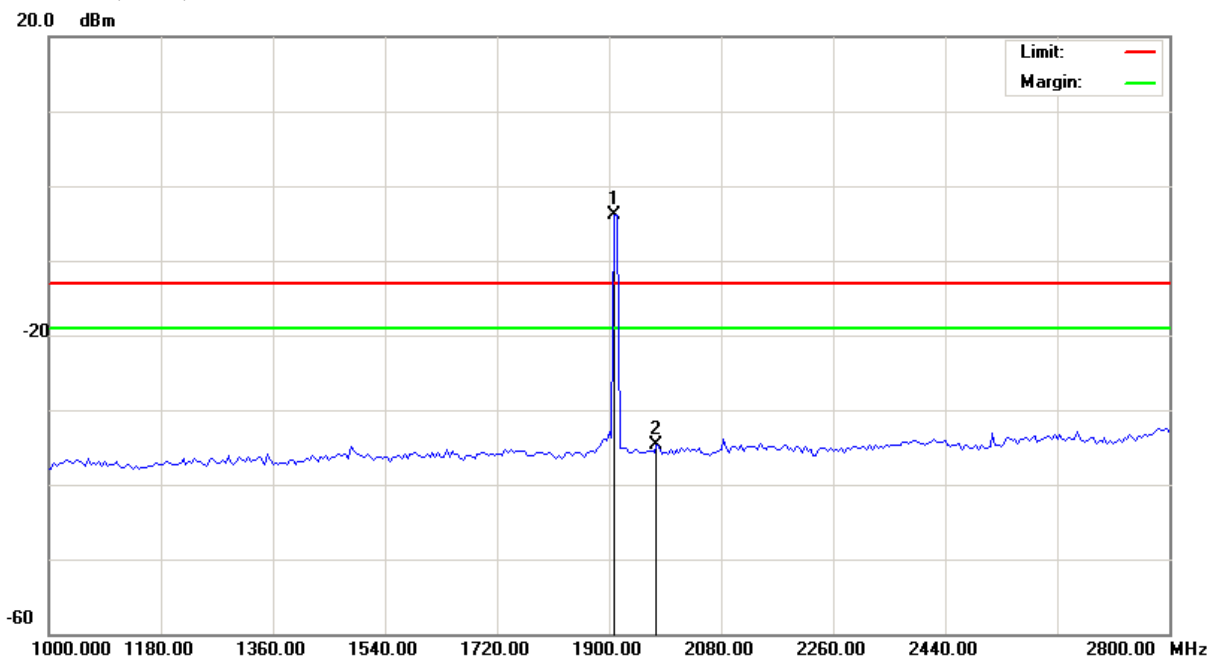

Site Polarization: **Conducted po** Temperature: 26 °C
 Limit: FCC Part 24 conducted(9k-12.75G) Power: AC 110V/60Hz Humidity: 55 %
 EUT: Distance:
 M/N: 08-0252-SEO
 Mode: PCS1900(GPRS)
 Note: CH810
 加Notch(5TNF-1700)

No.	Mk.	Freq.	Reading Level	Correct Factor	Measurement	Limit	Over	Antenna Height	Table Degree	Comment
		MHz	dBm	dB	dBm	dBm	dB	cm	degree	
1	*	1909.000	-9.70	5.80	-3.90	-13.00	9.10	peak		Main Frequency
2		1976.500	-39.41	4.78	-34.63	-13.00	-21.63	peak		

*:Maximum data x:Over limit !:over margin

●Reference Only



File :FD400(CH810)

Data :#4

Date: 2008/10/15

Time: 上午 01:33:11

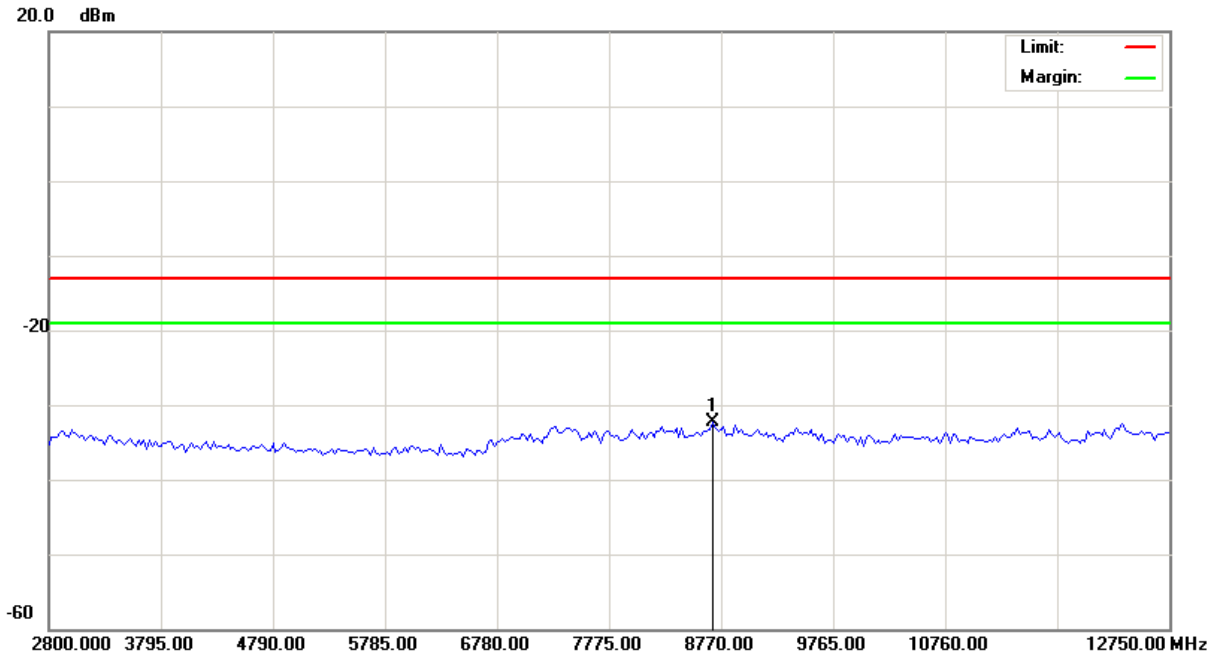

Site Polarization: **Conducted po** Temperature: 26 °C
 Limit: FCC Part 24 conducted(9k-12.75G) Power: AC 110V/60Hz Humidity: 55 %
 EUT: Distance:
 M/N: 08-0252-SEO
 Mode: PCS1900(GPRS)
 Note: CH810

No.	Mk.	Freq.	Reading Level	Correct Factor	Measurement	Limit	Over	Antenna Height	Table Degree	
		MHz	dBm	dB	dBm	dBm	dB	cm	degree	Comment
1	*	8695.375	-37.72	5.37	-32.35	-13.00	-19.35	peak		

*:Maximum data x:Over limit !:over margin

●Reference Only



File :FD400(CH810)

Data :#5

Date: 2008/10/15

Time: 上午 01:33:32

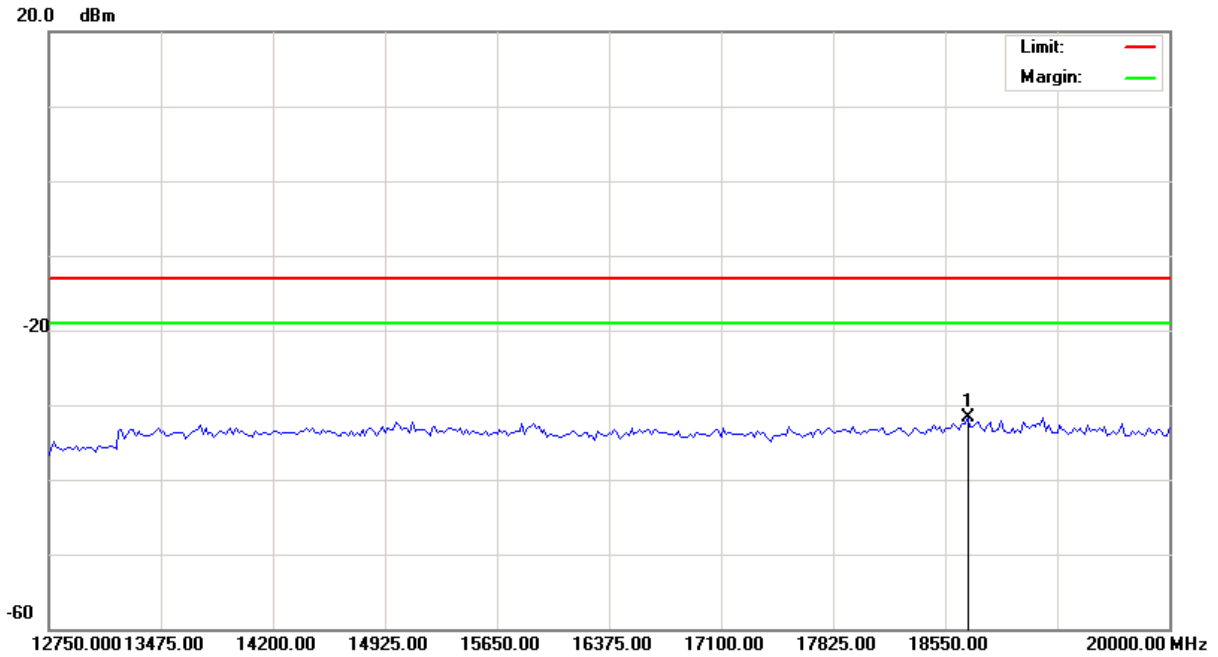

Site Polarization: **Conducted po** Temperature: 26 °C
 Limit: FCC Part 24 conducted(9k-12.75G) Power: AC 110V/60Hz Humidity: 55 %
 EUT: Distance:
 M/N: 08-0252-SEO
 Mode: PCS1900(GPRS)
 Note: CH810

No.	Mk.	Freq.	Reading Level	Correct Factor	Measurement	Limit	Over	Antenna Height	Table Degree	
		MHz	dBm	dB	dBm	dBm	dB	cm	degree	Comment
1	*	18695.00	-38.74	7.07	-31.67	-13.00	-18.67			peak

*:Maximum data x:Over limit !:over margin

●Reference Only



4.5.4.3 WCDMA Band V Test Result

Applicant : XAC Automation Corporation
Model No : FD-400
EUT : Portable Terminal
Test Mode : WCDMA Band V (Low CH4132 / Middle CH4182 / High CH 4233)
Test Date : 10/15/2008

Please refer to next pager of detail testing data.

Note: Amplitude= Reading Amplitude + Factor (Cable loss + Filter Amplitude= Insertion loss)
(Auto calculate in spectrum analyzer)



File :FD400(CH4132)

Data :#1

Date: 2008/10/15

Time: 上午 03:05:35

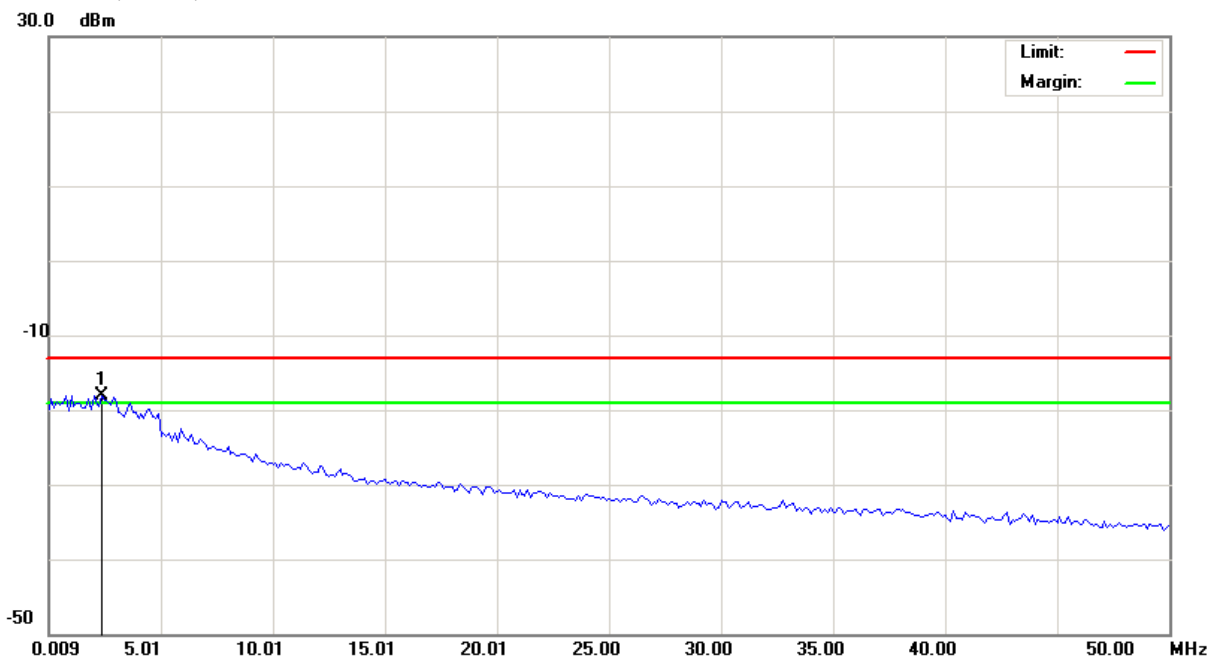

Site Polarization: **Conducted po** Temperature: 26 °C
 Limit: FCC Part 22 conducted(9k-12.75G) Power: AC 110V/60Hz Humidity: 55 %
 EUT: Distance:
 M/N: 08-0252-SEO
 Mode: WCDMA(BANDV)
 Note: CH4132
 加Notch(3TNF-800)

No.	Mk.	Freq.	Reading Level	Correct Factor	Measurement	Limit	Over	Antenna Height	Table Degree	Detector	Comment
		MHz	dBm	dB	dBm	dBm	dB	cm	degree		
1	*	2.3835	-48.89	30.88	-18.01	-13.00	-5.01			peak	

*:Maximum data x:Over limit !:over margin

●Reference Only



File :FD400(CH4132)

Data :#2

Date: 2008/10/15

Time: 上午 03:06:00

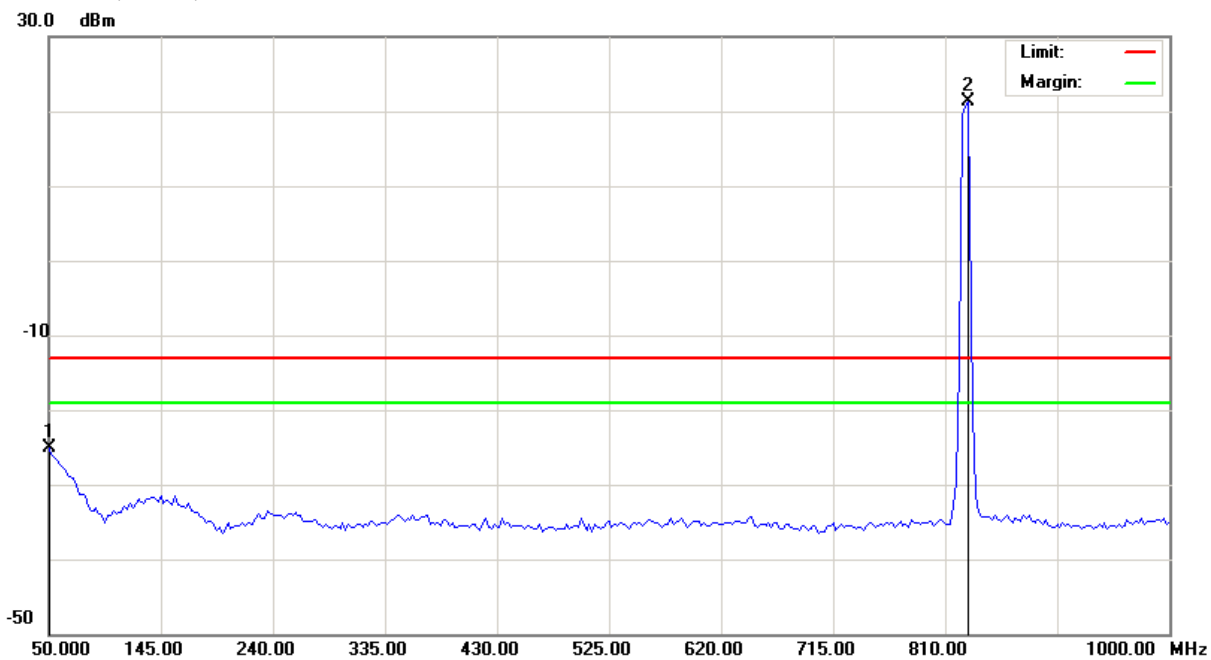

Site Polarization: **Conducted po** Temperature: 26 °C
 Limit: FCC Part 22 conducted(9k-12.75G) Power: AC 110V/60Hz Humidity: 55 %
 EUT: Distance:
 M/N: 08-0252-SEO
 Mode: WCDMA(BANDV)
 Note: CH4132
 加口Notch(3TNF-800)

No.	Mk.	Freq.	Reading Level	Correct Factor	Measurement	Limit	Over	Antenna Height	Table Degree	Comment
		MHz	dBm	dB	dBm	dBm	dB	cm	degree	
1		50.0000	-39.76	14.69	-25.07	-13.00	-12.07	peak		
2	*	829.0000	17.38	3.89	21.27	-13.00	34.27	peak		Main Frequency

*:Maximum data x:Over limit !:over margin

●Reference Only



File :FD400(CH4132)

Data :#3

Date: 2008/10/15

Time: 上午 01:54:29

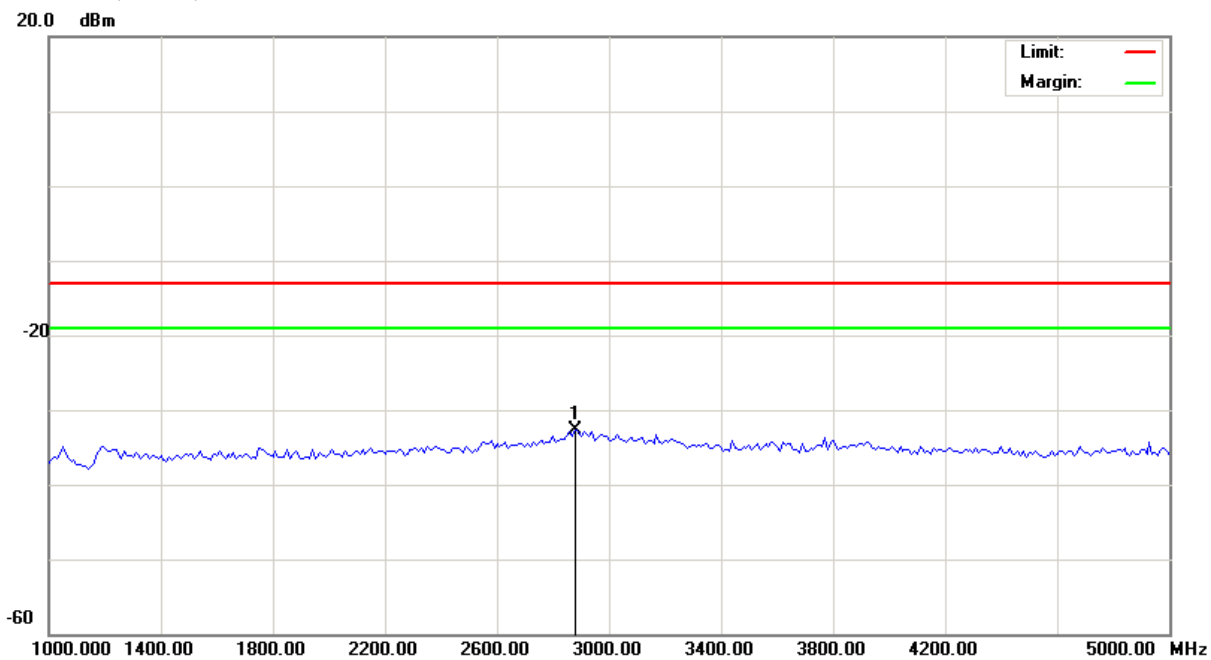

Site Polarization: **Conducted po** Temperature: 26 °C
 Limit: FCC Part 22 conducted(9k-12.75G) Power: AC 110V/60Hz Humidity: 55 %
 EUT: Distance:
 M/N: 08-0252-SEO
 Mode: WCDMA(BANDV)
 Note: CH4132

No.	Mk.	Freq.	Reading Level	Correct Factor	Measurement	Limit	Over	Antenna Height	Table Degree	Detector	Comment
		MHz	dBm	dB	dBm	dBm	dB	cm	degree		
1	*	2880.000	-37.37	4.66	-32.71	-13.00	-19.71			peak	

*:Maximum data x:Over limit !:over margin

●Reference Only



File :FD400(CH4132)

Data :#4

Date: 2008/10/15

Time: 上午 01:54:50

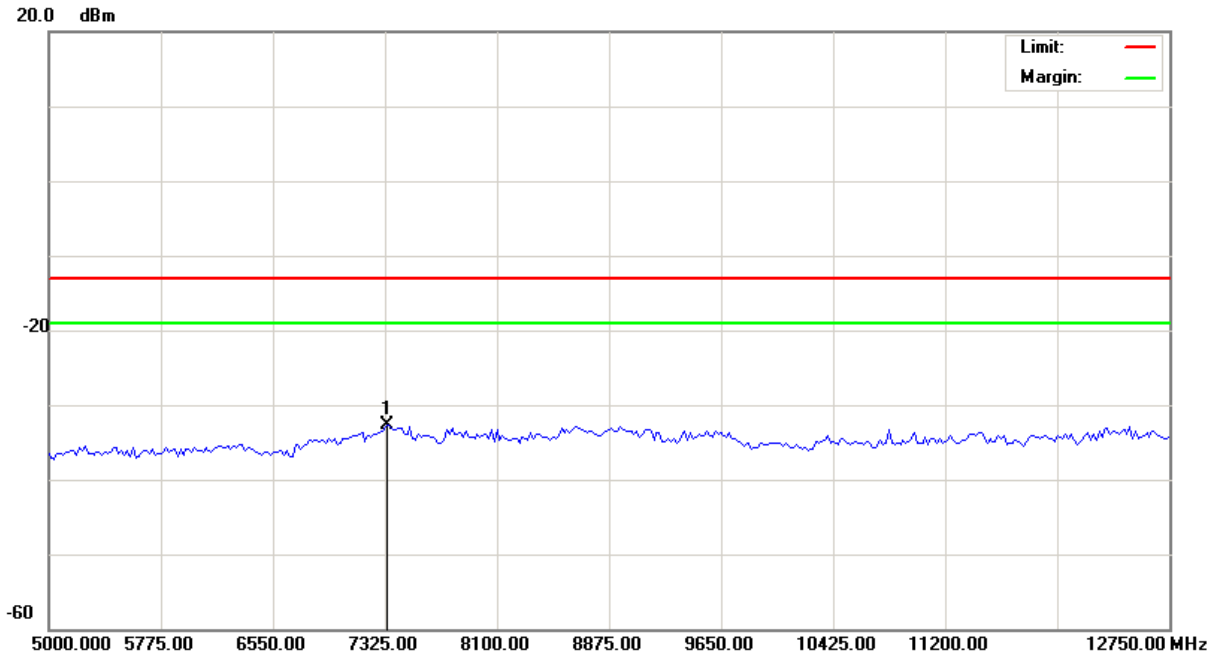

Site Polarization: **Conducted po** Temperature: 26 °C
 Limit: FCC Part 22 conducted(9k-12.75G) Power: AC 110V/60Hz Humidity: 55 %
 EUT: Distance:
 M/N: 08-0252-SEO
 Mode: WCDMA(BANDV)
 Note: CH4132

No.	Mk.	Freq.	Reading Level	Correct Factor	Measurement	Limit	Over	Antenna Height	Table Degree	Detector	Comment
		MHz	dBm	dB	dBm	dBm	dB	cm	degree		
1	*	7344.375	-37.71	5.04	-32.67	-13.00	-19.67			peak	

*:Maximum data x:Over limit !:over margin

●Reference Only



File :FD400(CH4180)

Data :#1

Date: 2008/10/15

Time: 上午 03:07:32

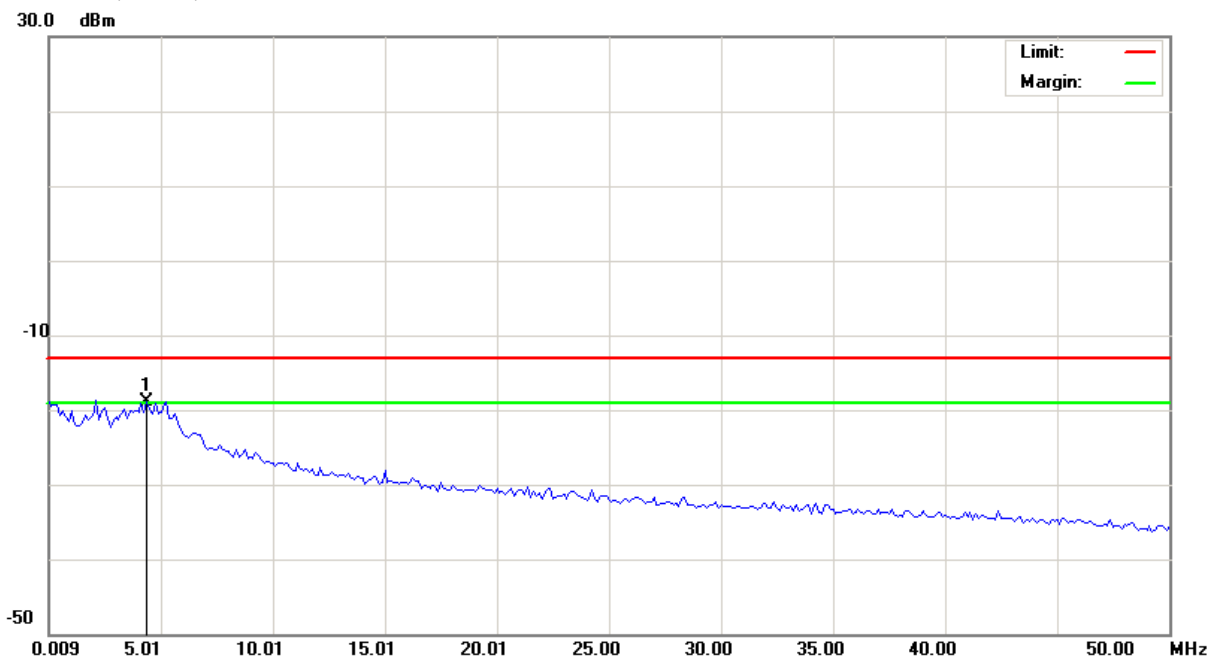

Site Polarization: **Conducted po** Temperature: 26 °C
 Limit: FCC Part 22 conducted(9k-12.75G) Power: AC 110V/60Hz Humidity: 55 %
 EUT: Distance:
 M/N: 08-0252-SEO
 Mode: WCDMA(BANDV)
 Note: CH4180
 加Notch(3TNF-800)

No.	Mk.	Freq.	Reading Level	Correct Factor	Measurement	Limit	Over	Antenna Height	Table Degree	
		MHz	dBm	dB	dBm	dBm	dB	cm	degree	Comment
1	*	4.3832	-47.98	29.11	-18.87	-13.00	-5.87			peak

*:Maximum data x:Over limit !:over margin

●Reference Only



File :FD400(CH4180)

Data :#2

Date: 2008/10/15

Time: 上午 03:07:53

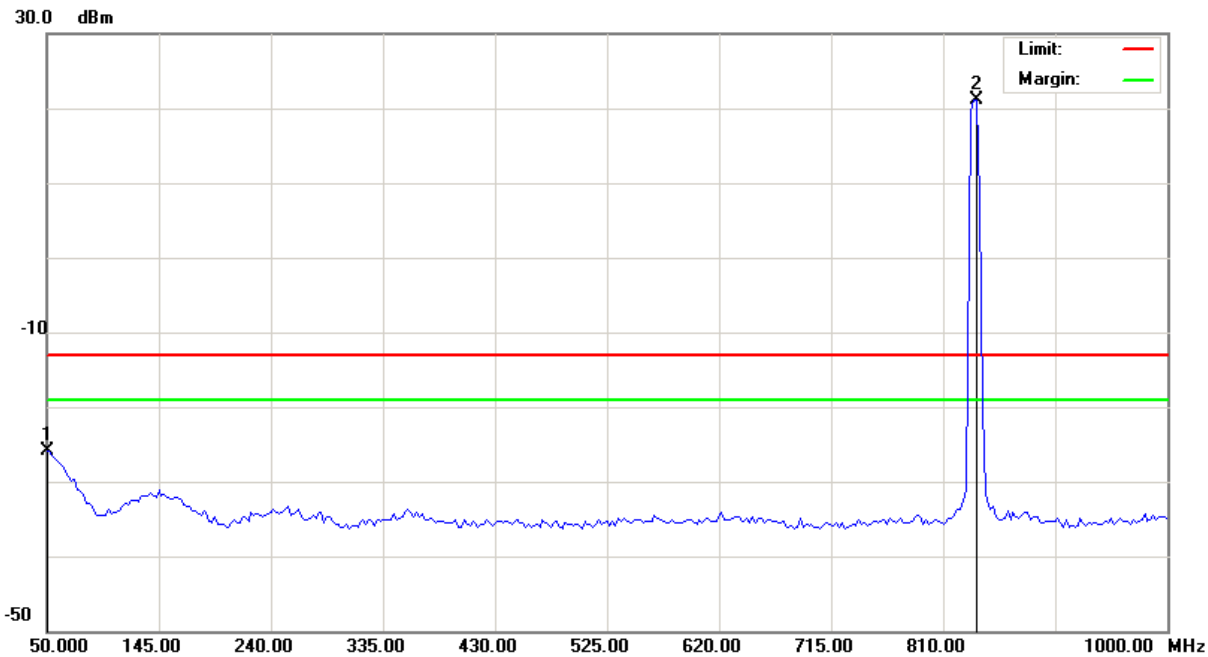

Site Polarization: **Conducted po** Temperature: 26 °C
 Limit: FCC Part 22 conducted(9k-12.75G) Power: AC 110V/60Hz Humidity: 55 %
 EUT: Distance:
 M/N: 08-0252-SEO
 Mode: WCDMA(BANDV)
 Note: CH4180
 加口Notch(3TNF-800)

No.	Mk.	Freq.	Reading Level	Correct Factor	Measurement	Limit	Over	Antenna Height	Table Degree	
		MHz	dBm	dB	dBm	dBm	dB	cm	degree	Comment
1		50.0000	-40.59	14.69	-25.90	-13.00	-12.90	peak		
2	*	838.5000	17.16	3.97	21.13	-13.00	34.13	peak		Main Frequency

*:Maximum data x:Over limit !:over margin

●Reference Only



File :FD400(CH4180)

Data :#3

Date: 2008/10/15

Time: 上午 01:56:21

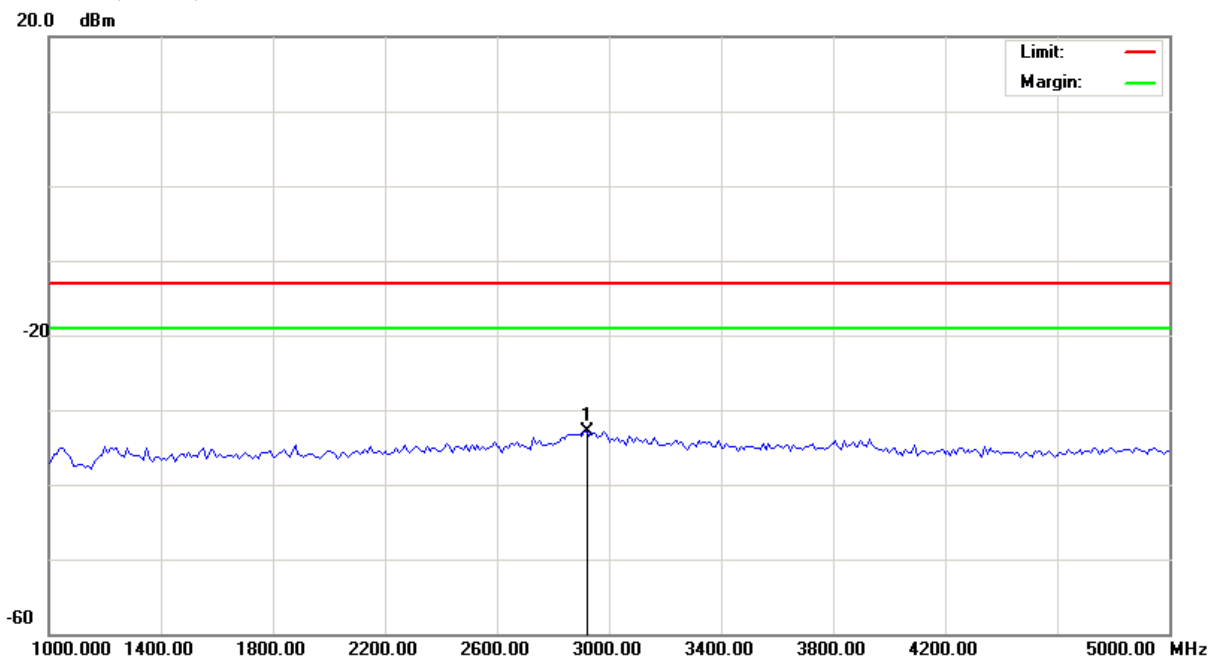

Site Polarization: **Conducted po** Temperature: 26 °C
 Limit: FCC Part 22 conducted(9k-12.75G) Power: AC 110V/60Hz Humidity: 55 %
 EUT: Distance:
 M/N: 08-0252-SEO
 Mode: WCDMA(BANDV)
 Note: CH4180

No.	Mk.	Freq.	Reading Level	Correct Factor	Measurement	Limit	Over	Antenna Height	Table Degree	Detector	Comment
		MHz	dBm	dB	dBm	dBm	dB	cm	degree		
1	*	2920.000	-37.62	4.69	-32.93	-13.00	-19.93			peak	

*:Maximum data x:Over limit !:over margin

●Reference Only



File :FD400(CH4180)

Data :#4

Date: 2008/10/15

Time: 上午 01:56:42

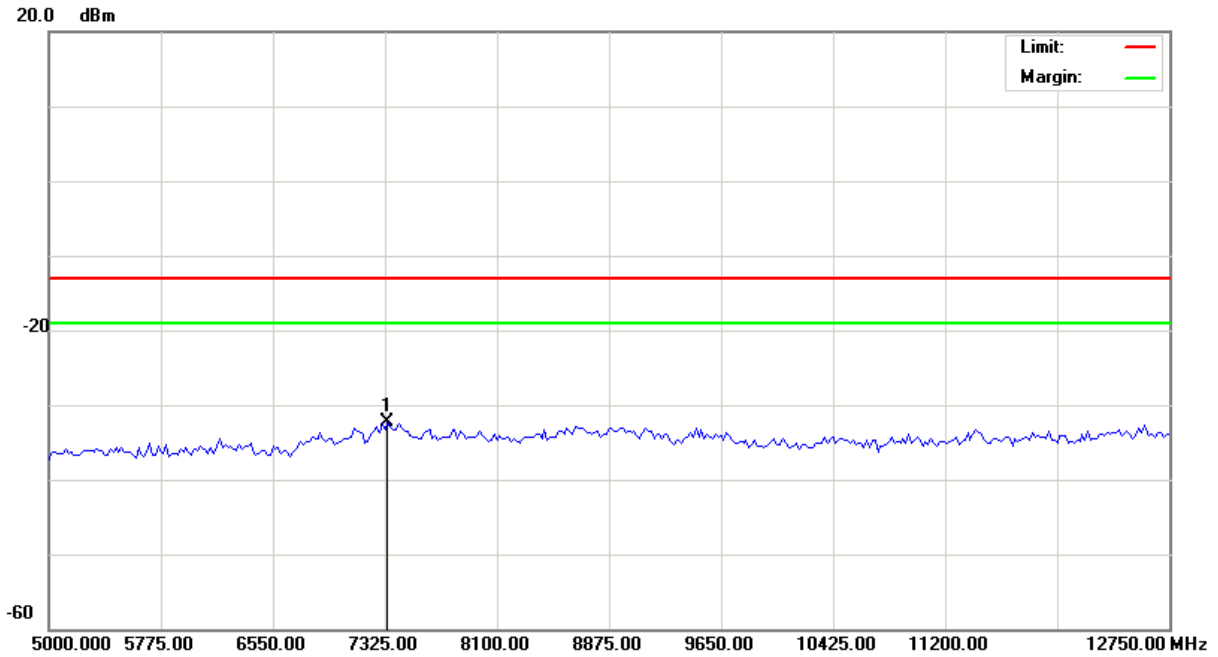

Site Polarization: **Conducted po** Temperature: 26 °C
 Limit: FCC Part 22 conducted(9k-12.75G) Power: AC 110V/60Hz Humidity: 55 %
 EUT: Distance:
 M/N: 08-0252-SEO
 Mode: WCDMA(BANDV)
 Note: CH4180

No.	Mk.	Freq.	Reading Level	Correct Factor	Measurement	Limit	Over	Antenna Height	Table Degree	Comment
		MHz	dBm	dB	dBm	dBm	dB	cm	degree	
1	*	7344.375	-37.40	5.04	-32.36	-13.00	-19.36	peak		

*:Maximum data x:Over limit !:over margin

●Reference Only



File :FD400(CH4233)

Data :#1

Date: 2008/10/15

Time: 上午 03:09:30

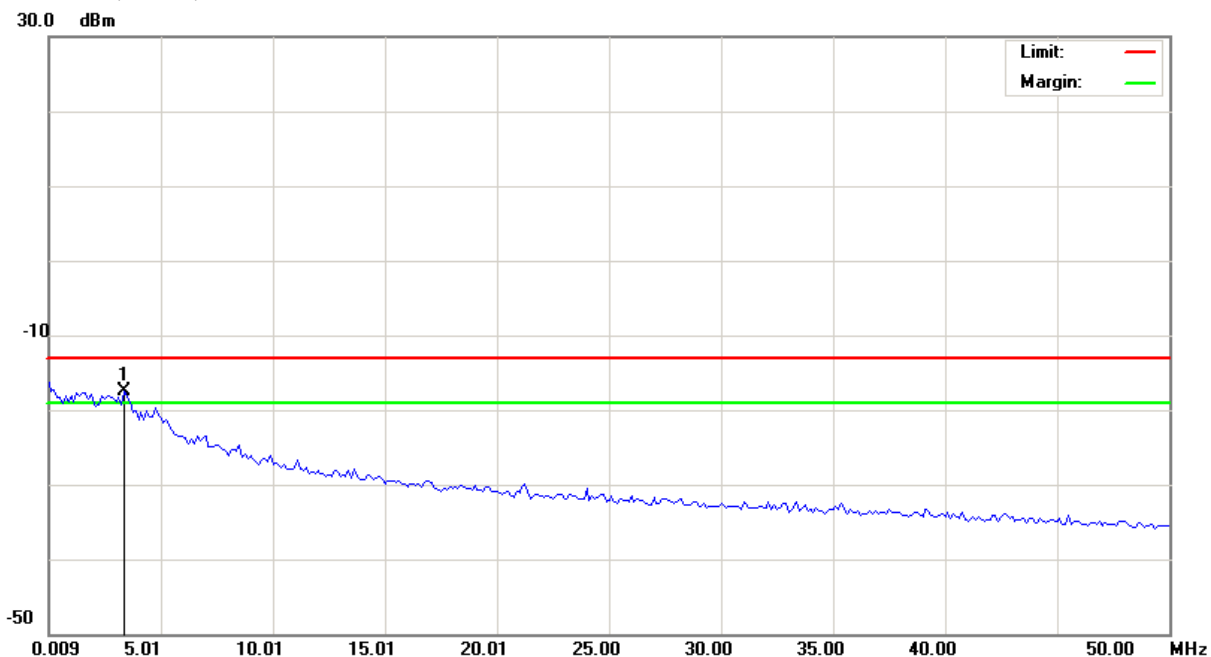

Site Polarization: **Conducted po** Temperature: 26 °C
 Limit: FCC Part 22 conducted(9k-12.75G) Power: AC 110V/60Hz Humidity: 55 %
 EUT: Distance:
 M/N: 08-0252-SEO
 Mode: WCDMA(BANDV)
 Note: CH4233
 加Notch(3TNF-800)

No.	Mk.	Freq.	Reading Level	Correct Factor	Measurement	Limit	Over	Antenna Height	Table Degree	
		MHz	dBm	dB	dBm	dBm	dB	cm	degree	Comment
1	*	3.3833	-47.57	30.02	-17.55	-13.00	-4.55			peak

*:Maximum data x:Over limit !:over margin

●Reference Only



File :FD400(CH4233) Data :#2 Date: 2008/10/15 Time: 上午 03:09:51

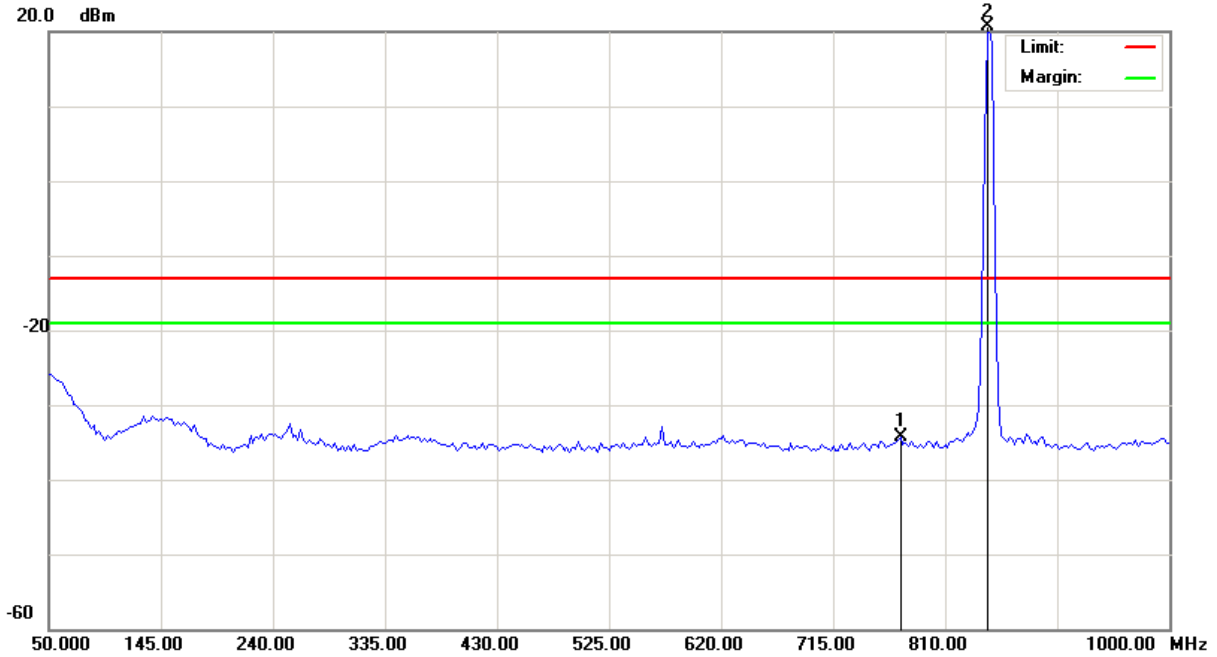

Site Polarization: **Conducted po** Temperature: 26 °C
 Limit: FCC Part 22 conducted(9k-12.75G) Power: AC 110V/60Hz Humidity: 55 %
 EUT: Distance:
 M/N: 08-0252-SEO
 Mode: WCDMA(BANDV)
 Note: CH4233
 加口Notch(3TNF-800)

No.	Mk.	Freq.	Reading Level	Correct Factor	Measurement	Limit	Over	Antenna Height	Table Degree		
		MHz	dBm	dB	dBm	dBm	dB	Detector	cm	degree	Comment
1		772.0000	-38.04	3.73	-34.31	-13.00	-21.31	peak			
2	*	845.6250	16.79	3.99	20.78	-13.00	33.78	peak			Main Frequency

*:Maximum data x:Over limit !:over margin

●Reference Only



File :FD400(CH4233)

Data :#3

Date: 2008/10/15

Time: 上午 01:57:29

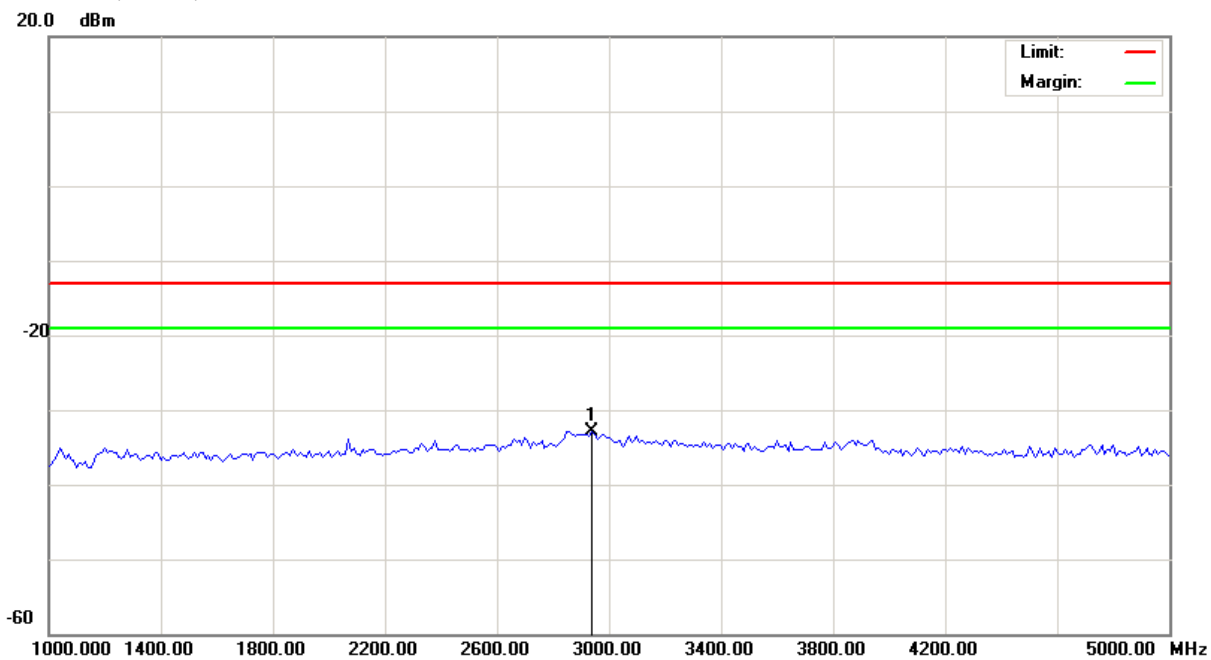

Site: Polarization: **Conducted po** Temperature: 26 °C
 Limit: FCC Part 22 conducted(9k-12.75G) Power: AC 110V/60Hz Humidity: 55 %
 EUT: Distance:
 M/N: 08-0252-SEO
 Mode: WCDMA(BANDV)
 Note: CH4233

No.	Mk.	Freq.	Reading Level	Correct Factor	Measurement	Limit	Over	Antenna Height	Table Degree	
		MHz	dBm	dB	dBm	dBm	dB	cm	degree	Comment
1	*	2940.000	-37.45	4.62	-32.83	-13.00	-19.83			peak

*:Maximum data x:Over limit !:over margin

●Reference Only



File :FD400(CH4233)

Data :#4

Date: 2008/10/15

Time: 上午 01:57:50

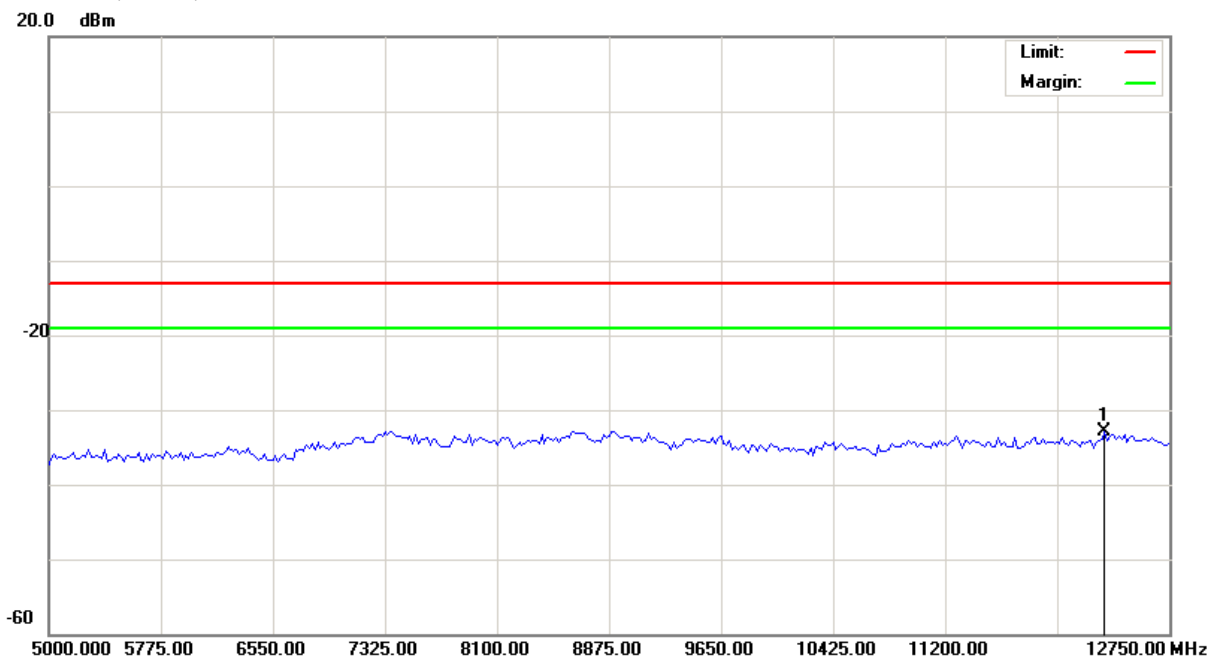

Site Polarization: **Conducted po** Temperature: 26 °C
 Limit: FCC Part 22 conducted(9k-12.75G) Power: AC 110V/60Hz Humidity: 55 %
 EUT: Distance:
 M/N: 08-0252-SEO
 Mode: WCDMA(BANDV)
 Note: CH4233

No.	Mk.	Freq.	Reading Level	Correct Factor	Measurement	Limit	Over	Antenna Height	Table Degree	
		MHz	dBm	dB	dBm	dBm	dB	cm	degree	Comment
1	*	12304.37	-37.36	4.52	-32.84	-13.00	-19.84	peak		

*:Maximum data x:Over limit !:over margin

●Reference Only



4.5.4.4 WCDMA Band II Test Result

Applicant : XAC Automation Corporation
Model No : FD-400
EUT : Portable Terminal
Test Mode : WCDMA Band II (Low CH9262 / Middle CH9400 / High CH 9536)
Test Date : 10/15/2008

Please refer to next pager of detail testing data.

Note: Amplitude= Reading Amplitude + Factor (Cable loss + Filter Amplitude= Insertion loss)
(Auto calculate in spectrum analyzer)



File :FD400(CH9262)

Data :#1

Date: 2008/10/15

Time: 上午 02:36:13

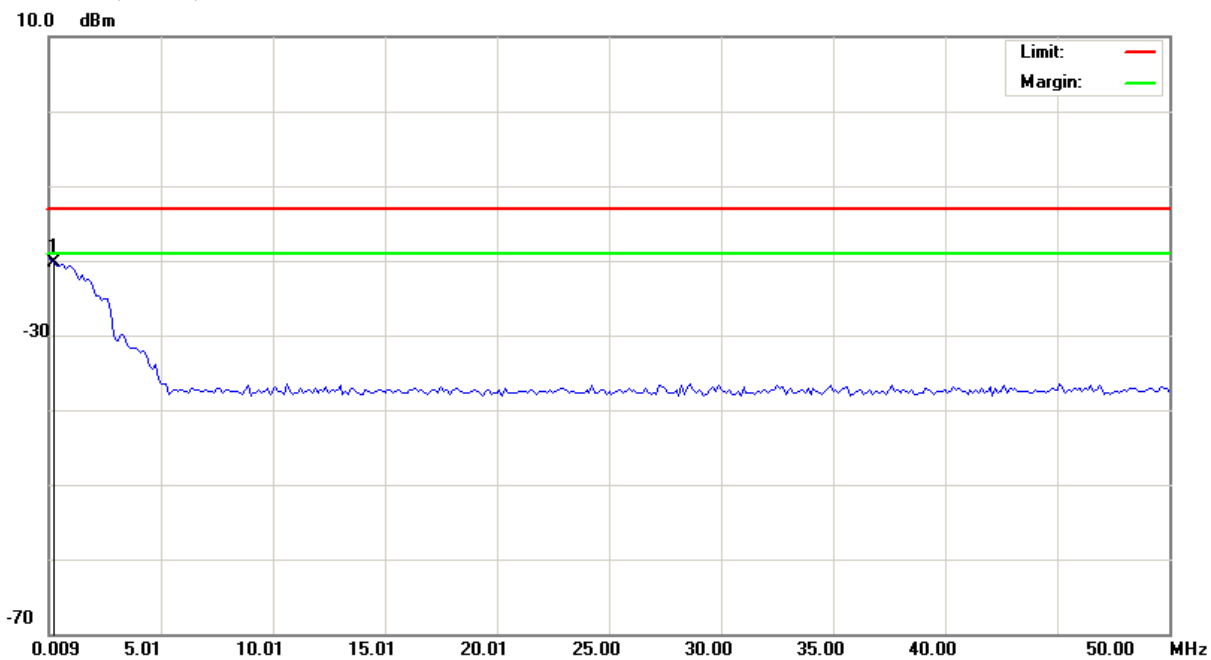

Site Polarization: **Conducted po** Temperature: 26 °C
 Limit: FCC Part 24 conducted(9k-12.75G) Power: AC 110V/60Hz Humidity: 55 %
 EUT: Distance:
 M/N: 08-0252-SEO
 Mode: WCDMA(BANDII)
 Note: CH9262
 加10db衰减器

No.	Mk.	Freq.	Reading Level	Correct Factor	Measurement	Limit	Over	Antenna Height	Table Degree	Detector	Comment
		MHz	dBm	dB	dBm	dBm	dB	cm	degree		
1	*	0.2590	-32.81	12.54	-20.27	-13.00	-7.27			peak	

*:Maximum data x:Over limit !:over margin

●Reference Only



File :FD400(CH9262)

Data :#2

Date: 2008/10/15

Time: 上午 02:36:34

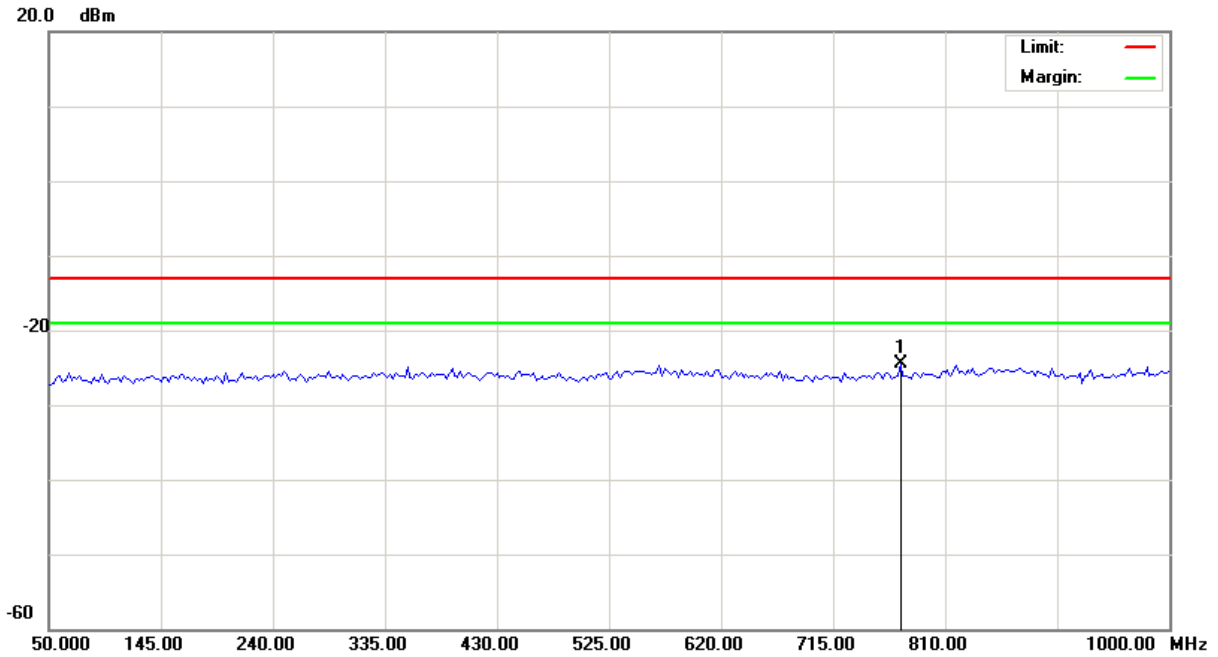

Site Polarization: **Conducted po** Temperature: 26 °C
 Limit: FCC Part 24 conducted(9k-12.75G) Power: AC 110V/60Hz Humidity: 55 %
 EUT: Distance:
 M/N: 08-0252-SEO
 Mode: WCDMA(BANDII)
 Note: CH9262
 加10db衰减器

No.	Mk.	Freq.	Reading Level	Correct Factor	Measurement	Limit	Over	Antenna Height	Table Degree	Comment
		MHz	dBm	dB	dBm	dBm	dB	cm	degree	
1	*	772.0000	-37.71	13.15	-24.56	-13.00	-11.56	peak		

*:Maximum data x:Over limit !:over margin

●Reference Only



File :FD400(CH9262)

Data :#3

Date: 2008/10/15

Time: 上午 02:54:24

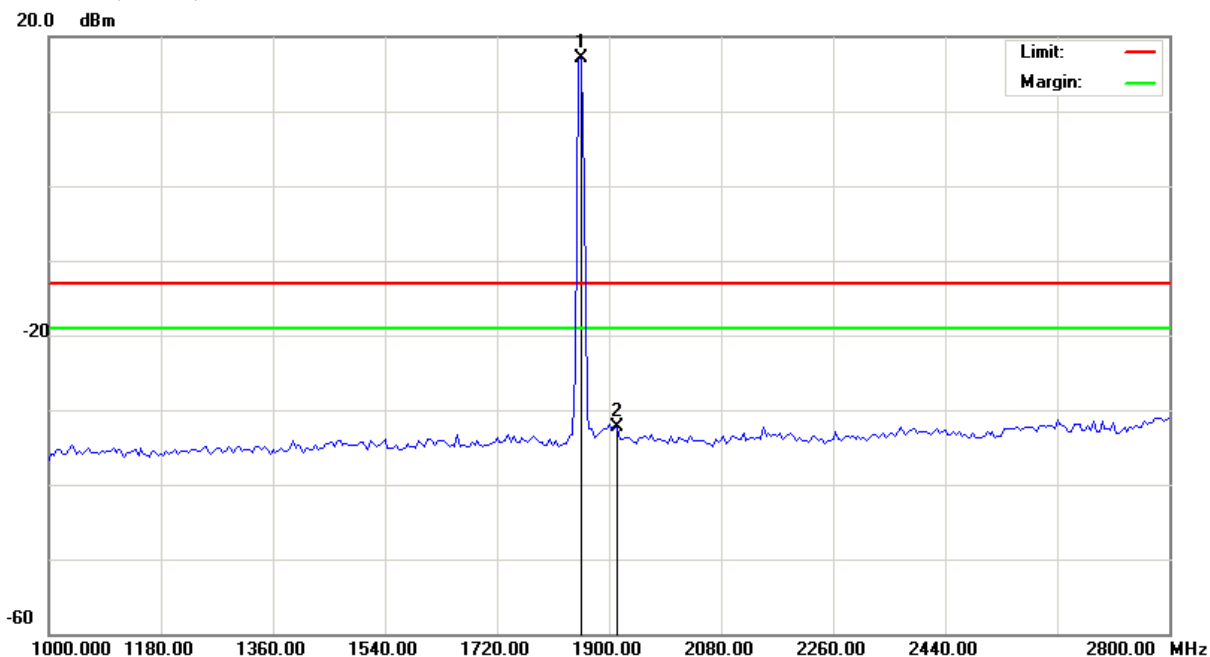

Site Polarization: **Conducted po** Temperature: 26 °C
 Limit: FCC Part 24 conducted(9k-12.75G) Power: AC 110V/60Hz Humidity: 55 %
 EUT: Distance:
 M/N: 08-0252-SEO
 Mode: WCDMA(BANDII)
 Note: CH9262
 加口Notch(5TNF-1700)

No.	Mk.	Freq.	Reading Level	Correct Factor	Measurement	Limit	Over	Antenna Height	Table Degree	Comment
		MHz	dBm	dB	dBm	dBm	dB	Detector	cm	degree
1	*	1855.000	12.90	4.29	17.19	-13.00	30.19	peak		Main Frequency
2		1913.500	-37.77	5.38	-32.39	-13.00	-19.39	peak		

*:Maximum data x:Over limit !:over margin

●Reference Only



File :FD400(CH9262)

Data :#4

Date: 2008/10/15

Time: 上午 02:00:09

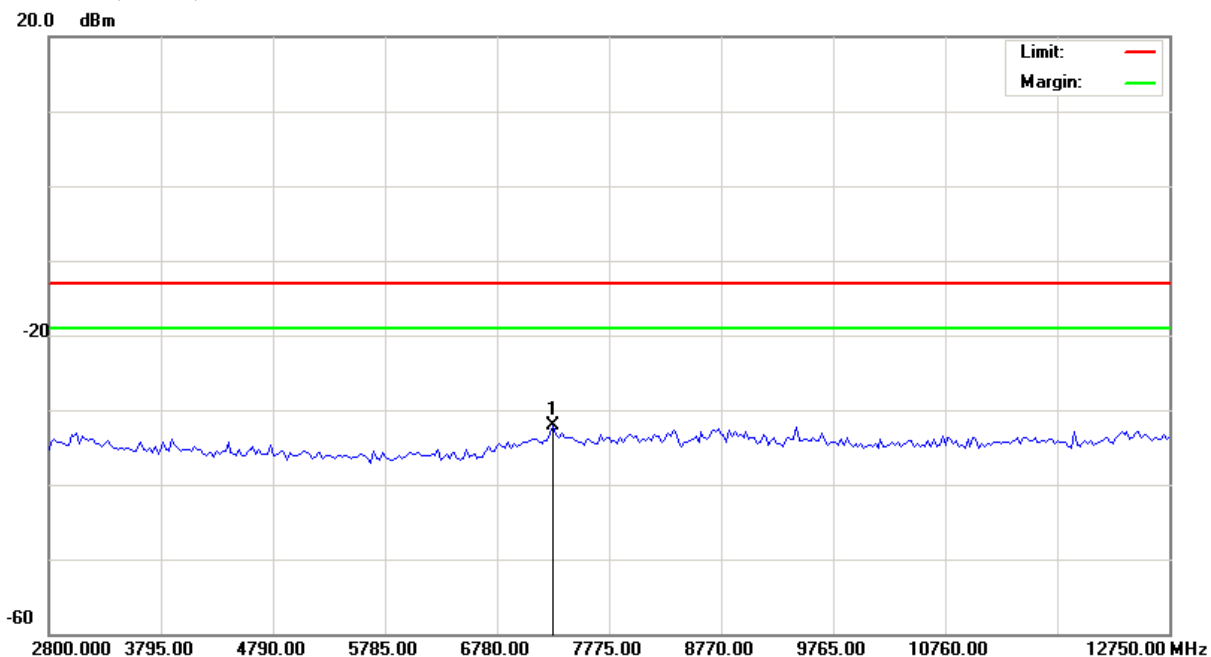

Site

Polarization: **Conducted po**

Temperature: 26 °C

Limit: FCC Part 24 conducted(9k-12.75G)

Power: AC 110V/60Hz

Humidity: 55 %

EUT:

Distance:

M/N: 08-0252-SEO

Mode: WCDMA(BANDII)

Note: CH9262

No.	Mk.	Freq.	Reading Level	Correct Factor	Measurement	Limit	Over	Antenna Height	Table Degree	
		MHz	dBm	dB	dBm	dBm	dB	cm	degree	Comment
1	*	7277.500	-37.16	5.16	-32.00	-13.00	-19.00	peak		

*:Maximum data x:Over limit !:over margin

●Reference Only



File :FD400(CH9262)

Data :#5

Date: 2008/10/15

Time: 上午 02:00:30

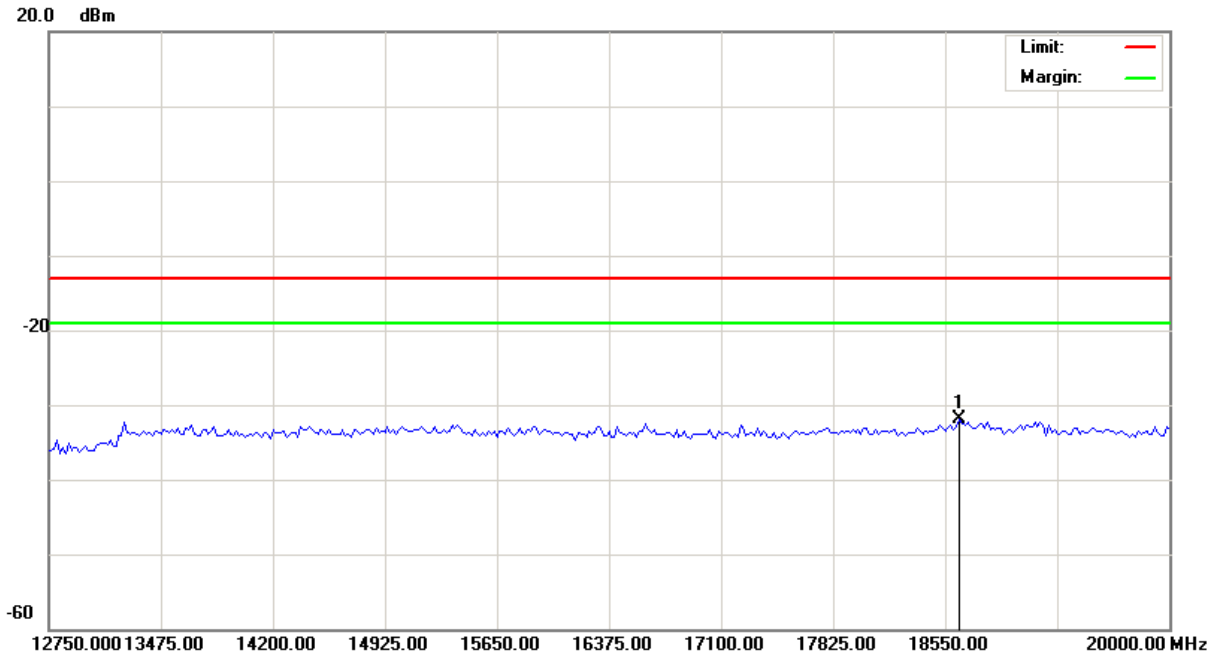

Site Polarization: **Conducted po** Temperature: 26 °C
 Limit: FCC Part 24 conducted(9k-12.75G) Power: AC 110V/60Hz Humidity: 55 %
 EUT: Distance:
 M/N: 08-0252-SEO
 Mode: WCDMA(BANDII)
 Note: CH9262

No.	Mk.	Freq.	Reading Level	Correct Factor	Measurement	Limit	Over	Antenna Height	Table Degree	Comment
		MHz	dBm	dB	dBm	dBm	dB	cm	degree	
1	*	18640.62	-38.92	7.05	-31.87	-13.00	-18.87	peak		

*:Maximum data x:Over limit !:over margin

●Reference Only



File :FD400(CH9400)

Data :#1

Date: 2008/10/15

Time: 上午 02:37:39

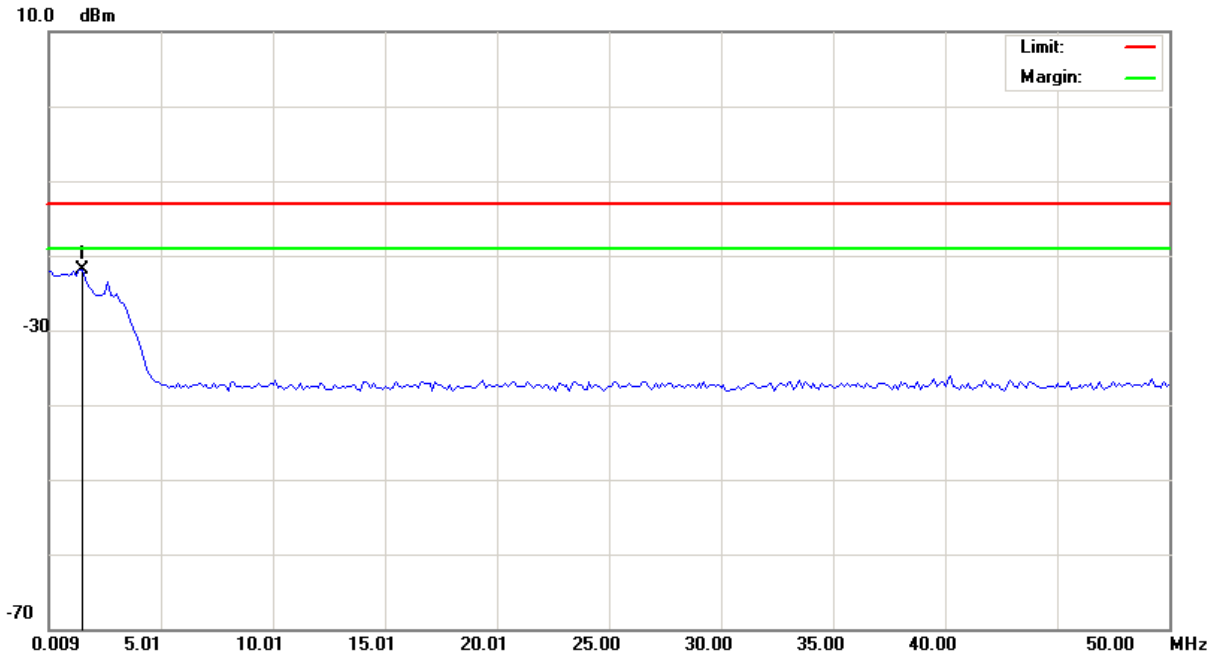

Site Polarization: **Conducted po** Temperature: 26 °C
 Limit: FCC Part 24 conducted(9k-12.75G) Power: AC 110V/60Hz Humidity: 55 %
 EUT: Distance:
 M/N: 08-0252-SEO
 Mode: WCDMA(BANDII)
 Note: CH9400
 加10db衰减器

No.	Mk.	Freq.	Reading Level	Correct Factor	Measurement	Limit	Over	Antenna Height	Table Degree	
		MHz	dBm	dB	dBm	dBm	dB	cm	degree	Comment
1	*	1.5085	-34.41	12.55	-21.86	-13.00	-8.86			peak

*:Maximum data x:Over limit !:over margin

●Reference Only



File :FD400(CH9400)

Data :#2

Date: 2008/10/15

Time: 上午 02:38:00

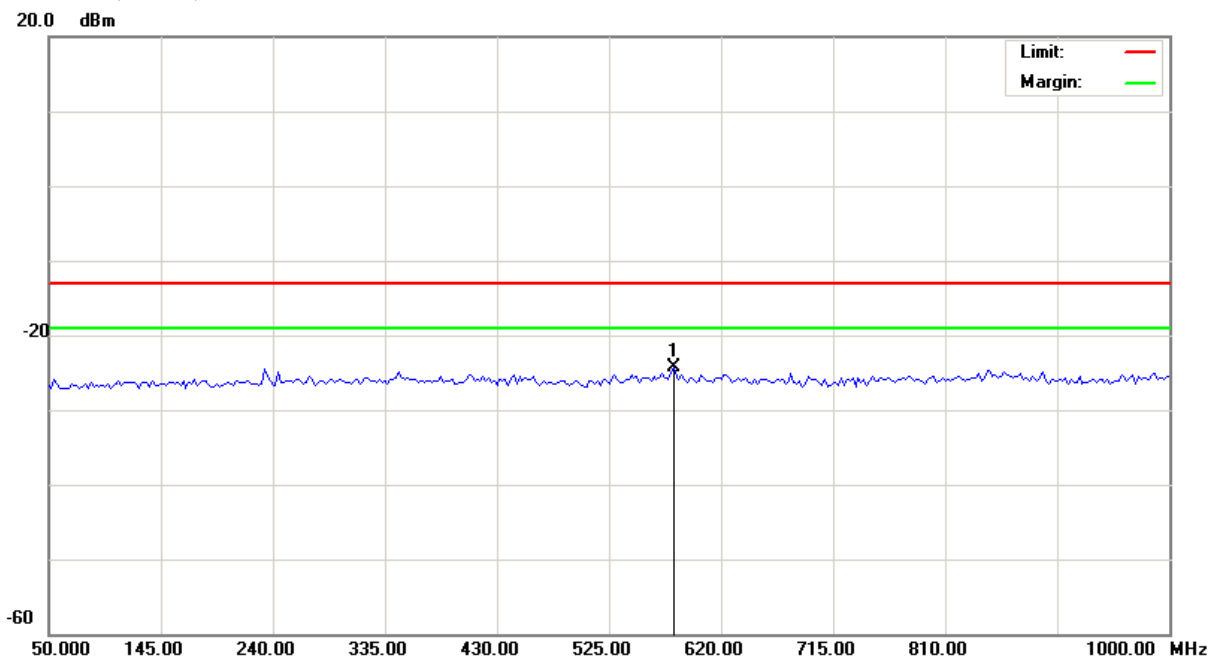

Site Polarization: **Conducted po** Temperature: 26 °C
 Limit: FCC Part 24 conducted(9k-12.75G) Power: AC 110V/60Hz Humidity: 55 %
 EUT: Distance:
 M/N: 08-0252-SEO
 Mode: WCDMA(BANDII)
 Note: CH9400
 加10db衰减器

No.	Mk.	Freq.	Reading Level	Correct Factor	Measurement	Limit	Over	Antenna Height	Table Degree	Detector	Comment
		MHz	dBm	dB	dBm	dBm	dB	cm	degree		
1	*	579.6250	-37.51	13.16	-24.35	-13.00	-11.35			peak	

*:Maximum data x:Over limit !:over margin

●Reference Only



File :FD400(CH9400)

Data :#3

Date: 2008/10/15

Time: 上午 02:56:13

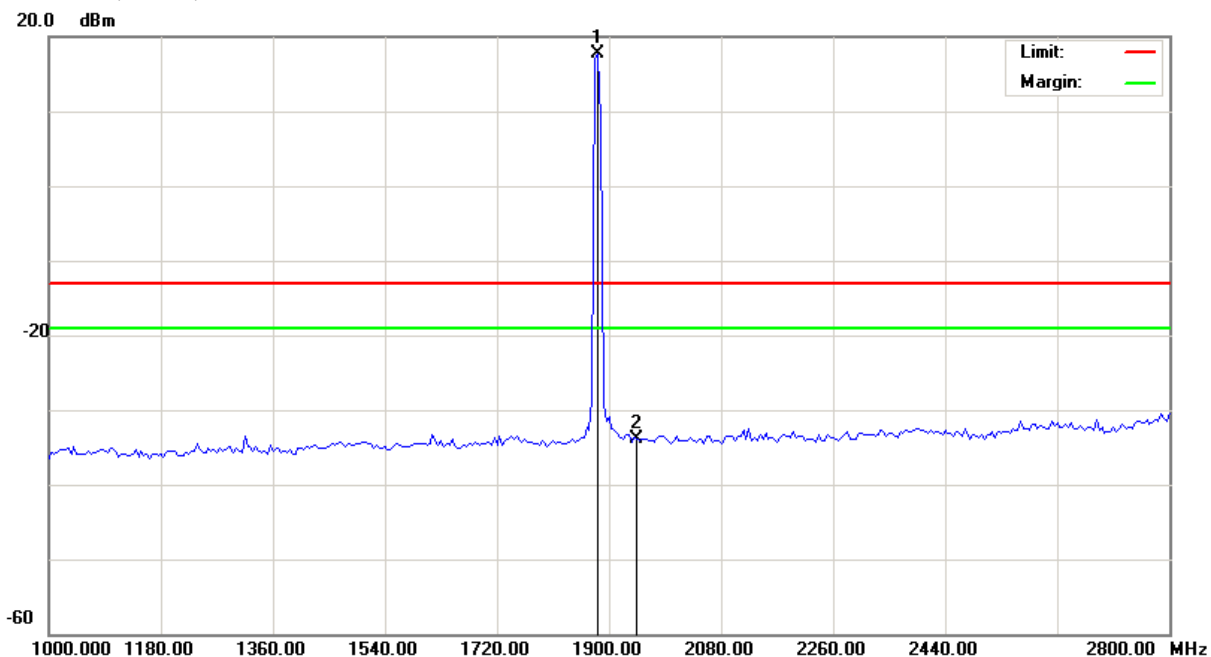

Site Polarization: **Conducted po** Temperature: 26 °C
 Limit: FCC Part 24 conducted(9k-12.75G) Power: AC 110V/60Hz Humidity: 55 %
 EUT: Distance:
 M/N: 08-0252-SEO
 Mode: WCDMA(BANDII)
 Note: CH9400
 加口Notch(5TNF-1700)

No.	Mk.	Freq.	Reading Level	Correct Factor	Measurement	Limit	Over	Antenna Height	Table Degree	Comment
		MHz	dBm	dB	dBm	dBm	dB	cm	degree	
1	*	1882.000	12.87	4.83	17.70	-13.00	30.70	peak		Main Frequency
2		1945.000	-38.53	4.63	-33.90	-13.00	-20.90	peak		

*:Maximum data x:Over limit !:over margin

●Reference Only



File :FD400(CH9400)

Data :#4

Date: 2008/10/15

Time: 上午 02:01:27

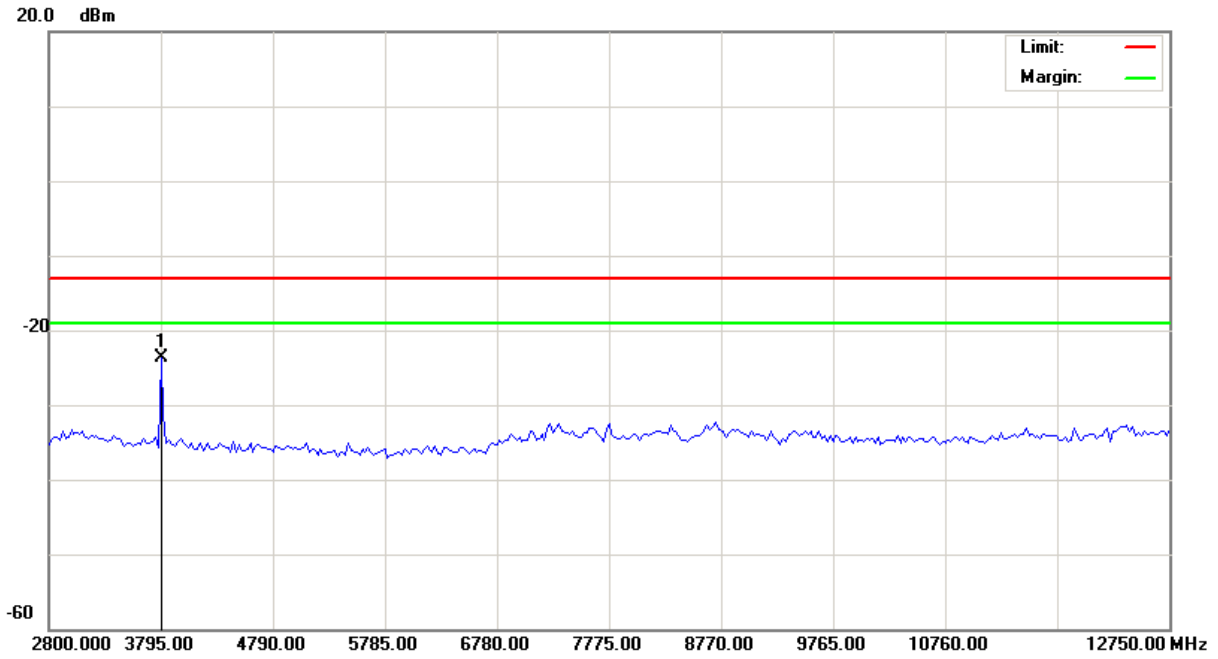

Site	Polarization: Conducted po	Temperature: 26 °C
Limit: FCC Part 24 conducted(9k-12.75G)	Power: AC 110V/60Hz	Humidity: 55 %
EUT:	Distance:	
M/N: 08-0252-SEO		
Mode: WCDMA(BANDII)		
Note: CH9400		

No.	Mk.	Freq.	Reading Level	Correct Factor	Measurement	Limit	Over	Antenna Height	Table Degree	
		MHz	dBm	dB	dBm	dBm	dB	cm	degree	Comment
1	*	3795.000	-28.59	4.93	-23.66	-13.00	-10.66			peak

*:Maximum data x:Over limit !:over margin

●Reference Only



File :FD400(CH9400)

Data :#5

Date: 2008/10/15

Time: 上午 02:01:48

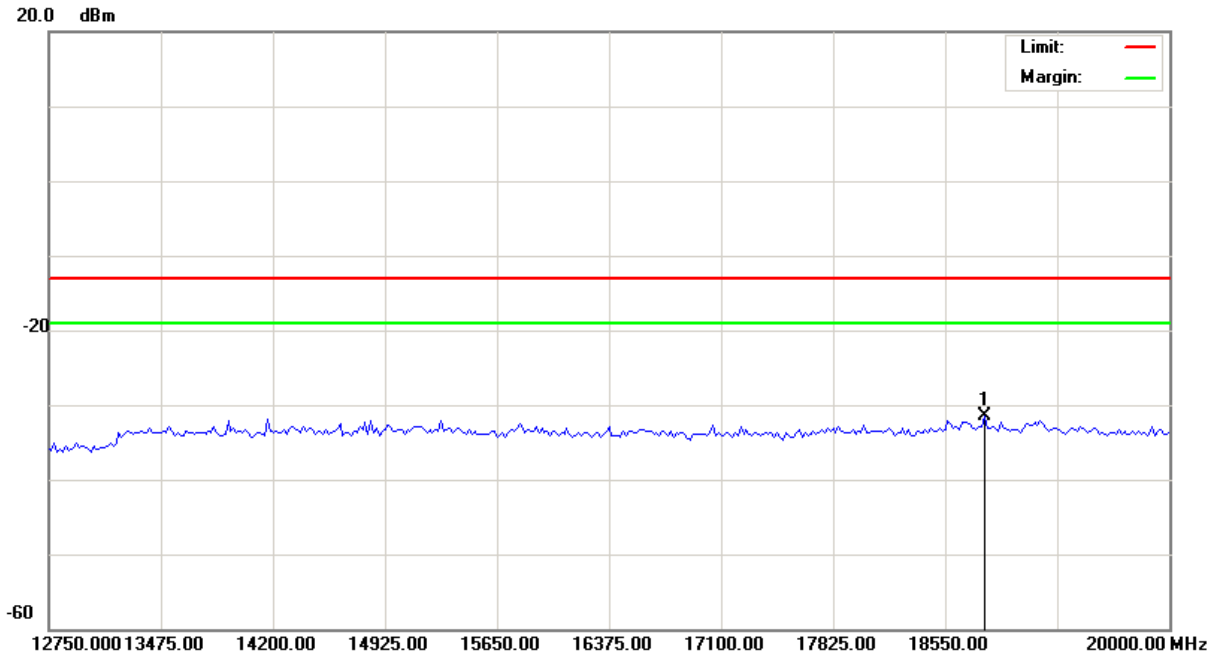

Site Polarization: **Conducted po** Temperature: 26 °C
 Limit: FCC Part 24 conducted(9k-12.75G) Power: AC 110V/60Hz Humidity: 55 %
 EUT: Distance:
 M/N: 08-0252-SEO
 Mode: WCDMA(BANDII)
 Note: CH9400

No.	Mk.	Freq.	Reading Level	Correct Factor	Measurement	Limit	Over	Antenna Height	Table Degree	Comment
		MHz	dBm	dB	dBm	dBm	dB	cm	degree	
1	*	18803.75	-38.69	7.10	-31.59	-13.00	-18.59	peak		

*:Maximum data x:Over limit !:over margin

●Reference Only



File :FD400(CH9538)

Data :#1

Date: 2008/10/15

Time: 上午 02:38:52

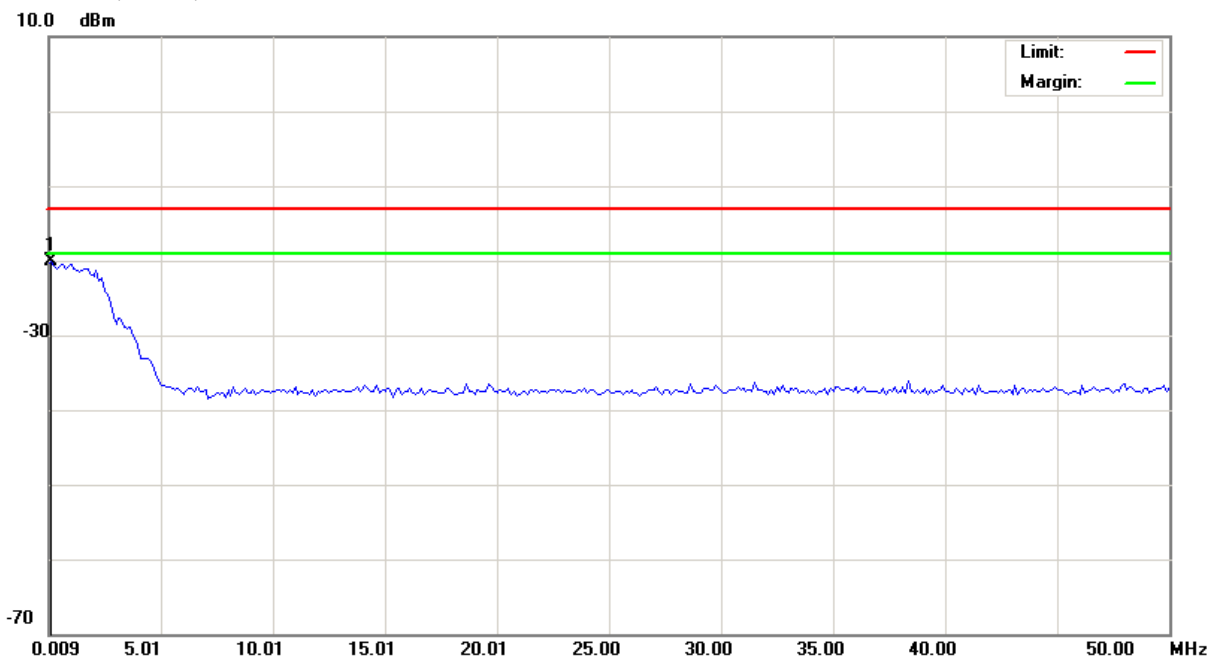

Site Polarization: **Conducted po** Temperature: 26 °C
 Limit: FCC Part 24 conducted(9k-12.75G) Power: AC 110V/60Hz Humidity: 55 %
 EUT: Distance:
 M/N: 08-0252-SEO
 Mode: WCDMA(BANDII)
 Note: CH9538
 加10db衰减器

No.	Mk.	Freq.	Reading Level	Correct Factor	Measurement	Limit	Over	Antenna Height	Table Degree	
		MHz	dBm	dB	dBm	dBm	dB	cm	degree	Comment
1	*	0.1340	-32.48	12.48	-20.00	-13.00	-7.00			peak

*:Maximum data x:Over limit !:over margin

●Reference Only



File :FD400(CH9538)

Data :#2

Date: 2008/10/15

Time: 上午 02:39:13

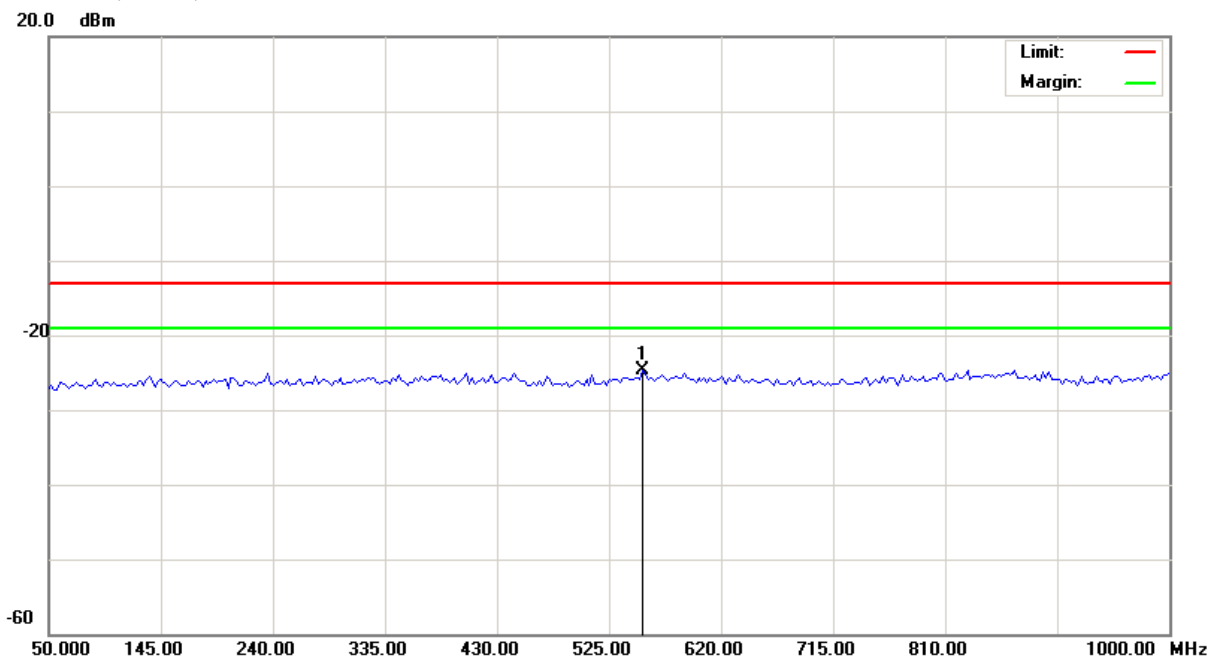

Site Polarization: **Conducted po** Temperature: 26 °C
 Limit: FCC Part 24 conducted(9k-12.75G) Power: AC 110V/60Hz Humidity: 55 %
 EUT: Distance:
 M/N: 08-0252-SEO
 Mode: WCDMA(BANDII)
 Note: CH9538
 加10db衰减器

No.	Mk.	Freq.	Reading Level	Correct Factor	Measurement	Limit	Over	Antenna Height	Table Degree	Detector	Comment
		MHz	dBm	dB	dBm	dBm	dB	cm	degree		
1	*	553.5000	-37.78	13.15	-24.63	-13.00	-11.63			peak	

*:Maximum data x:Over limit !:over margin

●Reference Only



File :FD400(CH9538)

Data :#3

Date: 2008/10/15

Time: 上午 02:57:43

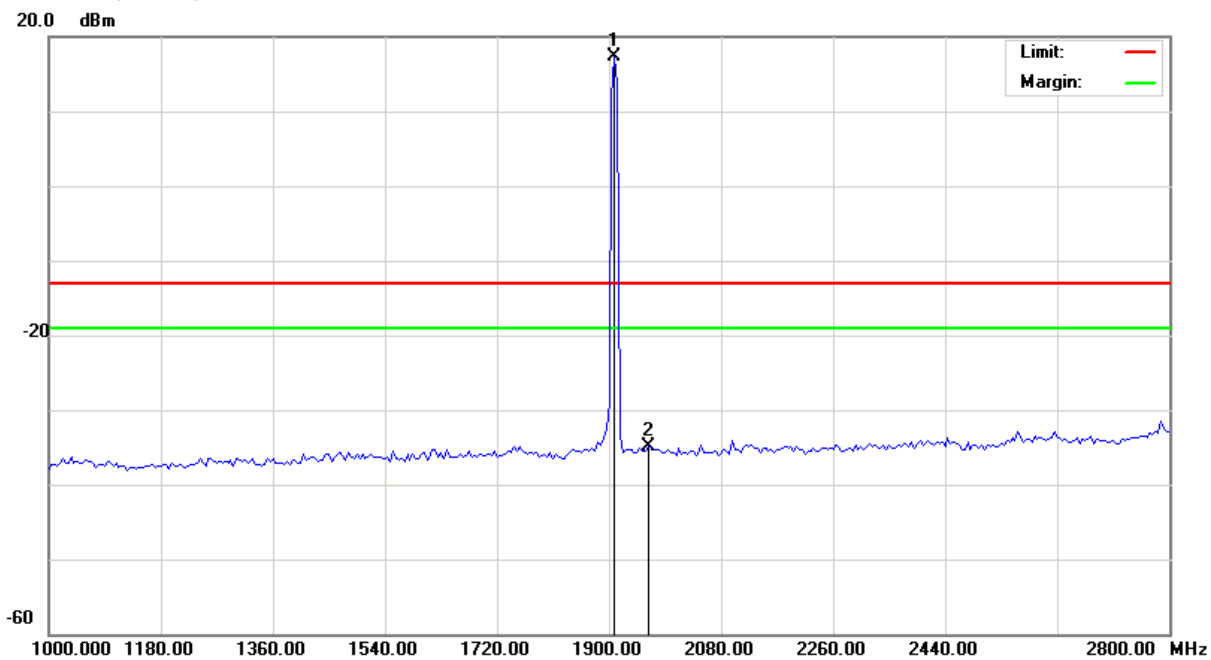

Site Polarization: **Conducted po** Temperature: 26 °C
 Limit: FCC Part 24 conducted(9k-12.75G) Power: AC 110V/60Hz Humidity: 55 %
 EUT: Distance:
 M/N: 08-0252-SEO
 Mode: WCDMA(BANDII)
 Note: CH9538
 加Notch(5TNF-1700)

No.	Mk.	Freq.	Reading Level	Correct Factor	Measurement	Limit	Over	Antenna Height	Table Degree	Comment
		MHz	dBm	dB	dBm	dBm	dB	cm	degree	
1	*	1909.000	11.50	5.80	17.30	-13.00	30.30	peak		Main Frequency
2		1963.000	-39.64	4.74	-34.90	-13.00	-21.90	peak		

*:Maximum data x:Over limit !:over margin

●Reference Only



File :FD400(CH9538)

Data :#4

Date: 2008/10/15

Time: 上午 02:03:59

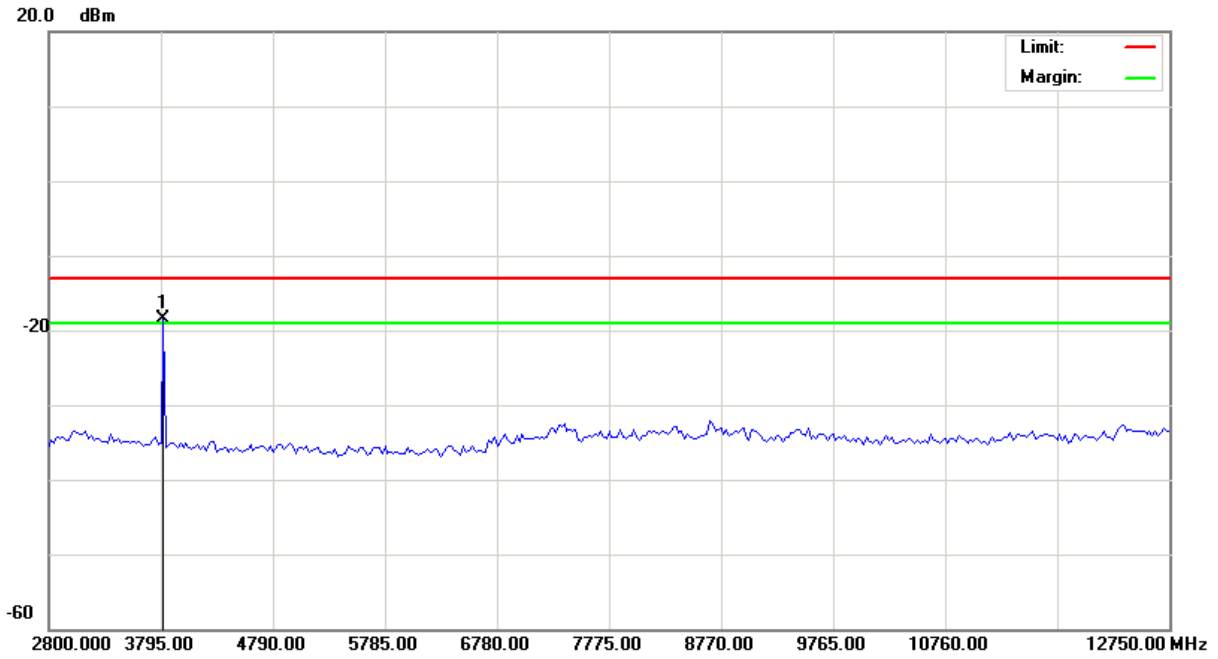

Site Polarization: **Conducted po** Temperature: 26 °C
 Limit: FCC Part 24 conducted(9k-12.75G) Power: AC 110V/60Hz Humidity: 55 %
 EUT: Distance:
 M/N: 08-0252-SEO
 Mode: WCDMA(BANDII)
 Note: CH9538

No.	Mk.	Freq.	Reading Level	Correct Factor	Measurement	Limit	Over	Antenna Height	Table Degree	Comment
		MHz	dBm	dB	dBm	dBm	dB	cm	degree	
1	*	3819.875	-23.48	4.91	-18.57	-13.00	-5.57			peak

*:Maximum data x:Over limit !:over margin

●Reference Only



File :FD400(CH9538)

Data :#5

Date: 2008/10/15

Time: 上午 02:04:21

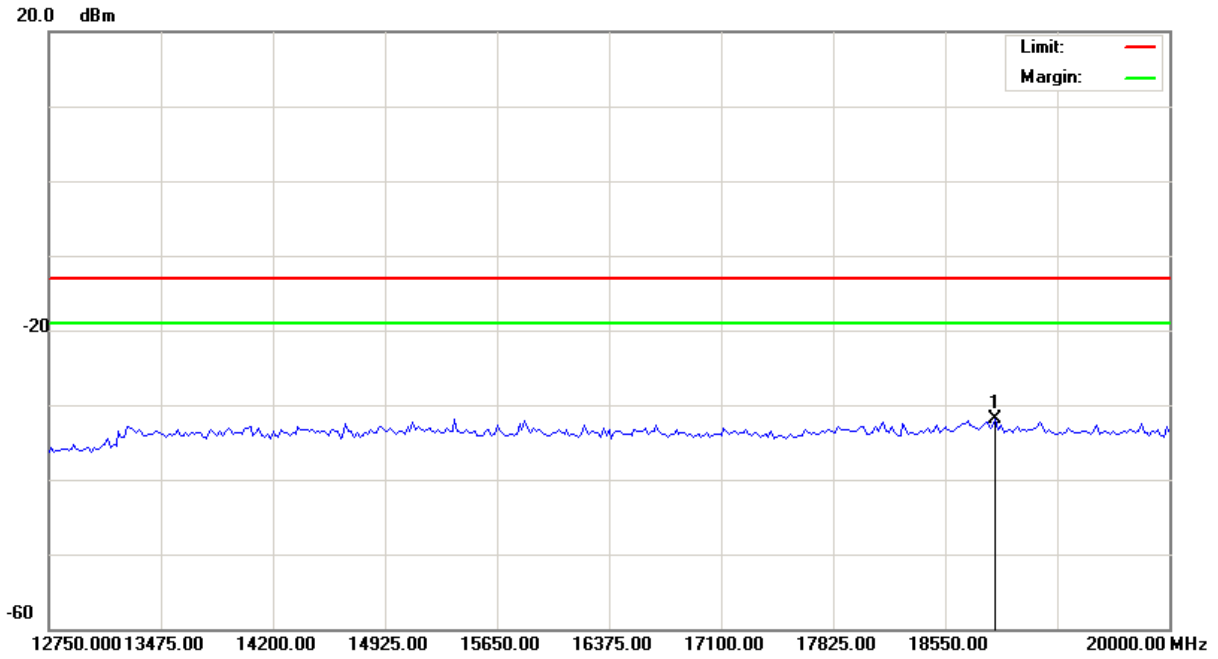

Site Polarization: **Conducted po** Temperature: 26 °C
 Limit: FCC Part 24 conducted(9k-12.75G) Power: AC 110V/60Hz Humidity: 55 %
 EUT: Distance:
 M/N: 08-0252-SEO
 Mode: WCDMA(BANDII)
 Note: CH9538

No.	Mk.	Freq.	Reading Level	Correct Factor	Measurement	Limit	Over	Antenna Height	Table Degree	Comment
		MHz	dBm	dB	dBm	dBm	dB	cm	degree	
1	*	18876.25	-39.02	7.12	-31.90	-13.00	-18.90	peak		

*:Maximum data x:Over limit !:over margin

●Reference Only



4.6 Field Strength of Spurious Radiation

Equivalent isotropic radiated Power Measurements by substitution method according to ANSI/TIA/EIA-603-A.

4.6.1 Measurement Instruments

As described in chapter 5 of this test report.

4.6.2 Test Procedure

The measurement is made according to ANSI/TIA-603-C-2004 as follows:

The equipment under test is placed inside the semi-anechoic chamber on a wooden table at the turntable center. For each spurious frequency, the antenna mast is raised and lowered from 1 to 4 meters and the turntable is rotated 360 degrees to obtain a maximum reading on the spectrum analyzer. This is repeated for both horizontal and vertical polarizations of the receive antenna.

The equipment under test is then replaced with a substitution antenna fed by a signal generator. With the signal generator tuned to a particular spurious frequency, the antenna mast is raised and lowered from 1 to 4 meters to obtain a maximum reading at the spectrum analyzer. The output of the signal generator is then adjusted until a reading identical to that obtained with the actual transmitter is achieved.

The power in dBm of each spurious emission is calculated by correcting the signal generator level for cable loss and gain of the substitution antenna referenced to a dipole. A fully charged battery was used for the supply voltage.

The settings of the receiver were as follows:

Units	dBm
Resolution Bandwidth	1 MHz
Video Bandwidth	Auto
Sweep Time	Auto

4.6.3 Test Setup Layout

Substituted Method Test Set-up

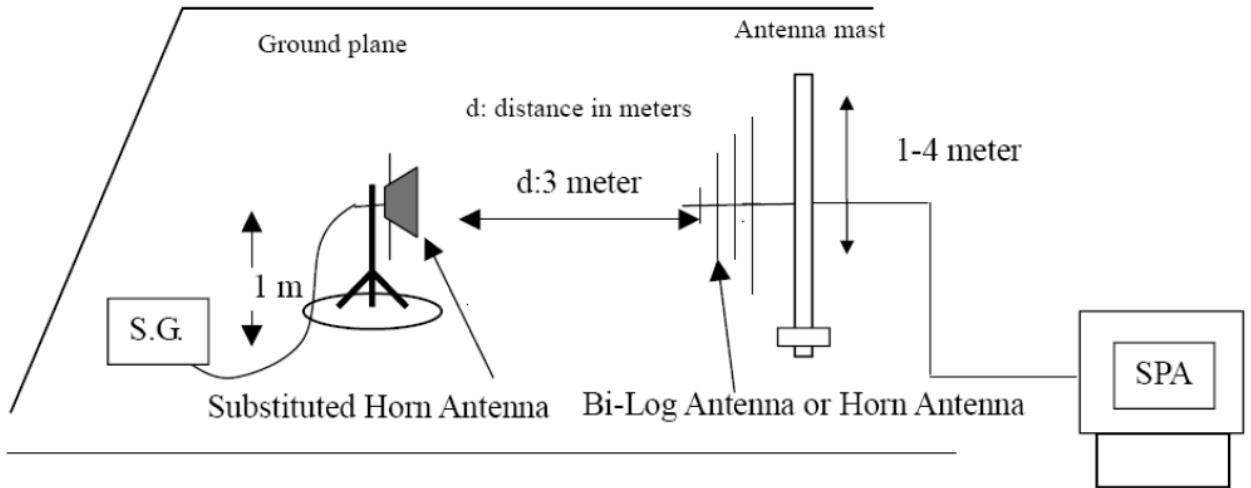



4.6.4 Test Result

4.6.4.1 GPRS 850 Test Result

Applicant : XAC Automation Corporation
 Model No : FD-400
 EUT : Portable Terminal
 Test Mode : GPRS 850 (Low CH128)
 Test Date : 10/16/2008

Harmonic	Frequency (MHz)	Polarization	FCC Max. Limit	S.G Power	Substitution Antenna Gain	Cable Loss	Peak Output Power
			(dBm)	(dBm)	(dBi)	(dBm)	(dBm)
2nd	1648.8	V	-13	-61.58	10.72	0.56	-51.42
3rd	2473.2	V	-13	-53.92	10.66	0.62	-43.88
4th	3297.6	V	-13	-39.40	10.78	0.74	-29.36
5th	4122.0	V	-13	*	*	*	*
6th	4946.4	V	-13	*	*	*	*
7th	5770.8	V	-13	*	*	*	*
8th	6595.2	V	-13	*	*	*	*
9th	7419.6	V	-13	*	*	*	*
10th	8244.0	V	-13	*	*	*	*
2nd	1648.8	H	-13	-59.31	10.72	0.56	-49.15
3rd	2473.2	H	-13	-55.26	10.66	0.62	-45.22
4th	3297.6	H	-13	-39.94	10.78	0.74	-29.90
5th	4122.0	H	-13	*	*	*	*
6th	4946.4	H	-13	*	*	*	*
7th	5770.8	H	-13	*	*	*	*
8th	6595.2	H	-13	*	*	*	*
9th	7419.6	H	-13	*	*	*	*
10th	8244.0	H	-13	*	*	*	*

Notes:

- * Indicates the spurious emission could not be detected due to noise limitations or ambients.
- Each emission reported reflects the highest absolute level at the specific harmonic for the low, mid, and high channels at maximum power.
- The Spectrum was investigated from 30 MHz to the tenth harmonic of the fundamental.
- ERP = S.G Power (dBm) + Substitution Antenna Gain (dBd) - Cable Loss (dB)
 ERP = S.G Power (dBm) + Substitution Antenna Gain (dBi) - Cable Loss (dB)

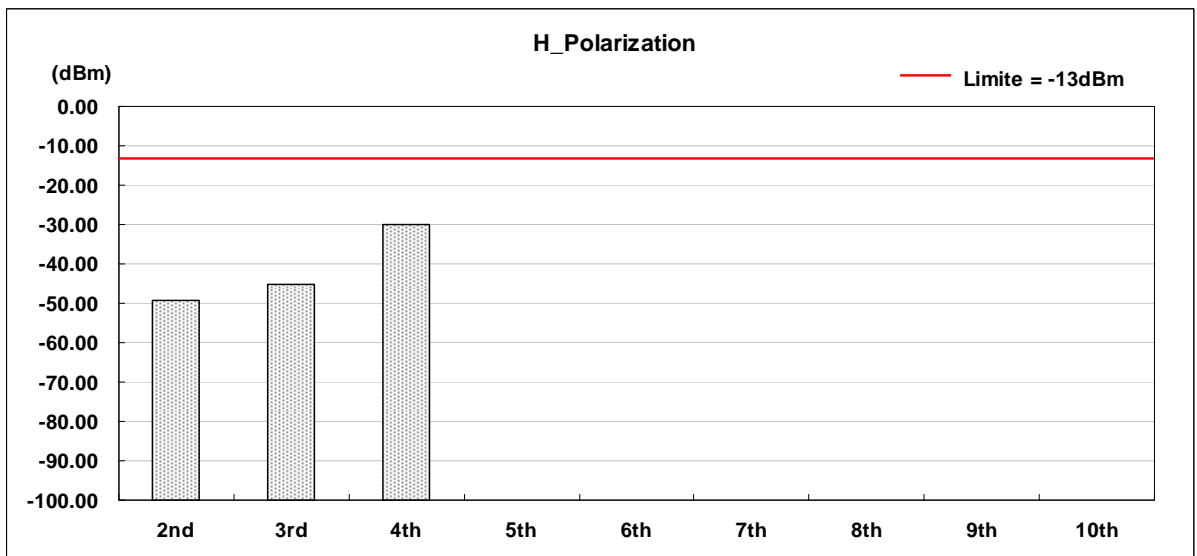
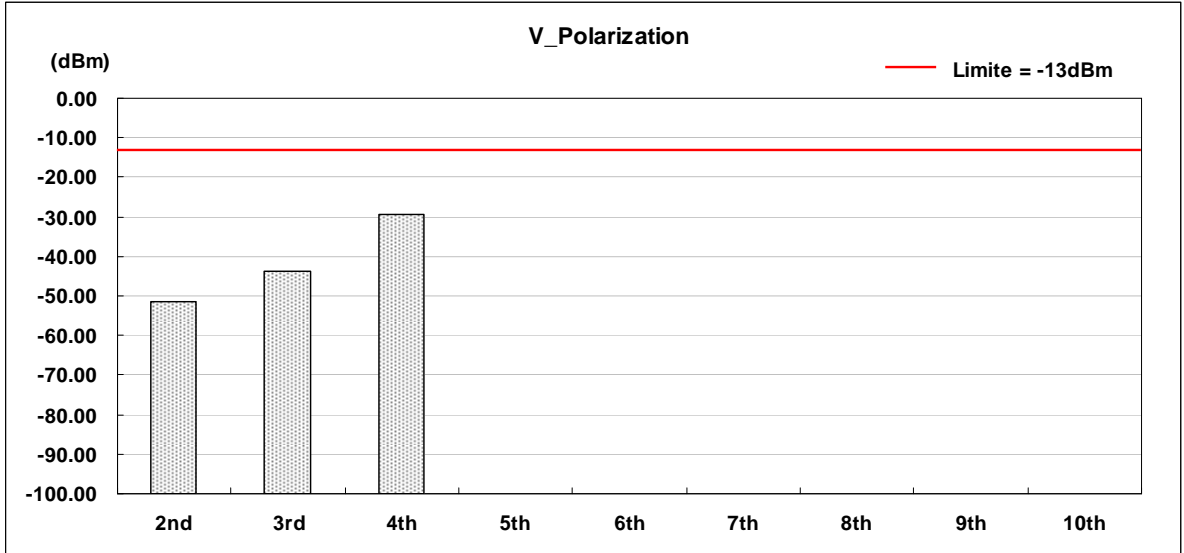



Applicant : XAC Automation Corporation
 Model No : FD-400
 EUT : Portable Terminal
 Test Mode : GPRS 850 (Middle CH190)
 Test Date : 10/15/2008

Harmonic	Frequency (MHz)	Polarization	FCC Max. Limit	S.G Power	Substitution Antenna Gain	Cable Loss	Peak Output Power
			(dBm)	(dBm)	(dBi)	(dBm)	(dBm)
2nd	1673.2	V	-13	-60.26	10.72	0.56	-50.10
3rd	2509.8	V	-13	-53.72	10.66	0.62	-43.68
4th	3346.4	V	-13	-39.00	10.78	0.74	-28.96
5th	4183.0	V	-13	*	*	*	*
6th	5019.6	V	-13	*	*	*	*
7th	5856.2	V	-13	*	*	*	*
8th	6692.8	V	-13	*	*	*	*
9th	7529.4	V	-13	*	*	*	*
10th	8366.0	V	-13	*	*	*	*
2nd	1673.2	H	-13	-59.82	10.72	0.56	-49.66
3rd	2509.8	H	-13	-53.86	10.66	0.62	-43.82
4th	3346.4	H	-13	-37.92	10.78	0.74	-27.88
5th	4183.0	H	-13	*	*	*	*
6th	5019.6	H	-13	*	*	*	*
7th	5856.2	H	-13	*	*	*	*
8th	6692.8	H	-13	*	*	*	*
9th	7529.4	H	-13	*	*	*	*
10th	8366.0	H	-13	*	*	*	*

Notes:

- * Indicates the spurious emission could not be detected due to noise limitations or ambients.
- Each emission reported reflects the highest absolute level at the specific harmonic for the low, mid, and high channels at maximum power.
- The Spectrum was investigated from 30 MHz to the tenth harmonic of the fundamental.
- ERP = S.G Power (dBm) + Substitution Antenna Gain (dBd) - Cable Loss (dB)
 ERP = S.G Power (dBm) + Substitution Antenna Gain (dBi) - Cable Loss (dB)

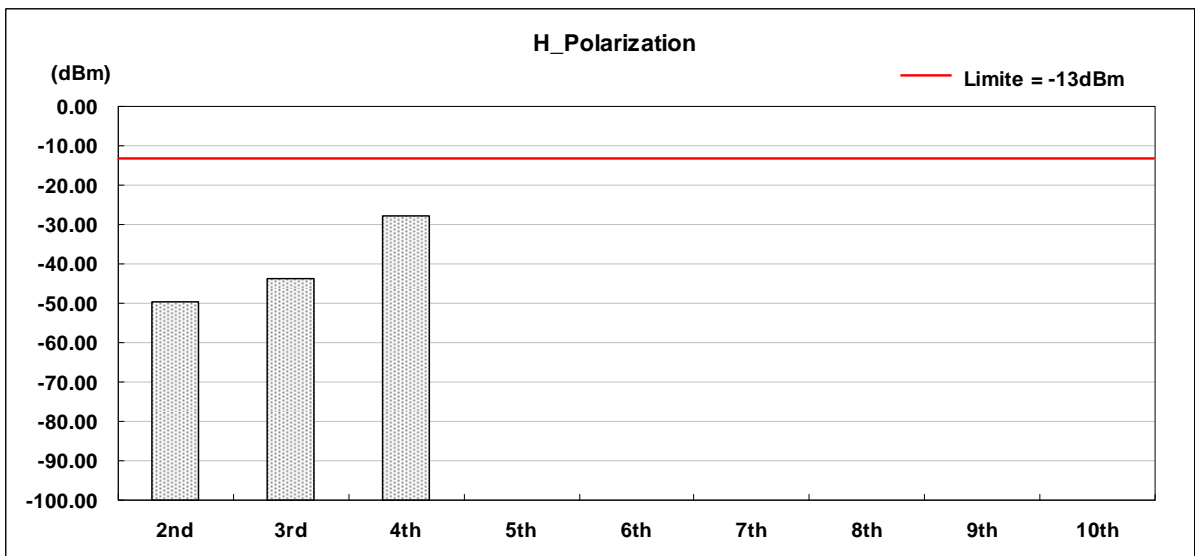
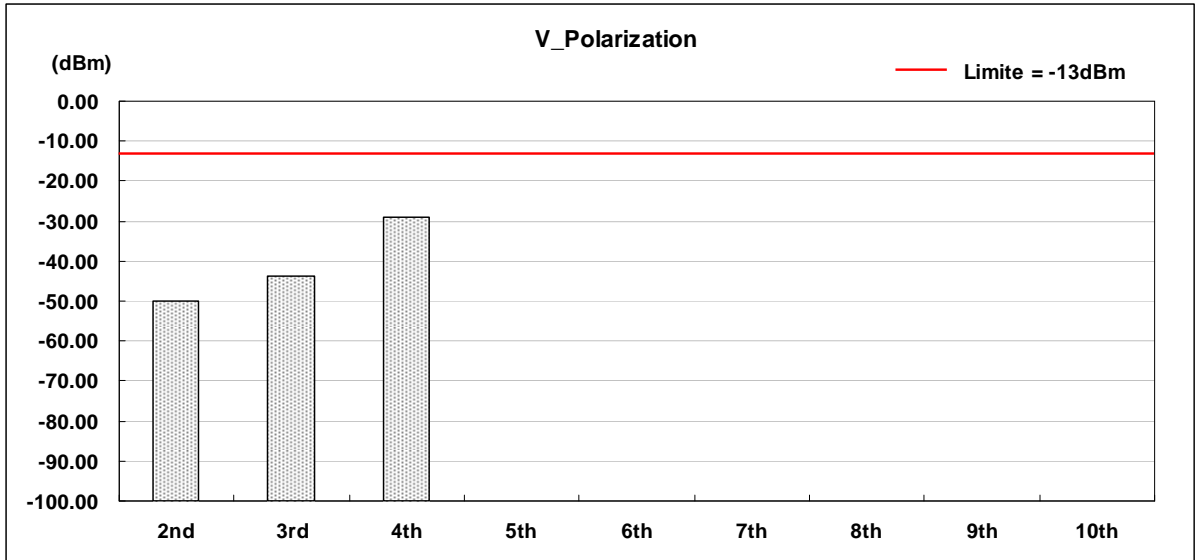



Applicant : XAC Automation Corporation
 Model No : FD-400
 EUT : Portable Terminal
 Test Mode : GPRS 850 (High CH 251)
 Test Date : 10/16/2008

Harmonic	Frequency (MHz)	Polarization	FCC Max. Limit	S.G Power	Substitution Antenna Gain	Cable Loss	Peak Output Power
			(dBm)	(dBm)	(dBi)	(dBm)	(dBm)
2nd	1697.6	V	-13	-59.82	10.72	0.56	-49.66
3rd	2546.4	V	-13	-53.82	10.66	0.62	-43.78
4th	3395.2	V	-13	-38.87	10.78	0.74	-28.83
5th	4244.0	V	-13	*	*	*	*
6th	5092.8	V	-13	*	*	*	*
7th	5941.6	V	-13	*	*	*	*
8th	6790.4	V	-13	*	*	*	*
9th	7639.2	V	-13	*	*	*	*
10th	8488.0	V	-13	*	*	*	*
2nd	1697.6	H	-13	-60.05	10.72	0.56	-49.89
3rd	2546.4	H	-13	-53.80	10.66	0.62	-43.76
4th	3395.2	H	-13	-38.97	10.78	0.74	-28.93
5th	4244.0	H	-13	*	*	*	*
6th	5092.8	H	-13	*	*	*	*
7th	5941.6	H	-13	*	*	*	*
8th	6790.4	H	-13	*	*	*	*
9th	7639.2	H	-13	*	*	*	*
10th	8488.0	H	-13	*	*	*	*

Notes:

- * Indicates the spurious emission could not be detected due to noise limitations or ambients.
- Each emission reported reflects the highest absolute level at the specific harmonic for the low, mid, and high channels at maximum power.
- The Spectrum was investigated from 30 MHz to the tenth harmonic of the fundamental.
- $ERP = S.G \text{ Power (dBm)} + \text{Substitution Antenna Gain (dBd)} - \text{Cable Loss (dB)}$
 $ERP = S.G \text{ Power (dBm)} + \text{Substitution Antenna Gain (dBi)} - \text{Cable Loss (dB)}$

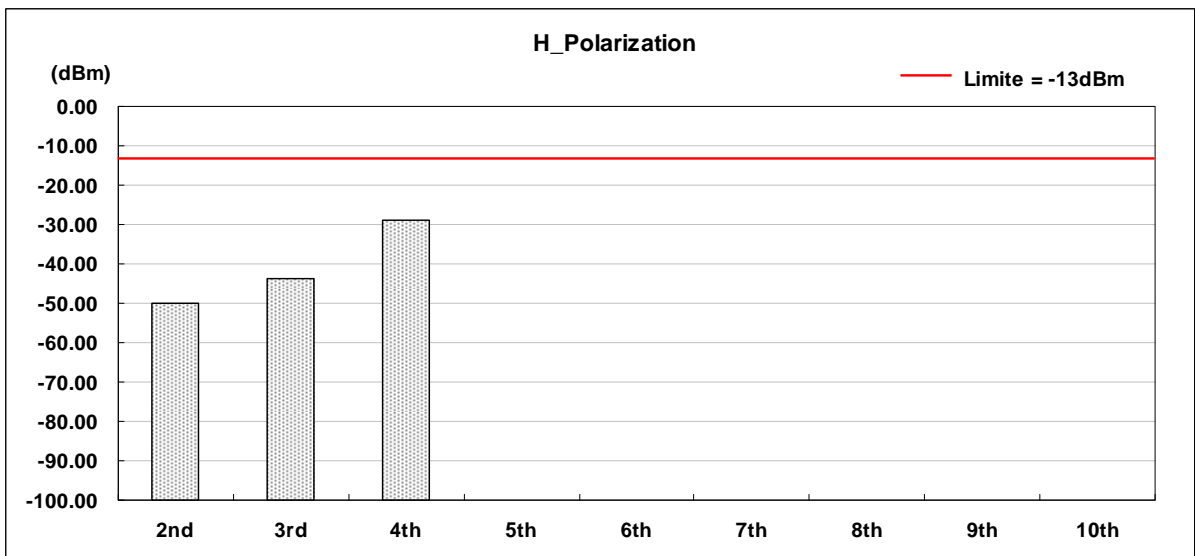
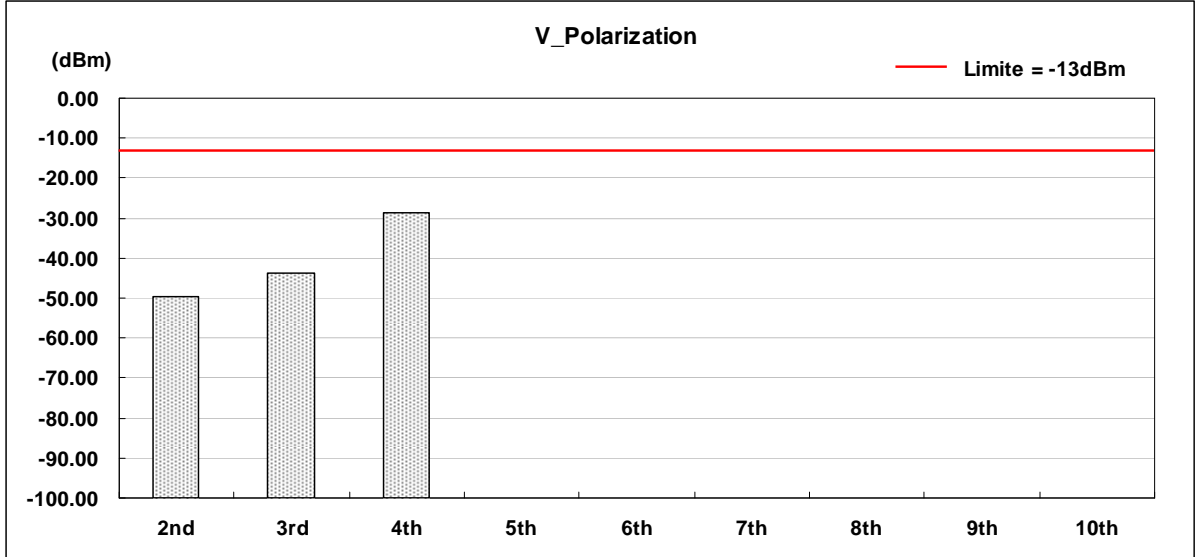



4.6.4.2 PCS 1900 Test Result

Applicant : XAC Automation Corporation
 Model No : FD-400
 EUT : Portable Terminal
 Test Mode : GPRS 1900 (Low CH512)
 Test Date : 10/16/2008

Harmonic	Frequency (MHz)	Polarization	FCC Max. Limit	S.G Power	Substitution Antenna Gain	Cable Loss	Peak Output Power
			(dBm)	(dBm)	(dBi)	(dBm)	(dBm)
2nd	3700.4	V	-13	-52.16	10.72	0.56	-42.00
3rd	5550.6	V	-13	-45.23	10.66	0.62	-35.19
4th	7400.8	V	-13	-39.20	10.78	0.74	-29.16
5th	9251.0	V	-13	*	*	*	*
6th	11101.2	V	-13	*	*	*	*
7th	12951.4	V	-13	*	*	*	*
8th	14801.6	V	-13	*	*	*	*
9th	16651.8	V	-13	*	*	*	*
10th	18502.0	V	-13	*	*	*	*
2nd	3700.4	H	-13	-52.58	10.72	0.56	-42.42
3rd	5550.6	H	-13	-46.39	10.66	0.62	-36.35
4th	7400.8	H	-13	-38.97	10.78	0.74	-28.93
5th	9251.0	H	-13	*	*	*	*
6th	11101.2	H	-13	*	*	*	*
7th	12951.4	H	-13	*	*	*	*
8th	14801.6	H	-13	*	*	*	*
9th	16651.8	H	-13	*	*	*	*
10th	18502.0	H	-13	*	*	*	*

Notes:

- * Indicates the spurious emission could not be detected due to noise limitations or ambients.
- Each emission reported reflects the highest absolute level at the specific harmonic for the low, mid, and high channels at maximum power.
- The Spectrum was investigated from 30 MHz to the tenth harmonic of the fundamental.
- ERP = S.G Power (dBm) + Substitution Antenna Gain (dBd) - Cable Loss (dB)
 ERP = S.G Power (dBm) + Substitution Antenna Gain (dBi) - Cable Loss (dB)

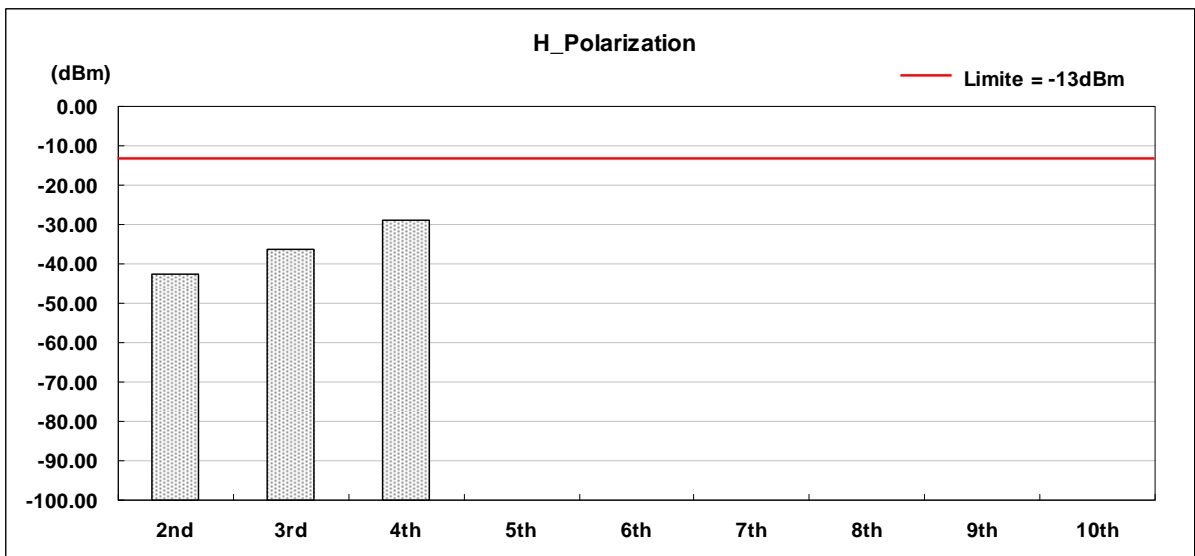
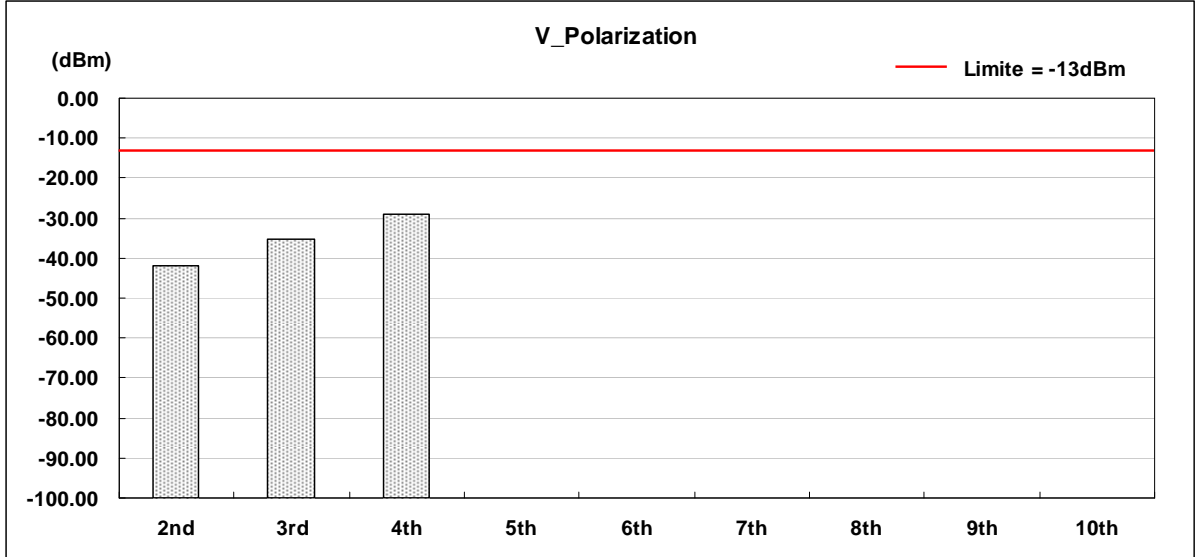



Applicant : XAC Automation Corporation
 Model No : FD-400
 EUT : Portable Terminal
 Test Mode : GPRS 1900 (Middle CH661)
 Test Date : 10/16/2008

Harmonic	Frequency (MHz)	Polarization	FCC Max. Limit	S.G Power	Substitution Antenna Gain	Cable Loss	Peak Output Power
			(dBm)	(dBm)	(dBi)	(dBm)	(dBm)
2nd	3760.0	V	-13	-51.95	10.72	0.56	-41.79
3rd	5640.0	V	-13	-46.63	10.66	0.62	-36.59
4th	7520.0	V	-13	-39.01	10.78	0.74	-28.97
5th	9400.0	V	-13	*	*	*	*
6th	11280.0	V	-13	*	*	*	*
7th	13160.0	V	-13	*	*	*	*
8th	15040.0	V	-13	*	*	*	*
9th	16920.0	V	-13	*	*	*	*
10th	18800.0	V	-13	*	*	*	*
2nd	3760.0	H	-13	-52.89	10.72	0.56	-42.73
3rd	5640.0	H	-13	-46.59	10.66	0.62	-36.55
4th	7520.0	H	-13	-39.05	10.78	0.74	-29.01
5th	9400.0	H	-13	*	*	*	*
6th	11280.0	H	-13	*	*	*	*
7th	13160.0	H	-13	*	*	*	*
8th	15040.0	H	-13	*	*	*	*
9th	16920.0	H	-13	*	*	*	*
10th	18800.0	H	-13	*	*	*	*

Notes:

- * Indicates the spurious emission could not be detected due to noise limitations or ambients.
- Each emission reported reflects the highest absolute level at the specific harmonic for the low, mid, and high channels at maximum power.
- The Spectrum was investigated from 30 MHz to the tenth harmonic of the fundamental.
- ERP = S.G Power (dBm) + Substitution Antenna Gain (dBd) - Cable Loss (dB)
 ERP = S.G Power (dBm) + Substitution Antenna Gain (dBi) - Cable Loss (dB)

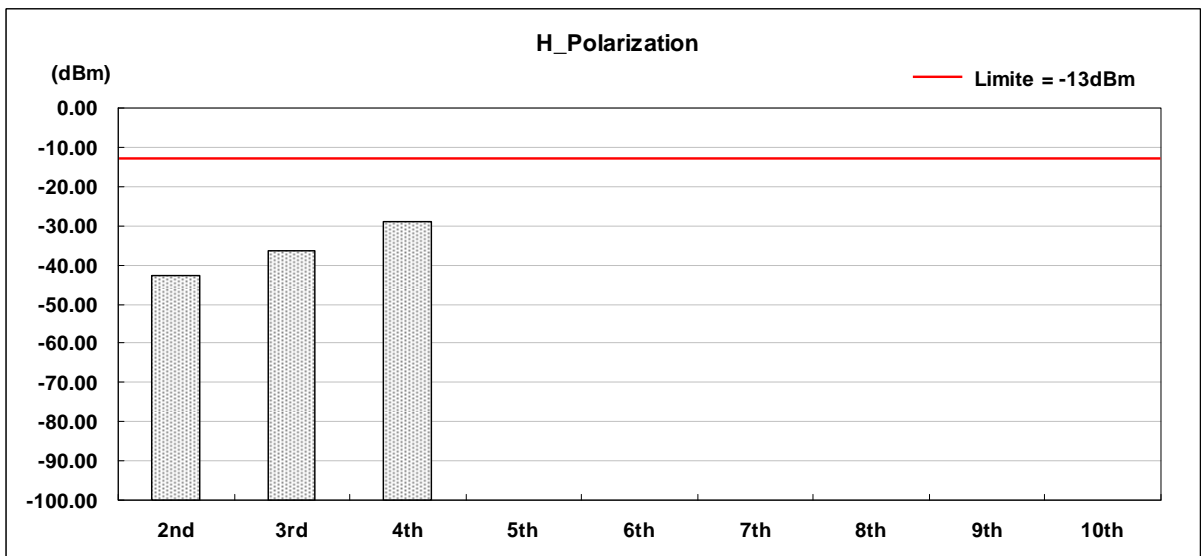
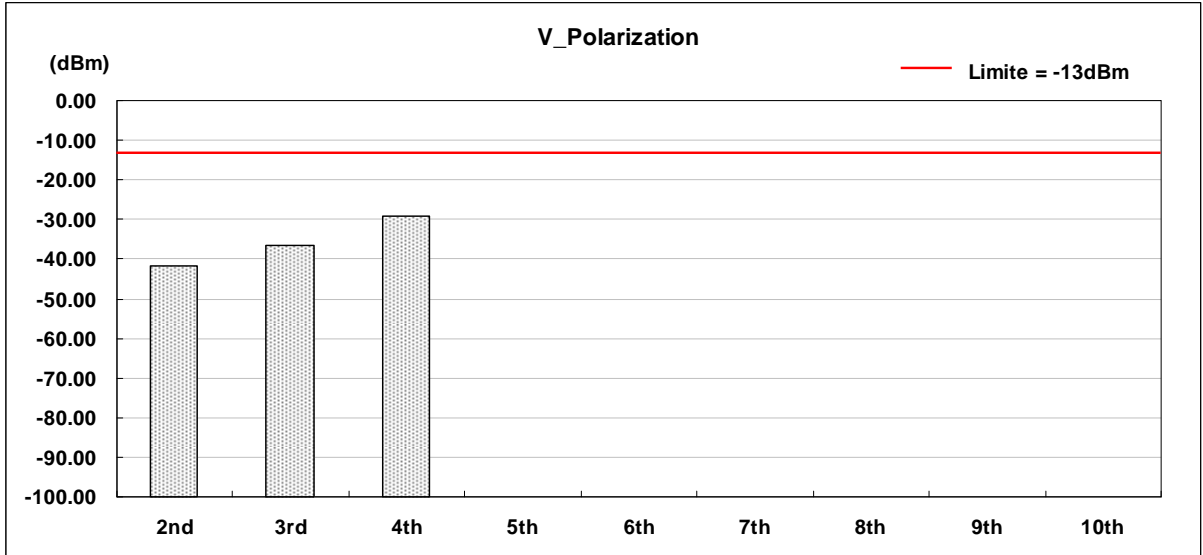



Applicant : XAC Automation Corporation
 Model No : FD-400
 EUT : Portable Terminal
 Test Mode : GPRS 1900 (High CH 810)
 Test Date : 10/16/2008

Harmonic	Frequency (MHz)	Polarization	FCC Max. Limit	S.G Power	Substitution Antenna Gain	Cable Loss	Peak Output Power
			(dBm)	(dBm)	(dBi)	(dBm)	(dBm)
2nd	3819.6	V	-13	-52.73	10.72	0.56	-42.57
3rd	5729.4	V	-13	-46.12	10.66	0.62	-36.08
4th	7639.2	V	-13	-39.16	10.78	0.74	-29.12
5th	9549.0	V	-13	*	*	*	*
6th	11458.8	V	-13	*	*	*	*
7th	13368.6	V	-13	*	*	*	*
8th	15278.4	V	-13	*	*	*	*
9th	17188.2	V	-13	*	*	*	*
10th	19098.0	V	-13	*	*	*	*
2nd	3819.6	H	-13	-51.85	10.72	0.56	-41.69
3rd	5729.4	H	-13	-46.39	10.66	0.62	-36.35
4th	7639.2	H	-13	-38.55	10.78	0.74	-28.51
5th	9549.0	H	-13	*	*	*	*
6th	11458.8	H	-13	*	*	*	*
7th	13368.6	H	-13	*	*	*	*
8th	15278.4	H	-13	*	*	*	*
9th	17188.2	H	-13	*	*	*	*
10th	19098.0	H	-13	*	*	*	*

Notes:

- * Indicates the spurious emission could not be detected due to noise limitations or ambients.
- Each emission reported reflects the highest absolute level at the specific harmonic for the low, mid, and high channels at maximum power.
- The Spectrum was investigated from 30 MHz to the tenth harmonic of the fundamental.
- ERP = S.G Power (dBm) + Substitution Antenna Gain (dBd) - Cable Loss (dB)
 ERP = S.G Power (dBm) + Substitution Antenna Gain (dBi) - Cable Loss (dB)

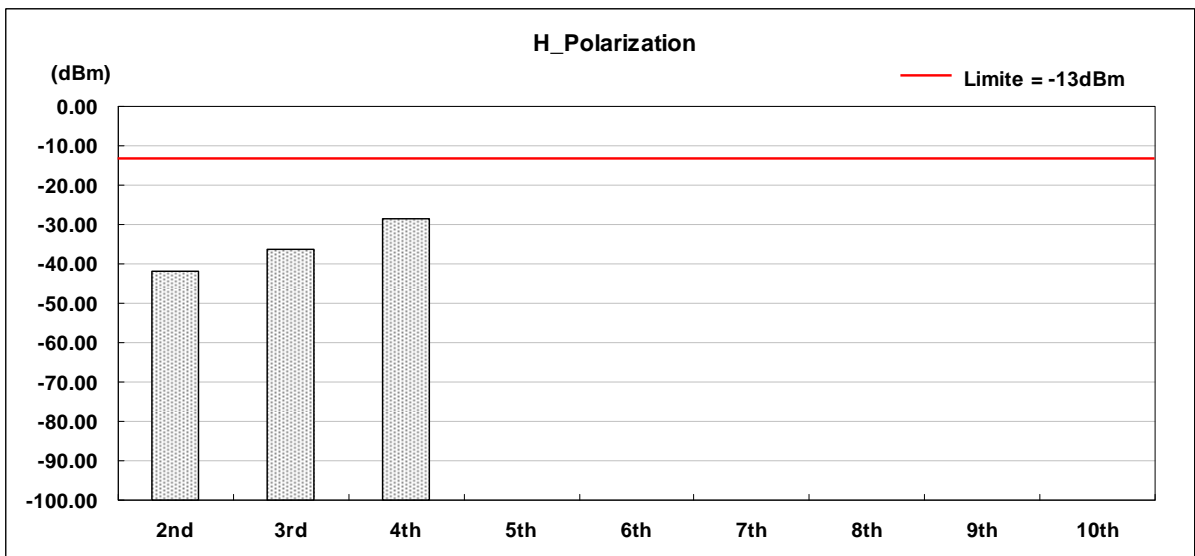
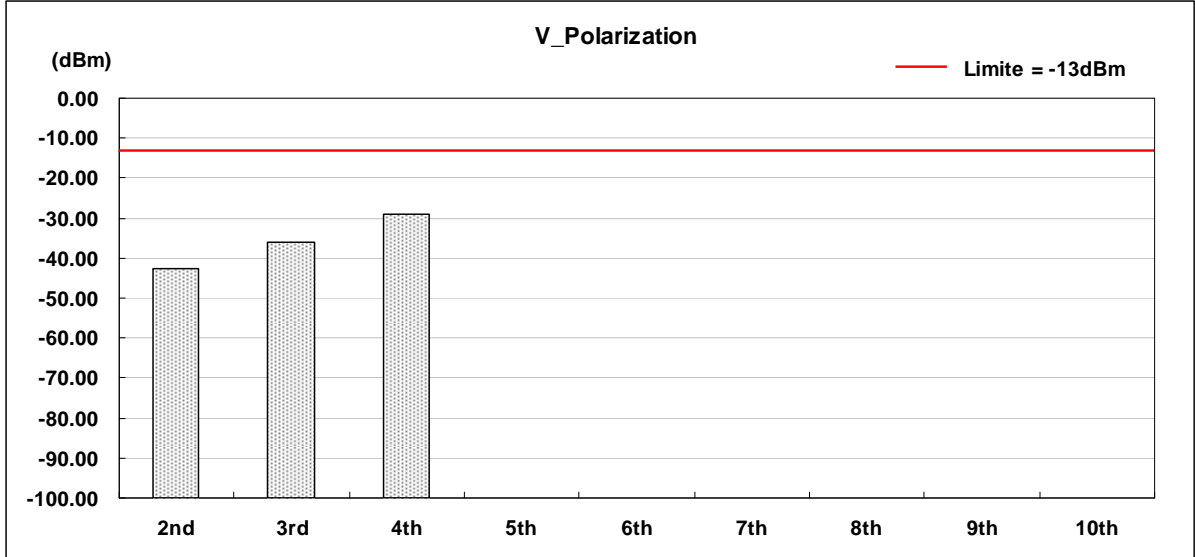



4.6.4.3 WCDMA Band V Test Result

Applicant : XAC Automation Corporation
 Model No : FD-400
 EUT : Portable Terminal
 Test Mode : WCDMA Band V (Low CH4132)
 Test Date : 10/16/2008

Harmonic	Frequency (MHz)	Polarization	FCC Max. Limit	S.G Power	Substitution Antenna Gain	Cable Loss	Peak Output Power
			(dBm)	(dBm)	(dBi)	(dBm)	(dBm)
2nd	1652.8	V	-13	-60.01	10.74	0.59	-49.86
3rd	2479.2	V	-13	-53.95	10.68	0.63	-43.90
4th	3305.6	V	-13	-39.92	10.80	0.78	-29.90
5th	4132.0	V	-13	*	*	*	*
6th	4958.4	V	-13	*	*	*	*
7th	5784.8	V	-13	*	*	*	*
8th	6611.2	V	-13	*	*	*	*
9th	7437.6	V	-13	*	*	*	*
10th	8264.0	V	-13	*	*	*	*
2nd	1652.8	H	-13	-60.90	10.74	0.59	-50.75
3rd	2479.2	H	-13	-53.93	10.68	0.63	-43.88
4th	3305.6	H	-13	-39.38	10.80	0.78	-29.36
5th	4132.0	H	-13	*	*	*	*
6th	4958.4	H	-13	*	*	*	*
7th	5784.8	H	-13	*	*	*	*
8th	6611.2	H	-13	*	*	*	*
9th	7437.6	H	-13	*	*	*	*
10th	8264.0	H	-13	*	*	*	*

Notes:

- * Indicates the spurious emission could not be detected due to noise limitations or ambients.
- Each emission reported reflects the highest absolute level at the specific harmonic for the low, mid, and high channels at maximum power.
- The Spectrum was investigated from 30 MHz to the tenth harmonic of the fundamental.
- ERP = S.G Power (dBm) + Substitution Antenna Gain (dBd) - Cable Loss (dB)
 ERP = S.G Power (dBm) + Substitution Antenna Gain (dBi) - Cable Loss (dB)

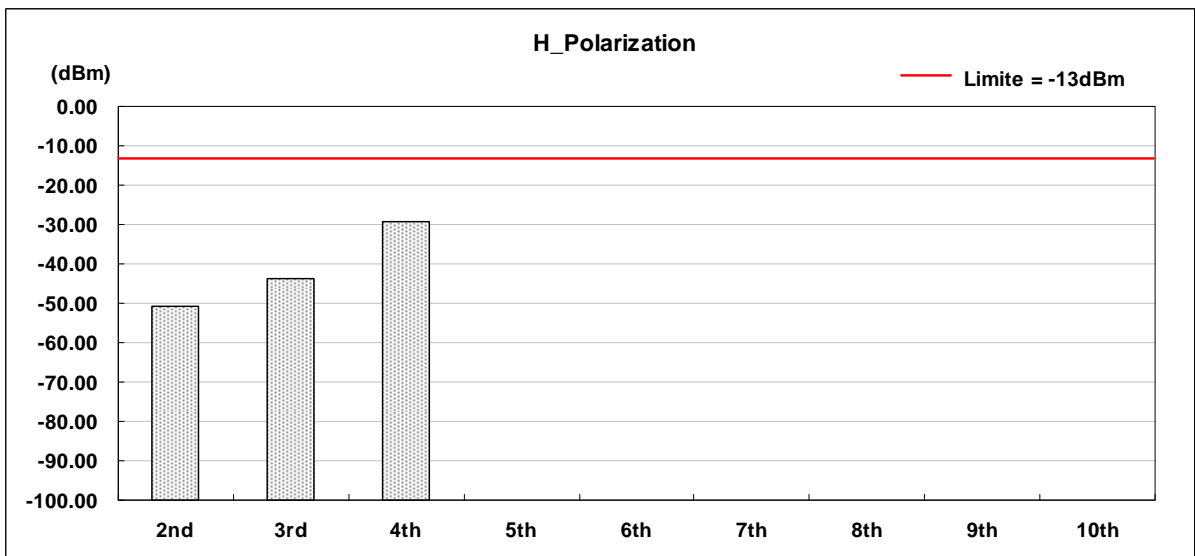
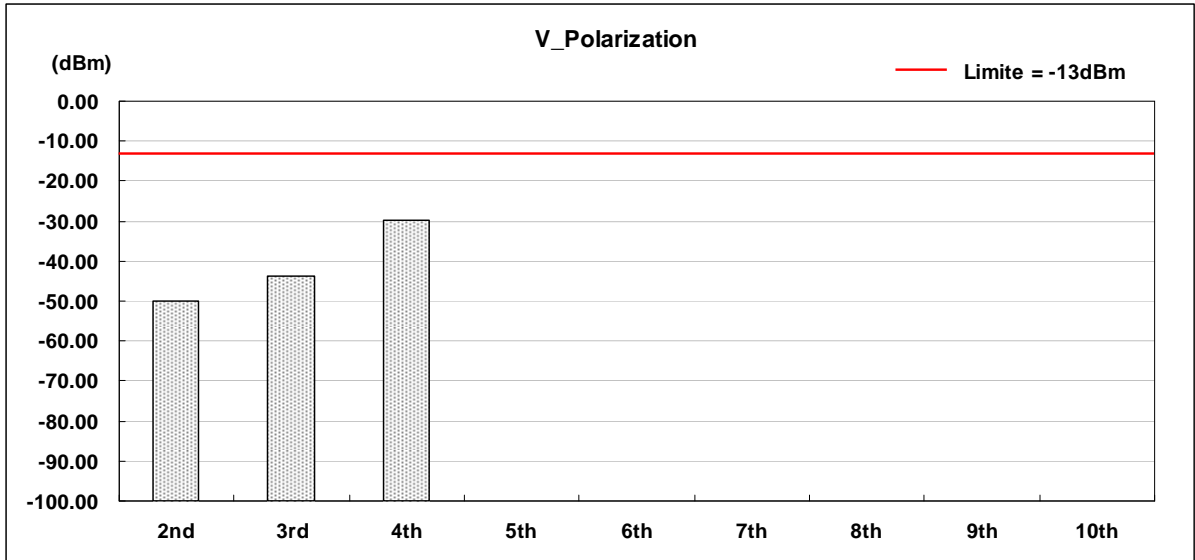



Applicant : XAC Automation Corporation
 Model No : FD-400
 EUT : Portable Terminal
 Test Mode : WCDMA Band V (Middle CH4182)
 Test Date : 10/16/2008

Harmonic	Frequency (MHz)	Polarization	FCC Max. Limit	S.G Power	Substitution Antenna Gain	Cable Loss	Peak Output Power
			(dBm)	(dBm)	(dBi)	(dBm)	(dBm)
2nd	1693.2	V	-13	-60.63	10.74	0.59	-50.48
3rd	2539.8	V	-13	-53.87	10.68	0.63	-43.82
4th	3386.4	V	-13	-37.90	10.80	0.78	-27.88
5th	4233.0	V	-13	*	*	*	*
6th	5079.6	V	-13	*	*	*	*
7th	5926.2	V	-13	*	*	*	*
8th	6772.8	V	-13	*	*	*	*
9th	7619.4	V	-13	*	*	*	*
10th	8466.0	V	-13	*	*	*	*
2nd	1693.2	H	-13	-60.43	10.74	0.59	-50.28
3rd	2539.8	H	-13	-53.73	10.68	0.63	-43.68
4th	3386.4	H	-13	-38.98	10.80	0.78	-28.96
5th	4233.0	H	-13	*	*	*	*
6th	5079.6	H	-13	*	*	*	*
7th	5926.2	H	-13	*	*	*	*
8th	6772.8	H	-13	*	*	*	*
9th	7619.4	H	-13	*	*	*	*
10th	8466.0	H	-13	*	*	*	*

Notes:

- * Indicates the spurious emission could not be detected due to noise limitations or ambients.
- Each emission reported reflects the highest absolute level at the specific harmonic for the low, mid, and high channels at maximum power.
- The Spectrum was investigated from 30 MHz to the tenth harmonic of the fundamental.
- ERP = S.G Power (dBm) + Substitution Antenna Gain (dBd) - Cable Loss (dB)
 ERP = S.G Power (dBm) + Substitution Antenna Gain (dBi) - Cable Loss (dB)

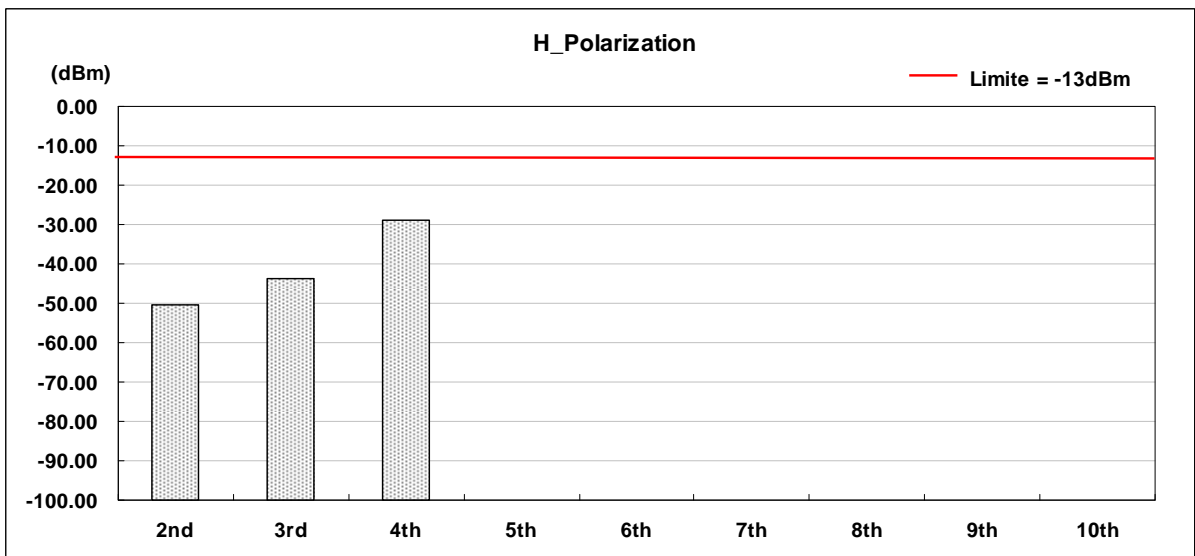
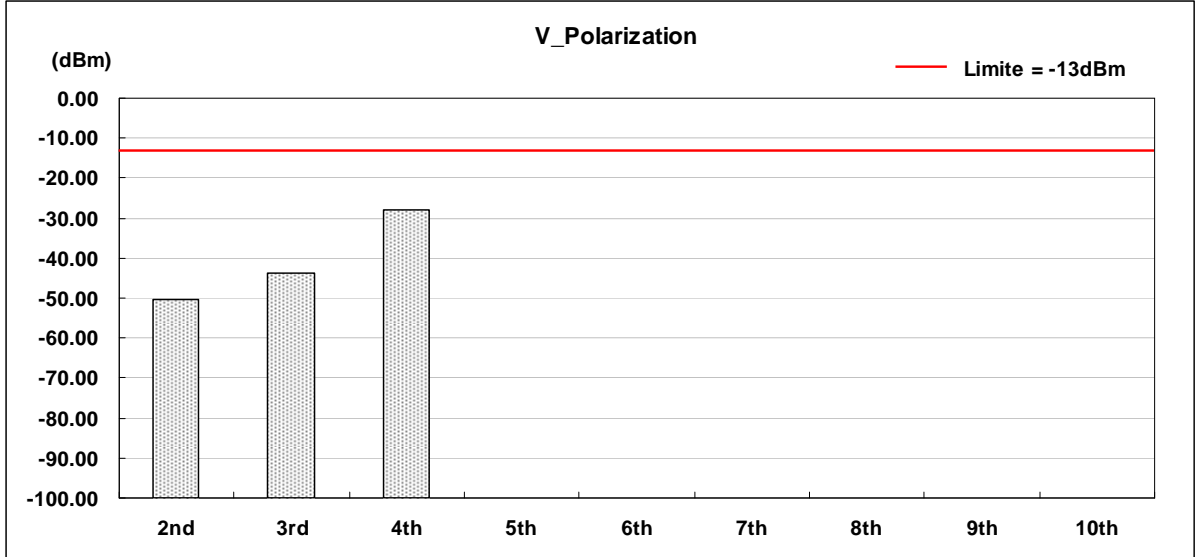



Applicant : XAC Automation Corporation
 Model No : FD-400
 EUT : Portable Terminal
 Test Mode : WCDMA Band V (High CH 4233)
 Test Date : 10/16/2008

Harmonic	Frequency (MHz)	Polarization	FCC Max. Limit	S.G Power	Substitution Antenna Gain	Cable Loss	Peak Output Power
			(dBm)	(dBm)	(dBi)	(dBm)	(dBm)
2nd	1693.2	V	-13	-60.70	10.74	0.59	-50.55
3rd	2539.8	V	-13	-53.81	10.68	0.63	-43.76
4th	3386.4	V	-13	-38.95	10.80	0.78	-28.93
5th	4233.0	V	-13	*	*	*	*
6th	5079.6	V	-13	*	*	*	*
7th	5926.2	V	-13	*	*	*	*
8th	6772.8	V	-13	*	*	*	*
9th	7619.4	V	-13	*	*	*	*
10th	8466.0	V	-13	*	*	*	*
2nd	1693.2	H	-13	-60.38	10.74	0.59	-50.23
3rd	2539.8	H	-13	-53.83	10.68	0.63	-43.78
4th	3386.4	H	-13	-38.85	10.80	0.78	-28.83
5th	4233.0	H	-13	*	*	*	*
6th	5079.6	H	-13	*	*	*	*
7th	5926.2	H	-13	*	*	*	*
8th	6772.8	H	-13	*	*	*	*
9th	7619.4	H	-13	*	*	*	*
10th	8466.0	H	-13	*	*	*	*

Notes:

- * Indicates the spurious emission could not be detected due to noise limitations or ambients.
- Each emission reported reflects the highest absolute level at the specific harmonic for the low, mid, and high channels at maximum power.
- The Spectrum was investigated from 30 MHz to the tenth harmonic of the fundamental.
- ERP = S.G Power (dBm) + Substitution Antenna Gain (dBd) - Cable Loss (dB)
 ERP = S.G Power (dBm) + Substitution Antenna Gain (dBi) - Cable Loss (dB)

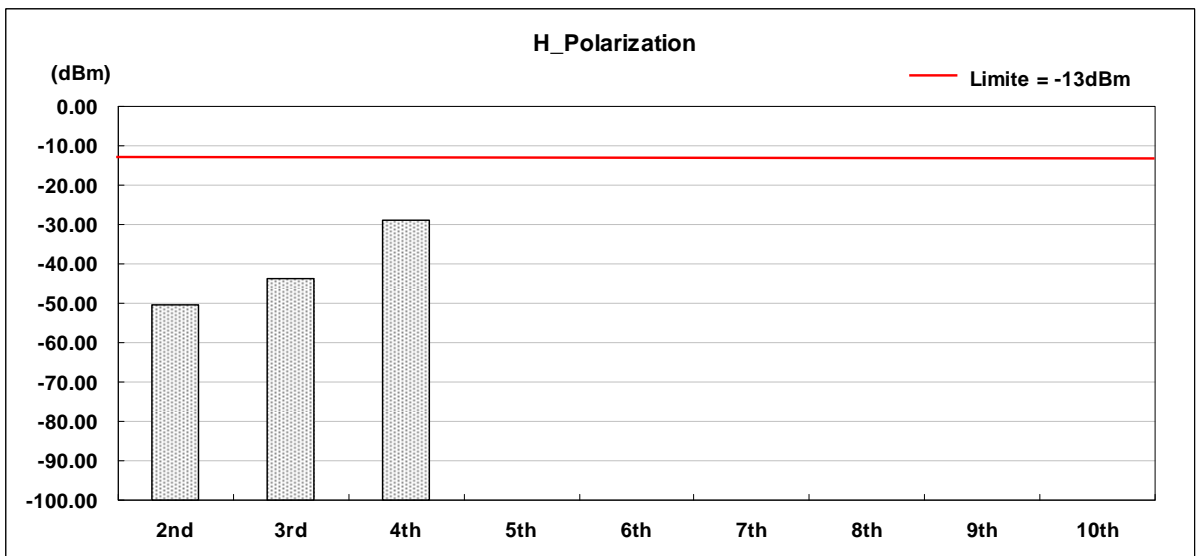
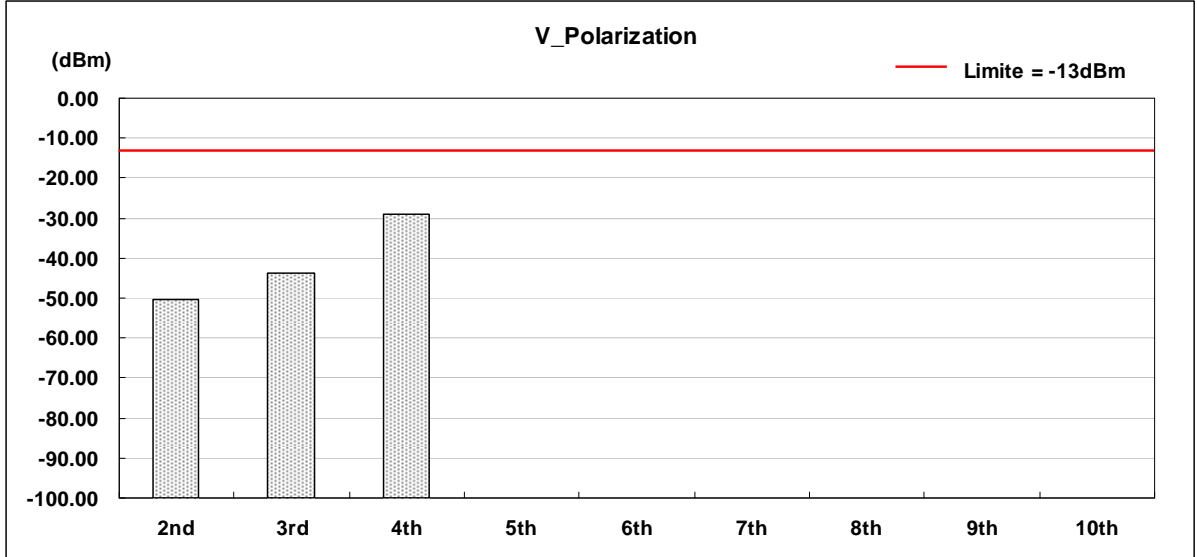



4.6.4.4 WCDMA Band II Test Result

Applicant : XAC Automation Corporation
 Model No : FD-400
 EUT : Portable Terminal
 Test Mode : WCDMA Band II (Low CH9262)
 Test Date : 10/16/2008

Harmonic	Frequency (MHz)	Polarization	FCC Max. Limit	S.G Power	Substitution Antenna Gain	Cable Loss	Peak Output Power
			(dBm)	(dBm)	(dBi)	(dBm)	(dBm)
2nd	3704.8	V	-13	-52.72	10.79	0.58	-42.51
3rd	5557.2	V	-13	-46.21	10.71	0.63	-36.13
4th	7409.6	V	-13	-38.86	10.81	0.78	-28.83
5th	9262.0	V	-13	*	*	*	*
6th	11114.4	V	-13	*	*	*	*
7th	12966.8	V	-13	*	*	*	*
8th	14819.2	V	-13	*	*	*	*
9th	16671.6	V	-13	*	*	*	*
10th	18524.0	V	-13	*	*	*	*
2nd	3704.8	H	-13	-47.36	10.79	0.58	-37.15
3rd	5557.2	H	-13	-45.40	10.71	0.63	-35.32
4th	7409.6	H	-13	-38.94	10.81	0.78	-28.91
5th	9262.0	H	-13	*	*	*	*
6th	11114.4	H	-13	*	*	*	*
7th	12966.8	H	-13	*	*	*	*
8th	14819.2	H	-13	*	*	*	*
9th	16671.6	H	-13	*	*	*	*
10th	18524.0	H	-13	*	*	*	*

Notes:

- * Indicates the spurious emission could not be detected due to noise limitations or ambients.
- Each emission reported reflects the highest absolute level at the specific harmonic for the low, mid, and high channels at maximum power.
- The Spectrum was investigated from 30 MHz to the tenth harmonic of the fundamental.
- ERP = S.G Power (dBm) + Substitution Antenna Gain (dBd) - Cable Loss (dB)
 ERP = S.G Power (dBm) + Substitution Antenna Gain (dBi) - Cable Loss (dB)

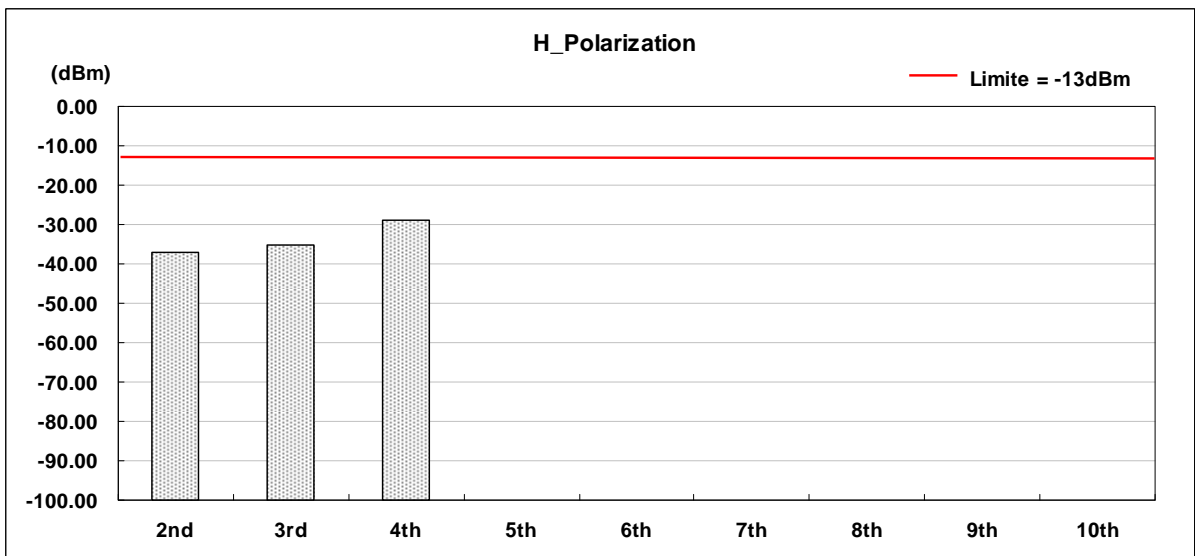
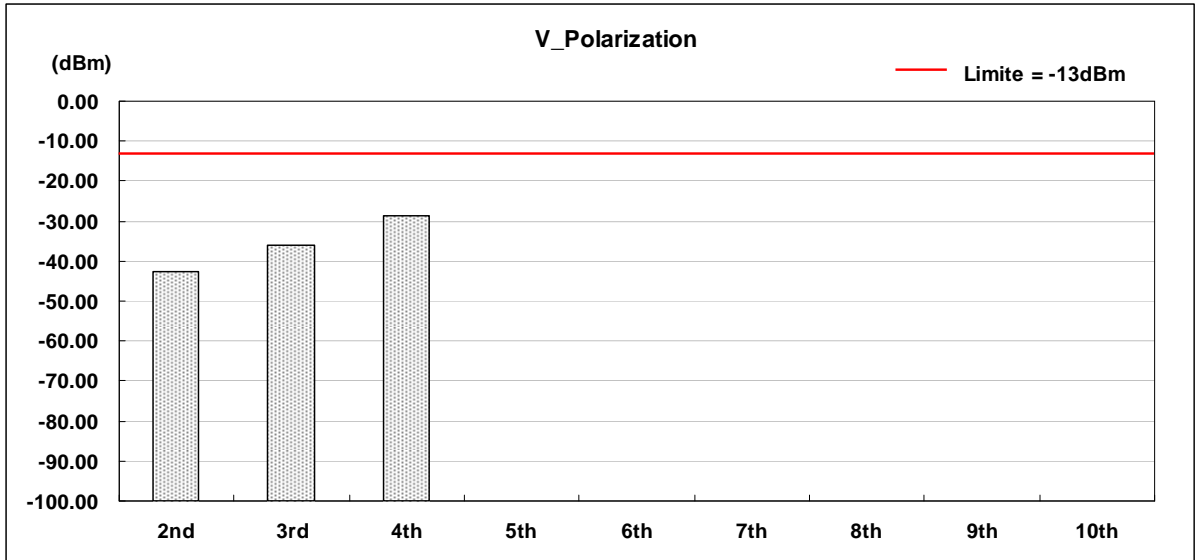



Applicant : XAC Automation Corporation
 Model No : FD-400
 EUT : Portable Terminal
 Test Mode : WCDMA Band II (Middle CH9400)
 Test Date : 10/16/2008

Harmonic	Frequency (MHz)	Polarization	FCC Max. Limit	S.G Power	Substitution Antenna Gain	Cable Loss	Peak Output Power
			(dBm)	(dBm)	(dBi)	(dBm)	(dBm)
2nd	3760.0	V	-13	-41.10	10.79	0.58	-30.89
3rd	5640.0	V	-13	-46.28	10.71	0.63	-36.20
4th	7520.0	V	-13	-39.05	10.81	0.78	-29.02
5th	9400.0	V	-13	*	*	*	*
6th	11280.0	V	-13	*	*	*	*
7th	13160.0	V	-13	*	*	*	*
8th	15040.0	V	-13	*	*	*	*
9th	16920.0	V	-13	*	*	*	*
10th	18800.0	V	-13	*	*	*	*
2nd	3760.0	H	-13	-27.91	10.79	0.58	-17.70
3rd	5640.0	H	-13	-46.10	10.71	0.63	-36.02
4th	7520.0	H	-13	-39.81	10.81	0.78	-29.78
5th	9400.0	H	-13	*	*	*	*
6th	11280.0	H	-13	*	*	*	*
7th	13160.0	H	-13	*	*	*	*
8th	15040.0	H	-13	*	*	*	*
9th	16920.0	H	-13	*	*	*	*
10th	18800.0	H	-13	*	*	*	*

Notes:

5. * Indicates the spurious emission could not be detected due to noise limitations or ambients.
6. Each emission reported reflects the highest absolute level at the specific harmonic for the low, mid, and high channels at maximum power.
7. The Spectrum was investigated from 30 MHz to the tenth harmonic of the fundamental.
8. ERP = S.G Power (dBm) + Substitution Antenna Gain (dBd) - Cable Loss (dB)
 ERP = S.G Power (dBm) + Substitution Antenna Gain (dBi) - Cable Loss (dB)

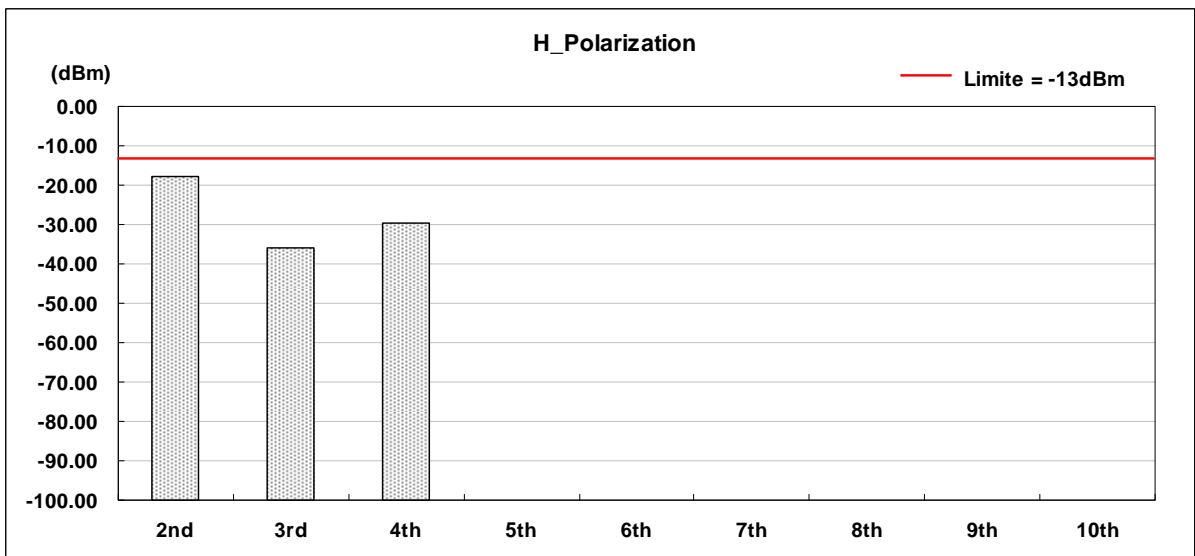
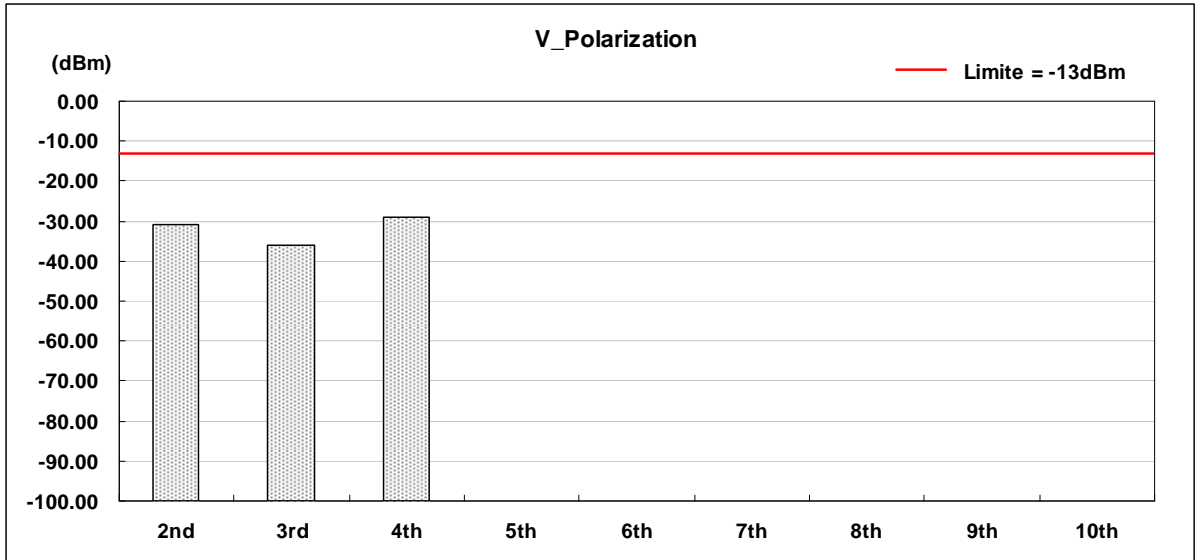



Applicant : XAC Automation Corporation
 Model No : FD-400
 EUT : Portable Terminal
 Test Mode : WCDMA Band II (High CH 9538)
 Test Date : 10/16/2008

Harmonic	Frequency (MHz)	Polarization	FCC Max. Limit	S.G Power	Substitution Antenna Gain	Cable Loss	Peak Output Power
			(dBm)	(dBm)	(dBi)	(dBm)	(dBm)
2nd	3815.2	V	-13	-38.76	10.79	0.58	-28.55
3rd	5722.8	V	-13	-46.31	10.71	0.63	-36.23
4th	7630.4	V	-13	-39.96	10.81	0.78	-29.93
5th	9538.0	V	-13	*	*	*	*
6th	11445.6	V	-13	*	*	*	*
7th	13353.2	V	-13	*	*	*	*
8th	15260.8	V	-13	*	*	*	*
9th	17168.4	V	-13	*	*	*	*
10th	19076.0	V	-13	*	*	*	*
2nd	3815.2	H	-13	-24.27	10.79	0.58	-14.06
3rd	5722.8	H	-13	-46.41	10.71	0.63	-36.33
4th	7630.4	H	-13	-39.71	10.81	0.78	-29.68
5th	9538.0	H	-13	*	*	*	*
6th	11445.6	H	-13	*	*	*	*
7th	13353.2	H	-13	*	*	*	*
8th	15260.8	H	-13	*	*	*	*
9th	17168.4	H	-13	*	*	*	*
10th	19076.0	H	-13	*	*	*	*

Notes:

5. * Indicates the spurious emission could not be detected due to noise limitations or ambients.
6. Each emission reported reflects the highest absolute level at the specific harmonic for the low, mid, and high channels at maximum power.
7. The Spectrum was investigated from 30 MHz to the tenth harmonic of the fundamental.
8. ERP = S.G Power (dBm) + Substitution Antenna Gain (dBd) - Cable Loss (dB)
 ERP = S.G Power (dBm) + Substitution Antenna Gain (dBi) - Cable Loss (dB)

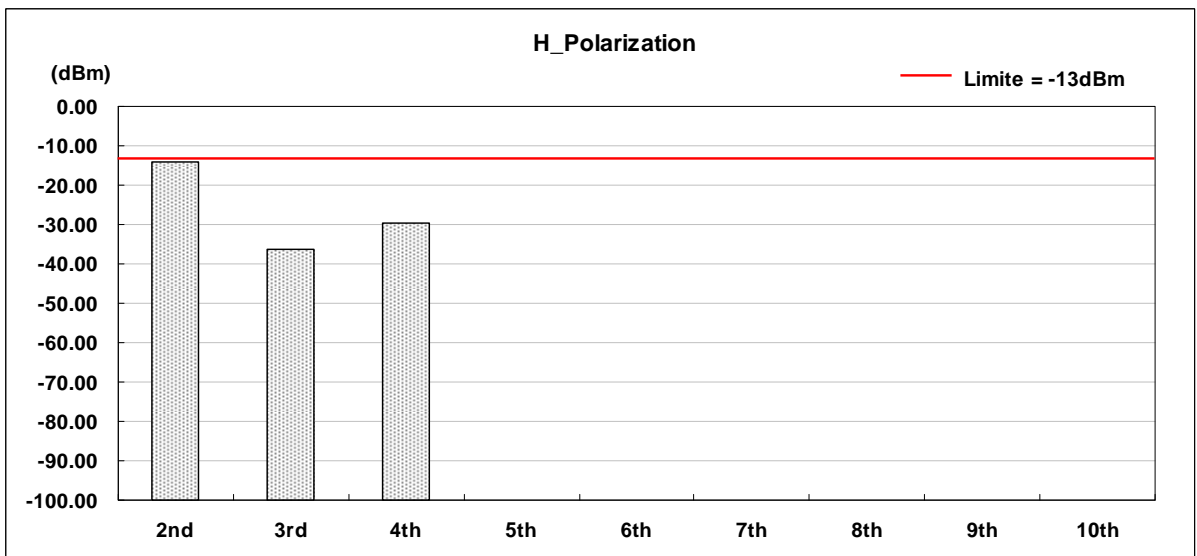
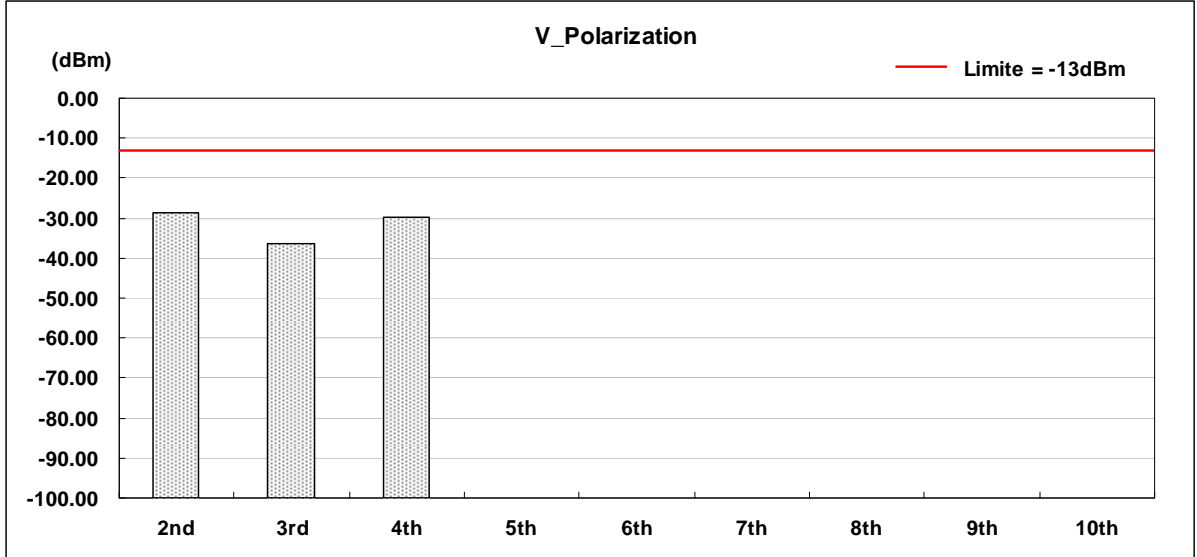

4.7 Frequency Stability (Temperature Variation)

4.7.1 Measurement Instrument

As described in chapter 5 of this test report.

4.7.2 Test Procedure

The measurement is made according to FCC rules part 22 and 24:

1. The EUT and test equipment were set up as shown on the following section.
2. With all power removed, the temperature was decreased to -30°C and permitted to stabilize for three hours. Power was applied and the maximum change in frequency was note within one minute.
3. With power OFF, the temperature was raised in 10°C steps. The sample was permitted to stabilize at each step for at least one-half hour. Power was applied and the maximum frequency change was noted within one minute.
4. The temperature tests were performed for the worst case.
5. Test data was recorded.

4.7.3 Test Setup Layout

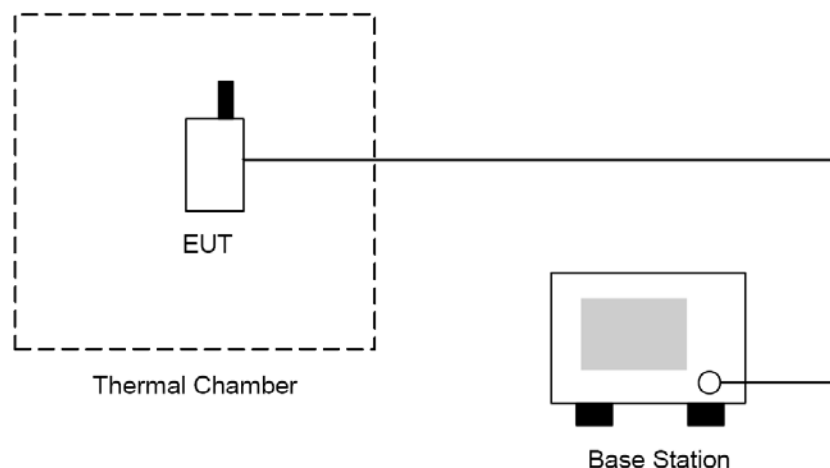



4.7.4 Test Result

Test Mode: GPRS 850 CH190

Temperature (°C)	Deviation (Hz)	Deviation (ppm)	Limit (ppm)
-30	22.49	0.027	0.1
-20	22.81	0.027	0.1
-10	18.64	0.022	0.1
0	25.39	0.030	0.1
10	28.48	0.034	0.1
20	30.47	0.036	0.1
30	29.59	0.035	0.1
40	22.77	0.027	0.1
50	24.24	0.029	0.1

Test Mode: GPRS 1900 CH661

Temperature (°C)	Deviation (Hz)	Deviation (ppm)	Limit (ppm)
-30	35.29	0.019	1
-20	34.88	0.019	1
-10	32.17	0.017	1
0	34.39	0.018	1
10	32.72	0.017	1
20	34.61	0.018	1
30	35.25	0.019	1
40	30.18	0.016	1
50	29.52	0.016	1



Test Mode: WCDMA Band V CH4182

Temperature (°C)	Deviation (Hz)	Deviation (ppm)	Limit (ppm)
-30	24.76	0.030	0.1
-20	22.85	0.027	0.1
-10	29.18	0.035	0.1
0	32.46	0.039	0.1
10	30.57	0.037	0.1
20	34.38	0.041	0.1
30	29.59	0.035	0.1
40	21.66	0.026	0.1
50	18.35	0.022	0.1

Test Mode: WCDMA Band II CH9400

Temperature (°C)	Deviation (Hz)	Deviation (ppm)	Limit (ppm)
-30	36.95	0.020	1
-20	38.24	0.020	1
-10	30.61	0.016	1
0	31.28	0.017	1
10	27.49	0.015	1
20	22.55	0.012	1
30	26.98	0.014	1
40	28.61	0.015	1
50	34.22	0.018	1

4.8 Frequency Stability (Voltage Variation)

4.8.1 Measurement Instrument

As described in chapter 5 of this test report.

4.8.2 Test Procedure

1. The EUT was placed in a temperature chamber at 25 ± 5 °C and connected as the following section.
2. The power supply voltage to the EUT was varied from BEP to 115% of the nominal value measured at the input to the EUT.
3. The variation in frequency was measured for the worst case.

4.8.3 Test Setup Layout

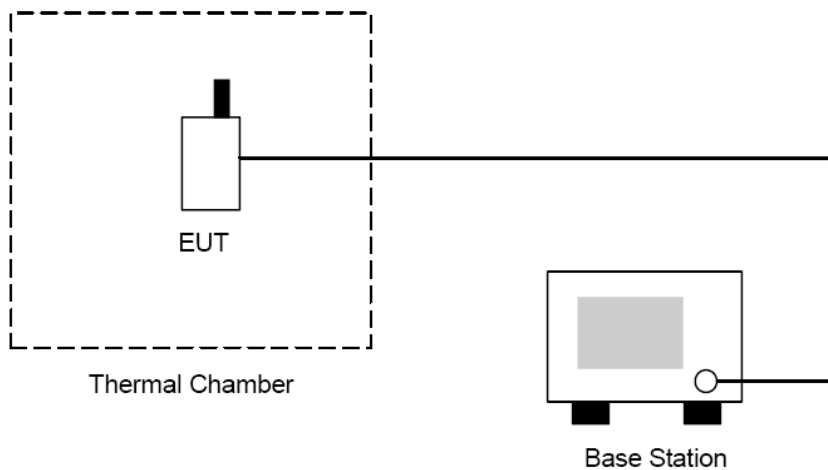



4.8.4 Test Result

Test Mode: GPRS 850 CH190

Level	Voltage [V]	Deviation [Hz]	Deviation [ppm]	Limit [ppm]
Battery full point	4.25	28.76	0.034	0.1
Normal	3.70	32.57	0.039	0.1
Battery cut-off point	3.20	34.64	0.041	0.1

Test Mode: GPRS 1900 CH661

Level	Voltage [V]	Deviation [Hz]	Deviation [ppm]	Limit [ppm]
Battery full point	4.25	36.77	0.020	1
Normal	3.70	32.18	0.017	1
Battery cut-off point	3.20	36.55	0.019	1

Test Mode: WCDMA Band V CH4182

Level	Voltage [V]	Deviation [Hz]	Deviation [ppm]	Limit [ppm]
Battery full point	4.25	24.19	0.029	0.1
Normal	3.70	32.86	0.039	0.1
Battery cut-off point	3.20	34.61	0.041	0.1

Test Mode: WCDMA Band II CH9400

Level	Voltage [V]	Deviation [Hz]	Deviation [ppm]	Limit [ppm]
Battery full point	4.25	40.18	0.021	1
Normal	3.70	39.66	0.021	1
Battery cut-off point	3.20	35.27	0.019	1



4.9 AC Power Conducted Emissions Requirements

4.9.1 Measurement Instrument

As described in chapter 5 of this test report.

4.9.2 Test Procedure

The measurement is made according to FCC rules 15.207:

The power line conducted emission measurements were performed in a shielded enclosure. The EUT was assembled on a wooden table which is 80 centimeters high, was placed 40 centimeters from the back wall and at least 1 meter from the sidewall.

Power was fed to the EUT from the public utility power grid through a line filter and EMCO Model 3162/2 SH Line Impedance Stabilization Networks (LISN). The LISN housing, measuring instrumentation case, ground plane, etc., were electrically bonded together at the same RF potential. The Spectrum analyzer was connected to the AC line through an isolation transformer. The 50-ohm output of the LISN was connected to the spectrum analyzer directly. Conducted emission levels were in the CISPR quasi-peak detection mode. The analyzer's 6 dB bandwidth was set to 9 KHz. No post-detector video filter was used.

The spectrum was scanned from 150 KHz to 30 MHz. The physical arrangement of the test system and associated cabling was varied (within the scope of arrangements likely to be encountered in actual use) to determine the effect on the unit's emanations in amplitude and frequency. All spurious emission frequencies were observed. The highest emission amplitudes relative to the appropriate limit were measured and have been recorded in paragraph 2.6.

4.9.3 Test Configuration:



Figure 1. Front View of the Test Configuration



Figure 2. Rear View of the Test Configuration



4.9.4 Test condition:

EUT tested in accordance with the specifications given by the Manufacturer, and exercised in the most unfavorable manner.

4.9.5 Conducted Emissions Limits:

Frequency range (MHz)	Limits (dBuV)	
	Quasi-peak	Average
0.15 to 0.50	66 to 56	56 to 46
0.50 to 5.0	56	46
5.0 to 30	60	50



4.9.6 Test Result

4.9.6.1 Stand by Test Result

Applicant : XAC Automation Corporation

Model No : FD-400

EUT : Portable Terminal

Test Mode : Stand by

Test Date : 10/17/2008

Please refer to next pager of detail testing data.



File :FD400(idel)

Data :#1

Date: 2008/10/17

Time: 下午 07:54:55

80.0 dBuV

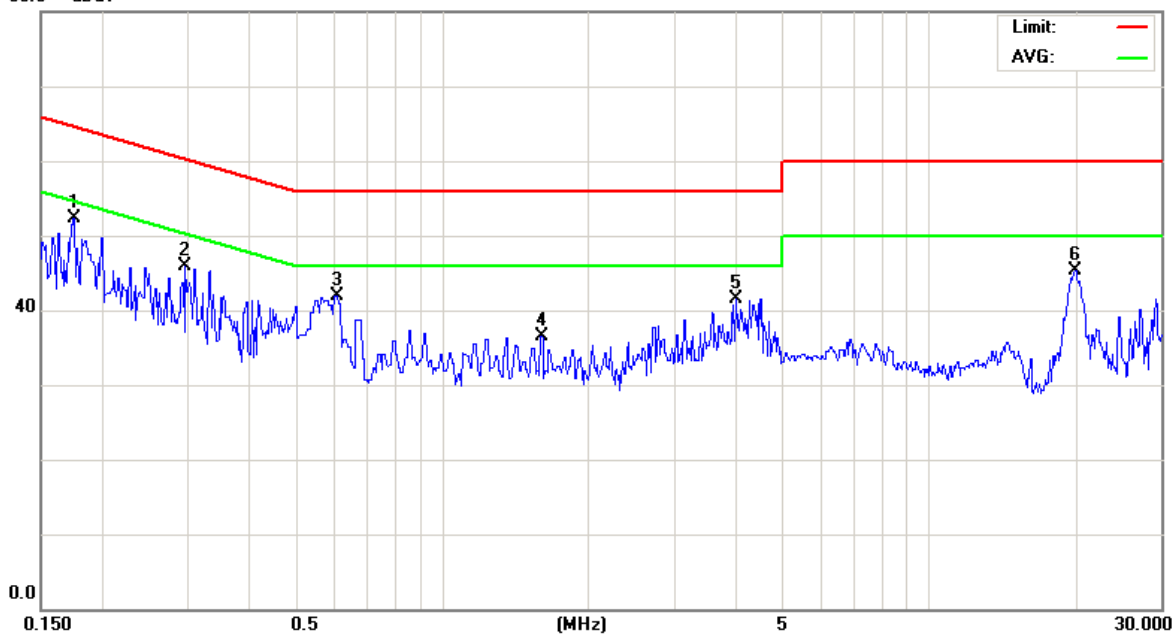

Site Phase: **L1** Temperature: 26 °C
 Limit: CISPR22 Class B Conduction(QP) Power: AC 110V/60Hz Humidity: 55 %
 EUT:
 M/N: 08-0252-E
 Mode: idel
 Note:

No.	Mk.	Freq. MHz	Reading Level dBuV	Correct Factor dB	Measure- ment dBuV	Limit dBuV	Over dB	Detector	Comment
1	*	0.1751	42.63	9.74	52.37	64.71	-12.34	peak	
2		0.2968	36.15	9.76	45.91	60.33	-14.42	peak	
3		0.6078	32.05	9.79	41.84	56.00	-14.16	peak	
4		1.5979	26.75	9.82	36.57	56.00	-19.43	peak	
5		4.0189	31.62	9.97	41.59	56.00	-14.41	peak	
6		19.9500	35.08	10.23	45.31	60.00	-14.69	peak	

*:Maximum data x:Over limit !:over margin

●Reference Only



File :FD400(idel)

Data :#2

Date: 2008/10/17

Time: 下午 07:58:31

80.0 dBuV

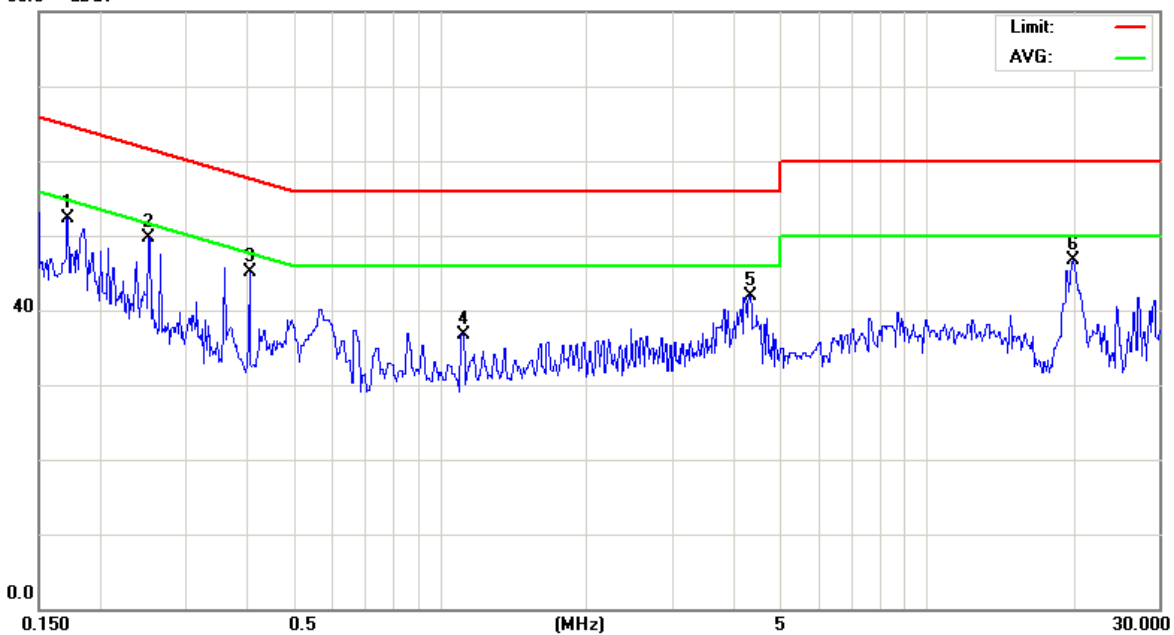

Site Phase: **L2** Temperature: 26 °C
 Limit: CISPR22 Class B Conduction(QP) Power: AC 110V/60Hz Humidity: 55 %
 EUT:
 M/N: 08-0252-E
 Mode: idel
 Note:

No.	Mk.	Freq. MHz	Reading Level dBuV	Correct Factor dB	Measure- ment dBuV	Limit dBuV	Over dB	Detector	Comment
1		0.1716	42.66	9.73	52.39	64.88	-12.49	peak	
2	*	0.2519	39.99	9.75	49.74	61.69	-11.95	peak	
3		0.4047	35.38	9.78	45.16	57.76	-12.60	peak	
4		1.1119	26.87	9.80	36.67	56.00	-19.33	peak	
5		4.3158	31.93	10.01	41.94	56.00	-14.06	peak	
6		19.9000	36.42	10.24	46.66	60.00	-13.34	peak	

*:Maximum data x:Over limit !:over margin

●Reference Only



4.9.6.2 GPRS 850 Test Result

Applicant : XAC Automation Corporation
Model No : FD-400
EUT : Portable Terminal
Test Mode : Link Mode _ GPRS 850 (Low CH128 / Middle CH190 / High CH 251)
Test Date : 10/16/2008

Please refer to next pager of detail testing data.



File :FD400(GSM850)(GPRS)

Data :#1

Date: 2008/10/16

Time: 上午 02:31:23

80.0 dBuV

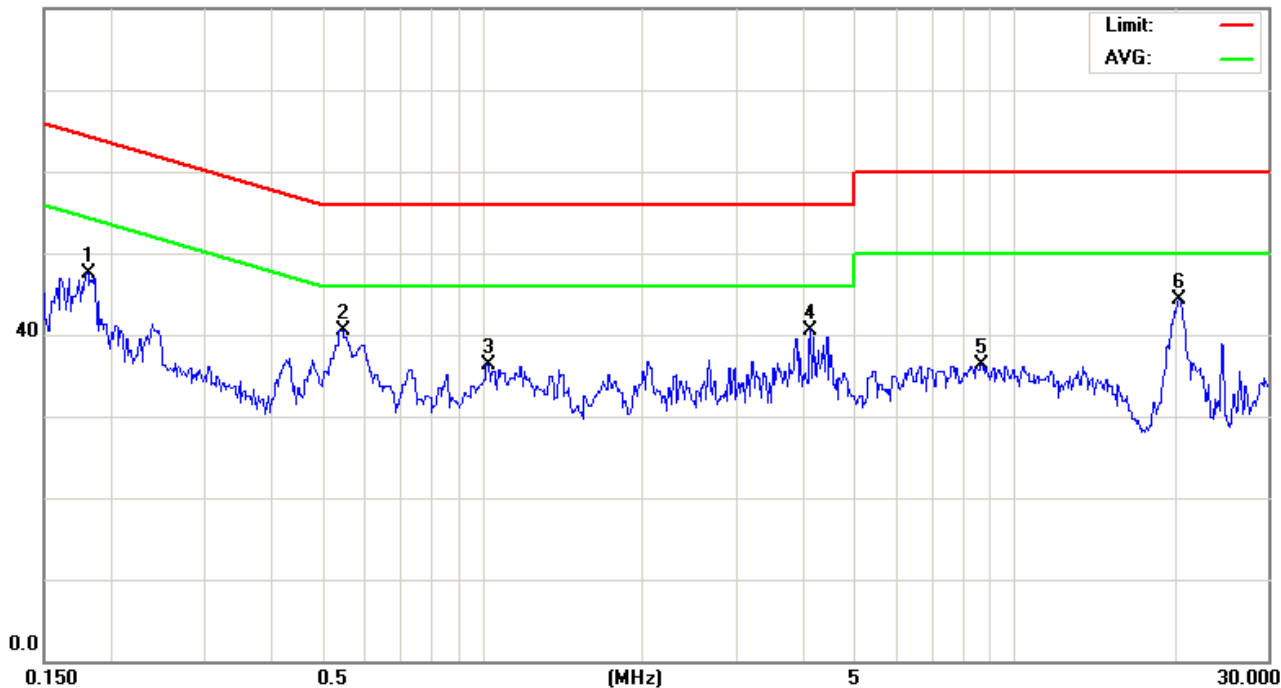

Site site#1

Phase: **L1**

Temperature: 26 °C

Limit: CISPR22 Class B Conduction(QP)

Power: AC 110V/60Hz

Humidity: 55 %

EUT:

M/N: 08-0252-E

Mode: GSM850(GPRS)

Note: CH128

No.	Mk.	Freq. MHz	Reading Level dBuV	Correct Factor dB	Measure- ment dBuV	Limit dBuV	Over dB	Detector	Comment
1		0.1808	37.79	9.74	47.53	64.44	-16.91	peak	
2		0.5450	30.80	9.79	40.59	56.00	-15.41	peak	
3		1.0220	26.52	9.80	36.32	56.00	-19.68	peak	
4	*	4.1270	30.63	9.97	40.60	56.00	-15.40	peak	
5		8.6500	26.12	10.09	36.21	60.00	-23.79	peak	
6		20.3000	33.89	10.33	44.22	60.00	-15.78	peak	

*:Maximum data x:Over limit !:over margin

●Reference Only



File :FD400(GSM850)(GPRS)

Data :#2

Date: 2008/10/16

Time: 上午 02:33:03

80.0 dBuV

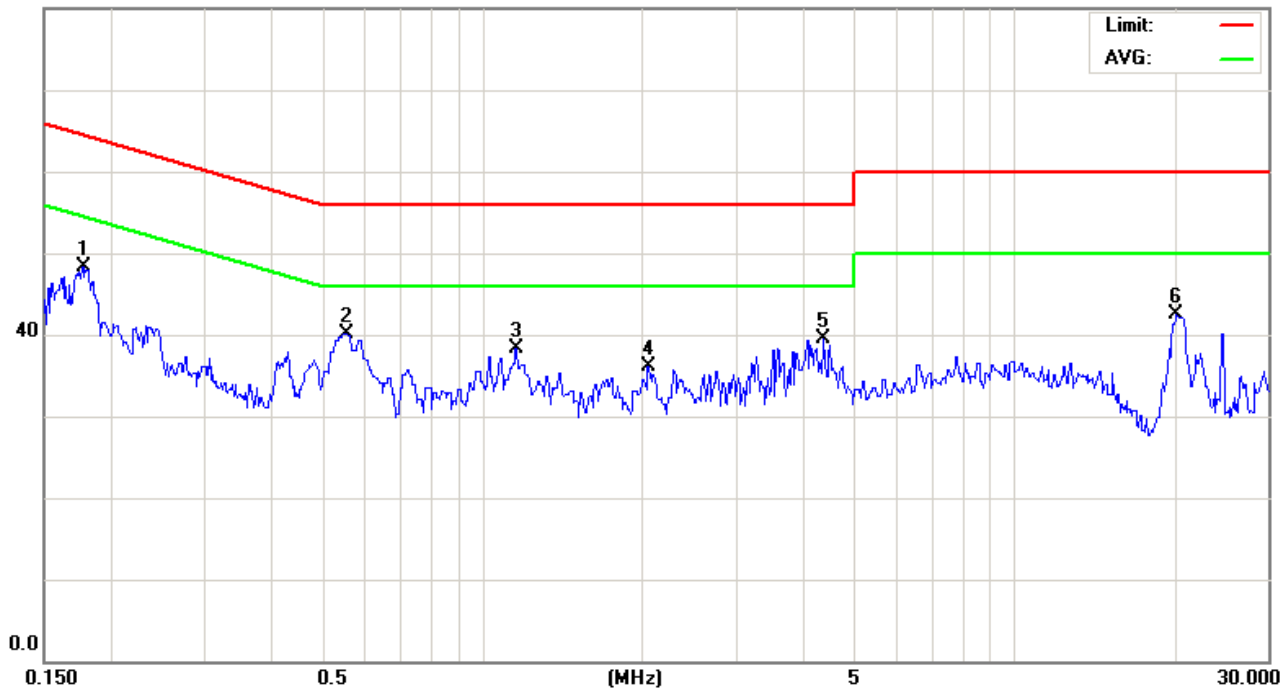

Site site#1

Phase: **L2**

Temperature: 26 °C

Limit: CISPR22 Class B Conduction(QP)

Power: AC 110V/60Hz

Humidity: 55 %

EUT:

M/N: 08-0252-E

Mode: GSM850(GPRS)

Note: CH128

No.	Mk.	Freq. MHz	Reading Level dBuV	Correct Factor dB	Measure- ment dBuV	Limit dBuV	Over dB	Detector	Comment
1		0.1773	38.54	9.74	48.28	64.61	-16.33	peak	
2	*	0.5540	30.37	9.79	40.16	56.00	-15.84	peak	
3		1.1570	28.55	9.80	38.35	56.00	-17.65	peak	
4		2.0480	26.23	9.86	36.09	56.00	-19.91	peak	
5		4.3700	29.45	10.01	39.46	56.00	-16.54	peak	
6		20.1500	32.30	10.27	42.57	60.00	-17.43	peak	

*:Maximum data x:Over limit !:over margin

●Reference Only



File :FD400(GSM850)(GPRS)

Data :#3

Date: 2008/10/16

Time: 上午 02:35:08

80.0 dBuV

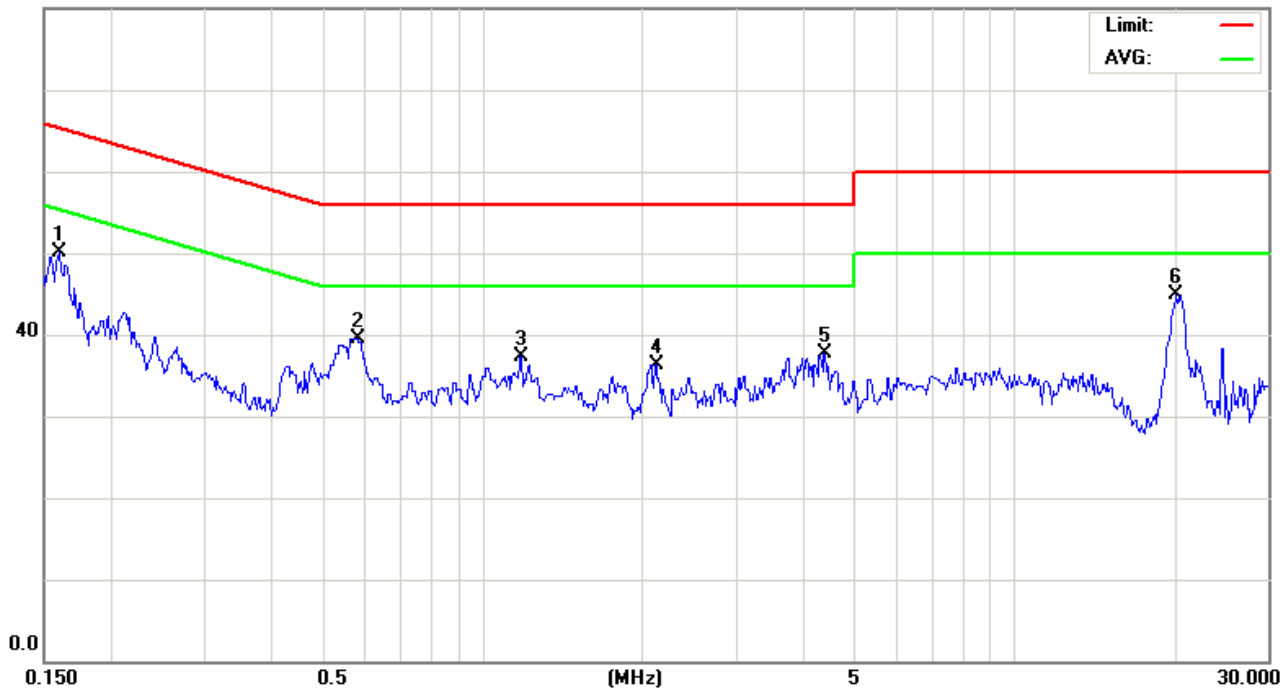

Site site#1

Phase: **L1**

Temperature: 26 °C

Limit: CISPR22 Class B Conduction(QP)

Power: AC 110V/60Hz

Humidity: 55 %

EUT:

M/N: 08-0252-E

Mode: GSM850(GPRS)

Note: CH190

No.	Mk.	Freq. MHz	Reading Level dBuV	Correct Factor dB	Measure- ment dBuV	Limit dBuV	Over dB	Detector	Comment
1		0.1598	40.41	9.73	50.14	65.47	-15.33	peak	
2		0.5810	29.80	9.79	39.59	56.00	-16.41	peak	
3		1.1840	27.58	9.80	37.38	56.00	-18.62	peak	
4		2.1110	26.47	9.87	36.34	56.00	-19.66	peak	
5		4.3880	27.73	10.01	37.74	56.00	-18.26	peak	
6	*	20.1500	34.61	10.27	44.88	60.00	-15.12	peak	

*:Maximum data x:Over limit !:over margin

●Reference Only



File :FD400(GSM850)(GPRS)

Data :#4

Date: 2008/10/16

Time: 上午 02:37:02

80.0 dBuV

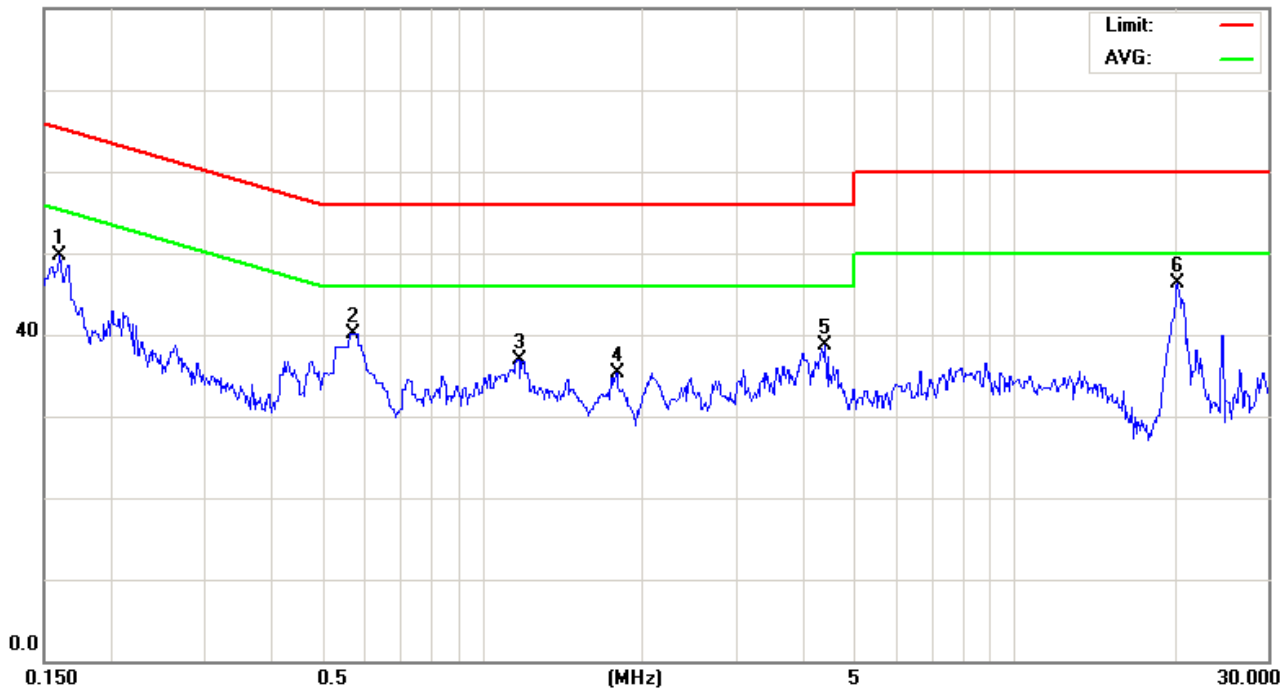

Site site#1

Phase: **L2**

Temperature: 26 °C

Limit: CISPR22 Class B Conduction(QP)

Power: AC 110V/60Hz

Humidity: 55 %

EUT:

M/N: 08-0252-E

Mode: GSM850(GPRS)

Note: CH190

No.	Mk.	Freq. MHz	Reading Level dBuV	Correct Factor dB	Measure- ment dBuV	Limit dBuV	Over dB	Detector	Comment
1		0.1598	39.91	9.73	49.64	65.47	-15.83	peak	
2		0.5720	30.31	9.79	40.10	56.00	-15.90	peak	
3		1.1660	27.18	9.80	36.98	56.00	-19.02	peak	
4		1.7870	25.58	9.82	35.40	56.00	-20.60	peak	
5		4.3970	28.64	10.01	38.65	56.00	-17.35	peak	
6	*	20.2000	35.93	10.29	46.22	60.00	-13.78	peak	

*:Maximum data x:Over limit !:over margin

●Reference Only



File :FD400(GSM850)(GPRS)

Data :#5

Date: 2008/10/16

Time: 上午 02:39:15

80.0 dBuV

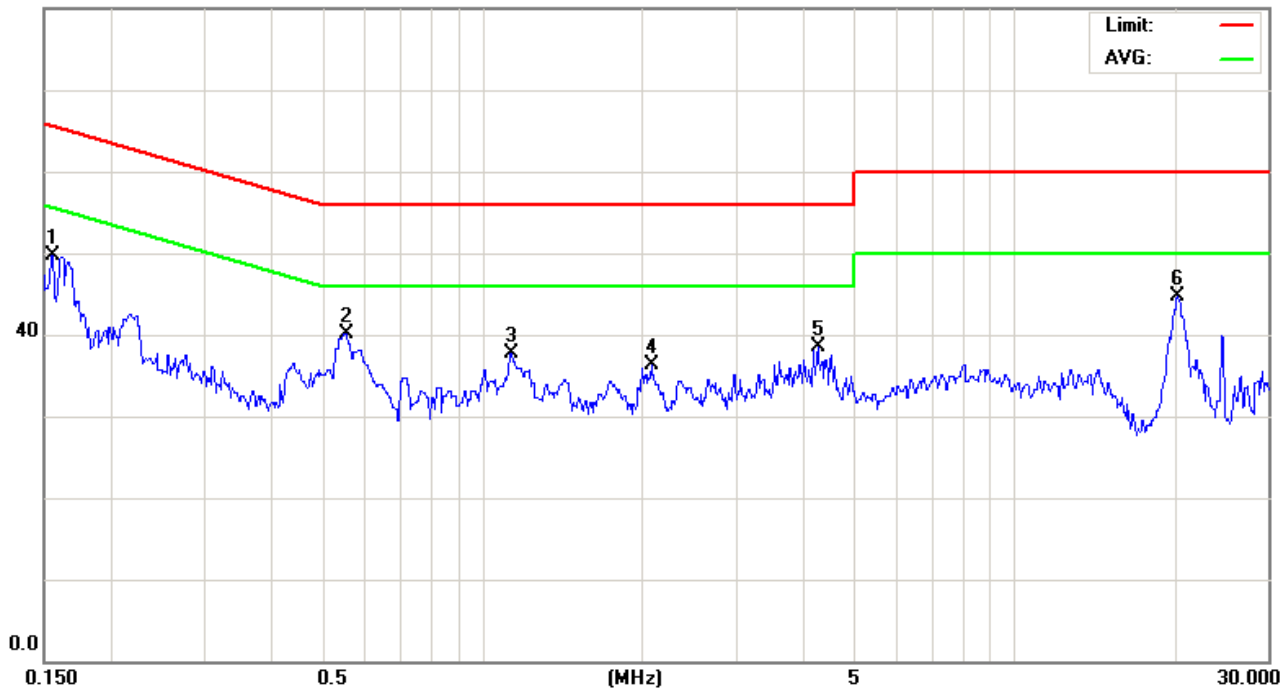

Site site#1

Phase: **L1**

Temperature: 26 °C

Limit: CISPR22 Class B Conduction(QP)

Power: AC 110V/60Hz

Humidity: 55 %

EUT:

M/N: 08-0252-E

Mode: GSM850(GPRS)

Note: CH251

No.	Mk.	Freq. MHz	Reading Level dBuV	Correct Factor dB	Measure- ment dBuV	Limit dBuV	Over dB	Detector	Comment
1		0.1549	39.90	9.73	49.63	65.73	-16.10	peak	
2		0.5540	30.25	9.79	40.04	56.00	-15.96	peak	
3		1.1300	27.98	9.80	37.78	56.00	-18.22	peak	
4		2.0750	26.46	9.86	36.32	56.00	-19.68	peak	
5		4.2619	28.47	10.00	38.47	56.00	-17.53	peak	
6	*	20.2500	34.40	10.31	44.71	60.00	-15.29	peak	

*:Maximum data x:Over limit !:over margin

●Reference Only



File :FD400(GSM850)(GPRS)

Data :#6

Date: 2008/10/16

Time: 上午 02:41:28

80.0 dBuV

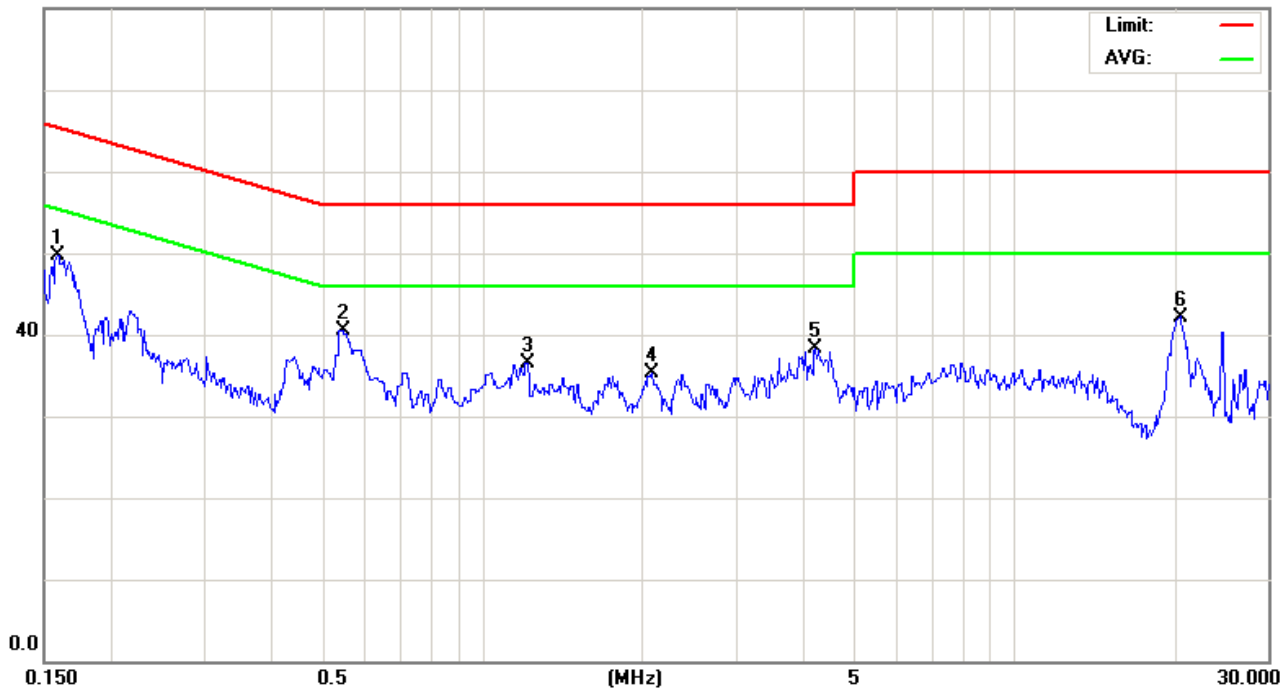

Site site#1

Phase: **L2**

Temperature: 26 °C

Limit: CISPR22 Class B Conduction(QP)

Power: AC 110V/60Hz

Humidity: 55 %

EUT:

M/N: 08-0252-E

Mode: GSM850(GPRS)

Note: CH251

No.	Mk.	Freq. MHz	Reading Level dBuV	Correct Factor dB	Measure- ment dBuV	Limit dBuV	Over dB	Detector	Comment
1		0.1590	39.88	9.73	49.61	65.51	-15.90	peak	
2	*	0.5450	30.62	9.79	40.41	56.00	-15.59	peak	
3		1.2109	26.78	9.81	36.59	56.00	-19.41	peak	
4		2.0840	25.47	9.87	35.34	56.00	-20.66	peak	
5		4.2170	28.23	9.99	38.22	56.00	-17.78	peak	
6		20.4000	31.82	10.38	42.20	60.00	-17.80	peak	

*:Maximum data x:Over limit !:over margin

●Reference Only



4.9.6.3 GPRS 1900 Test Result

Applicant : XAC Automation Corporation

Model No : FD-400

EUT : Portable Terminal

Test Mode : Link Mode _ GPRS 1900 (Low CH512 / Middle CH661 / High CH 810)

Test Date : 10/16/2008

Please refer to next pager of detail testing data.



File :FD400(PCS1900)(GPRS)

Data :#1

Date: 2008/10/16

Time: 上午 02:15:33

80.0 dBuV

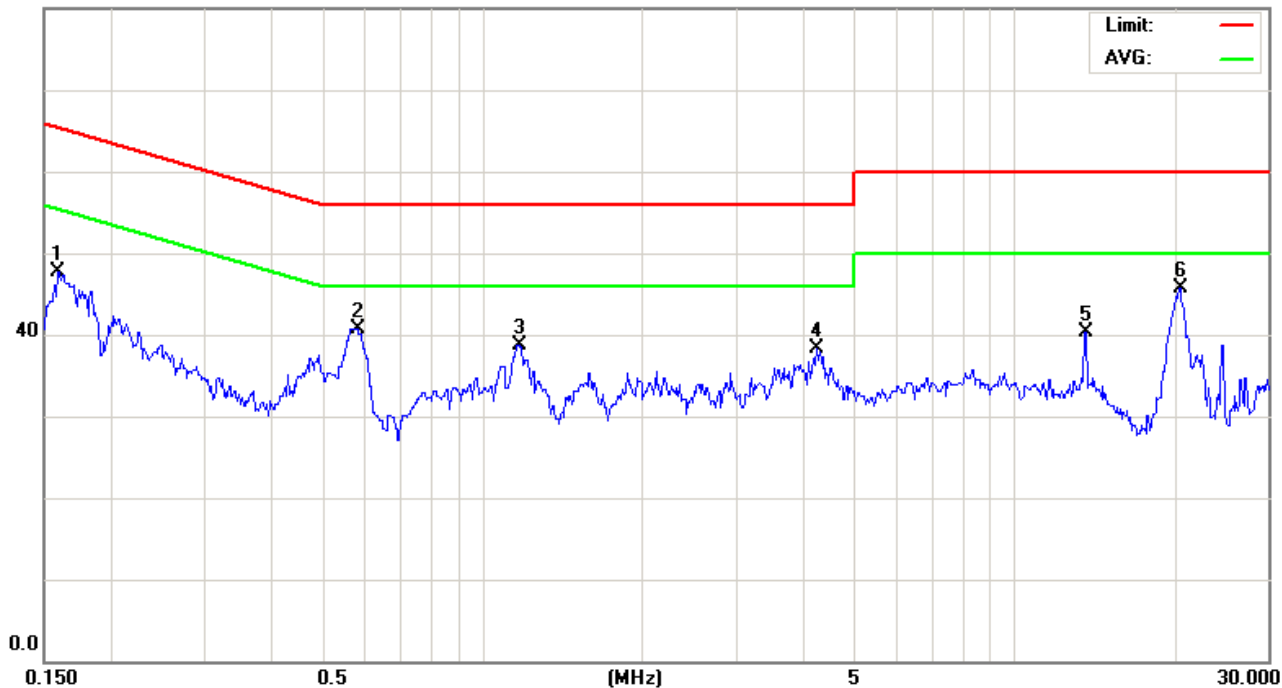

Site site#1

Phase: **L1**

Temperature: 26 °C

Limit: CISPR22 Class B Conduction(QP)

Power: AC 110V/60Hz

Humidity: 55 %

EUT:

M/N: 08-0252-E

Mode: PCS1900(GPRS)

Note: CH512

No.	Mk.	Freq. MHz	Reading Level dBuV	Correct Factor dB	Measure- ment dBuV	Limit dBuV	Over dB	Detector	Comment
1		0.1590	37.99	9.73	47.72	65.51	-17.79	peak	
2		0.5810	31.01	9.79	40.80	56.00	-15.20	peak	
3		1.1660	28.88	9.80	38.68	56.00	-17.32	peak	
4		4.2440	28.27	10.00	38.27	56.00	-17.73	peak	
5		13.6000	30.08	10.21	40.29	60.00	-19.71	peak	
6	*	20.4000	35.34	10.38	45.72	60.00	-14.28	peak	

*:Maximum data x:Over limit !:over margin

●Reference Only



File :FD400(PCS1900)(GPRS)

Data :#2

Date: 2008/10/16

Time: 上午 02:17:28

80.0 dBuV

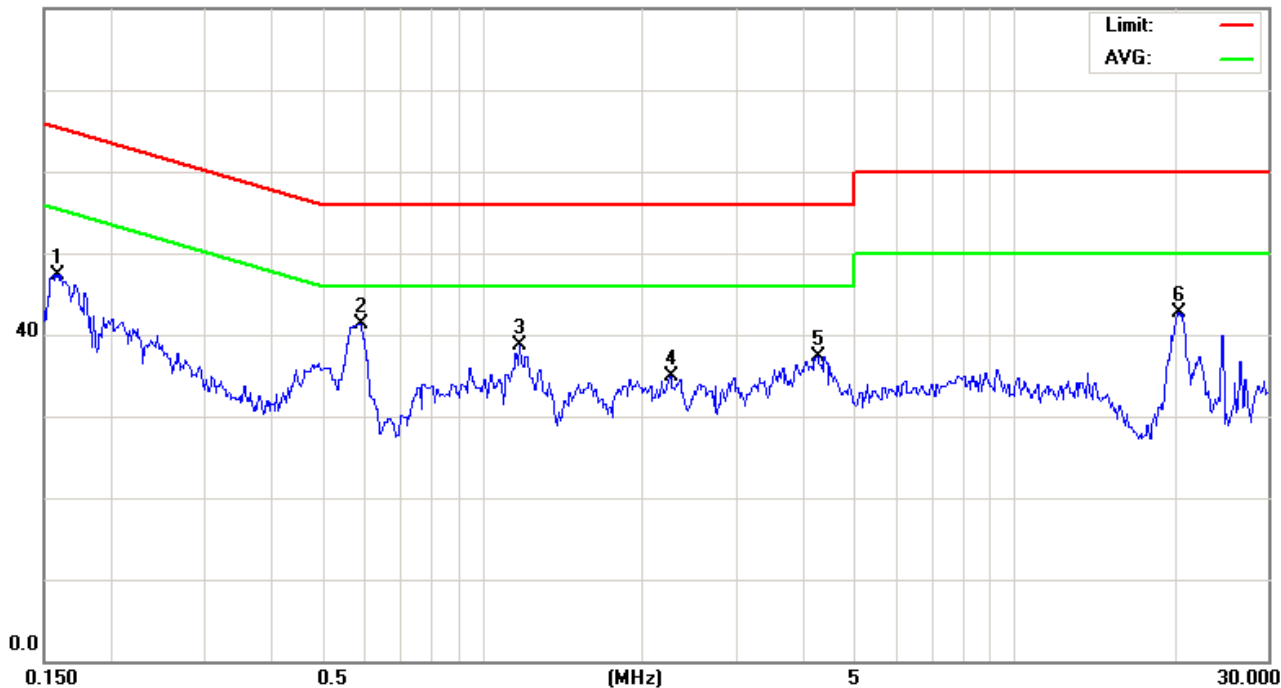

Site site#1

Phase: **L2**

Temperature: 26 °C

Limit: CISPR22 Class B Conduction(QP)

Power: AC 110V/60Hz

Humidity: 55 %

EUT:

M/N: 08-0252-E

Mode: PCS1900(GPRS)

Note: CH512

No.	Mk.	Freq. MHz	Reading Level dBuV	Correct Factor dB	Measure- ment dBuV	Limit dBuV	Over dB	Detector	Comment
1		0.1584	37.52	9.73	47.25	65.54	-18.29	peak	
2	*	0.5899	31.46	9.79	41.25	56.00	-14.75	peak	
3		1.1750	28.86	9.80	38.66	56.00	-17.34	peak	
4		2.2550	24.95	9.88	34.83	56.00	-21.17	peak	
5		4.2530	27.26	10.00	37.26	56.00	-18.74	peak	
6		20.3000	32.45	10.33	42.78	60.00	-17.22	peak	

*:Maximum data x:Over limit !:over margin

●Reference Only



File :FD400(PCS1900)(GPRS)

Data :#3

Date: 2008/10/16

Time: 上午 02:19:37

80.0 dBuV

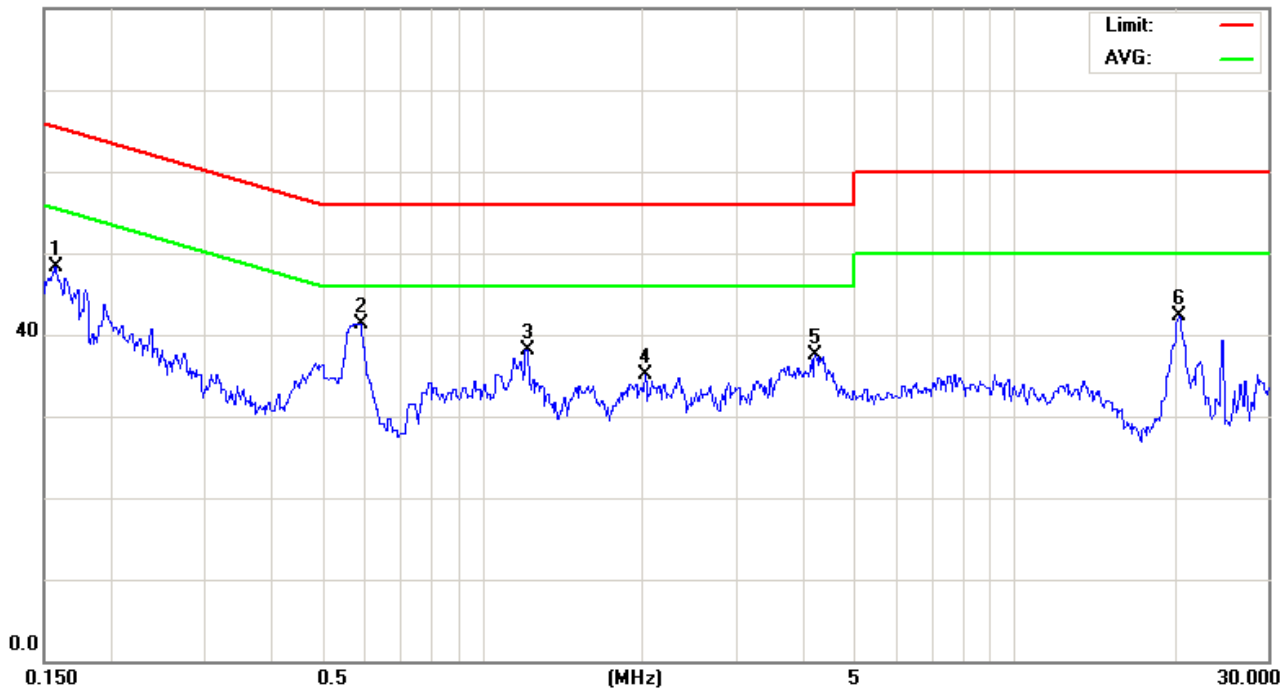

Site site#1

Phase: **L1**

Temperature: 26 °C

Limit: CISPR22 Class B Conduction(QP)

Power: AC 110V/60Hz

Humidity: 55 %

EUT:

M/N: 08-0252-E

Mode: PCS1900(GPRS)

Note: CH661

No.	Mk.	Freq. MHz	Reading Level dBuV	Correct Factor dB	Measure- ment dBuV	Limit dBuV	Over dB	Detector	Comment
1		0.1577	38.56	9.73	48.29	65.58	-17.29	peak	
2	*	0.5899	31.61	9.79	41.40	56.00	-14.60	peak	
3		1.2109	28.21	9.81	38.02	56.00	-17.98	peak	
4		2.0210	25.23	9.85	35.08	56.00	-20.92	peak	
5		4.2170	27.60	9.99	37.59	56.00	-18.41	peak	
6		20.3500	31.94	10.36	42.30	60.00	-17.70	peak	

*:Maximum data x:Over limit !:over margin

●Reference Only



File :FD400(PCS1900)(GPRS)

Data :#4

Date: 2008/10/16

Time: 上午 02:21:41

80.0 dBuV

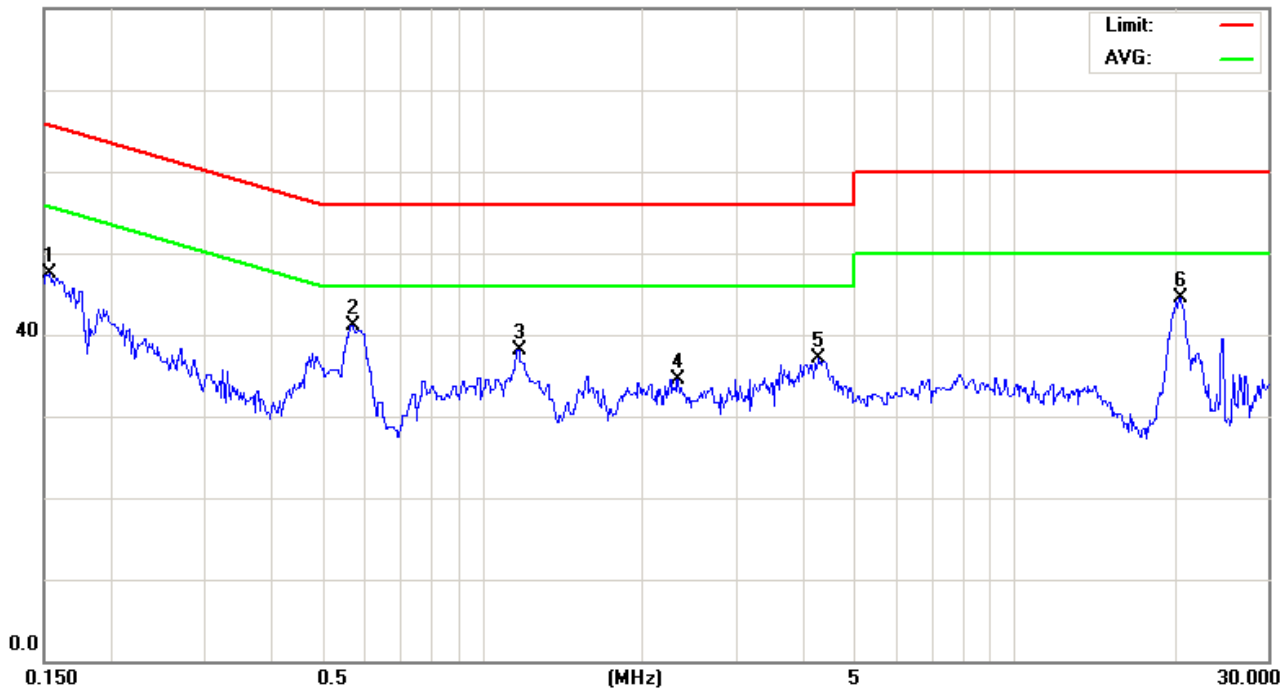

Site site#1

Phase: **L2**

Temperature: 26 °C

Limit: CISPR22 Class B Conduction(QP)

Power: AC 110V/60Hz

Humidity: 55 %

EUT:

M/N: 08-0252-E

Mode: PCS1900(GPRS)

Note: CH661

No.	Mk.	Freq. MHz	Reading Level dBuV	Correct Factor dB	Measure- ment dBuV	Limit dBuV	Over dB	Detector	Comment
1		0.1535	37.77	9.73	47.50	65.80	-18.30	peak	
2	*	0.5720	31.32	9.79	41.11	56.00	-14.89	peak	
3		1.1660	28.27	9.80	38.07	56.00	-17.93	peak	
4		2.3270	24.69	9.85	34.54	56.00	-21.46	peak	
5		4.2890	27.15	10.00	37.15	56.00	-18.85	peak	
6		20.4500	34.09	10.40	44.49	60.00	-15.51	peak	

*:Maximum data x:Over limit !:over margin

●Reference Only



File :FD400(PCS1900)(GPRS)

Data :#5

Date: 2008/10/16

Time: 上午 02:23:45

80.0 dBuV

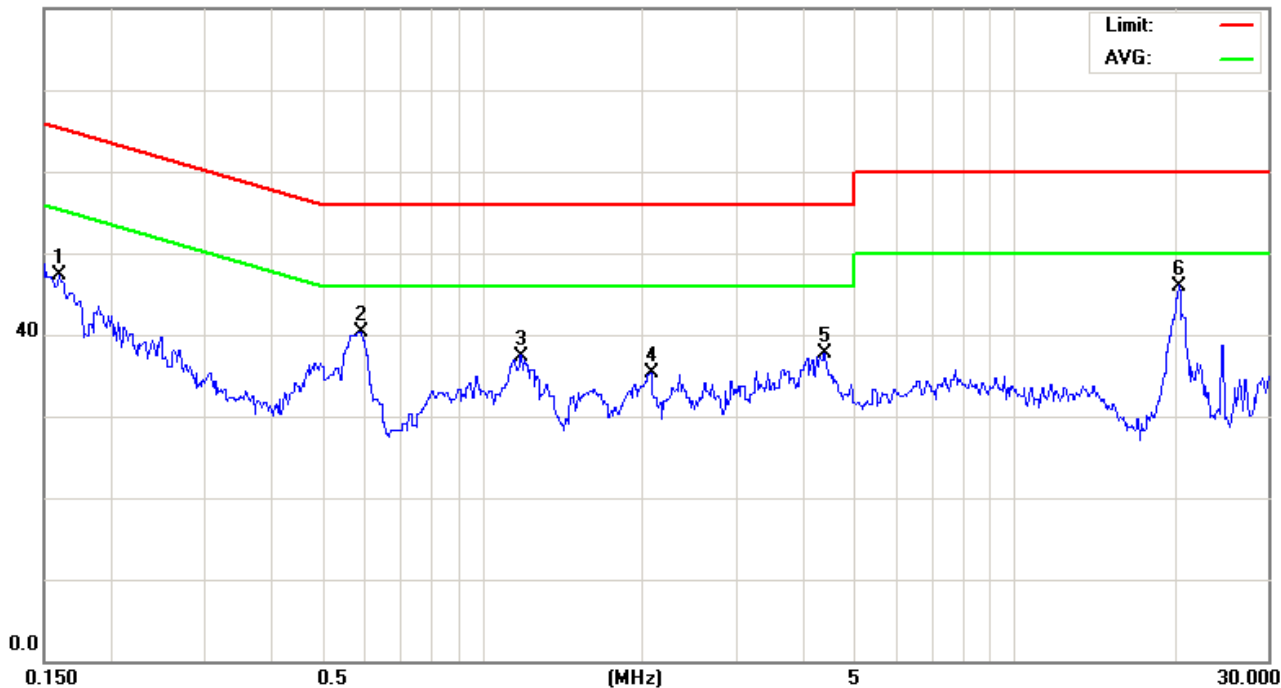

Site site#1

Phase: **L1**

Temperature: 26 °C

Limit: CISPR22 Class B Conduction(QP)

Power: AC 110V/60Hz

Humidity: 55 %

EUT:

M/N: 08-0252-E

Mode: PCS1900(GPRS)

Note: CH810

No.	Mk.	Freq. MHz	Reading Level dBuV	Correct Factor dB	Measure- ment dBuV	Limit dBuV	Over dB	Detector	Comment
1		0.1598	37.55	9.73	47.28	65.47	-18.19	peak	
2		0.5899	30.49	9.79	40.28	56.00	-15.72	peak	
3		1.1840	27.60	9.80	37.40	56.00	-18.60	peak	
4		2.0660	25.38	9.86	35.24	56.00	-20.76	peak	
5		4.3880	27.62	10.01	37.63	56.00	-18.37	peak	
6	*	20.3500	35.64	10.36	46.00	60.00	-14.00	peak	

*:Maximum data x:Over limit !:over margin

●Reference Only



File :FD400(PCS1900)(GPRS)

Data :#6

Date: 2008/10/16

Time: 上午 02:25:28

80.0 dBuV

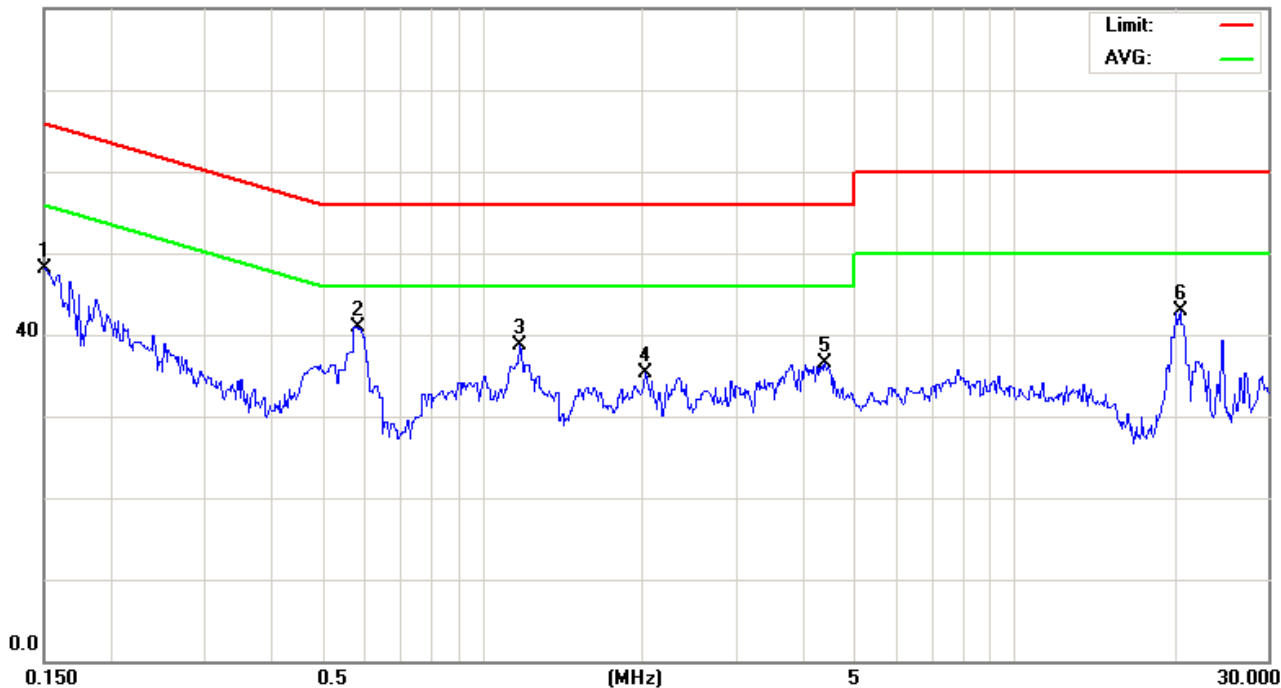

Site site#1

Phase: **L2**

Temperature: 26 °C

Limit: CISPR22 Class B Conduction(QP)

Power: AC 110V/60Hz

Humidity: 55 %

EUT:

M/N: 08-0252-E

Mode: PCS1900(GPRS)

Note: CH810

No.	Mk.	Freq. MHz	Reading Level dBuV	Correct Factor dB	Measure- ment dBuV	Limit dBuV	Over dB	Detector	Comment
1		0.1500	38.45	9.73	48.18	65.99	-17.81	peak	
2	*	0.5810	31.18	9.79	40.97	56.00	-15.03	peak	
3		1.1750	28.87	9.80	38.67	56.00	-17.33	peak	
4		2.0210	25.53	9.85	35.38	56.00	-20.62	peak	
5		4.4060	26.49	10.02	36.51	56.00	-19.49	peak	
6		20.4500	32.41	10.40	42.81	60.00	-17.19	peak	

*:Maximum data x:Over limit !:over margin

●Reference Only



4.9.6.4 WCDMA Band V Test Result

Applicant : XAC Automation Corporation
Model No : FD-400
EUT : Portable Terminal
Test Mode : Link Mode _ WCDMA Band V (Low CH4132 / Middle CH4182 / High CH 4233)
Test Date : 10/15/2008

Please refer to next pager of detail testing data.



File :FD400(WCDMA)(BAND V)

Data :#1

Date: 2008/10/15

Time: 下午 09:14:37

80.0 dBuV

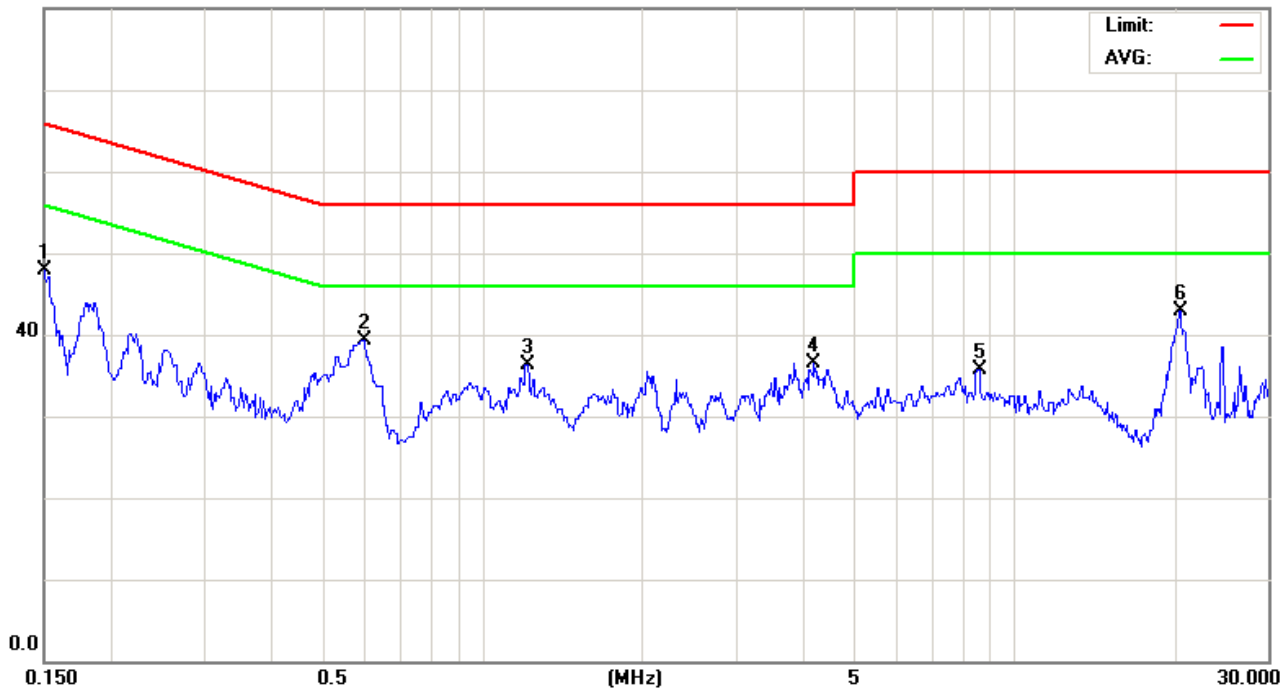

Site site#1

Phase: **L1**

Temperature: 26 °C

Limit: CISPR22 Class B Conduction(QP)

Power: AC 110V/60Hz

Humidity: 55 %

EUT:

M/N: 08-0252-E

Mode: WCDMA(BAND V)

Note: CH4132

No.	Mk.	Freq. MHz	Reading Level dBuV	Correct Factor dB	Measure- ment dBuV	Limit dBuV	Over dB	Detector	Comment
1		0.1500	38.22	9.73	47.95	65.99	-18.04	peak	
2	*	0.5990	29.56	9.79	39.35	56.00	-16.65	peak	
3		1.2109	26.55	9.81	36.36	56.00	-19.64	peak	
4		4.1900	26.47	9.98	36.45	56.00	-19.55	peak	
5		8.5500	25.65	10.09	35.74	60.00	-24.26	peak	
6		20.4000	32.57	10.38	42.95	60.00	-17.05	peak	

*:Maximum data x:Over limit !:over margin

●Reference Only



File :FD400(WCDMA)(BAND V)

Data :#2

Date: 2008/10/15

Time: 下午 09:16:52

80.0 dBuV

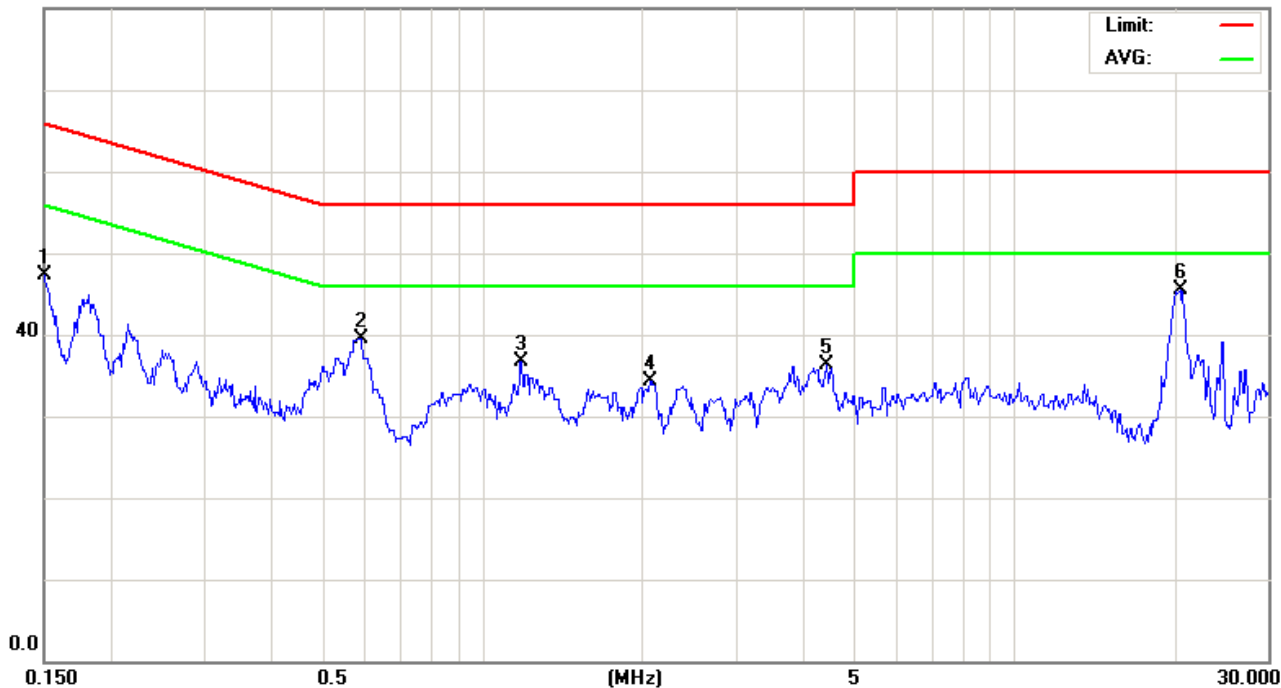

Site site#1

Phase: **L2**

Temperature: 26 °C

Limit: CISPR22 Class B Conduction(QP)

Power: AC 110V/60Hz

Humidity: 55 %

EUT:

M/N: 08-0252-E

Mode: WCDMA(BAND V)

Note: CH4132

No.	Mk.	Freq. MHz	Reading Level dBuV	Correct Factor dB	Measure- ment dBuV	Limit dBuV	Over dB	Detector	Comment
1		0.1500	37.59	9.73	47.32	65.99	-18.67	peak	
2		0.5899	29.73	9.79	39.52	56.00	-16.48	peak	
3		1.1839	26.95	9.80	36.75	56.00	-19.25	peak	
4		2.0659	24.49	9.86	34.35	56.00	-21.65	peak	
5		4.4239	26.24	10.02	36.26	56.00	-19.74	peak	
6	*	20.4500	35.16	10.40	45.56	60.00	-14.44	peak	

*:Maximum data x:Over limit !:over margin

●Reference Only



File :FD400(WCDMA)(BAND V)

Data :#3

Date: 2008/10/15

Time: 下午 09:19:29

80.0 dBuV

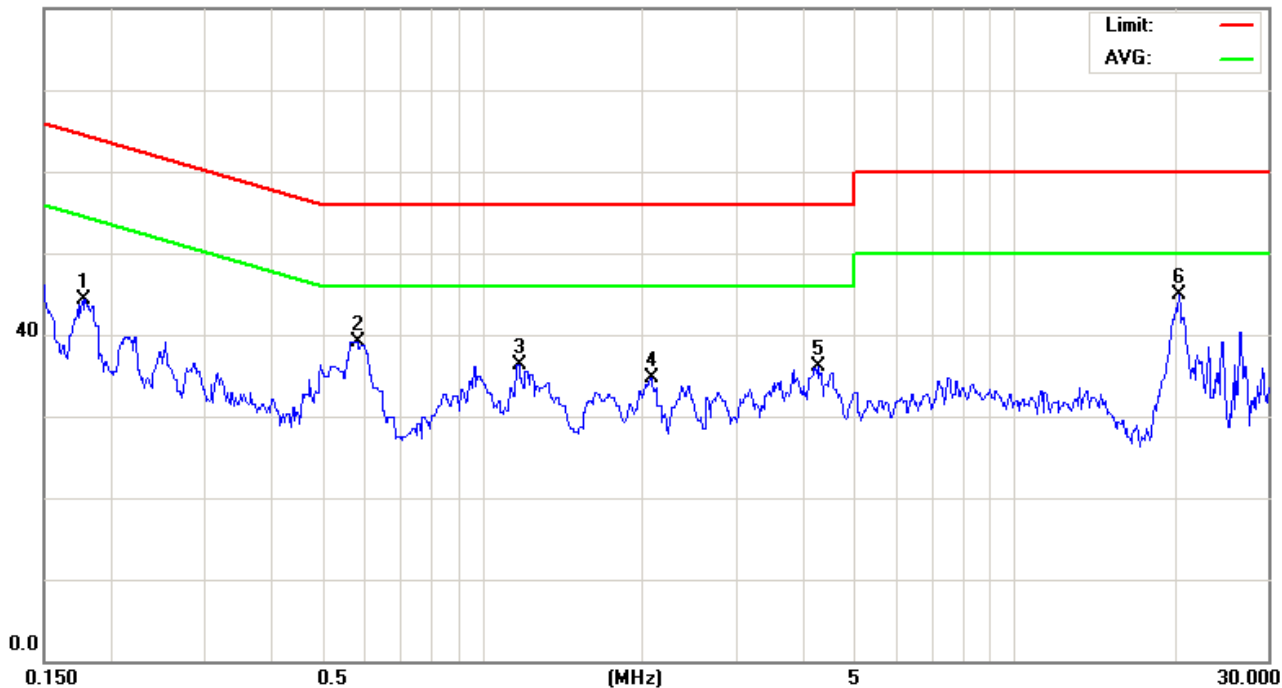

Site site#1

Phase: **L1**

Temperature: 26 °C

Limit: CISPR22 Class B Conduction(QP)

Power: AC 110V/60Hz

Humidity: 55 %

EUT:

M/N: 08-0252-E

Mode: WCDMA(BAND V)

Note: CH4180

No.	Mk.	Freq. MHz	Reading Level dBuV	Correct Factor dB	Measure- ment dBuV	Limit dBuV	Over dB	Detector	Comment
1		0.1787	34.52	9.74	44.26	64.54	-20.28	peak	
2		0.5810	29.37	9.79	39.16	56.00	-16.84	peak	
3		1.1660	26.54	9.80	36.34	56.00	-19.66	peak	
4		2.0660	24.92	9.86	34.78	56.00	-21.22	peak	
5		4.2619	26.09	10.00	36.09	56.00	-19.91	peak	
6	*	20.3500	34.57	10.36	44.93	60.00	-15.07	peak	

*:Maximum data x:Over limit !:over margin

●Reference Only



File :FD400(WCDMA)(BAND V)

Data :#4

Date: 2008/10/15

Time: 下午 09:22:39

80.0 dBuV

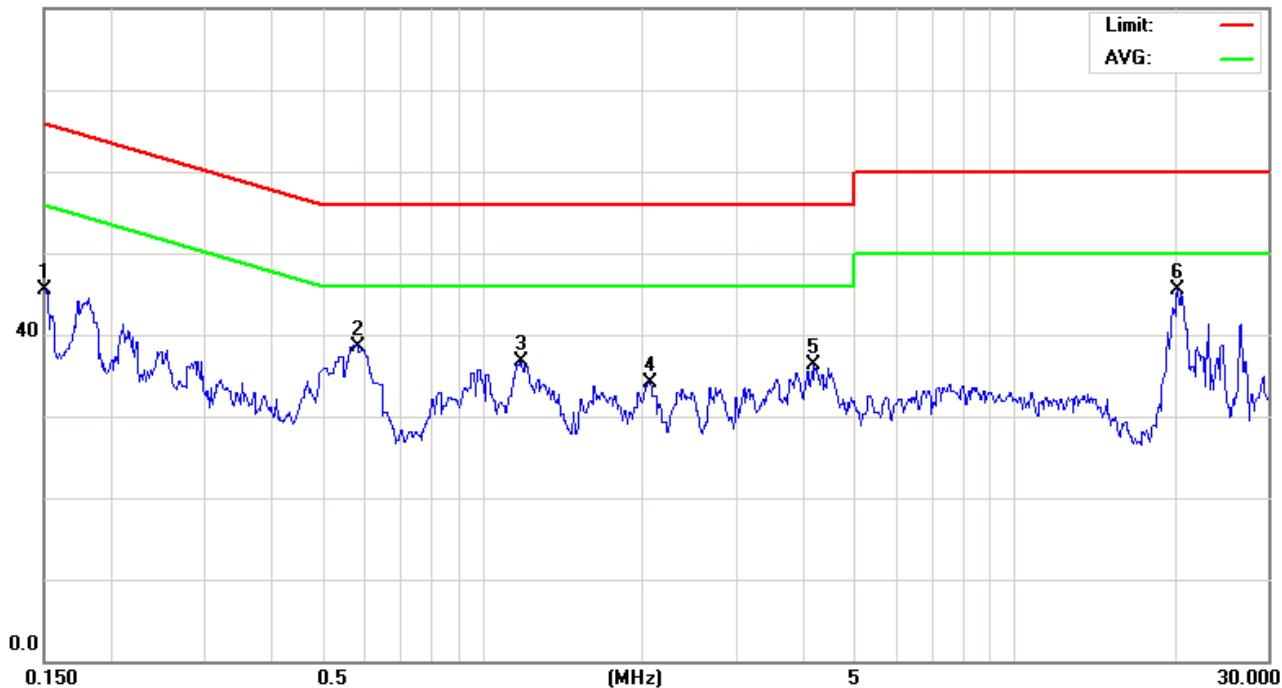

Site site#1

Phase: **L2**

Temperature: 26 °C

Limit: CISPR22 Class B Conduction(QP)

Power: AC 110V/60Hz

Humidity: 55 %

EUT:

M/N: 08-0252-E

Mode: WCDMA(BAND V)

Note: CH4180

No.	Mk.	Freq. MHz	Reading Level dBuV	Correct Factor dB	Measure- ment dBuV	Limit dBuV	Over dB	Detector	Comment
1		0.1500	35.79	9.73	45.52	65.99	-20.47	peak	
2		0.5810	28.81	9.79	38.60	56.00	-17.40	peak	
3		1.1839	26.94	9.80	36.74	56.00	-19.26	peak	
4		2.0569	24.24	9.86	34.10	56.00	-21.90	peak	
5		4.1989	26.24	9.98	36.22	56.00	-19.78	peak	
6	*	20.2500	35.10	10.31	45.41	60.00	-14.59	peak	

*:Maximum data x:Over limit !:over margin

●Reference Only



File :FD400(WCDMA)(BAND V)

Data :#5

Date: 2008/10/15

Time: 下午 09:24:43

80.0 dBuV

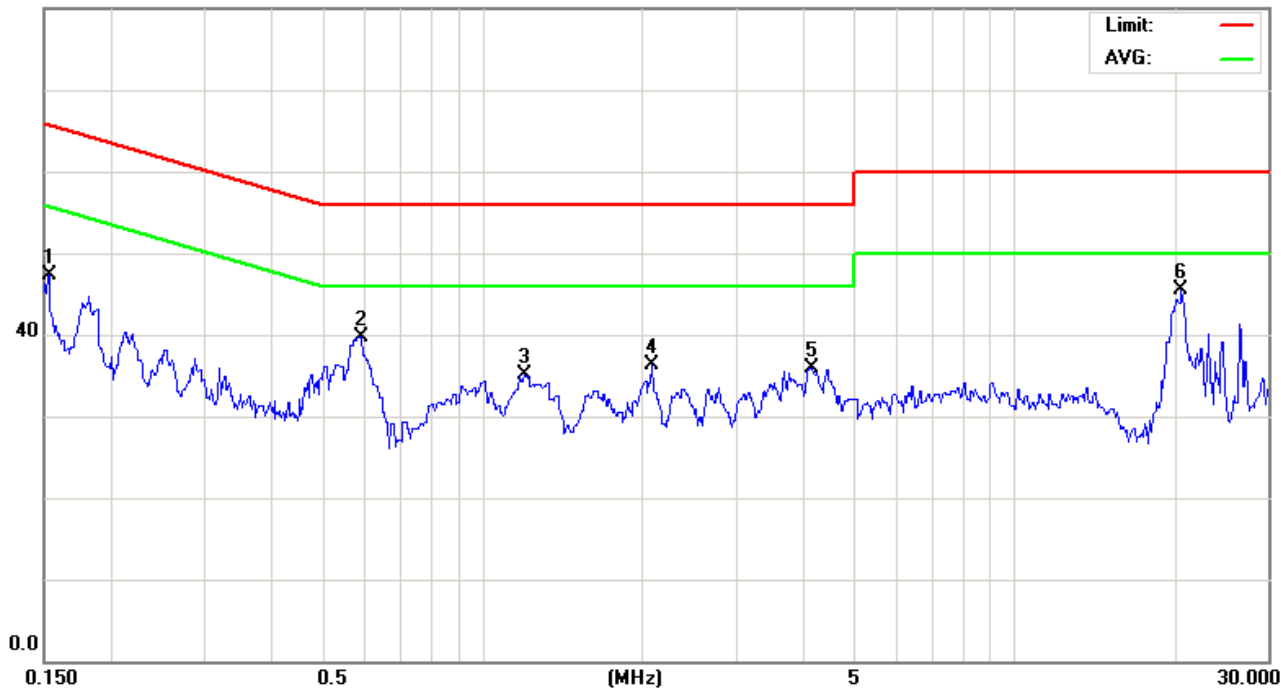

Site site#1

Phase: **L1**

Temperature: 26 °C

Limit: CISPR22 Class B Conduction(QP)

Power: AC 110V/60Hz

Humidity: 55 %

EUT:

M/N: 08-0252-E

Mode: WCDMA(BAND V)

Note: CH4233

No.	Mk.	Freq. MHz	Reading Level dBuV	Correct Factor dB	Measure- ment dBuV	Limit dBuV	Over dB	Detector	Comment
1		0.1528	37.59	9.73	47.32	65.84	-18.52	peak	
2		0.5899	29.95	9.79	39.74	56.00	-16.26	peak	
3		1.2020	25.26	9.81	35.07	56.00	-20.93	peak	
4		2.0840	26.37	9.87	36.24	56.00	-19.76	peak	
5		4.1359	25.94	9.97	35.91	56.00	-20.09	peak	
6	*	20.5500	35.02	10.45	45.47	60.00	-14.53	peak	

*:Maximum data x:Over limit !:over margin

●Reference Only



File :FD400(WCDMA)(BAND V)

Data :#6

Date: 2008/10/15

Time: 下午 09:26:30

80.0 dBuV

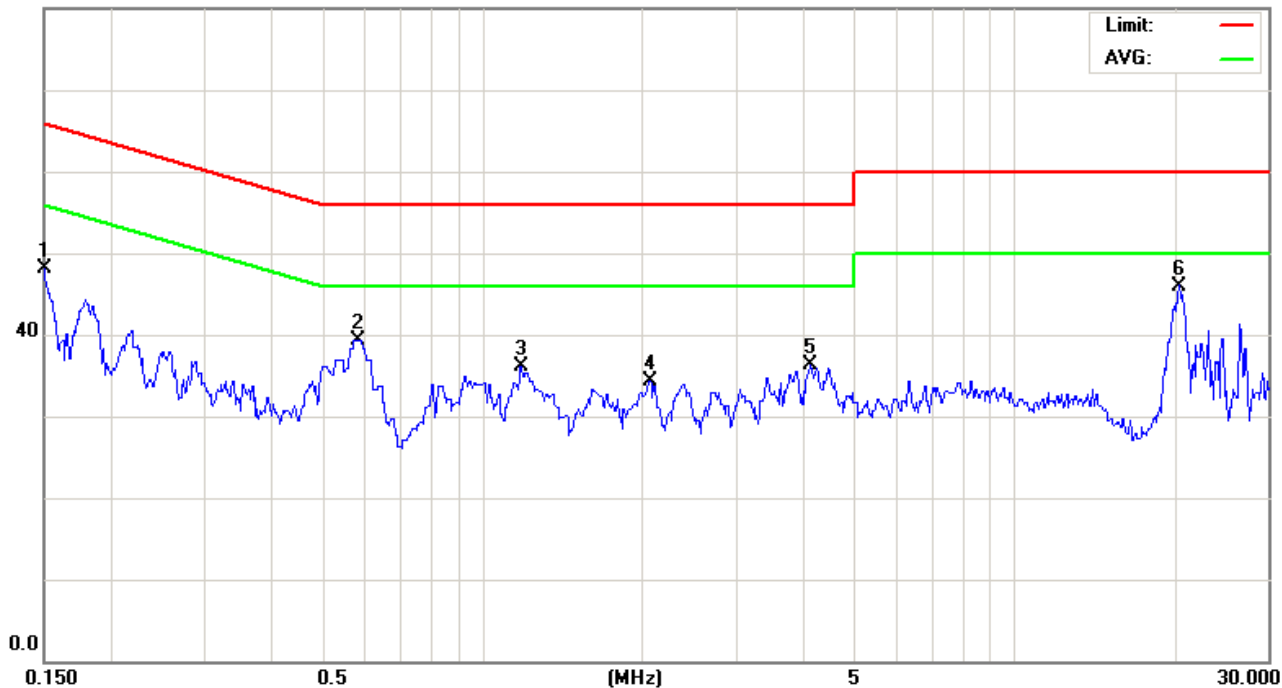

Site site#1

Phase: **L2**

Temperature: 26 °C

Limit: CISPR22 Class B Conduction(QP)

Power: AC 110V/60Hz

Humidity: 55 %

EUT:

M/N: 08-0252-E

Mode: WCDMA(BAND V)

Note: CH4233

No.	Mk.	Freq. MHz	Reading Level dBuV	Correct Factor dB	Measure- ment dBuV	Limit dBuV	Over dB	Detector	Comment
1		0.1500	38.34	9.73	48.07	65.99	-17.92	peak	
2		0.5810	29.54	9.79	39.33	56.00	-16.67	peak	
3		1.1839	26.27	9.80	36.07	56.00	-19.93	peak	
4		2.0569	24.44	9.86	34.30	56.00	-21.70	peak	
5		4.1269	26.27	9.97	36.24	56.00	-19.76	peak	
6	*	20.3500	35.64	10.36	46.00	60.00	-14.00	peak	

*:Maximum data x:Over limit !:over margin

●Reference Only



4.9.6.5 WCDMA Band II Test Result

Applicant : XAC Automation Corporation
Model No : FD-400
EUT : Portable Terminal
Test Mode : Link Mode _ WCDMA Band II (Low CH9262 / Middle CH9400 / High CH 9536)
Test Date : 10/15/2008

Please refer to next pager of detail testing data.



File :FD400(vvCDMA)(BAND II)

Data :#1

Date: 2008/10/15

Time: 下午 08:53:22

80.0 dBuV

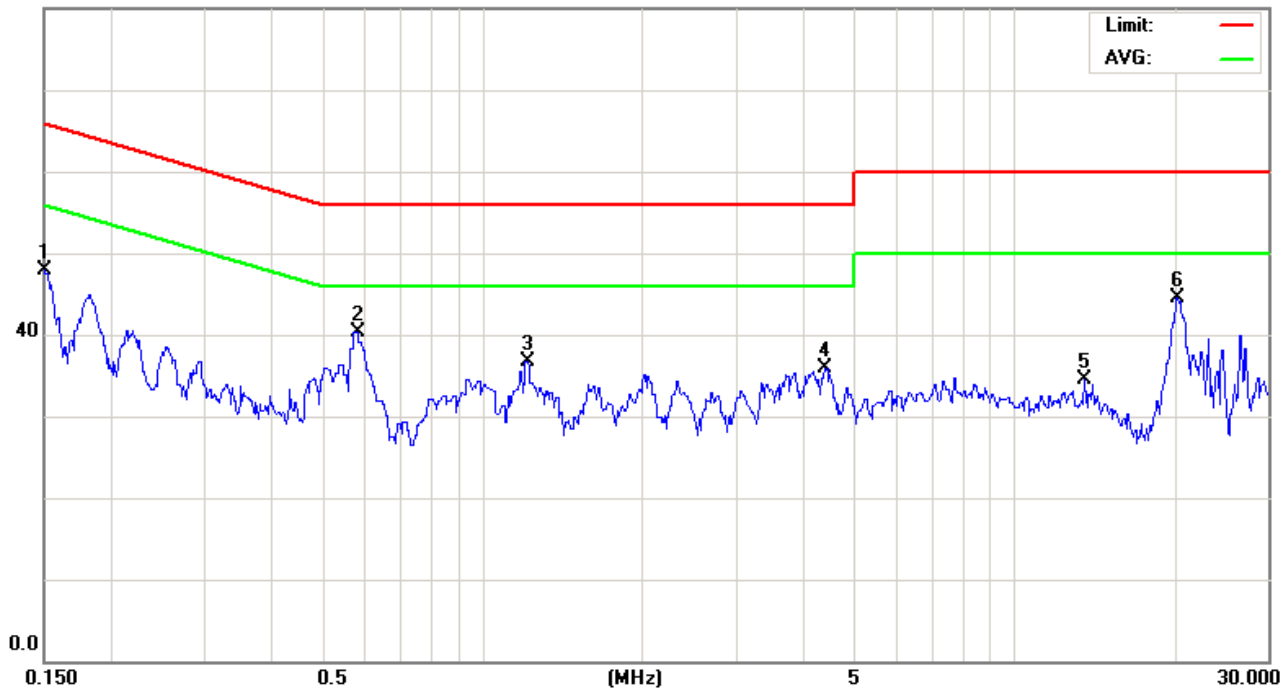

Site site#1

Phase: **L1**

Temperature: 26 °C

Limit: CISPR22 Class B Conduction(QP)

Power: AC 110V/60Hz

Humidity: 55 %

EUT:

M/N: 08-0252-E

Mode: BAND II

Note: CH9262

No.	Mk.	Freq. MHz	Reading Level dBuV	Correct Factor dB	Measure- ment dBuV	Limit dBuV	Over dB	Detector	Comment
1		0.1507	38.13	9.73	47.86	65.96	-18.10	peak	
2		0.5810	30.47	9.79	40.26	56.00	-15.74	peak	
3		1.2109	26.88	9.81	36.69	56.00	-19.31	peak	
4		4.4060	25.96	10.02	35.98	56.00	-20.02	peak	
5		13.5500	24.31	10.21	34.52	60.00	-25.48	peak	
6	*	20.2000	34.21	10.29	44.50	60.00	-15.50	peak	

*:Maximum data x:Over limit !:over margin

●Reference Only



File :FD400(vvCDMA)(BAND II)

Data :#2

Date: 2008/10/15

Time: 下午 08:58:09

80.0 dBuV

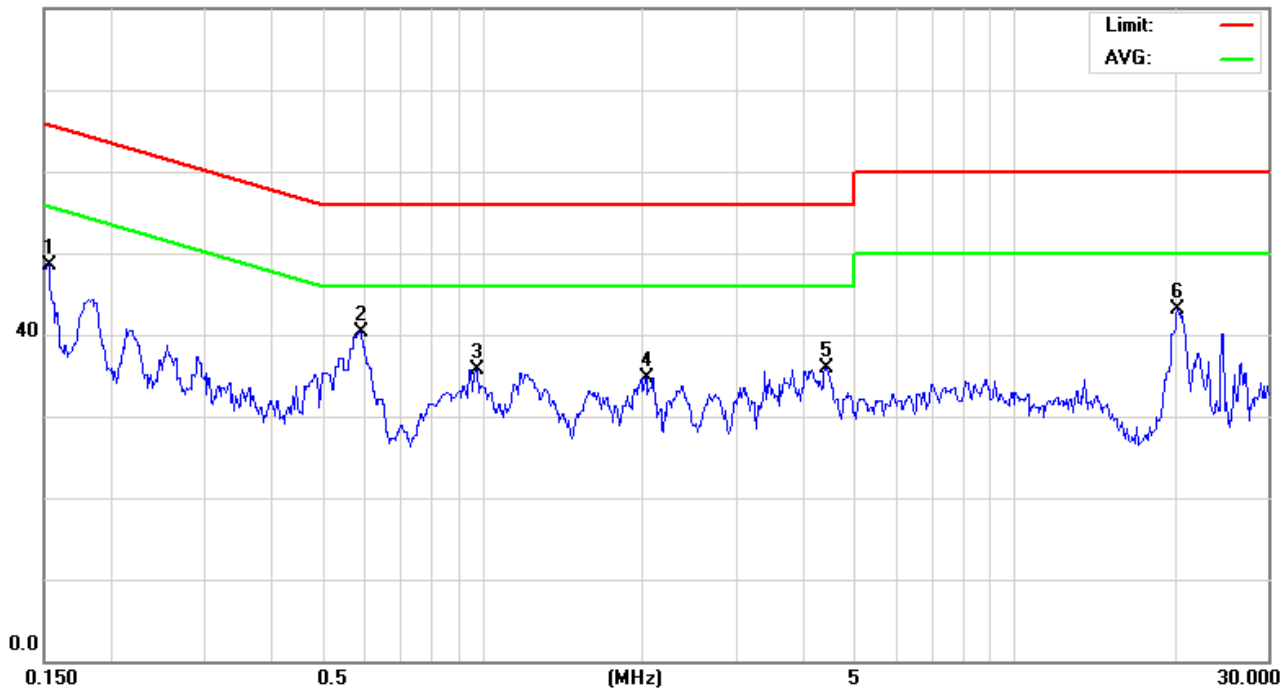

Site site#1

Phase: **L2**

Temperature: 26 °C

Limit: CISPR22 Class B Conduction(QP)

Power: AC 110V/60Hz

Humidity: 55 %

EUT:

M/N: 08-0252-E

Mode: BAND II

Note: CH9262

No.	Mk.	Freq. MHz	Reading Level dBuV	Correct Factor dB	Measure- ment dBuV	Limit dBuV	Over dB	Detector	Comment
1		0.1528	38.68	9.73	48.41	65.84	-17.43	peak	
2	*	0.5899	30.50	9.79	40.29	56.00	-15.71	peak	
3		0.9770	25.92	9.81	35.73	56.00	-20.27	peak	
4		2.0300	24.91	9.86	34.77	56.00	-21.23	peak	
5		4.4149	25.98	10.02	36.00	56.00	-20.00	peak	
6		20.2500	32.84	10.31	43.15	60.00	-16.85	peak	

*:Maximum data x:Over limit !:over margin

●Reference Only



File :FD400(vvCDMA)(BAND II)

Data :#3

Date: 2008/10/15

Time: 下午 09:03:59

80.0 dBuV

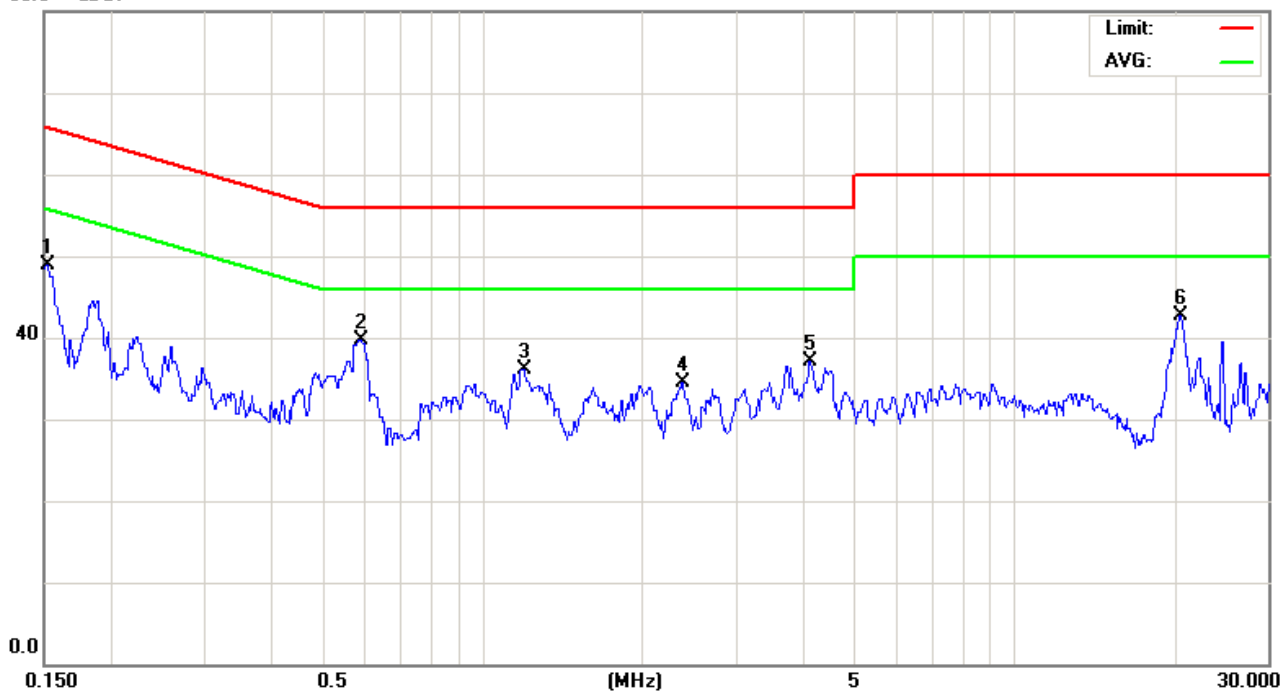

Site site#1

Phase: **L1**

Temperature: 26 °C

Limit: CISPR22 Class B Conduction(QP)

Power: AC 110V/60Hz

Humidity: 55 %

EUT:

M/N: 08-0252-E

Mode: BAND II

Note: CH9400

No.	Mk.	Freq. MHz	Reading Level dBuV	Correct Factor dB	Measure- ment dBuV	Limit dBuV	Over dB	Detector	Comment
1		0.1521	39.11	9.73	48.84	65.88	-17.04	peak	
2	*	0.5899	29.98	9.79	39.77	56.00	-16.23	peak	
3		1.1929	26.29	9.80	36.09	56.00	-19.91	peak	
4		2.3718	24.64	9.84	34.48	56.00	-21.52	peak	
5		4.1179	27.12	9.97	37.09	56.00	-18.91	peak	
6		20.4000	32.41	10.38	42.79	60.00	-17.21	peak	

*:Maximum data x:Over limit !:over margin

●Reference Only



File :FD400(vvCDMA)(BAND II)

Data :#4

Date: 2008/10/15

Time: 下午 09:05:58

80.0 dBuV

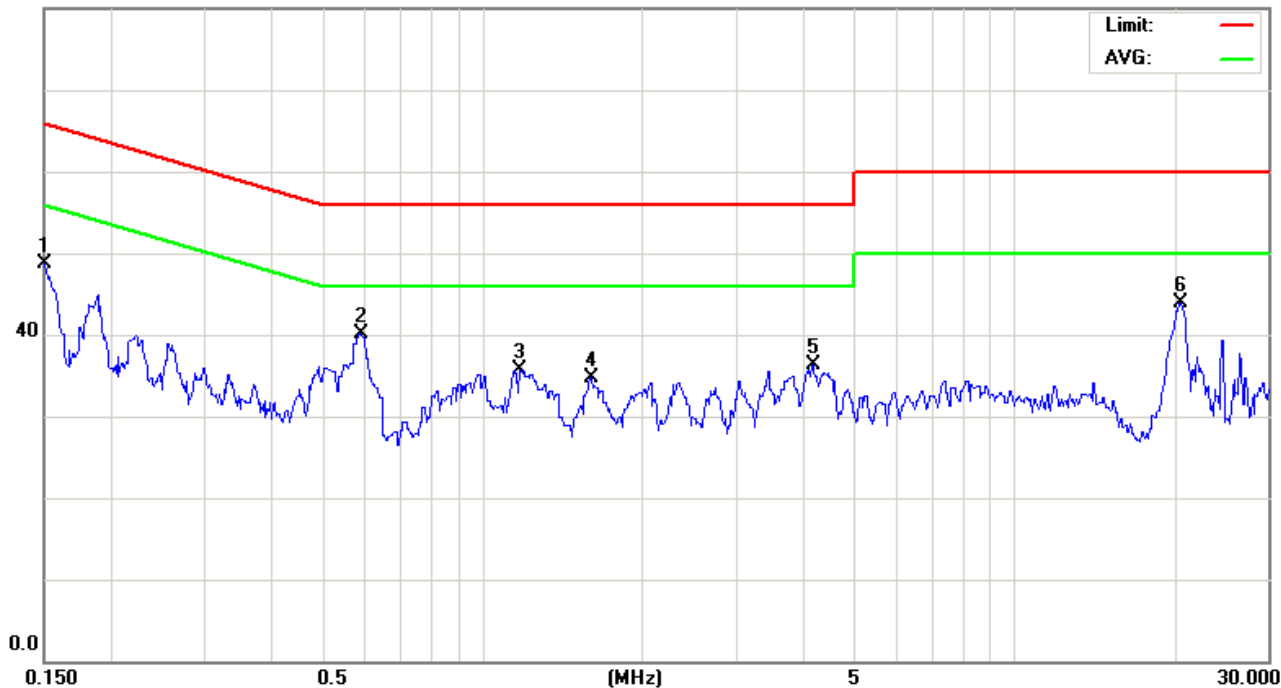

Site site#1

Phase: **L2**

Temperature: 26 °C

Limit: CISPR22 Class B Conduction(QP)

Power: AC 110V/60Hz

Humidity: 55 %

EUT:

M/N: 08-0252-E

Mode: BAND II

Note: CH9400

No.	Mk.	Freq. MHz	Reading Level dBuV	Correct Factor dB	Measure- ment dBuV	Limit dBuV	Over dB	Detector	Comment
1		0.1500	38.99	9.73	48.72	65.99	-17.27	peak	
2	*	0.5899	30.32	9.79	40.11	56.00	-15.89	peak	
3		1.1750	25.95	9.80	35.75	56.00	-20.25	peak	
4		1.5980	24.93	9.82	34.75	56.00	-21.25	peak	
5		4.1630	26.25	9.97	36.22	56.00	-19.78	peak	
6		20.4000	33.51	10.38	43.89	60.00	-16.11	peak	

*:Maximum data x:Over limit !:over margin

●Reference Only



File :FD400(vvCDMA)(BAND II)

Data :#5

Date: 2008/10/15

Time: 下午 09:09:25

80.0 dBuV

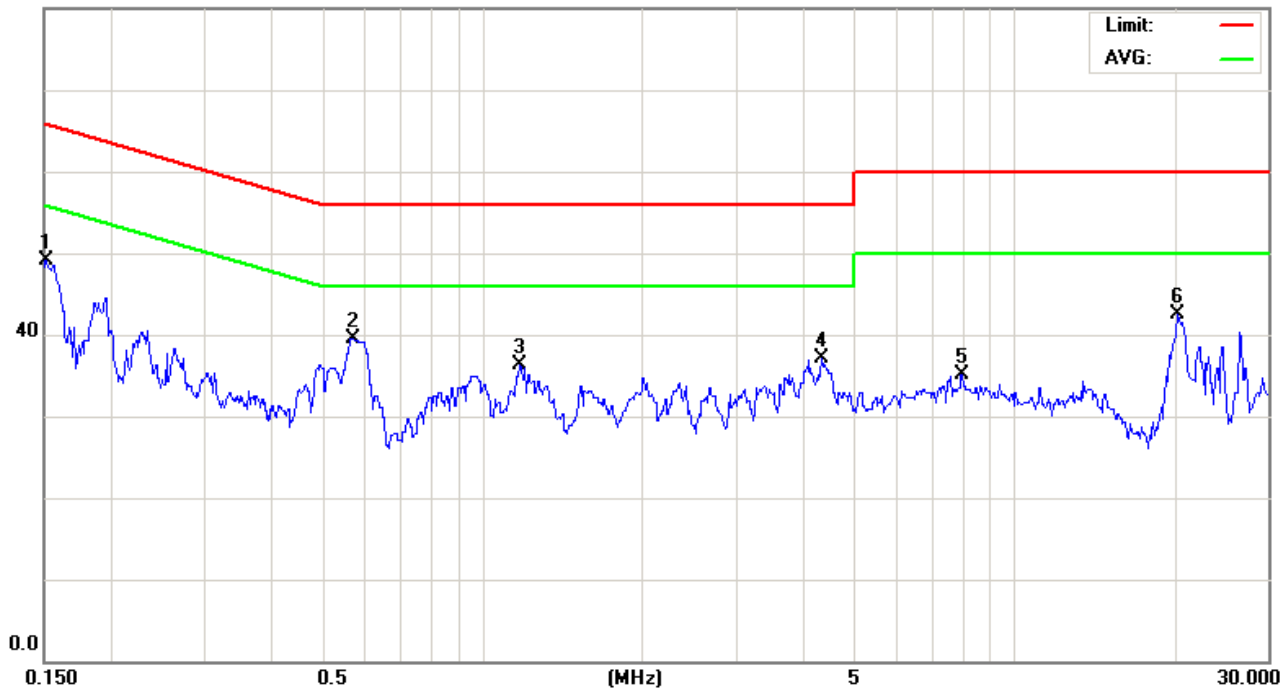

Site site#1

Phase: **L1**

Temperature: 26 °C

Limit: CISPR22 Class B Conduction(QP)

Power: AC 110V/60Hz

Humidity: 55 %

EUT:

M/N: 08-0252-E

Mode: BAND II

Note: CH9538

No.	Mk.	Freq. MHz	Reading Level dBuV	Correct Factor dB	Measure- ment dBuV	Limit dBuV	Over dB	Detector	Comment
1		0.1514	39.30	9.73	49.03	65.92	-16.89	peak	
2	*	0.5720	29.74	9.79	39.53	56.00	-16.47	peak	
3		1.1749	26.53	9.80	36.33	56.00	-19.67	peak	
4		4.3249	27.07	10.01	37.08	56.00	-18.92	peak	
5		7.9500	25.05	10.09	35.14	60.00	-24.86	peak	
6		20.2500	32.14	10.31	42.45	60.00	-17.55	peak	

*:Maximum data x:Over limit !:over margin

●Reference Only



File :FD400(vvCDMA)(BAND II)

Data :#6

Date: 2008/10/15

Time: 下午 09:11:16

80.0 dBuV

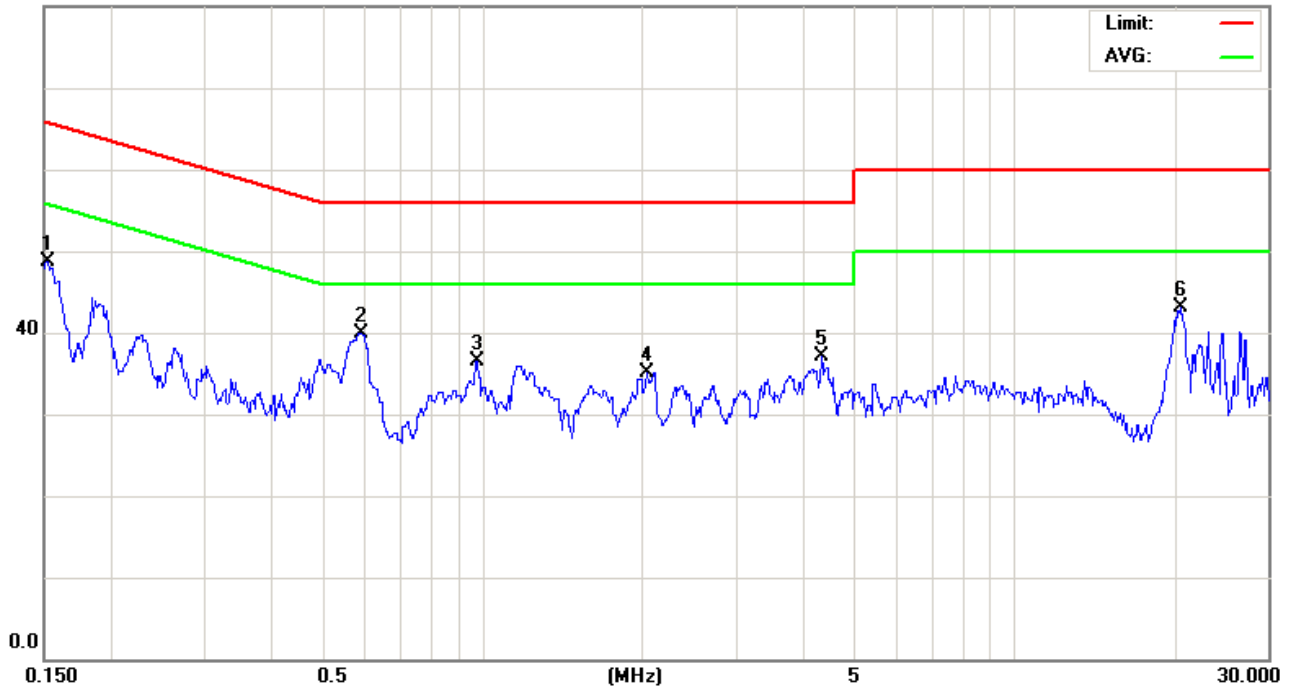

Site site#1

Phase: **L2**

Temperature: 26 °C

Limit: CISPR22 Class B Conduction(QP)

Power: AC 110V/60Hz

Humidity: 55 %

EUT:

M/N: 08-0252-E

Mode: BAND II

Note: CH9538

No.	Mk.	Freq. MHz	Reading Level dBuV	Correct Factor dB	Measure- ment dBuV	Limit dBuV	Over dB	Detector	Comment
1		0.1521	39.01	9.73	48.74	65.88	-17.14	peak	
2	*	0.5899	30.07	9.79	39.86	56.00	-16.14	peak	
3		0.9770	26.66	9.81	36.47	56.00	-19.53	peak	
4		2.0390	25.30	9.86	35.16	56.00	-20.84	peak	
5		4.3340	27.06	10.01	37.07	56.00	-18.93	peak	
6		20.4500	32.75	10.40	43.15	60.00	-16.85	peak	

*:Maximum data x:Over limit !:over margin

●Reference Only



File :FD400(WCDMA)(BAND II)

Data :#1

Date: 2008/10/15

Time: 下午 08:53:22

80.0 dBuV

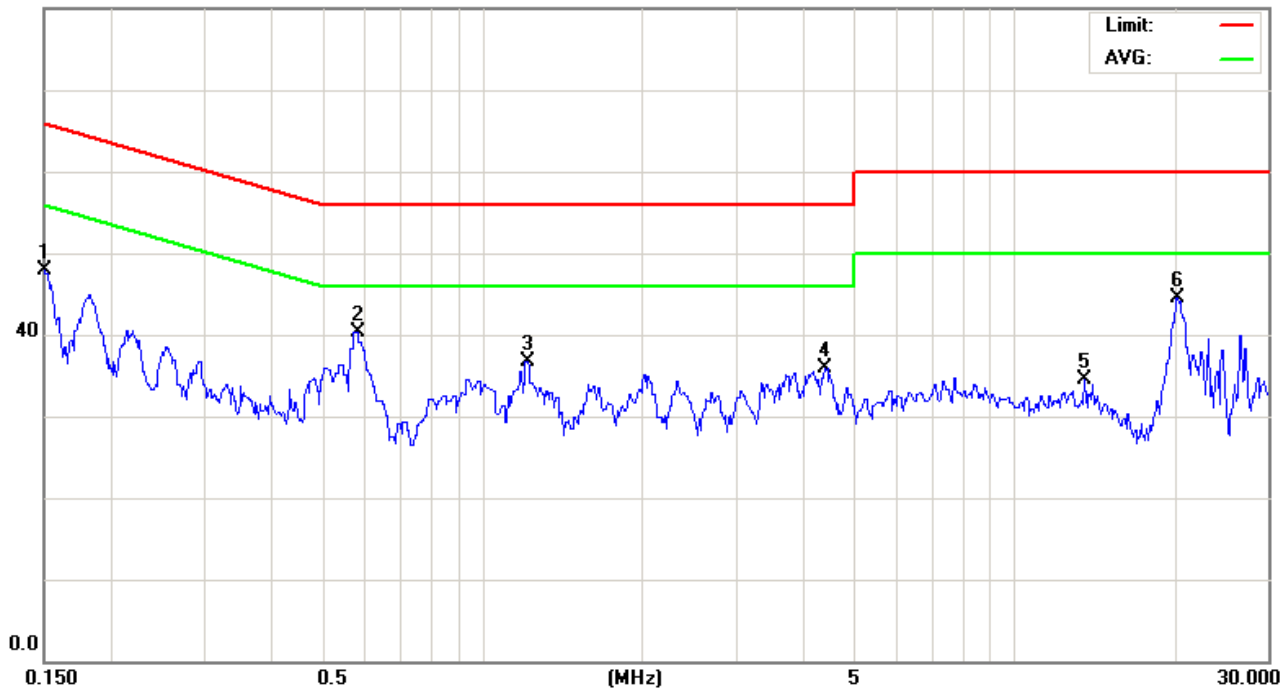

Site site#1

Phase: **L1**

Temperature: 26 °C

Limit: CISPR22 Class B Conduction(QP)

Power: AC 110V/60Hz

Humidity: 55 %

EUT:

M/N: 08-0252-E

Mode: WCDMA(BAND II)

Note: CH9262

No.	Mk.	Freq. MHz	Reading Level dBuV	Correct Factor dB	Measure- ment dBuV	Limit dBuV	Over dB	Detector	Comment
1		0.1507	38.13	9.73	47.86	65.96	-18.10	peak	
2		0.5810	30.47	9.79	40.26	56.00	-15.74	peak	
3		1.2109	26.88	9.81	36.69	56.00	-19.31	peak	
4		4.4060	25.96	10.02	35.98	56.00	-20.02	peak	
5		13.5500	24.31	10.21	34.52	60.00	-25.48	peak	
6	*	20.2000	34.21	10.29	44.50	60.00	-15.50	peak	

*:Maximum data x:Over limit !:over margin

●Reference Only



File :FD400(wCDMA)(BAND II)

Data :#2

Date: 2008/10/15

Time: 下午 08:58:09

80.0 dBuV

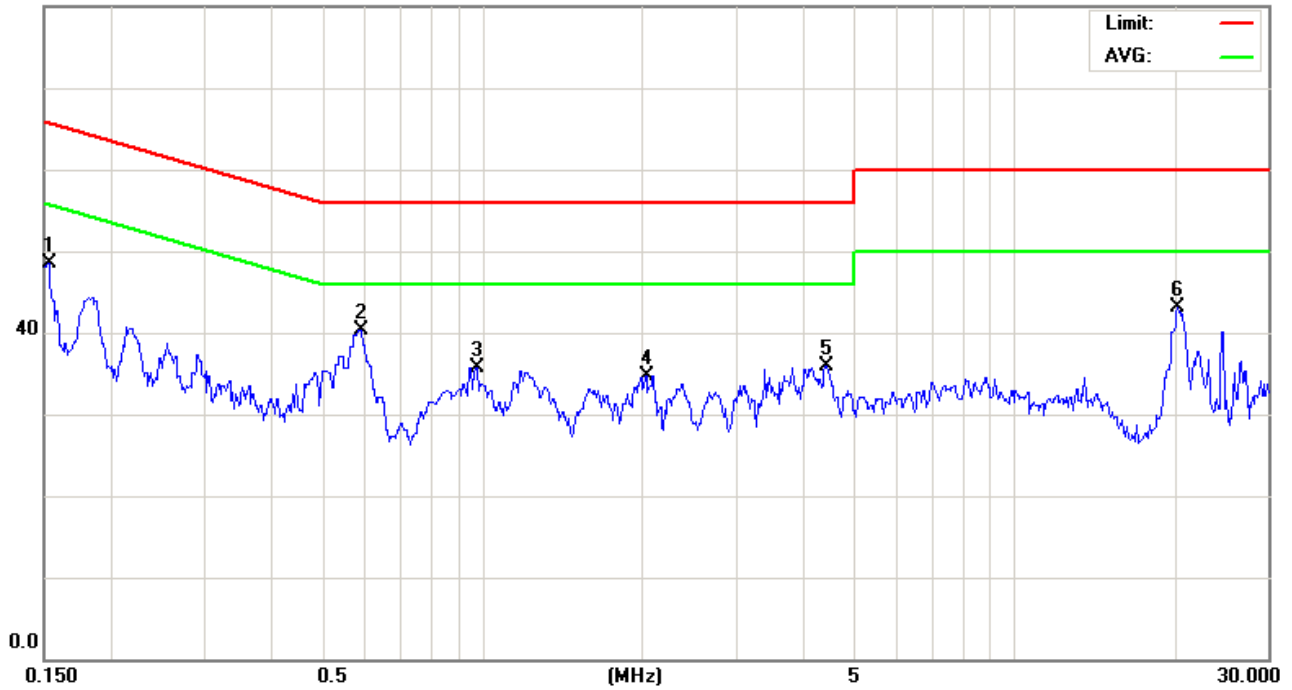

Site site#1

Phase: **L2**

Temperature: 26 °C

Limit: CISPR22 Class B Conduction(QP)

Power: AC 110V/60Hz

Humidity: 55 %

EUT:

M/N: 08-0252-E

Mode: WCDMA(BAND II)

Note: CH9262

No.	Mk.	Freq. MHz	Reading Level dBuV	Correct Factor dB	Measure- ment dBuV	Limit dBuV	Over dB	Detector	Comment
1		0.1528	38.68	9.73	48.41	65.84	-17.43	peak	
2	*	0.5899	30.50	9.79	40.29	56.00	-15.71	peak	
3		0.9770	25.92	9.81	35.73	56.00	-20.27	peak	
4		2.0300	24.91	9.86	34.77	56.00	-21.23	peak	
5		4.4149	25.98	10.02	36.00	56.00	-20.00	peak	
6		20.2500	32.84	10.31	43.15	60.00	-16.85	peak	

*:Maximum data x:Over limit !:over margin

●Reference Only



File : CH400(WCDMA)(BAND II)

Data :#3

Date: 2008/10/15

Time: 下午 09:03:59

80.0 dBuV

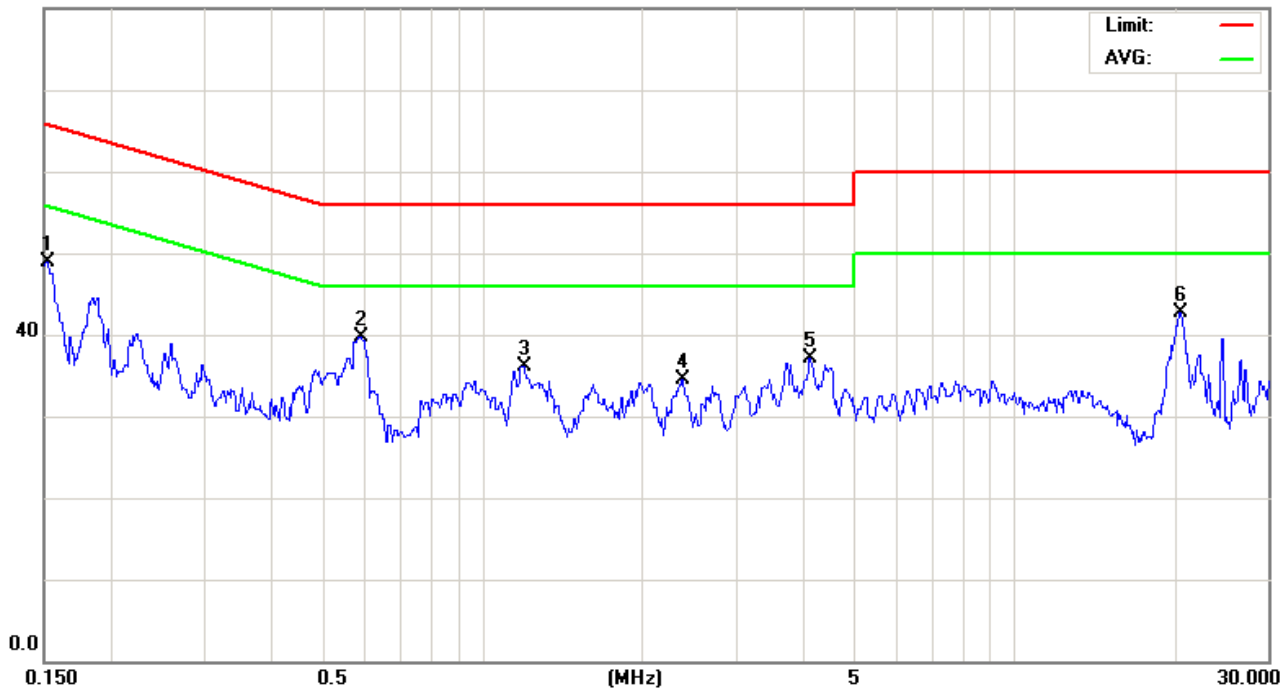

Site site#1

Phase: **L1**

Temperature: 26 °C

Limit: CISPR22 Class B Conduction(QP)

Power: AC 110V/60Hz

Humidity: 55 %

EUT:

M/N: 08-0252-E

Mode: WCDMA(BAND II)

Note: CH9400

No.	Mk.	Freq. MHz	Reading Level dBuV	Correct Factor dB	Measure- ment dBuV	Limit dBuV	Over dB	Detector	Comment
1		0.1521	39.11	9.73	48.84	65.88	-17.04	peak	
2	*	0.5899	29.98	9.79	39.77	56.00	-16.23	peak	
3		1.1929	26.29	9.80	36.09	56.00	-19.91	peak	
4		2.3718	24.64	9.84	34.48	56.00	-21.52	peak	
5		4.1179	27.12	9.97	37.09	56.00	-18.91	peak	
6		20.4000	32.41	10.38	42.79	60.00	-17.21	peak	

*:Maximum data x:Over limit !:over margin

●Reference Only



File : CH400(WCDMA)(BAND II)

Data :#4

Date: 2008/10/15

Time: 下午 09:05:58

80.0 dBuV

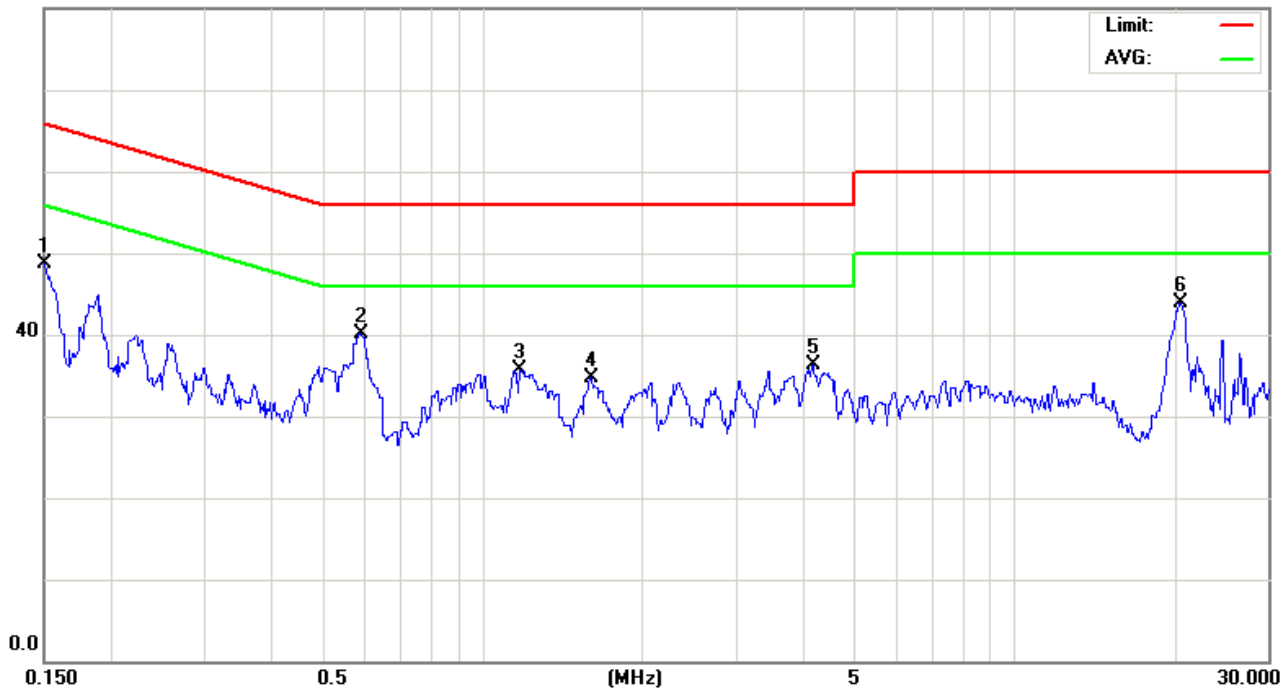

Site site#1

Phase: **L2**

Temperature: 26 °C

Limit: CISPR22 Class B Conduction(QP)

Power: AC 110V/60Hz

Humidity: 55 %

EUT:

M/N: 08-0252-E

Mode: WCDMA(BAND II)

Note: CH9400

No.	Mk.	Freq. MHz	Reading Level dBuV	Correct Factor dB	Measure- ment dBuV	Limit dBuV	Over dB	Detector	Comment
1		0.1500	38.99	9.73	48.72	65.99	-17.27	peak	
2	*	0.5899	30.32	9.79	40.11	56.00	-15.89	peak	
3		1.1750	25.95	9.80	35.75	56.00	-20.25	peak	
4		1.5980	24.93	9.82	34.75	56.00	-21.25	peak	
5		4.1630	26.25	9.97	36.22	56.00	-19.78	peak	
6		20.4000	33.51	10.38	43.89	60.00	-16.11	peak	

*:Maximum data x:Over limit !:over margin

●Reference Only



File :FD400(WCDMA)(BAND II)

Data :#5

Date: 2008/10/15

Time: 下午 09:09:25

80.0 dBuV

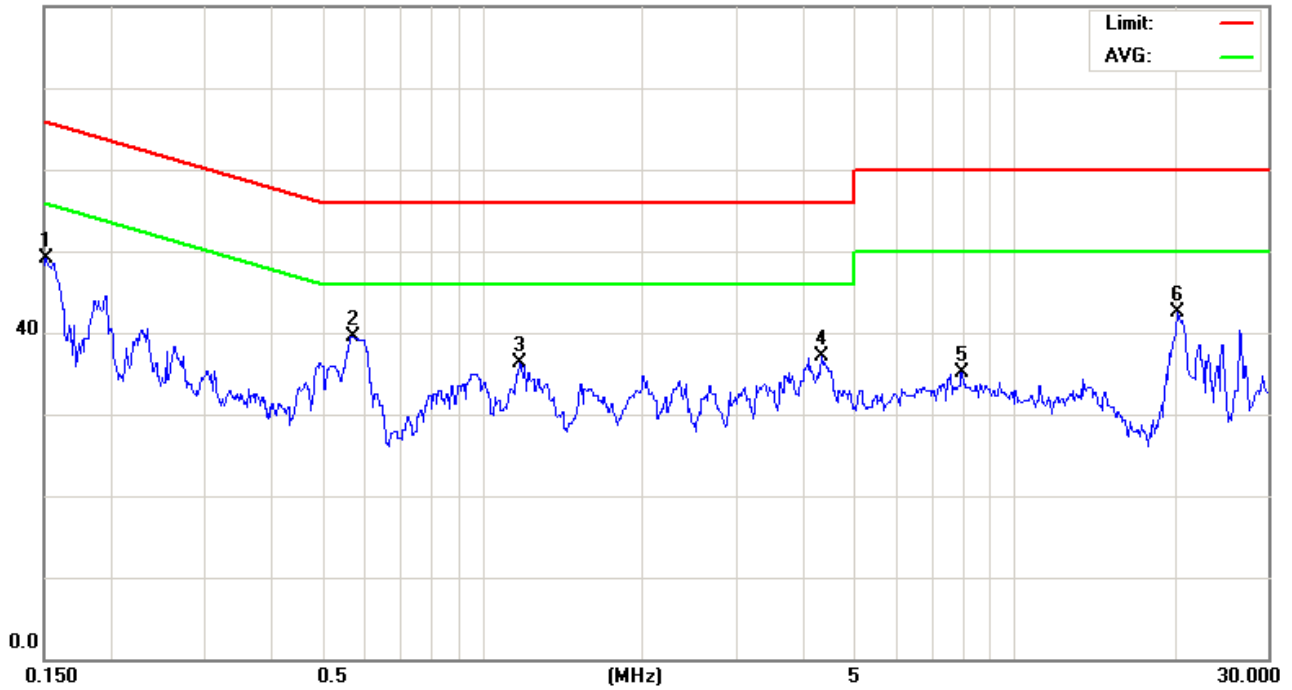

Site site#1

Phase: **L1**

Temperature: 26 °C

Limit: CISPR22 Class B Conduction(QP)

Power: AC 110V/60Hz

Humidity: 55 %

EUT:

M/N: 08-0252-E

Mode: WCDMA(BAND II)

Note: CH9538

No.	Mk.	Freq. MHz	Reading Level dBuV	Correct Factor dB	Measure- ment dBuV	Limit dBuV	Over dB	Detector	Comment
1		0.1514	39.30	9.73	49.03	65.92	-16.89	peak	
2	*	0.5720	29.74	9.79	39.53	56.00	-16.47	peak	
3		1.1749	26.53	9.80	36.33	56.00	-19.67	peak	
4		4.3249	27.07	10.01	37.08	56.00	-18.92	peak	
5		7.9500	25.05	10.09	35.14	60.00	-24.86	peak	
6		20.2500	32.14	10.31	42.45	60.00	-17.55	peak	

*:Maximum data x:Over limit !:over margin

●Reference Only



File :FD400(WCDMA)(BAND II)

Data :#6

Date: 2008/10/15

Time: 下午 09:11:16

80.0 dBuV

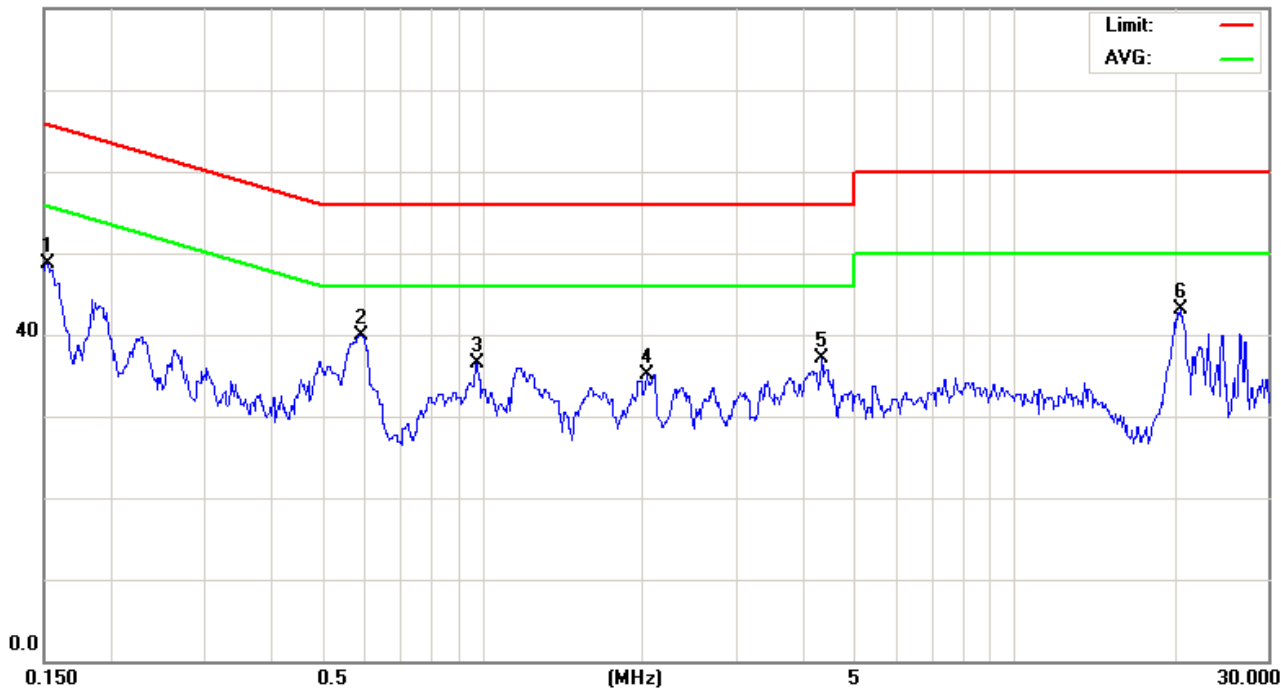

Site site#1

Phase: **L2**

Temperature: 26 °C

Limit: CISPR22 Class B Conduction(QP)

Power: AC 110V/60Hz

Humidity: 55 %

EUT:

M/N: 08-0252-E

Mode: WCDMA(BAND II)

Note: CH9538

No.	Mk.	Freq. MHz	Reading Level dBuV	Correct Factor dB	Measure- ment dBuV	Limit dBuV	Over dB	Detector	Comment
1		0.1521	39.01	9.73	48.74	65.88	-17.14	peak	
2	*	0.5899	30.07	9.79	39.86	56.00	-16.14	peak	
3		0.9770	26.66	9.81	36.47	56.00	-19.53	peak	
4		2.0390	25.30	9.86	35.16	56.00	-20.84	peak	
5		4.3340	27.06	10.01	37.07	56.00	-18.93	peak	
6		20.4500	32.75	10.40	43.15	60.00	-16.85	peak	

*:Maximum data x:Over limit !:over margin

●Reference Only



5. List of Measurement Equipments

Manufacturer	Name of Equipment	Type/Model	Serial Number	Calibration	
				Last Cal.	Due Date
Agilent	Spectrum analyzer	E4408B	MY45107753	Jun. 05, 2008	Jun. 05, 2009
R&S	Receiver	ESCI	100367	Jun. 05, 2008	Jun. 05, 2009
SCHWARZBECK	Trilog Broadband Antenna	VULB 9163	9163-270	Jun. 26, 2008	Jun. 26, 2009
SCHWARZBECK	Broadband Horn Antenna	BBHA 9120D	9120D-550	Jun. 26, 2008	Jun. 26, 2009
SCHWARZBECK	Broadband Horn Antenna	BBHA 9170	9170-320	Jun. 09, 2008	Aug. 07, 2009
Agilent	Amplifier	8447D	2944A10961	Jun. 10, 2008	Jun. 10, 2009
Universal Radio Communication Tester	ROHDE & SCHWARZ	CMU200	112387	Jul. 25, 2008	Jul. 25, 2009
Spectrum Analyzer	Agilent	E4445A	MY45300744	Nov. 29, 2007	Nov. 29, 2008
Loop Dipole	ETS-Lindgren	3127-1880	00052640	Jul. 02, 2008	Jul. 02, 2009
Loop Dipole	ETS-Lindgren	3127-836	00055272	Jun. 29, 2008	Jun. 29, 2009
Sleeve Dipole	ETS-Lindgren	3126-1845	00056670	Jun. 29, 2008	Jun. 29, 2009
Sleeve Dipole	ETS-Lindgren	3126-880	00052705	Jun. 29, 2008	Jun. 29, 2009
Anechoic Chamber	ETS-Lindgren	AMS 8500	S/N 102165	NA	
High Pass Filter	MICRO-TRONICS	HPM50108	020	NA	
High Pass Filter	MICRO-TRONICS	HPM50111	021	NA	
Circularly Polarized Communication Antennas	EMCO	3102	00051714	NA	
Pattern Measurement Software	ETS-Lindgren	EMQuest™ EMQ-100	NA	NA	
Desktop Computer with Windows XP		Dell Computers	NA	NA	
Antenna Positioner Controller	EMCO	2090	00052447	NA	
MAPS Positioner	EMCO	2010/2015	NA	NA	
Filter	K&L	5TNF-1700/ 2000-0.1N/N	166	NA	
Filter	K&L	3TNF-800/ 1000-0.2N/N	274	NA	
Attenuator	RADIALL	R41572000	0603033073	NA	
Splitter	Powercom	SGR-GFQ-2-D	41106609	NA	
Power divider	Agilent	87302C	3239A00760	NA	



6. Uncertainty Evaluation

Uncertainty of Radiated Emission Measurement (30MHz ~ 1000MHz)

Contribution	Uncertainty of x_i		$U(x_i)$
	dB	Probability Distribution	
Receiver reading	0.41	Normal(k=2)	0.21
Antenna factor calibration	0.83	Normal(k=2)	0.42
Cable loss calibration	0.25	Normal(k=2)	0.13
Pre Amplifier Gain calibration	0.27	Normal(k=2)	0.14
RCV/SPA specification	2.50	Rectangular	0.72
Antenna Factor Interpolation for Frequency	1.00	Rectangular	0.29
Site imperfection	1.43	Rectangular	0.83
Mismatch	+0.39/-0.41	U-shaped	0.28
combined standard uncertainty Uc(y)	1.27		
Measuring uncertainty for a level of confidence of 95% U=2Uc(y)	2.54		

Uncertainty of Radiated Emission Measurement (1GHz ~ 40GHz)

Contribution	Uncertainty of x_i		$U(x_i)$	C_i	$C_i * U(x_i)$
	dB	Probability Distributio			
Receiver reading	±0.10	Normal(k=1)	0.10	1	0.10
Antenna factor calibration	±1.70	Normal(k=2)	0.85	1	0.85
Cable loss calibration	±0.50	Normal(k=2)	0.25	1	0.25
Receiver Correction	±2.00	Rectangular	1.15	1	1.15
Antenna Factor Directional	±1.50	Rectangular	0.87	1	0.87
Site imperfection	±2.80	Triangular	1.14	1	1.14
Mismatch Receiver VSWR $\sqrt{1} = 0.197$ Antenna VSWR $\sqrt{2} = 0.194$ Uncertainty= $20\log(1-\sqrt{1} * \sqrt{2} * \sqrt{3})$	+0.34/-0.35	U-shaped	0.244	1	0.244
Combined standard uncertainty Uc(y)	2.36				
Measuring uncertainty for a level of confidence of 95% U=2Ue(y)	4.72				