



BUREAU
VERITAS

FCC Test Report (BT-EDR)

Report No.: RF160509E03A-2

FCC ID: MQT-200I10YXX

Test Model: xCE_E200I-10YXX

Received Date: May 18, 2016

Test Date: June 03 to Aug. 15, 2016

Issued Date: Sep. 02, 2016

Applicant: XAC AUTOMATION CORP.

Address: 4F, No. 30, INDUSTRY E. RD. IX, SCIENCE-BASED INDUSTRIAL PARK,HSINCHU,TAIWAN

Issued By: Bureau Veritas Consumer Products Services (H.K.) Ltd., Taoyuan Branch Hsin Chu Laboratory

Lab Address: E-2, No.1, Li Hsin 1st Road, Hsinchu Science Park, Hsinchu City 300, Taiwan R.O.C.

Test Location (1): E-2, No.1, Li Hsin 1st Road, Hsinchu Science Park, Hsinchu City 300, Taiwan R.O.C.

Test Location (2): No. 49, Ln. 206, Wende Rd., Shangshan Tsuen, Chiung Lin Hsiang, Hsin Chu Hsien 307, Taiwan R.O.C.



This report is for your exclusive use. Any copying or replication of this report to or for any other person or entity, or use of our name or trademark, is permitted only with our prior written permission. This report sets forth our findings solely with respect to the test samples identified herein. The results set forth in this report are not indicative or representative of the quality or characteristics of the lot from which a test sample was taken or any similar or identical product unless specifically and expressly noted. Our report includes all of the tests requested by you and the results thereof based upon the information that you provided to us. You have 60 days from date of issuance of this report to notify us of any material error or omission caused by our negligence, provided, however, that such notice shall be in writing and shall specifically address the issue you wish to raise. A failure to raise such issue within the prescribed time shall constitute your unqualified acceptance of the completeness of this report, the tests conducted and the correctness of the report contents. Unless specific mention, the uncertainty of measurement has been explicitly taken into account to declare the compliance or non-compliance to the specification. The report must not be used by the client to claim product certification, approval, or endorsement by TAF or any government agencies.

Table of Contents

Release Control Record	4
1 Certificate of Conformity	5
2 Summary of Test Results	6
2.1 Measurement Uncertainty	7
2.2 Modification Record	7
3 General Information	8
3.1 General Description of EUT (BT-EDR)	8
3.2 Description of Test Modes	9
3.2.1 Test Mode Applicability and Tested Channel Detail	10
3.3 Description of Support Units	12
3.3.1 Configuration of System under Test	13
3.4 General Description of Applied Standards	14
4 Test Types and Results	15
4.1 Radiated Emission and Bandedge Measurement	15
4.1.1 Limits of Radiated Emission and Bandedge Measurement	15
4.1.2 Test Instruments	16
4.1.3 Test Procedures	18
4.1.4 Deviation from Test Standard	18
4.1.5 Test Setup	19
4.1.6 EUT Operating Conditions	19
4.1.7 Test Results	20
4.2 Conducted Emission Measurement	27
4.2.1 Limits of Conducted Emission Measurement	27
4.2.2 Test Instruments	27
4.2.3 Test Procedures	28
4.2.4 Deviation From Test Standard	28
4.2.5 Test Setup	28
4.2.6 EUT Operating Condition	28
4.2.7 Test Results	29
4.3 Number of Hopping Frequency Used	31
4.3.1 Limits of Hopping Frequency Used Measurement	31
4.3.2 Test Setup	31
4.3.3 Test Instruments	31
4.3.4 Test Procedure	31
4.3.5 Deviation from Test Standard	31
4.3.6 Test Results	32
4.4 Dwell Time on Each Channel	33
4.4.1 Limits of Dwell Time on Each Channel Measurement	33
4.4.2 Test Setup	33
4.4.3 Test Instruments	33
4.4.4 Test Procedures	33
4.4.5 Deviation from Test Standard	33
4.4.6 Test Results	34
4.5 Channel Bandwidth	38
4.5.1 Limits of Channel Bandwidth Measurement	38
4.5.2 Test Setup	38
4.5.3 Test Instruments	38
4.5.4 Test Procedure	38
4.5.5 Deviation from Test Standard	38
4.5.6 EUT Operating Condition	38
4.5.7 Test Results	39
4.6 Hopping Channel Separation	40
4.6.1 Limits of Hopping Channel Separation Measurement	40



4.6.2	Test Setup.....	40
4.6.3	Test Instruments	40
4.6.4	Test Procedure	40
4.6.5	Deviation from Test Standard	40
4.6.6	Test Results	41
4.7	Maximum Output Power.....	42
4.7.1	Limits of Maximum Output Power Measurement	42
4.7.2	Test Setup.....	42
4.7.3	Test Instruments	42
4.7.4	Test Procedure	42
4.7.5	Deviation from Test Standard	42
4.7.6	EUT Operating Condition	42
4.7.7	Test Results	43
4.8	Conducted Out of Band Emission Measurement.....	44
4.8.1	Limits of Conducted Out of Band Emission Measurement.....	44
4.8.2	Test Instruments	44
4.8.3	Test Procedure	44
4.8.4	Deviation from Test Standard	44
4.8.5	Eut Operating Condition	44
4.8.6	Test Results	44
5	Pictures of Test Arrangements.....	47
	Appendix – Information on the Testing Laboratories	48



Release Control Record

Issue No.	Description	Date Issued
RF160509E03A-2	Original release.	Sep. 02, 2016

1 Certificate of Conformity

Product: Terminal

Brand: XAC

Test Model: xCE_E200I-10YXX

Sample Status: ENGINEERING SAMPLE

Applicant: XAC AUTOMATION CORP.

Test Date: June 03 to Aug. 15, 2016

Standards: 47 CFR FCC Part 15, Subpart C (Section 15.247)
ANSI C63.10: 2013

The above equipment has been tested by **Bureau Veritas Consumer Products Services (H.K.) Ltd., Taoyuan Branch**, and found compliance with the requirement of the above standards. The test record, data evaluation & Equipment Under Test (EUT) configurations represented herein are true and accurate accounts of the measurements of the sample's EMC characteristics under the conditions specified in this report.

Prepared by :



Claire Kuan / Specialist

Date: Sep. 02, 2016

Approved by :



May Chen / Manager

Date: Sep. 02, 2016

2 Summary of Test Results

47 CFR FCC Part 15, Subpart C (SECTION 15.247)			
FCC Clause	Test Item	Result	Remarks
15.207	AC Power Conducted Emission	PASS	Meet the requirement of limit. Minimum passing margin is -3.04dB at 0.43516MHz.
15.247(a)(1)(iii)	Number of Hopping Frequency Used	PASS	Meet the requirement of limit.
15.247(a)(1)(iii)	Dwell Time on Each Channel	PASS	Meet the requirement of limit.
15.247(a)(1)	1. Hopping Channel Separation 2. Spectrum Bandwidth of a Frequency Hopping Sequence Spread Spectrum System	PASS	Meet the requirement of limit.
15.247(b)	Maximum Peak Output Power	PASS	Meet the requirement of limit.
15.205 & 209 & 15.247(d)	Radiated Emissions & Band Edge Measurement	PASS	Meet the requirement of limit. Minimum passing margin is -3.1dB at 125.00MHz.
15.247(d)	Antenna Port Emission	PASS	Meet the requirement of limit.
15.203	Antenna Requirement	PASS	No antenna connector is used.

NOTE: If The Frequency Hopping System operating in 2400-2483.5MHz band and the output power less than 125mW. The hopping channel carrier frequencies separated by a minimum of 25kHz or two-thirds of the 20dB bandwidth of hopping channel whichever is greater.

2.1 Measurement Uncertainty

Where relevant, the following measurement uncertainty levels have been estimated for tests performed on the EUT as specified in CISPR 16-4-2:

Measurement	Frequency	Expanded Uncertainty (k=2) (\pm)
Conducted Emissions at mains ports	150kHz ~ 30MHz	1.83 dB
Radiated Emissions up to 1 GHz	30MHz ~ 1GHz	5.37 dB
Radiated Emissions above 1 GHz	1GHz ~ 6GHz	3.65 dB
	6GHz ~ 18GHz	3.88 dB
	18GHz ~ 40GHz	4.11 dB

2.2 Modification Record

There were no modifications required for compliance.

3 General Information

3.1 General Description of EUT (BT-EDR)

Product	Terminal
Brand	XAC
Test Model	xCE_E200I-10YXX
Status of EUT	ENGINEERING SAMPLE
Power Supply Rating	DC 24V
Modulation Type	GFSK, $\pi/4$ -DQPSK, 8DPSK
Modulation Technology	FHSS
Transfer Rate	Up to 3Mbps
Operating Frequency	2402MHz ~ 2480MHz
Number of Channel	79
Output Power	11.455mW
Antenna Type	Refer to Note
Antenna Connector	Refer to Note
Accessory Device	Adapter (Optional) x 1
Data Cable Supplied	NA

Note:

1. There are WLAN and Bluetooth technology used for the EUT.
2. For WLAN: 2.4GHz & 5GHz technology cannot transmit at same time.
3. WLAN and Bluetooth coexistence mode:

Condition	Technology	
1	WLAN (2.4GHz)	Bluetooth
2	WLAN (5GHz)	Bluetooth

Note: The emission of the simultaneous operation has been evaluated and no non-compliance was found.

4. The EUT power needs to be supplied from one power adapter, the information is as below table:

Brand	Model No.	Spec.
FSP GROUP INC	FSP060-DAAN2	Input: 100-240Vac, 1.5A, 50-60Hz Output: 24V, 2.5A DC cable: unshielded, 1.5m with one core

5. The antenna provided to the EUT, please refer to the following table:

Brand	Model	Antenna Type	Connector Type	Antenna Gain(dBi)	Frequency range
INPAQ	ACM3-5036-A1-CC-S	Chip	NA	3	2.4~2.4835GHz 5.15~5.85GHz

6. The EUT could be supplied with one transformer and following two different transformers could be chosen:

Transformer	Manufacturer	Part number
Main source	Linkcom Mfg Co., Ltd.	LAN0019-01
2nd source	Dong Guan TNK Industry Co., Ltd.	LSQ098

From the above transformer, the Main source was the worst case and it was selected as representative model for the test and its data was recorded in this report.

7. The above EUT information is declared by manufacturer and for more detailed features description, please refer to the manufacturer's specifications or user's manual.

3.2 Description of Test Modes

79 channels are provided for BT-EDR mode:

Channel	Freq. (MHz)	Channel	Freq. (MHz)	Channel	Freq. (MHz)	Channel	Freq. (MHz)
0	2402	20	2422	40	2442	60	2462
1	2403	21	2423	41	2443	61	2463
2	2404	22	2424	42	2444	62	2464
3	2405	23	2425	43	2445	63	2465
4	2406	24	2426	44	2446	64	2466
5	2407	25	2427	45	2447	65	2467
6	2408	26	2428	46	2448	66	2468
7	2409	27	2429	47	2449	67	2469
8	2410	28	2430	48	2450	68	2470
9	2411	29	2431	49	2451	69	2471
10	2412	30	2432	50	2452	70	2472
11	2413	31	2433	51	2453	71	2473
12	2414	32	2434	52	2454	72	2474
13	2415	33	2435	53	2455	73	2475
14	2416	34	2436	54	2456	74	2476
15	2417	35	2437	55	2457	75	2477
16	2418	36	2438	56	2458	76	2478
17	2419	37	2439	57	2459	77	2479
18	2420	38	2440	58	2460	78	2480
19	2421	39	2441	59	2461		

3.2.1 Test Mode Applicability and Tested Channel Detail

EUT CONFIGURE MODE	APPLICABLE TO				DESCRIPTION
	RE≥1G	RE<1G	PLC	APCM	
-	√	√	√	√	-

Where **RE≥1G**: Radiated Emission above 1GHz **RE<1G**: Radiated Emission below 1GHz
PLC: Power Line Conducted Emission **APCM**: Antenna Port Conducted Measurement

- NOTE:** 1. "-" means no effect.
2. The EUT's monitor had been pre-tested on the positioned of each 3 axis. The worst case was found when positioned on **Z-plane**.

Radiated Emission Test (Above 1GHz):

- Pre-Scan has been conducted to determine the worst-case mode from all possible combinations between available modulations, data rates and antenna ports (if EUT with antenna diversity architecture).
- Following channel(s) was (were) selected for the final test as listed below.

AVAILABLE CHANNEL	TESTED CHANNEL	MODULATION TECHNOLOGY	MODULATION TYPE	PACKET TYPE
0 to 78	0, 39, 78	FHSS	GFSK	DH5
0 to 78	0, 39, 78	FHSS	8DPSK	3DH5

Radiated Emission Test (Below 1GHz):

- Pre-Scan has been conducted to determine the worst-case mode from all possible combinations between available modulations, data rates and antenna ports (if EUT with antenna diversity architecture).
- Following channel(s) was (were) selected for the final test as listed below.

AVAILABLE CHANNEL	TESTED CHANNEL	MODULATION TECHNOLOGY	MODULATION TYPE	PACKET TYPE
0 to 78	78	FHSS	GFSK	DH5

Power Line Conducted Emission Test:

- Pre-Scan has been conducted to determine the worst-case mode from all possible combinations between available modulations, data rates and antenna ports (if EUT with antenna diversity architecture).
- Following channel(s) was (were) selected for the final test as listed below.

AVAILABLE CHANNEL	TESTED CHANNEL	MODULATION TECHNOLOGY	MODULATION TYPE	PACKET TYPE
0 to 78	78	FHSS	GFSK	DH5

Antenna Port Conducted Measurement:

- This item includes all test value of each mode, but only includes spectrum plot of worst value of each mode.
- Pre-Scan has been conducted to determine the worst-case mode from all possible combinations between available modulations, data rates and antenna ports (if EUT with antenna diversity architecture).
- Following channel(s) was (were) selected for the final test as listed below.

AVAILABLE CHANNEL	TESTED CHANNEL	MODULATION TECHNOLOGY	MODULATION TYPE	PACKET TYPE
0 to 78	0, 39, 78	FHSS	GFSK	DH5
0 to 78	0, 39, 78	FHSS	8DPSK	3DH5

Test Condition:

APPLICABLE TO	ENVIRONMENTAL CONDITIONS	INPUT POWER	TESTED BY
RE \geq 1G	25deg. C, 65%RH	120Vac, 60Hz	JyunChun Lin
RE<1G	25deg. C, 65%RH	120Vac, 60Hz	JyunChun Lin
PLC	24deg. C, 59%RH	120Vac, 60Hz	Bear Lee Arthur Yang
	23deg. C, 79%RH		
APCM	23deg. C, 65%RH	120Vac, 60Hz	Anderson Chen

3.3 Description of Support Units

The EUT has been tested as an independent unit together with other necessary accessories or support units. The following support units or accessories were used to form a representative test configuration during the tests.

ID	Product	Brand	Model No.	Serial No.	FCC ID	Remarks
A.	iPod	Apple	MD778TA/A	CC4JMCXF4T1	NA	Provided by Lab
B.	iPod	Apple	MD778TA/A	CC4JMJU0F4T1	NA	Provided by Lab
C.	iPod	Apple	MD778TA/A	CC4JD4CDF4T1	NA	Provided by Lab
D.	iPod	Apple	MD778TA/A	CC4JMJV2F4T1	NA	Provided by Lab
E.	iPod	Apple	MD778TA/A	CC4JMJTYP4T1	NA	Provided by Lab
F.	Notebook computer	DELL	PP32LA	GSLB32S	FCC DoC	Provided by Lab
G.	Print	XAC	TP72-SA	NA	NA	Supplied by client
H.	Adapter	FSP	FSP120-AAAN2	NA	NA	Supplied by client

Note:

1. All power cords of the above support units are non-shielded (1.8m).

ID	Descriptions	Qty.	Length (m)	Shielding (Yes/No)	Cores (Qty.)	Remarks
1.	DC	1	1	Yes	0	Supplied by client
2.	AC	1	1.8	No	0	Supplied by client
3.	RJ 11	1	1.5	No	0	Supplied by client
4.	RJ11 to RS232	1	1.5	No	0	Supplied by client
5.	RJ45	1	10	No	0	Supplied by client
6.	RJ11 to RS232	1	1.5	No	0	Supplied by client
7.	RJ11 to RS232	1	1.5	No	0	Supplied by client
8.	USB	1	0.1	Yes	0	Provided by Lab
9.	USB	1	0.1	Yes	0	Provided by Lab
10.	USB	1	0.1	Yes	0	Provided by Lab
11.	USB	1	0.1	Yes	0	Provided by Lab
12.	USB	1	0.1	Yes	0	Provided by Lab
13.	USB	1	1.8	Yes	0	Supplied by client
14.	DC	1	1	No	0	Supplied by client
15.	DC	1	1.6	No	0	Supplied by client
16.	AC	1	1.8	No	0	Supplied by client

3.3.1 Configuration of System under Test

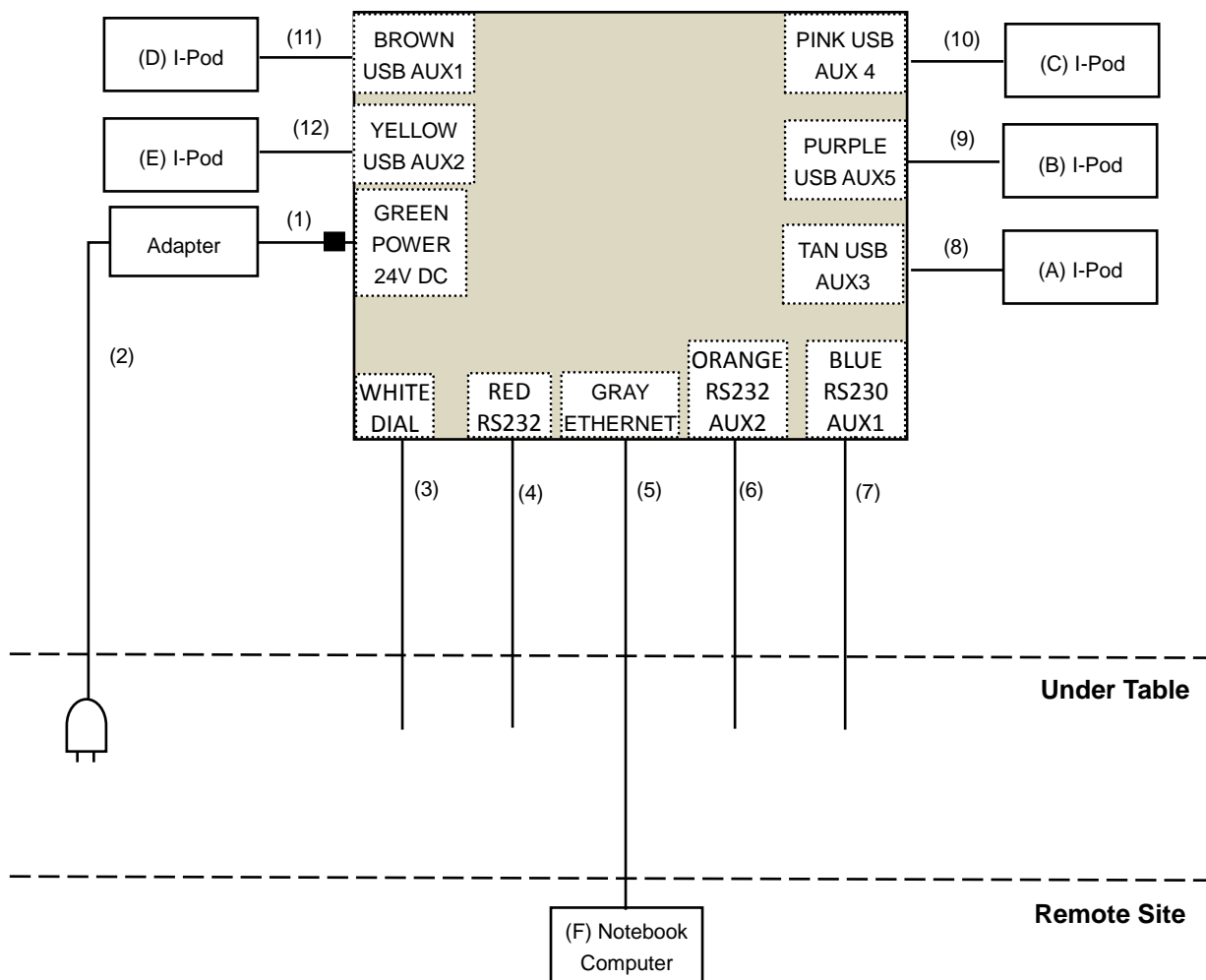

3.4 General Description of Applied Standards

The EUT is a RF Product. According to the specifications of the manufacturer, it must comply with the requirements of the following standards:

FCC Part 15, Subpart C (15.247)

ANSI C63.10-2013

All test items have been performed and recorded as per the above standards.

4 Test Types and Results

4.1 Radiated Emission and Bandedge Measurement

4.1.1 Limits of Radiated Emission and Bandedge Measurement

Radiated emissions which fall in the restricted bands must comply with the radiated emission limits specified as below table. Other emissions shall be at least 20dB below the highest level of the desired power:

Frequencies (MHz)	Field Strength (microvolts/meter)	Measurement Distance (meters)
0.009 ~ 0.490	2400/F(kHz)	300
0.490 ~ 1.705	24000/F(kHz)	30
1.705 ~ 30.0	30	30
30 ~ 88	100	3
88 ~ 216	150	3
216 ~ 960	200	3
Above 960	500	3

NOTE:

1. The lower limit shall apply at the transition frequencies.
2. Emission level (dBuV/m) = 20 log Emission level (uV/m).
3. For frequencies above 1000MHz, the field strength limits are based on average detector, however, the peak field strength of any emission shall not exceed the maximum permitted average limits, specified above by more than 20dB under any condition of modulation.

4.1.2 Test Instruments

For below 1GHz test:

DESCRIPTION & MANUFACTURER	MODEL NO.	SERIAL NO.	CALIBRATED DATE	CALIBRATED UNTIL
Test Receiver Agilent	N9038A	MY51210105	July 06, 2016	July 05, 2017
Pre-Amplifier ^(*) EMCI	EMC001340	980142	Jan. 20, 2016	Jan. 19, 2018
Loop Antenna ^(*) Electro-Metrics	EM-6879	264	Dec. 16, 2014	Dec. 15, 2016
RF Cable	NA	LOOPCAB-001 LOOPCAB-002	Jan. 18, 2016	Jan. 17, 2017
Pre-Amplifier Mini-Circuits	ZFL-1000VH2 B	AMP-ZFL-03	Nov. 11, 2015	Nov. 10, 2016
Trilog Broadband Antenna SCHWARZBECK	VULB 9168	9168-360	Jan. 04, 2016	Jan. 03, 2017
RF Cable	8D-FB	CHGCAB-001 -1 CHGCAB-001 -2	Oct. 03, 2015	Oct. 02, 2016
	RF-141	CHGCAB-004	Oct. 03, 2015	Oct. 02, 2016
Software	ADT_Radiated _V8.7.07	NA	NA	NA
Antenna Tower & Turn Table CT	CM100	NA	NA	NA

Note:

1. The calibration interval of the above test instruments is 12 months and the calibrations are traceable to NML/ROC and NIST/USA.
2. *The calibration interval of the above test instruments is 24 months and the calibrations are traceable to NML/ROC and NIST/USA.
3. The test was performed in 966 Chamber No. G.
4. The FCC Site Registration No. is 966073.
5. The CANADA Site Registration No. is IC 7450H-2.
6. Tested Date: Aug. 15, 2016

For other items:

DESCRIPTION & MANUFACTURER	MODEL NO.	SERIAL NO.	CALIBRATED DATE	CALIBRATED UNTIL
Test Receiver Agilent	N9038A	MY51210105	July 24, 2015	July 23, 2016
Horn_Antenna AISI	AIH.8018	000032009111 0	Jan. 19, 2016	Jan. 18, 2017
Pre-Amplifier Agilent	8449B	3008A02578	June 23, 2015	June 22, 2016
RF Cable	NA	131205 131216 131217 SNMY23684/ 4	Jan. 15, 2016	Jan. 14, 2017
Spectrum Analyzer Agilent	E4446A	MY48250254	Nov. 25, 2015	Nov. 24, 2016
Pre-Amplifier SPACEK LABS	SLKKa-48-6	9K16	Dec. 11, 2015	Dec. 10, 2016
Horn_Antenna SCHWARZBECK	BBHA 9170	9170-424	Jan. 18, 2016	Jan. 17, 2017
RF Cable	SUCOFLEX 102	36442/2 36434/2	Dec. 10, 2015	Dec.09, 2016
Software	ADT_Radiated _V8.7.07	NA	NA	NA
Antenna Tower & Turn Table CT	CM100	NA	NA	NA
Boresight Antenna Fixture	FBA-01	FBA-WD01	NA	NA
Spectrum Analyzer R&S	FSP40	100060	May 11, 2016	May 10, 2017

Note:

1. The calibration interval of the above test instruments is 12 months and the calibrations are traceable to NML/ROC and NIST/USA.
2. The test was performed in 966 Chamber No. G.
3. The FCC Site Registration No. is 966073.
4. The CANADA Site Registration No. is IC 7450H-2.
5. Tested Date: June 03 to 07, 2016

4.1.3 Test Procedures

- a. The EUT was placed on the top of a rotating table 0.8 meters (for below 1GHz) / 1.5 meters (for above 1GHz) above the ground at 3 meter chamber room for test. The table was rotated 360 degrees to determine the position of the highest radiation.
- b. The EUT was set 3 meters away from the interference-receiving antenna, which was mounted on the top of a variable-height antenna tower.
- c. The height of antenna is varied from one meter to four meters above the ground to determine the maximum value of the field strength. Both horizontal and vertical polarizations of the antenna are set to make the measurement.
- d. For each suspected emission, the EUT was arranged to its worst case and then the antenna was tuned to heights from 1 meter to 4 meters and the rotatable table was turned from 0 degrees to 360 degrees to find the maximum reading.
- e. The test-receiver system was set to quasi-peak detect function and specified bandwidth with maximum hold mode when the test frequency is below 1 GHz.
- f. The test-receiver system was set to peak detect function and specified bandwidth with maximum hold mode when the test frequency is above 1 GHz.

Note:

1. The resolution bandwidth and video bandwidth of test receiver/spectrum analyzer is 120kHz for Quasi-peak detection (QP) at frequency below 1GHz.
2. The resolution bandwidth of test receiver/spectrum analyzer is 1 MHz and the video bandwidth is 3 MHz for Peak detection (PK) at frequency above 1GHz.
3. For Average measurement, due to the DH5 packet was the worse case duty cycle for a transmit dwell time on a channel, based upon bluetooth theory the transmitter is on $0.625 * 5$ per 296.25 ms per channel. Therefore, the duty cycle correlation factor be equal to: $20\log(3.125 / 100) = -30.1$ dB, therefore Average value = peak reading + $20\log(\text{duty cycle})$.
4. All modes of operation were investigated and the worst-case emissions are reported.

4.1.4 Deviation from Test Standard

No deviation.

4.1.5 Test Setup

<Frequency Range below 1GHz>

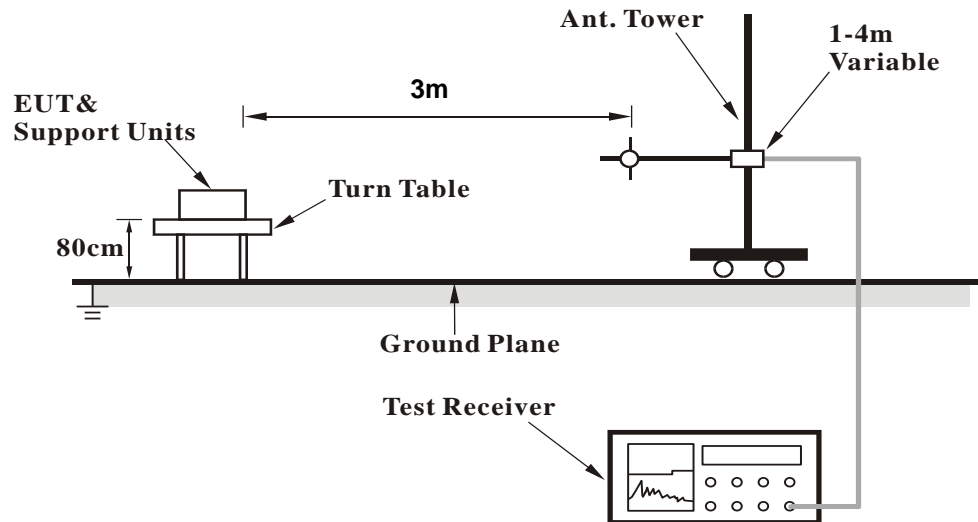

<Frequency Range above 1GHz>

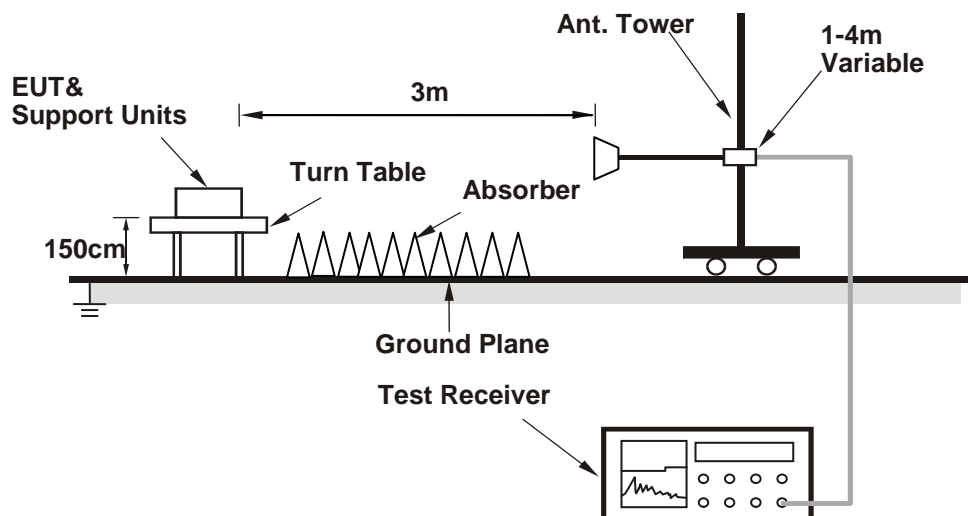

For the actual test configuration, please refer to the attached file (Test Setup Photo).

4.1.6 EUT Operating Conditions

1. Connect the EUT with the support unit F (Notebook Computer) which is placed on remote site.
2. The communication partner run test program "Run hypertrm terminal paste command" to enable EUT under transmission/receiving condition continuously at specific channel frequency.

4.1.7 Test Results

Above 1GHz Data:

BT_GFSK

CHANNEL	TX Channel 0	DETECTOR FUNCTION	Peak (PK)
FREQUENCY RANGE	1GHz ~ 25GHz		

ANTENNA POLARITY & TEST DISTANCE: HORIZONTAL AT 3 M								
NO.	FREQ. (MHz)	EMISSION LEVEL (dBuV/m)	LIMIT (dBuV/m)	MARGIN (dB)	ANTENNA HEIGHT (m)	TABLE ANGLE (Degree)	RAW VALUE (dBuV)	CORRECTION FACTOR (dB/m)
1	2390.00	54.1 PK	74.0	-19.9	1.58 H	242	53.5	0.6
2	2390.00	24.0 AV	54.0	-30.0	1.58 H	242	23.4	0.6
3	*2402.00	103.2 PK			1.58 H	242	102.5	0.7
4	*2402.00	73.1 AV			1.58 H	242	72.4	0.7
5	4804.00	63.6 PK	74.0	-10.4	1.53 H	336	54.5	9.1
6	4804.00	33.5 AV	54.0	-20.5	1.53 H	336	24.4	9.1

ANTENNA POLARITY & TEST DISTANCE: VERTICAL AT 3 M								
NO.	FREQ. (MHz)	EMISSION LEVEL (dBuV/m)	LIMIT (dBuV/m)	MARGIN (dB)	ANTENNA HEIGHT (m)	TABLE ANGLE (Degree)	RAW VALUE (dBuV)	CORRECTION FACTOR (dB/m)
1	2390.00	58.9 PK	74.0	-15.1	1.45 V	341	58.3	0.6
2	2390.00	28.8 AV	54.0	-25.2	1.45 V	341	28.2	0.6
3	*2402.00	108.8 PK			1.45 V	341	108.1	0.7
4	*2402.00	78.7 AV			1.45 V	341	78.0	0.7
5	4804.00	64.6 PK	74.0	-9.4	1.65 V	44	55.5	9.1
6	4804.00	34.5 AV	54.0	-19.5	1.65 V	44	25.4	9.1

REMARKS:

1. Emission Level(dBuV/m) = Raw Value(dBuV) + Correction Factor(dB/m)
2. Correction Factor(dB/m) = Antenna Factor(dB/m) + Cable Factor(dB) – Pre-Amplifier Factor(dB)
3. The other emission levels were very low against the limit.
4. Margin value = Emission Level – Limit value
5. " * ": Fundamental frequency.
6. The DH5 packet was the worse case duty cycle for a transmit dwell time on a channel, based upon bluetooth theory the transmitter is on 0.625 * 5 per 296.25 ms per channel. Therefore, the duty cycle correlation factor be equal to: $20\log(3.125 / 100) = -30.1$ dB
7. Average value = peak reading + $20\log(\text{duty cycle})$.

CHANNEL	TX Channel 39	DETECTOR FUNCTION	Peak (PK)
FREQUENCY RANGE	1GHz ~ 25GHz		

ANTENNA POLARITY & TEST DISTANCE: HORIZONTAL AT 3 M

NO.	FREQ. (MHz)	EMISSION LEVEL (dBuV/m)	LIMIT (dBuV/m)	MARGIN (dB)	ANTENNA HEIGHT (m)	TABLE ANGLE (Degree)	RAW VALUE (dBuV)	CORRECTION FACTOR (dB/m)
1	*2441.00	103.4 PK			1.56 H	245	102.6	0.8
2	*2441.00	73.3 AV			1.56 H	245	72.5	0.8
3	4882.00	63.2 PK	74.0	-10.8	1.50 H	343	53.8	9.4
4	4882.00	33.1 AV	54.0	-20.9	1.50 H	343	23.7	9.4
5	7323.00	58.3 PK	74.0	-15.7	1.46 H	273	41.9	16.4
6	7323.00	28.2 AV	54.0	-25.8	1.46 H	273	11.8	16.4

ANTENNA POLARITY & TEST DISTANCE: VERTICAL AT 3 M

NO.	FREQ. (MHz)	EMISSION LEVEL (dBuV/m)	LIMIT (dBuV/m)	MARGIN (dB)	ANTENNA HEIGHT (m)	TABLE ANGLE (Degree)	RAW VALUE (dBuV)	CORRECTION FACTOR (dB/m)
1	*2441.00	108.7 PK			1.54 V	360	107.9	0.8
2	*2441.00	78.6 AV			1.54 V	360	77.8	0.8
3	4882.00	65.0 PK	74.0	-9.0	1.64 V	32	55.6	9.4
4	4882.00	34.9 AV	54.0	-19.1	1.64 V	32	25.5	9.4
5	7323.00	58.4 PK	74.0	-15.6	1.51 V	314	42.0	16.4
6	7323.00	28.3 AV	54.0	-25.7	1.51 V	314	11.9	16.4

REMARKS:

- Emission Level(dBuV/m) = Raw Value(dBuV) + Correction Factor(dB/m)
- Correction Factor(dB/m) = Antenna Factor(dB/m) + Cable Factor(dB) – Pre-Amplifier Factor(dB)
- The other emission levels were very low against the limit.
- Margin value = Emission Level – Limit value
- " * ": Fundamental frequency.
- The DH5 packet was the worse case duty cycle for a transmit dwell time on a channel, based upon bluetooth theory the transmitter is on 0.625 * 5 per 296.25 ms per channel. Therefore, the duty cycle correlation factor be equal to: $20\log(3.125 / 100) = -30.1 \text{ dB}$
- Average value = peak reading + $20\log(\text{duty cycle})$.

CHANNEL	TX Channel 78	DETECTOR FUNCTION	Peak (PK)
FREQUENCY RANGE	1GHz ~ 25GHz		

ANTENNA POLARITY & TEST DISTANCE: HORIZONTAL AT 3 M

NO.	FREQ. (MHz)	EMISSION LEVEL (dBuV/m)	LIMIT (dBuV/m)	MARGIN (dB)	ANTENNA HEIGHT (m)	TABLE ANGLE (Degree)	RAW VALUE (dBuV)	CORRECTION FACTOR (dB/m)
1	*2480.00	103.3 PK			1.58 H	244	102.4	0.9
2	*2480.00	73.2 AV			1.58 H	244	72.3	0.9
3	2483.50	53.1 PK	74.0	-20.9	1.58 H	244	52.2	0.9
4	2483.50	23.0 AV	54.0	-31.0	1.58 H	244	22.1	0.9
5	4960.00	63.0 PK	74.0	-11.0	1.44 H	345	53.5	9.5
6	4960.00	32.9 AV	54.0	-21.1	1.44 H	345	23.4	9.5
7	7440.00	58.7 PK	74.0	-15.3	1.49 H	301	42.7	16.0
8	7440.00	28.6 AV	54.0	-25.4	1.49 H	301	12.6	16.0

ANTENNA POLARITY & TEST DISTANCE: VERTICAL AT 3 M

NO.	FREQ. (MHz)	EMISSION LEVEL (dBuV/m)	LIMIT (dBuV/m)	MARGIN (dB)	ANTENNA HEIGHT (m)	TABLE ANGLE (Degree)	RAW VALUE (dBuV)	CORRECTION FACTOR (dB/m)
1	*2480.00	108.9 PK			1.50 V	352	108.0	0.9
2	*2480.00	78.8 AV			1.50 V	352	77.9	0.9
3	2483.50	57.8 PK	74.0	-16.2	1.50 V	352	56.9	0.9
4	2483.50	27.7 AV	54.0	-26.3	1.50 V	352	26.8	0.9
5	4960.00	65.1 PK	74.0	-8.9	1.67 V	35	55.6	9.5
6	4960.00	35.0 AV	54.0	-19.0	1.67 V	35	25.5	9.5
7	7440.00	58.8 PK	74.0	-15.2	1.55 V	320	42.8	16.0
8	7440.00	28.7 AV	54.0	-25.3	1.55 V	320	12.7	16.0

REMARKS:

- Emission Level(dBuV/m) = Raw Value(dBuV) + Correction Factor(dB/m)
- Correction Factor(dB/m) = Antenna Factor(dB/m) + Cable Factor(dB) – Pre-Amplifier Factor(dB)
- The other emission levels were very low against the limit.
- Margin value = Emission Level – Limit value
- " * ": Fundamental frequency.
- The DH5 packet was the worse case duty cycle for a transmit dwell time on a channel, based upon bluetooth theory the transmitter is on 0.625 * 5 per 296.25 ms per channel. Therefore, the duty cycle correlation factor be equal to: $20\log(3.125 / 100) = -30.1 \text{ dB}$
- Average value = peak reading + $20\log(\text{duty cycle})$.

BT_8DPSK

CHANNEL	TX Channel 0	DETECTOR FUNCTION	Peak (PK)
FREQUENCY RANGE	1GHz ~ 25GHz		

ANTENNA POLARITY & TEST DISTANCE: HORIZONTAL AT 3 M

NO.	FREQ. (MHz)	EMISSION LEVEL (dBuV/m)	LIMIT (dBuV/m)	MARGIN (dB)	ANTENNA HEIGHT (m)	TABLE ANGLE (Degree)	RAW VALUE (dBuV)	CORRECTION FACTOR (dB/m)
1	2390.00	53.8 PK	74.0	-20.2	1.57 H	252	53.2	0.6
2	2390.00	23.7 AV	54.0	-30.3	1.57 H	252	23.1	0.6
3	*2402.00	100.4 PK			1.57 H	252	99.7	0.7
4	*2402.00	70.3 AV			1.57 H	252	69.6	0.7
5	4804.00	58.4 PK	74.0	-15.6	1.51 H	341	49.3	9.1
6	4804.00	28.3 AV	54.0	-25.7	1.51 H	341	19.2	9.1

ANTENNA POLARITY & TEST DISTANCE: VERTICAL AT 3 M

NO.	FREQ. (MHz)	EMISSION LEVEL (dBuV/m)	LIMIT (dBuV/m)	MARGIN (dB)	ANTENNA HEIGHT (m)	TABLE ANGLE (Degree)	RAW VALUE (dBuV)	CORRECTION FACTOR (dB/m)
1	2390.00	58.7 PK	74.0	-15.3	1.60 V	355	58.1	0.6
2	2390.00	28.6 AV	54.0	-25.4	1.60 V	355	28.0	0.6
3	*2402.00	105.8 PK			1.60 V	355	105.1	0.7
4	*2402.00	75.7 AV			1.60 V	355	75.0	0.7
5	4804.00	60.5 PK	74.0	-13.5	1.58 V	24	51.4	9.1
6	4804.00	30.4 AV	54.0	-23.6	1.58 V	24	21.3	9.1

REMARKS:

1. Emission Level(dBuV/m) = Raw Value(dBuV) + Correction Factor(dB/m)
2. Correction Factor(dB/m) = Antenna Factor(dB/m) + Cable Factor(dB) – Pre-Amplifier Factor(dB)
3. The other emission levels were very low against the limit.
4. Margin value = Emission Level – Limit value
5. " * ": Fundamental frequency.
6. The DH5 packet was the worse case duty cycle for a transmit dwell time on a channel, based upon bluetooth theory the transmitter is on 0.625 * 5 per 296.25 ms per channel. Therefore, the duty cycle correlation factor be equal to: $20\log(3.125 / 100) = -30.1 \text{ dB}$
7. Average value = peak reading + $20\log(\text{duty cycle})$.

CHANNEL	TX Channel 39	DETECTOR FUNCTION	Peak (PK)
FREQUENCY RANGE	1GHz ~ 25GHz		

ANTENNA POLARITY & TEST DISTANCE: HORIZONTAL AT 3 M								
NO.	FREQ. (MHz)	EMISSION LEVEL (dBuV/m)	LIMIT (dBuV/m)	MARGIN (dB)	ANTENNA HEIGHT (m)	TABLE ANGLE (Degree)	RAW VALUE (dBuV)	CORRECTION FACTOR (dB/m)
1	*2441.00	100.6 PK			1.56 H	234	99.8	0.8
2	*2441.00	70.5 AV			1.56 H	234	69.7	0.8
3	4882.00	58.4 PK	74.0	-15.6	1.49 H	330	49.0	9.4
4	4882.00	28.3 AV	54.0	-25.7	1.49 H	330	18.9	9.4
5	7323.00	58.3 PK	74.0	-15.7	1.45 H	286	41.9	16.4
6	7323.00	28.2 AV	54.0	-25.8	1.45 H	286	11.8	16.4

ANTENNA POLARITY & TEST DISTANCE: VERTICAL AT 3 M								
NO.	FREQ. (MHz)	EMISSION LEVEL (dBuV/m)	LIMIT (dBuV/m)	MARGIN (dB)	ANTENNA HEIGHT (m)	TABLE ANGLE (Degree)	RAW VALUE (dBuV)	CORRECTION FACTOR (dB/m)
1	*2441.00	105.9 PK			1.55 V	343	105.1	0.8
2	*2441.00	75.8 AV			1.55 V	343	75.0	0.8
3	4882.00	60.8 PK	74.0	-13.2	1.62 V	26	51.4	9.4
4	4882.00	30.7 AV	54.0	-23.3	1.62 V	26	21.3	9.4
5	7323.00	58.8 PK	74.0	-15.2	1.53 V	322	42.4	16.4
6	7323.00	28.7 AV	54.0	-25.3	1.53 V	322	12.3	16.4

REMARKS:

1. Emission Level(dBuV/m) = Raw Value(dBuV) + Correction Factor(dB/m)
2. Correction Factor(dB/m) = Antenna Factor(dB/m) + Cable Factor(dB) – Pre-Amplifier Factor(dB)
3. The other emission levels were very low against the limit.
4. Margin value = Emission Level – Limit value
5. " * ": Fundamental frequency.
6. The DH5 packet was the worse case duty cycle for a transmit dwell time on a channel, based upon bluetooth theory the transmitter is on 0.625 * 5 per 296.25 ms per channel. Therefore, the duty cycle correlation factor be equal to: $20\log(3.125 / 100) = -30.1 \text{ dB}$
7. Average value = peak reading + $20\log(\text{duty cycle})$.

CHANNEL	TX Channel 78	DETECTOR FUNCTION	Peak (PK)
FREQUENCY RANGE	1GHz ~ 25GHz		

ANTENNA POLARITY & TEST DISTANCE: HORIZONTAL AT 3 M

NO.	FREQ. (MHz)	EMISSION LEVEL (dBuV/m)	LIMIT (dBuV/m)	MARGIN (dB)	ANTENNA HEIGHT (m)	TABLE ANGLE (Degree)	RAW VALUE (dBuV)	CORRECTION FACTOR (dB/m)
1	*2480.00	100.5 PK			1.58 H	244	99.6	0.9
2	*2480.00	70.4 AV			1.58 H	244	69.5	0.9
3	2483.50	54.5 PK	74.0	-19.5	1.58 H	244	53.6	0.9
4	2483.50	24.4 AV	54.0	-29.6	1.58 H	244	23.5	0.9
5	4960.00	58.6 PK	74.0	-15.4	1.47 H	330	49.1	9.5
6	4960.00	28.5 AV	54.0	-25.5	1.47 H	330	19.0	9.5
7	7440.00	58.5 PK	74.0	-15.5	1.50 H	285	42.5	16.0
8	7440.00	28.4 AV	54.0	-25.6	1.50 H	285	12.4	16.0

ANTENNA POLARITY & TEST DISTANCE: VERTICAL AT 3 M

NO.	FREQ. (MHz)	EMISSION LEVEL (dBuV/m)	LIMIT (dBuV/m)	MARGIN (dB)	ANTENNA HEIGHT (m)	TABLE ANGLE (Degree)	RAW VALUE (dBuV)	CORRECTION FACTOR (dB/m)
1	*2480.00	105.9 PK			1.50 V	354	105.0	0.9
2	*2480.00	75.8 AV			1.50 V	354	74.9	0.9
3	2483.50	58.2 PK	74.0	-15.8	1.50 V	354	57.3	0.9
4	2483.50	28.1 AV	54.0	-25.9	1.50 V	354	27.2	0.9
5	4960.00	60.6 PK	74.0	-13.4	1.67 V	35	51.1	9.5
6	4960.00	30.5 AV	54.0	-23.5	1.67 V	35	21.0	9.5
7	7440.00	58.4 PK	74.0	-15.6	1.55 V	310	42.4	16.0
8	7440.00	28.3 AV	54.0	-25.7	1.55 V	310	12.3	16.0

REMARKS:

1. Emission Level(dBuV/m) = Raw Value(dBuV) + Correction Factor(dB/m)
2. Correction Factor(dB/m) = Antenna Factor(dB/m) + Cable Factor(dB) – Pre-Amplifier Factor(dB)
3. The other emission levels were very low against the limit.
4. Margin value = Emission Level – Limit value
5. " * ": Fundamental frequency.
6. The DH5 packet was the worse case duty cycle for a transmit dwell time on a channel, based upon bluetooth theory the transmitter is on 0.625 * 5 per 296.25 ms per channel. Therefore, the duty cycle correlation factor be equal to: $20\log(3.125 / 100) = -30.1 \text{ dB}$
7. Average value = peak reading + $20\log(\text{duty cycle})$.

Below 1GHz Data:

BT_GFSK

CHANNEL	TX Channel 78	DETECTOR FUNCTION	Quasi-Peak (QP)
FREQUENCY RANGE	Below 1GHz		

ANTENNA POLARITY & TEST DISTANCE: HORIZONTAL AT 3 M

NO.	FREQ. (MHz)	EMISSION LEVEL (dBuV/m)	LIMIT (dBuV/m)	MARGIN (dB)	ANTENNA HEIGHT (m)	TABLE ANGLE (Degree)	RAW VALUE (dBuV)	CORRECTION FACTOR (dB/m)
1	83.03	31.4 QP	40.0	-8.6	2.00 H	341	44.7	-13.3
2	124.99	32.9 QP	43.5	-10.6	1.50 H	250	42.5	-9.6
3	258.60	32.3 QP	46.0	-13.7	1.00 H	40	40.7	-8.4
4	387.95	36.6 QP	46.0	-9.4	2.00 H	10	41.0	-4.4
5	480.03	34.6 QP	46.0	-11.4	2.00 H	243	36.4	-1.8
6	756.02	37.1 QP	46.0	-8.9	1.00 H	149	33.0	4.1

ANTENNA POLARITY & TEST DISTANCE: VERTICAL AT 3 M

NO.	FREQ. (MHz)	EMISSION LEVEL (dBuV/m)	LIMIT (dBuV/m)	MARGIN (dB)	ANTENNA HEIGHT (m)	TABLE ANGLE (Degree)	RAW VALUE (dBuV)	CORRECTION FACTOR (dB/m)
1	108.01	35.1 QP	43.5	-8.4	1.50 V	360	46.2	-11.1
2	258.63	33.7 QP	46.0	-12.3	2.00 V	360	42.1	-8.4
3	440.41	32.1 QP	46.0	-13.9	1.00 V	75	34.6	-2.5
4	480.03	30.7 QP	46.0	-15.3	1.00 V	222	32.5	-1.8
5	756.04	35.5 QP	46.0	-10.5	2.00 V	111	31.4	4.1
6	828.02	33.9 QP	46.0	-12.1	1.00 V	65	28.9	5.0

REMARKS:

1. Emission Level(dBuV/m) = Raw Value(dBuV) + Correction Factor(dB/m)
2. Correction Factor(dB/m) = Antenna Factor(dB/m) + Cable Factor(dB) – Pre-Amplifier Factor(dB)
3. The other emission levels were very low against the limit.
4. Margin value = Emission Level – Limit value

4.2 Conducted Emission Measurement

4.2.1 Limits of Conducted Emission Measurement

Frequency (MHz)	Conducted Limit (dBuV)	
	Quasi-peak	Average
0.15 - 0.5	66 - 56	56 - 46
0.50 - 5.0	56	46
5.0 - 30.0	60	50

Note: 1. The lower limit shall apply at the transition frequencies.

2. The limit decreases in line with the logarithm of the frequency in the range of 0.15 to 0.50MHz.

4.2.2 Test Instruments

DESCRIPTION & MANUFACTURER	MODEL NO.	SERIAL NO.	CALIBRATED DATE	CALIBRATED UNTIL
Test Receiver R&S	ESCS 30	100375	May 09, 2016	May 08, 2017
Line-Impedance Stabilization Network (for EUT) SCHWARZBECK	NSLK-8127	8127-522	Sep. 01, 2015	Aug. 31, 2016
Line-Impedance Stabilization Network (for Peripheral) R&S	ENV216	100072	June 11, 2015	June 10, 2016
RF Cable	5D-FB	COCCAB-001	Mar. 08, 2016	Mar. 07, 2017
10 dB PAD Mini-Circuits	HAT-10+	CONATT-002	Sep. 14, 2015	Sep. 13, 2016
50 ohms Terminator	N/A	EMC-03	Sep. 23, 2015	Sep. 22, 2016
50 ohms Terminator	N/A	EMC-02	Oct. 01, 2015	Sep. 30, 2016
50 ohms Terminator	E1-011315	13	Dec. 11 2015	Dec. 10 2016
Software BVADT	BVADT_Cond_ V7.3.7.3	NA	NA	NA

Note:

1. The calibration interval of the above test instruments are 12 months and the calibrations are traceable to NML/ROC and NIST/USA.
2. The test was performed in Shielded Room No. C.
3. The VCCI Con C Registration No. is C-3611.
4. Tested Date: June 06, 2016

4.2.3 Test Procedures

- The EUT was placed 0.4 meters from the conducting wall of the shielded room with EUT being connected to the power mains through a line impedance stabilization network (LISN). Other support units were connected to the power mains through another LISN. The two LISNs provide 50 ohm/ 50uH of coupling impedance for the measuring instrument.
- Both lines of the power mains connected to the EUT were checked for maximum conducted interference.
- The frequency range from 150kHz to 30MHz was searched. Emission levels under (Limit - 20dB) was not recorded.

NOTE: The resolution bandwidth and video bandwidth of test receiver is 9kHz for quasi-peak detection (QP) and average detection (AV) at frequency 0.15MHz-30MHz.

4.2.4 Deviation From Test Standard

No deviation.

4.2.5 Test Setup

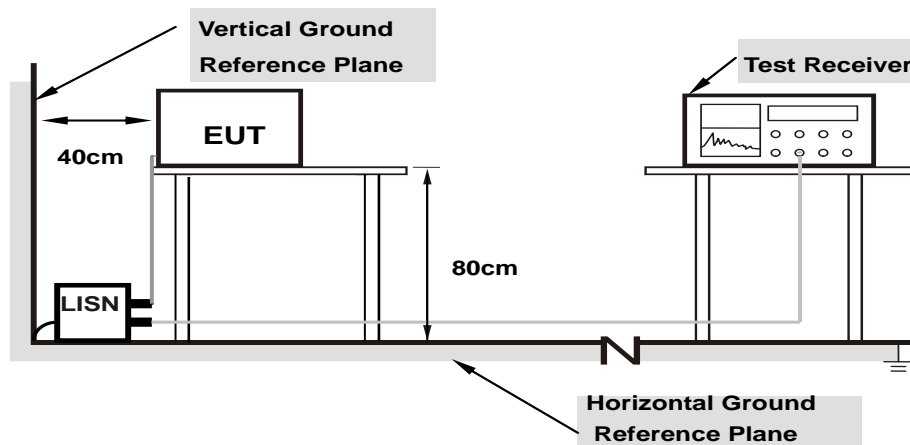

Note: 1.Support units were connected to second LISN.

For the actual test configuration, please refer to the attached file (Test Setup Photo).

4.2.6 EUT Operating Condition

Same as 4.1.6.

4.2.7 Test Results

Phase	Line (L)	Detector Function	Quasi-Peak (QP) / Average (AV)
-------	----------	-------------------	--------------------------------

No	Freq. [MHz]	Corr.	Reading Value		Emission Level		Limit		Margin	
		Factor (dB)	[dB (uV)]		[dB (uV)]		[dB (uV)]		(dB)	
		Q.P.	AV.	Q.P.	AV.	Q.P.	AV.	Q.P.	AV.	Q.P.
1	0.15000	10.32	36.57	22.66	46.89	32.98	66.00	56.00	-19.11	-23.02
2	0.18125	10.30	30.95	16.23	41.25	26.53	64.43	54.43	-23.18	-27.90
3	0.43516	10.30	39.10	33.81	49.40	44.11	57.15	47.15	-7.75	-3.04
4	0.71250	10.26	23.74	18.34	34.00	28.60	56.00	46.00	-22.00	-17.40
5	0.88047	10.24	23.51	18.39	33.75	28.63	56.00	46.00	-22.25	-17.37
6	20.80859	10.97	28.69	26.79	39.66	37.76	60.00	50.00	-20.34	-12.24

REMARKS:

1. Q.P. and AV. are abbreviations of quasi-peak and average individually.
2. The emission levels of other frequencies were very low against the limit.
3. Margin value = Emission level - Limit value
4. Correction factor = Insertion loss + Cable loss
5. Emission Level = Correction Factor + Reading Value

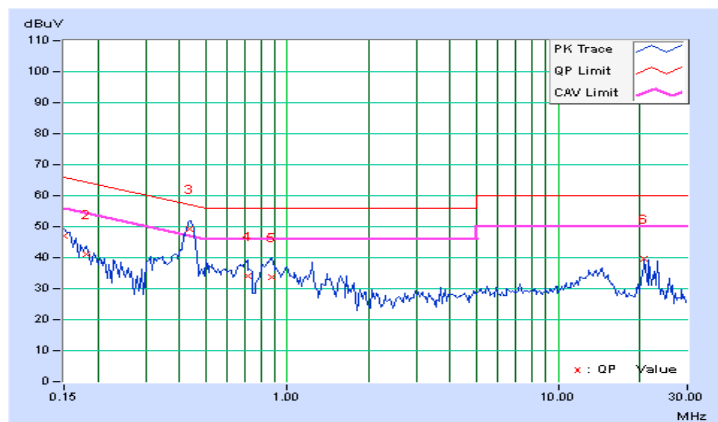

Phase	Neutral (N)	Detector Function	Quasi-Peak (QP) / Average (AV)
-------	-------------	-------------------	--------------------------------

No	Freq. [MHz]	Corr. Factor (dB)	Reading Value		Emission Level		Limit		Margin	
			[dB (uV)]		[dB (uV)]		[dB (uV)]		(dB)	
			Q.P.	AV.	Q.P.	AV.	Q.P.	AV.	Q.P.	AV.
1	0.15000	10.30	36.57	22.58	46.87	32.88	66.00	56.00	-19.13	-23.12
2	0.22422	10.26	25.92	16.51	36.18	26.77	62.66	52.66	-26.48	-25.89
3	0.43516	10.28	38.92	33.39	49.20	43.67	57.15	47.15	-7.95	-3.48
4	0.85703	10.23	22.89	18.82	33.12	29.05	56.00	46.00	-22.88	-16.95
5	4.26563	10.44	13.79	9.11	24.23	19.55	56.00	46.00	-31.77	-26.45
6	20.37891	10.99	25.46	23.44	36.45	34.43	60.00	50.00	-23.55	-15.57

REMARKS:

1. Q.P. and AV. are abbreviations of quasi-peak and average individually.
2. The emission levels of other frequencies were very low against the limit.
3. Margin value = Emission level - Limit value
4. Correction factor = Insertion loss + Cable loss
5. Emission Level = Correction Factor + Reading Value

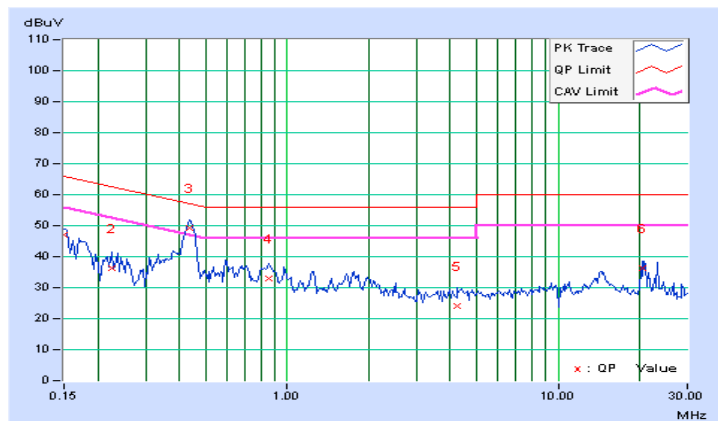

4.3 Number of Hopping Frequency Used

4.3.1 Limits of Hopping Frequency Used Measurement

At least 15 channels frequencies, and should be equally spaced.

4.3.2 Test Setup

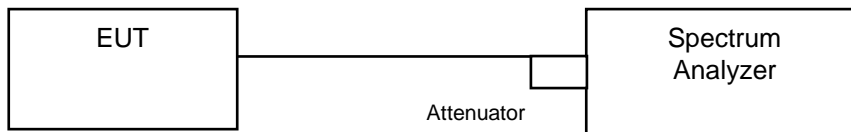

4.3.3 Test Instruments

Refer to section 4.1.2 to get information of above instrument.

4.3.4 Test Procedure

- a. Check the calibration of the measuring instrument (SA) using either an internal calibrator or a known signal from an external generator.
- b. Turn on the EUT and connect its antenna terminal to measurement via a low loss cable. Then set it to any one measured frequency within its operating range and make sure the instrument is operated in its linear range.
- c. Set the SA on MaxHold Mode, and then keep the EUT in hopping mode. Record all the signals from each channel until each one has been recorded.
- d. Set the SA on View mode and then plot the result on SA screen.
- e. Repeat above procedures until all frequencies measured were complete.

4.3.5 Deviation from Test Standard

No deviation.

4.3.6 Test Results

There are 79 hopping frequencies in the hopping mode. Please refer to next page for the test result. On the plots, it shows that the hopping frequencies are equally spaced.

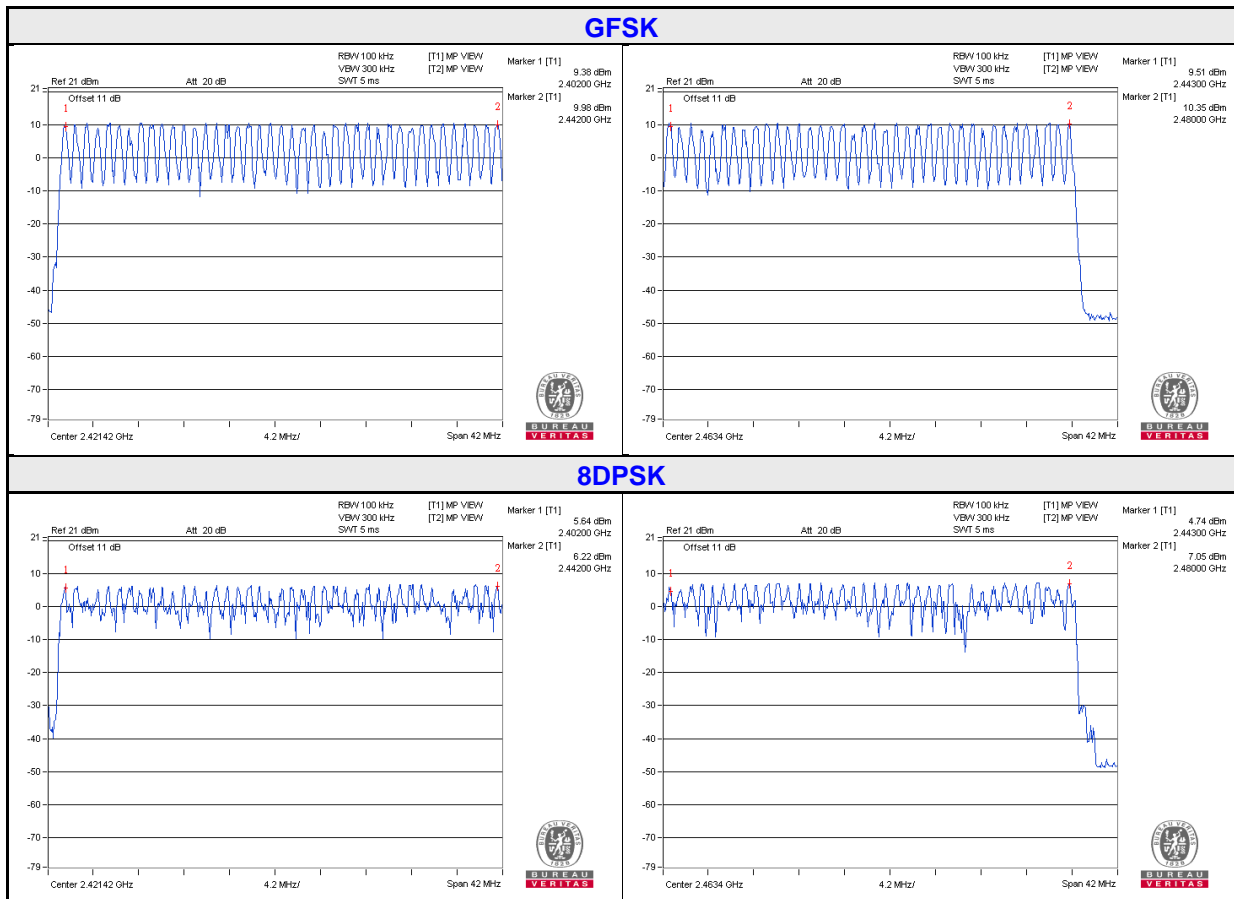

4.4 Dwell Time on Each Channel

4.4.1 Limits of Dwell Time on Each Channel Measurement

The average time of occupancy on any channel shall not be greater than 0.4 seconds within a period of 0.4 seconds multiplied by the number of hopping channels employed.

4.4.2 Test Setup

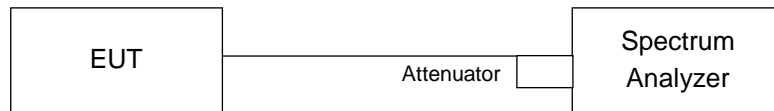

4.4.3 Test Instruments

Refer to section 4.1.2 to get information of above instrument.

4.4.4 Test Procedures

- Check the calibration of the measuring instrument (SA) using either an internal calibrator or a known signal from an external generator.
- Turn on the EUT and connect its antenna terminal to measurement via a low loss cable. Then set it to any one measured frequency within its operating range and make sure the instrument is operated in its linear range.
- Adjust the center frequency of SA on any frequency to be measured and set SA to zero span mode. And then, set RBW and VBW of spectrum analyzer to proper value.
- Measure the time duration of one transmission on the measured frequency. And then plot the result with time difference of this time duration.
- Repeat above procedures until all different time-slot modes have been completed.

4.4.5 Deviation from Test Standard

No deviation.



4.4.6 Test Results

GFSK

Mode	Number of transmission in a 31.6 (79Hopping*0.4)	Length of transmission time (msec)	Result (msec)	Limit (msec)
DH1	50 (times / 5 sec) * 6.32 = 316 times	0.456	144.1	400
DH3	25 (times / 5 sec) * 6.32 = 158 times	1.8	284.4	400
DH5	16 (times / 5 sec) * 6.32 = 101.12 times	3.024	305.79	400

NOTE: Test plots of the transmitting time slot are shown on next page.



BUREAU
VERITAS

DH1

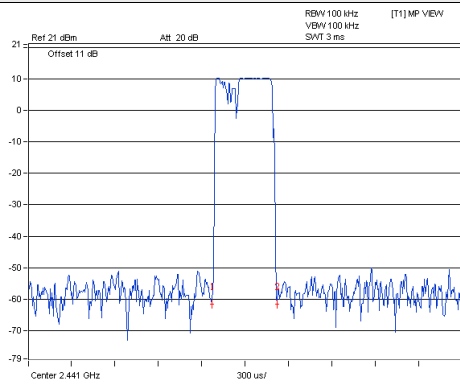
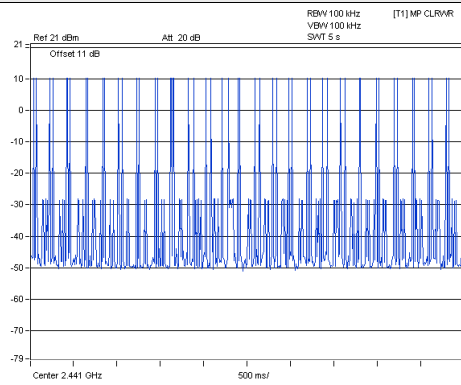

Marker 1 [T1] -61.60 dBm
1.266000 ms
Delta 2 [T1] 0.10 dB
456.000000 us



DH3

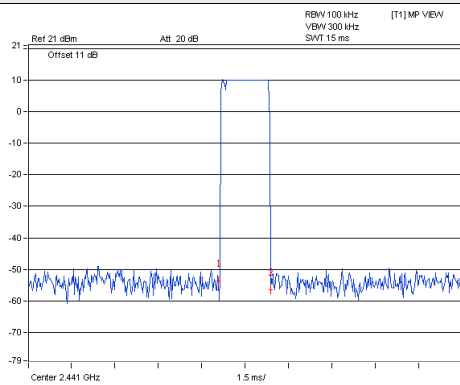
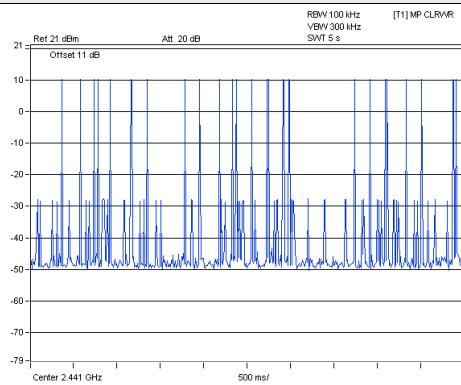

Marker 1 [T1] -53.64 dBm
6.570000 ms
Delta 2 [T1] 2.76 dB
1.800000 ms



DH5

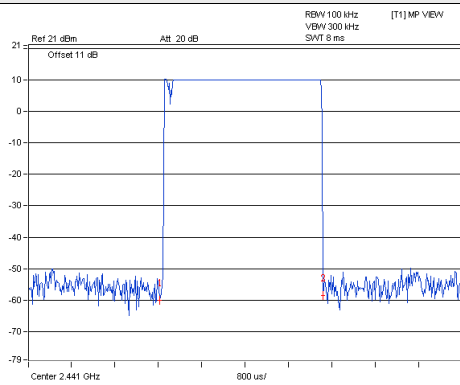
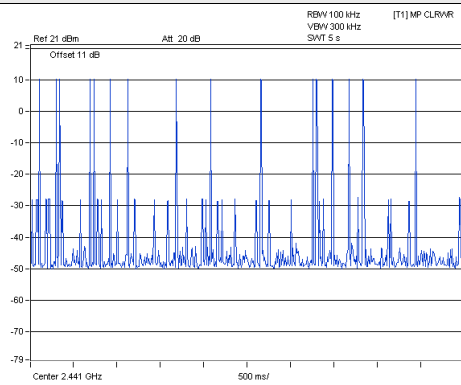

Marker 1 [T1] -60.06 dBm
2.416000 ms
Delta 2 [T1] 1.56 dB
3.024000 ms





8DPSK

Mode	Number of transmission in a 31.6 (79Hopping*0.4)	Length of transmission time (msec)	Result (msec)	Limit (msec)
3DH1	$50 \text{ (times / 5 sec)} * 6.32 = 316 \text{ times}$	0.468	147.89	400
3DH3	$27 \text{ (times / 5 sec)} * 6.32 = 170.64 \text{ times}$	1.86	317.39	400
3DH5	$17 \text{ (times / 5 sec)} * 6.32 = 107.44 \text{ times}$	3.04	326.62	400

NOTE: Test plots of the transmitting time slot are shown on next page.



3DH1

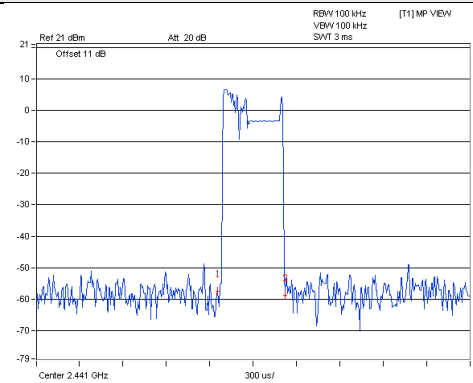
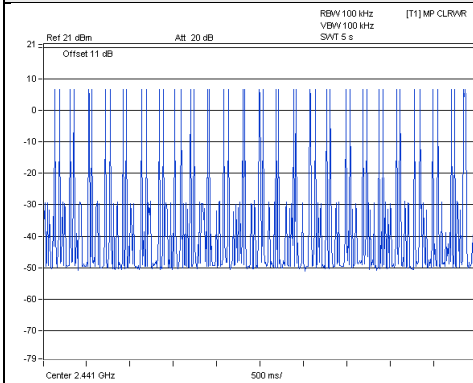

3DH3

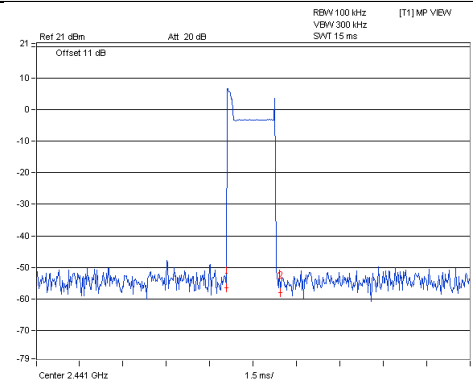
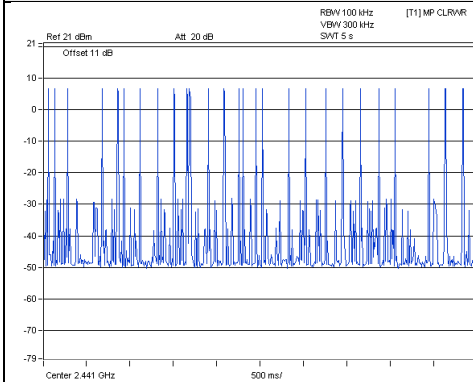

3DH5

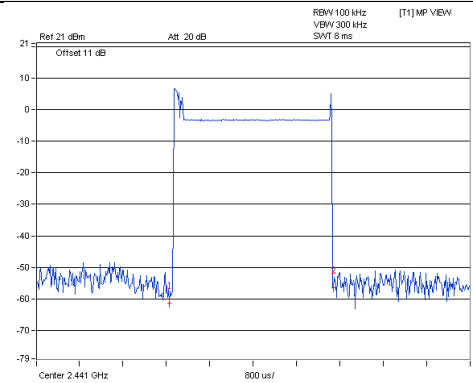
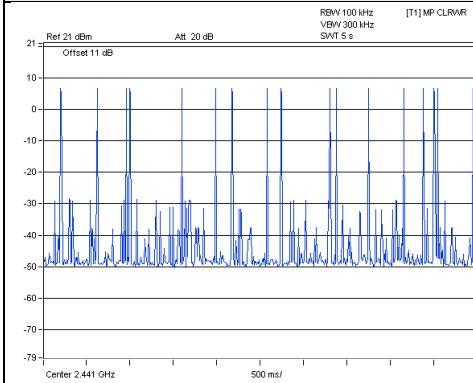

4.5 Channel Bandwidth

4.5.1 Limits of Channel Bandwidth Measurement

For frequency hopping system operating in the 2400-2483.5MHz, If the 20dB bandwidth of hopping channel is greater than 25kHz, two-thirds 20dB bandwidth of hopping channel shall be a minimum limit for the hopping channel separation.

4.5.2 Test Setup

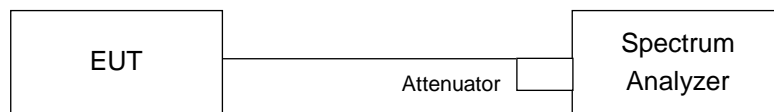

4.5.3 Test Instruments

Refer to section 4.1.2 to get information of above instrument.

4.5.4 Test Procedure

- Check the calibration of the measuring instrument using either an internal calibrator or a known signal from an external generator.
- Turn on the EUT and connect it to measurement instrument. Then set it to any one convenient frequency within its operating range. Set a reference level on the measuring instrument equal to the highest peak value.
- Measure the frequency difference of two frequencies that were attenuated 20dB from the reference level. Record the frequency difference as the emission bandwidth.
- Repeat above procedures until all frequencies measured were complete.

4.5.5 Deviation from Test Standard

No deviation.

4.5.6 EUT Operating Condition

The software provided by client enabled the EUT to transmit and receive data at lowest, middle and highest channel frequencies individually.

4.5.7 Test Results

Channel	Frequency (MHz)	20dB Bandwidth (MHz)	
		GFSK	8DPSK
0	2402	0.81	1.19
39	2441	0.82	1.19
78	2480	0.82	1.19

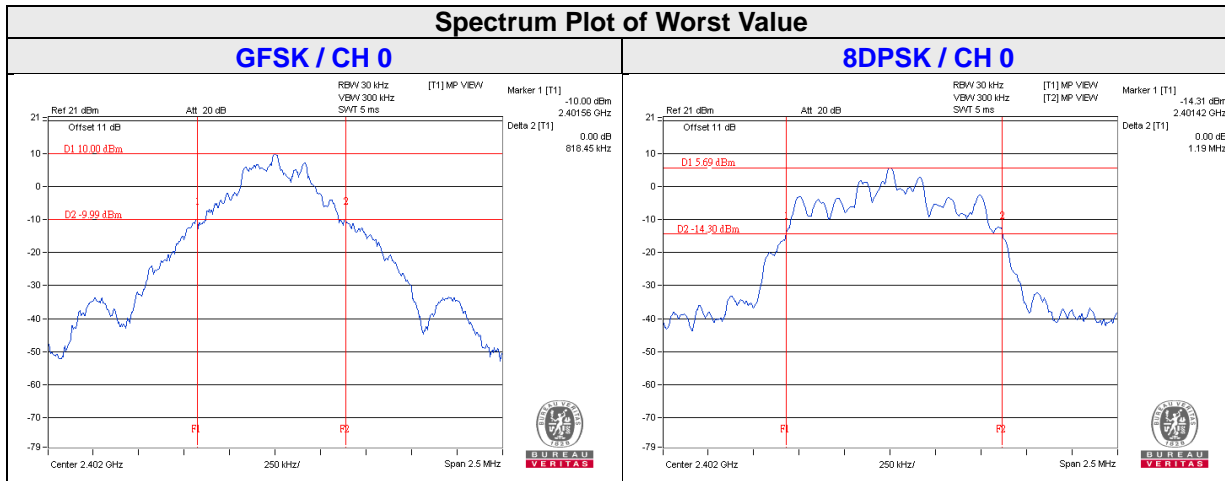

4.6 Hopping Channel Separation

4.6.1 Limits of Hopping Channel Separation Measurement

At least 25kHz or two-third of 20dB hopping channel bandwidth (whichever is greater).

4.6.2 Test Setup

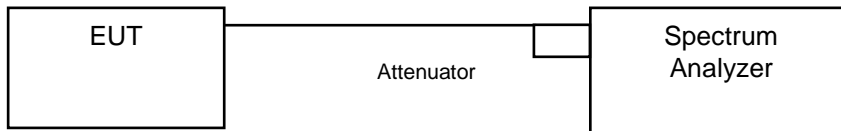

4.6.3 Test Instruments

Refer to section 4.1.2 to get information of above instrument.

4.6.4 Test Procedure

Measurement Procedure REF

- a. Check the calibration of the measuring instrument using either an internal calibrator or a known signal from an external generator.
- b. Turn on the EUT and connect it to measurement instrument. Then set it to any one convenient frequency within its operating range.
- c. By using the MaxHold function record the separation of two adjacent channels.
- d. Measure the frequency difference of these two adjacent channels by SA MARK function. And then plot the result on SA screen.
- e. Repeat above procedures until all frequencies measured were complete.

4.6.5 Deviation from Test Standard

No deviation.

4.6.6 Test Results

Channel	Frequency (MHz)	Adjacent Channel Separation (MHz)		20dB Bandwidth (MHz)		Minimum Limit (MHz)		Pass / Fail
		GFSK	8DPSK	GFSK	8DPSK	GFSK	8DPSK	
0	2402	1.00	1.00	0.81	1.19	0.54	0.8	Pass
39	2441	1.00	1.00	0.82	1.19	0.55	0.8	Pass
78	2480	1.00	1.00	0.82	1.19	0.55	0.8	Pass

NOTE: The minimum limit is two-third 20dB bandwidth.

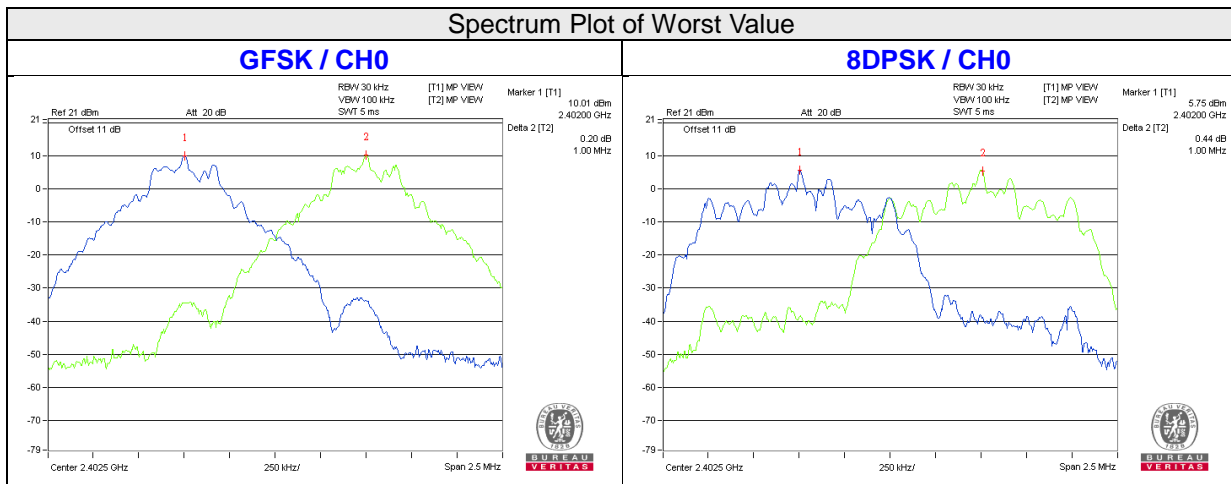

4.7 Maximum Output Power

4.7.1 Limits of Maximum Output Power Measurement

The Maximum Output Power Measurement is 125mW.

4.7.2 Test Setup

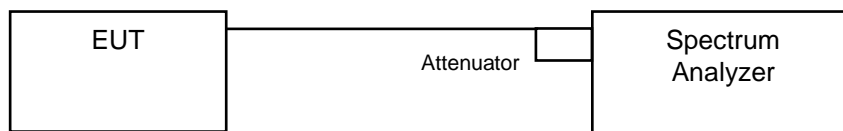

4.7.3 Test Instruments

Refer to section 4.1.2 to get information of above instrument.

4.7.4 Test Procedure

- a. Check the calibration of the measuring instrument using either an internal calibrator or a known signal from an external generator.
- b. Turn on the EUT and connect it to measurement instrument. Then set it to any one convenient frequency within its operating range. Set a reference level on the measuring instrument equal to the highest peak value.
- c. The center frequency of the spectrum analyzer is set to the fundamental frequency and using 3MHz RBW and 10 MHz VBW.
- d. Measure the captured power within the band and recording the plot.
- e. Repeat above procedures until all frequencies required were complete.

4.7.5 Deviation from Test Standard

No deviation.

4.7.6 EUT Operating Condition

The software provided by client enabled the EUT to transmit and receive data at lowest, middle and highest channel frequencies individually.

4.7.7 Test Results

Channel	Frequency (MHZ)	Output Power (mW)		Output Power (dBm)		Power Limit (mW)	Pass / Fail
		GFSK	8DPSK	GFSK	8DPSK		
0	2402	11.298	8.166	10.53	9.12	21.00	Pass
39	2441	11.22	8.531	10.50	9.31	21.00	Pass
78	2480	11.455	8.337	10.59	9.21	21.00	Pass

Spectrum Plot of Worst Value

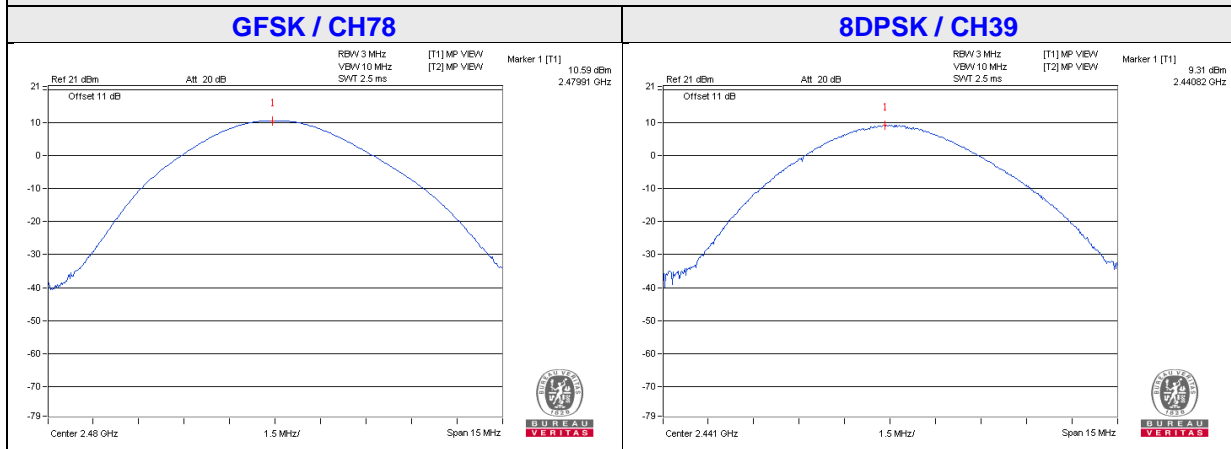

4.8 Conducted Out of Band Emission Measurement

4.8.1 Limits of Conducted Out of Band Emission Measurement

Below -20dB of the highest emission level of operating band (in 100kHz RBW).

4.8.2 Test Instruments

Refer to section 4.1.2 to get information of above instrument.

4.8.3 Test Procedure

The transmitter output was connected to the spectrum analyzer via a low lose cable. Set both RBW and VBW of spectrum analyzer to 100 kHz and 300 kHz with suitable frequency span including 100 MHz bandwidth from band edge. The band edges was measured and recorded.

4.8.4 Deviation from Test Standard

No deviation.

4.8.5 Eut Operating Condition

The software provided by client enabled the EUT to transmit and receive data at lowest, middle and highest channel frequencies individually.

4.8.6 Test Results

The spectrum plots are attached on the following images. D1 line indicates the highest level, D2 line indicates the 20dB offset below D1. It shows compliance with the requirement.

GFSK

Hopping disabled_ Low Channel

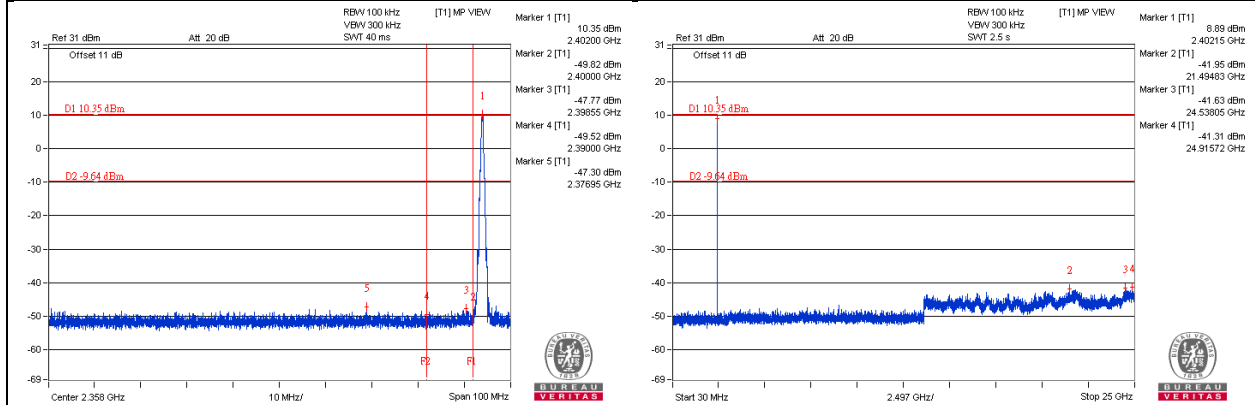

Hopping disabled_ High Channel

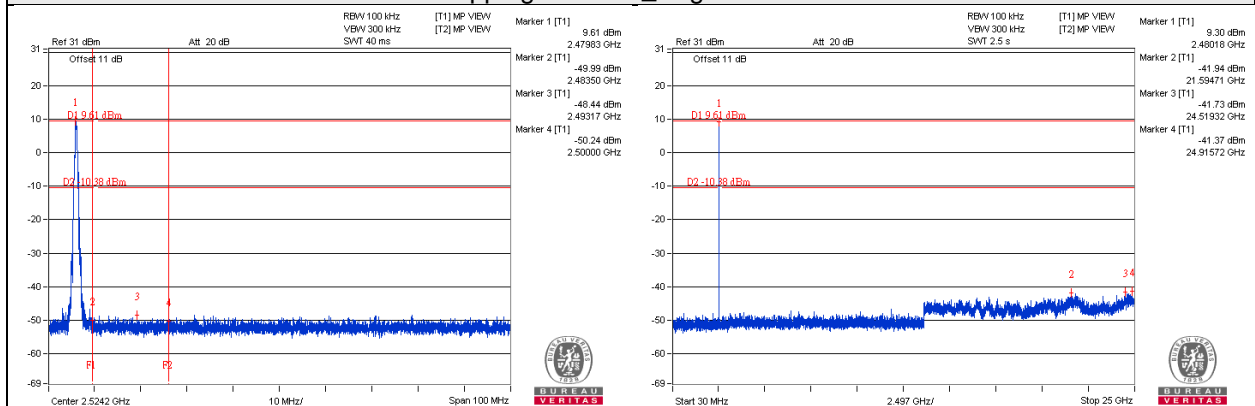

Hopping enabled_ Low Channel

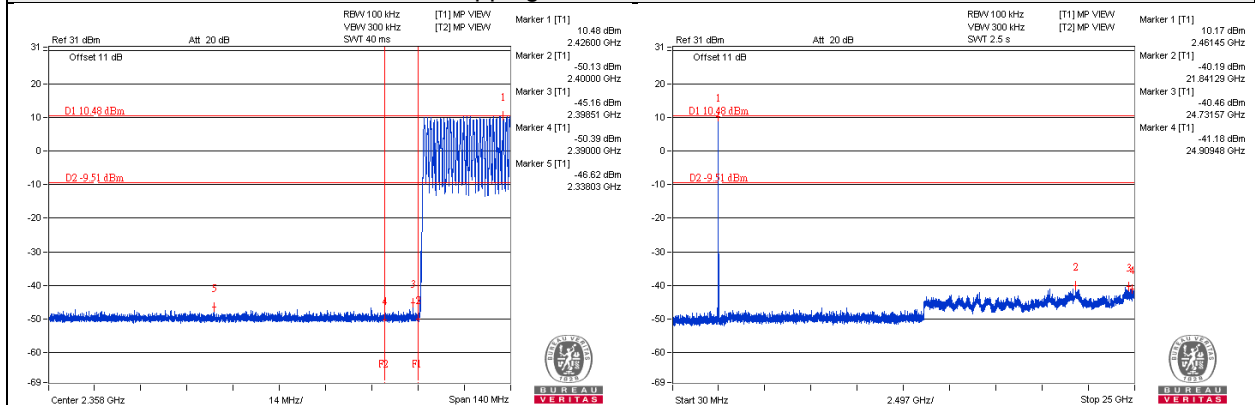

Hopping enabled_ High Channel

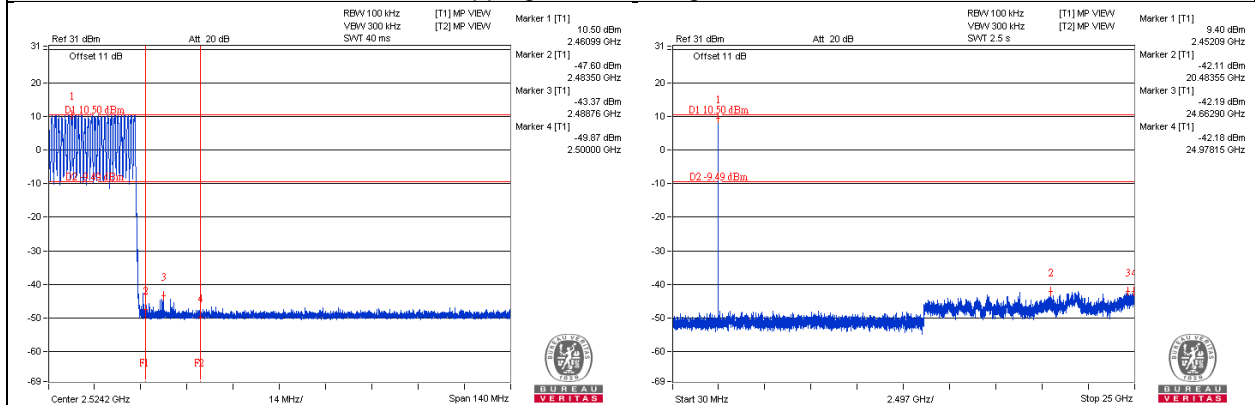



BUREAU VERITAS

8DPSK

Hopping disabled_ Low Channel

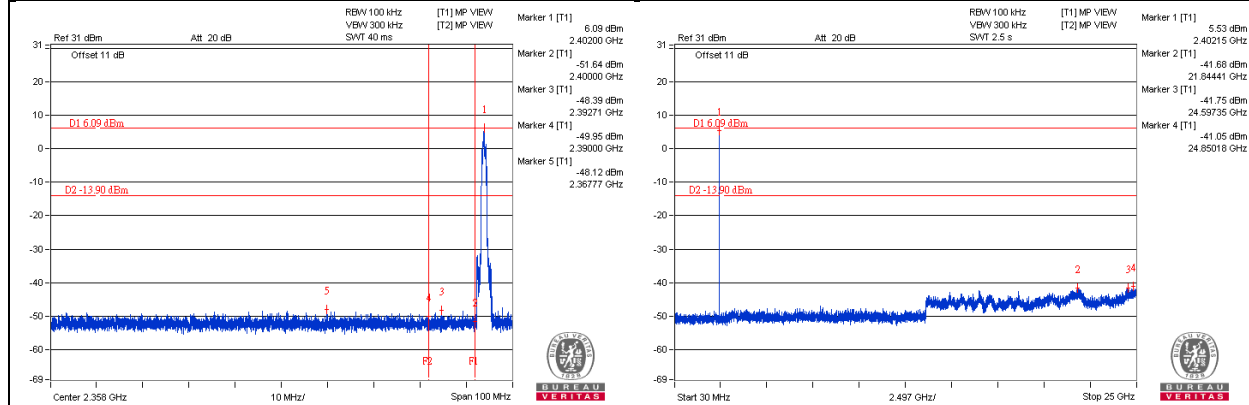

Hopping disabled_ High Channel

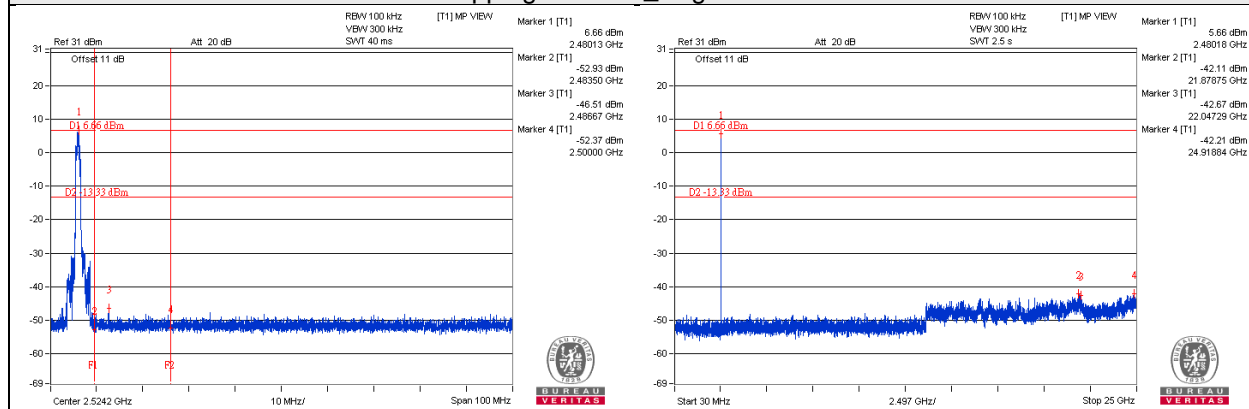

Hopping enabled_ Low Channel

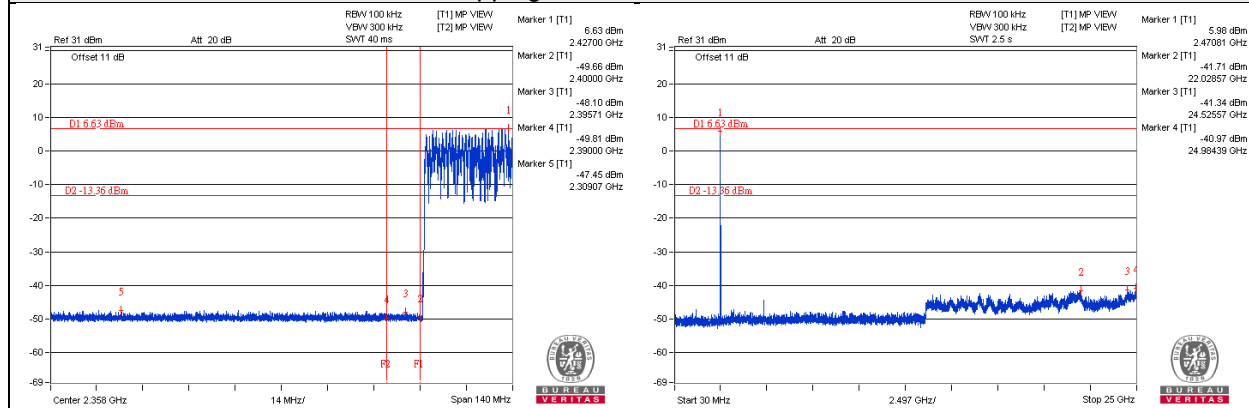

Hopping enabled_ High Channel

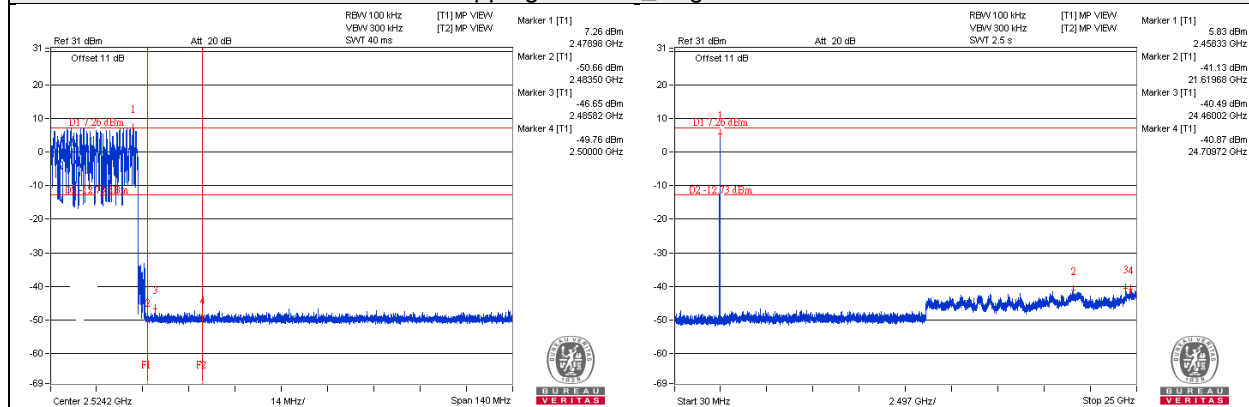



5 Pictures of Test Arrangements

Please refer to the attached file (Test Setup Photo).



Appendix – Information on the Testing Laboratories

We, Bureau Veritas Consumer Products Services (H.K.) Ltd., Taoyuan Branch, were founded in 1988 to provide our best service in EMC, Radio, Telecom and Safety consultation. Our laboratories are accredited and approved according to ISO/IEC 17025.

If you have any comments, please feel free to contact us at the following:

Linko EMC/RF Lab

Tel: 886-2-26052180

Fax: 886-2-26051924

Hsin Chu EMC/RF/Telecom Lab

Tel: 886-3-6668565

Fax: 886-3-6668323

Hwa Ya EMC/RF/Safety Lab

Tel: 886-3-3183232

Fax: 886-3-3270892

Email: service.adt@tw.bureauveritas.com

Web Site: www.bureauveritas-adt.com

The address and road map of all our labs can be found in our web site also.

--- END ---