

ENGINEERING TEST REPORT

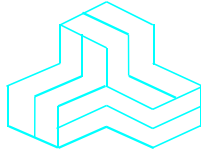

**XBee PRO Series 2 OEM RF Module
Model No.: XBEEPRO2**

FCC ID: MCQ-XBEEPRO2

Applicant:

Digi International Inc.
11001 Bren Road East
Minnetonka, MN 55343

In Accordance With

**Federal Communications Commission (FCC)
Part 15, Subpart C, Section 15.247
Digital Modulation Systems (DTS) Operating in 2400 – 2483.5 MHz Band**

UltraTech's File No.: DIGI-051F15C247C2PC

This Test report is Issued under the Authority of
Tri M. Luu
Vice President of Engineering
UltraTech Group of Labs

Date: September 6, 2011

Report Prepared by: Dan Huynh

Tested by: Hung Trinh

Issued Date: September 6, 2011

Test Dates: July 27, 2011

- *The results in this Test Report apply only to the sample(s) tested, and the sample tested is randomly selected.*
- *This report must not be used by the client to claim product endorsement by NVLAP or any agency of the US Government.*

UltraTech

3000 Bristol Circle, Oakville, Ontario, Canada, L6H 6G4
Tel.: (905) 829-1570 Fax.: (905) 829-8050
Website: www.ultratech-labs.com, Email: vic@ultratech-labs.com, Email: tri@ultratech-labs.com

FCC

91038



1309



46390-2049



NvLap Lab Code 200093-0



SL2-IN-E-1119R



Korea KCC-RRL
CA2049

TABLE OF CONTENTS

EXHIBIT 1. INTRODUCTION..... 1

1.1. SCOPE 1

1.2. RELATED SUBMITTAL(S)/GRANT(S) 1

1.3. NORMATIVE REFERENCES 1

EXHIBIT 2. PERFORMANCE ASSESSMENT..... 2

2.1. CLIENT INFORMATION 2

2.2. EQUIPMENT UNDER TEST (EUT) INFORMATION 2

2.3. EUT'S TECHNICAL SPECIFICATIONS..... 3

2.4. ASSOCIATED ANTENNA DESCRIPTION 3

2.5. LIST OF EUT'S PORTS..... 4

2.6. ANCILLARY EQUIPMENT 4

EXHIBIT 3. EUT OPERATING CONDITIONS AND CONFIGURATIONS DURING TESTS..... 5

3.1. CLIMATE TEST CONDITIONS 5

3.2. OPERATIONAL TEST CONDITIONS & ARRANGEMENT FOR TESTS..... 5

EXHIBIT 4. SUMMARY OF TEST RESULTS 6

4.1. LOCATION OF TESTS 6

4.2. APPLICABILITY & SUMMARY OF EMC EMISSION TEST RESULTS 6

4.3. MODIFICATIONS INCORPORATED IN THE EUT FOR COMPLIANCE PURPOSES..... 6

EXHIBIT 5. MEASUREMENTS, EXAMINATIONS & TEST DATA FOR EMC EMISSIONS..... 7

5.1. TEST PROCEDURES..... 7

5.2. MEASUREMENT UNCERTAINTIES 7

5.3. MEASUREMENT EQUIPMENT USED 7

5.4. ESSENTIAL/PRIMARY FUNCTIONS AS DECLARED BY THE MANUFACTURER 7

5.5. PEAK CONDUCTED OUTPUT POWER - DTS [§ 15.247(b)(3)] 8

5.6. TRANSMITTER SPURIOUS RADIATED EMISSIONS AT 3 METERS [§§ 15.247(d), 15.209 & 15.205] 12

EXHIBIT 6. TEST EQUIPMENT LIST 17

EXHIBIT 7. MEASUREMENT UNCERTAINTY 18

7.1. LINE CONDUCTED EMISSION MEASUREMENT UNCERTAINTY 18

7.2. RADIATED EMISSION MEASUREMENT UNCERTAINTY 18

EXHIBIT 1. INTRODUCTION

1.1. SCOPE

Reference:	FCC Part 15, Subpart C, Section 15.247
Title:	Code of Federal Regulations (CFR), Title 47 – Telecommunication, Part 15
Purpose of Test:	Class II Permissive Change application for equipment certification of Digital Modulation Systems (DTS) Transmitter Operating in the Frequency Band 2400-2483.5 MHz.
Test Procedures:	Both conducted and radiated emissions measurements were conducted in accordance with American National Standards Institute ANSI C63.4 - American National Standard for Methods of Measurement of Radio-Noise Emissions from Low-Voltage Electrical and Electronic Equipment in the Range of 9 kHz to 40 GHz.
Environmental Classification:	[x] Commercial, industrial or business environment [x] Residential environment

1.2. RELATED SUBMITTAL(S)/GRANT(S)

None.

1.3. NORMATIVE REFERENCES

Publication	Year	Title
47 CFR Parts 0-19	2010	Code of Federal Regulations (CFR), Title 47 – Telecommunication
ANSI C63.4	2009	American National Standard for Methods of Measurement of Radio-Noise Emissions from Low-Voltage Electrical and Electronic Equipment in the Range of 9 KHz to 40 GHz
ANSI C63.10	2009	American National Standard for Testing Unlicensed Wireless Devices
CISPR 22 & EN 55022	2008-09, Edition 6.0 2006	Information Technology Equipment - Radio Disturbance Characteristics - Limits and Methods of Measurement
CISPR 16-1-1 +A1 +A2	2006 2006 2007	Specification for radio disturbance and immunity measuring apparatus and methods. Part 1-1: Measuring Apparatus
CISPR 16-1-2 +A1 +A2	2003 2004 2006	Specification for radio disturbance and immunity measuring apparatus and methods. Part 1-2: Conducted disturbances
FCC, KDB Publication No. 558074	2005	Guidance on Measurements for Digital Transmission Systems (47 CFR 15.247)

EXHIBIT 2. PERFORMANCE ASSESSMENT

2.1. CLIENT INFORMATION

APPLICANT	
Name:	Digi International Inc.
Address:	11001 Bren Road East Minnetonka, MN 55343 USA
Contact Person:	Mr. Paul Dahl Phone #: 801-765-9885 Fax #: 801-765-9895 Email Address: Paul.dahl@digi.com

MANUFACTURER	
Name:	Digi International Inc.
Address:	11001 Bren Road East Minnetonka, MN 55343 USA
Contact Person:	Mr. Paul Dahl Phone #: 801-765-9885 Fax #: 801-765-9895 Email Address: Paul.dahl@digi.com

2.2. EQUIPMENT UNDER TEST (EUT) INFORMATION

The following information (with the exception of the Date of Receipt) has been supplied by the applicant.

Brand Name:	Digi International Inc.
Product Name:	XBee PRO Series 2 OEM RF Module
Model Name or Number:	XBEEPRO2
Serial Number:	Test Sample
Type of Equipment:	Digital Modulation Transmitter
Input Power Supply Type:	External DC Power Supply
Primary User Functions of EUT:	Wireless modem

ULTRATECH GROUP OF LABS

3000 Bristol Circle, Oakville, Ontario, Canada L6H 6G4
Tel. #: 905-829-1570, Fax. #: 905-829-8050, Email: vic@ultratech-labs.com, Website: <http://www.ultratech-labs.com>

File #: DIGI-051F15C247C2PC
September 6, 2011

All test results contained in this engineering test report are traceable to National Institute of Standards and Technology (NIST)

2.3. EUT'S TECHNICAL SPECIFICATIONS

TRANSMITTER	
Equipment Type:	<ul style="list-style-type: none">• Mobile• Base Station (fixed use)
Intended Operating Environment:	<ul style="list-style-type: none">• Commercial, industrial or business• Residential
Power Supply Requirement:	3.0 – 3.4 Vdc
RF Output Power Rating:	79 mW (+19 dBm) Peak
Operating Frequency Range:	2405 – 2470 MHz
RF Output Impedance:	50 Ohm
Channel Spacing:	5 MHz
Duty Cycle:	27%
6 dB bandwidth:	1.633 MHz
Modulation Type:	QPSK
Oscillator Frequencies:	4900 MHz
Antenna Connector Type:	<ul style="list-style-type: none">• Integral• Unique connector (RPSMA/U.FL/IPX)

2.4. ASSOCIATED ANTENNA DESCRIPTION

1. Integrated PCB Omnidirectional Antenna (Manufacturer: Digi, Model: 29000430, Gain: -0.5 dBi)

2.5. LIST OF EUT’S PORTS

Port Number	EUT’s Port Description	Number of Identical Ports	Connector Type	Cable Type (Shielded/Non-shielded)
1	RF IN/OUT Port	1	RPSMA/U.FL/IPX	Shielded
2	DC Supply & I/O Port	1	Pin Header	No cable, direct connection

2.6. ANCILLARY EQUIPMENT

The EUT was tested while connected to the following representative configuration of ancillary equipment necessary to exercise the ports during tests:

Ancillary Equipment # 1	
Description:	Test Jig Cable
Brand name:	Digi International
Model Name or Number:	N/A
Serial Number:	N/A
Connected to EUT’s Port:	Module pin signals

EXHIBIT 3. EUT OPERATING CONDITIONS AND CONFIGURATIONS DURING TESTS

3.1. CLIMATE TEST CONDITIONS

The climate conditions of the test environment are as follows:

Temperature:	21°C
Humidity:	51%
Pressure:	102 kPa
Power input source:	3.0 – 3.4 Vdc

3.2. OPERATIONAL TEST CONDITIONS & ARRANGEMENT FOR TESTS

Operating Modes:	Each of lowest, middle and highest channel frequencies transmits continuously for emissions measurements.
Special Test Software:	Special software and hardware by the Applicant to operate the EUT at each channel frequency continuously. For example, the transmitter will be operated at each of the lowest, middle and highest frequencies individually continuously during testing.
Special Hardware Used:	The RF Module could be tested outside of the enclosure using Test Jig connected to EUT.
Transmitter Test Antenna:	The EUT is tested with the antenna fitted in a manner typical of normal intended use as integral / non-integral antenna equipment as described with the test results.

Transmitter Test Signals	
Frequency Band(s):	2405 – 2470 MHz
Frequency(ies) Tested: (Near lowest, near middle & near highest frequencies in the frequency range of operation.)	2405 MHz, 2440 MHz and 2470 MHz
RF Power Output: (measured maximum output power at antenna terminals)	19 dBm (79 mW) Peak
Normal Test Modulation:	QPSK
Modulating Signal Source:	Internal

EXHIBIT 4. SUMMARY OF TEST RESULTS

4.1. LOCATION OF TESTS

All of the measurements described in this report were performed at Ultratech Group of Labs located in the city of Oakville, Province of Ontario, Canada.

- AC Power Line Conducted Emissions were performed in UltraTech's shielded room, 24'(L) by 16'(W) by 8'(H).
- Radiated Emissions were performed at the Ultratech's 3-10 TDK Semi-Anechoic Chamber situated in the Town of Oakville, province of Ontario. This test site been calibrated in accordance with ANSI C63.4, and found to be in compliance with the requirements of Sec. 2.948 of the FCC Rules. The descriptions and site measurement data of the Oakville 3-10 TDK Semi-Anechoic Chamber has been filed with FCC office (FCC File No.: 91038) and Industry Canada office (Industry Canada File No.: 2049A-3). Expiry Date: 2014-04-04.

4.2. APPLICABILITY & SUMMARY OF EMC EMISSION TEST RESULTS

FCC Section(s)	Test Requirements	Compliance (Yes/No)
15.203	Antenna requirements	See Note 1
15.207(a)	AC Power Line Conducted Emissions	See Note 2
15.247(a)(2)	6 dB Bandwidth	See Note 2
15.247(b)(3)	Peak Conducted Output Power - DTS	Yes
15.247(d)	Band-Edge and RF Conducted Spurious Emissions at the Transmitter Antenna Terminal	See Note 2
15.247(d), 15.209 & 15.205	Transmitter Spurious Radiated Emissions	Yes
15.247(e)	Power Spectral Density	See Note 2
15.247(i)	RF Exposure	See Note 2

Note 1: The EUT complies with the requirement, it employs an integrated PCB antenna or unique (non-standard) antenna connector, for all external antennas proposed for use with the EUT.

Note 2: Refer to original filing.

4.3. MODIFICATIONS INCORPORATED IN THE EUT FOR COMPLIANCE PURPOSES

None.

EXHIBIT 5. MEASUREMENTS, EXAMINATIONS & TEST DATA FOR EMC EMISSIONS

5.1. TEST PROCEDURES

This section contains test results only. Details of test methods and procedures can be found in ANSI C63.4, ANSI C63.10 and FCC KDB Publication No. 558074: Guidance on Measurements for Digital Transmission Systems.

5.2. MEASUREMENT UNCERTAINTIES

The measurement uncertainties stated were calculated in accordance with the requirements of CISPR 16-4-2 @ IEC:2003 and JCGM 100:2008 (GUM 1995) – Guide to the Expression of Uncertainty in Measurement. Refer to Exhibit 7 for Measurement Uncertainties.

5.3. MEASUREMENT EQUIPMENT USED

The measurement equipment used complied with the requirements of the Standards referenced in the Methods & Procedures ANSI C63.4 and CISPR 16-1-1.

5.4. ESSENTIAL/PRIMARY FUNCTIONS AS DECLARED BY THE MANUFACTURER

Wireless modem.

5.5. PEAK CONDUCTED OUTPUT POWER - DTS [§ 15.247(b)(3)]

5.5.1. Limit(s)

§ 15.247(b)(3): For systems using digital modulation in the 902-928 MHz, 2400-2483.5 MHz, and 5725-5850 MHz bands: 1 Watt. As an alternative to a peak power measurement, compliance with the one Watt limit can be based on a measurement of the maximum conducted output power. Maximum Conducted Output Power is defined as the total transmit power delivered to all antennas and antenna elements averaged across all symbols in the signaling alphabet when the transmitter is operating at its maximum power control level. Power must be summed across all antennas and antenna elements. The average must not include any time intervals during which the transmitter is off or is transmitting at a reduced power level. If multiple modes of operation are possible (e.g., alternative modulation methods), the *maximum conducted output power* is the highest total transmit power occurring in any mode.

§15.247(b)(4): The conducted output power limit specified in paragraph (b) of this section is based on the use of antennas with directional gains that do not exceed 6 dBi. Except as shown in paragraph (c) of this section, if transmitting antennas of directional gain greater than 6 dBi are used, the conducted output power from the intentional radiator shall be reduced below the stated values in paragraphs (b)(1), (b)(2), and (b)(3) of this section, as appropriate, by the amount in dB that the directional gain of the antenna exceeds 6 dBi.

5.5.2. Method of Measurements & Test Arrangement

KDB Publication No. 558074: Guidance on Measurements for Digital Transmission Systems (47 CFR 15.247).

5.5.2.1. Test Arrangement

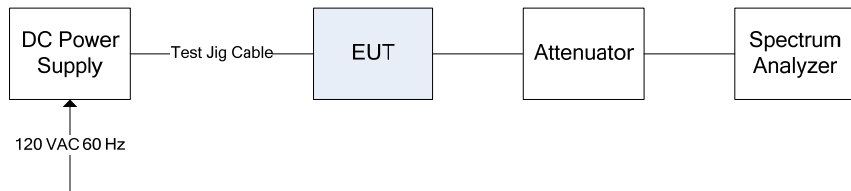

5.5.3. Test Data

Frequency (MHz)	Peak Conducted Power (dBm)	Peak EIRP* (dBm)	Peak Conducted Power Limit (dBm)	EIRP Limit (dBm)
2405	19.03	18.53	30	36
2440	19.03	18.53	30	36
2470	18.53	18.03	30	36

* Peak EIRP calculation = Peak Conducted Power + Antenna Gain in dBi.

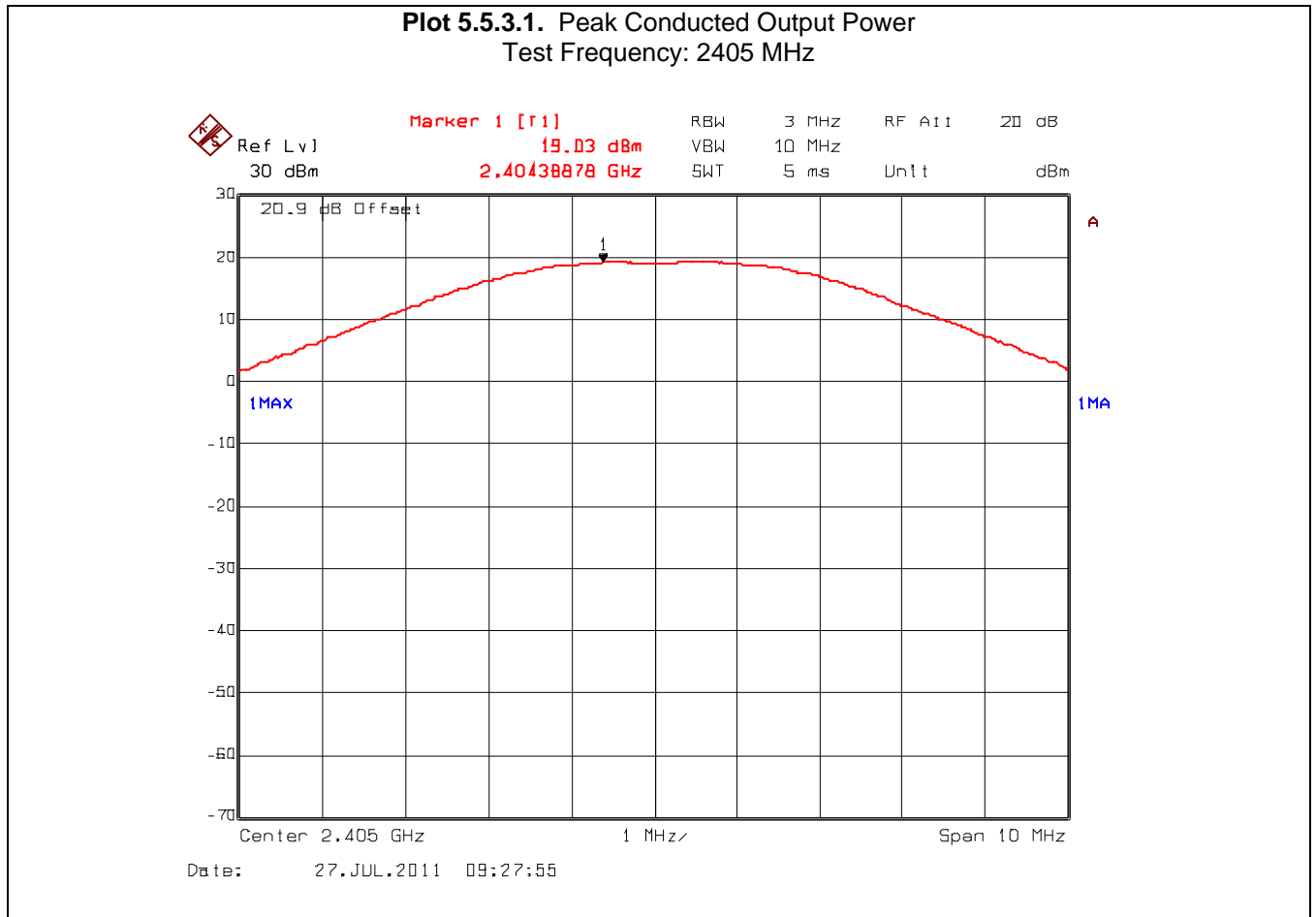

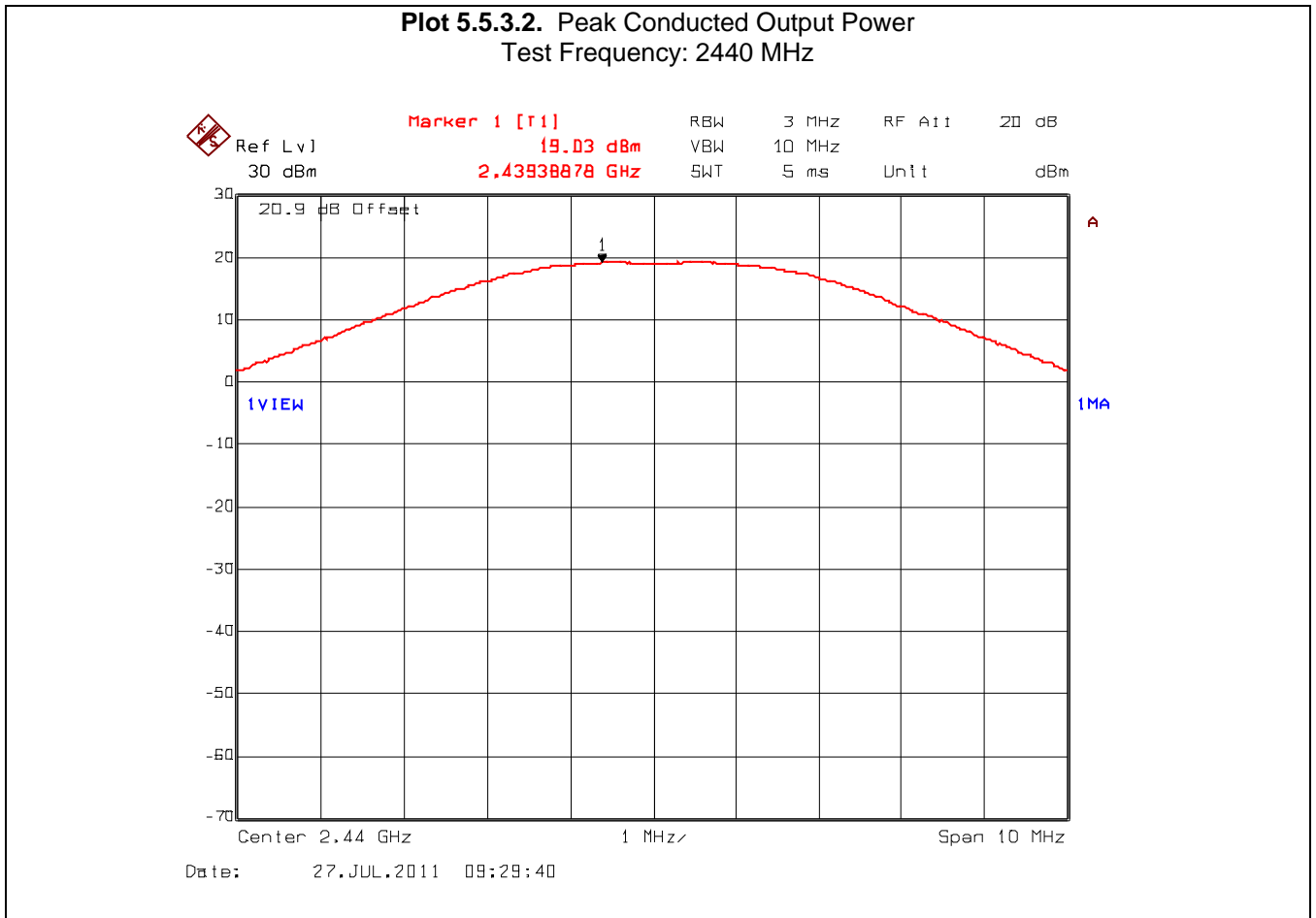

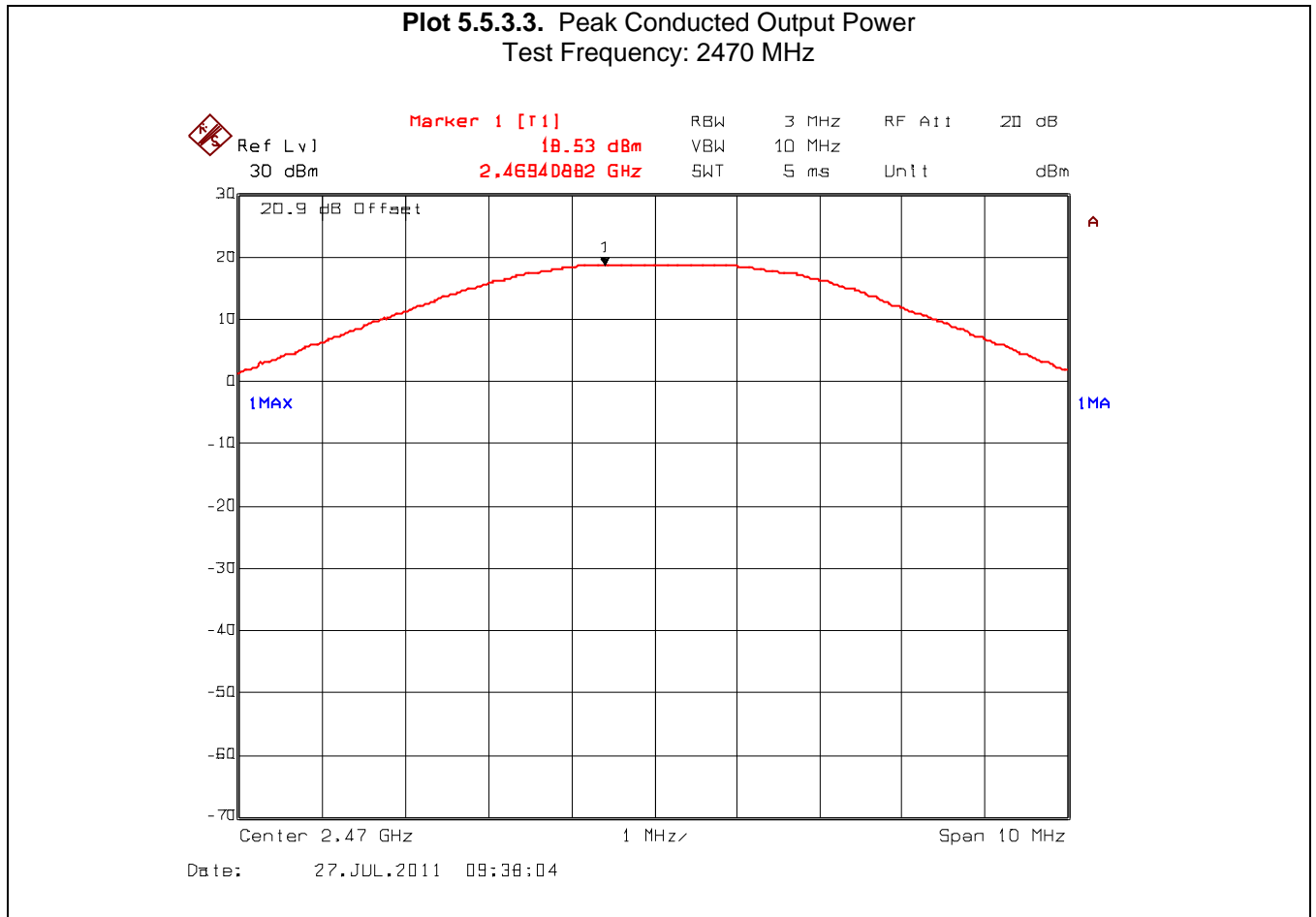

5.6. TRANSMITTER SPURIOUS RADIATED EMISSIONS AT 3 METERS [§§ 15.247(d), 15.209 & 15.205]

5.6.1. Limit(s)

§ 15.247 (d) In any 100 kHz bandwidth outside the frequency band in which the spread spectrum or digitally modulated intentional radiator is operating, the radio frequency power that is produced by the intentional radiator shall be at least 20 dB below that in the 100 kHz bandwidth within the band that contains the highest level of the desired power, based on either an RF conducted or a radiated measurement, provided the transmitter demonstrates compliance with the peak conducted power limits. If the transmitter complies with the conducted power limits based on the use of RMS averaging over a time interval, as permitted under paragraph (b)(3) of this section, the attenuation required under this paragraph shall be 30 dB instead of 20 dB. Attenuation below the general limits specified in § 15.209(a) is not required. In addition, radiated emissions which fall in the restricted bands, as defined in § 15.205(a), must also comply with the radiated emission limits specified in § 15.209(a) (see § 15.205(c)).

Section 15.205(a) - Restricted Bands of Operation

MHz	MHz	MHz	GHz
0.090–0.110	16.42–16.423	399.9–410	4.5–5.15
¹ 0.495–0.505	16.69475–16.69525	608–614	5.35–5.46
2.1735–2.1905	16.80425–16.80475	960–1240	7.25–7.75
4.125–4.128	25.5–25.67	1300–1427	8.025–8.5
4.17725–4.17775	37.5–38.25	1435–1626.5	9.0–9.2
4.20725–4.20775	73–74.6	1645.5–1646.5	9.3–9.5
6.215–6.218	74.8–75.2	1660–1710	10.6–12.7
6.26775–6.26825	108–121.94	1718.8–1722.2	13.25–13.4
6.31175–6.31225	123–138	2200–2300	14.47–14.5
8.291–8.294	149.9–150.05	2310–2390	15.35–16.2
8.362–8.366	156.52475–156.52525	2483.5–2500	17.7–21.4
8.37625–8.38675	156.7–156.9	2655–2900	22.01–23.12
8.41425–8.41475	162.0125–167.17	3260–3267	23.6–24.0
12.29–12.293	167.72–173.2	3332–3339	31.2–31.8
12.51975–12.52025	240–285	3345.8–3358	36.43–36.5
12.57675–12.57725	322–335.4	3600–4400	(²)
13.36–13.41.			

¹ Until February 1, 1999, this restricted band shall be 0.490–0.510 MHz.

² Above 38.6

Section 15.209(a)

-- Field Strength Limits within Restricted Frequency Bands --

Frequency (MHz)	Field Strength (microvolts/meter)	Measurement Distance (meters)
0.009 - 0.490	2,400 / F (kHz)	300
0.490 - 1.705	24,000 / F (kHz)	30
1.705 - 30.0	30	30
30 – 88	100	3
88 – 216	150	3
216 – 960	200	3
Above 960	500	3

5.6.2. Method of Measurements

KDB Publication No. 558074: Guidance on Measurements for Digital Transmission Systems (47 CFR 15.247) and ANSI C63.4.

5.6.3. Test Arrangement

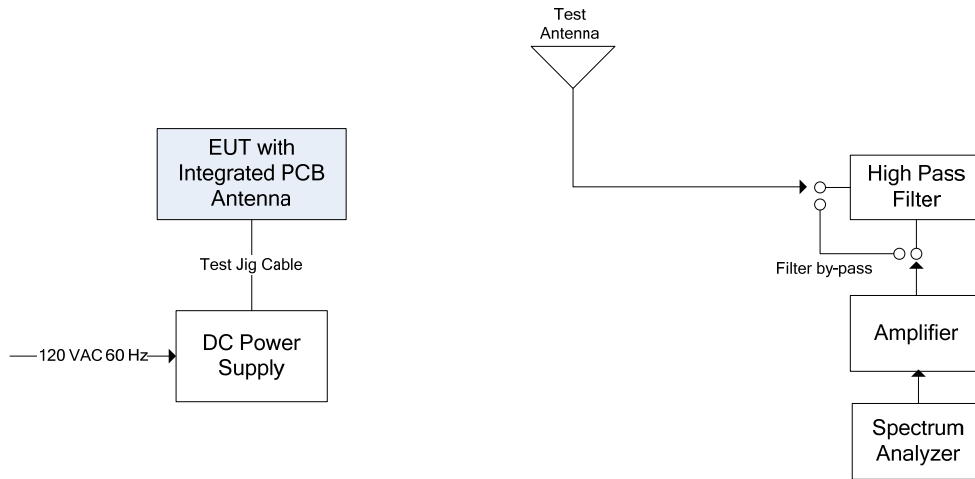

5.6.4. Test Data

Remarks:

- All spurious emissions that are in excess of 20 dB below the specified limit shall be recorded.
- EUT shall be tested in three orthogonal positions.
- The following test results are the worst-case measurements.

Fundamental Frequency:		2405 MHz					
Test Frequency Range:		30 MHz – 25 GHz					
Frequency (MHz)	RF Peak Level (dBµV/m)	RF Avg Level (dBµV/m)	Antenna Plane (H/V)	Limit 15.209 (dBµV/m)	Limit 15.247 (dBµV/m)	Margin (dB)	Pass/Fail
2405	120.75	--	V	--	--	--	--
2405	118.88	--	H	--	--	--	--
4810	67.26	46.78	V	54.0	100.8	-7.2	Pass*
4810	64.78	45.04	H	54.0	100.8	-9.0	Pass*

*Field strength of emissions appearing within restricted frequency bands shall not exceed the limits in § 15.209.

Fundamental Frequency:		2440 MHz					
Test Frequency Range:		30 MHz – 25 GHz					
Frequency (MHz)	RF Peak Level (dBµV/m)	RF Avg Level (dBµV/m)	Antenna Plane (H/V)	Limit 15.209 (dBµV/m)	Limit 15.247 (dBµV/m)	Margin (dB)	Pass/Fail
2440	119.13	--	V	--	--	--	--
2440	118.07	--	H	--	--	--	--
4880	66.34	44.96	V	54.0	99.1	-9.0	Pass*
4880	65.49	45.83	H	54.0	99.1	-8.2	Pass*

*Field strength of emissions appearing within restricted frequency bands shall not exceed the limits in § 15.209.

Fundamental Frequency:		2470 MHz					
Test Frequency Range:		30 MHz – 25 GHz					
Frequency (MHz)	RF Peak Level (dBµV/m)	RF Avg Level (dBµV/m)	Antenna Plane (H/V)	Limit 15.209 (dBµV/m)	Limit 15.247 (dBµV/m)	Margin (dB)	Pass/Fail
2470	119.20	--	V	--	--	--	--
2470	118.80	--	H	--	--	--	--
4940	67.77	48.39	V	54.0	99.2	-5.6	Pass*
4940	65.39	45.62	H	54.0	99.2	-8.4	Pass*
7410	57.30	35.14	V	54.0	99.2	-18.9	Pass*
7410	57.64	35.59	H	54.0	99.2	-18.4	Pass*
12350	58.85	35.31	V	54.0	99.2	-18.7	Pass*
12350	59.04	35.62	H	54.0	99.2	-18.4	Pass*

*Field strength of emissions appearing within restricted frequency bands shall not exceed the limits in § 15.209.

See the following test data plots for band-edge emissions.

Plot 5.6.4.1. Band-Edge RF Radiated Emissions @ 3 m
 Low End of Frequency Band
 Rx Antenna Orientation: Horizontal

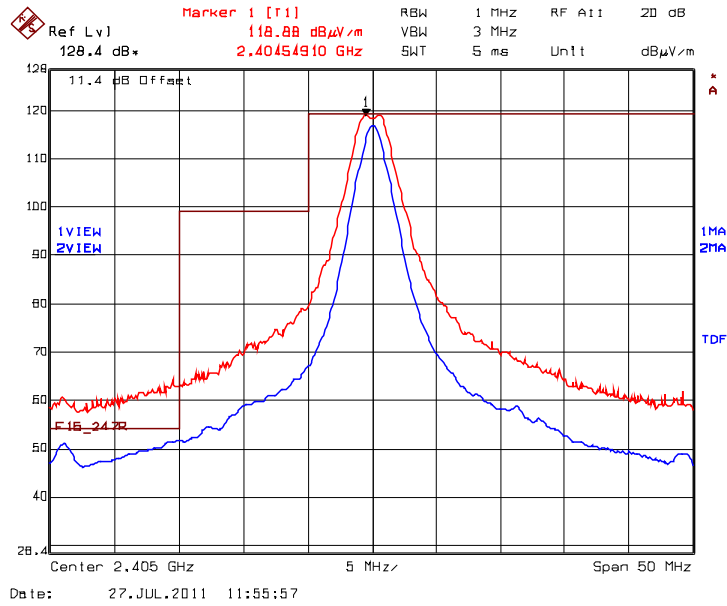

Plot 5.6.4.2. Band-Edge RF Radiated Emissions @ 3 m
 Low End of Frequency Band
 Rx Antenna Orientation: Vertical

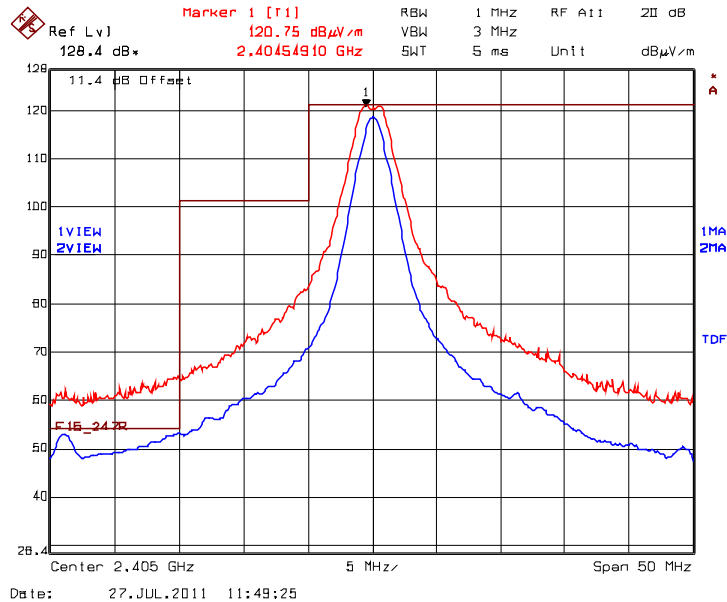

Trace 1: RBW = 1 MHz, VBW = 3 MHz
 Trace 2: RBW = 1 MHz, VBW = 10 Hz

Plot 5.6.4.3. Band-Edge RF Radiated Emissions @ 3 m,
 High End of Frequency Band, Rx Antenna Orientation: Horizontal
 At 2483.5 MHz, Average with 27% Duty Cycle Correction Factor: 53.62 dB μ V/m – 11.37dB = 42.25 dB μ V/m

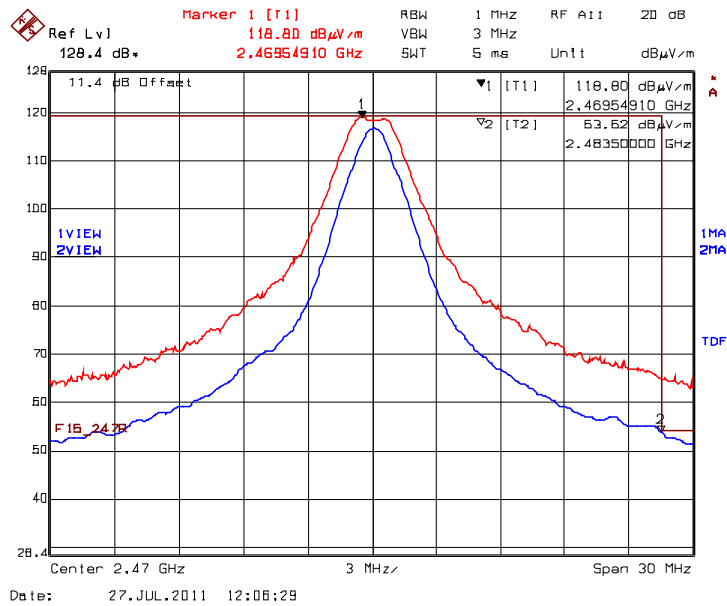

Plot 5.6.4.4. Band-Edge RF Radiated Emissions @ 3 m
 High End of Frequency Band, Rx Antenna Orientation: Vertical
 At 2483.5 MHz, Average with 27% Duty Cycle Correction Factor: 56.93 dB μ V/m – 11.37dB = 45.56 dB μ V/m

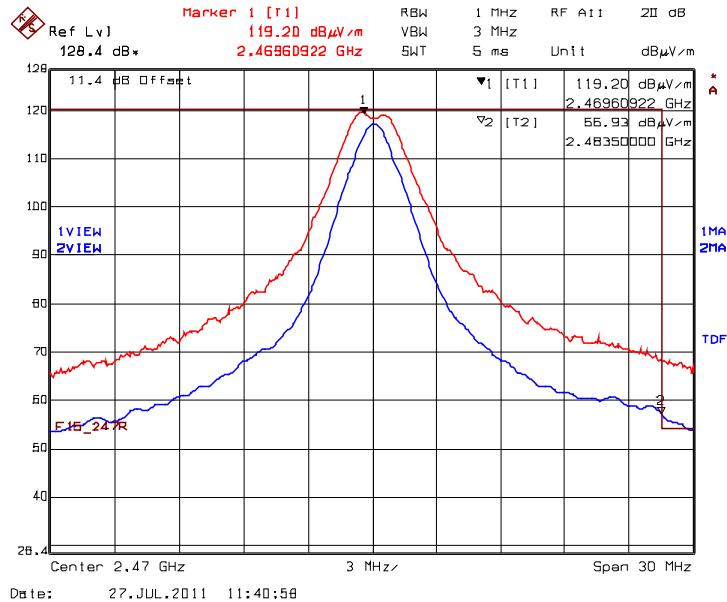

Trace 1: RBW = 1 MHz, VBW = 3 MHz
 Trace 2: RBW = 1 MHz, VBW = 10 Hz

EXHIBIT 6. TEST EQUIPMENT LIST

Test Instruments	Manufacturer	Model No.	Serial No.	Frequency Range	Cal. Due Date
Spectrum Analyzer	Rohde & Schwarz	FSEK30	100077	20 Hz – 40 GHz	14 Aug 2011
Spectrum Analyzer	Rohde & Schwarz	ESU40	100037	20 Hz – 40 GHz	15 Mar 2012
RF Amplifier	Hewlett Packard	84498	3008A00769	1 – 26.5 GHz	17 Feb 2012
RF Amplifier	AH System	PAM-0118	225	20 MHz – 18 GHz	15 Mar 2012
High Pass Filter	K & L	11SH10-4000/T12000	4	Cut off at 2.4 GHz	Cal. on use
Horn Antenna	Emco	3115	6570	1 – 18 GHz	22 Feb 2012
Biconi-Log Antenna	Emco	3142C	00034792	26 – 3000 MHz	26 Apr 2012
Signal Generator	Hewlett Packard	8648C	3443U00391	100 kHz – 3200 MHz	16 Dec 2011
Attenuator	Narda	4768-20	-	DC – 40 GHz	Cal. on use
Horn Antenna	Emco	3115	5061	1 – 18 GHz	28 Nov 2011
Horn Antenna	Emco	3160-09	00118385	18 – 26.5 GHz	30 May 2012

ULTRATECH GROUP OF LABS

3000 Bristol Circle, Oakville, Ontario, Canada L6H 6G4
Tel. #: 905-829-1570, Fax. #: 905-829-8050, Email: vic@ultratech-labs.com, Website: <http://www.ultratech-labs.com>

File #: DIGI-051F15C247C2PC
September 6, 2011

All test results contained in this engineering test report are traceable to National Institute of Standards and Technology (NIST)

EXHIBIT 7. MEASUREMENT UNCERTAINTY

The measurement uncertainties stated were calculated in accordance with the requirements of CISPR 16-4-2 @ IEC:2003 and JCGM 100:2008 (GUM 1995) – Guide to the Expression of Uncertainty in Measurement.

7.1. LINE CONDUCTED EMISSION MEASUREMENT UNCERTAINTY

	Line Conducted Emission Measurement Uncertainty (150 kHz – 30 MHz):	Measured	Limit
u_c	Combined standard uncertainty: $u_c(y) = \sqrt{\sum_{i=1}^m u_i^2(y)}$	± 1.57	± 1.8
U	Expanded uncertainty U: $U = 2u_c(y)$	± 3.14	± 3.6

7.2. RADIATED EMISSION MEASUREMENT UNCERTAINTY

	Radiated Emission Measurement Uncertainty @ 3m, Horizontal (30-1000 MHz):	Measured	Limit
u_c	Combined standard uncertainty: $u_c(y) = \sqrt{\sum_{i=1}^m u_i^2(y)}$	± 2.15	± 2.6
U	Expanded uncertainty U: $U = 2u_c(y)$	± 4.30	± 5.2

	Radiated Emission Measurement Uncertainty @ 3m, Vertical (30-1000 MHz):	Measured	Limit
u_c	Combined standard uncertainty: $u_c(y) = \sqrt{\sum_{i=1}^m u_i^2(y)}$	± 2.39	± 2.6
U	Expanded uncertainty U: $U = 2u_c(y)$	± 4.78	± 5.2

	Radiated Emission Measurement Uncertainty @ 3 m, Horizontal & Vertical (1 – 18 GHz):	Measured	Limit
u_c	Combined standard uncertainty: $u_c(y) = \sqrt{\sum_{i=1}^m u_i^2(y)}$	± 1.87	Under consideration
U	Expanded uncertainty U: $U = 2u_c(y)$	± 3.75	Under consideration