



USER GUIDE

5.9.3AA | March 2020 | 3725-49138-001A

Poly Trio C60

Getting Help

For more information about installing, configuring, and administering Poly/Polycom products or services, go to Polycom Support.

Plantronics, Inc. (Poly — formerly Plantronics and Polycom)
345 Encinal Street
Santa Cruz, California
95060

© 2020 Plantronics, Inc. All rights reserved. Poly, the propeller design, and the Poly logo are trademarks of Plantronics, Inc. All other trademarks are the property of their respective owners.

Contents

Before You Begin.....	6
Audience, Purpose, and Required Skills.....	6
Related Poly and Partner Resources.....	6
Getting Started with Poly Trio C60.....	7
Product Overview of Poly Trio C60 Systems.....	7
Poly Trio C60 System Hardware Overview.....	7
Navigating Poly Trio C60.....	9
Accessing Screens on the Poly Trio C60 System.....	9
Icons and Status Indicators.....	13
Entering Information Using the Onscreen Keyboard.....	14
Change the Phone Language and Keyboard Layouts.....	14
Switching Call Applications.....	15
Logging In to and Locking the System.....	16
Logging In to Poly Trio C60.....	16
Locking Poly Trio C60.....	17
Audio Calls.....	19
Placing Audio Calls.....	19
Place an Audio Call.....	19
Place an International Call.....	20
Place a Call from Recent Calls.....	20
Call a Favorite.....	20
Place a Call over Bluetooth.....	20
Place a Call from a Locked Phone.....	21
Redial a Number.....	21
Calling Contacts from the Directory.....	21
Call a Contact from a Directory.....	21
Call a Contact from a Directory Search.....	21
Placing Intercom Calls.....	22
Place an Intercom Call.....	22
Place an Intercom Call During a Call.....	22
Answering Audio Calls.....	23
Answer an Incoming Call.....	23
Answer a Call When in a Call.....	24
Answer Calls Automatically.....	24

Answer a Call on a Locked Phone.....	24
Answer an Intercom Call.....	24
Decline an Incoming Call.....	25
End an Audio Call.....	25
Holding and Resuming Calls.....	25
Hold a Call.....	25
Resume a Call.....	25
Transferring Calls.....	26
Choose a Default Transfer Type.....	26
Transfer a Call Using Blind Transfer.....	26
Transfer a Call Using Consultative Transfer.....	26
Cancel a Transfer.....	27
Forwarding Incoming Calls to a Contact.....	27
Forward an Incoming Call to a Contact.....	27
Forward All Incoming Calls to a Contact.....	27
Disable Call Forwarding.....	28
Rejecting Calls with Do Not Disturb.....	28
Enable Do Not Disturb.....	28
Disable Do Not Disturb.....	28
Managing Multiple Calls.....	29
Manage a Call from the Calls Screen.....	29
Make a Call Using a Different Call Application.....	30
Mute the Microphones.....	30
Unmute the Microphones.....	31
Conference Calls.....	32
Initiate a Conference Call.....	32
Merge Calls into a Conference Call.....	32
Add Participants to a Conference Call.....	33
End a Conference Call.....	33
Hold a Conference Call.....	33
Resume a Conference Call.....	33
Mute a Conference Participant.....	33
Remove a Conference Participant.....	34
Recording Audio Calls.....	35
Guidelines When Recording Calls.....	35
Record a Call.....	36
Pause a Recording.....	36
Resume a Recording.....	36
Stop Recording.....	36

Browse Recorded Calls.....	37
Play a Recorded Call.....	37
Pause and Resume Played Recordings.....	37
Stop Playing a Recording.....	38
Rename a Recording.....	38
Delete a Recording.....	38
Using the Calendar.....	39
Open the Calendar.....	39
View Meeting Details.....	40
Meeting Reminders.....	40
Choose a Meeting Reminder Type.....	41
Choose a Meeting Alert Tone.....	41
Disable Meeting Reminders.....	41
Joining Calendar Meetings.....	41
Join a Meeting from the Calendar.....	41
Join a Meeting from a Meeting Reminder.....	42
Join a Meeting with an Alternate Number.....	42
Call Lists and Directories.....	43
Recent Calls.....	43
View Recent Calls.....	43
Edit a Recent Call Entry.....	43
Save a Recent Contact.....	44
Delete a Recent Call Entry.....	44
Local Directory.....	44
Search for a Local Directory Contact.....	44
Add a Contact to the Local Directory.....	44
View Contact Details.....	45
Update a Local Directory Contact's Information.....	45
Delete a Local Directory Contact.....	45
Local Directory Favorites.....	45
Add Favorites.....	45
Remove a Favorite.....	46
Corporate Directory.....	46
Search the Corporate Directory.....	46
Perform an Advanced Search of the Corporate Directory.....	46
Add Corporate Directory Contacts to the Local Directory.....	47
Searching the BroadSoft Directory.....	47
Search the BroadSoft Directory.....	47
Perform an Advanced Search of the BroadSoft Directory.....	47

Add BroadSoft Contacts to the Local Directory.....	48
Voicemail and Pages.....	49
Access Voicemail Messages.....	49
Receiving Messages with Group Paging.....	49
Listen to a Page During an Active Call.....	50
Receiving Pages When Not in an Active Call.....	50
Connecting Bluetooth and USB Devices.....	51
Connecting Devices Using Bluetooth.....	51
Make the System Visible to Nearby Bluetooth Devices.....	51
Connect a Bluetooth Device.....	52
Play Audio from a Bluetooth Device.....	52
Connecting a Device Using a USB Cable.....	52
Minimum Hardware and Software Laptop Requirements.....	53
Connect a USB Device or Laptop.....	53
Setting Your Phone as the Audio Device.....	53
Poly Trio C60 Settings.....	54
Password Required to Access Basic Settings.....	54
Time and Date Display.....	54
Change the Time and Date Format.....	54
Disable the Time and Date Display.....	55
Set the Language.....	55
Backlight Intensity and Timeout.....	55
Set the Backlight Intensity.....	55
Set the Backlight Timeout.....	56
Enable or Disable Number Formatting.....	56
Power Saving Mode.....	56
Change Your Office Hours for Power Saving Mode.....	57
Change Idle Timeouts for Power Saving Mode.....	57
Change User Detection for Power Saving Mode.....	57
Set a Ringtone for Incoming Calls.....	58
Maintaining Poly Trio C60.....	59
Update the Phone's Configuration	59
Clean the Touchscreen.....	59
Accessibility Features.....	60

Features for Hearing-Impaired Users.....	60
Features for Mobility-Impaired Users.....	60
Features for Vision-Impaired and Blind Users.....	61
Troubleshooting.....	62
Investigate Warnings.....	62
Check the Status of the Calendar.....	62
Test the Hardware.....	63
Set Log Levels.....	63
Reboot Your Phone.....	63
Reset the Phone to Factory Defaults.....	64

Before You Begin

Topics:

- [Audience, Purpose, and Required Skills](#)
- [Related Poly and Partner Resources](#)

This guide contains overview information, procedures, and references you can use to perform tasks with your Poly Trio C60 system.

Audience, Purpose, and Required Skills

This guide provides information for Poly Trio C60 systems. Administrators and users can use this guide to configure Poly settings available on the system's local interface.

This guide covers the models listed below:

- Poly Trio C60 system
- Poly Trio C60 ND system
- Poly Trio C60 NR system

Related Poly and Partner Resources

See the following sites for information related to this product.

- The [Polycom Support Site](#) is the entry point to online product, service, and solution support information including **Licensing & Product Registration**, **Self-Service**, **Account Management**, **Product-Related Legal Notices**, and **Documents & Software** downloads.
- The [Polycom Document Library](#) provides support documentation for active products, services, and solutions. The documentation displays in responsive HTML5 format so that you can easily access and view installation, configuration, or administration content from any online device.
- The [Polycom Community](#) provides access to the latest developer and support information. Create an account to access Poly support personnel and participate in developer and support forums. You can find the latest information on hardware, software, and partner solutions topics, share ideas, and solve problems with your colleagues.
- The [Polycom Partner Network](#) are industry leaders who natively integrate the Poly standards-based RealPresence Platform with their customers' current UC infrastructures, making it easy for you to communicate face-to-face with the applications and devices you use every day.
- The [Polycom Collaboration Services](#) help your business succeed and get the most out of your investment through the benefits of collaboration.

Getting Started with Poly Trio C60

Topics:

- [Product Overview of Poly Trio C60 Systems](#)
- [Navigating Poly Trio C60](#)
- [Entering Information Using the Onscreen Keyboard](#)
- [Switching Call Applications](#)

Before you use your phone, familiarize yourself with its features and user interface.

Note: As you read this guide, remember that your system administrator configures certain features or your network environment may determine them. As a result, some features may not be enabled or may operate differently on your device. Additionally, the examples and graphics in this guide may not directly reflect available options or what your device screen displays.

Product Overview of Poly Trio C60 Systems

Poly Trio C60 systems support audio-only conference calls with Open-SIP voice platforms.

Trio C60 systems support the following features:

- Placing, answering, and managing audio calls
- Switching call applications on the fly
- Initiating, joining, and managing audio conference calls
- Recording audio calls with USB flash drives
- Viewing and joining scheduled calendar meetings
- Managing contacts, call lists, and directories
- Adjusting call and phone settings
- Checking voicemail messages
- Connecting to computers over USB
- Pairing with Bluetooth-enabled devices
- Connecting to wireless networks

Poly Trio C60 System Hardware Overview

The following figure displays the hardware features on Poly Trio C60 systems. The table lists each numbered feature shown in the figure.

Figure 1: Poly Trio C60 System hardware features

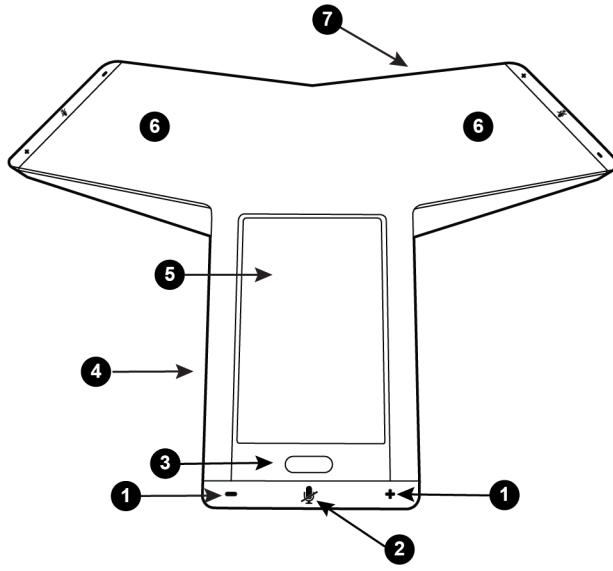

Poly Trio C60 System Hardware Feature Descriptions

Reference Number	Feature	Feature Description
1	Volume keys	Adjusts the volume of the audio from the speakerphone and ringer.
2	Mute key	Mutes the microphones during calls and conferences. The key glows red when activated.
3	Proximity sensor	Wakes the system when it detects user movement nearby. Note: Don't press on the proximity sensor. Doing so may damage the sensor and the system.
4	USB ports	The USB host port, found on the side of the phone, enables you to connect a USB flash drive to record calls. The USB device port, found on the bottom of the phone, enables you to connect a computer using a micro USB cable to use the system as a speakerphone for calls.
5	Touchscreen	Enables you to select items and navigate menus on the touch-sensitive screen.

Reference Number	Feature	Feature Description
6	Speaker and microphones	Sends your audio to call participants and provides audio output for the ringer and speakerphone.
7	Security slot (on back)	Enables you to attach a universal security cable lock to your phone so you can secure it to a desktop.

Related Links

[Connecting a Device Using a USB Cable](#) on page 52

[Features for Mobility-Impaired Users](#) on page 60

Navigating Poly Trio C60

The phone has icons, status indicators, and user screens to help you navigate and understand important information on the state of your phone.

Accessing Screens on the Poly Trio C60 System

You can access the following screens on your phone:

- **Home** - Displays your messages, settings, and information.
- **Calls** - Displays all active and held calls on your line.
- **Place a Call** - Enables quick access to the dialpad, **Recent Calls**, **Contacts**, and **Calendar**.



Access the Home Screen

The **Home** screen displays icons you can use to access features, settings, additional registered lines, and favorite contacts.

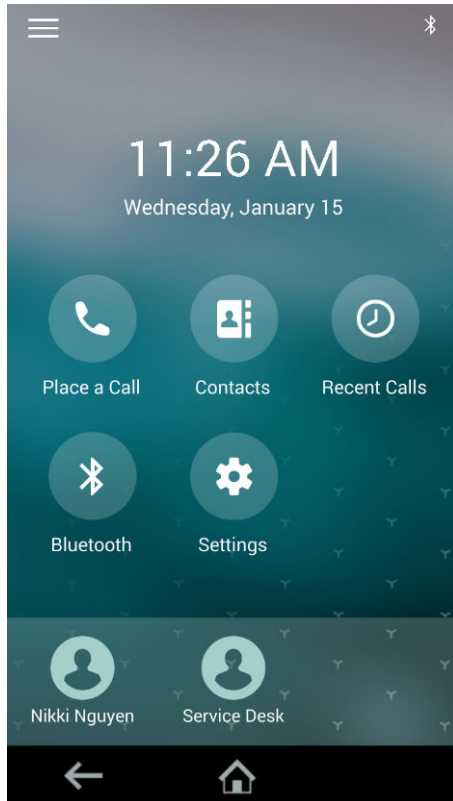
Figure 2: Home screen



Procedure

- » Do one of the following:
 - Select **Home** .
 - Select **Menu**  > **Home** .

Expand or Contract the Home Screen

You can use the page indicator to control how many icons display on the **Home** screen.

The page indicator displays on the **Home** screen beneath the menu options. It indicates which page you're currently viewing as a series of dots. If you have larger menu option icons, the system requires pages to accommodate them all. Smaller icons allow the system to display more menu option icons on the **Home** screen at once and fewer pages to scroll through.

Procedure

- » On the **Home** screen, press and hold the page indicator to switch between large or small menu option icons.

Access the Place a Call Screen



The **Place a Call** screen on Poly Trio C60 displays when you select **Place a Call** on the **Home** screen or when the system is idle (if set by your administrator).

From the **Place a Call** screen, you can access the dialpad, **Contacts**, **Recent Calls**, and the **Calendar**.

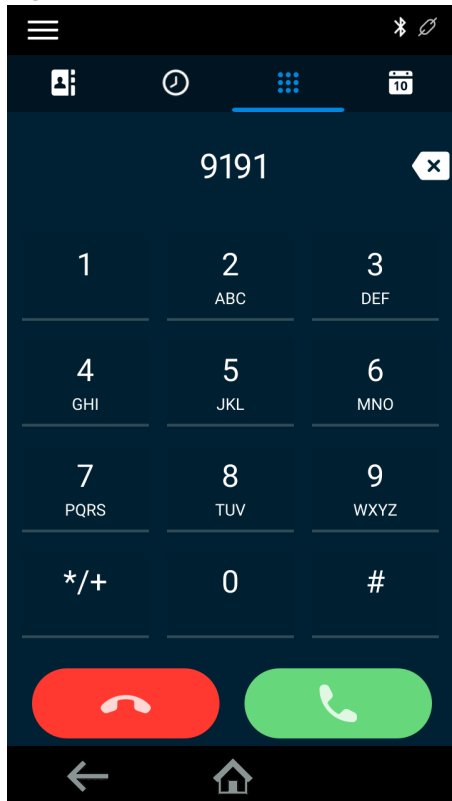
Figure 3: Place a Call screen



Procedure

- » Do one of the following:
 - Select **Place a Call** .
 - Select **Menu**  > **Place a Call** .

Calls Screen Overview

The **Calls** screen on Trio C60 systems display automatically when you place a call and when you have an active call in progress.

When you have an active call in progress, the name and number of the contact you are talking with and the duration of the call displays on the **Calls** screen.

Figure 4: Active call on the Calls screen

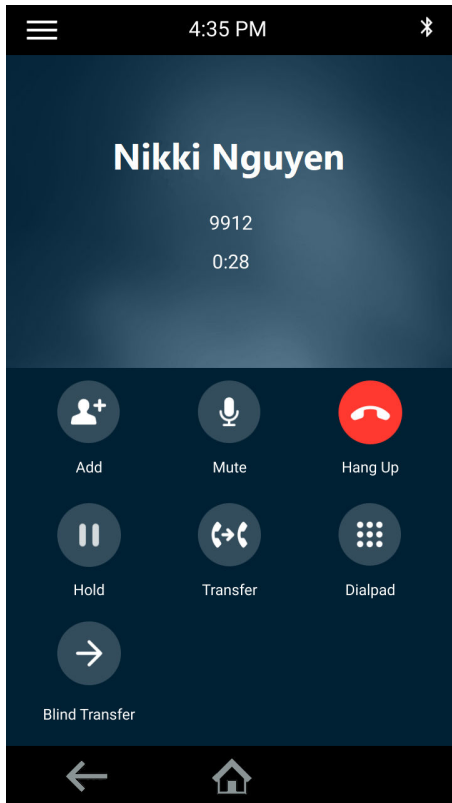

You can also view active and held calls in progress on the phone. If the phone has multiple lines, active and held calls display under the associated line.

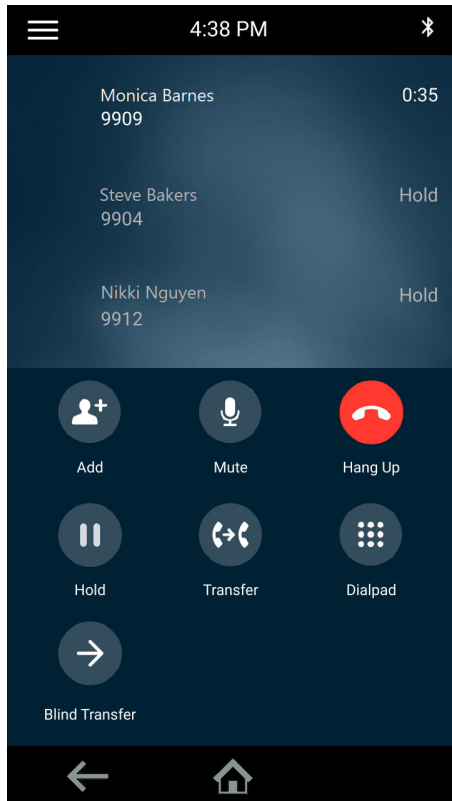



Figure 5: Multiple calls on the Calls screen

Icons and Status Indicators

The following table displays the icons and status indicators that display on your phone.

Icons and Status Indicators

Icon	Description
	Registered line
	Unregistered line
	Active call
	USB device attached
	Missed call
	Placed call
	Received call
	Call Forwarding enabled





Icon	Description
	Do Not Disturb enabled
	Bluetooth
	Wireless status
	Paired device

Entering Information Using the Onscreen Keyboard

The onscreen keyboard available on Trio C60 systems enables you to enter information into text fields using the touchscreen.

The onscreen keyboard displays on your screen automatically when a text field displays. When a text field requires only numbers, the onscreen keyboard displays only numbers.

The following icons also display on the keyboard:

- **Letters**  - Displays alphabetical letters
- **Uppercase**  - Shifts to uppercase letters
- **Lowercase**  - Shifts to lowercase letters
- **Numbers and Punctuation**  - Displays numbers and punctuation marks
- **Special characters**  - Displays special characters

Change the Phone Language and Keyboard Layouts

When you set the phone language and country, the phone uses the default keyboard layout for that language. For example, setting the phone language to French sets the phone to the AZERTY keyboard layout. You can enable multiple languages for the phone and switch between keyboard layouts.

You can enable multiple languages for the phone and switch between keyboard layouts.

Procedure

1. On the phone's keyboard, long-press and release the comma key and choose **Input Languages**.
2. Clear the **Use System Language** check box.
3. Select one or more available languages and press the back arrow.

The phone enables each language you select, along with its default keyboard layout. When you enable more than one language, a globe key displays on the phone keyboard.

4. Do one of the following:
 - Long-press the globe key to view and choose from a list of enabled languages. The phone uses the default keyboard layout for the language you choose.
 - Short-press the globe key to rotate through enabled languages. The space bar displays the current language and keyboard layout.

Switching Call Applications

Poly Trio C60 systems allow you to switch between different call applications.

Trio C60 systems can switch between the different available call applications on your phone. The list of available call applications includes Microsoft Teams, Skype for Business, Zoom Rooms, as well as the generic Poly call application.

Related Links

[Make a Call Using a Different Call Application](#) on page 30

Logging In to and Locking the System

Topics:

- [Logging In to Poly Trio C60](#)
- [Locking Poly Trio C60](#)
- [Change Your Login Password](#)
- [Change Your User Password](#)

You can log in to and lock a Poly Trio C60 system with the user credentials provided by your system administrator.

Logging In to Poly Trio C60

If your system administrator has set up user credentials for your phone, you can log in to a phone and access your contacts or favorites, settings, and calendar (if enabled).

You can view your personal settings from any phone or system within your organization. Contact your system administrator for your user credentials.

Note: Some of the features described in this section require access to the **Basic** settings menu. If your phone requires a password to access the **Basic** settings menu, contact your system administrator for assistance.

Log In to a Phone

Depending on how your system administrator set up your user login options, you may need to log in to a Poly phone before you can use one.

By default, Poly devices don't require you to log in before you can use them. If you don't log in, you see the default profile. When you log in, you have full access to your personal settings and your directory.

Any settings you change while logged in on a public phone commit to your profile and display the next time you log in to any phone.

Procedure

1. If you see the **User Login** screen, proceed to the next step.
If you don't see the **User Login** screen, go to **Settings > Features > User Login > Log In**.
2. Enter your user ID and password, and select **Log In**.

Your personal profile displays when you enter the correct login credentials. If you enter incorrect credentials, a message indicating that your login attempt has failed displays and the **User Login** screen displays again. Check with your system administrator to confirm your login credentials.

Log Out of the Phone

After you finish using a public phone, make sure you log out to prevent access to your personal settings.

Procedure

1. Select **Log Out** or go to **Settings > Features > User Login > Log Out**.
The Log Out screen displays with a confirmation message.
2. Select **Yes**.
Your personal profile is no longer accessible, and either the User Login screen displays for the next user or the default profile displays.

Locking Poly Trio C60

If your system administrator has set up the system to lock when it isn't in use, you must unlock it before you can use the system.

Your system administrator provides you with a user password that you can use to unlock Poly Trio systems.

With the system locked, you can do the following:

- Place outgoing calls only to emergency and authorized numbers.
- Enter a password to answer incoming calls.

Related Links

[Place a Call from a Locked Phone](#) on page 21

[Answer a Call on a Locked Phone](#) on page 24

Lock the Phone

You can lock a phone so that only authorized personnel can use it. Some features are available for users with a valid user password.

Procedure

1. Go to **Settings > Basic > Lock Phone**.
2. On the **Lock Phone** screen, select either of the following options:
 - **Allowing ringing when locked** - Incoming calls ring on the system, and you can answer calls by entering a user password.
 - **DND when locked** - Do Not Disturb applies to all lines, and the system doesn't ring for incoming calls.
3. Select **Lock**.

Unlock the Phone

You can unlock the phone with your user password.

Procedure

1. Select **Unlock**.

2. Enter your user password (or guest PIN if signed in as a guest on a host phone) and select **Unlock**.

Change Your Login Password

You can change your login password from any phone on your network.

Procedure

1. Log in to a phone on your network.
2. Go to **Settings > Features > User Login > Change User Login Password**.
3. On the **Change User Login Password** screen, enter your old and new password information and select **Enter**.

Your password changes. The next time you log in to a phone, you must enter your new password.

Change Your User Password

You can change your user password at any time from the **Advanced** settings menu on Trio C60.

The Advanced settings menu requires a password to access the menu options. Ask your system administrator for the password if you cannot access menu.

Procedure

1. Go to **Settings > Advanced**.
2. Enter your user password and select **Enter**.
3. On the **Advanced** screen, select **Change User Password**.
4. On the **Change User Password** screen, enter your old and new user password and select **Enter**.

Audio Calls

Topics:

- [Placing Audio Calls](#)
- [Calling Contacts from the Directory](#)
- [Placing Intercom Calls](#)
- [Answering Audio Calls](#)
- [Decline an Incoming Call](#)
- [End an Audio Call](#)
- [Holding and Resuming Calls](#)
- [Transferring Calls](#)
- [Forwarding Incoming Calls to a Contact](#)
- [Rejecting Calls with Do Not Disturb](#)
- [Managing Multiple Calls](#)
- [Make a Call Using a Different Call Application](#)
- [Mute the Microphones](#)
- [Unmute the Microphones](#)

By default, your phone has one registered line.

You can manage a maximum of active, incoming, or held audio calls at a time on the line. However, you can have only one active call in progress with numerous other incoming calls or calls on hold.

Placing Audio Calls



Poly phones enable you to place calls to local numbers, international numbers, and Skype for Business contacts.

You can initiate calls from your favorites list, recent calls list, and your phone directory. From a locked phone, you can place calls to numbers authorized by your system administrator.

Place an Audio Call

You can call a contact using a number or IP address from the dialpad or onscreen keyboard.

Procedure

1. Select **Place a Call**.
2. Enter your contact's number, or select the onscreen keyboard  and enter an IP address.
3. Select **Dial** .

Place an International Call

You can place calls to international phone numbers on your phone.



Procedure

1. On the dialpad, quickly press the star key (*) twice.
A plus sign (+) displays.
2. Enter the country code and phone number then select **Dial** .

Place a Call from Recent Calls

You can place calls from the **Recent Calls** list, which contains calls that you recently placed, answered, or missed.

Procedure

1. Do one of the following:
 - From the **Home** screen, select **Recent Calls** .
 - From the **Place a Call** screen, select **Recent Calls** .
2. Select a contact.
The call begins automatically after you select a contact.

Related Links

[Recent Calls](#) on page 43

Call a Favorite

Contacts you add as favorites display at the bottom of the **Home** screen with an avatar. You can place a call to favorites by selecting the favorite's avatar.

Procedure

- » On the **Home** screen, select a favorite.

Place a Call over Bluetooth

You can pair and connect your phone with a Bluetooth-enabled mobile phone or tablet. Calls placed call on your device and use the phone as a speakerphone for the call. These steps apply to most mobile phones and tablets. For more information refer to your mobile phone or tablet's product documentation.

Procedure

1. Connect your device with the phone over Bluetooth.
2. On your device, place a call to a contact and select the Trio C60 as the audio source.

Related Links

[Connecting Devices Using Bluetooth](#) on page 51

Place a Call from a Locked Phone

When the phone is locked, you can place outgoing calls only to emergency numbers, such as 911, and authorized numbers that your system administrator sets up. You can't call any other numbers from a locked phone.

Procedure

1. Select **New Call**.
2. From the **Place an Authorized Call** screen, choose a number and select **Dial**.

Related Links

[Locking Poly Trio C60](#) on page 17

Redial a Number

Your phone automatically keeps a record of all calls placed. You can recall the last contact you called using **Redial**, if enabled by your system administrator.

Procedure

- » Select **Redial**.



Calling Contacts from the Directory

On Poly Trio C60 systems, you can search for and call contacts in your contact directory, the corporate directory, and the BroadSoft directory.

Call a Contact from a Directory

Place a call directly from your directory or select contacts in your directory to call on the **Place a Call** screen.

Procedure

1. Do one of the following:
 - Go to **Contacts** and select a directory.
 - Go to **Place a Call**, select **Contacts** , and select a directory.
2. Select a contact.
3. On the **Details** screen, select **Call**  next to the number you want to call.

Call a Contact from a Directory Search

Search for and call contacts on the **Search** screen in your directory.

Procedure

1. Select **Contacts** and select a directory.
2. In the **Search** field, enter your contact's name.
Results that match your search display automatically.
3. Select a contact.

4. On the **Details** screen, select **Call**  next to the number you want to call.

Placing Intercom Calls

Like a normal call, the intercom feature enables you to place a call to a contact.

An intercom call differs from a normal call in that the call recipient's phone answers automatically when not in an active call. Check with your system administrator to find out if this feature is available on your phone.

If the call recipient has an active call, the recipient can choose to answer the intercom call. Otherwise, the phone answers the intercom call automatically after their active call ends.

Related Links

[Answer an Intercom Call](#) on page 24

Place an Intercom Call

You can place an intercom call from your phone to quickly relay a message to a contact.

Tip: Your system administrator can set up your phone to automatically call a specific contact when you select **Intercom**. If your phone is set up this way, select **Intercom** and wait for your contact to answer before speaking your message.

Procedure

1. Select **Intercom**.
2. Enter a number or select a contact.
3. Select **Dial** .

The phone plays a tone and the contact's phone answers the call automatically.
4. After your contact answers the call, speak your message and select **Hang Up** .



Place an Intercom Call During a Call

You can place an intercom call to another contact during an active call.

Procedure

1. Select **Hold > Intercom**.

The active call goes on hold and the dialpad displays.
2. Enter a number or select a contact.
3. Select **Dial** .

The phone plays a tone and the contact's phone answers the call automatically.
4. After your contact answers the call, speak your message and select **Hang Up** .
5. Select **Resume** .

Answering Audio Calls

When you receive an incoming call on your phone, you can choose to answer the call in a number of different ways.

Answer an Incoming Call

When you receive an incoming call, the phone rings and the **Incoming Call** screen displays. On the **Incoming Call** screen, you can choose to answer or reject the incoming call.

Figure 6: Incoming call screen

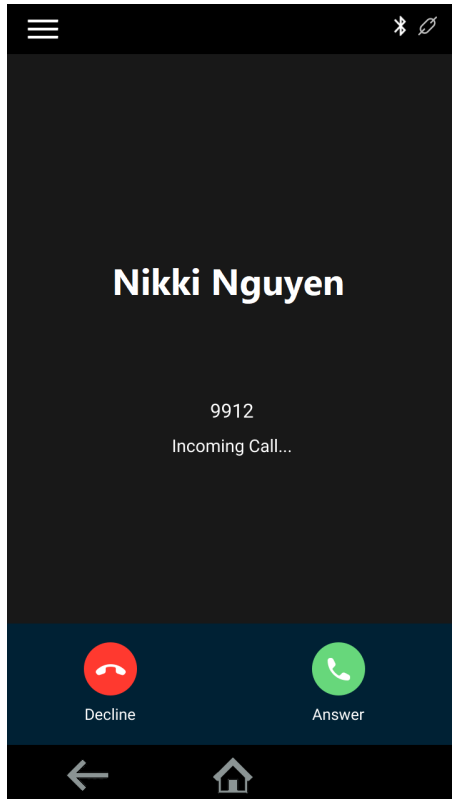

Note: Your system administrator can enable the screen to flash bright orange when you have an incoming call. The screen continues to flash until the **Home** or **Calls** screen displays the incoming call. For more information about this feature, contact your system administrator.

Procedure

- » Select **Answer** .

If enabled, you can answer calls using the **Mute** button.

Related Links

[Decline an Incoming Call](#) on page 25

Answer a Call When in a Call

When you're in an active call and an incoming call arrives on the same or a different line, a call waiting tone beeps and the **Incoming Call** screen displays.

Procedure

- » Select **Answer**.

This places the active call on hold, and the incoming call becomes active.

Answer Calls Automatically

You can set up your phone to automatically answer calls using Auto Answer.

When enabled, the phone automatically answers all incoming calls using the speakerphone. Your system administrator sets how many times the phone rings before it automatically answers the call.

The phone doesn't automatically answer a call until you place your current call on hold or end it.

Procedure

1. Go to **Settings > Basic > Preferences**.
2. Select **Auto Answer**.
3. Select **Auto Answer SIP Calls** and select **Yes**.
4. Select **Microphone Muted** and choose **Yes** (the default setting) to mute the microphone for auto-answered calls.
5. Select **Save**.

Related Links

[#unique_53](#)

[Features for Mobility-Impaired Users](#) on page 60

Answer a Call on a Locked Phone

You can enable your phone to accept calls while it's locked. To answer calls on a locked phone, enter your password.

Procedure

1. On the **Incoming Call** screen, select **Answer**.
2. Enter your password and select **Enter**.

The call connects.

Related Links

[Locking Poly Trio C60](#) on page 17

Answer an Intercom Call

When you receive an intercom call, your phone answers the call automatically as long as you don't have an active call already.

If the phone answers an intercom call with your microphone muted, you must unmute your microphone before responding to the call.

Related Links

[Placing Intercom Calls](#) on page 22

Decline an Incoming Call

You can decline an incoming call and send the call directly to voicemail.

Declined calls display in the **Missed Calls** list in **Recent Calls**. You can't decline calls for shared lines.

Procedure

- » In the **Incoming Call** screen, select  **Decline**.



Related Links

[Answer an Incoming Call](#) on page 23

End an Audio Call

You can end active calls at any time. To end a held call, resume the call and then end it.

Procedure

- » Do one of the following:
 - Select **Hang Up** .
 - On the **Calls** screen, select the call and select **Hang Up** .
 - On the **Calls** screen, select a held call, select **Resume** , and select **Hang Up** .

Holding and Resuming Calls

When you are in a call, you can place an active audio call on hold and resume the call.

The **Mute** keys and microphones glow red when you place a call on hold. The **Mute** keys and microphones flash green when the other contact places you on hold.

Hold a Call

Place an active call on hold.

Procedure

- » During an active call, select **Hold**.

Resume a Call

View and resume a held call.

Procedure

- » Do one of the following:
 - Select **Resume**.

- From the **Calls** screen, select the call and select **Resume**.

Transferring Calls

You can transfer active or held calls to another contact.

Use one using the following transfer types:

- Blind transfer - Transfers the call directly to another line without speaking with the other party first.
- Consultative transfer - Enables you to speak with the other party before completing the transfer.

Choose a Default Transfer Type

Your phone is preconfigured to use consultative as the transfer type, but you can choose a default transfer type to use for all calls on your phone.

Procedure

1. Go to **Settings > Basic > Preferences**.
2. Select **Default Transfer Type** and choose a transfer type.

All calls use the selected transfer type you select.

Transfer a Call Using Blind Transfer

When you use Blind call transfers, calls transfer as soon as the recipient's line connects.

Procedure

1. During a call, select **Transfer** .
2. Dial a number or select a contact from **Recent Calls** or **Contacts**.

The call transfers as soon as the recipient's line connects.

Transfer a Call Using Consultative Transfer

When you use Consultative call transfers, you can speak with the recipient and then manually complete the transfer.

Procedure

1. During a call, select **Consult** .

The phone places the caller on hold while you start the transfer.
2. Dial a number or select a contact from **Recent Calls** or **Contacts**.
3. When the recipient answers, speak with them and then select **Complete Transfer**  to transfer the call.

If the recipient either doesn't answer your call, or can't accept the call transfer and hangs up before you transfer the call, the original caller stays on hold. You can resume that call or try to transfer to another recipient.

Cancel a Transfer

If a contact does not answer the transfer or you want to remain speaking with the contact on your line, you can cancel the transfer before it is complete.

Procedure

- » Select **Cancel**.
The call doesn't transfer and becomes active.

Forwarding Incoming Calls to a Contact

You can forward incoming calls to one of your contacts.

Forward an Incoming Call to a Contact

You can forward an incoming call directly to a contact without answering the call.

Note: On shared lines, you must answer a call before forwarding it to a contact.

Procedure

1. On the **Incoming Call** screen, select **Menu**  and select **Forward**.
2. On the **Call Forwarding** screen, enter the forwarding number and select **Forward**.

Forward All Incoming Calls to a Contact

You can set up your phone to automatically forward incoming calls to a specific contact.

Use one of the following forwarding types:

- **Always** - Forwards all incoming calls.
- **No Answer** - Forwards all unanswered incoming calls.
- **Busy** - Forwards incoming calls when you're in a call.

For shared lines, you can only choose **Always** as your forwarding type; the other forwarding options aren't available for shared lines.

Procedure

1. Select **Forward** or go to **Settings > Features > Forward**.
2. On the **Forwarding Type Select** screen, select a forwarding type.
3. Enter a contact's number or IP address, if enabled, and select **Enable**.
4. Optional: If you selected the **No Answer** option, enter the number of rings before the call is forwarded.

The forwarding number or name of the contact you chose scrolls in the status bar. When you select **Always** as your forwarding option, the **Forwarding** icon  displays on the line.

Disable Call Forwarding

You can disable call forwarding when you no longer want to forward your calls.

Procedure

1. Go to **Settings > Features > Forward**.
2. On the **Forwarding Type Select** screen, select **Disable Call Forwarding**.

Rejecting Calls with Do Not Disturb

Do Not Disturb (DND) enables you to set your phone to automatically reject calls when you don't want to be interrupted.

When you enable DND, you see the following:

- The **DND**  icon displays in the status bar.
- When the phone is idle, the **DND** icon displays next to your phone line.
- When the administrator enables hybrid line registration on the phone, you can choose **All** to enable DND on all the registered lines.
- If you have new messages or you have enabled call forwarding, the messages or forwarding icon display instead of the **DND** icon.

Note: When you set your presence status to **Do Not Disturb** and enable **DND** on your phone, a message reflecting your Do Not Disturb status scrolls under the time display. The **DND** icon doesn't display in the status bar.

Enable Do Not Disturb

Enable DND to prevent your phone from ringing and to send all incoming calls to voicemail. The phone logs all calls you receive while on DND in the **Recent Calls** list.

Enabling DND on shared lines disables ringing only. A visual notification of the call still displays, and you have the option to answer or ignore the call.

Procedure

- » Do one of the following:
 - Select **DND** on the **Home** screen, if enabled by your system administrator.
 - Go to **Settings > Features > Do Not Disturb** and select **Enable**.

Disable Do Not Disturb

When you're ready to receive calls, disable DND.

Procedure

- » Go to **Settings > Features > Do Not Disturb** and select **Disable**.

Managing Multiple Calls

Manage multiple active, incoming, or held calls.

In the **Calls** screen, you can view active and held calls, including conference calls. The following figure shows an active call and a held call.

Figure 7: Multiple calls on the calls screen

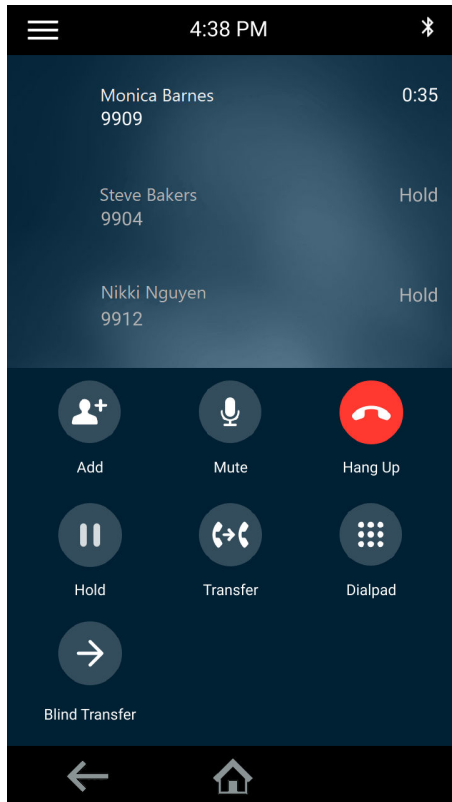

Manage a Call from the Calls Screen

From the **Calls** screen, you can manage a call by holding, resuming, or transferring the call.

Procedure

1. Select a call.
2. Do one of the following:
 - Select **Hold** to place an active call on hold.
 - Select **Resume** (⏮) to make a held call active.
 - Select **Hang Up** (📞) to end a call with a contact. You can end active calls only, so resume the held call first before ending it.
 - Select **Transfer** (📞) to send the call to another contact.

Make a Call Using a Different Call Application

You can make a call in a different call application by switching the system's active call application.

Procedure

1. Swipe upwards on the bottom of the touchscreen.
The Nav bar displays.

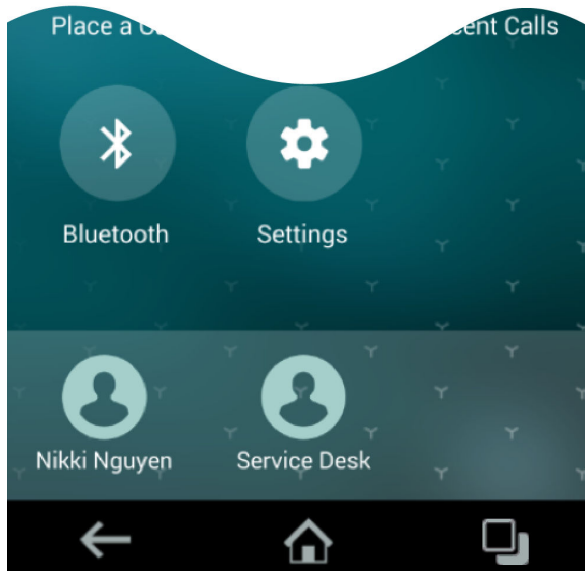

2. On the Nav Bar, tap the **App Switch**  icon to switch to another call application.
3. Repeat these steps to select the desired call application.



Related Links

[Switching Call Applications](#) on page 15

Mute the Microphones

Mute the microphone so other parties can't hear you.



Procedure

- » Do one of the following:
 - Select **Mute** .
 - Select the Mute key  on the phone.
 - Select the Mute key  on the microphone.

Unmute the Microphones

Unmute your audio when you're ready to speak and let others on the call hear you.

Procedure

- » Do one of the following:
 - Select **Unmute** .
 - Select the Mute key  on the phone.
 - Select the Mute key  on the microphone.

Conference Calls

Topics:

- [Initiate a Conference Call](#)
- [Merge Calls into a Conference Call](#)
- [Add Participants to a Conference Call](#)
- [End a Conference Call](#)
- [Hold a Conference Call](#)
- [Resume a Conference Call](#)
- [Mute a Conference Participant](#)
- [Remove a Conference Participant](#)

You can initiate and manage up to 12 audio conference calls on a Poly Trio C60 system.

Initiate a Conference Call

You can initiate a conference by adding a contact to an active call. This merges the contacts into a conference call. A single conference call can have up to four participants.

While the system can manage up to 12 conference calls, you can have only one active conference call at a time. You can keep other conference calls on hold.

If your system administrator enables the conference Management feature on your phone, you can manage each participant in the call. With the conference Management feature, you can mute, hold, and remove individual participants in a conference call.

Procedure

1. Call a contact.
2. After the contact answers, select **Add** + .
3. Enter another contact's number or select a contact from Contacts or Recent Calls.
The contact is added to the conference call after answering.

Merge Calls into a Conference Call

You can merge an active call and a held call to initiate a conference call.

Procedure

1. In the **Calls** screen, choose a held call.
2. Select **Merge**  .
The held call merges with the active call to initiate a conference call.

Add Participants to a Conference Call

You can add up to four contacts to a conference call.

Procedure

1. During a conference call, select **Add Participants**.
2. Enter a contact's number or select a contact from Contacts or Recent Calls and select **Dial**.
The contact is added to the call after answering.

End a Conference Call

By default, when you end a conference call, your connection to the call ends and the other participants in the conference remain in the call. Your system administrator can set up your phone so that all connections terminate when you end a conference call.

Procedure

- » During a conference call, select **Hang Up** .

Hold a Conference Call

When you place a conference call on hold, you place all conference participants on hold.

Procedure

- » Select **Hold** .

Resume a Conference Call

Resuming a held conference call enables all participants to hear the audio of everyone on the call.

Procedure

- » Select **Resume**.

Mute a Conference Participant

You can mute individual participants in a conference call, if enabled by your system administrator.

Procedure

1. During a conference call, choose a participant.
2. Select **Mute** .

The muted participant can hear everyone, but no one can hear the muted participant.

Remove a Conference Participant

You can remove individual participants from a conference call, if enabled by system administrator.

Procedure

1. During a conference call, choose a participant.
2. Select **Hang Up** .

Recording Audio Calls

Topics:

- [Guidelines When Recording Calls](#)
- [Record a Call](#)
- [Pause a Recording](#)
- [Resume a Recording](#)
- [Stop Recording](#)
- [Browse Recorded Calls](#)
- [Play a Recorded Call](#)
- [Pause and Resume Played Recordings](#)
- [Stop Playing a Recording](#)
- [Rename a Recording](#)
- [Delete a Recording](#)

You can connect a USB flash drive to a Poly Trio C60 system and record audio calls onto the drive.

Recordings save as `.wav` files on the USB flash drive, and you can record up to four hours in one `.wav` file. You can replay recordings on the phone or on a computer.

For a list of supported USB flash drives to record phone audio, see *Technical Bulletin 38084: Supported USB Devices* at [Polycom Support](#).

Note: If your phone doesn't detect the USB device when you insert it into the USB port, the USB port on your phone may be disabled. Contact your system administrator for assistance using the USB port.

Guidelines When Recording Calls

Use the following guidelines when recording audio calls on your phone.

- Inform contacts when you're recording a call.
- Make sure to mute your audio when you're placed on hold while recording the call.
- During an active call, pause your recording before answering incoming calls. All incoming calls you answer after you start recording are also recorded in the same file. For example, on June 22, 2019, at 11:22 a.m., you answer a call from person A. During your call with person A, you answer calls from person B and person C. All three calls are recorded in the same file.

Record a Call

The phone allows you to record an active audio call. Make sure to inform your contacts on the call before you begin recording.

Some things to note about recording:

- You can't record when there are no connected calls, when you place a new call to transfer a call or initiate a conference, or when you have an incoming call.
- Your phone records some tones that your contact's phone makes.
- When you mute your microphone while recording, the phone doesn't record your audio and records only the other participants' audio.

Procedure

- » During an active call, select **Menu**  > **Start Recording** .

The recording icon displays at the top of the **Call** screen.

Pause a Recording

During a call, you might need to pause a recording while the call is active.

Procedure

- » Select **Menu** > **Pause Recording** .

The pause recording icon displays at the top of the **Call** screen.

Resume a Recording

After you pause and then resume recording, recording continues in the same file.

Procedure

- » Select **Menu**  > **Resume Recording** .

Stop Recording

You can stop recording a call before the call ends. The recording also stops when the active call ends, no matter who ended the call.

Caution: Don't remove the USB flash drive while recording. Doing so may corrupt the file, preventing you from playing it back later. Removing the USB flash drive while recording can also damage the flash drive.

Procedure

- » Do one of the following:

- Select **Menu** ≡ > **Stop Recording** ■.
- Select **Hang Up**.

When you stop recording, the **USB** icon displays in the status bar.

Browse Recorded Calls

You can browse recorded files stored on the USB flash drive connected to supported phones.

Procedure

- » Go to **Settings** > **Features** > **Removable Storage Media** > **Browse Recordings**.

A list of recordings displays.

Play a Recorded Call

Play back calls recorded on a USB flash drive connected to your phone.

Note: You can't open and play recordings when you are in an active call or if you're recording a call. If you try to, the phone cancels the action. Place the call on hold before playing recordings. The recording stops playing when you resume the call.

Procedure

1. Go to **Settings** > **Features** > **Removable Storage Media** > **Browse Recordings**.

A list of recordings displays.

2. Select a recording.
3. Select **Open** > **Play**.

The length of the recording and a progress bar displays as the recording plays.

Pause and Resume Played Recordings

While playing a recording, you can pause the recording, perform another task on the phone, and resume the recording at any time.

When you receive an incoming call while playing a recording, the phone automatically pauses the recording playback. If you don't answer or reject the incoming call, the recording remains paused until you select **Resume**.

Procedure

1. To pause the recording, select **Pause**.
2. Select **Resume** to continue playing the recording.

Stop Playing a Recording

After you finish listening to a recording, you can stop playing it by exiting the recording.

Procedure

- » Select **Exit**.

Rename a Recording

By default, recordings are labeled with the date of the recording. You can rename recordings to provide them with more meaningful names.

Procedure

1. Go to **Settings > Features > Removable Storage Media > Browse Recordings**.
A list of recordings displays.
2. Select a recording.
3. Select **Rename**, update the file name, and select **OK**.

Delete a Recording

When you've played a recording or need additional space on your USB drive, delete recordings from the phone.

Procedure

1. Go to **Settings > Features > Removable Storage Media > Browse Recordings**.
A list of recordings displays.
2. Select a recording.
3. Select **Delete**.

Using the Calendar

Topics:

- [Open the Calendar](#)
- [View Meeting Details](#)
- [Meeting Reminders](#)
- [Joining Calendar Meetings](#)

When connected to Microsoft Exchange Server, you can view and join meetings scheduled in Microsoft Outlook from your phone.

Open the Calendar

To view and join scheduled meetings, access the calendar on your phone.

View meetings for the current day and upcoming meetings. You cannot view meetings for previous days.

Procedure

- » On the **Home** screen, select **Calendar**.



Company Meeting

9:30 - 10:30 AM

Join

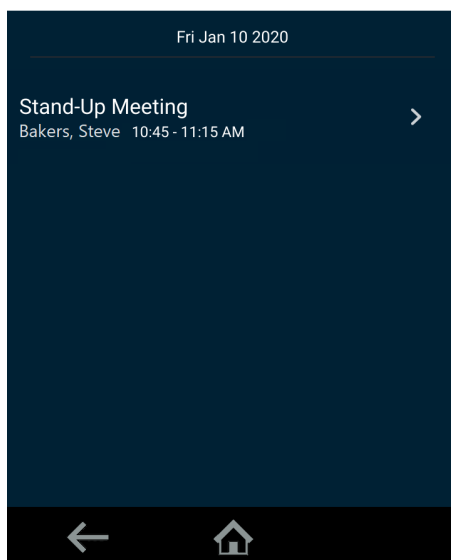

The calendar displays scheduled meetings for the day.

View Meeting Details

When you select a meeting on the calendar, you can view the meeting's start and end time, location, organizer, invitees, and meeting description.

Figure 8: Meeting details

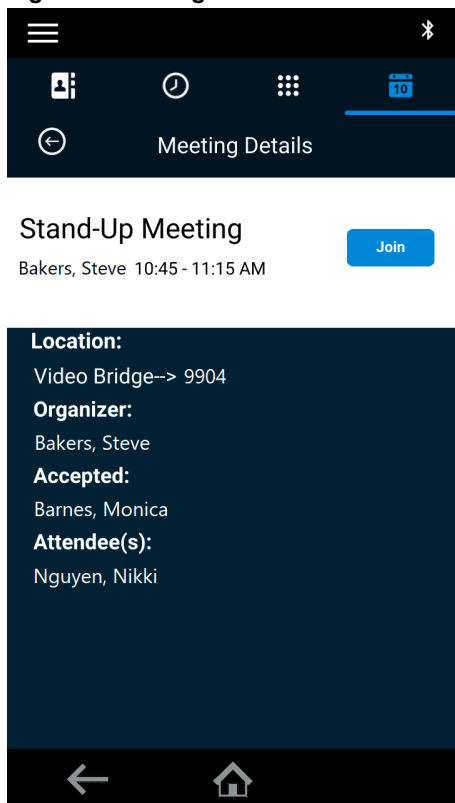

Procedure

- » On the calendar, select a meeting.

Meeting Reminders

When you have a scheduled meeting on the calendar, a meeting reminder displays and an alert tone plays 5 minutes and 1 minute before a meeting starts.

From the meeting reminder, you can view meeting details and join the meeting.

Figure 9: Meeting reminder



Note: If you have enabled meeting reminders but the reminders don't display before meetings, make sure that your login credentials are correct.

Choose a Meeting Reminder Type

Choose a meeting reminder type that determines if an alert tone plays each time a meeting reminder displays.

The following options are available for meeting reminders:

- **Silent**—The meeting reminder displays without an alert tone.
- **Audible Once**—An alert tone plays the first time a meeting reminder displays but doesn't play for any additional reminders.
- **Audible Always (default)**—An alert tone plays each time a meeting reminder displays.

Procedure

1. Go to **Settings > Basic > Preferences**.
2. Select **Calendar Settings > Reminder Settings**.
3. Select **Reminder Type** and choose a meeting reminder type.

Choose a Meeting Alert Tone

Choose the alert tone that plays for meeting reminders.

Procedure

1. Go to **Settings > Basic > Preferences**.
2. Select **Calendar Settings > Alert Tone**.
3. Choose an alert tone and select **Play** to hear the tone.

Disable Meeting Reminders

Meeting reminders are enabled by default. The phone displays reminders for all meetings. You can choose to disable meeting reminders on your phone.

Procedure

1. Go to **Settings > Basic > Preferences**.
2. Select **Calendar Settings > Reminder Settings**.
3. Select **Reminder > Disable**.

Joining Calendar Meetings

You can join any scheduled meeting from the calendar or from a meeting reminder.

Join a Meeting from the Calendar

You can join meetings from the calendar or from the **Meeting Details** screen.

Procedure

- » Do one of the following:
 - From the calendar, select **Join**.
 - In the **Meeting Details** screen, choose a meeting and select **Join**.

Join a Meeting from a Meeting Reminder

Join a meeting from the meeting reminder when it displays before a meeting, if enabled.

Procedure

- » Select **Join**.

Join a Meeting with an Alternate Number

If the meeting organizer has provided alternate numbers you can use to join the meeting, you can view and use alternate numbers to join the meeting.

Procedure

1. Select **Join** on the meeting reminder and select **More Actions**.
2. On the **Meeting Details** screen, choose a number.

Call Lists and Directories

Topics:

- [Recent Calls](#)
- [Local Directory](#)
- [Local Directory Favorites](#)
- [Corporate Directory](#)
- [Searching the BroadSoft Directory](#)

Note: Your phone may not support all of the features described in this section. Check with your system administrator to find out which features are available.

Recent Calls

The Recent Calls list includes missed, received, and placed calls. Each list holds up to 100 entries.

Perform the following tasks from the Recent Calls list:

- Remove calls from the list.
- Select a call record to view call details.
- Select a call record to automatically call a contact.

Related Links

[Place a Call from Recent Calls](#) on page 20

View Recent Calls

In the Recent Calls list, view a list of up to 100 missed, received, and placed call entries.



Procedure

- » On the Home screen, tap **Recent Calls**.

Edit a Recent Call Entry

Edit a contact's phone number stored in your Recent Calls list before returning the contact's call.

Procedure

1. Next to a call entry, select **Info** .
2. Tap **Edit** .
3. Edit the number then select **Dial**.

Save a Recent Contact

You can save a recent contact to the **Contact Directory**.

Procedure

1. Next to a call entry, select **Info** ⓘ.
2. On the **Call Details** screen, select **Save**.
3. Optional: If needed, edit the contact's information.
4. Select **Save**.

Delete a Recent Call Entry

You can delete any call entry from the Recent Calls list.

If you delete or move call entries on the phone, the changes save to that phone only. If you delete call entries in the Skype for Business client, the changes save to that phone and in the Skype for Business client.

Procedure

1. Next to a call entry, select **Info** ⓘ.
2. Select **Delete** ✖.

Local Directory

Add and save contacts in the phone's Local Directory, if allowed by your system administrator.

Your system administrator can set the Local Directory as read-only or require a password for access to the directory. Contact your system administrator for assistance accessing or updating the Local Directory.

Related Links

[Add Corporate Directory Contacts to the Local Directory](#) on page 47

Search for a Local Directory Contact

In the Local Directory, enter a search criteria to find your desired contact.

Procedure

1. Go to **Contacts > Local Directory**.
2. In the **Search** field, enter your contact's name.
Results that match your search display automatically.

Add a Contact to the Local Directory

When you add a contact to your local directory, you can choose how much information you want to enter for your contact. You're required to only enter a contact number for each new contact.

Procedure

1. Go to **Local Directory > Add** +.
2. On the **Add Contact** screen, enter your contact's information in the available fields.

3. Select **Save**.

View Contact Details

From your local directory, you can view information for any contacts saved to the directory.

Procedure

1. Go to **Contacts > Local Directory**.
2. Choose a contact.

The **Details** screen displays with the contact's name, number, and any additional information, such as a job title or email address.

Update a Local Directory Contact's Information

After you add a contact to your local directory, you can update the contact's information.

Procedure

1. In the **Local Directory**, select a contact.
2. On the **Details** screen, select **Edit** .
3. On the **Edit Contact** screen, update the contact's information.
4. Select **Save**.

Delete a Local Directory Contact

You can delete any contact from the local directory.

Procedure

1. In the **Local Directory**, select a contact.
2. On the **Details** screen, select **Delete Contact**.
3. Select **Yes** to delete the contact.

Local Directory Favorites

Favorites are the contacts in your local directory that you call most often.

Contacts that you add as favorites display on the **Home** screen. Only three favorites display onscreen at a time, however, you can swipe the screen from right to left to display additional favorites. Favorites also display at the top of the list of contacts in the **Local Directory**.

Add Favorites

Add any contact in the local directory as a favorite.

When you add a contact as a favorite, the contact displays on the Home screen.

Procedure

1. Go to **Contacts > Local Directory**.
2. Select a contact.

3. On the **Details** screen, select **Favorite** ★.

Remove a Favorite

Remove a favorite contact to make room for a new favorite.

Procedure

1. Go to **Contacts > Local Directory**.
2. Select a contact.
3. On the **Details** screen, select **Favorite** ★.

Corporate Directory

Your system administrator can set up your phone so that you can access a corporate directory, which lists contacts and groups within your company.

However, you can't update the corporate directory, and your system administrator determines which contacts you can see. Check with your system administrator to find out if this feature is available.

Note: You may need to enter your user credentials to access the directory for the first time, if set by your system administrator.

Search the Corporate Directory

You can search for contacts in the Corporate Directory using either their first name or last name.

Procedure

1. Go to **Contacts > Corporate Directory**.
2. In the search field, enter your search criteria and select **Submit**.
3. Choose a contact and select **View** to view the contact's information.

Perform an Advanced Search of the Corporate Directory

An advanced search enables you to choose to search for contacts by first name, last name, or phone number.

Procedure

1. Go to **Contacts > Corporate Directory**.
2. In the **Corporate Directory**, select **AdvFind**.
3. In the search field, enter your search criteria and select **Submit**.
4. Choose a contact and select **View** to view the contact's information.

Add Corporate Directory Contacts to the Local Directory

You can add contacts in the corporate directory to the local directory.

When you save a corporate directory contact to the local directory, the first name, last name, and phone number of the contact automatically save to the directory. You can add additional contact information the contact in the directory afterward.

Procedure

1. In the **Corporate Directory**, search for a contact.
2. From the search results, choose the contact and select **View**.
3. Select **Save**.
4. Enter any additional contact information and select **Save**.

Related Links

[Local Directory](#) on page 44

Searching the BroadSoft Directory

You can access and search the BroadSoft directory on the phone, and you can choose to perform a simple or advanced search for contacts.

After the system administrator configures the enterprise directory, you can view a list of contacts by default in the BroadSoft directory. The default contacts list displays even with a blank search of the directory.

Search the BroadSoft Directory

Searching the BroadSoft directory allows you to search for contacts using either their first name, last name, or by typing a few letters of their name. You can view a maximum of 50 contacts at one time.

Procedure

1. Go to **Contacts > BroadSoft Directory**.
A default list of contacts displays.
2. In the search field, enter your search criteria and select **Submit**.

Perform an Advanced Search of the BroadSoft Directory

An advanced search enables you to choose to search for contacts by first name, last name, or phone number.

Procedure

1. Go to **Contacts > BroadSoft Directory**.
A default list of contacts displays.
2. Select **Advanced Search** and choose how you want to search for a contact: by first name, last name, or a contact number.
3. Optional: Do one of the following:
 - Select **Cs.Sn** to make the search case-sensitive.
 - Select **Cs.In** to make the search case-insensitive.

4. In the search field, enter your search criteria and select **Submit**.
5. Choose your contact.
A contact details screen displays.

Add BroadSoft Contacts to the Local Directory

After you find your BroadSoft contact, you can add the contact to the local directory.

Procedure

- » On the contact details screen, select **Add to local directory**.

The first and last name and phone number of the contact save to the contact directory. You can go to the contact directory to see if the contact saved correctly and to add additional contact information.

Voicemail and Pages

Topics:

- [Access Voicemail Messages](#)
- [Receiving Messages with Group Paging](#)

You can send, broadcast, and access a variety of audio messages on the phone.

Note: Your phone may not support all of the features described in this section. Check with your system administrator to find out which features are available.

Access Voicemail Messages

When there are voicemail messages available on the phone, an audible tone plays and an alert displays on the **Messages** icon.

Note: For information on setting the voicemail greeting or remotely accessing your voicemail, contact your system administrator or service provider.

Procedure

1. Go to **Settings > Features > Voicemail > Message Center**.
2. Select a line.
3. Select **Connect** and follow the voicemail prompts.

Receiving Messages with Group Paging

You can receive pages from any paging groups you're subscribed to. By default, you're subscribed to groups 1, 24 (priority pages and broadcasts), and 25 (emergency pages and broadcasts).

How and when you receive a page or broadcast depends on the priority, whether you are in an active call, and if you enable Do Not Disturb. When you receive a page, the page always plays through the speakerphone.

Note: Your system administrator must enable a phone to receive pages while in an active call.

Your system administrator can define up to 25 paging groups. Each group receives a label to identify it from the others. Example group labels are All, HR Dept, Shipping Staff, and Executives.

Each group has one of the following broadcast priorities:

- Normal - Broadcasts sent to groups 1 to 23 are considered normal broadcasts. By default, all phones can receive broadcasts sent to group 1.
- Priority - By default, broadcasts sent to group 24 are considered priority broadcasts. A priority broadcast interrupts normal broadcasts or active calls. All phones receive priority broadcasts unless you enable Do Not Disturb.

- Emergency - By default, broadcasts sent to group 25 are considered emergency broadcasts. An emergency broadcast interrupts normal broadcasts, priority broadcasts, and active calls. Emergency broadcasts play at near maximum volume, even if you enable Do Not Disturb.
-

Note: When you enable Do Not Disturb, you receive only emergency broadcasts, and non-emergency broadcasts don't play or display.

Listen to a Page During an Active Call

Pages received during an active call defer or automatically play depending on the page priority.

Pages received during an active call don't interrupt the call. The phone plays audio from both the call and the page at the same time. When you receive a page during a call:

- If configured by your administrator, standard priority pages play during active calls. Otherwise, the page displays on your phone as pending.
 - Priority and emergency pages play immediately.
-

Note: If you adjust the volume of a normal, nonemergency page while it plays, the phone uses the adjusted volume for all subsequent nonemergency pages. However, only your system administrator can change the volume of an emergency page.

Procedure

- » Do one of the following:
 - For normal pages that play automatically during a call, hold the call to hear only the page.
 - For pending pages, select **Accept** or hold the call to listen to the page.

Receiving Pages When Not in an Active Call

When you receive a page and you aren't in an active call, the page immediately plays, regardless of the paging priority.

While a page plays, you can do the following:

- Hold the page.
- End the page. This ends the page at your phone only.
- Place a new call.

Connecting Bluetooth and USB Devices

Topics:

- [Connecting Devices Using Bluetooth](#)
- [Connecting a Device Using a USB Cable](#)

You can connect a USB or Bluetooth-enabled laptop or mobile device to a Poly Trio C60 system.

When you connect a device to the Trio C60 system, you can use the system hardware for the connected device audio and calling functions.

Connecting Devices Using Bluetooth

The Bluetooth feature on Poly Trio C60 systems enables you to place calls on your mobile phone and use the system as a speakerphone for the call. You can also use the system to play audio from media, such as music or videos, from your mobile phone or tablet.

Note: The Trio C60 system doesn't automatically reconnect to previously paired Bluetooth devices after the device disconnects from the system or after a system reboot. You must manually reconnect and pair the Bluetooth device with the system.

Related Links

[Place a Call over Bluetooth](#) on page 20

Make the System Visible to Nearby Bluetooth Devices

Before you connect a Bluetooth device to a Poly Trio C60 system, make sure that the system is visible to nearby devices.

Procedure

1. On the **Home** screen, select **Bluetooth**.
2. Make sure the statement `Visible as "<System Name>" to other devices` displays below the menu options.

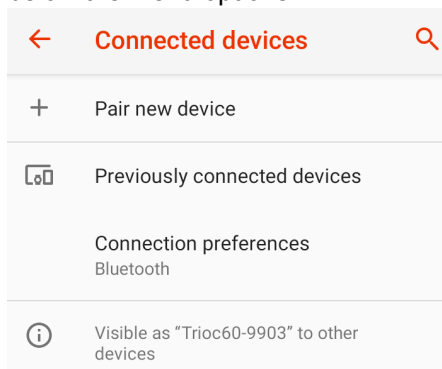

3. If the statement `Only visible to paired devices` displays, select the system's name.

The system is now visible to all nearby Bluetooth devices.

Connect a Bluetooth Device

You can connect a Bluetooth-capable mobile phone or tablet to a Poly Trio C60 system, if your system administrator has enabled Bluetooth on the system.

The system can remember up to 10 previously paired devices or fewer as set by your system administrator.

Procedure

- » On your device, turn on Bluetooth and select the name of the system in available devices.

Note: You can't connect to a Bluetooth device when you are in a call.

Play Audio from a Bluetooth Device

Use your phone as a Bluetooth speaker for music or videos played on your mobile phone or tablet.

Procedure

1. Connect your mobile phone or tablet with the phone.
2. On your mobile phone or tablet, choose the music or video you want to hear.
3. Make sure that the phone is set as your audio device.

The audio plays through the phone's speakers.

Connecting a Device Using a USB Cable

You can connect your computer, mobile phone, or tablet directly to the phone using a USB cable. With the USB connection, you can use the phone as a microphone for calls and as a speaker for audio calls or media.

When you connect a Microsoft Windows computer to the phone, you can control the volume of audio and video calls from the computer or on the phone. While connected, the call volume synchronizes on both devices.

Related Links

[Poly Trio C60 System Hardware Overview](#) on page 7

Minimum Hardware and Software Laptop Requirements

Before you connect your laptop to the phone, make sure that your laptop meets the minimum hardware and software requirements.

Minimum Hardware and Software Requirements for the Connected Laptop

Component	Requirement
Operating system	<ul style="list-style-type: none"> Windows 10 (32-bit or 64-bit) Windows 8.1 (32-bit or 64-bit) Windows 8 (32-bit or 64-bit) OS X 10.9.x (Mavericks) OS X 10.10.x (Yosemite) OS X 10.11.x (El Capitan) OS X 10.12.x (Sierra)
Desktop client or application	<ul style="list-style-type: none"> Skype for Business

Connect a USB Device or Laptop

When you connect your Poly phone to a laptop or mobile device, you can use it as a microphone and speaker.

Procedure

- » Connect your laptop or device to the micro USB port on the underside of the phone.

Setting Your Phone as the Audio Device

Set the phone as your audio communication device to use your phone to play call audio from your communication and collaboration clients or media from your connected laptop.

Set Your Phone as the Default Audio Device for Your Windows Laptop

You can set the connected phone as the default audio device to play media audio from your Windows laptop using the phone's speakers.

Procedure

1. On your laptop, go to **Start > Control Panel**.
2. In the **Control Panel**, go to **Hardware and Sound > Sound**.
3. Choose the phone you want to use and select **Set as Default Device**.
4. Select **OK**.

Poly Trio C60 Settings

Topics:

- [Password Required to Access Basic Settings](#)
- [Time and Date Display](#)
- [Set the Language](#)
- [Backlight Intensity and Timeout](#)
- [Enable or Disable Number Formatting](#)
- [Power Saving Mode](#)
- [Set a Ringtone for Incoming Calls](#)

You can make some basic customizations on the phone, which includes changing the time and date format, setting a language, and adjusting the screen brightness.

Password Required to Access Basic Settings

You may need a password to configure basic settings on your phone.

You can enable or customize your phone from the **Basic** settings menu. However, your system administrator may require a password to access the settings menu. If your phone requires a password to access the settings menu, contact your system administrator for assistance.

Time and Date Display

The time and date display in the status bar.

When the phone can't obtain a time and date, the time and date display flashes. If this happens, or if the time and date are incorrect, contact your system administrator.

Change the Time and Date Format

Customize the time and date by choosing between a variety of time and date formats, including options to display the day, month, or year.

Procedure

1. Go to **Settings > Basic > Preferences**.
2. Select **Time and Date** and select one of the following:
 - Select **Clock Date** to change the date format.
 - Select **Clock Time** to change the time format.
3. From the **Clock Date**, **Clock Time**, or **Clock Order** screen, select the format you want.

Disable the Time and Date Display

If desired, turn off the time and date display.

Procedure

1. Go to **Settings > Basic > Preferences**.
2. Select **Time and Date** and select **Disable**.

Set the Language

Poly phones support several languages that you can choose to display on the phone.

Check with your system administrator to find out which languages your phone supports.

Procedure

1. Go to **Settings > Basic > Preferences**.
2. Select **Language** and select a language.

The language on the phone updates immediately.

Backlight Intensity and Timeout

If desired, change settings for the following backlight components:

- **Backlight Intensity**—The brightness of the screen during phone activity and inactivity.
- **Backlight Timeout**—The number of seconds the phone is inactive before the backlight dims to its Backlight Idle intensity. The backlight timeout period begins after your last activity, such as an incoming call.

Backlight Intensity includes the following settings you can choose from:

- **Backlight On**—The brightness of the screen when there's activity.
- **Backlight Idle**—The brightness of the screen when there's no activity.
- **Maximum Intensity**—The brightness scale that applies to both Backlight On and Backlight Idle intensities.

Set the Backlight Intensity

Change the Backlight On intensity and the Backlight Idle intensity separately. Choose an intensity level or turn off the backlight entirely. When you change the Maximum Intensity, you modify the entire backlight intensity scale. For example, if you decrease the Maximum Intensity, the low, medium, and high levels for both Backlight On and Backlight Idle intensities decrease.

Procedure

1. Go to **Settings > Basic**.
2. Select **Backlight Intensity > Backlight On Intensity**.
3. Select the intensity you want, and select **Back**.
4. From the **Backlight Intensity** screen, select **Backlight Idle Intensity**.
5. Select the intensity you want, and select **Back**.

6. From the **Backlight Intensity** screen, select **Maximum Intensity**.
7. Select **Up** or **Down** to increase or decrease the maximum intensity.

Set the Backlight Timeout

The backlight automatically turns on with any phone activity.

By setting the **Backlight Timeout**, you can determine how long the phone should be idle before the backlight dims to its **Backlight Idle** intensity. By default, the backlight dims after the phone is idle for 40 seconds.

Procedure

1. Go to **Settings > Basic**.
2. Select **Backlight Timeout**.
3. Choose the number of seconds the phone is idle before the backlight dims.

Enable or Disable Number Formatting

By default, the phone automatically formats phone numbers based on the number of digits you enter. For example, 11234567890 displays as +1 (123) 456-7890.

Procedure

1. Go to **Settings > Basic > Preferences**.
2. Select **Number Formatting**.
3. Select **Enable** or **Disable**.

Power Saving Mode

By default, Poly phones enter power saving mode and turn off the screen after being idle for a certain period of time to conserve energy.

You can determine the period of time that the phone is idle before the screen turns off, and you can set different idle timeouts for office hours and off hours, such as evenings and weekends. The phone exits power saving mode if an event occurs—for example, if there is an incoming call or message. If a screen saver is enabled, power saving mode still activates.

You can update the following power-saving settings:

- **Office Hours** - When you start work and how long you're in the office each day.
- **Timeouts** - The period of time the phone should be idle before the screen turns off.

Note: By default, Poly Trio C60 systems enter power saving mode after a period of idle time to conserve energy. However, Poly Trio systems don't enter power saving mode while idle in the Bluetooth or Wi-Fi menus. To ensure that the system enters power saving mode, exit the **Bluetooth** or **Wi-Fi** menu.

Change Your Office Hours for Power Saving Mode

When you update your office hours, you specify when you start and how long you work each day. After your work hours, the phone is idle and goes into power saving mode.

Procedure

1. Go to **Settings > Basic**.
2. Select **Power Saving > Office Hours** and select **Start Hour**.
3. Select a day of the week, and using the 24-hour clock, enter a start time from 0 to 23.
4. Select **Save**.
5. From the **Office Hours** screen, select **Duration**.
6. Select a day of the week and enter a duration of 0 to 12 hours per day.
7. Select **Save**.

Change Idle Timeouts for Power Saving Mode

Update the period of time the phone is idle before the screen turns off.

You can specify different timeouts for office hours (Office Hours Idle Timeout) and nonoffice hours (Off Hours Idle Timeout). By default, the Office Hours Idle Timeout is much longer than the Off Hours Idle Timeout.

You can also specify User Input Idle Timeout period that applies after you press a key or tap the screen (on touchscreen models). You can choose to set a higher User Input Idle Timeout than the Office Hours and Off Hours Idle Timeouts. Doing so prevents Power Saving Mode from initiating when you're actively using the phone.

Tip: If you press a key or tap the screen (on touchscreen models), the phone uses the idle timeout period with the highest value.

Procedure

1. Go to **Basic** settings.
2. Select **Power Saving > Timeouts**.
3. Select **Office Hours Idle Timeout** and enter the number of minutes (1 to 600 minutes) the phone should wait during office hours before starting Power Saving Mode.
4. Select **Off Hours Idle Timeout** and enter the number of minutes (1 to 10 minutes) the phone should wait during off-hours before starting Power Saving Mode.
5. Select **User Input Idle Timeout** and enter the number of minutes (1 to 10 minutes) the phone should wait after a key press or screen select before starting Power Saving Mode.
6. Select **Save**.

Change User Detection for Power Saving Mode

You can set the level of sensitivity that the system uses to detect users within its proximity.

When the Trio C60 system detects users in its vicinity, the screen remains active. Set the sensitivity to 0 to disable the user detection feature for either office hours or off-hours.

Procedure

1. Go to **Basic** settings.

2. Go to **Power Saving > User Detection**.
3. Select **Office Hours Sensitivity** and enter sensitivity level (0 to 10) for office hours.
4. Select **Off Hours Sensitivity** and enter sensitivity level (0 to 10) for off-hours.
5. Select **Save**.

Set a Ringtone for Incoming Calls

One way to personalize your phone is to change the ringtone. You can pick unique ringtones for the different lines on the phone. The default ringtone is **Low Trill**.

Procedure

1. Go to **Settings > Basic > Preferences**.
2. Select **Ring Type**.
3. On the **Ring Type** screen, select a ringtone.
4. Optional: Select **Play** to hear the ringtone.

Maintaining Poly Trio C60

Topics:

- [Update the Phone's Configuration](#)
- [Clean the Touchscreen](#)

When the phone isn't operating properly, investigate or troubleshoot issues along with any other tasks your administrator may ask you to perform.

Update the Phone's Configuration

Your system administrator may ask you to update the configuration for your phone to apply any changes to the phone settings, which you can do without rebooting it.

Procedure

1. Go to **Settings > Basic**.
2. Select **Update Configuration**.
A confirmation message displays.
3. Select **Yes**.
The configuration updates. The phone may reboot, depending on which settings you changed.

Clean the Touchscreen

The phone screens require minor maintenance, but you may need to clean the screen periodically.

Before you clean the screen, disable it so you don't activate phone functions while you wipe the touchscreen.

Use a clean, dry, microfiber cloth—the kind you would use to clean glass surfaces—to wipe the screen. Don't use chemicals to clean the screen.

Procedure

1. Go to **Settings > Basic**.
2. Select **Screen Clean**.
3. Wipe the screen with the clean, dry, microfiber cloth.

Note: If the screen is still dirty after cleaning, dampen a soft, lint-free cloth with an isopropyl alcohol and water solution of 50:50, then wipe the screen with the cloth. Always use the dampened cloth to apply the solution; never apply the solution directly to the screen because the solution could seep inside the screen or stain the phone. Do not use chemicals to clean the screen.

4. To enable the touchscreen, follow the on-screen instructions.

Accessibility Features

Topics:

- [Features for Hearing-Impaired Users](#)
- [Features for Mobility-Impaired Users](#)
- [Features for Vision-Impaired and Blind Users](#)

Poly products include a number of features to accommodate hearing, vision, mobility, or cognitively impaired users.

Features for Hearing-Impaired Users

Your phone includes many features that enable users with hearing impairments to use various features on the phone.

The following table lists the accessibility features for hearing-impaired users.

Accessibility Features for Hearing-Impaired Users

Accessibility Feature	Description
Visual message indicators	Icons on the screen indicate when the system has new messages.
Adjustable ringer and call volume	You can change the volume of the ringer to suit your needs. Also, you can separately control the call audio volume.
Visual notifications	Status and icon indicators let you know when you have incoming, outgoing, active, or held calls. Indicators also alert you of the device's status and when features are enabled.

Features for Mobility-Impaired Users

Your phone includes accessibility features to enable those with mobility impairments to use various phone features.

The following table lists the accessibility features for mobility-impaired users.

Accessibility Features for Mobility-Impaired Users

Accessibility Feature	Description
Auto-answering	You can enable the phone to auto-answer calls.
Touchscreen	The large touchscreen enables you to select, swipe, and press the screen to perform functions and activate features.

Accessibility Feature	Description
Built-in speakerphone	A built-in speakerphone enables you to hear audio on the device without having to use headset.

Related Links

[Answer Calls Automatically](#) on page 24

Related Links

[Poly Trio C60 System Hardware Overview](#) on page 7

Features for Vision-Impaired and Blind Users

Poly phones include various features that enable users with visual impairments to use many of the features on the phone.

The following table lists the accessibility features for visually impaired and blind users.

Accessibility Features for Vision-Impaired and Blind Users

Accessibility Feature	Description
Adjustable backlight settings	You can change the brightness of the screen by adjusting backlight intensity settings.
Tactile volume keys	Poly Trio C60 volume buttons are raised and discernible to touch.
Large text	You can increase the onscreen text font to a larger size.
High contrast mode	You can increase the screen's contrast settings to more easily view objects and text on the screen.
Color correction	You can change the screen colors to compensate for certain kinds of color-blindness: <ul style="list-style-type: none"> • Deuteranomaly • Protanomaly • Tritanomaly

Troubleshooting

Topics:

- [Investigate Warnings](#)
- [Check the Status of the Calendar](#)
- [Test the Hardware](#)
- [Set Log Levels](#)
- [Reboot Your Phone](#)
- [Reset the Phone to Factory Defaults](#)

If you're having issues with your Poly phone, you can try the troubleshooting options and solutions in the following topics to resolve certain issues.

Investigate Warnings

When a phone can't perform certain tasks, a **Warning**  icon displays in the status bar and on the **Settings** icon on the **Home** screen.

View details about the issues from the **Warnings** screen.

Procedure

1. Go to **Settings** > **Status** > **Diagnostics**.
2. Select **Warnings**.

The **Warnings** screen displays, listing any issues.

Check the Status of the Calendar

Issues with the phone's connection to the Microsoft server may cause calendar problems. Without a functioning connection, you may not see the **Calendar** icon on the **Home** screen or you may not receive meeting reminders.

Procedure

1. Go to **Settings** > **Calendar**.
2. On the **Calendar** screen, make sure the **Status** field includes **Connected to Server**.

If the status reads that it is not connected to the server, contact your system administrator.

Test the Hardware

If you're experiencing issues with your phone, your system administrator may ask you to test the phone hardware.

Test the display, microphones, and speaker. Contact your system administrator for instructions on how to perform these tests.

Procedure

1. Go to **Settings > Status > Diagnostics**.
2. Select **Test Hardware** and select

Set Log Levels

Your system administrator uses log files to troubleshoot issues with your phone and may ask you to set the level for log files.

Contact your system administrator before setting a log level for your phone.

Procedure

1. Go to **Settings > Basic > Diagnostic Logs > Server Log Level**.
2. Choose a log level.

Reboot Your Phone

Your system administrator may ask you to reboot the phone if it malfunctions or to assist in troubleshooting.

Caution: Before you reboot the phone, contact your system administrator. Rebooting the phone requires an administrative password. If the phone is malfunctioning, you may be able to restore normal operation without rebooting it. Additionally, your system administrator may want to troubleshoot the phone before you reboot it. You don't need to reboot the phone to update its configuration.

Procedure

1. Go to **Settings > Basic**.
2. Select **Reboot Phone**.
A confirmation message displays.
3. Select **Yes**.
The reboot process begins, and the process ends when the **Home** screen displays.

Reset the Phone to Factory Defaults

Access the phone reset option without having to enter an administrator password.

After the administrator configures this feature on the phone, you can reset the phone to factory default settings.

Procedure

- » Go to **Settings > Basic > Reset to Factory**.