

Amber Helm Development L.C.

92723 Michigan Hwy-152

Sister Lakes, Michigan 49047 USA

Tel: 888-847-8027

EMC Test Report

CONTI-WR1805TX

Issued: February 11, 2019

regarding

USA: CFR Title 47, Part 15.231e (Emissions)
Canada: ISED RSS-210v9/GENE (Emissions)

for

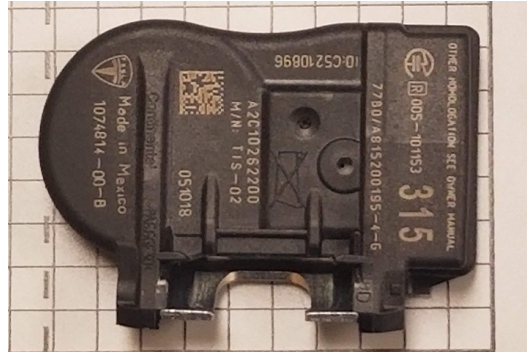

M3N-A2C89898

Category: TPM Sensor

Judgments:

15.231(e)/RSS-210v9 Compliant Transmitter

Testing Completed: December 23, 2018



Prepared for:

Continental Automotive

4685 Investment Drive, Troy Michigan 48098 USA

Phone: +1 (248) 764-6783, Fax: +1 (248) 764-7281

Contact: Charles Muma, Charles.Muma@continental-corporation.com

Data Recorded by:

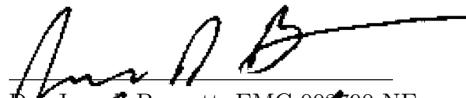
Dr. Joseph Brunett, EMC-002790-NE

Reviewed by:

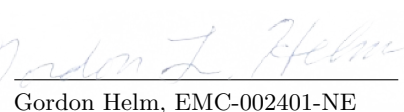
Gordon Helm, EMC-002401-NE

Prepared by:

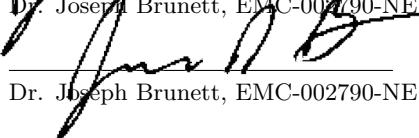
Dr. Joseph Brunett, EMC-002790-NE

Date of Issue: February 11, 2019

Revision History

Rev. No.	Date	Details	Revised By
r0	February 11, 2019	Initial Release.	J. Brunett
r1	February 21, 2019	Minor typos + signatures.	J. Brunett

Contents

Revision History	2
Table of Contents	2
1 Test Report Scope and Limitations	4
1.1 Laboratory Authorization	4
1.2 Report Retention	4
1.3 Subcontracted Testing	4
1.4 Test Data	4
1.5 Limitation of Results	4
1.6 Copyright	4
1.7 Endorsements	4
1.8 Test Location	5
1.9 Traceability and Equipment Used	5
2 Test Specifications and Procedures	6
2.1 Test Specification and General Procedures	6
3 Configuration and Identification of the Equipment Under Test	7
3.1 Description and Declarations	7
3.1.1 EUT Configuration	7
3.1.2 Modes of Operation	8
3.1.3 Variants	8
3.1.4 Test Samples	8
3.1.5 Functional Exerciser	8
3.1.6 Modifications Made	8
3.1.7 Production Intent	8
3.1.8 Declared Exemptions and Additional Product Notes	8
4 Emissions	9
4.1 General Test Procedures	9
4.1.1 Radiated Test Setup and Procedures	9
4.1.2 Conducted Emissions Test Setup and Procedures	11
4.1.3 Power Supply Variation	11
4.2 Intentional Emissions	12
4.2.1 Fundamental Emission Pulsed Operation	12
4.2.2 Fundamental Emission Bandwidth	16
4.2.3 Fundamental Emission Field Strength	17
4.3 Unintentional Emissions	18
4.3.1 Transmit Chain Spurious Emissions	18
5 Measurement Uncertainty and Accreditation Documents	19

List of Tables

1 Test Site List. 5
2 Equipment List. 5
3 EUT Declarations. 7
4 Fundamental Emission Pulsed Operation. 12
5 Fundamental Emission Bandwidth. 16
6 Fundamental Emission Field Strength. 17
7 Transmit Chain Spurious Emissions. 18
8 Measurement Uncertainty. 19

List of Figures

1 Photos of EUT. 7
2 EUT Test Configuration Diagram. 7
3 Radiated Emissions Diagram of the EUT. 9
4 Radiated Emissions Test Setup Photograph(s). 10
5 Fundamental Emission Pulsed Operation. 13
5 Fundamental Emission Pulsed Operation. 14
5 Fundamental Emission Pulsed Operation. 15
6 Fundamental Emission Bandwidth. 16
7 Accreditation Documents 19

1 Test Report Scope and Limitations

1.1 Laboratory Authorization

Test Facility description and attenuation characteristics are on file with the FCC Laboratory, Columbia, Maryland (FCC Reg. No: US5348 and US5356) and with ISED Canada, Ottawa, ON (File Ref. No: 3161A and 24249). Amber Helm Development L.C. holds accreditation under NVLAP Lab Code 200129-0.

1.2 Report Retention

For equipment verified to comply with the regulations herein, the manufacturer is obliged to retain this report with the product records for the life of the product, and no less than ten years. A copy of this Report will remain on file with this laboratory until March 2029.

1.3 Subcontracted Testing

This report does not contain data produced under subcontract.

1.4 Test Data

This test report contains data included within the laboratories scope of accreditation.

1.5 Limitation of Results

The test results contained in this report relate only to the item(s) tested. Any electrical or mechanical modification made to the test item subsequent to the test date shall invalidate the data presented in this report. Any electrical or mechanical modification made to the test item subsequent to this test date shall require reevaluation.

1.6 Copyright

This report shall not be reproduced, except in full, without the written approval of Amber Helm Development L.C.

1.7 Endorsements

This report shall not be used to claim product endorsement by any accrediting, regulatory, or governmental agency.

1.8 Test Location

The EUT was fully tested by **Amber Helm Development L.C.**, headquartered at 92723 Michigan Hwy-152, Sister Lakes, Michigan 49047 USA. Table 1 lists all sites employed herein. Specific test sites utilized are also listed in the test results sections of this report where needed.

Table 1: Test Site List.

Description	Location	Quality Num.
OATS (3 meter)	3615 E Grand River Rd., Williamston, Michigan 48895	OATSC

1.9 Traceability and Equipment Used

Pertinent test equipment used for measurements at this facility is listed in Table 2. The quality system employed at Amber Helm Development L.C. has been established to ensure all equipment has a clearly identifiable classification, calibration expiry date, and that all calibrations are traceable to the SI through NIST, other recognized national laboratories, accepted fundamental or natural physical constants, ratio type of calibration, or by comparison to consensus standards.

Table 2: Equipment List.

Description	Manufacturer/Model	SN	Quality Num.	Last Cal By / Date Due
Spectrum Analyzer	Rohde & Schwarz / FSV30	101660	RSFSV30001	RS / Apr-2019
Biconical	EMCO / 93110B	9802-3039	BICEMCO01	Keysight / Aug-2019
Log Periodic Antenna	EMCO / 3146	9305-3614	LOGEMCO01	Keysight / Aug-2019
BNC-BNC Coax	WRTL / RG58/U	001	CAB001-BLACK	AHD / Mar-2019
BNC-BNC Coax	WRTL / RG58/U	001	CAB002-BLACK	AHD / Mar-2019
3.5-3.5MM Coax	PhaseFlex / PhaseFlex	001	CAB015-PURPLE	AHD / Mar-2019
Quad Ridge Horn	Singer / A6100	C35200	HQR1TO18S01	Keysight / Aug-2019

2 Test Specifications and Procedures

2.1 Test Specification and General Procedures

The ultimate goal of Continental Automotive is to demonstrate that the Equipment Under Test (EUT) complies with the Rules and/or Directives below. Detailed in this report are the results of testing the Continental Automotive M3N-A2C89898 for compliance to:

Country/Region	Rules or Directive	Referenced Section(s)
United States	Code of Federal Regulations	CFR Title 47, Part 15.231e
Canada	ISED Canada	ISED RSS-210v9/GENe

It has been determined that the equipment under test is subject to the rules and directives above at the date of this testing. In conjunction with these rules and directives, the following specifications and procedures are followed herein to demonstrate compliance (in whole or in part) with these regulations.

ANSI C63.4:2014	"Methods of Measurement of Radio-Noise Emissions from Low-Voltage Electrical and Electronic Equipment in the Range of 9 kHz to 40 GHz"
ANSI C63.10:2013	"American National Standard of Procedures for Compliance Testing of Unlicensed Wireless Devices"
TP0102RA	"AHD Internal Document TP0102 - Radiated Emissions Test Procedure"
ISED Canada	"The Measurement of Occupied Bandwidth"

3 Configuration and Identification of the Equipment Under Test

3.1 Description and Declarations

The equipment under test is a wireless tire pressure and temperature sensor. The EUT is approximately 2 x 5 x 4 cm (approx.) in dimension, and is depicted in Figure 1. It is powered by 3 VDC Lithium cell battery. In use, this device is permanently affixed inside the tire of a motor vehicle. Table 3 outlines provider declared EUT specifications.

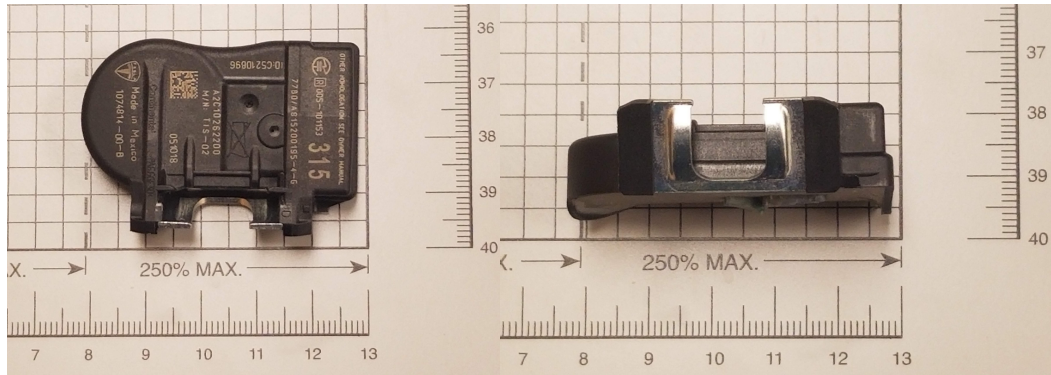

Figure 1: Photos of EUT.

Table 3: EUT Declarations.

General Declarations			
Equipment Type:	TPM Sensor	Country of Origin:	Mexico
Nominal Supply:	3 VDC	Oper. Temp Range:	Not Declared
Frequency Range:	315 MHz	Antenna Dimension:	Not Declared
Antenna Type:	metal form loop	Antenna Gain:	-20 dBi (approx)
Number of Channels:	1	Channel Spacing:	Not Applicable
Alignment Range:	Not Declared	Type of Modulation:	ASK+FSK
United States			
FCC ID Number:	M3N-A2C89898	Classification:	DSC
Canada			
IC Number:	7812A-A2C89898	Classification:	Remote Control Device, Vehicular Device

3.1.1 EUT Configuration

The EUT is configured for testing as depicted in Figure 2.

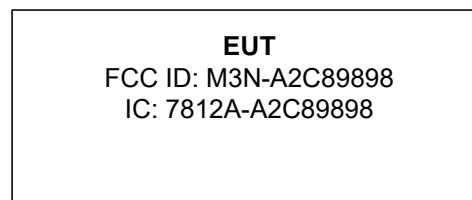

Figure 2: EUT Test Configuration Diagram.

3.1.2 Modes of Operation

This device is capable of three key modes of operation, manual activation (MA) mode (used in setting up the device and linking it to the vehicle), periodic transmission (PT) modes which occur as the vehicle drives or sits parked, and emergency condition (EC) modes which occur when drastic pressure changes are observed in the tire.

For MA modes, the EUT is manually activated via LF interrogation (typically through the use of special LF tool at a vehicle dealership). The EUT responds with a single transmission containing a set of frames (a burst) used to train the device to the vehicle. Depending on the desired emulation state indicated to the EUT by the LF tool, the EUT responds with one of five long-burst protocols (MA-1 through MA-5) and is locked into that emulation state (states 1 through 5) going forward.

Once installed into the vehicle and after the emulation state (as above) is fixed, the EUT will, in the worst case, periodically transmit in PT mode where the duration of each transmission is always less than 1 second and the silent period between transmissions is at least 30 times the duration of the transmission, and never less than 16 seconds. Depending on the emulation state locked-in, the EUT will transmit PT-1 through PT-5 bursts at regular intervals.

The EC mode occurs only in the case of an emergency (i.e. drastic change in pressure within the tire). In this mode the EUT will transmit tire pressure and temperature information through the duration of the emergency condition. When the emergency condition is no longer present, the EUT returns to a PT mode. Greater detail about all of these operating states, burst set protocols, and modes are to be provided by the manufacturer in a Modes of Operation exhibit.

3.1.3 Variants

There is only a single variant of the EUT. Normal samples were programmed into worst case on-time and CW mode via LF tool operated by Continental engineer.

3.1.4 Test Samples

Three samples in total were provided; two samples were capable of normal operation and CW mode activation via LF tool operated by Continental engineer. One sample was open (un-potted) for testing and photographs.

3.1.5 Functional Exerciser

Normal operating EUT functionality was verified by observation of transmitted signal.

3.1.6 Modifications Made

There were no modifications made to the EUT by this laboratory.

3.1.7 Production Intent

The EUT appears to be a production ready sample.

3.1.8 Declared Exemptions and Additional Product Notes

The EUT is permanently installed in a transportation vehicle. As such, digital emissions are exempt from US and Canadian digital emissions regulations (per FCC 15.103(a) and IC correspondence on ICES-003).

4 Emissions

4.1 General Test Procedures

4.1.1 Radiated Test Setup and Procedures

Radiated electromagnetic emissions from the EUT are first pre-scanned in our screen room. Spectrum and modulation characteristics of all emissions are recorded. Instrumentation, including spectrum analyzers and other test equipment as detailed in Section 1.8 are employed. After pre-scan, emission measurements are made on the test site of record. If the EUT connects to auxiliary equipment and is table or floor standing, the configurations prescribed in relevant test standards are followed. Alternatively, a layout closest to normal use (as declared by the provider) is employed if the resulting emissions appear to be worst-case in such a configuration. See Figure 3. All intentionally radiating elements that are not fixed-mounted in use are placed on the test table lying flat, on their side, and on their end (3-axes) and the resulting worst case emissions are recorded. If the EUT is fixed-mounted in use, measurements are made with the device oriented in the manner consistent with installation and then emissions are recorded. If the EUT exhibits spurious emissions due to internal receiver circuitry, such emissions are measured with an appropriate carrier signal applied.

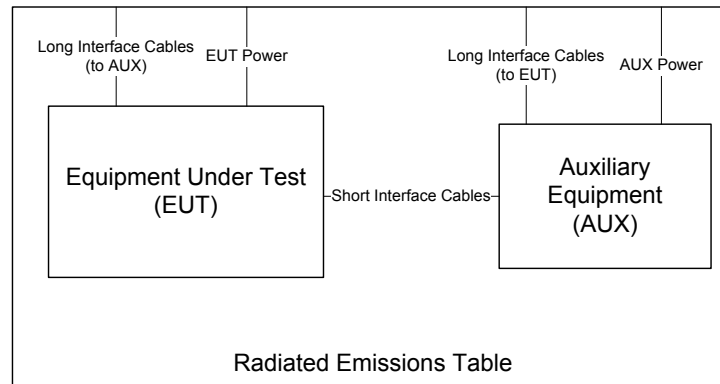

Figure 3: Radiated Emissions Diagram of the EUT.

For devices with intentional emissions below 30 MHz, a shielded loop antenna and/or E-field and H-Field broadband probes are used depending on the regulations. Shielded loops are placed at a 1 meter receive height at the desired measurement distance. For exposure in this band, the broadband probes employed are 10cm diameter single-axis shielded transducers and measurements are repeated and summed over three axes.

Emissions between 30 MHz and 1 GHz are measured using calibrated broadband antennas. For both horizontal and vertical polarizations, the test antenna is raised and lowered from 1 to 4 m in height until a maximum emission level is detected. The EUT is then rotated through 360° in azimuth until the highest emission is detected. The test antenna is then raised and lowered one last time from 1 to 4 m and the worst case value is recorded. Emissions above 1 GHz are characterized using standard gain or broadband ridge-horn antennas on our OATS with a 4×5 m rectangle of ECCOSORB absorber covering the OATS ground screen and a 1.5m table height. Care is taken to ensure that test receiver resolution and video bandwidths meet the regulatory requirements, and that the emission bandwidth of the EUT is not reduced. Photographs of the test setup employed are depicted in Figure 4.

Where regulations allow for direct measurement of field strength, power values (dBm) measured on the test receiver / analyzer are converted to $\text{dB}\mu\text{V}/\text{m}$ at the regulatory distance, using

$$E_{dist} = 107 + P_R + K_A - K_G + K_E - C_F$$

where P_R is the power recorded on spectrum analyzer, in dBm, K_A is the test antenna factor in dB/m, K_G is the combined pre-amplifier gain and cable loss in dB, K_E is duty correction factor (when applicable) in dB, and C_F is a distance conversion (employed only if limits are specified at alternate distance) in dB. This field strength value is then compared with the regulatory limit. If effective isotropic radiated power (EIRP) is computed, it is computed as

$$EIRP(\text{dBm}) = E_{3m}(\text{dB}\mu\text{V}/\text{m}) - 95.2.$$

When presenting data at each frequency, the highest measured emission under all possible EUT orientations (3-axes) is reported.

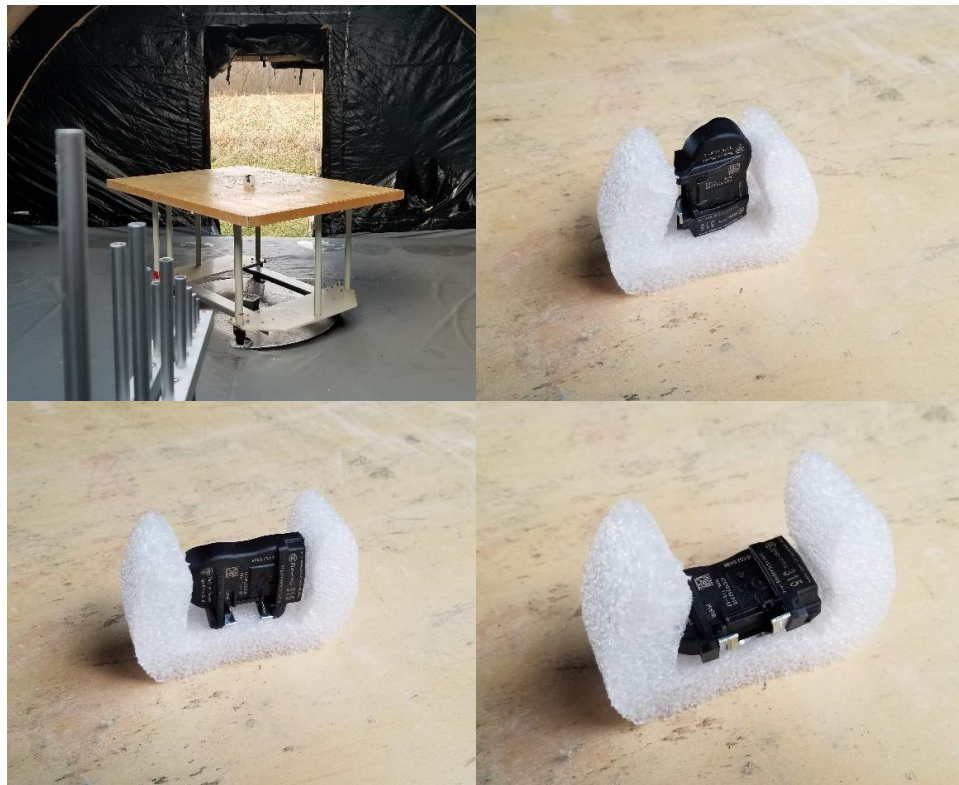

Figure 4: Radiated Emissions Test Setup Photograph(s).

4.1.2 Conducted Emissions Test Setup and Procedures

The EUT is not subject to measurement of power line conducted emissions as it is powered solely by its internal battery.

4.1.3 Power Supply Variation

Tests at extreme supply voltages are made if required by the procedures specified in the test standard, and results of this testing are detailed in this report.

In the case the EUT is designed for operation from a battery power source, the extreme test voltages are evaluated over the range specified in the test standard; no less than $\pm 10\%$ of the nominal battery voltage declared by the manufacturer. For all battery operated equipment, worst case intentional and spurious emissions are re-checked employing a new (fully charged) battery.

4.2 Intentional Emissions

4.2.1 Fundamental Emission Pulsed Operation

Test Setup & Procedure The test equipment and facilities were setup in accordance with the standards and procedures listed in Section 2.1. Environmental conditions were set at the appropriate temperature and thermal balance was checked with a thermocouple based probe. Duty cycle is reported for all relevant modes of operation. The test equipment employed includes RSFSV30001, LOGEMCO1.

Measurement Results The details and results of testing the EUT are summarized in Table 4. Plots showing the measurements made to obtain these values are provided in Figure 5.

Table 4: Fundamental Emission Pulsed Operation.

Detector	Span	IF Bandwidth	Video Bandwidth	Test Date:	10-Dec-18
Pk	0	1 MHz	3 MHz	Test Engineer:	Joseph Brunett
				EUT:	CONTI REDI
				EUT Mode:	Modulated
				Meas. Distance:	10 cm

FCC/IC									
R0	EUT Test Mode*	Overall Transmission			Internal Frame Characteristics			Computed Duty Cycle	
		Min. Repetition Rate (sec)	Max. No. of Frames	Total Transmission Length (sec)	Max. Frame Length (ms)	Min. Frame Period (ms)	Frame Encoding	(%)	(dB)
R1	Worst Case PT Periodic Mode - 8 FRAMES (subfigure (a))	16.8	8	0.4696	28.3	< 100 ms	The EUT transmits 8 frames every 16.8 seconds. One 28.3 ms ASK frame (with 0.120 / 0.238 ms duty) followed by one 8.4 ms FSK frame can occur in a 100 ms window in the worst case.	22.7	-12.9
R2	Worst Case PT Periodic Mode - 14 FRAMES (subfigure (b))	35.3	14	0.9239	30.2	82.5	The EUT transmits 14 frames every 35.3 seconds. In the worst case, two 30.2 ms long ASK frames with 50% duty occur with an interframe period of 82.5 ms.	18.3	-14.8
R3	Worst Case LF activated MA Mode (subfigure (c))	Single	56	4.58	10.1	< 100 ms	When manually actuated by LF interrogation the EUT can, in the worst case, transmit 56 frames. Within that set, two 8.3 ms and one 10.3 ms FSK frames occur in a 100 ms window in the worst case.	26.7	-11.5
#	C1	C2	C3	C4	C5	C6	C7	C8	C9

Example Calculation: Worst Case Duty (%) = (2 x 8.3 ms + 10.3 ms) / 100 ms = 26.7 % on-time.
 Equipment Used: LOGEMCO1, RSFSV30001

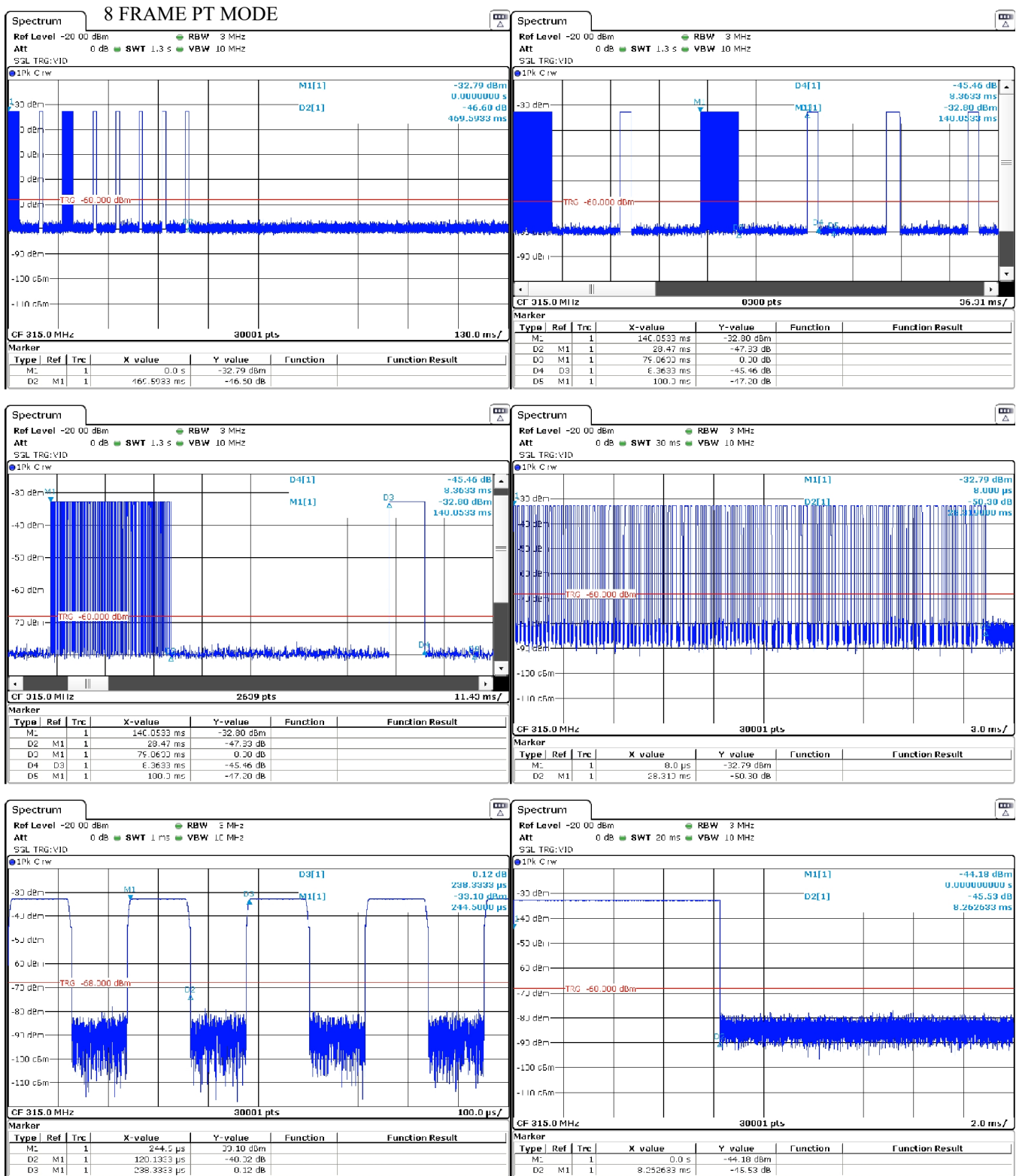

Figure 5(a): Fundamental Emission Pulsed Operation.

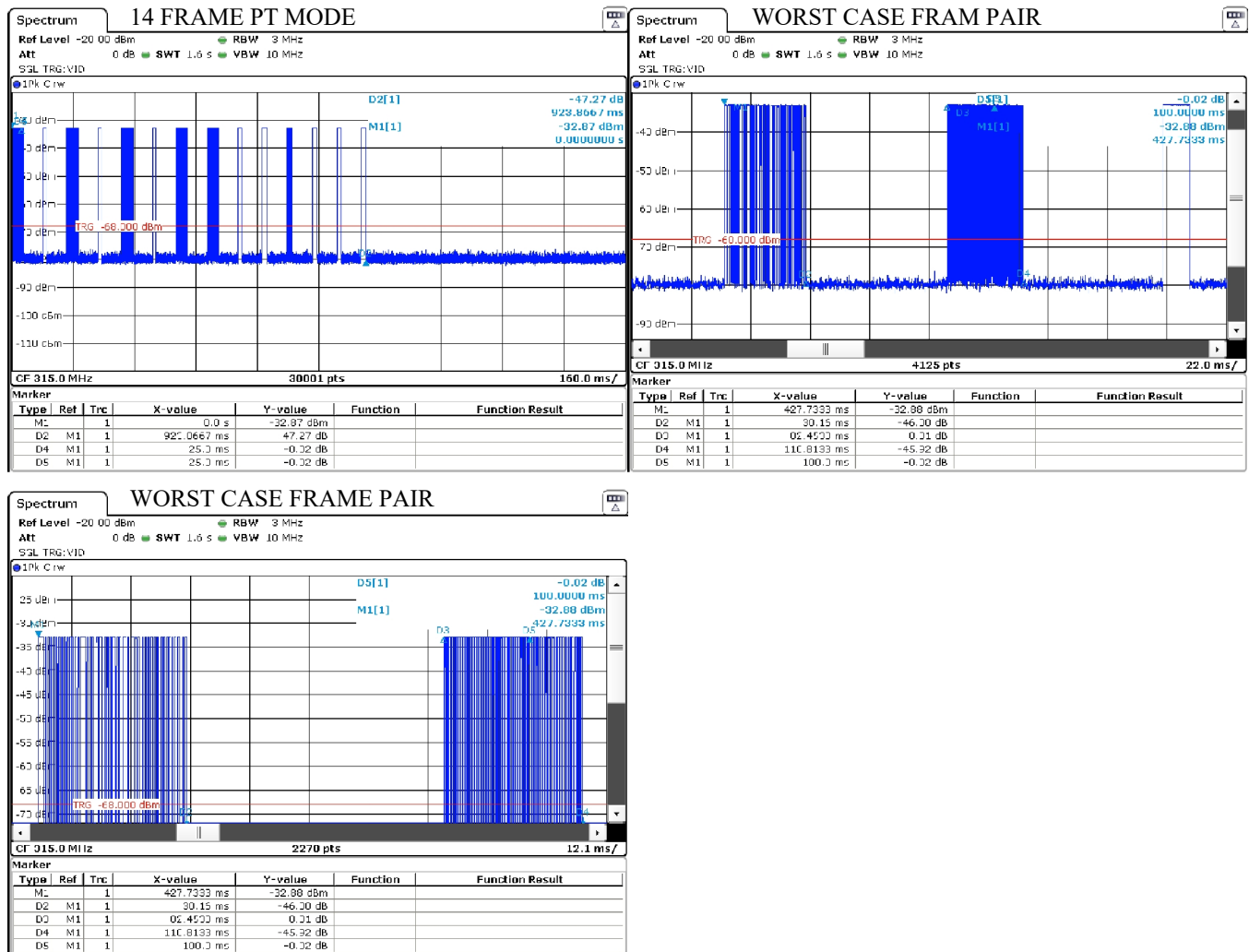

Figure 5(b): Fundamental Emission Pulsed Operation.

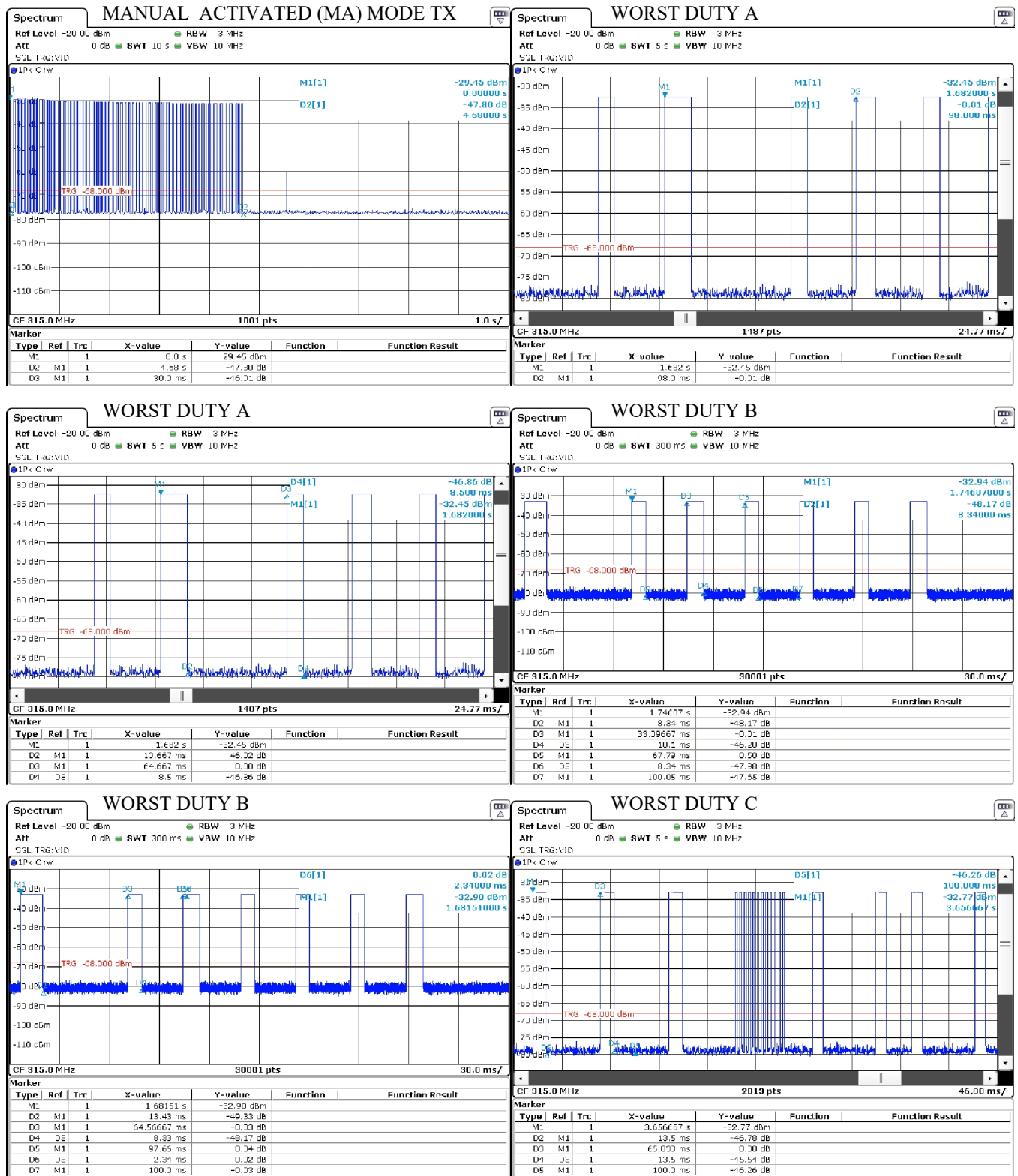

Figure 5(c): Fundamental Emission Pulsed Operation.

4.2.2 Fundamental Emission Bandwidth

Test Setup & Procedure The test equipment and facilities were setup in accordance with the standards and procedures listed in Section 2.1. Environmental conditions were set at the appropriate temperature and thermal balance was checked with a thermocouple based probe. Emission bandwidth (EBW) of the EUT is measured with the device placed in the test mode(s) with the shortest available frame length and minimum frame spacing. The 20 dB EBW is measured as the max-held peak-detected signal when the IF bandwidth is greater than or equal to 1% of the receiver span. For complex modulations other than ASK and FSK, the 99% emission bandwidth per IC test procedures has a different result, and is also reported. The test equipment employed includes RSFSV30001, LOGEMCO01.

Measurement Results The details and results of testing the EUT are summarized in Table 5. Plots showing the measurements made to obtain these values are provided in Figure 6.

Table 5: Fundamental Emission Bandwidth.

Detector	IF Bandwidth	Video Bandwidth	Test Date:	10-Dec-18
Pk	10 kHz	30 kHz	Test Engineer:	Joseph Brunett
			EUT:	CONTI REDI
			EUT Mode:	Modulated
			Meas. Distance:	10 cm

FCC/IC						
R0	Mode	Center Frequency (MHz)	20 dB EBW (MHz)	EBW Limit (MHz)	99% OBW (MHz)	
R1	All (ASK+FSK)	315	0.1279	0.788	0.1399	
R2						
#	C1	C2	C3	C4	C5	C6

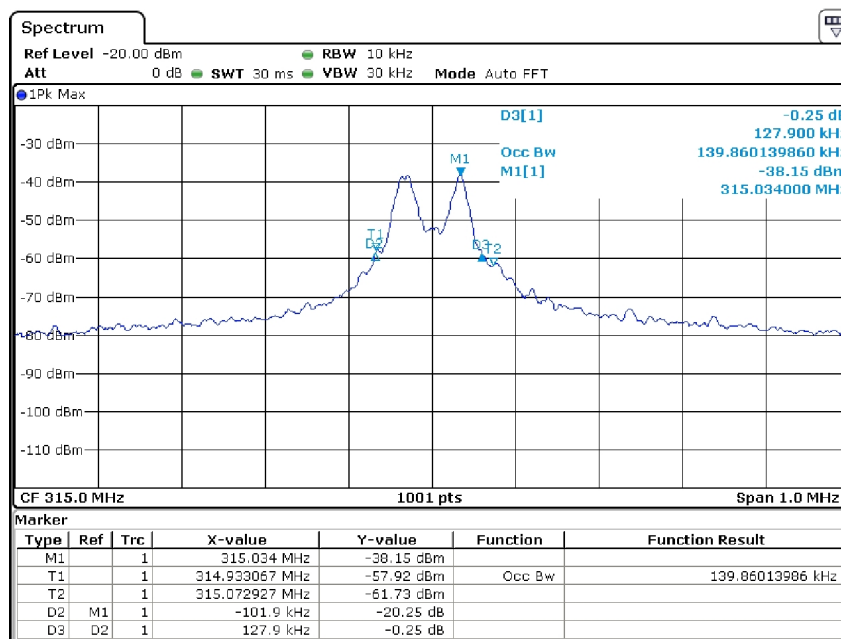

Figure 6: Fundamental Emission Bandwidth.

4.2.3 Fundamental Emission Field Strength

Test Setup & Procedure The test equipment and facilities were setup in accordance with the standards and procedures listed in Section 2.1. Environmental conditions were set at the appropriate temperature and thermal balance was checked with a thermocouple based probe. Fundamental emissions are measured at the regulatory distance on our OATS. The test equipment employed includes RSFSV30001, LOGEMCO01.

Measurement Results The details and results of testing the EUT are summarized in Table 6.

Table 6: Fundamental Emission Field Strength.

R0		Frequency		Temp. (C) Hum. %	Site				EUT			Test Antenna				Cable Kg	Receiver				Field Strength @ DR						EIRP		Details	
		Start MHz	Stop MHz		MR	DR	N/F	CF	Mode	Volt.	Dim	Pol.	Ant. Height	Dim.	Ka		Rx Power Pk	Avg	Bandwidth RBW	VBW	Meas.	Limit USA	CAN	Qpk / Avg	Limit USA	CAN	Calc.	Limit		Calc.
R1		SETUP			OATSC				CONTI REDI			EMCOLOG					RSFSV30001				NOTES: H-POL - SIDE, V-POL END Worst Case Orient									
R2		315.0	315.0	6 / 22	0.0	3.0	3.0		0.0	a1	3.0	8.0	H	1.0	100.0	14.1	0.0			0.12	0.30	78.8	87.6	87.6	67.3	67.6	67.6	-20.5		0.3
R3		315.0	315.0	6 / 22	90.0	3.0	3.0		0.0	a1	3.0	8.0	V	1.4	100.0	14.1	0.0			0.12	0.30	77.1	87.6	87.6	65.6	67.6	67.6	-22.2		2.0
R4																														
#		C1	C2	C3	C4	C5	C6	C7	C8	C9	C10	C11	C12	C13	C14	C15	C16	C17	C18	C19	C20	C21	C22	C23	C24	C25	C26	C27	C28	C29
(ROW)		(COLUMN)		NOTE:																										
R0		C5		MR is Measurement Range, which is reduced from DR to achieve necessary SNR.																										
R0		C6		DR is the regulatory Desired Range measurement distance.																										
R0		C7		N/F is Near-Field / Far-Field distance computed for max of EUT Antenna Dimension (C10) and Test Antenna dimension (C12), where applicable.																										
R0		C8		CF is computed using a 20 dB/decade Decay Rate.																										
R0		C18/19		When E-field or EIRP is reported directly from Spectrum Analyzer, Antenna Factors and Cable losses are included directly in SA settings and Pr is not reported.																										

4.3 Unintentional Emissions

4.3.1 Transmit Chain Spurious Emissions

Test Setup & Procedure The test equipment and facilities were setup in accordance with the standards and procedures listed in Section 2.1. Environmental conditions were set at the appropriate temperature and thermal balance was checked with a thermocouple based probe. Spurious radiated emissions measurements are performed to 10 times the highest fundamental operating frequency. The test equipment employed includes RSFSV30001, LOGEMCO01, HQR1TO18S01.

Measurement Results The details and results of testing the EUT are summarized in Table 7.

Table 7: Transmit Chain Spurious Emissions.

EUT Modes: a1 CW
a2
a3
a4

Test Date: 12/21/18
Test Engineer: J. Brunett

R0	Frequency		Temp. (C) Hum. %	Table Angle deg	Site				EUT			Test Antenna				Cable Kg	Receiver				Field Strength @ DR						EIRP		Details Pass dB	
	Start MHz	Stop MHz			MR	DR	N/F	CF	Mode	Volt.	Dim	Pol.	Ant. Height	Dim.	Ka		Rx Power Pk	Bandwidth Avg	RBW	VBW	Meas.	Pk Limit		Opk / Avg Limit		Calc.	Limit	Calc.		Limit
					m	m		dB	see table	(V)	cm	H/V	m	cm	dB/m		dB	dBm	MHz				USA	CAN	USA	CAN	dBm	dBm		
R1	SETUP				OATSC				CONTI REDI			EMCOLOG					RSFSV30001				NOTES: H-POL - SIDE, V-POL END Worst Case Orient									
R2	630.0	630.0	6 / 22	0.0	3.0	3.0		0.0	a1	3.0	8.0	H	1.2	100.0	10.5	-0.1			0.12	0.30	29.9	67.6	67.6	18.4	47.6	47.6	-65.3		29.2	
R3	630.0	630.0	6 / 22	90.0	3.0	3.0		0.0	a1	3.0	8.0	V	1.4	100.0	10.5	-0.1			0.12	0.30	32.6	67.6	67.6	21.1	47.6	47.6	-62.6		26.5	
R4	945.0	945.0	6 / 22	0.0	3.0	3.0		0.0	a1	3.0	8.0	H	1.0	100.0	16.7	-0.2			0.12	0.30	47.8	67.6	67.6	36.3	47.6	47.6	-47.4		11.3	
R5	945.0	945.0	6 / 22	90.0	3.0	3.0		0.0	a1	3.0	8.0	V	1.1	100.0	16.7	-0.2			0.12	0.30	39.7	67.6	67.6	28.2	47.6	47.6	-55.5		19.4	
R6																														
R7	SETUP				OATSC				CONTI REDI			HRNSINGQR					RSFSV30001				NOTES: max all orientations of EUT									
R8	1260.0	1260.0	6 / 22	all	3.0	3.0	0.2	0.0	a1	3.0	8.0	H/V	all	15.0	21.5	-0.2			1.00	3.00	42.3	74.0	74.0	30.8	54.0	54.0	-52.9		23.2	
R9	1575.0	1575.0	6 / 22	all	3.0	3.0	0.2	0.0	a1	3.0	8.0	H/V	all	15.0	25.2	-0.2			1.00	3.00	47.3	74.0	74.0	35.8	54.0	54.0	-47.9		18.2	
R10	1890.0	1890.0	6 / 22	all	3.0	3.0	0.3	0.0	a1	3.0	8.0	H/V	all	15.0	27.9	-0.2			1.00	3.00	43.2	74.0	74.0	31.7	54.0	54.0	-52.0		22.3	
R11	2205.0	2205.0	6 / 22	all	3.0	3.0	0.3	0.0	a1	3.0	8.0	H/V	all	15.0	29.7	-0.3			1.00	3.00	45.6	74.0	74.0	34.1	54.0	54.0	-49.6		19.9	
R12	2520.0	2520.0	6 / 22	all	3.0	3.0	0.4	0.0	a1	3.0	8.0	H/V	all	15.0	30.9	-0.3			1.00	3.00	48.8	74.0	74.0	37.3	54.0	54.0	-46.4		16.7	
R13	2835.0	2835.0	6 / 22	all	3.0	3.0	0.4	0.0	a1	3.0	8.0	H/V	all	15.0	31.6	-0.3			1.00	3.00	51.8	74.0	74.0	40.3	54.0	54.0	-43.4		13.7	
R14	3150.0	3150.0	6 / 22	all	3.0	3.0	0.5	0.0	a1	4.0	8.0	H/V	all	15.0	31.8	-0.3			1.00	3.00	53.0	74.0	74.0	41.5	54.0	54.0	-42.2		12.5	
R15																														
#	C1	C2	C3	C4	C5	C6	C7	C8	C9	C10	C11	C12	C13	C14	C15	C16	C17	C18	C19	C20	C21	C22	C23	C24	C25	C26	C27	C28	C29	

(ROW) (COLUMN) NOTE:
R0 C5 MR is Measurement Range, which is reduced from DR to achieve necessary SNR.
R0 C6 DR is the regulatory Desired Range measurement distance.
R0 C7 N/F is Near-Field / Far-Field distance computed for max of EUT Antenna Dimension (C10) and Test Antenna dimension (C12), where applicable.
R0 C8 CF is computed using a 20 dB/decade Decay Rate.
R0 C18/19 When E-field or EIRP is reported directly from Spectrum Analyzer, Antenna Factors and Cable losses are included directly in SA settings and Pr is not reported.

5 Measurement Uncertainty and Accreditation Documents

The maximum values of measurement uncertainty for the laboratory test equipment and facilities associated with each test are given in the table below. This uncertainty is computed for a 95.45% confidence level based on a coverage factor of $k = 2$.

Table 8: Measurement Uncertainty.

Measured Parameter	Measurement Uncertainty [†]
Radio Frequency	$\pm(f_{Mkr}/10^7 + RBW/10 + (SPN/(PTS - 1))/2 + 1 \text{ Hz})$
Conducted Emm. Amplitude	$\pm 1.9 \text{ dB}$
Radiated Emm. Amplitude (30 – 200 MHz)	$\pm 4.0 \text{ dB}$
Radiated Emm. Amplitude (200 – 1000 MHz)	$\pm 5.2 \text{ dB}$
Radiated Emm. Amplitude ($f > 1000 \text{ MHz}$)	$\pm 3.7 \text{ dB}$

[†]Ref: CISPR 16-4-2:2011+A1:2014



FEDERAL COMMUNICATIONS COMMISSION
 Laboratory Division
 7435 Oakland Mills Road
 Columbia, MD 21046
 July 06, 2018

National Voluntary Laboratory Accreditation Program
 100 Bureau Drive
 Gaithersburg, MD 20899-2140

Attention: Timothy Rasinski

Re: Accreditation of AHD (Amber Helm Development, L.C.)
 Designation Number: US5348
 Test Firm Registration #: 639064

Dear Sir or Madam:

We have been notified by National Voluntary Laboratory Accreditation Program that AHD (Amber Helm Development, L.C.) has been accredited as a testing laboratory.

At this time AHD (Amber Helm Development, L.C.) is hereby recognized to perform compliance testing on equipment subject to Declaration of Conformity (DOC) and Certification of the Commission's Rules.

This recognition will expire upon expiration of the accreditation or notification of withdrawal of recognition.

Any questions about this recognition should be submitted as an inquiry to the FCC Knowledge Database at www.fcc.gov/kdb.

Sincerely,

George Tanshill
 Electronics Engineer



Figure 7: Accreditation Documents