











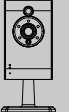

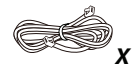

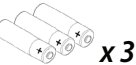

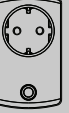

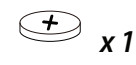
QUICK START GUIDE

KIT CONTENT

Gateway		 x 1	 x 1
IP Camera		 x 1	 x 1
Motion PIR		 x 3	 x 4  x 4
On / Off Switch		NA	
Door / Window Sensor		 x 1	 x 3  x 4
Indoor Siren		 x 1	 x 4  x 1  x 2
Panic Remote		 x 1	

Serie No.

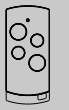
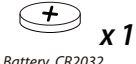

SYSTEM INTRODUCTION

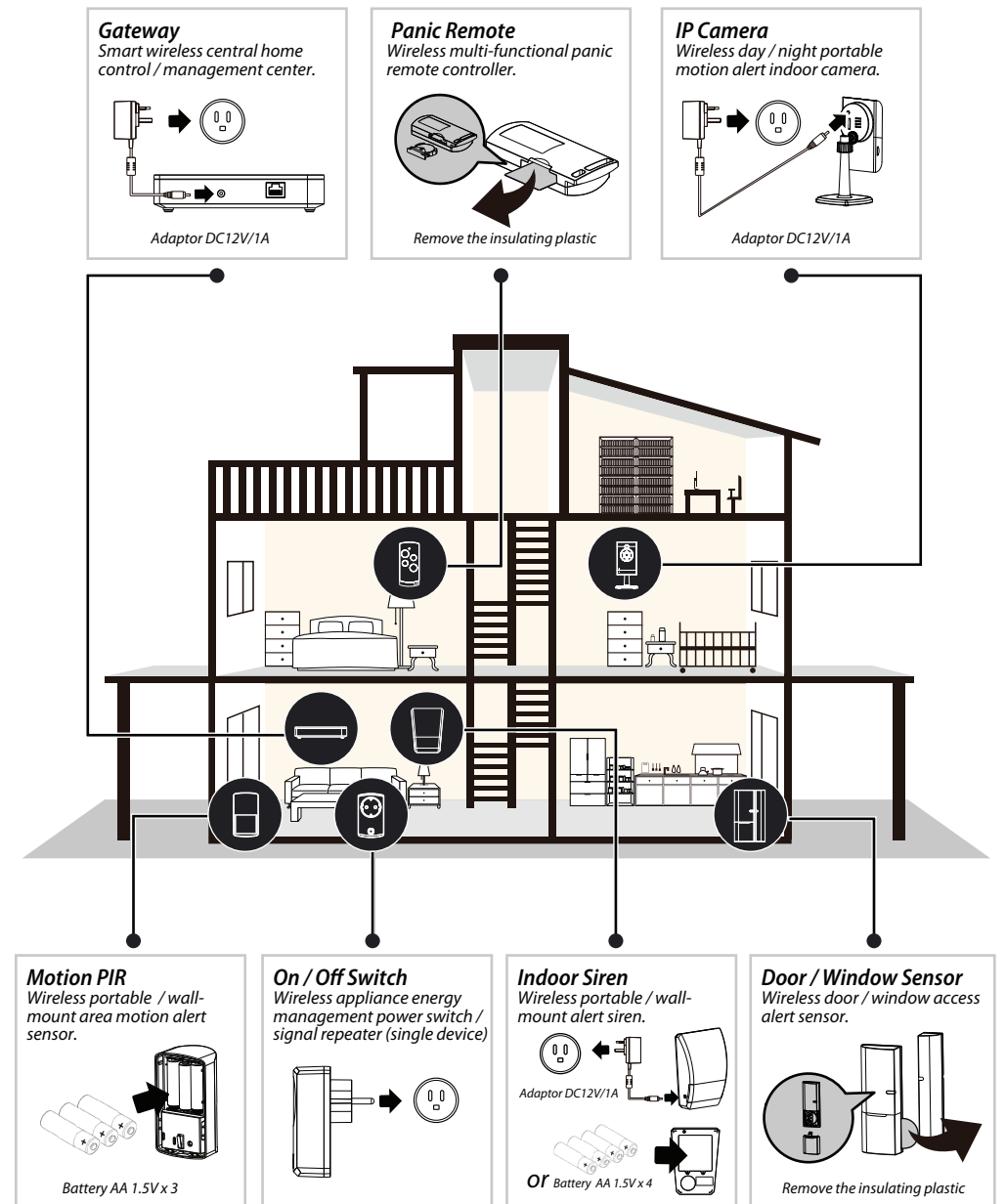

GETTING STARTED

1. Connect the gateway box to the Internet

(1) Connect gateway box to your router via the Ethernet cable. Then plug in the supplied power cable.

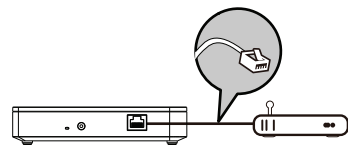

(2) The power LED indicator becomes steady RED and you will hear the gateway box beep twice. This means the gateway box is ready for APP setup.

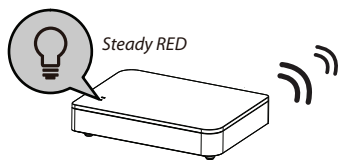

(3) Launch 'OMGUARD SHC' APP. The APP will automatically search the available gateway box and brings up the system DID/password. If it is not shown, Please check the system DID on the bottom of the gateway box. Enter the system DID and default password 123456 manually.

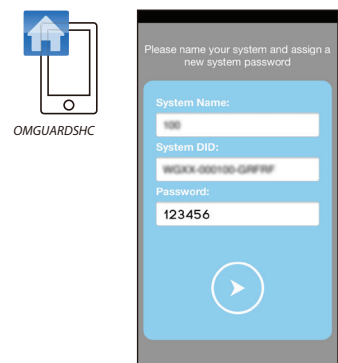

Note: The gateway box should be powered on and connected to the Internet at all times.

You can continue to setup the camera and sensor(s) now.

2. Set up the IP Camera

(1) Connect the IP Camera to your router via the Ethernet cable.

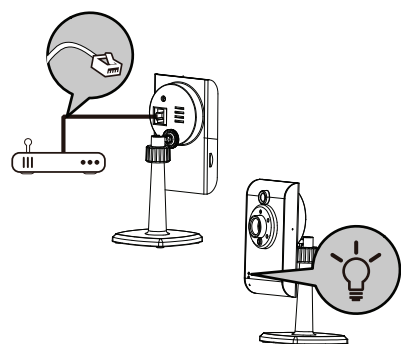

(2) Plug in the power adapter and wait until both RED and GREEN LED begin flashing.

Note: DO NOT begin the APP setup process until both LEDs become steady on.

(3) Launch the 'OMGUARD SHC' APP. Click the 'ADD' icon + and choose 'Camera' to add the device to system.

Follow the APP wizard setup process to add the camera.

Note: The APP will search the available IP Camera in LAN area. If the camera you're setting doesn't appear in the searching list, please enter the camera ID (DID) and password manually.



Installing the IP Camera:

(1) Secure the camera stand on the stable surface.

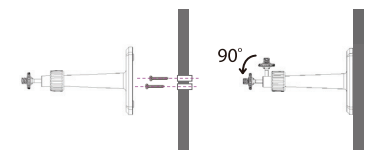

(2) Mount the camera into camera stand. Adjust the viewing angle and fix the camera tightly.

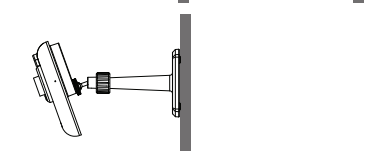

3. Pair the Motion Sensor

Launch the 'OMGUARD SHC' APP. Click the 'ADD' icon + and choose 'Motion Sensor' and to initiate the pairing process, following with pressing the pairing button located inside the battery compartment to complete the process.



Installing the Motion Sensor:

(1) Place the motion sensor upward, facing the location to be monitored. The detection distance is up to 16 meters.

For maximum coverage, it is recommended to place the motion sensor high up with its back against the corner of walls to ensure best detection coverage.

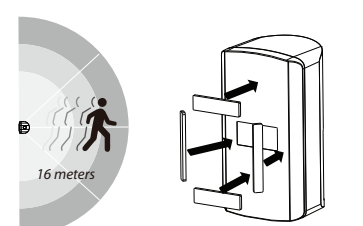

(2) Use the double-sided tape to fix the motion sensor.

4. Pairing the Power Switch

Launch the 'OMGUARD SHC' APP. Click the 'ADD' icon **+** and choose 'Power Switch' and  to initiate the pairing process, following with press/hold the front panel button until LED flashing blue.

To initiate the repeater function, press / hold the front panel button turned orange, following with pressing the pairing button on the device.

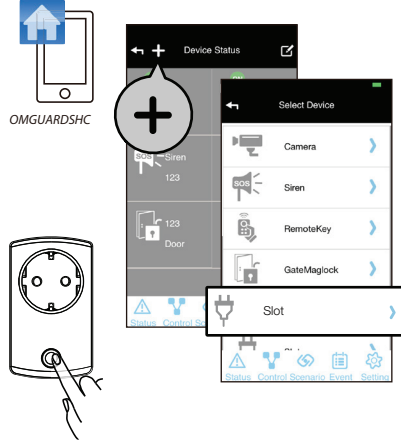

5. Pairing the Door / Window Sensor

Launch the 'OMGUARD SHC' APP. Click the 'ADD' icon **+** and choose 'Door Sensor' and  to initiate the pairing process, following with removing and reinstalling the battery compartment cover to complete the process.



Installing the Door/Window Sensor

Using the double-sided tape:

- (1) Apply the double-sided tape to the backs of the Door/Window sensor.
- (2) Select a location on the door/window. The large piece of the sensor should be fixed on the immovable frame of the door/window. Align the small piece to the large one. Fix the small piece on the movable part of the door/window frame.
- (3) When it is finished, open the door or window to test if the sensor has been correctly installed. You'll receive an alert from the mobile device if the APP and sensor have been corrected installed.

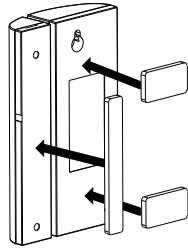

Using the mounting screws:

- (1) Fix the first mounting screw directly onto the door / window frame (A). Place (hang) the larger piece on to the mounted screw, remove the battery compartment cover to fix the second mounting screw (B).
- (2) Open back cover of the small piece. Use the mounting screws to fix the back cover on the movable part of the door/window frame (C). Mount the sensor onto the back cover.
- (3) When it is finished, open the door or window to test if the sensor has been correctly installed. You'll receive an alert from the mobile device if the APP and sensor have been corrected installed.

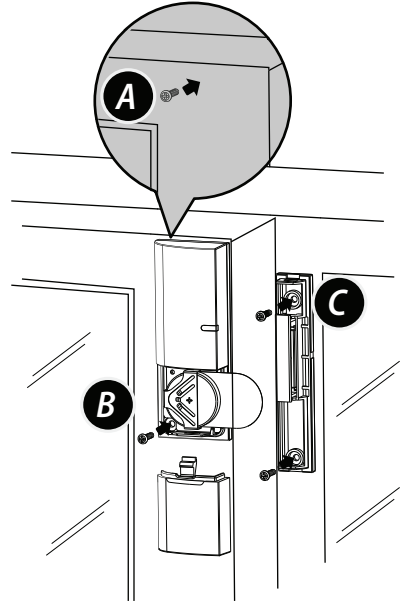

6. Indoor Siren

Launch the 'OMGUARD SHC' APP. Click the 'ADD' icon **+** and choose 'Siren' and  to initiate the pairing process, following with pressing the pairing button inside the battery compartment to complete the process.

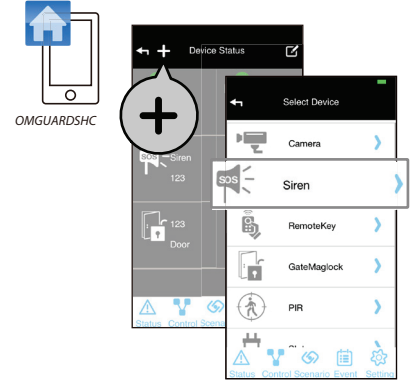

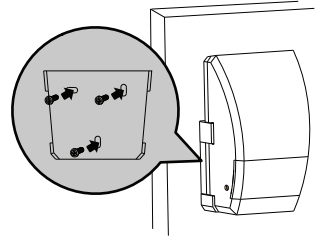

Installing the Siren:

It is recommended to install (wall-mount / place on flat surface) the Siren in a highly visible location with minimum obstacles near for maximum visual and sound alert deterrence in critical situations. A/C power option is available, choose a suitable power outlet location for the installation.



7. Pairing the Remote Control

Launch the 'OMGUARD SHC' APP. Click the 'ADD' icon **+** and choose 'Panic Remote' and  to initiate the pairing process, following with press/hold the camera  button until the LED flashing blue.

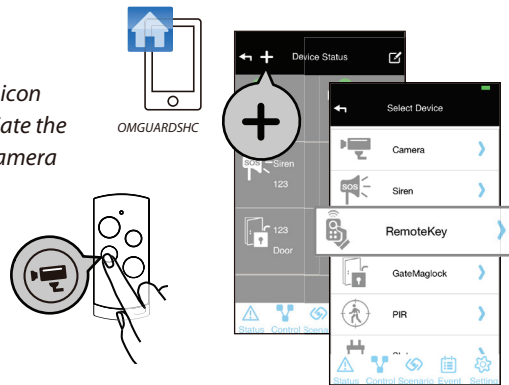

8. APP Operation

Display device status in realtime. Tap "Status" to refresh the status page.

Setup groups of devices for instant function activation / deactivation.

1. Choose "+" to start a new "control".
2. Naming the control and select device(s).
3. Save.



Setup various scenarios for system to launch pre-configured settings governing the behaviour of lights, cameras and sirens.

1. Choose a device (initiator) from the list.
2. Choose "+" to add additional device (follower). Repeat to add additional device(s).
3. Save.

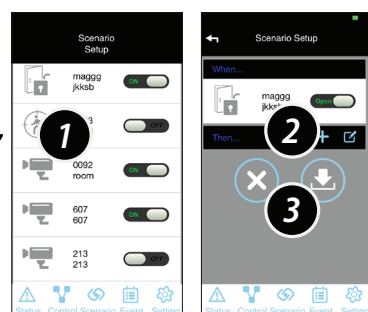







Example: "Motion PIR" (initiator) > "Power Switch" (follower) > "Save".

List of triggered events from device(s) and playback from camera(s).



STATUS INDICATOR

-  **Sensor On**
-  **Sensor Off**
-  **Sensor Triggered**
-  **Power Low**
-  **Vandal Alert**
-  **Delete**
-  **Edit Mode**

This device complies with Industry Canada's licence-exempt RSSs. Operation is subject to the following two conditions:

- (1) This device may not cause interference; and
 - (2) This device must accept any interference, including interference that may cause undesired operation of the device.
- Cet appareil est conforme aux CNR exemptes de licence d'Industrie Canada. Son fonctionnement est soumis aux deux conditions suivantes :
- (1) Ce dispositif ne peut causer d'interférences ; et
 - (2) Ce dispositif doit accepter toute interférence, y compris les interférences qui peuvent causer un mauvais fonctionnement de l'appareil.
- Changes or modifications not expressly approved by the party responsible for compliance could void the user's authority to operate the equipment.



FCC Compliance Statement: This device complies with Part 15 of the FCC rules. Operation is subject to the following two conditions:
(1) this device may not cause harmful interference, and (2) this device must accept any interference received, including interference that may cause undesired operation.



If the camera system no longer functions or can no longer be repaired, it must be disposed of according to the valid statutory regulations. Disposal of spent batteries/accumulators:
You are required by law (Battery Ordinance) to return all spent batteries and accumulators. Disposing of spent batteries/accumulators with common household waste is prohibited! Batteries/accumulators that contain hazardous substances are marked with the symbols on the side. These symbols indicate that it is prohibited to dispose of these batteries/accumulators in the household waste. The abbreviations for the respective heavy metals are: Cd=cadmium, Hg=mercury, Pb=lead. You can return spent batteries and accumulators that can no longer be charged to the designated collection points in your community, outlets or wherever batteries or accumulators are sold. Following these instructions will allow you to fulfill the legal requirements and contribute to the protection of our environment!



Products with CE Marking comply with EMC Directive (2004/108/EC); Low Voltage Directive (73/23/EEC); R&TTE (1999/5/EC); ROHS Directive (2011/65/EU) issued by the Commission of the European Community. Compliance with these directives implies conformity to the following European Norms:
EMC: EN 301 489
LVD: EN 60950
Radio: EN 300 328