



Cisco Phone 9871 User Guide (Onprem+MPP)

CONFIDENTIAL DRAFT

Contents

Chapter 1. Special Notes	8
Chapter 2. Get started	9
Get started with Cisco Desk Phone 9871	9
Hardware and buttons.....	10
Connect your phone	15
For a wired network.....	15
For a wireless network.....	18
Register your phone.....	19
With auto registration.....	19
With activation code.....	22
With alternate TFTP.....	25
Sign in to a shared phone (Hot Desking) (MPP).....	27
.....	27
Sign in and book a shared phone.....	27
Sign out of the booked phone.....	28
Sign yourself in to a shared phone (Extension Mobility) (Onprem).....	28
.....	28
Use the touchscreen	29
Single line.....	30
Multiple lines.....	31
Need more help?.....	33
Help Center.....	33
Technical support.....	34
Cisco one-year limited hardware warranty terms.....	34
Chapter 3. Calling	35
Make and answer calls (MPP).....	35
Make and answer calls	35

Make a call.....	35
Make an emergency call.....	36
Answer a call.....	37
Make and answer calls (Onprem).....	39
Make and answer calls	39
Make a call.....	40
Make an emergency call.....	43
Answer a call.....	44
Decline a call.....	46
Make an intercom call.....	48
Answer an intercom call.....	49
Make a call with speed dial.....	50
Use BLF with speed dial and call pickup.....	50
Configure speed dial numbers with Self Care Portal.....	52
Put a call on hold.....	53
Swap between active and held calls.....	54
Use call park (Onprem).....	55
Call park	55
Park a call.....	55
Retrieve a parked call.....	56
Park and unpark calls (MPP).....	56
Park and unpark calls	56
Transfer a call to another person	58
Forward calls (Onprem).....	58
.....	58
Forward calls (MPP).....	59
Forward calls.....	59
Work with a shared line on your phone (MPP).....	62
Work with a shared line on your phone	62

Work with a shared line on your phone (Onprem).....	64
Work with a shared line on your video phone	64
Enable privacy on a shared line.....	65
Answer a call for your hunt group (Onprem).....	66
Answer a call for your hunt group	66
Sign in and out of a hunt group.....	66
View the call queue in a hunt group.....	67
Pick up calls for your coworkers (MPP).....	67
Pick up calls for your coworkers	67
Answer calls for your coworkers (Onprem).....	69
Answer a call for your coworkers within your group (Pickup).....	69
Answer a call for another group (Group pickup)	70
Answer a call for an associated group (Other pickup).....	70
Use BLF with speed dial and call pickup.....	71
Silence incoming call ringer	73
Use Do Not Disturb (DND) (Onprem).....	73
Use Do Not Disturb (DND)	73
Use Do Not Disturb (DND) (MPP).....	74
Use Do Not Disturb (DND)	74
Check voice messages on your phone (Both).....	75
Single line.....	75
Multiple lines.....	76
Chapter 4. Meeting and conference.....	79
Join a scheduled Webex meeting with your phone (MPP).....	79
Join a calendar meeting with your phone	79
Scheduled conference calls (Meet me) (Onprem).....	80
.....	80
Host a Meet-me conference.....	80
Join a Meet-me conference.....	80

Use your phone for an ad-hoc conference (MPP).....	81
.....	81
Add more people to a call.....	81
View and manage participants.....	81
Manage audio for calls and meetings (Both).....	82
Mute yourself during a call.....	82
Mute or unmute yourself during a meeting.....	82
Adjust audio volume.....	83
Switch the phone audio path.....	84
Chapter 5. Contacts and call history (MPP).....	86
Contacts (Onprem).....	86
Contacts	86
Search for a contact	86
Use the personal directory on your phone (Onprem).....	87
Contacts (MPP).....	91
Search for a contact.....	91
Add a contact to Favorites.....	92
Add a contact in a corporate directory to your personal directory.....	92
Edit a contact.....	92
Add a contact to your personal directory.....	93
Add a contact from Recents.....	93
Add a contact using the keypad.....	93
Use and manage the call history on your phone (Onprem).....	93
Call history on your phone.....	93
View your call history.....	94
Make a call from call history.....	96
Redial a number.....	97
Delete call history of a contact.....	97
Delete entire call history.....	98

Use and manage the call history on your phone (MPP).....	99
View your recent calls.....	99
Make a call from call history.....	100
Add a contact from Recents.....	101
Delete a recent call.....	101
Clear the call history.....	102
Chapter 6. Settings and troubleshooting.....	103
Use a Bluetooth® headset with your phone (Both).....	103
Connect a Bluetooth® headset to your phone.....	103
Unpair a Bluetooth® headset.....	103
Manage network and services (MPP).....	103
Change the internet protocol mode.....	103
Change the IP address on the phone.....	104
Change VLAN settings on your phone.....	108
Find information on network settings of your phone.....	109
Enable 802.1x authentication	110
Manage network and services (Onprem).....	111
Change the IP address on your phone.....	111
Change VLAN settings on your phone.....	116
Find information on network settings of your phone.....	117
Enable 802.1x authentication	119
Set the time and language for your phone (MPP).....	120
Set time zone and time format.....	120
Change language for your phone	120
Troubleshooting your phone.....	121
Find information about your phone.....	121
Check phone issues and diagnostics.....	122
Report problem from your phone.....	123
Check network status.....	124

Restart your phone.....	124
Reset security settings (Cisco Unified CM).....	125
Reset your phone to the factory settings.....	125
Chapter 7. Cisco 9800 series key expansion module.....	128
Cisco 9800 key expansion module overview.....	128
Install key expansion module.....	128
Key Expansion Module buttons and hardware	131
Chapter 8. Safety and compliance information.....	133
Safety and performance information.....	133
Power outage.....	133
Regulatory domains.....	133
External devices.....	133
Bluetooth wireless headset performance.....	134
Ways to provide power to your phone.....	134
UL warning.....	134
Energy star.....	135
Product label.....	135
Compliance statements.....	135
Compliance statements for the European Union.....	135
Compliance statements for the US.....	136
Compliance statements for Canada.....	136
FCC compliance statements.....	138
Cisco product security overview.....	139
Cisco circular economy.....	139
Important online information.....	140

Chapter 1. Special Notes

This User Guide contains information about the phone's hardware features, installation instructions, and available software features as to the time of file generation.



Note:

- The contents of this file are confidential and protected by a Non-Disclosure Agreement. Please refrain from distributing the file to anyone outside the scope of the NDA.
- The contents in this file may change as the development progresses.

CONFIDENTIAL DRAFT

Chapter 2. Get started

Get started with Cisco Desk Phone 9871



Cisco Desk Phone 9871 is designed to facilitate convenient and flexible collaboration experience during calls and meetings for diverse roles, work modes, and workplaces.

Here are the key hardware features that your phone supports:

- 5" touch color screen
- Bluetooth®
- Wi-Fi
- USB-A and USB-C ports for headset connection and charging
- Support for Key Extension Module (KEM)
- Support for Power over Ethernet (PoE) Class 4

For more details about your phone specifications and features, see *Cisco Desk Phone 9800 Series Data Sheet*.

What's in the box

The following items came with your phone. If any items are missing, contact your administrator.

- Handset x 1
- Foot stand x 1

- Handset cable x 1
- Ethernet cable x 1
- Pointer card x 1, containing the links to the product help and compliance information



Note:

If your network doesn't support Power over Ethernet (PoE), order a power adapter from Cisco. For the list of available power adapters, see the **Ordering information** section in Cisco Desk Phone 9800 Series Data Sheet.

Hardware and buttons

Figure 1. Cisco Desk Phone 9871 front view



Table 1. Hardware and buttons on the front







Hardware Feature	Purpose
1. Phone screen	5" color touch screen (Resolution 800 x 480)
2. The top LED bar	Indicates the states of call, message, and the phone.
3. Emergency button	Press the button to place an emergency call, if configured.
4. NFC tag	<p>The location of the NFC tag.</p> <p>The NFC feature will be available in the later firmware release.</p>
5. Hold/Resume, Transfer, and Conference	<p>Hold/Resume  : Place an active call on hold and resume the held call.</p> <p>Transfer  : Transfer a call.</p> <p>Conference  : Create a conference call.</p>
6. Headset, Speakerphone, and Mute	<p>Headset  : Toggle the headset on. When the headset is on, the button lights up. To leave headset mode, pick up the handset or press Speakerphone  .</p> <p>Speakerphone  : Toggle the speakerphone on or off. When the speakerphone is on, the button lights up.</p> <p>Mute  : Toggle the microphone on or off. When the microphone is muted, the button lights up.</p>
7. Alphanumeric keypad	Use the keypad to input numbers, letters, and symbols.

Table 1. Hardware and buttons on the front (continued)



Hardware Feature	Purpose
8. Volume button	Adjust the handset, headset, and speakerphone volume (off hook), and the ringer volume (on hook and when the phone is idle).
9. Favorite, Settings, and Contacts	<p>Favorite  : Access the Favorites list.</p> <p>Settings  : Access the settings menu.</p> <p>Contacts  : Access directories.</p>
10. The front LED ribbon	The LED ribbon indicates the states of the phone, calls, and messages.
11. The Navigation Cluster	The Navigation Cluster consists of the Navigation Ring and Select button. Used to scroll through menus, highlight items and select the highlighted item.

Figure 2. Cisco Desk Phone 9871 back view

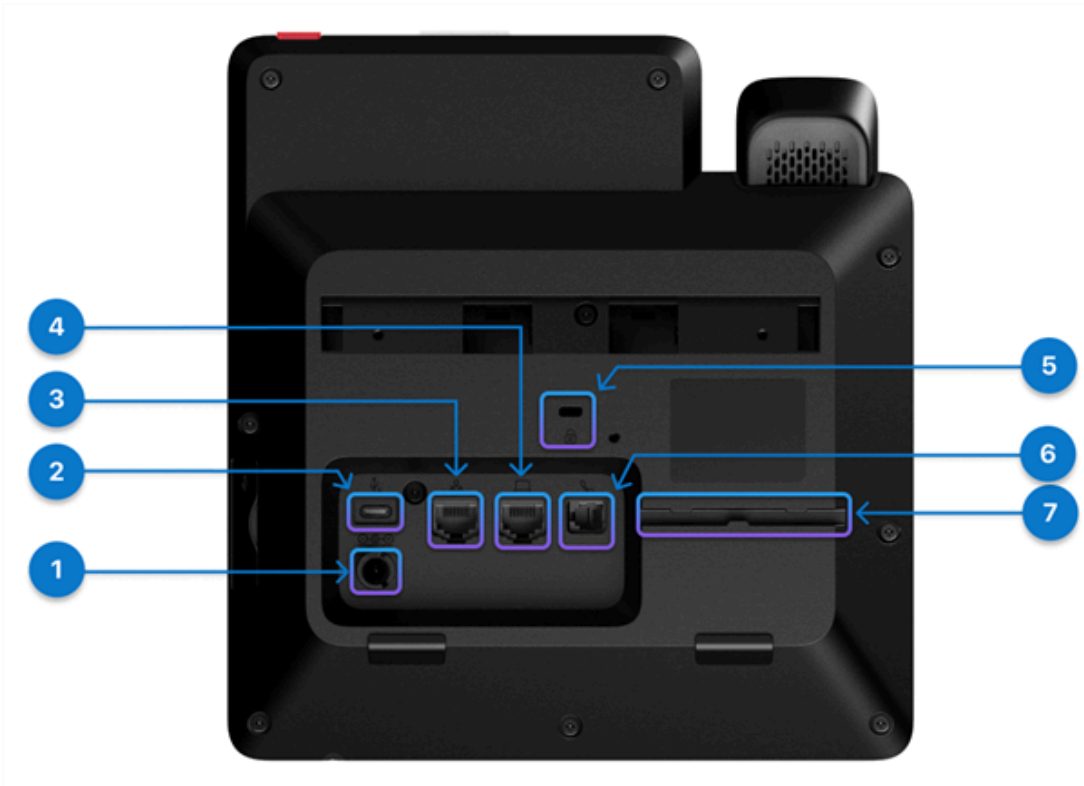

Table 2. Ports on the back of the phone

Port	Description
1. Power port	<p>If your Ethernet doesn't support PoE or you're using a wireless network, connect the power adapter to this port to power up your phone.</p> <p>The power adapter is purchased separately.</p>
2. USB-C port	<p>Connect your USB-C headset.</p> <p>You can also use this port to charge your smartphone.</p>
3. Ethernet port	<p>Connect this port to your Ethernet port on the wall or on your router with the shipped Ethernet cable.</p>

Table 2. Ports on the back of the phone (continued)

Port	Description
4. PC port	Used for getting network connection from your laptop or another IP phone.
5. Kensington security slot	To physically secure the phone in public places, attach an anti-theft cable lock to the slot.
6. Handset port	Connect your handset to this port with the shipped handset cable.
7. Cable socket	Used for holding the handset cable.

Figure 3. Cisco Desk Phone 9871 right-side view



Table 3. Ports on the right side of

Port	Description
1. USB-A port	Connect your USB-A headset or Key Expansion Module (KEM) to this port.
2. Foot stand	Supports your phone standing on a desk.

Connect your phone

Get your phone ready by installing the components and get it connected to the network and power.

The phone register process varies with deployment ways. Your phone may get registered automatically when you connect it to the network. Otherwise, you must get the activation code from your administrator to register your phone.

For a wired network

Use the information in this section to connect your phone in a wired network.

Your phone supports Power over Ethernet (PoE). If your network supports PoE, an Ethernet connection powers up your phone and connects it to the network. You don't have to connect the shipped power adapter.

1. Connect the shipped handset to the handset port.

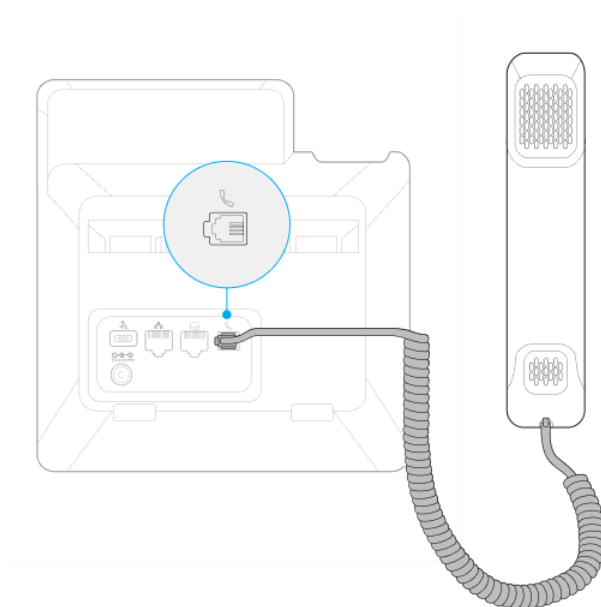

2. Insert the foot stand to the slots on the back of the phone.

The foot stand is designed for two tilt angles. Try both tilt angles to find the best position for your viewing preferences. To switch to the other angle, unplug the foot stand, flip it over, and reinsert it to the slots.

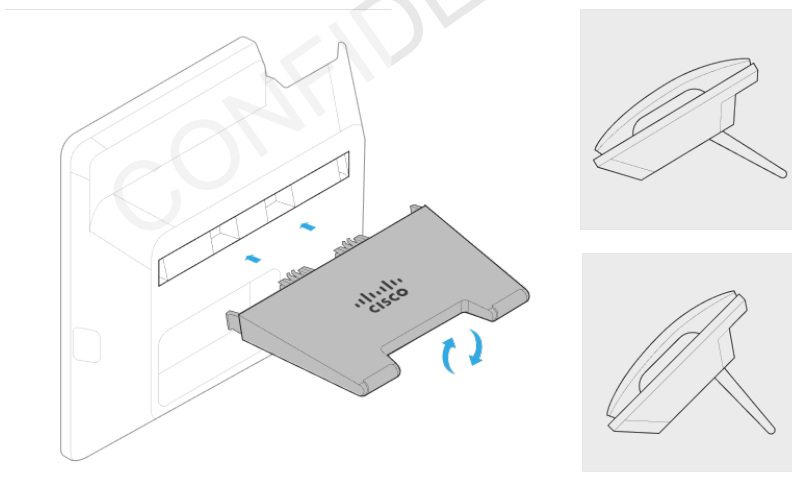

3. Connect your phone to the network with the shipped Ethernet cable.

Your phone boots up automatically when it connects to the power source.



Note:

If your network supports PoE, your phone powers up when you connect it to the network. Otherwise, go to the next step to connect the power adapter.

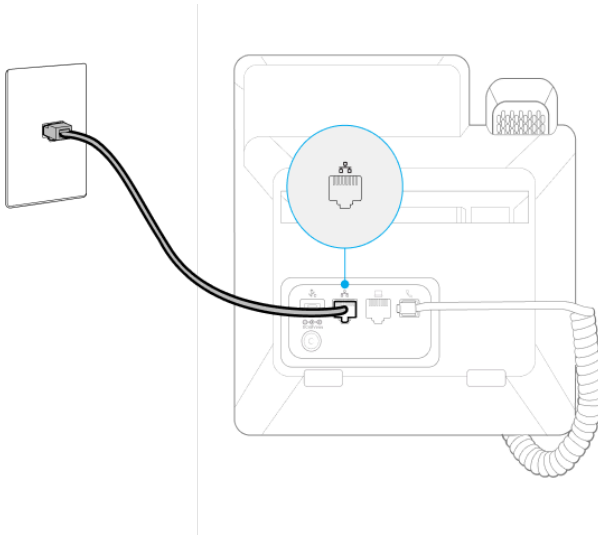

4. Connect your phone to a power socket with the shipped power adapter. Your phone boots up automatically when it connects to the power source.



Note:

If your network supports PoE, skip this step.

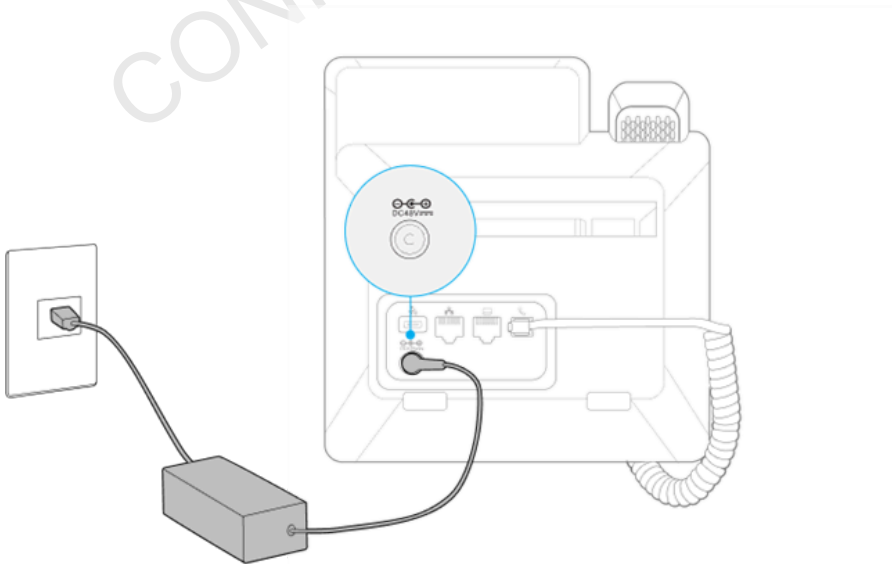

Register your phone.

For a wireless network

Follow the steps in this section to connect your phone in a wireless network.

1. Connect the shipped handset to the handset port.

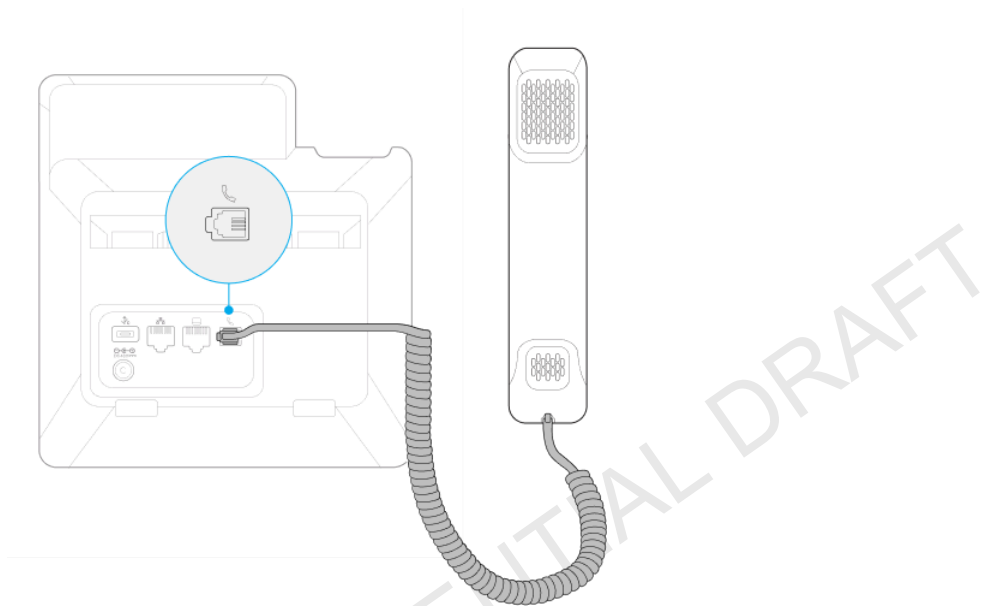

2. Insert the foot stand to the slots on the back of the phone.

The foot stand is designed for two tilt angles. Try both tilt angles to find the best position for your viewing preferences. To switch to the other angle, unplug the foot stand, flip it over, and reinsert it to the slots.

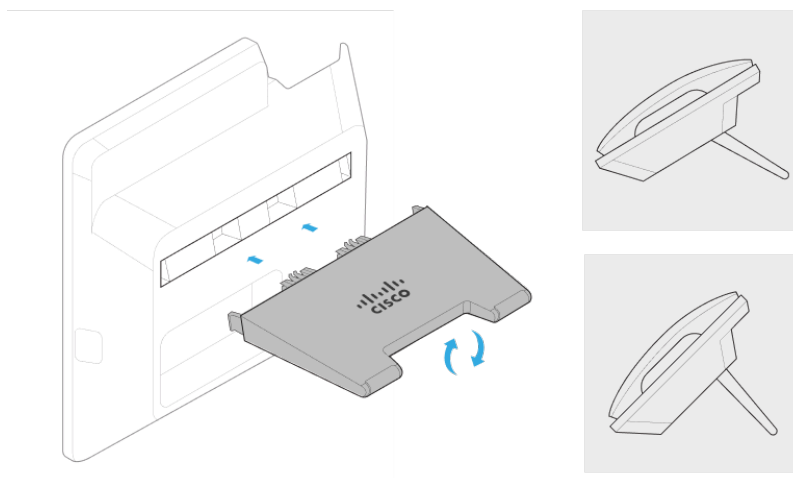

3. Connect your phone to a power socket with the shipped power adapter.

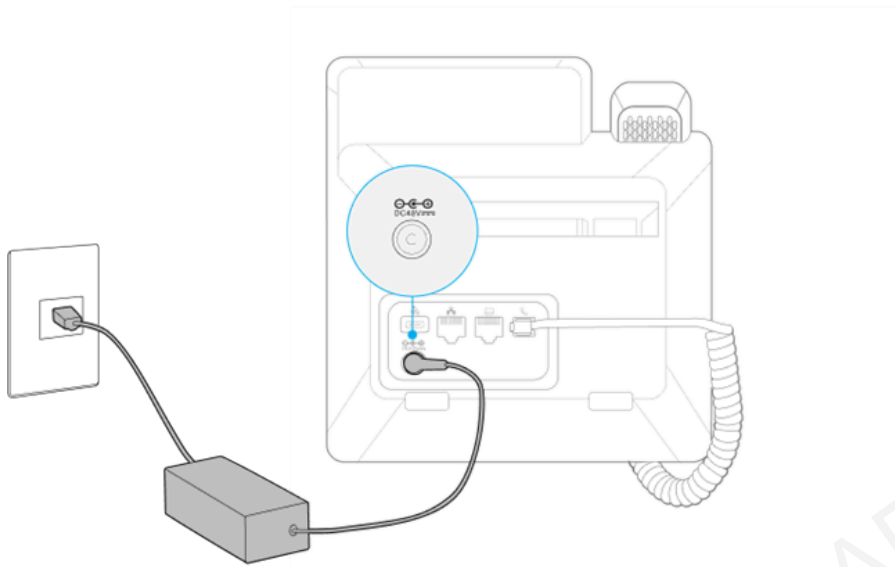

Your phone boots up automatically when it connects to the power source.

4. Tap **Start** on the Welcome screen.
5. Choose your wireless network from the list, enter the username and password, and tap **Apply**.

Register your phone.

Register your phone

Depending on how your administrator configures your phone on the call control system, you might use one of the following methods to register your phone:

- **Method 1:** No action is required during the phone registration. The registration is done automatically.
- **Method 2:** A 16-digit activation code is required during the phone registration. You can get it from your administrator in advance. Enter the activation code when you are prompted for it.
- **Method 3:** An alternate TFTP server address is required if your phone is missing a TFTP address. You can get it from your administrator when this situation occurs. You need to manually enter the alternate TFTP server to continue the registration.

With auto registration

- You have turned on your phone.
- Your phone connects to the corporate network.
- Your administrator configures your phone on the call control system.

Your phone gets registered automatically when it boots up and connects to the network. In this scenario of auto registration, you don't need to enter any input as the whole registration proceeds automatically.

1. Tap **Start**.

If you don't take any action, the phone goes to the next step at timeout.

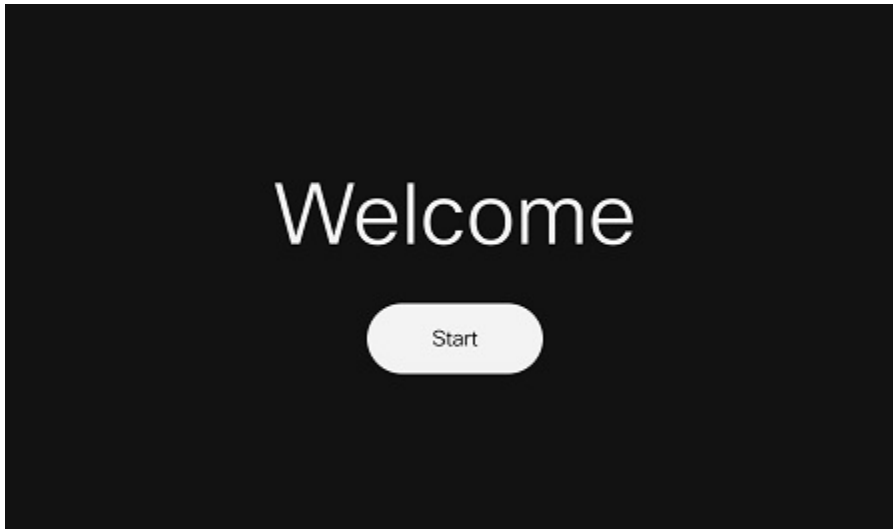

Your phone tries to connect to the network. If you use the wireless network, perform the next step. Otherwise, skip it.

2. **Optional:** Choose your wireless network from the list, enter your credentials, and tap **Apply**.
3. Tap **Next** on the phone screen showing that your phone successfully connects to ethernet or WiFi.

If you don't take any action, the phone goes to the next step at timeout. Then the phone starts checking the configuration, and then starts the registration automatically.

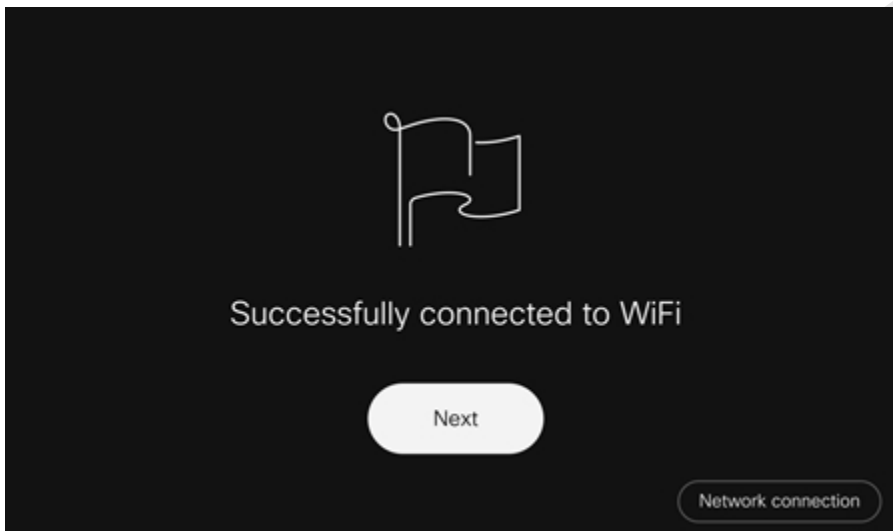
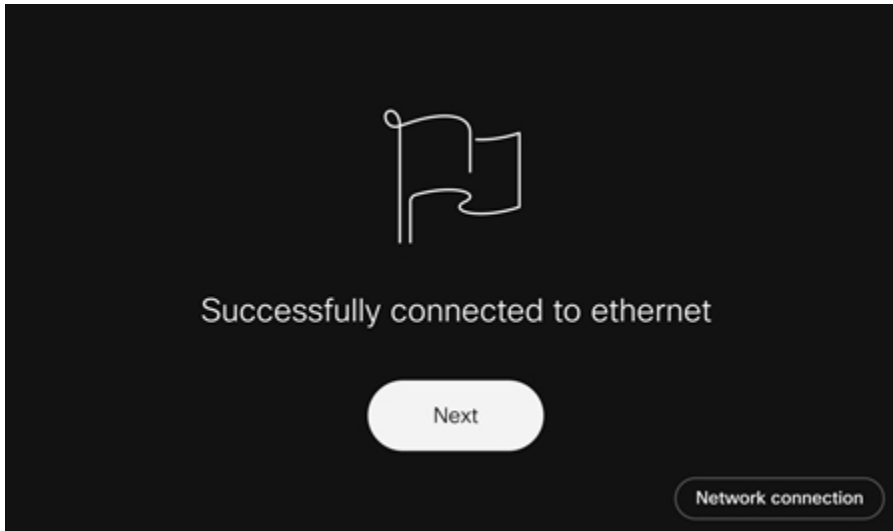

If you are prompted to choose a call service, do one of the following actions:

- If your phone will be registered on the Cisco Unified Communications Manager (Unified CM), tap **Cisco UCM > Register**.
- If your phone will be registered on the Webex Calling, tap **Cisco cloud service > Register**.



Note:

Contact your administrator if you don't know which service should be selected.

Typically, the registration takes about 3 minutes depending on the network condition. During the registration, we recommend that you should not press the power button.

After the registration succeeds, your primary line name or number displays on the top left of the phone screen.

4. When the registration is complete, you will be prompted to enable or disable the noise removal feature.

If you don't take any action, the phone enables the feature at timeout.

This feature can filter out background noises during a call. If you choose to disable the feature now, you can still enable it later.

Related information

Connect to a Wi-Fi network

Configure Ethernet settings for your phone

With activation code

- You have turned on your phone.
- Your phone connects to a wired or wireless network.
- Get a 16-digit activation code from your administrator.

After your phone boots up, it checks the configuration automatically, and you will be prompted to enter an activation code. If you don't have a new activation code, contact your administrator.

Activation codes are used to set up your new phone. They can only be used once, and expire after 1 week.



Note:

You might be prompted to choose a call service during the registration, depending on your network condition and your administrator's configurations on the call control system.

1. Tap **Start**.

If you don't take any action, the phone goes to the next step at timeout.

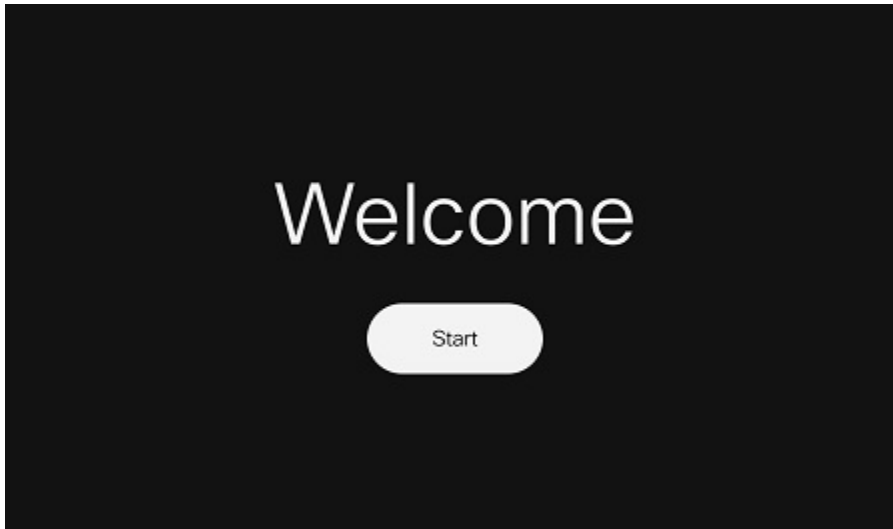

Your phone tries to connect to the network. If you use the wireless network, perform the next step. Otherwise, skip it.

2. **Optional:** Choose your wireless network from the list, enter your credentials, and tap **Apply**.
3. Tap **Next** on the phone screen showing that your phone successfully connects to ethernet or WiFi.

If you don't take any action, the phone goes to the next step at timeout. Then the phone starts checking the configuration, and then starts the registration automatically.

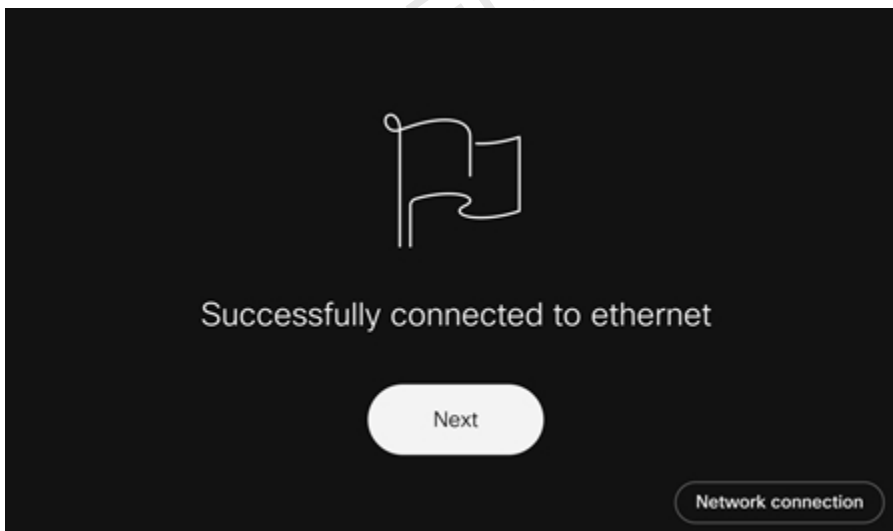

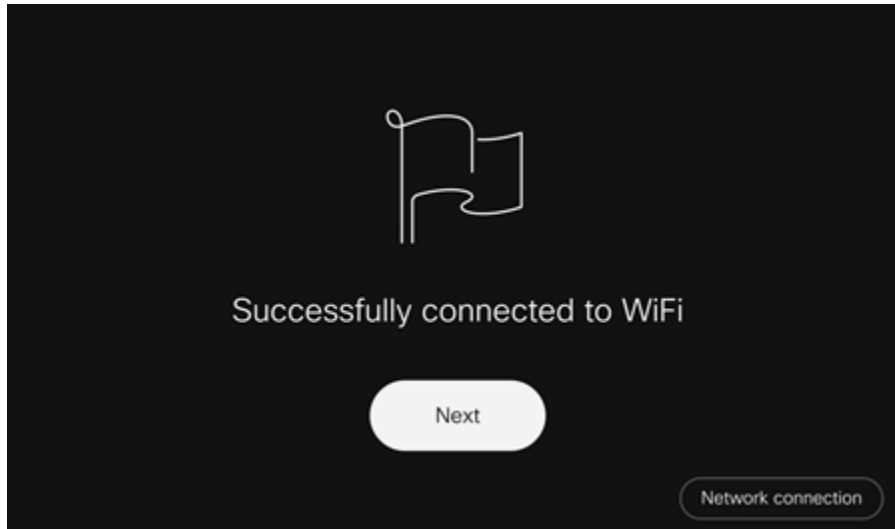

If you are prompted to choose a call service, do one of the following actions according to your network environment and the platform where the phone will be registered:

- If your phone connects to the corporate network and your phone will be registered on the Cisco Unified Communications Manager (Unified CM), tap **Cisco UCM > Register**.
- If your phone connects to the corporate network and your phone will be registered on the Webex Calling, tap **Cisco cloud service > Register**.
- If your phone uses Mobile and Remote Access (MRA) to connect to the corporate network when it's away from the office, tap **Cisco cloud service > Register**.



Note:

Contact your administrator if you don't know which service should be selected.

4. When prompted for an activation code, enter your activation code, and tap **Activate**.

Your phone starts the registration immediately. Typically, it takes about 3 minutes depending on the network condition. During the registration, we recommend that you should not press the power button.

After the registration succeeds, your primary line name or number displays on the top left of the phone screen.

5. When the registration is complete, you will be prompted to enable or disable the noise removal feature.

If you don't take any action, the phone enables the feature at timeout.

This feature can filter out background noises during a call. If you choose to disable the feature now, you can still enable it later.

With alternate TFTP

- You have turned on your phone.
- Your phone connects to a wired or wireless network.
- Get a TFTP server address from your administrator.
- Get a 16-digit activation code from your administrator, if needed.

In some situation, the Cisco DHCP server doesn't contain the network information of the TFTP servers. To accomplish the registration, you need to manually enter an alternate TFTP server address that your administrator provides.

1. Tap **Start**.

If you don't take any action, the phone goes to the next step at timeout.

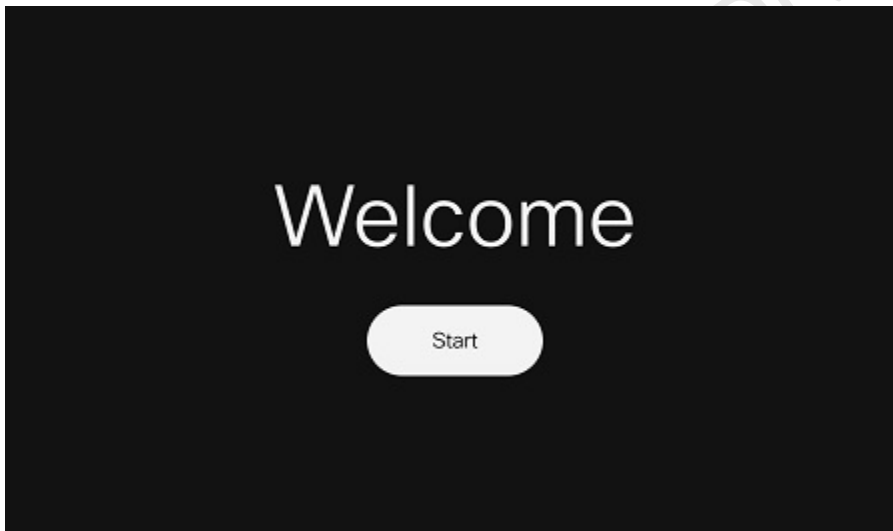

Your phone tries to connect to the network. If you use the wireless network, perform the next step. Otherwise, skip it.

2. **Optional:** Choose your wireless network from the list, enter your credentials, and tap **Apply**.
3. Tap **Network connection**.

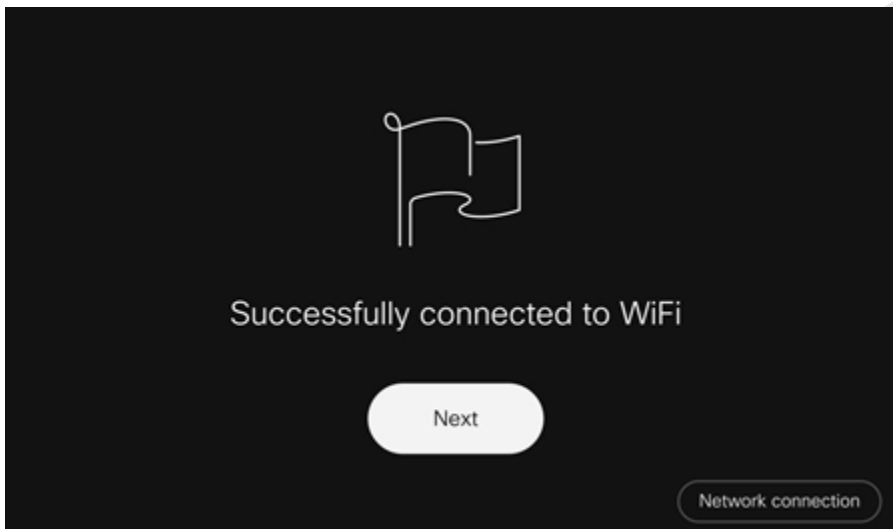
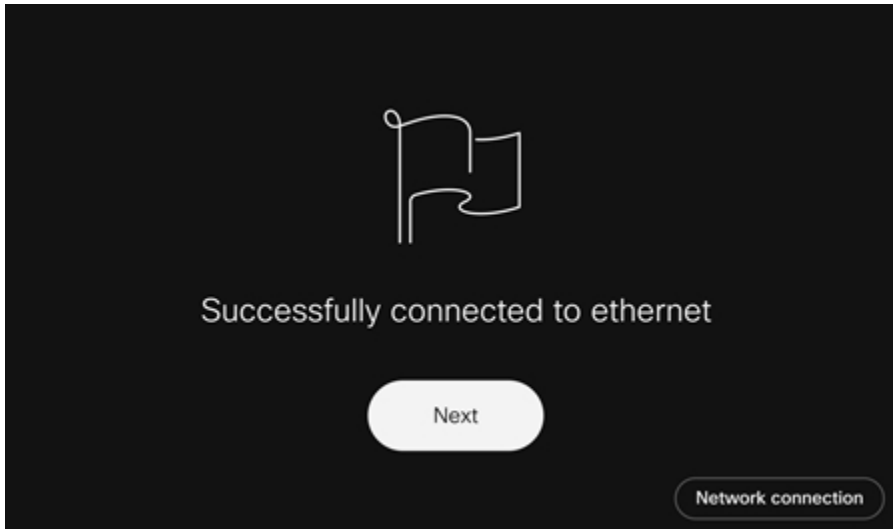

The screen shows the message depending on how your phone connects to the network.

4. Tap **Ethernet** on the **Network connection** screen.
5. Toggle on **Alternate TFTP**.
6. Enter an IP address in **TFTP Server <n>**, where <n> represents the type of the TFTP server.
TFTP Server 1 is the primary server, **TFTP Server 2** is the secondary server.
7. Tap **Apply**.

The registration starts automatically. If your phone requires an activation code to continue, do the following:

- a. Get an activation code from your administrator if you don't receive it yet.
- b. Enter your activation code, and tap **Activate**.

Typically, the registration takes about 3 minutes depending on the network condition. During the period, we recommend that you should not press the power button.

After the registration succeeds, your primary line name or number displays on the top left of the phone screen.

8. When the registration is complete, you will be prompted to enable or disable the noise removal feature.

If you don't take any action, the phone enables the feature at timeout.

This feature can filter out background noises during a call. If you choose to disable the feature now, you can still enable it later.

Sign in to a shared phone (Hot Desking) (MPP)

If you're working in a shared workspace that has a Cisco phone with the hot desking feature enabled, you can sign in and book the phone to use as your personal device. Once booked, the phone loads your contacts, Webex calendar, and call history, allowing you to easily access and manage your communications. This feature enables you to work more efficiently and effectively in a shared workspace environment.

Sign in and book a shared phone

Make sure you have installed and signed in to Webex App on your mobile phone.

1. Use the camera on your mobile phone to scan the QR code displayed on the phone screen.
2. Wait until the Booking page shows up.

The sign-in process would take about a minute to complete. You can't use the phone keys when sign-in is in processing.

3. Choose the end time for your booking from the time selector.



Note:

The phone doesn't support bookings that span multiple days.

4. Tap **Book desk** to confirm your booking.
5. Wait until the phone restarts.

When you successfully book the device, you can see that your directory number, call history, and Webex calendar displayed on the phone.

Sign out of the booked phone

If you need to end your booking earlier, simply sign out of the phone to make the workspace available for other users. Otherwise, the system will automatically sign you out when your booking duration expires. If you happen to be on a call when the booking expires, the phone will keep the call connected and sign you out after the call ends.

For privacy reasons, your personal data will be removed from the device once you sign out.



Note:

Active calls prevent automatic sign-out even after your booking duration expires. Make sure that you end all calls on the phone before you leave the desk, as this prevents you from being able to sign out remotely or from the phone.

Phone

End all calls on the phone before you sign out.

1. On the phone screen header, tap **Settings > Hot desking settings**.
2. Tap **Sign out** on the pop-up message.

Webex App

End all calls on the phone before you sign out.

You can sign yourself out of a booked device using Webex App either on your mobile phone or on your computer. This option is helpful when you leave the workspace forgetting to sign out.

1. On your Webex App, choose the **Connect to device** icon .
2. Locate your booked phone in the **Booked devices** list and choose **Sign out**.
3. Confirm the sign-out in the pop-up window.

Sign yourself in to a shared phone (Extension Mobility) (Onprem)

Your administrator has configured the extension mobility (EM) feature on the phone.

The extension mobility feature allows you to log in to any IP phone in your organization and use it as if it were your own. This feature is useful if you often move between different offices or workstations.

When you log in to an IP phone using the extension mobility feature, the phone retrieves your personal settings such as speed dials, phone directory, call history, and voicemail settings.

Once you sign out of the phone, your personal settings are automatically removed from the phone.

**Note:**

Depending on the settings on the shared phone, you may find the EM feature as a feature button, a feature shortcut on the **Shortcuts** tab, or a menu item under **Settings > Customized services**.

1. Tap **Extension Mobility** .

**Note:**

The name of the extension mobility feature may vary.

2. Enter your user ID and PIN.
3. Tap **Submit**.
4. To sign out of the shared phone, tap **Extension Mobility** , and then select **Yes** to confirm the logout.
5. Tap **Exit** to close the window.

Use the touchscreen

Depending on configurations, your phone can have a single line or multiple lines. The features are organized differently. Use the following sections to know how to navigate the features on your phone.

Single line

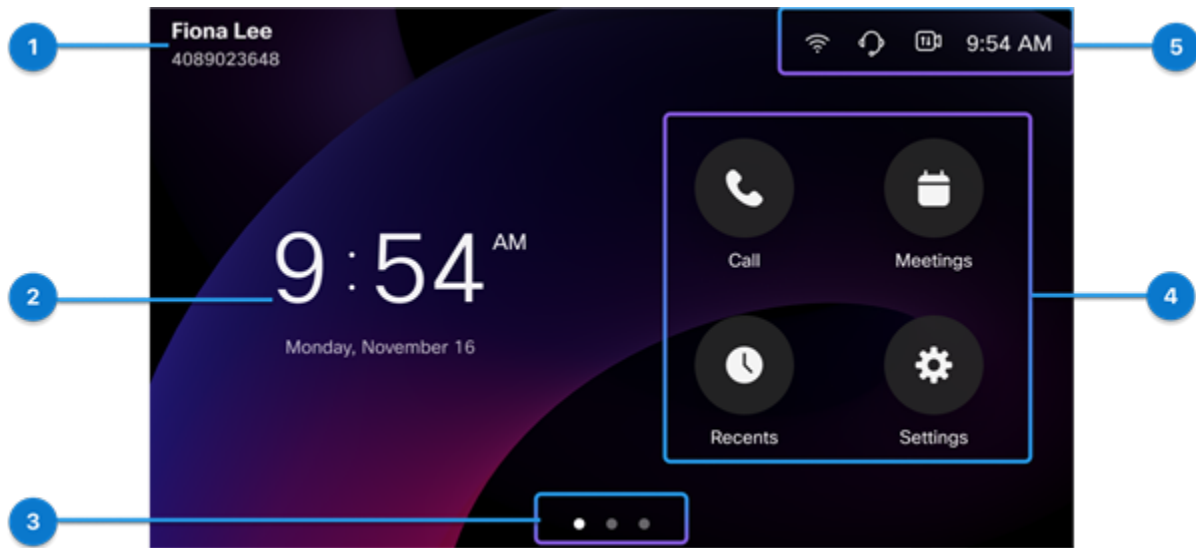
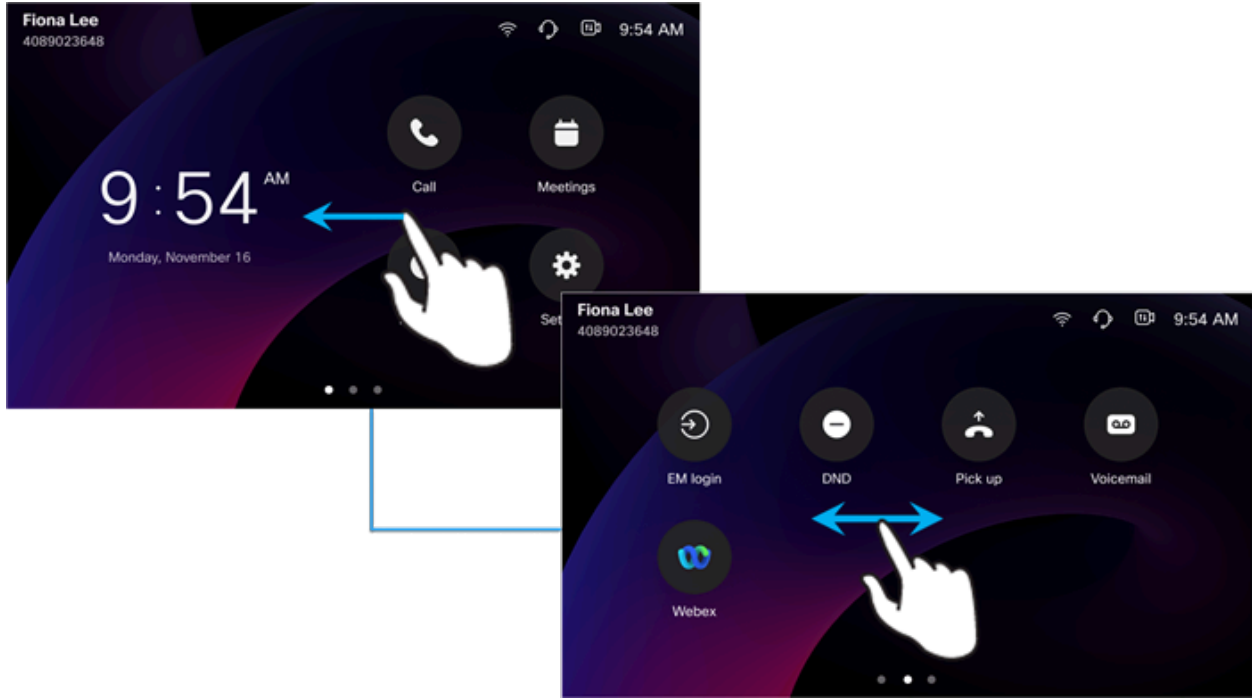

Table 4. Home screen items

UI element	Description
1. Line name and number	Shows the line name and line number.
2. Time and date	Displays the current time and date.
3. Navigation buttons	Tap the buttons to navigate between screens. The number of buttons varies with the configured shortcuts.
4. Feature buttons and shortcuts	Tap an item to access the feature. The available feature buttons and shortcuts vary with configurations.
5. Header	The screen header displays the system status, such as Wi-Fi signal, speaker off, and the active audio path. You can also change the audio path and camera exposure in the header.

Swipe on the screen to navigate between screens. Tap a button to access a feature.



Multiple lines

On the right half of the home screen, you can see the registered lines and the call pickup and speed dial shortcuts, if your administrator has configured them. Your primary line displays at the top of the list.

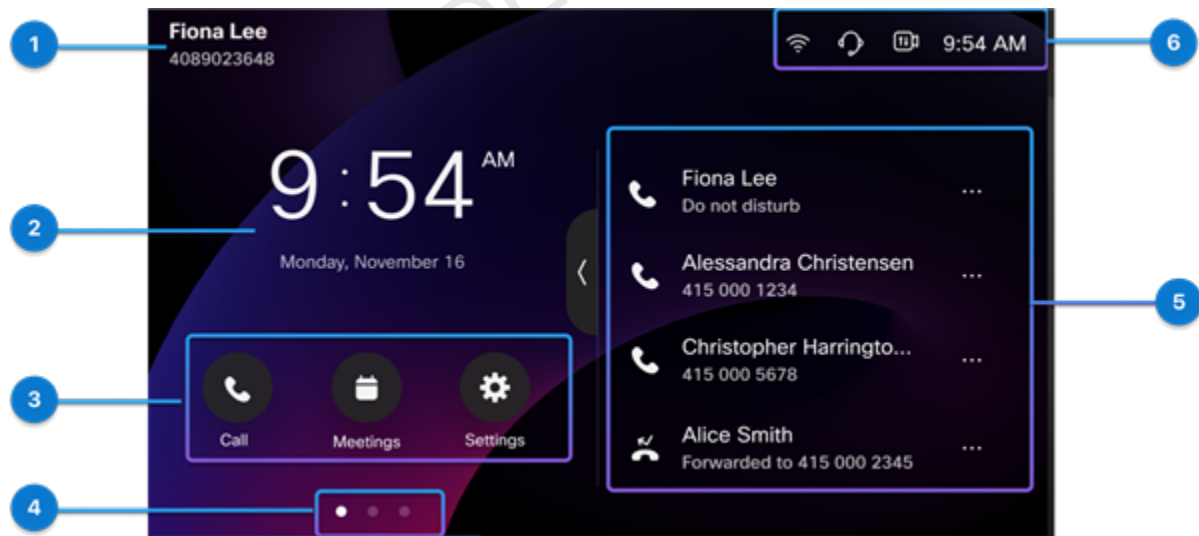

Table 5. Home screen items

UI element	Description
1. Primary line name and number	Shows the name and number of the primary line.

Table 5. Home screen items (continued)

UI element	Description
2. Time and date	Displays the current time and date.
3. Feature buttons and shortcuts	Tap an item to access the feature. The available feature buttons and shortcuts vary with configurations.
4. Navigation buttons	Tap the buttons to navigate between screens. The number of buttons varies with the configured shortcuts.
5. Lines and shortcuts	Use the registered lines and shortcuts for calls.
6. Header	The screen header displays the system status, such as Wi-Fi signal, speaker off, and the active audio path. You can also change the audio path and camera exposure in the header.

Do the following actions as needed:

- Swap on the left half of the screen to navigate the features and shortcuts.

- Tap **Expand**  to use the full-screen mode.

Tap **Fold**  to exit the full-screen mode.

- Tap a button or shortcut to access a feature.

Tap **More**  on a line to access a feature.

- Tap a line to call your contacts.

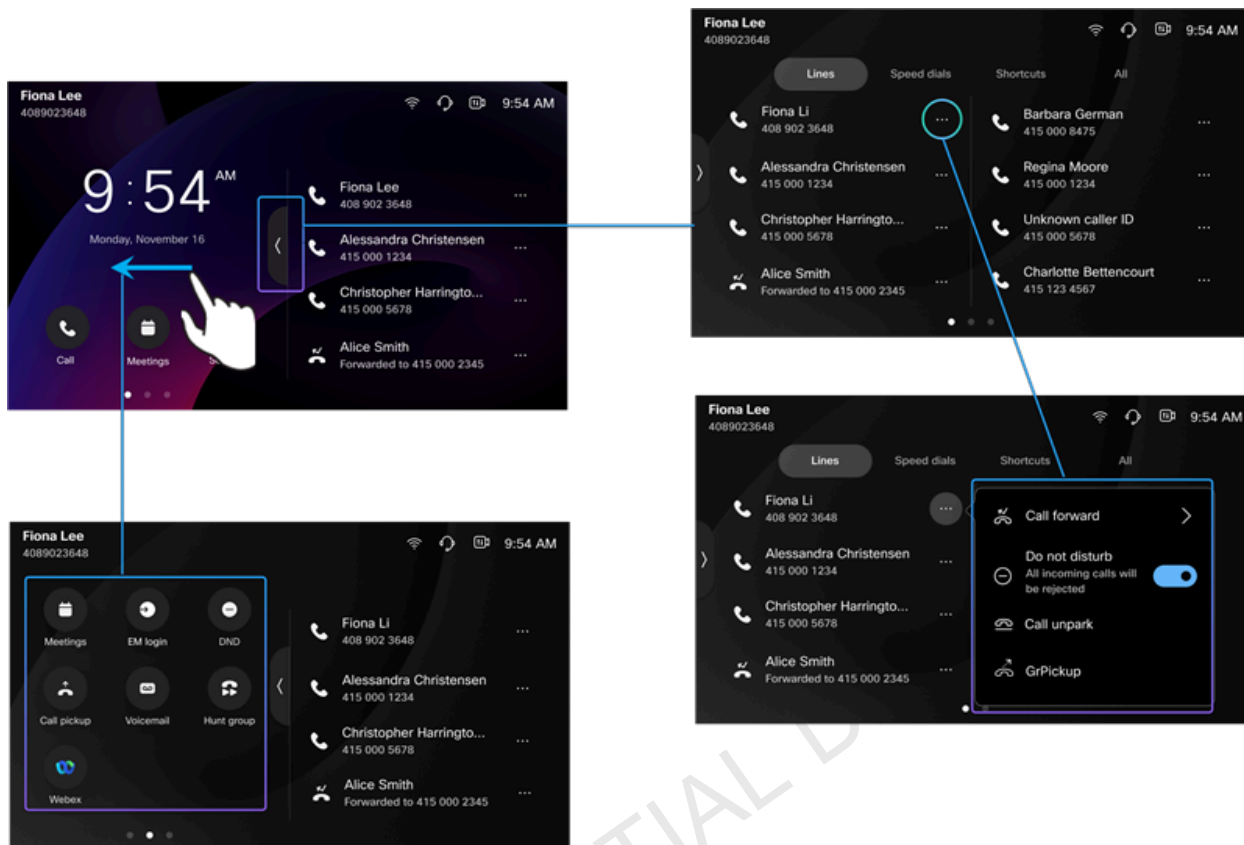

Need more help?

Use the following sections to get more help:

See the following sections for more help information:

- To look for more documentation about your phone, go to **Help Center**.
- To look for technical support, go to **Cisco technical support**.
- To view the hardware warranty terms, go to **Cisco one-year limited hardware warranty terms**.

Help Center

Go to the Cisco Desk Phone 9800 Series Help home page to get more help content about your phone. If you don't find the topic of your interest there, try to search for it and use the filters on the left to narrow down the results, if necessary.

Technical support

Cisco provides around-the-clock technical support services, both online and over the phone to all customers, partners, resellers, and distributors who hold valid Cisco service contracts.

You should have your Cisco.com User ID, Contract, and Serial numbers ready when you contact Cisco Support to prevent any delays with your support request.

In addition, support staff need the following information:

- Serial number—Every device has a serial number on the back.
- Time and date issue occurred—Support staff use device logs or cloud metrics to troubleshoot issues. It is helpful to have the approximate local time and date.
- Device Logs—Support staff may require the device logs to identify the root cause of your issue.
- A brief description—Include any actions prior to the incident.

Most firmware issues can be resolved by support staff without a Return Material Authorization (RMA). It is best to use the RMA process for hardware issues.

You can find a list of Cisco worldwide support centers at <https://www.cisco.com/c/en/us/support/web/tsd-cisco-worldwide-contacts.html>.

Cisco one-year limited hardware warranty terms

Special terms apply to your hardware warranty and services that you can use during the warranty period.

Your formal Warranty Statement, including the warranties and license agreements applicable to Cisco software, is available at [Product Warranties](#).

Chapter 3. Calling

Make and answer calls (MPP)

Make and answer calls

You can make and answer calls with either the touchscreen or the hardkeys on your phone.



Note:

If there's a meeting ongoing on the phone, leave the meeting to make or answer a call. The phone can't handle a meeting and a call at the same time.

If you have a Cisco Headset with the call control feature connected to your phone, you're able to answer a call with its call button.

Need help for Cisco Headsets? See [Cisco Headsets](#).





Make a call

Your phone can have one or multiple lines as your administrator configures.

Single line

You can either call phone numbers or call contacts from your directories.

1. Do one of the following actions:

- Tap  **Call**, and then search for the contact to call in **Favorites** and **Directories**, or tap a call in **Recents** to call back.
- On the Home screen, enter the phone number to call with the phone keypad and tap  to call the number.
- Tap  **Recents** and select a call from the list to call back.
- Press  **Contacts** and enter the contact name in the **Search or dial** bar to search from the **Favorites** and **Directories**. Tap the contact name to call.



2. Tap **End call** when you finish the call.

Multiple lines

You can use a particular line to make calls. The extension that displays on the top is your primary line. If you don't select an extension before you dial a number, then the primary line is used by default.

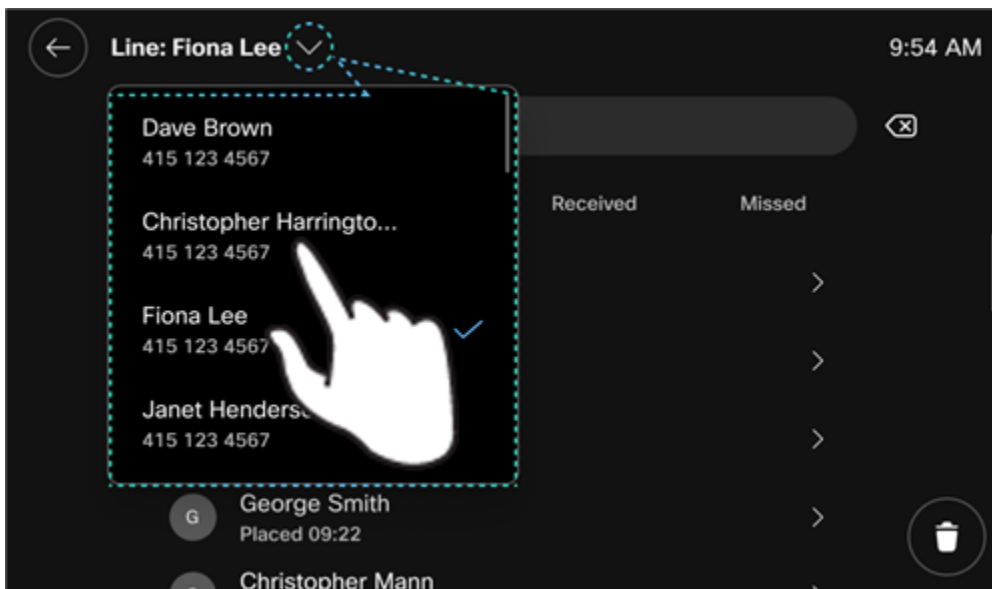
1. On your phone home screen, tap .
2. Select your desired line to use for the call from the Lines list.



3. Do one of these actions:
 - Enter the phone number to call with the phone keypad and tap  to call the number.
 - Tap **Search or dial** to enter the phone number with the soft keypad on the phone screen, and tap  to call the number.
 - Tap a call from the **Recents** list to call back.
 - Enter a contact's name in the **Search or dial** bar to search from the **Favorites** and **Directories**. Tap the contact name to call.

This feature is available if your administrator configures it.

4. Tap **End call** when you finish the call.

Make an emergency call

Your phone must be set up to obtain your physical location. Emergency services personnel need your location to find you when you make an emergency call.

Use your phone to make an emergency call, similar to any other call. When you dial the emergency number, your emergency services get your phone number and location so that they can assist you.

**Note:**

If your call disconnects, the emergency services can call you back.

Enter the emergency number and tap .

Answer a call

Single incoming call

You can answer an incoming call with the phone handset, the phone speaker, or the connected headset.

**Note:**

Your phone may automatically answer an incoming call according to your administrator's configuration.

When prompted with an incoming call, do one of these actions to answer it:

- Tap **Answer** on the phone screen to answer the call with the prespecified audio path.

**Note:**

If you are on an active call, the soft button is **Hold & Answer** instead. You can tap it to hold the current active call and answer the incoming call.

- Lift the phone handset to answer the call with the handset.
- Press **Headset**  to answer a call with the connected headset.

**Note:**

If there's more than one headset connected, the last connected one is used as the active audio path.

- Press **Speakerphone**  to answer a call with the phone speaker.



CAUTION:

Keep in mind that the people around you might be able to hear your call too.

Multiple incoming calls

When your line receives multiple calls at the same time, you can see a call list, where you can answer, decline, or silence the ringer.

You can open the call list from the home screen or from the in-call screen as shown in the following graphic.

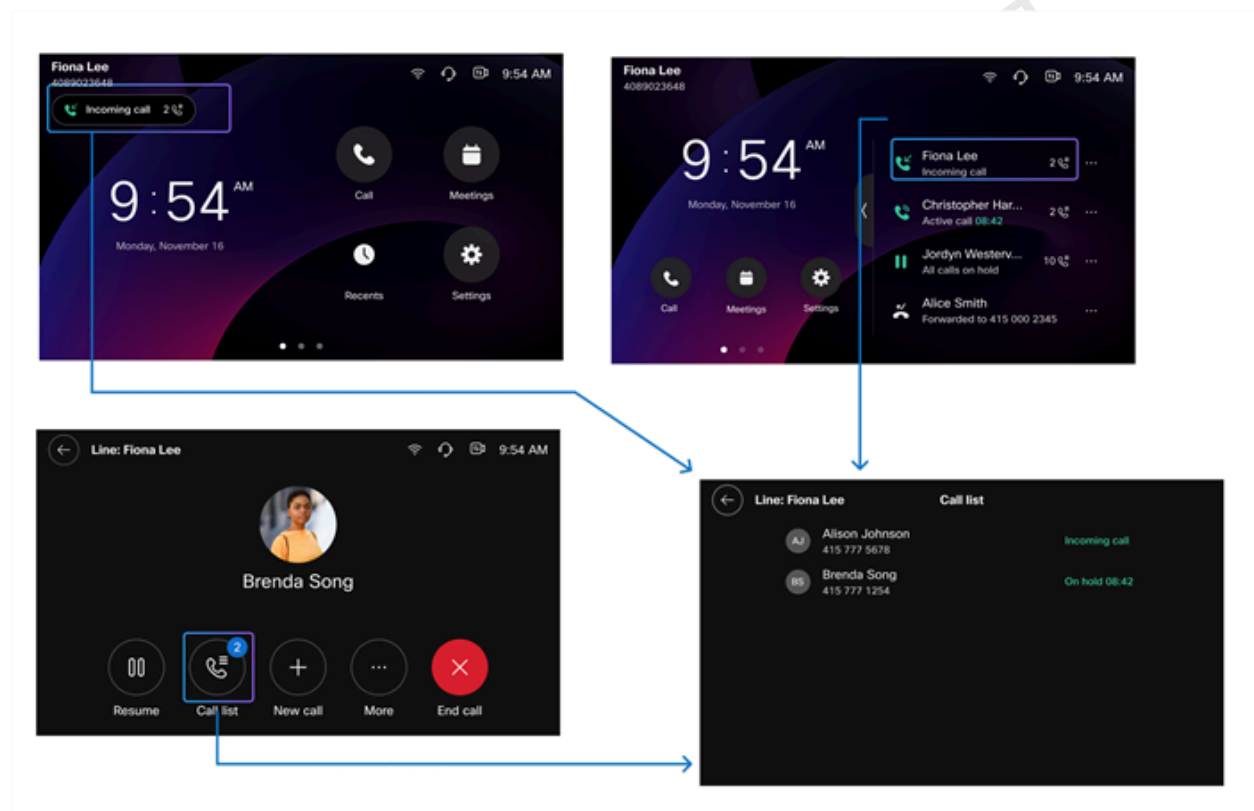

Note:

Your phone may automatically answer an incoming call according to your administrator's configuration.

1. Open the call list.
2. On the call list, tap the call that you want to answer.

3. Do one of the these actions:

- Tap **Answer** on the phone screen to answer the call with the pre-specified audio path.

**Note:**

If you are on an active call, the soft button is **Hold & Answer** instead. You can tap it to hold the current active call and answer the incoming call.

- Lift the phone handset to answer the call with the handset.
- Press **Headset**  to answer a call with the connected headset.

**Note:**

If there are more than one headset connected, the last connected one is used as the active audio path.

- Press **Phonespeaker**  to answer a call with the phone speaker.

**CAUTION:**

Keep in mind that the people around you might be able to hear your call too.

**Note:**

If an active call is ongoing, you can't directly answer an incoming call by handset, headset, and phonespeaker.

Make and answer calls (Onprem)

Make and answer calls

You can make and answer calls with either the touchscreen or the hardkeys on your phone.

**Note:**

If there's a meeting ongoing on the phone, leave the meeting to make or answer a call. The phone can't handle a meeting and a call at the same time.

If you have a Cisco Headset with the call control feature connected to your phone, you're able to answer a call with its call button.

Need help for Cisco Headsets? See [Cisco Headsets](#).

Make a call

Your phone can have one or multiple lines as your administrator configures.

Single line

You have different ways to make a call. For example, you can use your phone just like any other phone, use your speakerphone or headset for hands-free calling, or tap a button to use a feature available on the phone, and so on.

Choose one way to make a call according to your actual situation.





1. Do one of the following actions:

- Enter a number and pick up the handset.
- Enter a number with the phone keypad, and press **Speakerphone** .

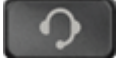

CAUTION:

Keep in mind that the people around you might be able to hear your call too.

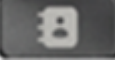
- Plug in a headset, enter a number with the phone keypad, press **Headset** .
- On the phone home screen, enter a number with the phone keypad, and tap  to make a call.
- Tap **Call** , search for a call entry from the **Recents** tab or a contact from the **Directories** tab, and tap the target to make a call. You can search for a contact in the search bar by using a phone number or a contact name.
- Tap **Recents** , locate the call entry, and tap the entry to make a call.
- Press **Contacts** , search a contact name in the search bar, and tap the contact to make a call.

When a call is connected, the in-call screen shows as below:

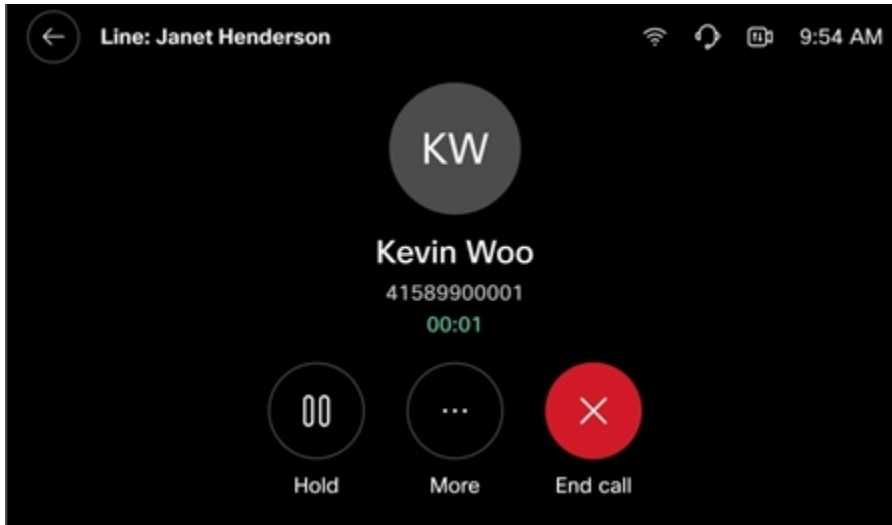

Typically, an in-call screen shows the following information of the contact:

- Contact name (if configured)
- Contact number or URI address
- Call duration

2. **Optional:** If you want to make a new call during the current active call, do the following:

- a. Tap **Hold**  on the phone screen or press **Hold/Resume**  on the phone keypad.

After you hold the call, the **New call**  button appears on the phone screen.

- b. Tap **New call**  to make a call to another person.

By default, each line can have up to 6 calls at the same time. If you want to change the maximum number, consult your administrator.

3. Tap **End call**  when you finish the call.

Related information

[Make a call from call history](#)

[Search for a contact](#)

[Put a call on hold](#)

[Swap between active and held calls](#)

[Turn your video stream on or off during a call](#)

Multiple lines

You can use a particular line to make a call. The extension that displays on the top left is your primary line. If you don't select an extension before you dial a number, then the primary line is used by default.

1. Select a line on your phone.

- a. On your phone home screen, tap **Call** .
- b. Select your desired line to use for the call from the Lines list.

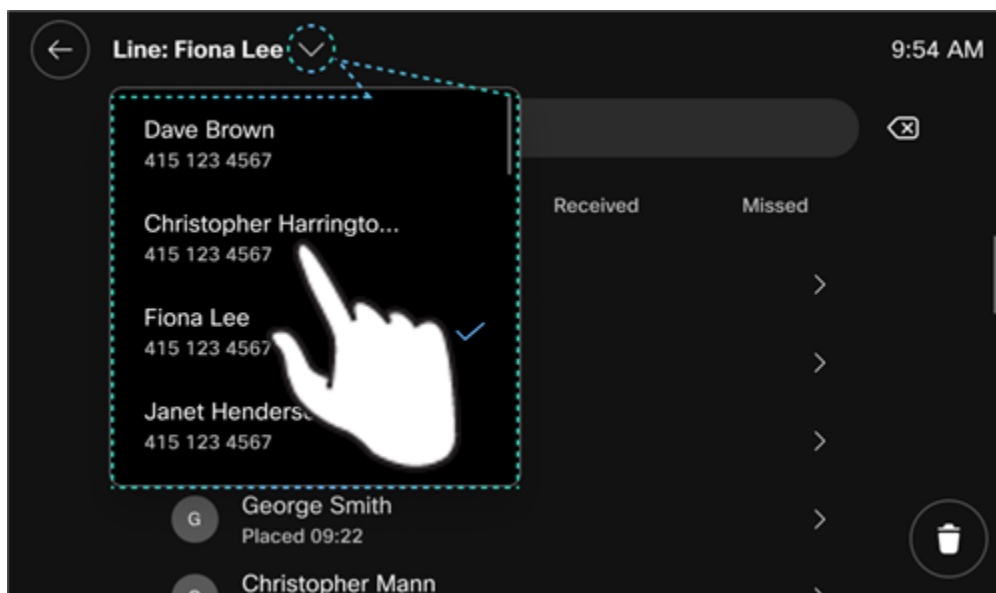



2. Do one of these actions:







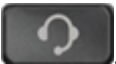

- Enter a number and pick up the handset.
- Enter a number with the phone keypad, and press **Speakerphone** .



CAUTION:

Keep in mind that the people around you might be able to hear your call too.

- Plug in a headset, enter a number with the phone keypad, press **Headset** .
- On the phone home screen, enter a number with the phone keypad, and tap  to make a call.

- Tap **Call** , search for a call entry from the **Recents** tab or a contact from the **Directories** tab, and tap the target to make a call. You can search for a contact in the search bar by using a phone number or a contact name.
 - Tap **Recents** , locate the call entry, and tap the entry to make a call.
 - Press **Contacts** , search a contact name in the search bar, and tap the contact to make a call.
3. **Optional:** If you want to make a new call during the current active call, do the following:
- a. Tap **Hold**  on the phone screen or press **Hold/Resume**  on the phone keypad.
After you hold the call, the **New call**  button appears on the phone screen.
 - b. Tap **New call**  to make a call to another person.
By default, each line can have up to 6 calls at the same time. If you want to change the maximum number, consult your administrator.
4. Tap **End call**  when you finish the call.

Related information

[Make a call from call history](#)

[Search for a contact](#)

[Put a call on hold](#)

[Swap between active and held calls](#)

Turn your video stream on or off during a call

Make an emergency call

Your phone must be set up to obtain your physical location. Emergency services personnel need your location to find you when you make an emergency call.

Use your phone to make an emergency call, similar to any other call. When you dial the emergency number, your emergency services get your phone number and location so that they can assist you.



Note:

If your call disconnects, the emergency services can call you back.

Enter the emergency number and tap .

Answer a call

Single incoming call

You can answer an incoming call with the phone handset, the phone speaker, or the connected headset.



Note:

Your phone may automatically answer an incoming call according to your administrator's configuration.

When prompted with an incoming call, do one of these actions to answer it:

- Tap **Answer** on the phone screen to answer the call with the prespecified audio path.



Note:

If you are on an active call, the soft button is **Hold & Answer** instead. You can tap it to hold the current active call and answer the incoming call.

- Lift the phone handset to answer the call with the handset.
- Press **Headset**  to answer a call with the connected headset.



Note:

If there's more than one headset connected, the last connected one is used as the active audio path.

- Press **Speakerphone**  to answer a call with the phone speaker.



CAUTION:

Keep in mind that the people around you might be able to hear your call too.

Multiple incoming calls

When your line receives multiple calls at the same time, you can see a call list, where you can answer, decline, or silence the ringer.

You can open the call list from the home screen or from the in-call screen as shown in the following graphic.

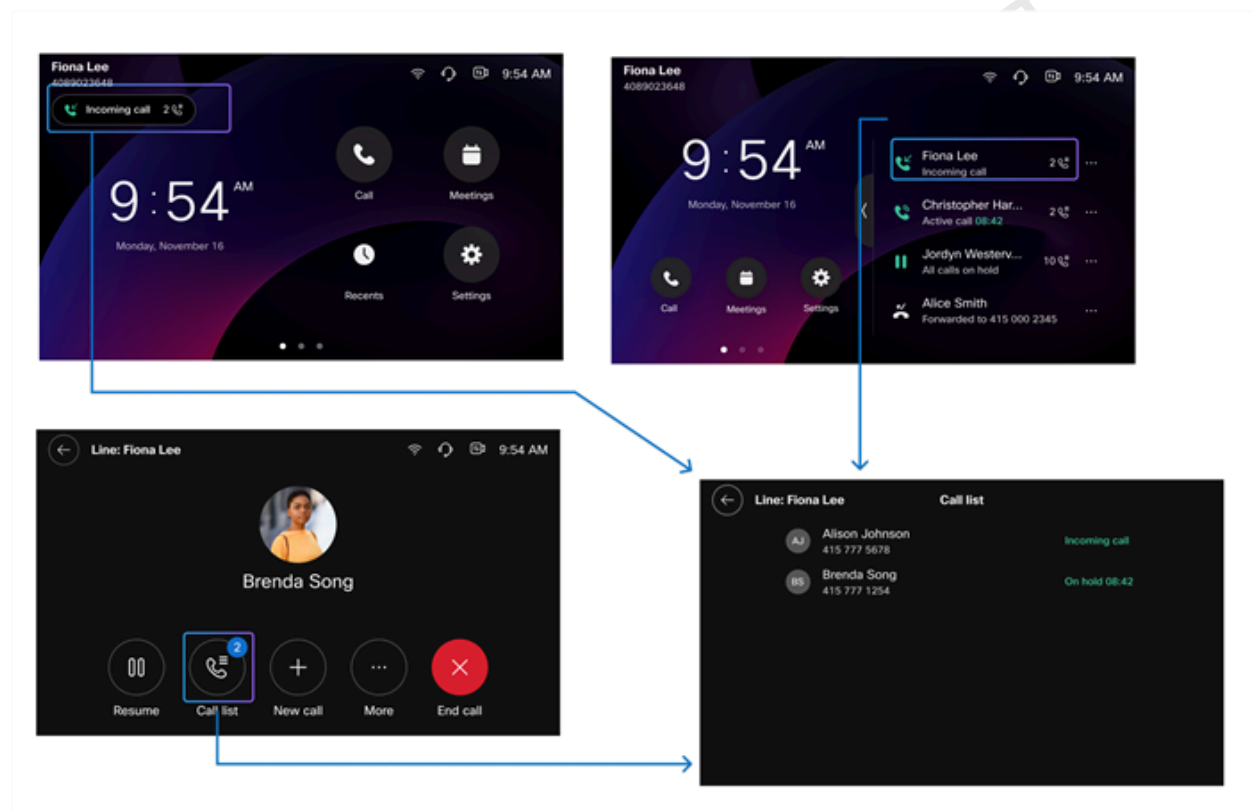

Note:

Your phone may automatically answer an incoming call according to your administrator's configuration.

1. Open the call list.
2. On the call list, tap the call that you want to answer.

3. Do one of the these actions:

- Tap **Answer** on the phone screen to answer the call with the pre-specified audio path.



Note:

If you are on an active call, the soft button is **Hold & Answer** instead. You can tap it to hold the current active call and answer the incoming call.

- Lift the phone handset to answer the call with the handset.
- Press **Headset**  to answer a call with the connected headset.



Note:

If there are more than one headset connected, the last connected one is used as the active audio path.

- Press **Phonespeaker**  to answer a call with the phone speaker.



CAUTION:

Keep in mind that the people around you might be able to hear your call too.



Note:

If an active call is ongoing, you can't directly answer an incoming call by handset, headset, and phonespeaker.

Decline a call

When prompted with an incoming call, you can decline it by sending a ringing call to your voicemail system (if configured). If your administrator doesn't set up your voicemail system, the call is rejected and the caller hears a busy tone.

Single incoming call

Tap **Decline**.

If your phone contains multiple lines, the receiver displays on the phone screen, as the following example shows:

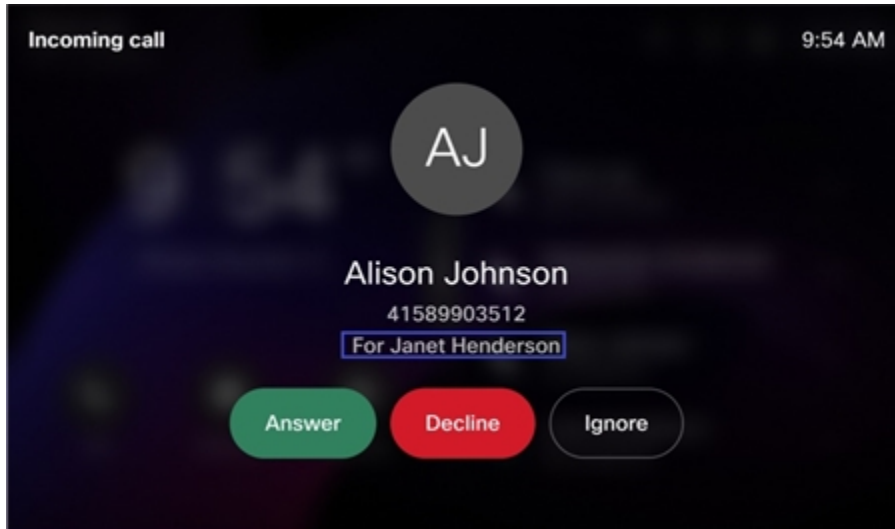

Multiple incoming calls

When your line receives multiple calls at the same time, open the call list to decline the calls.

1. Open the call list, do one of the following actions:
 - On the phone home screen with a single line, tap the banner of call status.
 - On the phone home screen with multiple lines, tap the desired line.
 - On the in-call screen, tap **Call list**  .

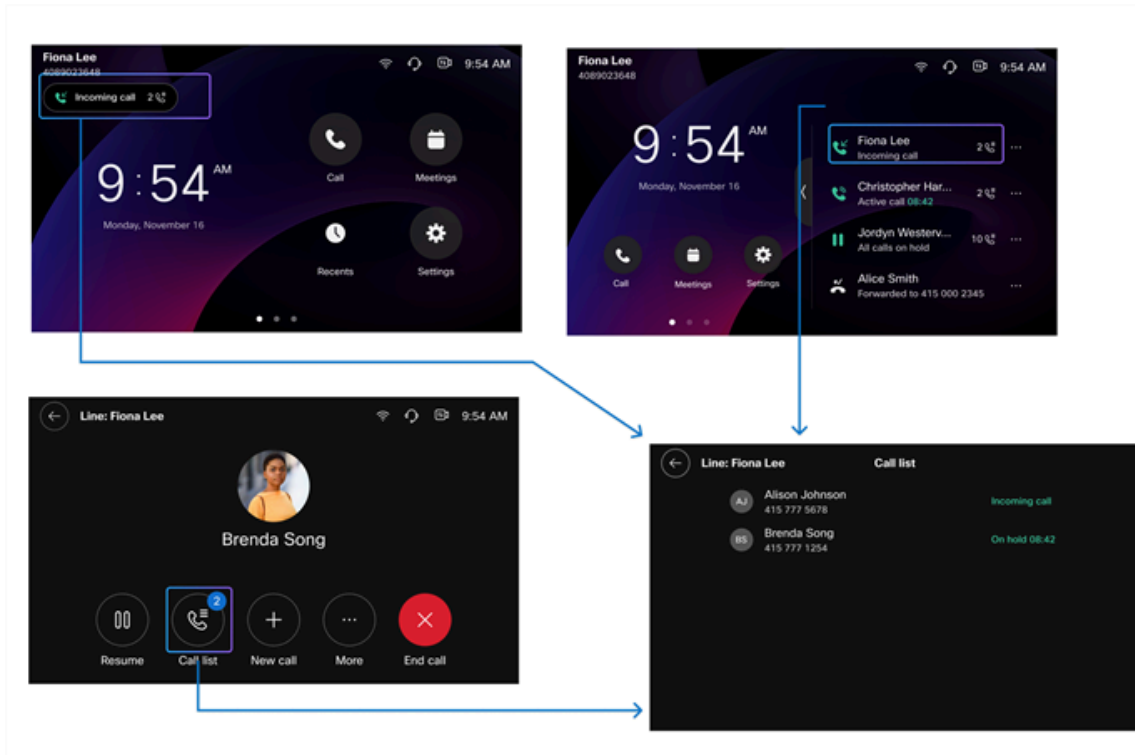

2. On the call list, tap the incoming call that you want to decline.
3. Tap **Decline**.

For a connected call, tap **More**  **> Decline** to divert the call to the voicemail system (if configured).

Whether the button displays depends on your administrator's configuration on the call service.



Note:

You can choose to tap **Decline all** to reject all the incoming calls.

Make an intercom call

Your administrator has configured an intercom line on your phone.

You can use an intercom line to make a one-way audio call in which the recipient's phone answers the call automatically with mute activated (whisper mode).

Your phone enters the whisper mode until the recipient accepts the intercom call. In the mode, the other person can hear you, but you can't hear them. Your message is broadcast through the recipient's speakerphone, headset, or handset, if any is active.

After receiving the intercom call, the recipient can start two-way audio (connected state) to allow for further conversation.

If you are already on an active call and you make an intercom call, the active call is placed on hold.

1. Tap **Intercom** .

The line name and intercom number display next to the icon. If your administrator assigns a speed dial number to the line, the speed dial number displays following the intercom number.

For the intercom numbers that are configured as speed dials, you can also find them from the **All** and **Lines** tabs on the phone home screen (full-screen mode).



Note:

If your intercom line is not configured with a speed-dial number, you will be prompted to enter an intercom number. Then you need to enter a valid intercom number on the search bar.

2. Listen for the intercom alert tone, and then begin speaking.
On the phone home screen, you can view the call status, including the recipient and call duration.
3. Tap **End call**  when you finish the call.

Answer an intercom call

You receive a message that shows a person is whispering to you, and an audible alert indicates that the intercom call begins. Your phone answers the intercom call with mute activated automatically (whisper mode).

You can answer an intercom call to talk to the other person.

1. Tap **Talk** to switch to the connected state. In the connected state, you can speak to the intercom caller.

If you are on an active call, tap **Hold & Talk** to place the active call on hold and talk to the intercom caller.



2. **Optional:** In the whisper mode, if you want to return to the phone home screen, tap **Hide**.
You can view the call status, including the intercom caller and call duration.
3. Tap **End call** when you finish the call.

Make a call with speed dial

For phones that register to Cisco Unified Communications Manager: [add speed dials on Cisco Unified Communications Self Care Portal](#).

For Phones that registers to Cisco BroadWorks or Webex Calling: add speed dials on the phone web page.

To access your saved speed dials, navigate to the **Speed dials** tab in the full-screen mode on your phone.

1. On the phone home screen, tap **Expand**  to use the full-screen mode.
2. Tap the **Speed dials** tab, and select a contact to make a call.
3. Tap **End call**  when you finish the call.

Use BLF with speed dial and call pickup

Your administrator has configured the Busy Lamp Field (BLF) feature with speed dial on your phone.

Compared to the speed-dial buttons found on your phone's Speed Dials tab, BLF shortcuts with speed dial not only allow you to quickly dial the number but also enable you to monitor the status of your coworker's line. If the shortcut is also configured with the Call Pickup feature, you're able to answer calls for your coworkers when they're unavailable.

The following table lists the status indicators for BLF with speed dial.

Table 6. Status indicators for BLF with speed dial







Icon	Status	Description
	Idle	The monitored line is in idle mode. You can tap the shortcut to call the speed dial number.
	Alerting or Alerting · Pickup enabled	A call is alerting on the monitored line. If the Call Pickup feature is enabled for the BLF shortcut, you will see Alerting · Pickup enabled and you can answer the call for your coworker by tapping the BLF shortcut. Otherwise, tapping the shortcut initiates a call to the monitored line.

Table 6. Status indicators for BLF with speed dial (continued)

Icon	Status	Description
		 Note: If there's an active call on your phone that registers to Cisco Unified Communication Manager, end the active call before you can initiate or answer a call with the BLF shortcut.
	In use	The monitored line is on a call. If you tap the shortcut, a call is placed to the speed dial number. You'll hear a busy tone or be redirected to the voicemail depending on the configuration on your coworker's line.
	DND	The monitored line is set to Do Not Disturb (DND). The calls to the line don't alert.
	Unregistered	The monitored line isn't registered. The calls to the line don't get connected.

1. On your phone Home screen, tap **Expand**  to enter the full screen mode.
2. Go to the **Shortcuts** tab and do one of the following actions as needed:
 - View the status of the monitored lines.
 - Tap a BLF shortcut to call the associated extension.
 - Tap a BLF shortcut with the **Alerting · Pickup enabled** status to answer the call.

**Note:**

If there's an active call on your phone that registers to Cisco Unified Communication Manager, end the active call before you can initiate or answer a call with the BLF shortcut.

Configure speed dial numbers with Self Care Portal

You can customize the speed dial feature with the Cisco Unified Communications Self Care Portal, which you access from your computer. The Self Care Portal is part of your organization's Cisco Unified Communications Manager.

Your administrator gives you the URL to access the Self Care Portal, and provides your user ID and password. For more information, see [Cisco Unified Communications Self Care Portal User Guide, Release 12.5\(1\) or later](#).

Tips for special speed dial numbers

When you dial a number on your phone, you enter a series of digits. When you set up a speed dial number, it must contain all the digits you need to make the call. For example, if you need to dial 9 to get an outside line, you enter the number 9 and then the number you want to dial.

The dial string can contain the following characters:

- 0 to 9
- Pound (#)
- Asterisk (*)
- Comma (,)—This is the pause character, and gives a 2 second delay in the dialing. You can have several commas in a row. For example, two commas (,,) represent a pause of 4 seconds.

Before you configure the speed dial, try to dial the digits manually at least once to ensure that the digit sequence is correct.

Example

To set up a speed dial number to call a person at a specific extension, consider the following requirements:

- You need to dial **9** for an outside line.
- You want to call **5556543**.
- You must wait for **4** seconds.
- After the call connects, you must dial the extension **56789#**.

In this scenario, the speed-dial number is **95556543,,56789#**.

**Note:**

You can add up to 108 speed dial numbers on the phone.

Put a call on hold

You can put a call on hold and then resume it when you're ready. When you place a video call on hold, video transmission is blocked until you resume the call.

If you are on a call and receive another call, answering the call automatically puts the active call on hold. You can swap between calls using the call list.

**Note:**

Only one call can be active, other calls are automatically placed on hold.

1. Do one of the following actions to hold an active call:

- On the phone touchscreen, tap **Hold** .

- Press **Hold/Resume** .

The line on your phone shows the **Local on hold** icon  together with the `On hold` status and duration.

**Note:**

If someone uses the call barge feature to join the active call, the person will be disconnected automatically when you hold the call.

2. Do one of the following actions to resume a held call:

- On the phone touchscreen, tap **Resume** .

- Press **Hold/Resume** .

The line on your phone shows the **Active call** icon  together with the `Active call` status and duration.

Swap between active and held calls

When you have two calls or more on a line, you can see the count of calls on the phone home screen. You can open the call list from either the in-call screen or the phone home screen. The digit on the Call List button shows the count of calls on the line.

**Note:**

If you have only one call, the Call List button doesn't display on the phone screen.

The calls can include the following:

- The active call
- The held calls
- The incoming calls waiting for pickup

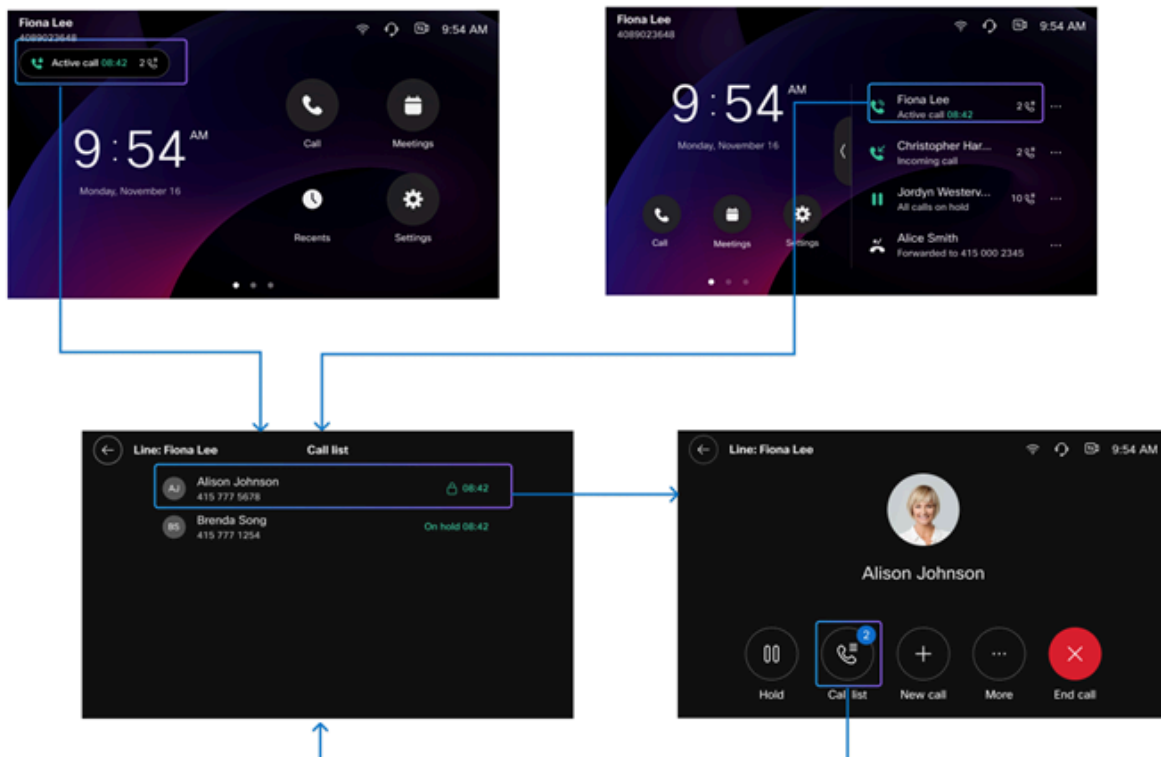

1. To open the call list, do one of the following actions:

- On the in-call screen, tap **Call list** .
- On the phone home screen with a single line, tap the banner of call status.
- On the phone home screen with multiple lines, tap the desired line.

2. Tap the desired call entry to open its in-call screen.

3. Perform the action as needed with the available buttons, such as resume a held call, put the active call on hold, and answer or reject an incoming call.

Use call park (Onprem)

Call park

You can park an active call and later pick up the parked call from your phone or retrieve it from another phone, such as a phone at a coworker's desk or in a conference room.

A parked call is monitored by your call control system so you won't forget about it. If the call remains parked for too long (typically 1 minute), you will receive an incoming call periodically to remind you to pick up the parked call. Then you can answer or ignore the call on your phone. If you don't answer the incoming call within a certain length of time (typically 5 minutes), it's routed to voicemail or another destination, as set by your administrator.

Park a call

- Your administrator has configured the call park feature on your phone.
- Your call must be active.

You can park an active call that you answered and resume it directly on your phone.

1. On an active call, tap **More** , choose **Call park**.

The call is parked and the phone screen displays the call park number which can be used to retrieve the parked call from another phone in your organization. You can park only one call at the call park number.

On the phone home screen, you can view the parked call status which contains the call park number.

If you have multiple calls, you can find the parked call in the call list.



Note:

If someone uses the call barge feature to join the active call, the person will be disconnected automatically when you park the call.

2. Press **Resume** to pick up the parked call.
3. **Optional:** Communicate the parked number to the person who needs to answer the call.

Retrieve a parked call

- An active call is parked.
- You have the call park number.

You can retrieve a parked call from another phone in your organization.

On another phone, enter the call park number and tap .

The parked call is connected.

Park and unpark calls (MPP)

Park and unpark calls

Call park puts an active call on hold and allows you to continue the conversation from another phone within your organization.

There are two ways to park and unpark a call:



- Use the phone user interface on your Cisco Video Phone 8875.

If your administrator configures a programmable line key for the call park feature on your phone, you can see the **Call park** and **Call unpark** shortcuts.
- Use the call park codes on any Cisco phone deployed within your organization.

Park a call

Your administrator has configured the Call Park feature on your phone.

After you park a call, the active call on your phone ends. You can retrieve the parked call on your phone, the destination phone, or any other phone in your organization.



1. On an active call, tap **More**  and choose **Call park**.
2. Enter the extension number on the search bar and tap .
The active call ends.

Retrieve the call on the destination phone or on any phone within your organization.

Retrieve the parked call

Your administrator has configured the call park feature on your phone.

If you have a call parked on your line, you see **Parked call** on the line.



1. Do one of the following actions to pick up the parked call:
 - **On a phone with a single line:**
Locate and tap the **Call unpark** softkey.
 - **On a phone with multiple lines:**
On the line with the parked call, tap **More**  and choose **Call unpark** from the list.
2. Enter the extension number on the search bar and tap .
The parked call is connected.

Park and retrieve a call with the call park codes

Your administrator has configured the call park code and the call unpark code.

You can park an active call by dialing the call park code with the phone keypad. With the call unpark code, you can pick up the parked call on any phone within your organization.

The call park code is *68, and *88 is the call unpark code.

1. To park an active call, use the phone keypad to enter *68 + destination ext number and tap .
The active ends.
2. To pick up a parked call with the call unpark code, use the keypad to enter *88 + destination ext number and tap .

Example:

You want to park the active call to the phone in a meeting room. The extension in the meeting room is 1234.

To park the call, dial *681234 while you are on the call. To pick up the parked call, you go to the meeting room and dial *881234 on the phone.

You can also pick up the call by dialing *881234 on any phone within your organization.



Transfer a call to another person

When you transfer a call, you can wait until the other person to answer. This allows you to make sure that the other person is available to have a conversation with the caller before you remove yourself from the call. You can also do a quick transfer without consulting the receiver.

When you transfer the call, the current call is put on hold. The call ends on your phone after you transfer it.

On an active call, do one of the following actions:

- Consult the receiver before you transfer the call:

- a. Tap **More**  > **Transfer**.
- b. Dial the phone number or search for the contact and tap it.
- c. Talk to the call receiver and tap **Transfer**  to complete the transfer.

You can also tap **Transfer**  before the receiver answers the call.

- Do a quick transfer (Available only on phones registered to Cisco BroadWorks or Webex Calling):



- a. Tap **More**  > **BlindXfer**.
- b. Dial the phone number or search for the contact and tap it to complete the transfer.

Forward calls (Onprem)

To avoid missing calls when you're away from office or your line is busy, set the phone to redirect incoming calls to an alternative phone number or to your voicemail.

The steps for configuring call forwarding are different for single line and multiple lines. The icon  on a line indicates that all incoming calls on this line will be redirected to another number. You can see the forwarded-to destination below the line name.



Single line

1. Locate and tap **Forward all**  from your phone home screen.
2. Do one of the following as needed:
 - Tap a history call in **Recents**.
 - Tap a contact in **Directories**.
 - Enter a phone number and tap .
 - Press the Message key  on the phone keypad to forward incoming calls to your voicemail.

All incoming calls will be forwarded to the specified destination.

3. To turn off the call forwarding service, Tap **Forward off** .

Multiple lines

1. On the line that you want to set call forwarding, tap **More**  and then choose **Forward all**.
2. Do one of the following as needed:
 - Tap a history call in **Recents**.
 - Tap a contact in **Directories**.
 - Enter a phone number and tap .
 - Press the Message key  on the phone keypad to forward incoming calls to your voicemail.

All incoming calls will be forwarded to the specified destination.

3. To turn off the call forwarding service, tap **More**  and then choose **Forward off**.

Forward calls (MPP)

Forward calls

To avoid missing calls when you're away from office or your line is busy, set the phone to redirect incoming calls to an alternative phone number.

There are three call forwarding services on phones that are deployed on Webex Calling or Cisco BroadWorks:

- Forward all—Forward all incoming calls to the destination phone number.
- Forward busy—Forward incoming calls to the destination phone number when the line is busy.
- Forward no answer—Forward incoming calls to the destination phone number when the call isn't answered.

The icon  on a line indicates that all incoming calls on this line are redirected to another number. You can see the destination number below the line name.

Single line

1. Locate and tap  from your phone home screen.
2. Tap **Call forward settings** and specify the destination phone numbers:
 - **Forward all to**—Enter the destination number for whenever there's an incoming call.
 - **Forward busy to**—Enter the destination number for when the line is busy.
 - **Forward no answer to**—Enter the destination number for when the call isn't picked up after a specified time period or after a number of rings.
 - You can see one of these two fields depending on your system configuration:
 - **Number of rings**—Specify the number of rings for a no-answer call before call forwarding.

This field is available when your administrator enables either the Feature Key Sync or XSI.

Valid values: 0, or a number from 2 through 20.
 - **Delay for no answer**—Specify the time that a call rings before call forwarding.

This field is available when your administrator disables both the Feature Key Sync and XSI.
3. Tap **Apply** to save the changes.

You are back to the **Call forward** screen.
4. On the **Call forward** screen, choose your preferred option and toggle on call forwarding for it.

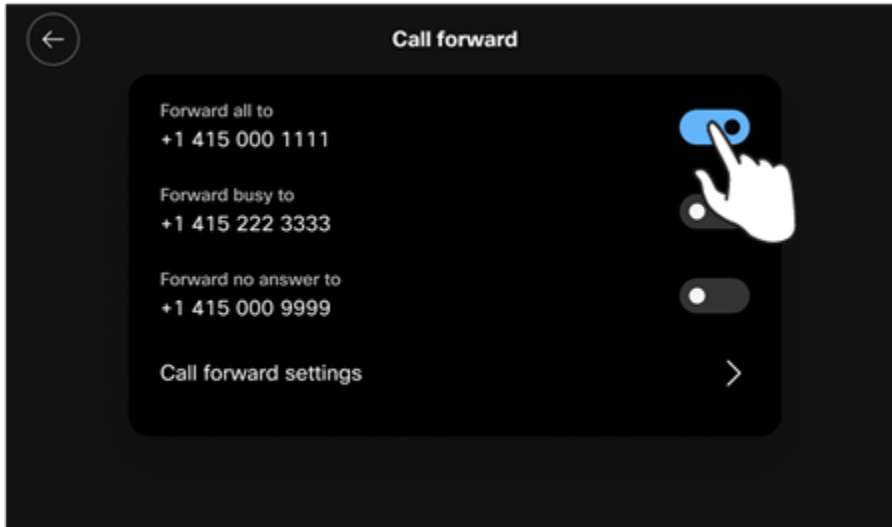

5. Tap the Back button to exit the **Call forward** screen.

Multiple lines

If your administrator has enabled the Feature Key Sync feature or has configured XSI on your lines, you can redirect incoming calls on specific lines to an alternate number. Otherwise, the call forwarding settings apply to all the lines on your phone when you turn on call forwarding on one of the lines.

1. On the line that you want to set call forwarding, tap **More**



and then choose **Call forward**.

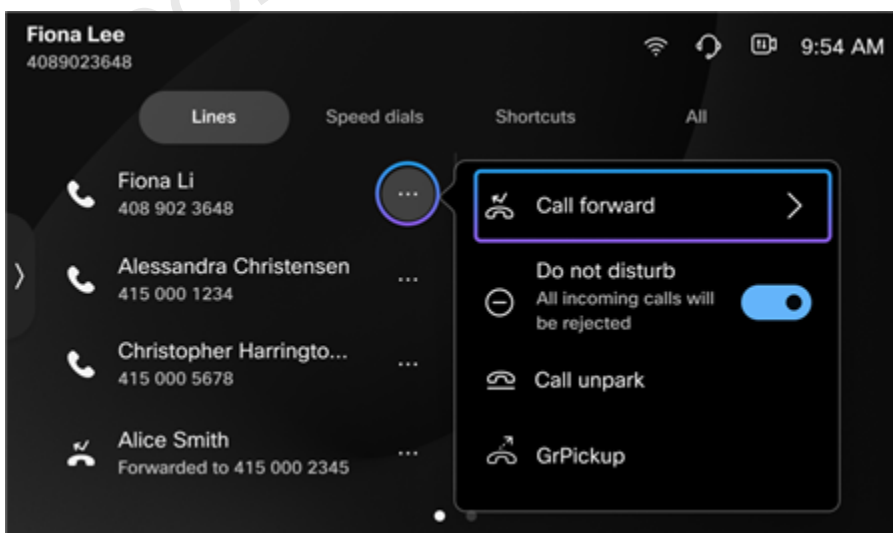

2. Choose **Call forward settings** and specify the destination phone numbers:

- **Forward all to**-Enter the destination number for whenever there's an incoming call.
- **Forward busy to**-Enter the destination number for when the line is busy.
- **Forward no answer to**-Enter the destination number for when the call isn't picked up after a specified time period or after a number of rings.
- You see one of these two fields depending on your system configuration:

- **Number of rings**-Specify the number of rings for a no-answer call before call forwarding.

This field is available when your administrator enables either the Feature Key Sync or XSI.

Valid values: 0, or a number from 2 through 20.

- **Delay for no answer**-Specify the time that a call rings before call forwarding.

This field is available when your administrator disables both the Feature Key Sync and XSI.

3. Tap **Apply** to save the changes.

You are back to the **Call forward** screen.

4. On the **Call forward** screen, choose your preferred option and toggle on call forwarding for it.

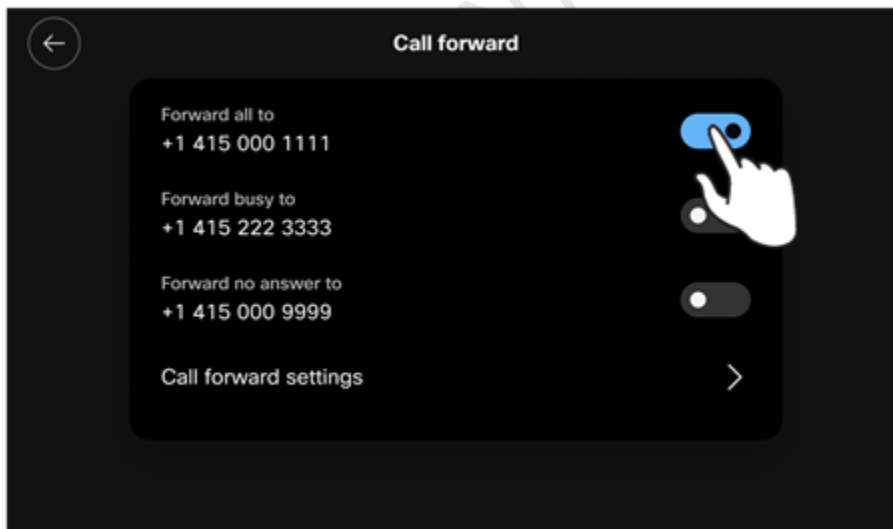

5. Tap the Back button to exit the **Call forward** screen.

Work with a shared line on your phone (MPP)

Work with a shared line on your phone

Your administrator has configured the shared line feature for your phone.

You can share a single phone number with one or more of your coworkers. For example, as an administrative assistant, you might be responsible for screening calls for the person that you support.

When you share a phone number, you can use that phone line just like you would do with any other line, but you should be aware of these special characteristics about shared lines:

- The shared phone number can be configured to appear on a maximum of 35 devices.
- The shared phone number appears on all phones that share the number.
- If your coworker answers the call, the shared line on your phone shows a **Remote active** icon . You can add yourself to the ongoing call.

If your coworker has privacy turned on, you see the **Remote private** icon  and can't barge into the call.

- If your coworker puts a call on hold, the shared line on your phone shows the **Remote on hold** icon . You can resume the call.



You can still hold or resume the call on the shared line even though your coworker enables the privacy feature.



Follow the following steps to work with the shared line.

On a shared line, you can do the following actions:

- Tap **Answer** to answer the incoming call.
- Tap **Decline** to reject the incoming call.
- Tap **Ignore** to silence the incoming call alert.
- Tap **Barge**  to add yourself to a call on a shared line.

If your coworker has privacy turned on, you can't see their call information and can't barge into the call on the shared line.

- Tap **Hold**  to hold an active call.
- Tap **Resume**  to resume a held call.

- Tap **More**  > **Call forward** to forward the calls on this line to other extensions.
- Tap **More**  > **Do not disturb** to turn on or off the DND mode.





Work with a shared line on your phone (Onprem)

Work with a shared line on your video phone

Your administrator has configured the shared line feature for your phone.

You can share a single phone number with one or more of your coworkers. For example, as an administrative assistant, you might be responsible for screening calls for the person that you support.

When you share a phone number, you can use that phone line just like you would do with any other line, but you should be aware of these special characteristics about shared lines:

- The shared phone number appears on all phones that share the number.
- If your coworker makes a call that is on the shared line, the shared line on your phone shows the **Remote active** icon  together with the `Shared - Calling` status.
- If your coworker answers a call or is in a conference call, the shared line on your phone shows the **Remote active** icon  together with the `Shared - Active` status. You can add yourself to the ongoing call.
- If your coworker puts a call on hold, the shared line on your phone shows the **Remote on hold** icon  together with the `Shared - On hold` status. You can resume the call.
- If your coworker enables Privacy, any information about the call on the shared line doesn't display on your phone. The shared line always shows the **Idle** icon .



Note:



According to your administrator's configuration, you might still see the icon  on the shared line although your coworker enables Privacy. In this case, you can resume the call.

Follow the following steps to work with the shared line.

On a shared line, you can do the following actions:

- Tap **Answer** to answer the incoming call.
- Tap **Decline** to reject the incoming call.
- Tap **Ignore** to silence the incoming call alert.
- Tap **Barge**  to add yourself to a call on a shared line.

If your coworker has privacy turned on, you can't see their call information and can't barge into the call on the shared line.

- Tap **Hold**  to hold an active call.
- Tap **Resume**  to resume a held call.
- After you tap **More**  on a shared line, you can do the following actions:
 - Tap **Call forward** to forward the calls on this line to another extension.
 - Tap **Transfer** to transfer the call to another person.
 - Tap **Conference** to create a conference call.
 - Tap **Meet me** to host or join a scheduled conference call.
 - Tap **Record** to start recording of the call.

Enable privacy on a shared line

Your administrator has configured the privacy feature for your phone.

Privacy prevents others who share your line from seeing information about your calls, for example, the call status and call history.

Privacy applies to all shared lines on your phone. If you have multiple shared lines and privacy is enabled, others can't view any of your shared lines.

If the phone that shares your line has privacy enabled, you can still make and receive calls using the shared line as usual.

1. Tap the **Privacy** toggle to enable the feature.

After you enable the privacy feature, the toggle shows as  together with `All lines - Private` status information.

2. Tag the **Privacy** toggle again to disable the feature.

After you disable the privacy feature, the toggle shows as .

Answer a call for your hunt group (Onprem)

Answer a call for your hunt group

You must sign into the hunt group to receive hunt group calls.

Hunt groups allow organizations that receive many incoming calls to share the call load. Your administrator sets up a hunt group with a series of directory numbers. Phones ring based on the hunt sequence that your administrator specifies for a hunt group. If you are a member of a hunt group, you can sign into a hunt group when you want to receive calls. You sign out of the group when you don't want calls to ring on your phone.

Depending on how hunt groups are configured, you may see the following information displayed on your phone screen:

- Caller ID (If configured)
- The line that receives the hunt group call
- The directory number of the hunt group
- The hunt group pilot number.

When a hunt group call rings on your phone, answer the call.



Note:

You can't decline the hunt group call. If you want to silence the ringer, tab **Ignore**.

Sign in and out of a hunt group

Your administrator has configured your hunt group.

Sign into your hunt group to receive calls to the hunt group.

When you are not available to take calls, sign out of your hunt group to stop receiving calls from it. You can still receive calls placed directly to you.

The hunt group setting applies to all lines.

Do one of the following actions that is applicable to your phone settings:

- Tap **Hunt group in**  to sign into the hunt group.

Tap **Hunt group out**  to sign out of the hunt group.

- Tap the **Hunt group** toggle to sign in or out of the hunt group.



After you sign in the hunt group, the toggle shows as  together with `All lines` status information.

After you sign out of the hunt group, the toggle shows as .

View the call queue in a hunt group

You can use the queue statistics to check the status of the hunt group queue. The queue status display provides the following information:

- The phone number used by the hunt group
- Number of queued callers on each hunt group queue
- Longest waiting time

1. Tap **Queue status** .
2. Tap **Update** to refresh the statistics.
3. Tap  to exit the screen.

Pick up calls for your coworkers (MPP)

Pick up calls for your coworkers

If your administrator has made you a member of a pickup group, you can answer calls for your group members when they are busy or absent.



How you can pick up calls for your coworkers depends on your phone configuration. Follow the directions that fit your use case in the following sections.

Pick up calls for coworkers in your group

Your administrator has assigned you to a call pickup group.

You can answer calls for any of your group members. If there're multiple calls queuing in the group, using any of the following methods answers the call that came in first.

Do one of the following actions to answer a call for someone in your pickup group:





- On a phone with a single line, tap **GrPickup**  .
- On a phone with multiple lines configured, tap  > **GrPickup**.
- On your phone, dial *98.

Pick up calls for a specific coworker

Your administrator has assigned you to a call pickup group.

You can answer calls for specific coworkers either within or out of your pickup group. You must know the coworkers' extension numbers before you answer calls for them.

Do one of the following actions to answer a call for someone:

- On a phone with a single line, tap **Pickup**  , enter the extension number, and tap  .
- On a phone with multiple lines configured, tap  > **Pickup** on the line that you want to use, enter the extension number, and tap  .
- On your phone, dial *97 + extension number, where the extension number is your coworker's extension.

Monitor and answer calls for your coworkers (BLF with Call Pickup)



Your administrator has assigned you to a call pickup group and configured the Busy Lamp Field (BLF) feature on your phone.

The BLF feature provides you a visual indicator on the status of the monitored line. By using BLF, you can quickly determine whether a colleague is available or on a call.

If your administrator has configured BLF with the Call Pickup feature, you're able to answer incoming calls for the monitored line.

The following table shows the status indicators on the monitoring line. If configured with both Call Pickup and Speed Dial, the status indicators on the monitoring line change. For information about BLF with speed dial, see [Use speed dials on your phone](#).

Table 7. Status on the monitoring line

Icon	Status
	The line is configured with call pickup and in idle mode.
 Alerting, or Alerting · Pickup enabled	There's an incoming call waiting for pickup. You can answer the call only when you see the Alerting · Pickup enabled status on the monitoring line.
 In use	The monitored line is in use.

When an incoming call alerts on the monitoring line, tap the line to answer the call for your coworker.

Answer calls for your coworkers (Onprem)

Answer a call for your coworkers within your group (Pickup)

Your administrator has assigned you to a call pickup group.

You can answer a call that rings on another phone within your call pickup group. If multiple calls are available for pickup, you'll answer the call that has been ringing for the longest time.

1. When you receive the notification on your phone, do one the following actions that's applicable to your phone settings:

- **Single line**

Tap **Pickup**  .

- **Multiple lines**

On the line that you want to use, tap  > **Pickup**.

2. Tap **Answer** when the call rings on your phone.

Answer a call for another group (Group pickup)

Your administrator has assigned you to at least one call pickup group.

Group pickup allows you to answer a call to a phone outside your designated call pickup group. You can redirect the call to your own phone using the group pickup number or the number of the phone line that is ringing. This is helpful if you're responsible for answering calls for multiple groups.

1. When you receive the notification on your phone, do one the following actions that's applicable to your phone settings:

- **Single line**

Tap **GrPickup** .

- **Multiple lines**

On the line that you want to use, tap  > **GrPickup**.

- **Feature shortcut**

Tap the **GrPickup** shortcut if available on your phone.

2. Enter the number of the other call pickup group or the directory number of the phone line that is ringing.
3. Tap **Answer** when the call rings on your phone.

Answer a call for an associated group (Other pickup)

Your administrator has assigned you to at least one call pickup group.

If your administrator has associated your call pickup group with another, you can redirect a call that rings on a phone from that group to your own phone. If you are responsible for answering the calls for that group, use the Other pickup feature to answer the call.

1. To answer a ringing call for an associated group, do one the following actions that's applicable to your phone settings:

- **Single line**

Tap **Other pickup**



- **Multiple lines**

On the line that you want to use, tap  **> Other pickup**.

- **Feature shortcut**

Tap the **Other pickup** shortcut if available on your phone.

2. Tap **Answer** when the call rings on your phone.

Use BLF with speed dial and call pickup

Your administrator has configured the Busy Lamp Field (BLF) feature with speed dial on your phone.

Compared to the speed-dial buttons found on your phone's Speed Dials tab, BLF shortcuts with speed dial not only allow you to quickly dial the number but also enable you to monitor the status of your coworker's line. If the shortcut is also configured with the Call Pickup feature, you're able to answer calls for your coworkers when they're unavailable.

The following table lists the status indicators for BLF with speed dial.

Table 8. Status indicators for BLF with speed dial







Icon	Status	Description
	Idle	The monitored line is in idle mode. You can tap the shortcut to call the speed dial number.
	Alerting or Alerting · Pickup enabled	A call is alerting on the monitored line. If the Call Pickup feature is enabled for the BLF shortcut, you will see Alerting · Pickup enabled and you can answer the call for your coworker by tapping the BLF shortcut. Otherwise, tapping the shortcut initiates a call to the monitored line.

Table 8. Status indicators for BLF with speed dial (continued)

Icon	Status	Description
		 Note: If there's an active call on your phone that registers to Cisco Unified Communication Manager, end the active call before you can initiate or answer a call with the BLF shortcut.
	In use	The monitored line is on a call. If you tap the shortcut, a call is placed to the speed dial number. You'll hear a busy tone or be redirected to the voicemail depending on the configuration on your coworker's line.
	DND	The monitored line is set to Do Not Disturb (DND). The calls to the line don't alert.
	Unregistered	The monitored line isn't registered. The calls to the line don't get connected.

1. On your phone Home screen, tap **Expand**  to enter the full screen mode.
2. Go to the **Shortcuts** tab and do one of the following actions as needed:
 - View the status of the monitored lines.
 - Tap a BLF shortcut to call the associated extension.
 - Tap a BLF shortcut with the **Alerting · Pickup enabled** status to answer the call.

**Note:**

If there's an active call on your phone that registers to Cisco Unified Communication Manager, end the active call before you can initiate or answer a call with the BLF shortcut.

Silence incoming call ringer

Silencing the ringer doesn't reject calls. If you've configured the line to redirect no-answer calls to your voicemail, you can check the voice messages in the Recents list later.

Do one of the following actions when you have an incoming call:

- Tap **Ignore** on the phone screen.

Then the incoming call that you ignored displays together with the animate icon  on the phone home screen.

If your line receives multiple incoming calls, tap **Ignore all** to silence the ringer for all the incoming calls.



Note:

The ring volume returns to normal with the next call.

- Press - (volume down) on .

The ring volume doesn't return to normal with the next call. You must manually volume up the ringer.

Related information

Check voice messages on your phone

[Answer a call](#)

Use Do Not Disturb (DND) (Onprem)

Use Do Not Disturb (DND)

DND silences your phone and rejects incoming calls. If configured, your phone directs incoming calls to your voicemail.

However, you will always receive paging, intercom, and emergency calls, even when DND is turned on.



Single line

When your phone is in DND mode, you can see a red bar and the DND icon  in the header.

Your administrator configures the soft buttons that display on your phone screen. If you don't see **DND**





on your phone, contact your administrator.

1. Tap **DND**  to turn on DND.
2. To turn off DND, tap **DND off** .

Multiple lines

On a phone with multiple lines configured, the DND setting applies to all the lines. When DND is on, you can see a red bar and the DND icon  in the screen header.

If your administrator has configured the **Do not disturb** shortcut, you can see the toggle in the **Shortcuts** tab or in between the configured lines.

1. Do one of the following actions:
 - Tap the **DND** soft button .
 - Tap the **Do not disturb** toggle if available.
2. To turn off DND, tap **DND off**  or toggle off DND with the **Do not disturb** toggle, if configured.

Use Do Not Disturb (DND) (MPP)

Use Do Not Disturb (DND)

DND silences your phone and rejects incoming calls. If configured, your phone directs incoming calls to your voicemail.

However, you will always receive paging, intercom, and emergency calls, even when DND is turned on.

Single line

When your phone is in DND mode, you can see a red bar and the DND icon  in the header.

Your administrator configures the soft buttons that display on your phone screen. If you don't see **DND**



on your phone, contact your administrator.

1. Tap **DND**  to turn on DND.

2. To turn off DND, tap **DND off** .

Multiple lines

On a phone with multiple lines configured, you can turn on DND for specific lines or for all the lines depending on the configuration of Feature Key Sync and XSI on your phone.





Note:

On a line with either Feature Key Sync or XSI enabled, the DND setting applies to this line only.

If a line has both Feature Key Sync and XSI disabled, the DND setting on this line applies to all the lines on the phone that have both Feature Key Sync and XSI disabled.

When all the lines are in DND mode, you can see a red bar and the DND icon  in the screen header. When a specific line is in DND mode, you can see the DND icon on the line.

1. Tap **More**  on the line and then toggle on **Do not disturb**.

2. To turn off DND, tap **More**  on the line and then toggle off **Do not disturb**.



Check voice messages on your phone (Both)

Single line

Your administrator has configured the voicemail account for you and set up your phone to access the voicemail system.

When you have unread voice messages on your phone, you can see the following indicators on the phone:

- The strip LED on the phone handset lights up if your administrator has configured the handset LED indicator.
- A digit appears on the **Recents** button . It appears also when there are new missed calls on the phone.

- In the Recents list, the voice message icon  or the urgent voice message icon  appears . The digit on the icons show the number of the unread messages.



Note:

The urgent voice messages are unavailable on the phone that is deployed on the Cisco Unified Communications Manager (Unified CM).

To access your voice messages, press **Messages**  on the phone or use the touchscreen by following these steps:

1. On the phone home screen, tap **Recents**  to open the Recents list.

The digit on **Recents**  shows the total number of missed calls and unread voice messages.

2. Tap  or .



Your phone starts dialing the voicemail number.



3. Follow the voice instructions to access your messages.

Multiple lines

Your administrator has configured the voicemail account for you and set up your phone to access the voicemail system.



When you have unread voice messages on your phone, you can see the following indicators on the phone:

- The strip LED on the phone handset lights up if your administrator has configured the handset LED indicator.
- A blue dot appears next to the **Expand** button . It appears also when there are new missed calls on the phone.
- A digit appears on the **Recents** button . It appears also when there are new missed calls on the phone.

- In the Lines list, you can also see the voice message icon  or the urgent voice message icon  on the respective lines.

**Note:**

The urgent voice messages are unavailable on the phone that is deployed on the Cisco Unified Communications Manager.

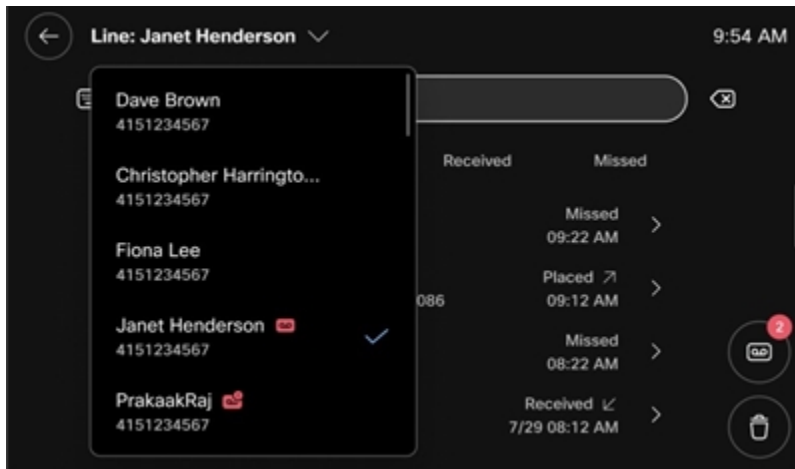

- The voice message icon  or the urgent voice message icon  appears in the Recents list. The digit on the icon shows the number of the unread messages, for example:





The example shows that there are two unread voice messages on the specific line.

1. On the phone home screen, tap **Recents**  to open the Recents list.

The digit on **Recents**  shows the total number of missed calls and unread voice messages.

The icon next to the current line name shows the missed calls  or unread voice messages , or both  on the phone (including all lines).

2. (Optional) If you want to check the voice messages on another line, tap the **Expand** button  next to the current line name, and choose your line from the Lines list.
3. Do one of the following actions to access your voicemail box.

◦ In the Recents list, tap  or .

◦ Press **Messages**  on your phone.

Your phone starts dialing the voicemail number.

4. Follow the voice instructions to listen to your messages.

CONFIDENTIAL DRAFT



Chapter 4. Meeting and conference

Join a scheduled Webex meeting with your phone (MPP)

Join a calendar meeting with your phone

You're prompted to join a meeting 5 minutes before it starts. If you choose snooze the reminder, you're prompted again 5 minutes later. If you ignore the notification, you can still find and join the meeting from the **Meetings** list, which shows you the scheduled meetings for the day.

Depending on the meeting configuration by the host, you may be prompted for the PIN code when joining a meeting. Usually, the PIN code is included in the invite. If you don't have the meeting PIN, ask your meeting host for it.

When the meeting is being recorded, you can see the recording indicator at the top of screen. The icon  indicates that the meeting is being recorded. The icon  means that the recording is paused.



Note:

Before using your phone for meetings, keep the following points in mind:

- You can only join one meeting at a time. To join another meeting, leave the ongoing one first.
- If you want to handle a call during a meeting, such as answering a call, placing a call, handling call park or call pickup, you will be prompted to leave the meeting first.
- If you want to check your voicemail during a meeting, you will be prompted to leave the meeting first.
- During a meeting, the following softkeys and hardkeys are disabled:
 - Conference
 - Hold/Resume
 - Transfer

1. To join a meeting, tap **Join** from the meeting notification when prompted.

You can also join an ongoing meeting from the **Meetings** list. From your phone home screen, tap

Meetings  and then **Join**. The digit on the **Meetings** button shows the number of meetings you have for the rest of the day.

2. If prompted, choose your role as host or guest and enter the meeting password.

3. To view the participant list, tap **Participant** .

The participant list shows the participants with their roles and the audio and video status. The invitees that are not present are listed in the lower part of the list.

4. (Optional) To leave the meeting, tap .

Scheduled conference calls (Meet me) (Onprem)

You can use your phone to host or join a conference call with a Meet-me conference number.

The conference call doesn't start until the host dials in, and it ends when all participants hang up. The conference doesn't automatically end when the host hangs up.

Host a Meet-me conference

Get a Meet-me conference number from your administrator, and distribute the number to the conference participants.

1. Do one of the following actions:

◦ **Single line:** Tap **Meet me** .

◦ **Multiple lines:** On the line that you want to use for the conference, tap **More**  and then choose **Meet me**.

2. Dial the Meet-me conference number.

3. **Optional:** If you want to remove participants from the conference call, see *View and manage participants*.

Join a Meet-me conference

You can't join a Meet-me conference until the conference hosts dials in. If you hear a busy tone, the host hasn't dialed into the conference. Hang up and try your call again.

Dial the Meet-me phone number that the conference host provides.



Use your phone for an ad-hoc conference (MPP)

When you're on a phone call, you can pull someone else into the conversation without having to schedule a meeting. When someone finishes their part, you can remove them from the conference.

By default, if the host drops the call, the conference ends for all participants. However, if your administrator has configured the call, it is possible for a 3-way conference to continue as a 2-way call when the host leaves.

Add more people to a call

You can invite additional participants to join your ongoing call and hold an ad-hoc conference. By default, the conference call can accommodate up to six people, including yourself as the host. If you need to increase the capacity, consult your administrator.

1. While you are on a call, tap **More**  and choose **Conference** .
2. In the **Recents** or **Directories** tab, tap the contact that you want to add.
3. **Optional:** If you want to search for a contact, follow these steps:
 - a. In the **Recents** or **Directories** tab, tap the search bar and enter the contact's phone number.
 - b. Tap the contact that you want to add from the search results.
Your phone tries to call the selected contact.



Note:

You can also add a contact to the conference call by entering a complete URI address of the contact. However, the phone doesn't support searching for a contact by URI address.

4. Tap **Conference**  to add the person to the call.
5. Repeat Step 1 through Step 4 to add more people.

View and manage participants

When on a conference call, you can view the participant list. If you have added someone else to the call, you can see the **Remove** button on the participant list. You can only remove the participants that you have added.

If you don't see the Participants button in a conference, consult your administrator.

1. When in a conference call, tap **More**  and choose **Participants**.
The participant list displays.
2. Tap **Remove** on the participant that you've added to remove.
3. Tap **Remove** on the prompt to confirm the removal.

Manage audio for calls and meetings (Both)

Mute yourself during a call

On a call or in a meeting, mute the audio while not speaking to avoid distractions to the other participants. When your phone is on mute, you can hear the others, but they can't hear you.

1. Press  on your phone.
The Mute key LED turns into red.
2. Press the Mute key again to unmute yourself when you're ready to speak.

Mute or unmute yourself during a meeting





Note:

The following steps apply to phones registered to Webex Calling.

Your audio status upon joining depends on your Webex settings or the meeting settings set by the host. In some meetings, the host may mute all the participants to encourage active listening or reduce background noise. If the host disallows participants from unmuting themselves, you'll see a lock on the

Unmute button . When the host requests that you unmute yourself, you can choose to unmute or remain muted when prompted.

If you have a Cisco headset connected to the phone, you can also use the Mute button on the headset to mute and unmute yourself.

1. To mute your audio, press the Mute key , or tap **Mute**  on the touchscreen.
The Mute key LED turns into red.
2. To unmute your audio, press the Mute key again, or tap **Unmute**  on the touchscreen.

Adjust audio volume

Adjust your phone volume to make sure you hear the participants clearly.

If the sound on your phone is too loud or too soft, you can change the volume when you're on a call or on a meeting.

The volume change applies to the currently active audio path, which can be the phone handset, the phone speaker, or your headset. You can check the screen header bar to know the active audio path.

See the following table for the audio path status.

**Table 9. Audio path status
displayed on the screen header**











Icon	Active audio path	Status
	Phone handset	Active
	Phone handset	Silenced
	Phone speaker	Active
	Phone speaker	Silenced
	Bluetooth head- set	Active
	Bluetooth head- set	Silenced
	USB headset	Active

Table 9. Audio path status displayed on the screen header (continued)

Icon	Active audio path	Status
	USB headset	Silenced
	Analog headset	Active
	Analog headset	Silenced

Do one of the following actions:

- Press - or + on .
- Use the volume buttons on your Cisco Headset.



Note:

Only Cisco Headsets are supported to control the phone audio volume.

Switch the phone audio path

The phone speaker and microphone are the default audio output and input path. You can switch the audio path to the handset or to a connected headset.

You can connect an analog headset, a Bluetooth headset, and a USB headset simultaneously to your phone. However, you can use only one headset at a time. The last connected headset is used as the active headset.

On header bar at the top of the screen, the audio path icon shows the audio device in use. You may see one of the following icons:

-  Handset
-  Speaker
-  USB headset
-  Analog headset (RJ-9 or AUX)
-  Bluetooth headset

Do any of these actions to switch the audio path:

- On the header bar, tap the audio path icon and select your desired audio path.

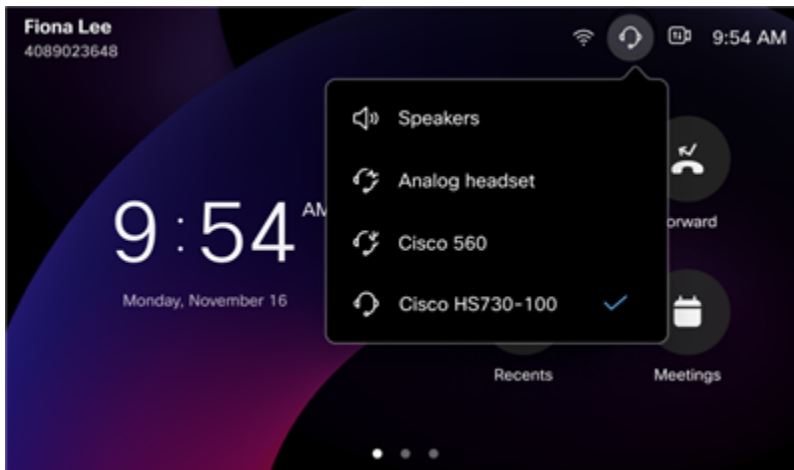

Note:

You can't switch the audio to the handset on the phone screen.

- Use the hard keys:



: Press this key to switch the audio to the phone speakers.



: Press this key to switch the audio to the connected headset. If you have more than one headsets connected, the audio switches to the one that you used last time.

- Pick up the handset to switch the audio to the handset.

Chapter 5. Contacts and call history (MPP)

Contacts (Onprem)

Contacts

Contacts are the collection of friends, colleagues, and customers that make up your personal and business world. It's an easy way for you to reach out and call someone without having to find their contact information.

Contacts are organized into corporate and personal directories. The corporate directory is a list of people in your company and can only be edited by your administrator. The personal directory is a list of your personal contacts that you can add, edit, or delete.

You can also search for someone in your directories, and mark them as a favorite if they're special.

Search for a contact

Contacts are organized into the corporate directory. The corporate directory is a list of people in your company and can only be edited by your administrator.

To locate a contact quickly, you can search for a contact in the Corporate directory by a contact name.

Enter more characters to narrow down the results if you're prompted to do so. Too many results make it difficult for you to locate your desired contact.

1. Press **Contacts**  to display your contacts list.
2. Tap the search bar and enter the contact name.



Note:

By default, the maximum number of the search results is 64. If you want to change the maximum number, consult your administrator.

3. Drag the scroll bar up or down to find your desired contact in the search results.
4. **Optional:** If you want to make a call to the contact, do one of the following actions:

- Tap the contact to directly make a call.

Your phone dials the first contact number of the first contact from the search results automatically.

- Tap  on the contact to access the call details screen, tap **Call**, and then tap your desired number from the pop-up menu to make a call.

5. **Optional:** If you want to make a call to the contact, do the following actions:

- Tap the contact that you want to call.
- Tap **Call**.

If the contact has only one number, your phone directly dials the number.

If the contact has more than one number, the contact numbers display in the pop-up menu.

- Tap one of the listed numbers to make a call.

Use the personal directory on your phone (Onprem)

Use the personal directory to store the contact information for friends, family, or coworkers. You can add your own contacts to the personal directory. For the contacts that you often call, assign them a fast dial for quick access.

You can manage your personal directory from your phone or from the Self Care portal. Use your phone to assign speed-dial codes to the directory entries.

Sign in and out of your personal directory

You need your user ID and PIN to sign in to your personal directory. Contact your administrator if you don't know this information.



- Press **Contacts** .
- Tap **Customized directory > Personal directory**.
- Enter your user ID and PIN code, then tap **Submit**.

After logging in, you will see a menu with options including **Personal Address Book**, **Personal Fast Dials**, **Log Out**.

- To log out of your personal directory, tap **Log Out**.

Add a contact to your personal directory

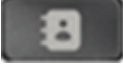
[Sign in to your personal directory on the phone.](#)

1. Press **Contacts** .
2. Navigate to **Customized directory > Personal directory > Personal Address Book**.
3. Tap **Submit**.
4. To add a contact, tap **More**  **> New** or tap **New**, depending on the user interface that you see.
5. Enter the names and email address of the contact.
Nickname is mandatory information and will be the display name in your personal directory. You can optionally enter the first name, last name, and email address of the contact.
6. Tap **Phones** to enter the phone numbers.
7. Tap **Submit** to add the contact information.

Search for a contact in your personal directory

[Sign in to your personal directory on the phone.](#)

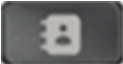
1. Press **Contacts** .
2. Navigate to **Customized directory > Personal directory > Personal Address Book**.
3. Enter the contact name and tap **Submit**.
If you tap **Submit** without entering search criteria, the list of your personal contacts will open. You can scroll through the list by swiping your finger up and down on the screen to scroll the list. To navigate between pages, use the **Next** and **Previous** buttons.

Call a contact in your personal directory

[Sign in to your personal directory on the phone.](#)

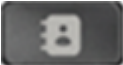
1. Press **Contacts** .
2. Navigate to **Customized directory > Personal directory > Personal Address Book**.
3. [Search for the contact by name.](#)
4. Tap the contact that you want to call.
5. Tap **Dial** on the phone number and tap **OK** to dial out.

Update contact information in your personal directory

[Sign in to your personal directory on the phone.](#)

Keep your personal directory up to date so that you can conveniently access your frequently contacted individuals. You can manage the personal directory either on the phone or [on Cisco Unified Communications Self Care Portal](#).

Follow these steps to update your directory on the phone.

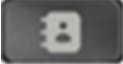

1. Press **Contacts** .
2. Navigate to **Customized directory > Personal directory > Personal Address Book**.
3. [Search for the contact by name](#).
4. Tap the contact entry to open the contact details.
5. Tap **Edit** and change the contact information.
6. Tap **Update** to save the changes.

Remove a contact from your personal directory

[Sign in to your personal directory on the phone.](#)

You can remove contacts from the personal directory either on the phone or [on Cisco Unified Communications Self Care Portal](#).

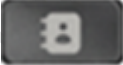
Follow these steps to remove contacts from your personal directory on the phone.

1. Press **Contacts** .
2. Navigate to **Customized directory > Personal directory > Personal Address Book**.
3. [Search for the contact by name](#).
4. Tap the contact entry to open the contact details.
5. Tap **Edit > More**  **> Delete**.
6. Tap **OK** to confirm the deletion.



Add a contact to fast dial

[Sign in to your personal directory on the phone.](#)

Fast dial allows you to place a call to a contact with a single tap. You can add the frequently called contacts in your personal directory to fast dial.

Fast-dial contacts are displayed with the phone number type followed by the contact's name or nickname. For example, H-Alice Alexandra. The following prefix may appear in your fast dial list:

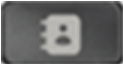
- **W:** Work phone number
- **H:** Home phone number
- **M:** Mobile phone number

1. Press **Contacts** .
2. Navigate to **Customized directory > Personal directory > Personal Address Book**.
3. [Search for the contact by name](#).
4. Tap the contact entry to open the contact details.
5. Tap **More**  **> FastDial**.
6. Tap the desired phone number to add it to the fast dial list.
7. Tap **Exit** to close the window.

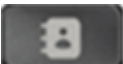

Call a contact with fast dial

[Add a contact to fast dial](#).

1. Press **Contacts** .
2. Navigate to **Customized directory > Personal directory > Personal Fast Dials**.
3. Find the contact that you want to call by scrolling up and down the list. Use the **Next** and **Previous** buttons to navigate through pages.
4. Tap the fast dial entry to place a call.

Remove a fast dial entry

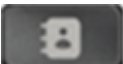

To maintain a shorter fast dial list, delete any fast dial entries that are no longer in use.

1. Press **Contacts** .
2. Navigate to **Customized directory > Personal directory > Personal Fast Dials**.
3. Tap **More**  **> Remove**.
4. Find the fast dial entry that you want to remove by scrolling up and down the list.
5. Tap **Remove** on the entry.
6. Tap **Exit** to close the window.

Manage your contacts on Self Care Portal

Get the URL for Self Care Portal from your administrator.

On Cisco Unified Communications Self Care Portal, you can add, remove, and edit contacts in your personal directory. To manage fast dials for personal contacts, go the directory menu on the phone.

1. Log in to Self Care Portal with your credentials.
2. Choose **Phone Settings > Phone Contacts**.
3. Do the following actions as needed:
 - To add a contact, click **Create New Contact**, enter the contact information, and click **Save**.
 - To update contact information, click  on the contact entry. Save the changes when finish editing.
 - To remove a contact from the directory, click  on the contact entry.

Contacts (MPP)

Search for a contact

To locate a contact quickly, search for it in the directories. You can search for a contact in your personal address book, XSI directory, or LDAP directory by either contact name or phone number. For the contacts from Webex server, you can search only by the contact name.

Enter more characters to narrow down the results if you're prompted to do so. Too many results make it difficult for you to locate your desired contact. The phone doesn't show all the results if the number of found contacts reaches the maximum limit. Your administrator configures the limit.

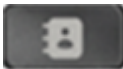
1. Press .
2. Tap the search bar and enter the contact name or the phone number.







Note:

The search starts after you enter three characters on the search bar.

3. Drag the scroll bar up or down to find your desired contact in the search results.

Add a contact to Favorites



Make it easy to connect with the people that you often contact. You can add the contacts from your personal address book and corporate directories to Favorites.

1. Press .
2. Find the contact that you want to add from your personal or corporate directories.
3. Tap  to open the contact card.
4. Tap  to add the contact to favorites.
5. To remove the contact from Favorites, tap .

Add a contact in a corporate directory to your personal directory

If you have someone who you call often, you can add them to your personal address book.

You can add up to three phone numbers for each contact.

1. Press  and select **Directories**.
2. Tap .
3. Enter the contact name and phone numbers with the onscreen soft keyboard.
4. Tap  to save the contact.



Edit a contact



Sometimes, your contacts change their phone numbers or have alternate phone numbers. Edit the contacts in your personal address book or in Favorites to keep the information updated.



Note:

You can't edit the contacts from the corporate directories. Adding the contacts to Favorites enables you to edit the contact names but not the phone numbers. When you remove the contact from Favorites, the contact name reverts to the original.

1. Press .
2. Find the contact that you want to update from your personal address book or from Favorites.
3. Tap  to open the contact card.



4. Tap  and update the information.
5. Tap  to save your changes.

Add a contact to your personal directory



If you have someone who you call often, you can add them to your personal address book. For example, you have some customers and you need to call them often. Saving their numbers to your personal directory allows you to easily call them or identify the incoming or missed calls from them.

You can add up to three phone numbers for each contact.

Add a contact from Recents

1. Open the Recents list.
2. Locate the phone number that you want to add.
3. Tap  to open the call details.
4. Tap  and enter the contact name.
5. Tap  to save the contact.

Add a contact using the keypad

1. On the phone home screen, enter the phone number with the phone keypad.
2. Tap  below the search bar.
3. Enter the contact name.
4. Tap  to save the contact.

Use and manage the call history on your phone (Onprem)

Call history on your phone

Use the Recents list to retrieve your recent calls and check your voice messages. The Recents list contains the calls that you placed, received, missed on the phone.

You can access the Recents list by tapping **Recents**  on the phone home screen. If you have missed calls or unread voice messages, a digit on the button shows the total number of them. After you access

the Recents lists on a specific line, you can see the number of the unread voice messages, for example,



urgent voice message icon



The calls are sorted into the following types:

- **All:** Lists all the recent calls.
- **Placed:** Lists the outgoing calls that you placed.
- **Received:** Lists the incoming calls that you answered.
- **Missed:** Lists the missed calls

The **All** Recents list can store a maximum number of 180 calls. The **Placed, Received, Missed** Recents list can store a maximum number of 60 calls respectively. If a Recents list reaches the maximum size, the next new entry overwrites the oldest entry in the list.

If you have recent calls for your hunt group, then the **All** Recents list includes the term `Hunt group` followed by the hunt group number or name. Therefore, you can quickly identify the hunt group calls from recent calls.

View your call history

Use the Recents list to view your call history. The call details include the following information:

- Contact information of a call
 - If the contact is from a hunt group, the hunt group number displays.
- Date and time that a call was placed, received, or missed

For the current day, only time displays. For a previous day, both date and time display.

- All history calls and call duration with a contact



Note:



If you have multiple lines configured on your phone, you can switch to a particular line and see the call history for the line.

1. On the phone home screen, tap **Recents**  to display call history of the primary line.

A digit displays on the **Recents** button if you have missed calls or voice messages, or both on the phone. The digit shows the total number of the missed calls and voice messages.



2. (For multiple lines) View the call history of a specific line:

By default, your phone displays the call history for the primary line. One of the following icons displays next to the current line name if the phone has missed calls or unread voice messages, or both:

-  : Missed calls
-  : Unread voice messages
-  : Missed calls and unread voice messages

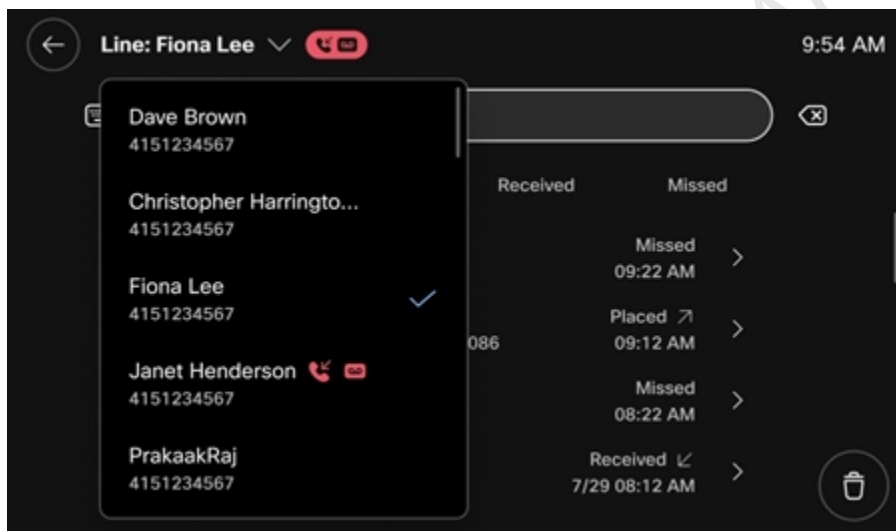
a. Tap the expand icon next to the line to display the Lines list.





In the Lines list, you can find the target lines that have missed calls icon  or unread voice messages icon .

unread urgent voice messages 



Note:

The missed calls icon  disappears after you view the Recents list.

The icon  next to the line changes to  after you view the missed calls.

- b. Choose a line by tapping it from the Lines list.
3. Tap the **All**, **Placed**, **Received**, or **Missed** tab to view the respective call list.

The contacts of missed calls are highlighted in red.

4. View the details of a particular call:
 - a. Tap  on the call entry to access the call details screen.

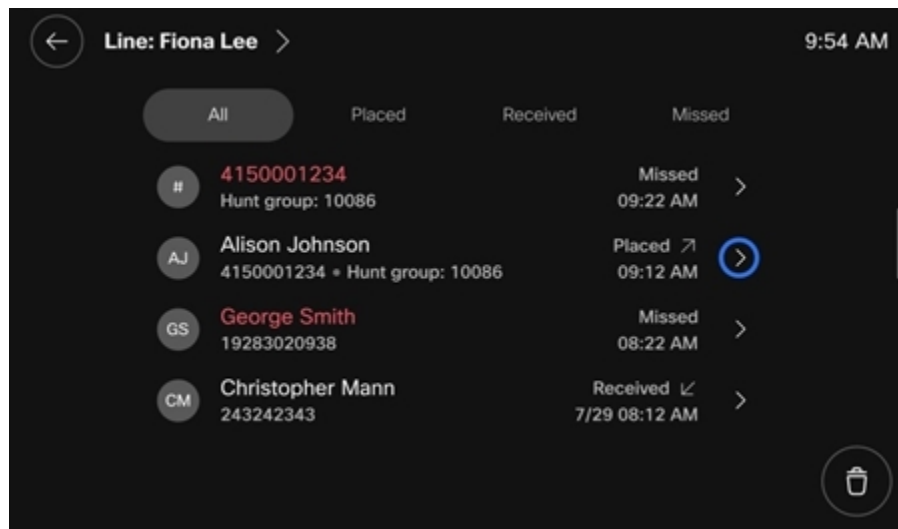

- b. In the call details screen, you can choose to call the contact, edit the dial number, or delete the recent call.

Make a call from call history

Use the Recents list to quickly return or repeat a recent call without looking for the contact in your directories.



1. On the phone home screen, tap **Recents**  to open the Recents list.



The digit on the icon shows the total number of missed calls and unread voice messages on the phone.

By default, your phone displays the call history for the primary line.

2. (For multiple lines) View the call history of a specific line:

- a. Tap  next to the line to open the Lines list.

If you have missed calls on the phone, an icon  or  displays next to the line.

- b. Choose a line by tapping it from the Lines list.
3. Locate a call entry by scrolling down the Recents list.
4. Tap the call entry to directly make a call.
5. **Optional:** If you want to modify the dial number before you make a call, do the following:
 - a. Tap  for the call entry to show the call history details.
 - b. Tap **Edit dial**.
 - c. Enter the dial number based on the existing number.
 - d. Tap  to dial the number.

Redial a number

You can call the most recently dialed number.

On the phone home screen, tap **Redial** . Your phone dials the most recent number automatically from a line that just placed a call.





Note:

You can swap on the screen to locate the **Redial** button.

Delete call history of a contact

Your recent calls are sorted into Placed, Received, and Missed calls in the Recents list. If you don't want any particular recent call to display in the list, you can delete it.

1. On the phone home screen, tap **Recents**  to open the Recents list.

By default, your phone displays the call history for the primary line.
2. (For multiple lines) View the call history of a specific line:
 - a. Tap  next to the line to open the Lines list.
 - b. Choose a line by tapping it from the Lines list.
3. Locate the call entry that you want to delete.

You can look for the record by scrolling down the Recents list.

- On the call entry, tap  to open the call history details.

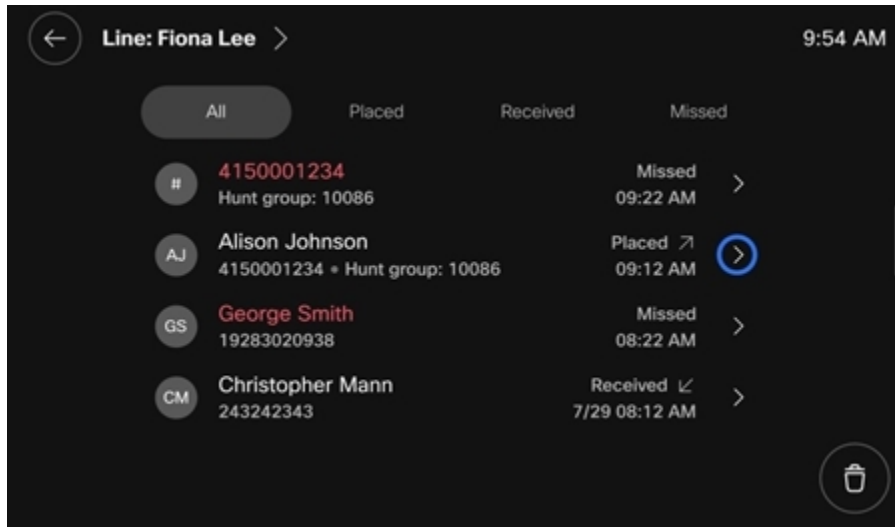

- Tap .
- Tap **Delete** to delete call history of the contact.

Delete entire call history

You can delete the entire call history for a particular line.

- On the phone home screen, tap **Recents**  to open the Recents list.

By default, your phone displays the call history for the primary line.

- (For multiple lines) View the call history of a specific line:
 - Tap  next to the line to open the Lines list.
 - Choose a line by tapping it from the Lines list.
- Optional:** View the call history from the Recents lists:
 - All:** (Default) Open this tab if you want to view all calls on the line.
 - Placed:** Open this tab if you want to view all placed calls on the line.
 - Received:** Open this tab if you want to view all answered calls on the line.
 - Missed:** Open this tab if you want to view all missed calls on the line.

4. Tap .
5. Tap **Delete** on the prompt to delete all recents for the line.

Use and manage the call history on your phone (MPP)

View your recent calls

Use the Recents list to view your call history. The call details include the following information:

- Contact information of a call
- Time that a call was placed or received
- Call duration
- All the history calls with a contact

If you have multiple lines configured on your phone, you can switch to a particular line and see the call history for the line.

1. On the phone home screen, tap  **Recents**.
2. (For multiple lines) To view the call history for a specific line, choose the line from the Lines list.

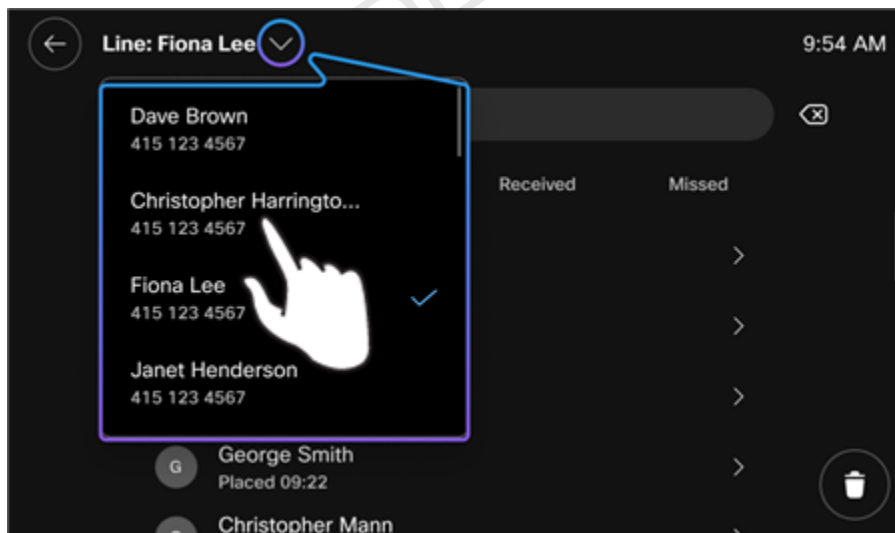

Note:

If you don't choose a line, the **Recents** list shows the call history for the primary line.

3. Tap the **Placed**, **Received**, or **Missed** tab to view the respective call list.
4. To view the details of a particular call, tap  on the call entry.

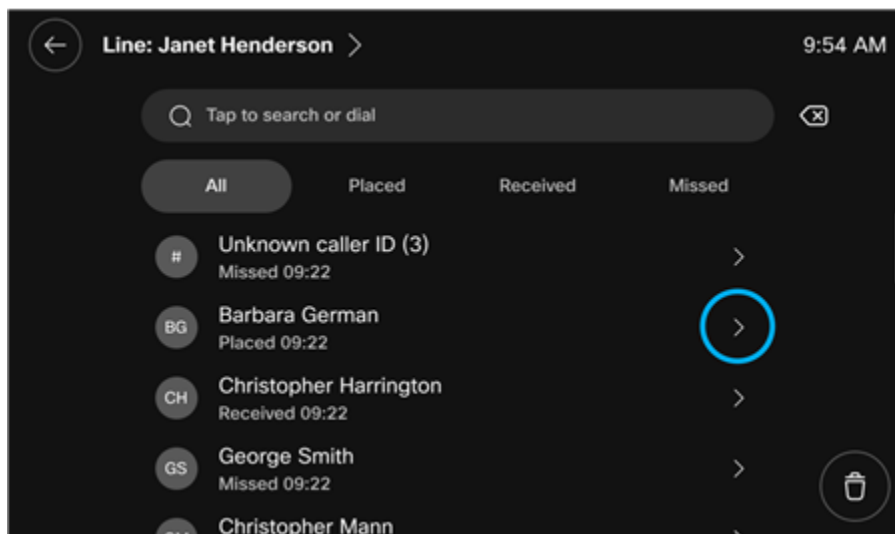

Make a call from call history

Use the Recents list to quickly return or repeat a recent call without looking for the contact in your directories.

1. On the phone home screen, tap **Recents**  to open the Recents list.

The digit on the icon shows the total number of missed calls and unread voice messages on the phone.

By default, your phone displays the call history for the primary line.



2. (For multiple lines) View the call history of a specific line:
 - a. Tap  next to the line to open the Lines list.

If you have missed calls on the phone, an icon  or  displays next to the line.

- b. Choose a line by tapping it from the Lines list.
3. Locate a call entry by scrolling down the Recents list.
4. Tap the call entry to directly make a call.
5. **Optional:** If you want to modify the dial number before you make a call, do the following:
 - a. Tap  for the call entry to show the call history details.
 - b. Tap **Edit dial**.

- c. Enter the dial number based on the existing number.
- d. Tap  to dial the number.

Add a contact from Recents

1. Open the Recents list.
2. Locate the phone number that you want to add.
3. Tap  to open the call details.
4. Tap  and enter the contact name.
5. Tap  to save the contact.

Delete a recent call

Your recent calls are sorted into Placed, Received, and Missed calls in the Recents list. If you don't want any particular call to display in the list, you can delete it.



Note:

You can't delete the call history that the administrator manages in the server.

1. Open the **Recents** list.
2. Locate the record that you want to delete.

You can look for the record by scrolling down the list or using the search bar at the top of the list.

3. On the call entry, tap  to open the call details.

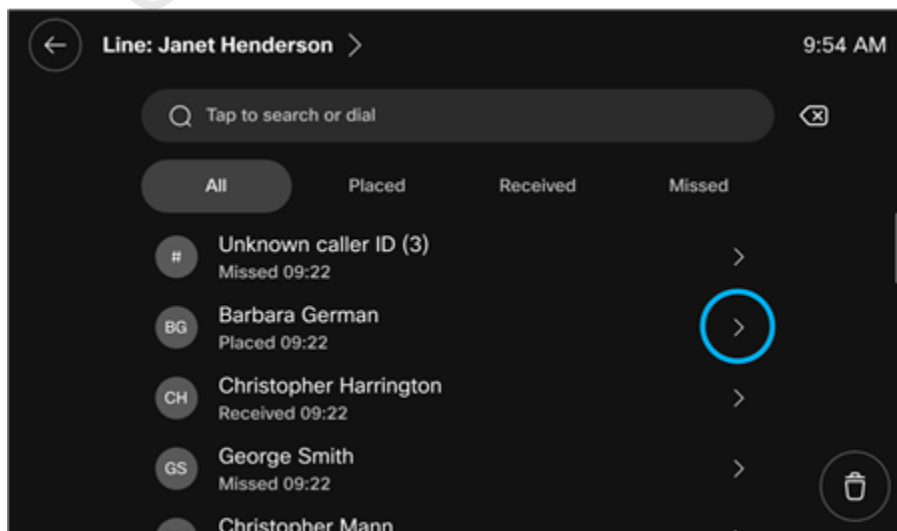

4. Tap .
5. Tap **Yes** to delete the record.

Clear the call history

You can clear the entire call history stored on your phone locally. You can also delete only the call history of a particular type, for example, the placed calls, and keep the others.



Note:

You can't clear the call history that the administrator manages in the server.



1. Open the **Recents** list.
2. Tap one of the following tabs to open it.
 - **All:** (Default) Open this tab if you want to delete all calls on the line.
 - **Placed:** Open this tab if you want to delete all placed calls.
 - **Received:** Open this tab if you want to delete all answered calls.
 - **Missed:** Open this tab if you want to delete all missed calls.
3. Tap .
4. Tap **Yes** on the prompt to clear the list.

CONFIDENTIAL DRAFT

Chapter 6. Settings and troubleshooting

Use a Bluetooth® headset with your phone (Both)

Connect a Bluetooth® headset to your phone

When your Bluetooth headset is paired with the phone, it's the active audio path until you connect another headset or change the audio path. You can see  on the phone home screen header. If the phone audio is in silence, you can see  on the header.

When you use a Bluetooth headset with your phone, keep in mind the following limitations:

- Effective signal range varies by headset model. Check with your headset manufacturer for the maximum headset range. For example, you can take the Cisco Bluetooth Headset as far as 30 meters (90 feet) from the device before you experience a dip in signal quality.
- Your environment may affect your Bluetooth signal quality. Objects such as walls, windows, and desks can reduce your headset range.

1. Press .
2. Scroll down to the **Audio** section and tap **Bluetooth**.
3. Tap the Bluetooth switch to toggle it on.
4. When you see your headset in the list, tap it to connect.

Unpair a Bluetooth® headset

If you don't want your phone to automatically connect to a particular Bluetooth headset, you can unpair the headset from your phone.

1. Press .
2. Scroll down to the **Audio** section and tap **Bluetooth**.
3. Under the device you wish to disconnect, tap **Unpair**.

Manage network and services (MPP)

Change the internet protocol mode

If requires you may need to change the internet protocol mode on which the phone operates.

1. Press **Settings** .
2. Navigate to **Network and service** and go to **Network settings > IP stack**.
3. In the **IP stack** screen, select one of the following internet protocol modes:
 - **IPv4 and IPv6**
 - **IPv4**
 - **IPv6**
4. Select **Apply**.

Change the IP address on the phone

As your network settings require, you may need to change or manually assign the IP address to your phone. You can set or change the IP address on your phone from the network connection menu.

Your phone supports IP version 4 (IPv4), IP version 6 (IPv6), and IPv4 and IPv6. IPv4 and IPv6 is the default setting. The IP parameters can be assigned automatically by the network, or you can set them manually.

Follow the steps in the following sections as needed to change your IPv4 or IPv6 address.

Change IPv4 settings

Follow these steps to change or set your IPv4 network.

If your network supports both IPv4 and IPv6, you may also need to set the IPv6 settings. For how to change IPv6 settings, see [esp_t_mpp_change-ipv6-settings.dita](#).

1. Press **Settings** .
2. Navigate to **Network and service** and go to **Network settings > IPv4 settings**.
3. In the **IPv4 settings** screen, configure the following settings as needed.

Table 10. Parameters for IPv4 settings

Parameters	Options	Default	Description
DHCP	On Off	On	Enable or disable DHCP on your phone. Enable DHCP to allow your phone to get an IP address from the DHCP server. Otherwise, dis-

Parameters	Options	Default	Description
			able DHCP and manually assign an IP address to your phone.
IPv4 address			Available only when DHCP is disabled. You must assign an IP address to the phone when DHCP is disabled.
Subnet mask			Available only when DHCP is disabled. You must specify the subset mask used by the phone when DHCP is disabled.
Gateway			Available only when DHCP is disabled. Identify the default router for the phone to use when DHCP is disabled.
DHCP address released	On Off	Off	Available only when DHCP is enabled. To release the IP address that DHCP assigned for reassignment, turn on this switch. Otherwise, turn it Off.
DHCPv4 option to use		66,160,159, 150,60,43,125	Specify the order in which the phone uses the IP addresses provided by DHCP server.

Parameters	Options	Default	Description
			Separate each option with a comma.
IPv4 DNS address 1			Identify the primary Domain Name System (DNS) server that the phone uses.
IPv4 DNS address 2			Identify the secondary Domain Name System (DNS) server that the phone uses.

4. Select **Apply** when done.

The phone restarts to apply the changes.

Change IPv6 settings

You can change the IPv6 settings when your phone's IP stack is set to **IPv6** or **IPv4 and IPv6**.

1. Press **Settings** .
2. Navigate to **Network and service** and go to **Network settings > IPv6 settings**.
3. In the **IPv6 settings** screen, configure the following settings as needed.

Table 11. Parameters for IPv6 settings

Parameters	Options	Default	Description
DHCPv6	On Off	On	Enable or disable DHCP on your phone. Enable DHCP to allow your phone to get an IP address from the DHCP server. Otherwise, disable DHCP and manually assign an IP address to your phone.

Parameters	Options	Default	Description
IPv6 address			Available only when DHCPv6 is disabled. You must assign an IP address to the phone when DHCP is disabled.
IPv6 prefix length			Available only when DHCPv6 is disabled. Identify how many bits of a Global Unicast IPv6 Address are there in the network part.
IPv6 Gateway			Available only when DHCPv6 is disabled. Identify the default router for the phone to use when DHCP is disabled.
DHCPv6 option to use		66,160,159, 150,60,43,125	Specify the order in which the phone uses the IP addresses provided by DHCP server. Separate each option with a comma.
IPv6 DNS address 1			Identify the primary Domain Name System (DNS) server that the phone uses.

Parameters	Options	Default	Description
IPv6 DNS address 2			Identify the secondary Domain Name System (DNS) server that the phone uses.

4. Select **Apply** when done.

The phone restarts to apply the changes.

Change VLAN settings on your phone

Consult your administrator before you make changes to the VLAN settings.

Determines which Virtual LAN (VLAN) your phone resides in. Your phone uses CDP to communicate information such as auxiliary VLAN ID, per port power management details, and Quality of Service (QoS) configuration information with the Cisco Catalyst switch.

1. Press **Settings** .
2. Navigate to **Network and service** and go to **Network settings > IPv4 settings**.
3. In the **IPv4 settings** screen, configure the following settings as needed.

Table 12. Parameters for VLAN settings

Parameters	Options	Default	Description
Admin VLAN ID	On Off	On	Enter a VLAN ID for the IP phone when you use a VLAN without CDP (VLAN enabled and CDP disabled). Note that only voicepackets are tagged with the VLAN ID. Do not use the 1 value for the VLAN ID. If VLAN ID is 1, you cannot tag voice packets with the VLAN ID.

Parameters	Options	Default	Description
PC VLAN ID			<p>Enter a value of the VLAN ID that is used to tag communications from the PC port on the phone.</p> <p>The phone tags all the untagged frames coming from the PC (it does not tag any frames with an existing tag).</p> <p>Valid values: 0 through 4095</p> <p>Default: 0</p>

4. Click **Apply** when done.

The phone restarts to apply the changes.

Find information on network settings of your phone

If you experience problems, your administrator may ask for information about network status of your phone. This information uniquely identifies the phone for troubleshooting purposes.

1. Press **Settings** .
2. Navigate to **Network and service** and go to **Network status**.
3. Select **Network status** to view the following information.

Table 13. Network status

Parameters	Description
IP stack	Specifies the Internet protocol mode on which the phone operates.
IPv4 address	IPv4 address of the phone.
IPv6 address	IPv6 address of the phone.

Parameters	Description
VLAN	Specifies the VLAN ID of the phone.
IPv4 DNS address 1	Identify the primary Domain Name System (DNS) server that the phone uses when Internet protocol mode is IPv4.
IPv4 DNS address 2	Identify the secondary Domain Name System (DNS) server that the phone uses when Internet protocol mode is IPv4.
IPv6 DNS address 1	Identify the primary Domain Name System (DNS) server that the phone uses when Internet protocol mode is IPv6.
IPv6 DNS address 2	Identify the secondary Domain Name System (DNS) server that the phone uses when Internet protocol mode is IPv6.

Enable 802.1x authentication

When 802.1X authentication is enabled, the phone uses 802.1X authentication to request network access. When 802.1X authentication is turned off, the phone uses CDP to acquire VLAN and network access. You can also view the transaction status on the phone screen menu.

1. Press **Settings** .
2. Navigate to **Network and service** and go to **Security settings**.
3. Select **Security settings > 802.1x authentication**.
4. In the **802.1x authentication** screen, configure the following settings as needed.

Table 14. Parameters for 802.1x

Parameters	Options	Default	Description
Device authentication	On Off	On	Enable or disable 802.1x on your phone.

Parameters	Options	Default	Description
Transaction status			Displays the state of 802.1x authentication.
Protocol			Displays the EAP method that is used for 802.1x authentication. The protocol can be EAP-FAST or EAP-TLS.

Manage network and services (Onprem)

Change the IP address on your phone

As your network settings require, you may need to change or manually assign the IP address to your phone. You can set or change the IP address on your phone from the network connection menu.

Your phone supports IP version 4 (IPv4), IP version 6 (IPv6), and IPv4 and IPv6. IPv4 and IPv6 is the default setting. The IP parameters can be assigned automatically by the network, or you can set them manually.

Follow the steps in the following sections as needed to change your IPv4 or IPv6 address.

Change IPv6 settings

You can change the IPv6 settings when your phone's IP stack is set to **IPv6** or **IPv4 and IPv6**.

1. Press **Settings** .
2. Navigate to **Network and service** and go to **Network settings > IPv6 settings**.
3. In the **IPv6 settings** screen, configure the following settings as needed.

Table 15. Parameters for IPv6 settings

Parameters	Options	Default	Description
DHCPv6	On Off	On	Enable or disable DHCP on your phone.

Parameters	Options	Default	Description
			Enable DHCP to allow your phone to get an IP address from the DHCP server. Otherwise, disable DHCP and manually assign an IP address to your phone.
IPv6 address			Available only when DHCPv6 is disabled. You must assign an IP address to the phone when DHCP is disabled.
IPv6 prefix length		0	Available only when DHCPv6 is disabled. Identify how many bits of a Global Unicast IPv6 Address are there in the network part.
IPv6 Gateway			Available only when DHCPv6 is disabled. Identify the default router for the phone to use when DHCP is disabled.
IPv6 DNS address 1			Identify the primary Domain Name System (DNS) server that the phone uses.
IPv6 DNS address 2			Identify the secondary Domain Name System (DNS) server that the phone uses.

Parameters	Options	Default	Description
IPv6 alternate TFTP	On Off	Off	<p>Available only when DHCP is enabled.</p> <p>Indicates whether the phone is using an alternate TFTP server.</p>
IPv6 TFTP server 1			<p>Unavailable only when Alternate TFTP is disabled.</p> <p>Primary Trivial File Transfer Protocol (TFTP) server that the phone uses. If you are not using DHCP in your network and you want to change this server, you must use the TFTP Server 1 option.</p> <p>If Alternate TFTP is enabled, enter a non-zero value for the TFTP Server 1 option.</p> <p>If neither the primary TFTP server nor the backup TFTP server is listed in the CTL or ITL file on the phone, you must unlock the file before you can save changes to the TFTP Server 1 option. In this case, the phone deletes the file when you save changes to the TFTP Server 1 option. A new CTL or ITL file downloads from the new TFTP Server 1 address.</p> <p>When the phone looks for the TFTP server, the phone gives precedence to manually as-</p>

Parameters	Options	Default	Description
			<p>signed TFTP servers, regardless of the protocol. If your configuration includes both IPv6 and IPv4 TFTP servers, the phone prioritizes the order that it looks for the TFTP server by giving priority to manually assigned IPv6 TFTP servers and IPv4 TFTP servers. The phone looks for the TFTP server in this order:</p> <ol style="list-style-type: none"> a. Any manually assigned IPv4 TFTP servers b. Any manually assigned IPv6 servers c. DHCP assigned TFTP servers d. DHCPv6 assigned TFTP servers
IPv6 TFTP server 2			<p>Unavailable only when Alternate TFTP is disabled.</p> <p>Optional backup TFTP server that the phone uses if the primary TFTP server is unavailable.</p> <p>If neither the primary TFTP server nor the backup TFTP server is listed in the CTL or ITL file on the phone, you must unlock either of the files before you can save changes to the TFTP Server 2 option. In this case, the phone deletes either of the files when</p>

Parameters	Options	Default	Description
			<p>you save changes to the TFTP Server 2 option. A new CTL or ITL file downloads from the new TFTP Server 2 address.</p> <p>If you forget to unlock the CTL or ITL file, you can change the TFTP Server 2 address in either file, then erase them by pressing Erase from the Security Configuration menu. A new CTL or ITL file downloads from the new TFTP Server 2 address.</p> <p>When the phone looks for the TFTP server, it gives precedence to manually assigned TFTP servers, regardless of the protocol. If your configuration includes both IPv6 and IPv4 TFTP servers, the phone prioritizes the order that it looks for the TFTP server by giving priority to manually assigned IPv6 TFTP servers and IPv4 TFTP servers. The phone looks for the TFTP server in the following order:</p> <ul style="list-style-type: none"> a. Any manually assigned IPv4 TFTP servers b. Any manually assigned IPv6 servers

Parameters	Options	Default	Description
			<p>c. DHCP assigned TFTP servers</p> <p>d. DHCPv6 assigned TFTP servers</p>
IPv6 address released	On Off	Off	<p>Available only when DHCP is enabled.</p> <p>To release the IP address that DHCP assigned for reassignment, turn on this switch. Otherwise, turn it Off.</p>

4. Select **Apply** when done.

The phone restarts to apply the changes.

Change VLAN settings on your phone

Consult your administrator before you make changes to the VLAN settings.

Determines which Virtual LAN (VLAN) your phone resides in. Your phone uses CDP to communicate information such as auxiliary VLAN ID, per port power management details, and Quality of Service (QoS) configuration information with the Cisco Catalyst switch.

1. Press **Settings** .
2. Navigate to **Network and service** and go to **Network settings > IPv4 settings**.
3. In the **IPv4 settings** screen, configure the following settings as needed.

Table 16. Parameters for VLAN settings

Parameters	Options	Default	Description
Admin VLAN ID	On Off	On	Enter a VLAN ID for the IP phone when you use a VLAN

Parameters	Options	Default	Description
			without CDP (VLAN enabled and CDP disabled). Note that only voicepackets are tagged with the VLAN ID. Do not use the 1 value for the VLAN ID. If VLAN ID is 1, you cannot tag voice packets with the VLAN ID.
PC VLAN ID			Enter a value of the VLAN ID that is used to tag communications from the PC port on the phone. The phone tags all the untagged frames coming from the PC (it does not tag any frames with an existing tag). Valid values: 0 through 4095 Default: 0

4. Click **Apply** when done.

The phone restarts to apply the changes.

Find information on network settings of your phone

If you experience problems, your administrator may ask for information about network status of your phone. This information uniquely identifies the phone for troubleshooting purposes.

1. Press **Settings** .
2. Navigate to **Network and service** and go to **Network status**.
3. Select **Network status** to view the following information.

Table 17. Network status

Parameters	Description
IP stack	Specifies the Internet protocol mode on which the phone operates.
IPv4 address	IPv4 address of the phone.
IPv6 address	IPv6 address of the phone.
VLAN	Specifies the VLAN ID of the phone.
IPv4 DNS address 1	Identify the primary Domain Name System (DNS) server that the phone uses when Internet protocol mode is IPv4.
IPv4 DNS address 2	Identify the secondary Domain Name System (DNS) server that the phone uses when Internet protocol mode is IPv4.
IPv4 DNS address 3	Identify the optional Domain Name System (DNS) server that the phone uses when Internet protocol mode is IPv4.
IPv4 TFTP address 1	Identify Primary Trivial File Transfer Protocol (TFTP) server that the phone uses.
IPv4 TFTP address 2	Identify Secondary Trivial File Transfer Protocol (TFTP) server that the phone uses.
IPv6 DNS address 1	Identify the primary Domain Name System (DNS) server that the phone uses when Internet protocol mode is IPv6.
IPv6 DNS address 2	Identify the secondary Domain Name System (DNS) server that the phone uses when Internet protocol mode is IPv6.

Parameters	Description
IPv6 TFTP address 1	Identify Primary Trivial File Transfer Protocol (TFTP) server that the phone uses when Internet protocol mode is IPv6.
IPv6 TFTP address 2	Identify Secondary Trivial File Transfer Protocol (TFTP) server that the phone uses when Internet protocol mode is IPv6.

Enable 802.1x authentication

When 802.1X authentication is enabled, the phone uses 802.1X authentication to request network access. When 802.1X authentication is turned off, the phone uses CDP to acquire VLAN and network access. You can also view the transaction status on the phone screen menu.

1. Press **Settings** .
2. Navigate to **Network and service** and go to **Security settings**.
3. Select **Security settings > 802.1x authentication**.
4. In the **802.1x authentication** screen, configure the following settings as needed.

Table 18. Parameters for 802.1x

Parameters	Options	Default	Description
Device authentication	On Off	On	Enable or disable 802.1x on your phone.
Transaction status			Displays the state of 802.1x authentication.
Protocol			Displays the EAP method that is used for 802.1x authentication. The protocol can be EAP-FAST or EAP-TLS.

Set the time and language for your phone (MPP)

Set time zone and time format

The default time zone on your phone is GMT-8:00. Set your time zone to display your local time on the phone. Your phone displays time in 12-hour format by default. You can change it to 24-hour time format, if needed.

1. Press **Settings** .
2. If prompted, enter the password to access the **Settings** menu. You can get the password from your administrator.
3. Go to the **Language and region** section.
4. Tap **Time settings > Time zone** and select your time zone.
5. Tap **Time format** and select the 24-hour or 12-hour time format.

Change language for your phone

You can change your phone's language settings in the phone **Settings** menu.

You can change the language when your phone is not in a call or a meeting. When you change the language settings, the soft keyboard on your device reflects that change. This means that you can use the alphabet of your language when you use the keyboard, for example when you search in the directory.



Note:

The soft keyboard doesn't support Korean, Japanese, and Traditional Chinese. When you set your phone to any of these languages, only the English keyboard is available.

Your administrator can deploy specific languages to your phone. If you can't change the language or can't find your language, contact your administrator.

Your phone supports the following languages:

- Arabic
- Czech
- Danish
- Dutch
- English

- French (France)
- French(Canada)
- German
- Hebrew
- Hungarian
- Italian
- Japanese
- Korean
- Norwegian
- Polish
- Portuguese (Portugal)
- Simplified Chinese
- Spanish (Spain)
- Swedish
- Traditional Chinese
- Turkish
- Ukrainian

1. Press **Settings** .
2. If prompted, enter the password to access the **Settings** menu. You can get the password from your administrator.
3. Go to the **Language and region** section.
4. Tap **Language**, navigate through the list, and select the language for your phone.

Troubleshooting your phone

Find information about your phone

Your administrator may ask for information about your phone. This information uniquely identifies the phone for troubleshooting purposes.

1. Press **Settings** .
2. If prompted, enter the password to access the **Settings** menu. You can get the password from your administrator.
3. Select **About this device**.

You can view the following information:

- **Product name**—Name that represents the phone.
- **Serial number**—Serial number of the phone.
- **MAC address**—Unique Media Access Control (MAC) address of the phone.
- **IPv4 address**—Internet Protocol Version 4 (IPv4) address of the phone.
- **IPv6 address**—Internet Protocol Version 6 (IPv6) address of the phone.
- **Active server**—IP address of the active Cisco Unified Communications Manager (CUCM) server.
- **Standby server**—IP address of the standby CUCM server.
- **Software version**—Version number of the phone firmware.
- **Last upgrade**—Information about the last upgrade or status of the software download progress.
- **Hardware version**—Version number of the phone hardware.
- **VID**—Version ID of the phone.
- **Certificate**—The status of certificate installation: Installed or Uninstalled. This item is available only on phones registered to Cisco BroadWorks or Webex Calling.
- **Customization**—The status of onboarding with EDOS or GDS. This item is available only on phones registered to Cisco BroadWorks or Webex Calling.

The status can be one of the following statuses:

- **Aborted**: The device has been provisioned through the phone web page or the phone screen. The onboarding process through EDOS and GDS is discarded.
- **Acquired**: The device has downloaded configuration from the EDOS server.
- **GDS-Acquired**: The device has downloaded configuration from the GDS server.

4. Select **Back** to exit the **About this device** screen.

Check phone issues and diagnostics

If you are experiencing any issues with your phone (for example, network connection, phone registration, or phone upgrade), then you see an error message displayed under **Issues**.

Use the information and functions listed under the **Issues and diagnostics** section to collect data and troubleshoot any problems on your phone. Typically, this section contains the following functions:

Table 19. Issues and diagnostics

Diagnostics	Function
Issues	Select this item to view the detected issues. When issues are found, it shows the number of issues. If no issues are detected, it shows None.
Diagnostics	Select this item if you want to see the statistics information about the network, service, and calls. The specific statistics vary with the calling system that your phone is deployed to.
Report problem	Select this item if you want to collect and send your device logs to your administrator.

1. Press **Settings** .
2. If prompted, enter the password to access the **Settings** menu. You can get the password from your administrator.
3. Select **Issues and diagnostics** and go to **Issues** or **Diagnostics** as you need.
4. Select the field as you need to see the relevant statistics.
5. Select **Back** to return to the upper-level menu.

Report problem from your phone

When you seek for help on phone issues from your administrator, send your device logs to the administrator for troubleshooting.

1. Press **Settings** .
2. If prompted, enter the password to access the **Settings** menu. You can get the password from your administrator.
3. Select **Issues and diagnostics > Report problem**.
4. Enter the date and time when the issue occurred.
By default, the current date and time are populated, you can further change them.
5. Choose a description from the **Problem description** list.

6. Select **Submit**.

After the report is sent, you can see the report file name and the submission time.



Note:

If your phone can't send out the problem report, the report file is generated locally, and you can download the file from a given IP address.

Check network status

Check the network connection details when you are troubleshooting a network issue. The **Network status** screen in the phone menu gives you the details about the Ethernet or Wi-Fi settings.



Note:

Cisco Desk Phone 9841 and 9851 don't support Wi-Fi network. The network status doesn't show wireless network related information.

1. Press **Settings**



2. If prompted, enter the password to access the **Settings** menu. You can get the password from your administrator.
3. Select **Network and service > Network status**.

Restart your phone

You may need to restart your phone to resolve some issues or for some changes to take effect. A phone restart doesn't erase the phone settings. You can restart your phone either from the touch user interface.

1. Press **Settings**



2. If prompted, enter the password to access the **Settings** menu. You can get the password from your administrator.
3. Scroll down to the menu bottom and select **Restart**.
4. Select **Restart** in the prompt window.

Reset security settings (Cisco Unified CM)



Note:

The security certificate reset option isn't available on phones that are registered to Cisco BroadWorks or Webex Calling.

If you want to change the phone registration from a Cisco Unified Communications Manager (Unified CM) server to another Cisco Unified CM server, we recommend that you delete the security settings on your phone. Security settings reset removes the Certificate Trust List (CTL) file. The phone gets the new CTL file from the new Unified CM cluster so that the phone can register successfully.

1. Press **Settings** .
2. If prompted, enter the password to access the **Settings** menu. You can get the password from your administrator.
3. Scroll down the list and select **Restart and reset > Reset security certificate**.
4. Select **Reset**.

Reset your phone to the factory settings

A factory reset clears all settings from your phone. You lose your current registration and all the configuration after a factory reset. You must register and set up your phone as you do for a new phone before you can use it again.

Reset your phone using the phone menu

In some circumstances, you may want to reset your phone settings. For example, when you encounter severe technical problems with your phone or you want to clear the existing configuration, a factory reset can help.

You can use the phone menu to factory reset your phone. If you can't access to the menu from the phone screen, you can [use the phone keypad to reset your phone](#).

1. Press **Settings** .
2. If prompted, enter the password to access the **Settings** menu. You can get the password from your administrator.
3. Scroll down to the menu bottom and select **Factory reset**.
4. Select **Reset** in the prompt window to start the reset.
Your phone reboots when the reset completes.

Reset your phone with the keypad

Use these steps to reset the phone to the factory default settings using the keypad.

You have two methods to perform the factory reset:

- **Method 1** (recommended): Press # > **123456789*0#**
- **Method 2**: Press 0 > **369#**

1. Unplug the phone:
 - If using Power over Ethernet (PoE), unplug the Ethernet cable.
 - If using the power cube, unplug the power cube.
2. Wait 5 seconds.
3. Press and hold # and plug the phone back in.
The Headset button, the Speaker button, and the Mute button light up.
4. As soon as the Mute button goes off, release # and press **123456789*0#** in sequence.



Note:

When you press **1**, the Headset button goes off.

You have less than 15 seconds to finish pressing the keys. The phone goes into a normal startup if you don't finish the input before it times out or you press the keys out of sequence.

After you finish pressing these keys, the Mute button lights up, indicating the factory reset process has started.



CAUTION:

Don't power down the phone until it completes the factory reset process and the **Welcome** screen appears.

Reset your phone with the phone web page (BroadWorks or Webex Calling)

You can remote restore your phone to its default settings from the phone web page only when your phone is registered to Cisco BroadWorks or Webex Calling.

Reset your phone from the phone web page with one of the methods:

- In your web browser, enter the URL in the following format and click **Confirm Factory Reset**.

`http://<Phone IP>/admin/factory-reset`

where:

`Phone IP` = the actual IP address of your phone.

`/admin` = the path to access admin page of your phone.

`/factory-reset` = the command that you must enter in the phone web page to factory-reset your phone.

- An administration access to the phone web page is required to use this method.
 - a. On the phone web page, select **Admin Login > Advanced > Info > Debug Info**.
 - b. Click **Factory Reset** in the **Factory Reset** section.
 - c. Click **CONFIRM FACTORY RESET** on the next page.

CONFIDENTIAL DRAFT

Chapter 7. Cisco 9800 series key expansion module

Cisco 9800 key expansion module overview

Figure 4. Key expansion module

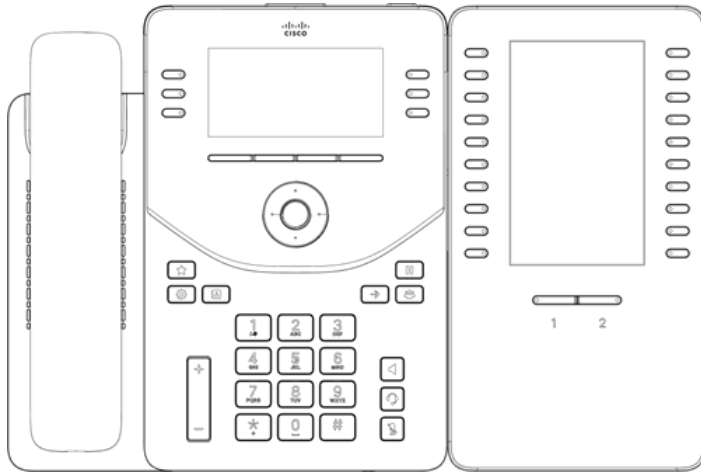

You can use more than one expansion module per phone. But each module must be the same type. The following table lists the phones and the number of key expansion modules that each model supports.

Table 20. Cisco IP phones and supported Cisco IP phone 9800 key expansion module

Cisco IP phone model	Supported number of key expansion modules and buttons
Cisco Desk Phone 9851	1; single LCD; 20 line keys
Cisco Desk Phone 9861	3; single LCD; 20 line keys
Cisco Desk Phone 9871	3; single LCD; 20 line keys

Install key expansion module

You can connect the key expansion module to the phone.

1. Remove the accessory connector cover.



2. Firmly press the USB connector attached to the module to the phone.

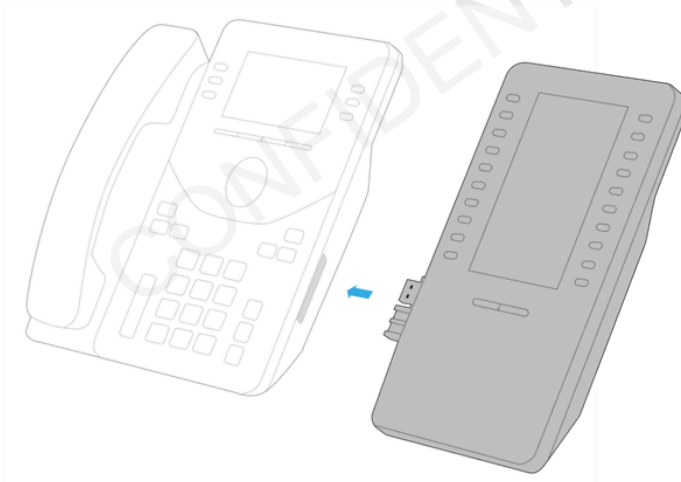

3. Fasten the screws into the phone.

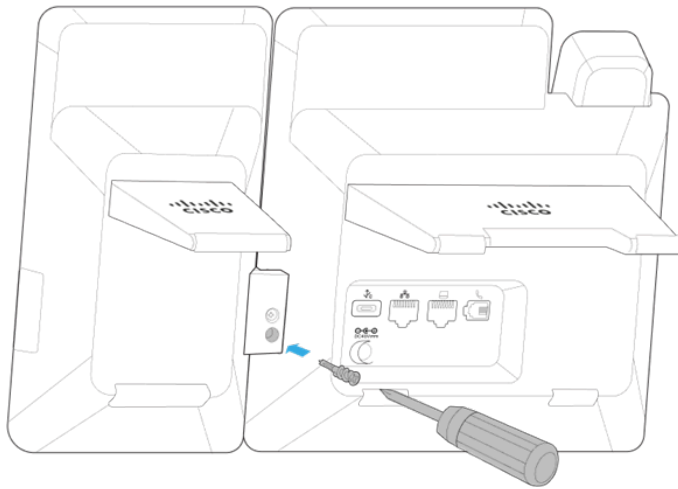

After you firmly attach the module to the phone, the front screen of the phone and KEM appears as following. No line numbers appear on the screen.

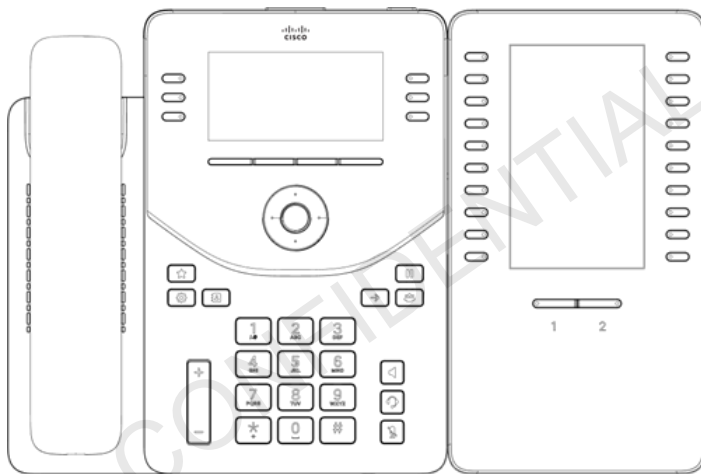

Key Expansion Module buttons and hardware

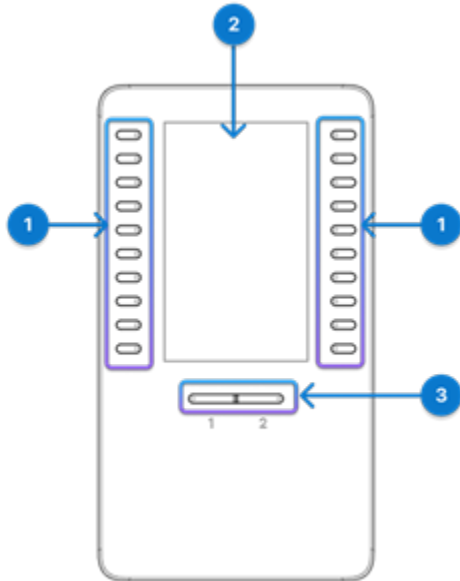

The following table describes the features of the key expansion module.

Table 21. Key Expansion Modules Buttons and Hardware







Hardware	Description
1. Line keys	<p>Lighted buttons—Line buttons. Each button or pair of buttons corresponds to one line. The lights beneath each button indicate the state of the corresponding line as follows:</p> <ul style="list-style-type: none">  light off—Button is not configured.  green steady LED—Line is configured correctly is in idle state.  red steady LED—Line in use and have an active call on it.  amber steady/blinking LED—A configuration error occurred when this feature was being set up.

Table 21. Key Expansion Modules Buttons and Hardware (continued)

Hardware	Description
2. LCD screen	<p>LCD screen—Displays the phone number, speed-dial number (or name or other text label), phone service, or phone feature assigned to each button.</p> <p>Icons that indicate line status resemble (in both appearance and function) the icons on the phone to which the key expansion module is attached.</p>
3. Shift buttons	<p>Shift buttons—2 buttons. The button for page 1 is labeled as 1 and the button for page 2 is labeled as 2. The lights in each button indicate the state of the page as follows:</p> <p> green steady LED—Page is in view.</p> <p> light off—Page is not in view.</p> <p> amber steady LED—Page is not in view with one or more alerting calls on the page.</p>

Chapter 8. Safety and compliance information

Safety and performance information

Power outage

Your access to emergency service through the phone requires that the phone receive power. If a power interruption occurs, service, emergency calling service dialing, and emergency alarm service access do not function until power is restored. If a power failure or disruption occurs, you may need to reset or reconfigure the equipment before you can use service or emergency calling service dialing.

Regulatory domains

The radio frequency (RF) for this phone is configured for a specific regulatory domain. If you use this phone outside of the specific regulatory domain, the phone will not function properly, and you might violate local regulations.

External devices

We recommend that you use good-quality external devices that are shielded against unwanted radio frequency (RF) and audio frequency (AF) signals. External devices include headsets, cables, and connectors.

Depending on the quality of these devices and their proximity to other devices, such as mobile phones or two-way radios, some audio noise may still occur. In these cases, we recommend that you take one or more of these actions:

- Move the external device away from the source of the RF or AF signals.
- Route the external device cables away from the source of the RF or AF signals.
- Use shielded cables for the external device, or use cables with a better shield and connector.
- Shorten the length of the external device cable.
- Apply ferrites or other such devices on the cables for the external device.

Cisco cannot guarantee the performance of external devices, cables, and connectors.



CAUTION:

In European Union countries, use only external speakers, microphones, and headsets that are fully compliant with the EMC Directive [2014/30/EU] or RED Directive [2014/53/EU].

Bluetooth wireless headset performance

Cisco IP Phones support Bluetooth Class 2 technology when the headsets support Bluetooth. Bluetooth enables low-bandwidth wireless connections within a range of 30 feet (10 meters). The best performance is in the 3- to 6-foot (1- to 2-meter) range. You can pair up to five headsets, but only the last one paired is used as the default.

Because of potential interference issues, we recommend that you move 802.11b/g devices, Bluetooth devices, microwave ovens, and large metal objects away from the wireless headset.

The Bluetooth wireless headset does not need to be within direct line-of-sight of the phone. However, some barriers, such as walls or doors, and interference from other electronic devices, can affect the connection.

Ways to provide power to your phone

You can provide power to your phone in one of these ways:

- Use the power adapter that comes with your phone.
- If your network supports Power over Ethernet (PoE), you can plug your phone into the network.

Plug an Ethernet cable into the Ethernet phone port  and into the network.

If you are not sure whether your network supports PoE, check with your administrator.

UL warning

The LAN/Ethernet cable or other cables attached to the device should not be extended outside of the building.

Energy star



The following phones have Energy Star certification:

- Cisco Desk Phone 9841
- Cisco Desk Phone 9851
- Cisco Desk Phone 9861
- Cisco Desk Phone 9871

Any phone model that isn't listed in the above list isn't certified.

Product label

The product label is located on the bottom of the device.

Compliance statements

Compliance statements for the European Union

CE marking

The following CE mark is affixed to the equipment and packaging.



RF exposure statement for the European Union

This device has been evaluated and found compliant in accordance with EU EMF Directive 2014/53/EU.

This device is restricted to indoor use only when operating in the 5150 to 5350 MHz frequency range.

Compliance statements for the US

Part 15 radio device



CAUTION:

The Part 15 radio device operates on a non-interference basis with other devices operating at this frequency. Any changes or modification to said product not expressly approved by Cisco, including the use of non-Cisco antennas, could void the user's authority to operate this device.

Compliance statements for Canada

This device complies with Industry Canada license-exempt RSS standard(s). Operation is subject to the following two conditions: (1) this device may not cause interference, and (2) this device must accept any interference, including interference that may cause undesired operation of the device. Privacy of communications may not be ensured when using this phone.

This product meets the applicable Innovation, Science and Economic Development Canada technical specifications.

Avis de Conformité Canadien

Cet appareil est conforme aux normes RSS exemptes de licence RSS d'Industry Canada. Le fonctionnement de cet appareil est soumis à deux conditions : (1) ce périphérique ne doit pas causer d'interférence et (2) ce périphérique doit supporter les interférences, y compris celles susceptibles d'entraîner un fonctionnement non souhaitable de l'appareil. La protection des communications ne peut pas être assurée lors de l'utilisation de ce téléphone.

Le présent produit est conforme aux spécifications techniques applicables d'Innovation, Sciences et Développement économique Canada.

Canadian RF exposure statement

THIS DEVICE MEETS THE LIMITS AS REFERENCED BY ISED RSS-102 R5 FOR EXPOSURE TO RADIO WAVES

Your device includes a radio transmitter and receiver. It is designed not to exceed the General populace (uncontrolled) limits for exposure to radio waves (radio frequency electromagnetic fields) as referenced in RSS-102 which references Health Canada Safety Code 6 and include a substantial safety margin designed to assure the safety of all persons, regardless of age and health.

As such the systems are designed to be operated as to avoid contact with the antennas by the end user. It is recommended to set the system in a location where the antennas can remain at least a minimum distance as specified from the user in accordance to the regulatory guidelines which are designed to reduce the overall exposure of the user or operator.

This equipment should be installed and operated with minimum distance 20 cm between the radiator & your body.

The device has been tested and found compliant with the applicable regulations as part of the radio certification process.

The device for operation in the band 5150-5250 MHz is only for indoor use to reduce the potential for harmful interference to co-channel mobile satellite systems.

Déclaration d'Exposition aux RF Canadienne

CE PÉRIPHÉRIQUE RESPECTE LES LIMITES DÉCRITES PAR LA NORME RSS-102 R5 D'EXPOSITION À DES ONDES RADIO

Votre appareil comprend un émetteur et un récepteur radio. Il est conçu pour ne pas dépasser les limites applicables à la population générale (ne faisant pas l'objet de contrôles périodiques) d'exposition à des ondes radio (champs électromagnétiques de fréquences radio) comme indiqué dans la norme RSS-102 qui sert de référence au règlement de sécurité n°6 sur l'état de santé du Canada et inclut une marge de sécurité importantes conçue pour garantir la sécurité de toutes les personnes, quels que soient leur âge et état de santé.

En tant que tels, les systèmes sont conçus pour être utilisés en évitant le contact avec les antennes par l'utilisateur final. Il est recommandé de positionner le système à un endroit où les antennes peuvent demeurer à au moins une distance minimum préconisée de l'utilisateur, conformément aux instructions des réglementations qui sont conçues pour réduire l'exposition globale de l'utilisateur ou de l'opérateur.

Cet équipement doit être installé et utilisé avec une distance minimale de 20 cm entre le radiateur et votre corps.

Le périphérique a été testé et déclaré conforme aux réglementations applicables dans le cadre du processus de certification radio.

les dispositifs fonctionnant dans la bande 5150-5250 MHz sont réservés uniquement pour une utilisation à l'intérieur afin de réduire les risques de brouillage préjudiciable aux systèmes de satellites mobiles utilisant les mêmes canaux.

Canadian high-power radars statement

Users should also be advised that high-power radars are allocated as primary users (that is, priority users) of the bands 5250-5350 MHz and 5650-5850 MHz and that these radars could cause interference and/or damage to LE-LAN devices.

Devraient également être informés des utilisateurs que les radars à haute puissance sont désignés comme utilisateurs principaux (à savoir des utilisateurs prioritaires) des bandes 5250-5350 MHz et 5650 à 5.850 MHz et que ces radars pourraient provoquer des interférences et / ou endommager les périphériques LE-LAN.

FCC compliance statements

The Federal Communications Commission requires compliance statements for the following:

FCC Part 15.19 Statement

This device complies with part 15 of the FCC Rules. Operation is subject to the following two conditions: (1) This device may not cause harmful interference, and (2) this device must accept any interference received, including interference that may cause undesired operation.

FCC Part 15.21 Statement

Changes or modifications not expressly approved by the party responsible for compliance could void the user's authority to operate the equipment.

FCC RF Radiation Exposure Statement

This equipment complies with FCC radiation exposure limits set forth for an uncontrolled environment. End users must follow the specific operating instructions for satisfying RF exposure compliance. This transmitter must be at least 20 cm from the user and must not be collocated or operating in conjunction with any other antenna or transmitter.

FCC Receivers and Class B Digital Statement

This product has been tested and complies with the specifications for a Class B digital device, pursuant to Part 15 of the FCC Rules. These limits are designed to provide reasonable protection against harmful

interference in a residential installation. This equipment generates, uses, and can radiate radio frequency energy and, if not installed and used according to the instructions, may cause harmful interference to radio communications. However, there is no guarantee that interference will not occur in a particular installation.

If this equipment does cause harmful interference to radio or television reception, which is found by turning the equipment off and on, the user is encouraged to try to correct the interference by one or more of the following measures:

- Reorient or relocate the receiving antenna
- Increase the separation between the equipment or devices
- Connect the equipment to an outlet other than the receiver's
- Consult a dealer or an experienced radio/TV technician for assistance

Cisco product security overview

This product contains cryptographic features and is subject to U.S. and local country laws that govern import, export, transfer, and use. Delivery of Cisco cryptographic products does not imply third-party authority to import, export, distribute, or use encryption. Importers, exporters, distributors, and users are responsible for compliance with U.S. and local country laws. By using this product, you agree to comply with applicable laws and regulations. If you are unable to comply with U.S. and local laws, return this product immediately.

Further information regarding U.S. export regulations can be found at <https://www.bis.doc.gov/index.php/regulations/export-administration-regulations-ear>.

Cisco circular economy

Cisco has adopted circular design principles in its products by pioneering the use of post-consumer recycled plastic. Cisco Desk Phone 9800 Series now reduces the use of natural resources while closing the loop with its own electronic waste.

Visit Cisco's Circular Economy website to learn more about what this means:

- Web site URL: <https://www.cisco.com/c/en/us/about/circular-economy.html>



- Web site QR code:



Important online information

End User License Agreement

The End User License Agreement (EULA) is located here: <https://www.cisco.com/go/eula>

Regulatory Compliance and Safety Information

Regulatory Compliance and Safety Information (RCSI) is located here:

https://www.cisco.com/c/dam/en/us/td/docs/voice_ip_comm/cuipph/9800-series/regulatory_compliance/rcsi-0274-book.pdf

CONFIDENTIAL DRAFT