

EXHIBIT 3: Information for which Confidentiality is Requested

Schematics

Block Diagrams (p. 46, P2P Architecture)

Theory of Operations (P2P Architecture)

EXHIBIT 4: Product Photographs

EXHIBIT 5: Bill of Materials (BOM)

EXHIBIT 6: User Manual and FCC ID Label

EXHIBIT 7: RF Hazard Information Per Sec. 1.1307

For transmitters operating in the 2.5-2.7 GHz frequency range, paragraph 1.1310 limits maximum permissible exposure (MPE) to 1 mW/cm² for uncontrolled environments, and 5 mW/cm² for controlled environments.

The maximum distance from the antenna at which MPE is met or exceeded is calculated from the equation relating field strength in V/m, transmit power in watts, transmit antenna gain, and separation distance in meters:

$$E, \text{V/m} = (30 \cdot P \cdot G) / d$$

$$\text{Power density, mW/m}^2 = E^2 / 3770$$

$$E \text{ for MPE } 1 \text{ mW/m}^2 = 61.4 \text{ V/m}$$

$$E \text{ for MPE } 5 \text{ mW/m}^2 = 136 \text{ V/m}$$

Cisco does not provide an antenna with their MMDS radio system. The licensee is responsible for placing a label on the antenna providing adequate information regarding hazardous RF exposure (such as the maximum distance at which MPE is achieved) and including reference to the applicable FCC regulations.

EXHIBIT 8: Report of Measurements

2.1033(c)13 Description of Modulation System

Refer to appropriate chapters in attached electronic file P2P-Architecture.doc

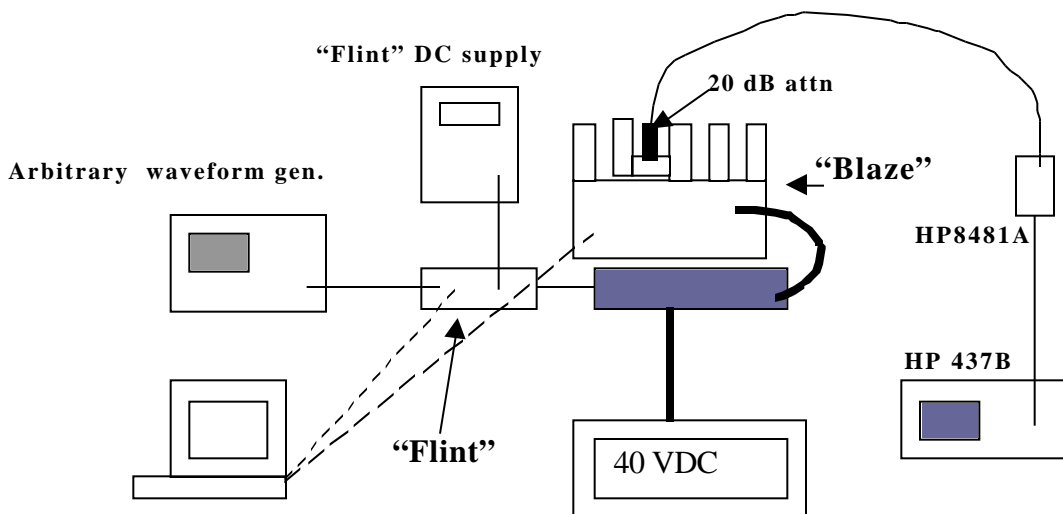
2.1033(c)14 Test Data per 2.1046 – 2.1057

2.1055 RF Output Power Measurements

Measurement equipment used:

HP 437B Power meter
HP 8381A power sensor

Test set-up:



Test Procedures

1. □ Set the "Flint" channel bandwidth parameters and output level to desired values. Output level is chosen to maximize RF output level from "Blaze" while keeping spectral re-growth and spurious emissions from "Blaze" at acceptably low levels.
2. □ Set "Blaze" output power and channel bandwidth parameters as required.
3. □ Zero HP 437/HP8481A and enter HP8481A cal factors.
4. □ Connect HP8481A to 20 dB attenuator and record value.

Test Results

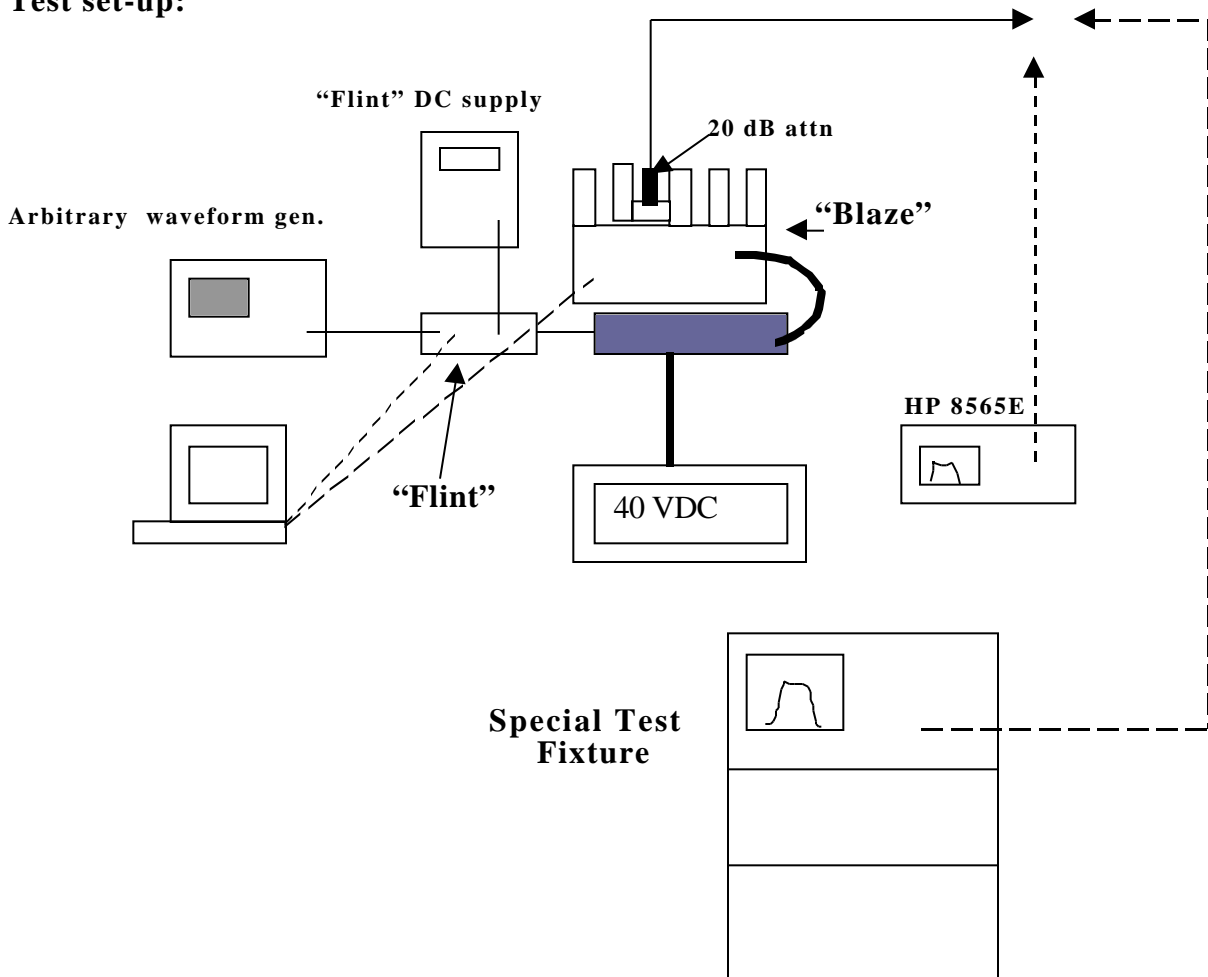
F(MHz)	P _{out} , 6 MHz Ch. BW	P _{out} , 12 MHz Ch BW
2506	(20)+8.54 = 28.54 dBm	(20)+6.5 = 26.5 dBm

Section 2.1047 Modulation Characteristics

Measurement equipment used:

HP 8565E spectrum analyzer
Cisco Special Test Fixture

Test set-up:



Test Procedures

1. The output of the "Blaze" unit is first coupled to the input of the Special Test Fixture. This test equipment is described in a document entitled Special Test Fixture. This equipment extends the measurement system dynamic range to meet the attenuation requirements of paragraph 21.908(e):

At more than 3 MHz removed from channel edge: 60 dB down from flat top, measured with 100 kHz bandwidth

The dynamic range of commercially available spectrum analyzers is limited to 50-55 dB.

2. □ Set transmitter output power and channel bandwidth parameters as required to meet the 60 dB attenuation requirement.
3. □ Record the output power level settings. This is the maximum permitted operating power level for each channel.
4. □ Connect the transmitter to the spectrum analyzer. Use the Digital Radio Personality utility to compare the transmitter output to a peak power relative mask.
5. □ Plot/photograph resultant spectrum analyzer trace.

Test Results

PASS. The Special Test Fixture yielded the following results:

TX Output Frequency: 2506 MHz

Channel BW/ Output power	Reading, fc	Reading, fL	Reading, fH	ATTN, fL	ATTN, fH
6 MHz/ 28.54 dBm	-12.7 dBm	-73.7 dBm	-73.0 dBm	61 dB	60.3 dB
12 MHz/ 26.5 dBm	-13.4 dBm	-73.7 dBm	-73.7 dBm	60.3 dB	60.3 dB

Refer to spectrum analyzer graphs in Exhibit 9.

Section 2.1049 Occupied Bandwidth

Measurement Equipment Used:

HP 856EE Spectrum Analyzer

Test Set-up

- Same as for 2.1047 above, but without the Special Test Fixture

Test Procedures and Results:

Using MKR DELTA function of the analyzer:

-26 dB Occupied Bandwidth: 6 MHz and 12 MHz

Section 2.1051 Spurious and Harmonic Emissions at Antenna Terminals

Measurement Equipment Used:

HP 856EE Spectrum Analyzer

Test Set-up

-□ Same as for 2.1049 above

Test Procedures

Section 21.908(e) requires that for a 100 kHz measurement bandwidth, all emissions removed from the channel edge by more than 3 MHz must be attenuated at least 60 dB below the channel emission flat top.

1. □ Set spectrum analyzer to TX output center frequency, RES BW = 100 kHz, VID BW = 100 Hz.
2. □ Use analyzer PEAK SEARCH to find flat top peak.
3. □ Set DISPLAY LINE to a level 60 dB below flat top peak
4. □ Record transmitter output spectrum from 1 MHz to 10th harmonic of TX output frequency
5. □ Plot/photograph spectrum analyzer data

Test Results

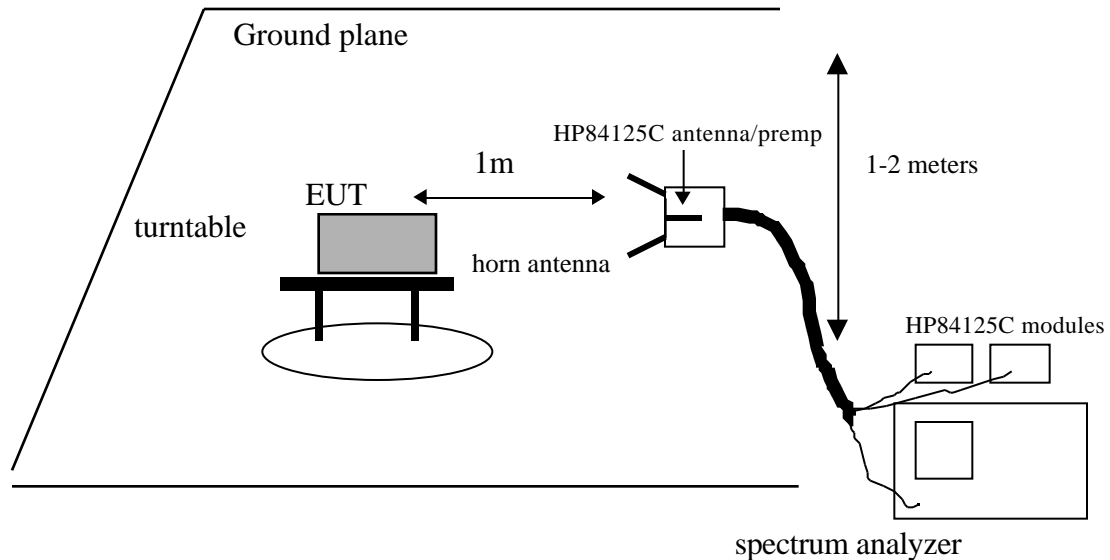
PASS. Refer to 14 spectrum analyzer photographs labeled “Antenna Conducted Emissions”, Exhibit 10. Output emissions data is presented from 1 MHz to the 10th harmonic of the carrier frequency.

Section 2.1053 Field Strength of Spurious and Harmonic Radiation

Measurement Equipment Used:

HP 8565E Spectrum Analyzer
 HP 84125C Microwave EMI Measurement System

Test Set-Up



Minimum Requirement

The magnitude of each spurious and harmonic emission detected as being radiated from the EUT must be at a level more than 60 dB below the emission flat top = -44.4 dBm

Resultant radiated field at 1 m from -44.4 dBm source feeding isotropic antenna:

$$61 \text{ dBuV/m}$$

Test Method

The antenna output port of the EUT was terminated with a 50 ohm load. With the transmitter operating at full power, the EUT was rotated 360° and the search antenna was raised and lowered in both polarities, all in an attempt to maximize the levels of the received emission for each harmonic and spurious emission up to 10 fo.

Test Results

Refer to spectrum analyzer photographs labeled Case Radiated Emissions in Exhibit 10. The HP 84125C system stores antenna factors, cable losses, and other correction factors in software, and the spectrum analyzer displays corrected field strength levels. Spurious and harmonic radiated emissions from the transmitter were below the 61 dBuV/m limit at 1 m separation.

2.1056 Frequency Stability

NOT APPLICABLE. Frequency stability tests are not meaningful for OFDM modulation systems.

Part 15 Digital Device Emissions

Tests were performed to measure radiated emissions per 15.109 of the Rules. A separate verification report is being held on file at Cisco Systems.

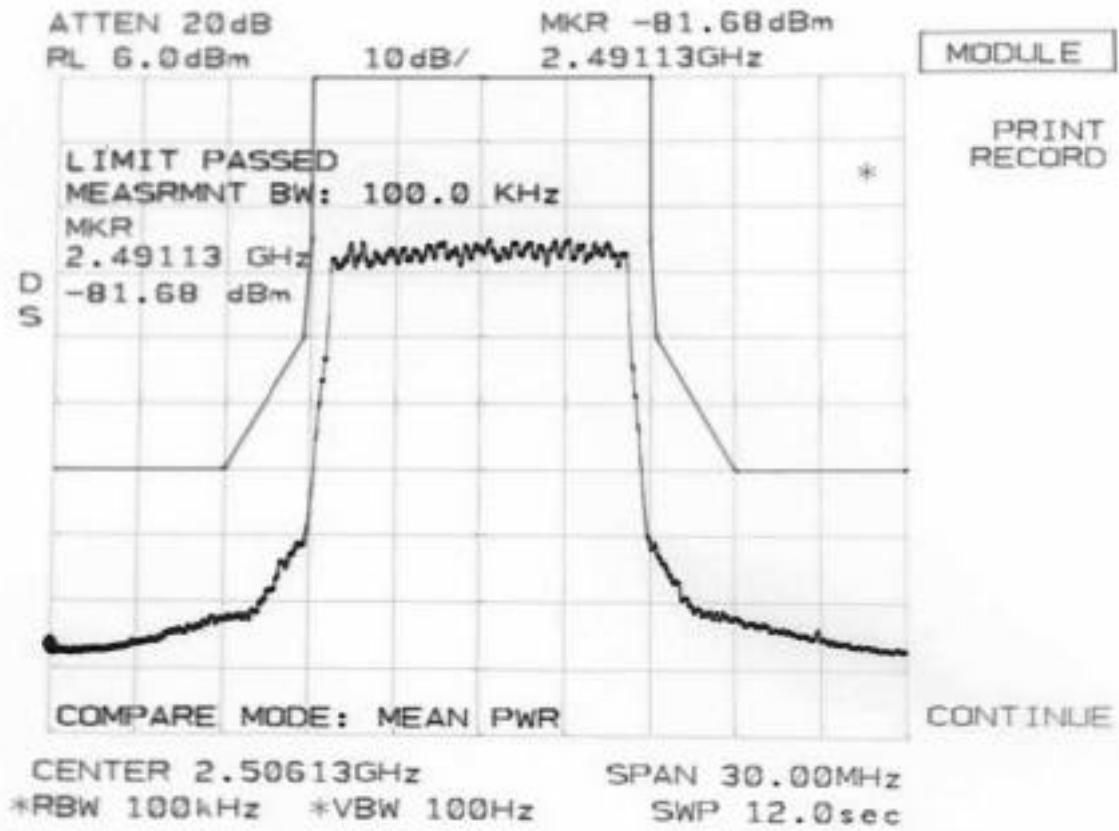
Test Site

All testing was performed at Cisco Systems by me or under my supervision. Conducted and radiated emissions were performed using test equipment with calibration traceable to NIST, and following test procedures accepted by the industry.

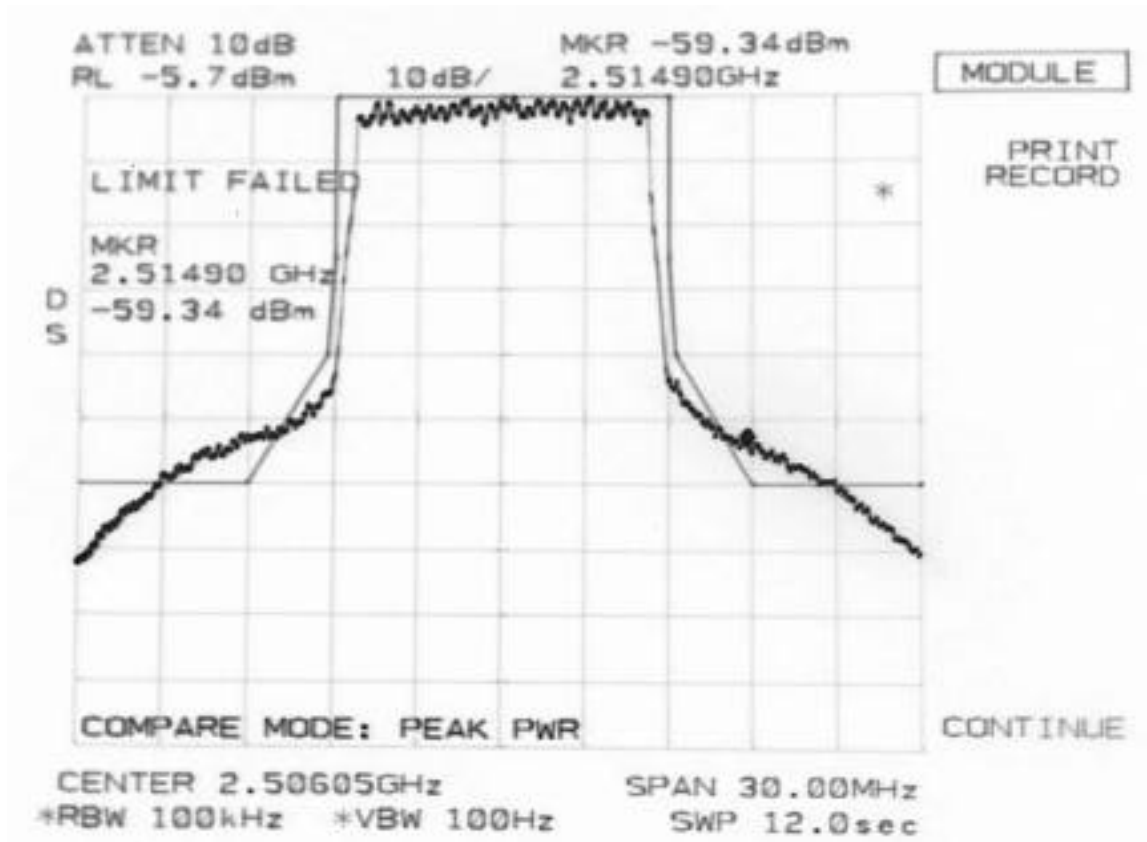
THOMAS N. COKENIAS
Consultant, EMC&Radio Type Approvals

EXHIBIT 9: Data Graphs: Emissions Masks

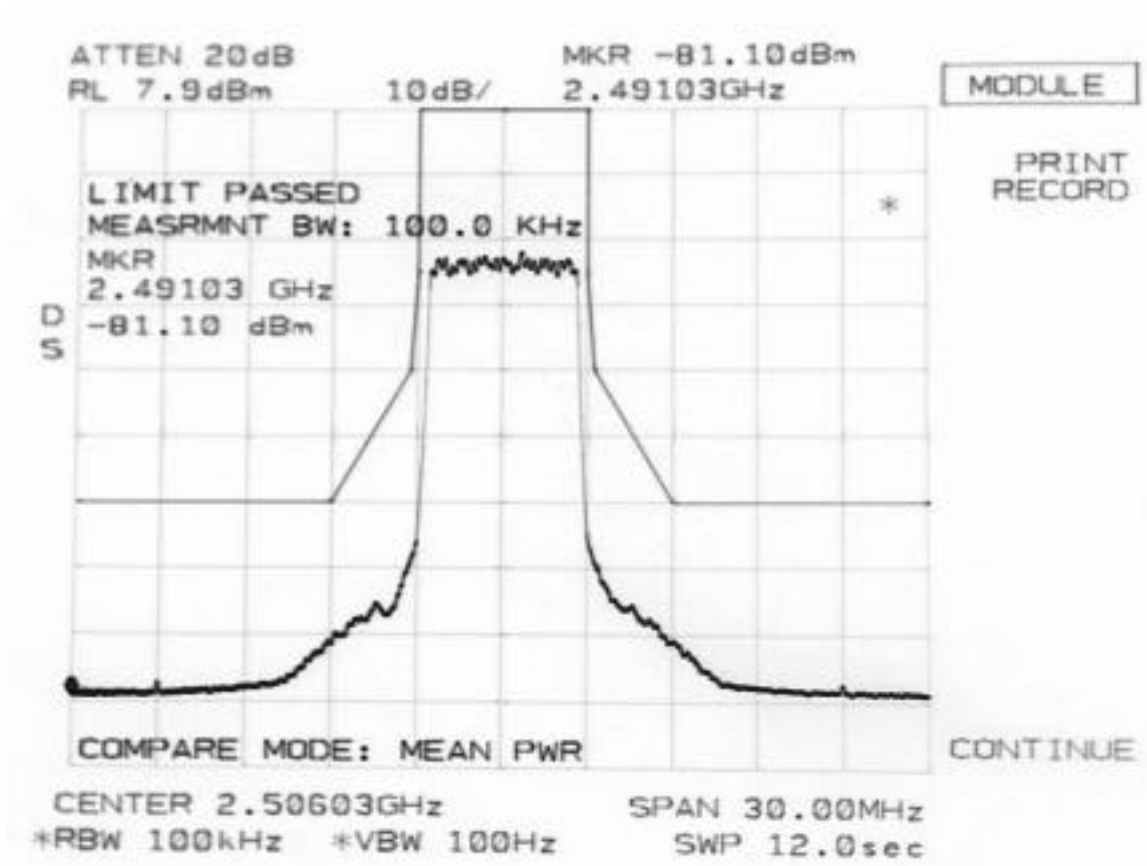
12 MHz Channel Mask, 100 kHz Mean Power Comparison



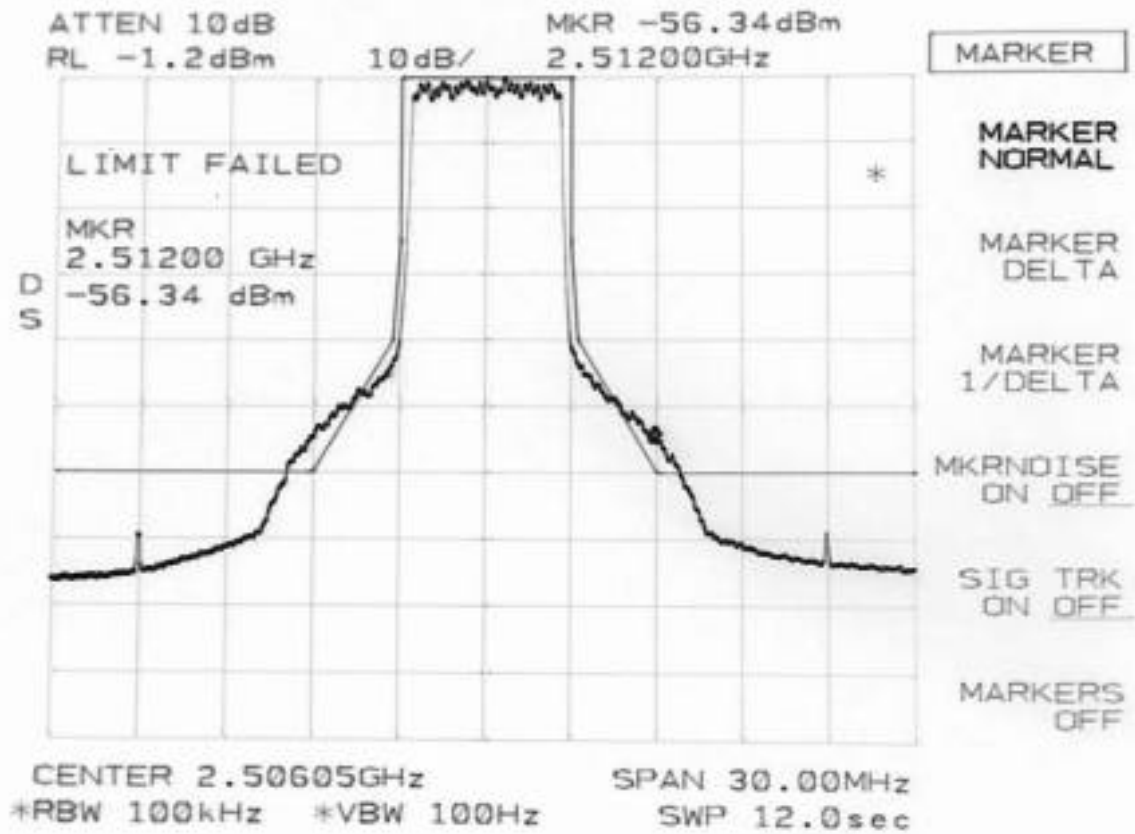
12 MHz Channel Mask, 100 kHz Peak Power Comparison



6 MHz Channel Mask, 100 kHz Mean Power Comparison

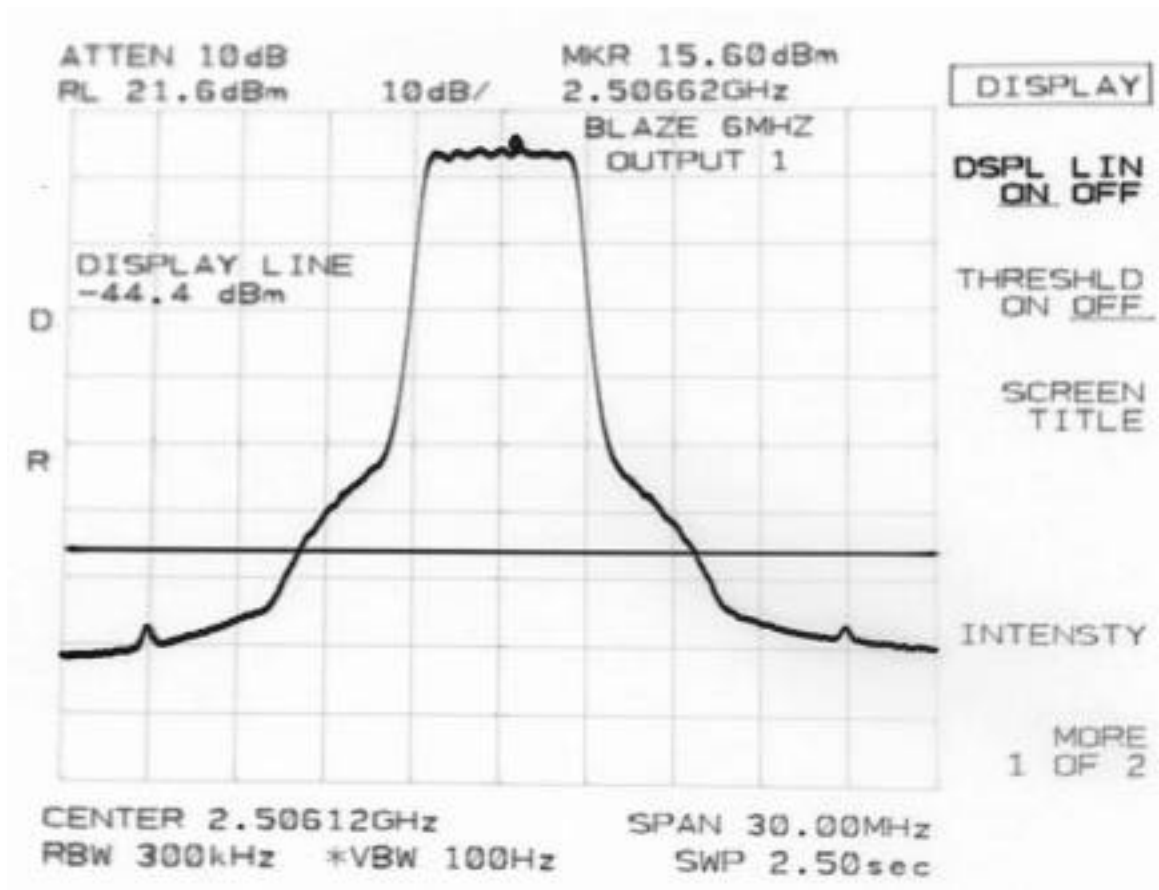


6 MHz Channel Mask, 100 kHz Peak Power Comparison

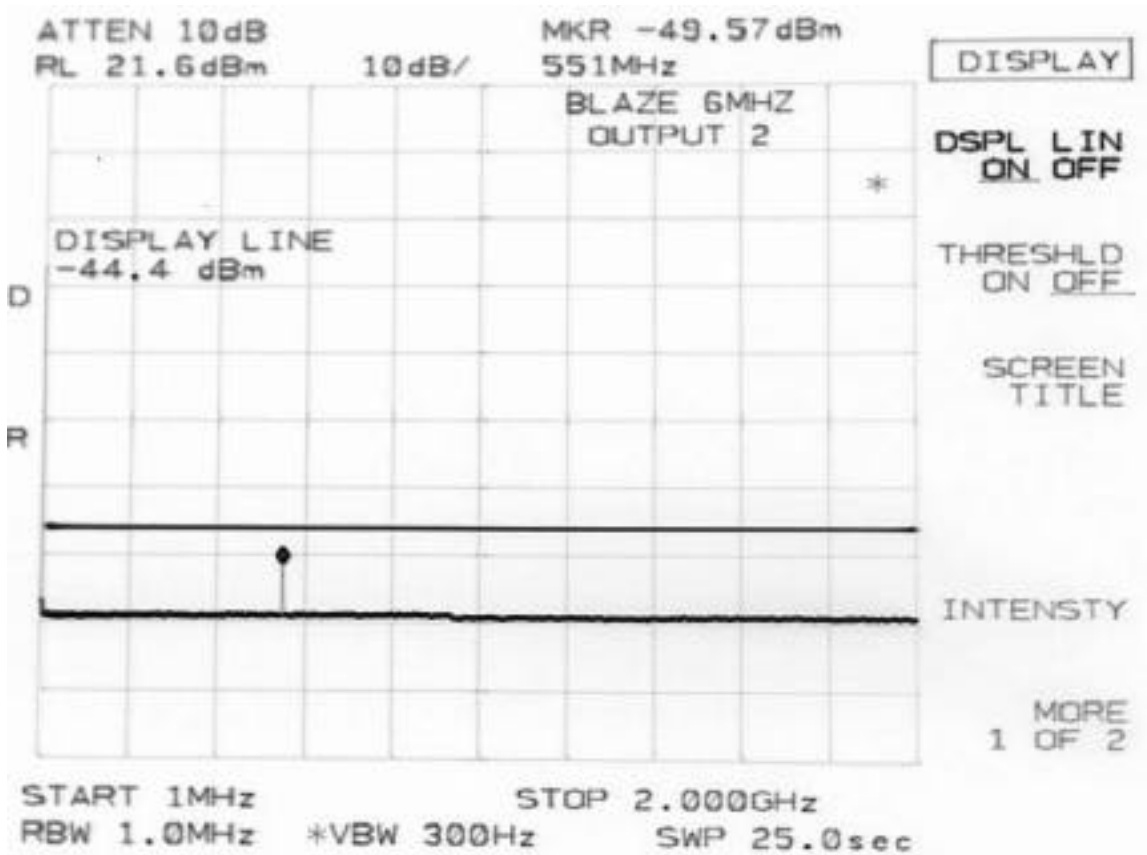


**EXHIBIT 10: Data Graphs: Antenna Conducted Emissions
Case Radiated Emissions**

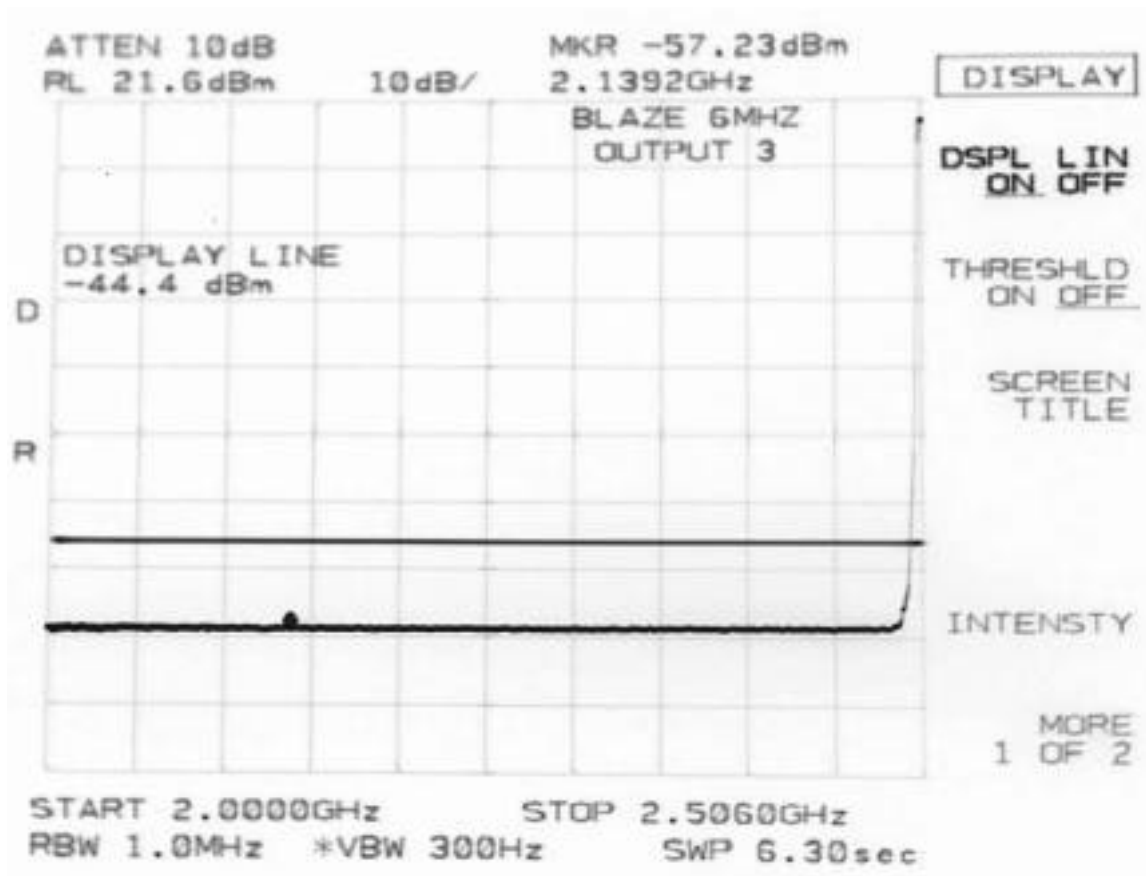
Antenna Conducted Emissions, 6 MHz Channel Bandwidth (1 of 7)



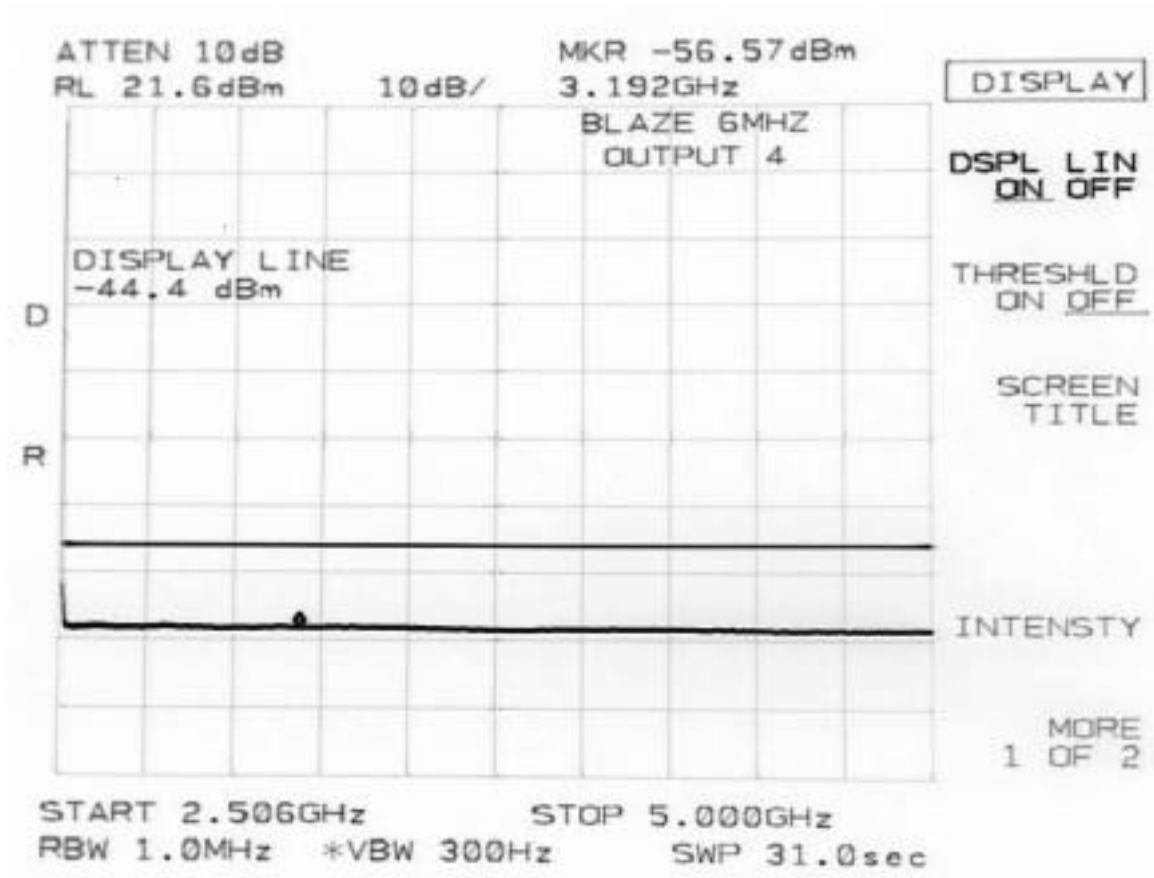
Antenna Conducted Emissions, 6 MHz Channel Bandwidth (2 of 7)



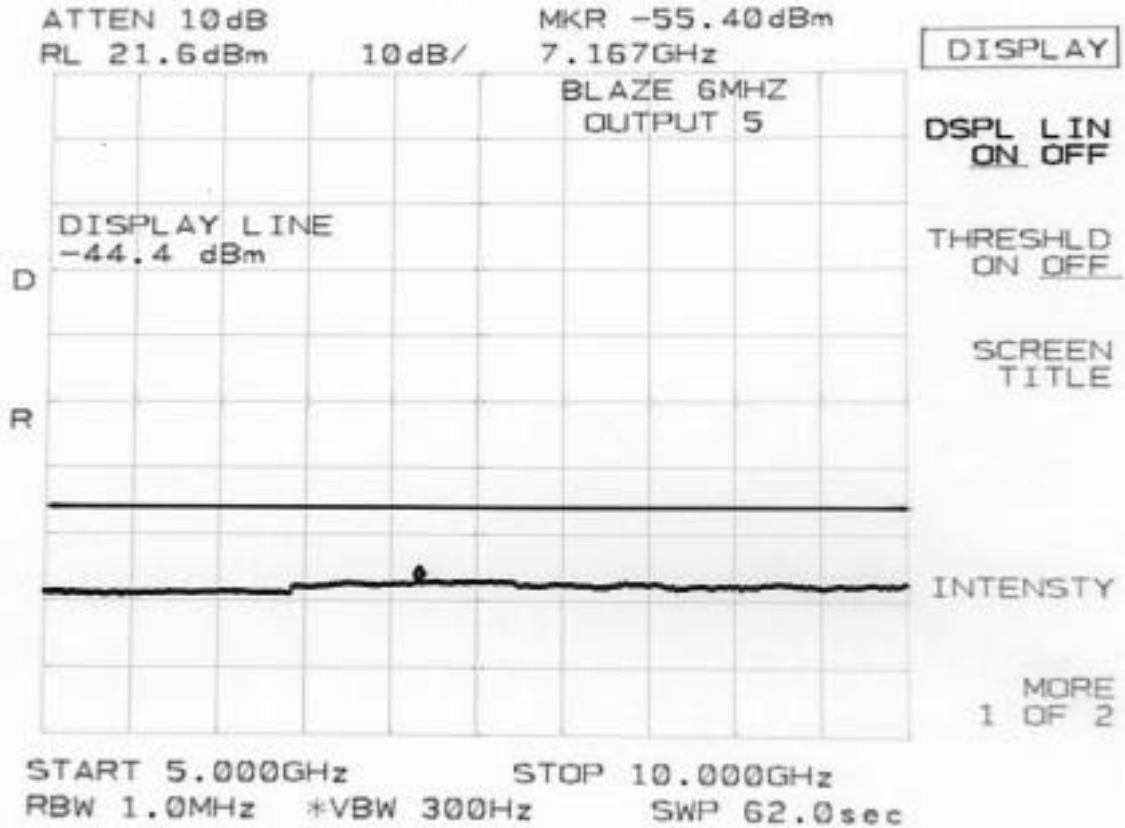
Antenna Conducted Emissions, 6 MHz Channel Bandwidth (3 of 7)



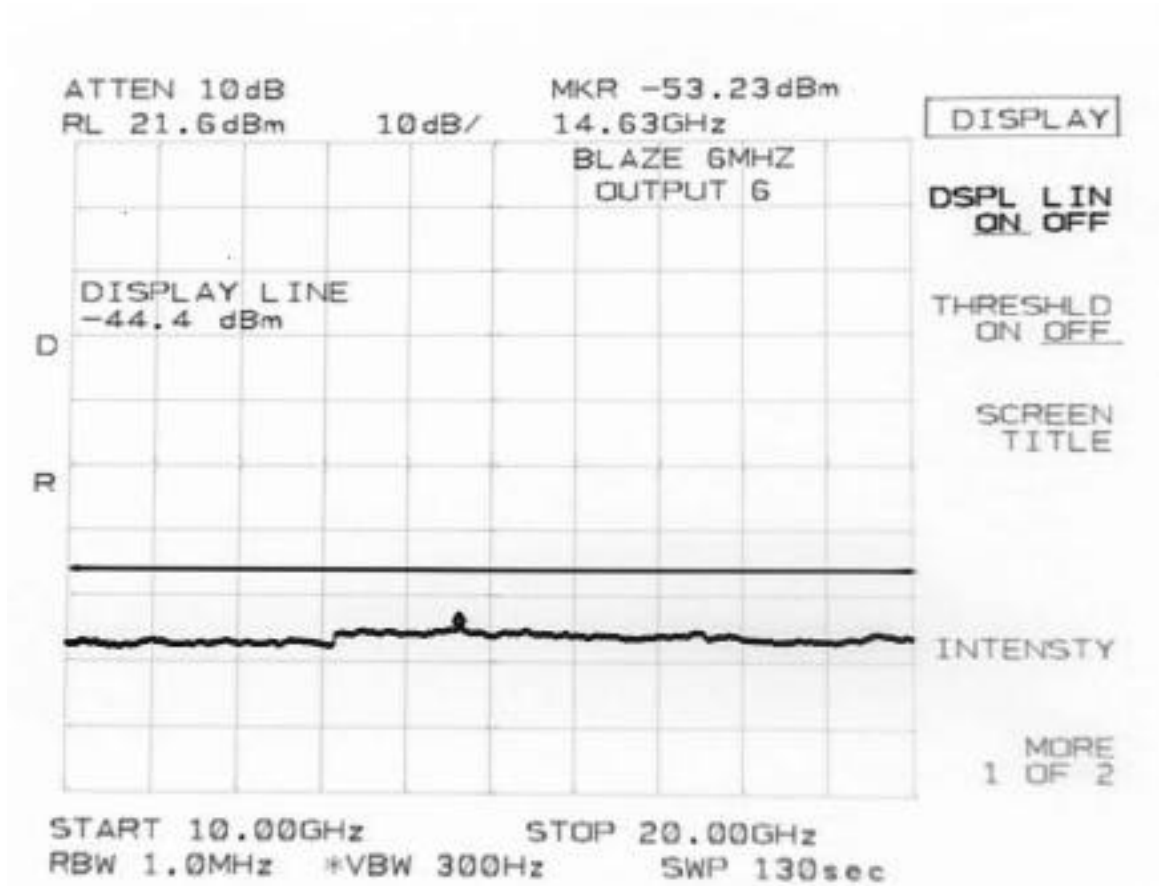
Antenna Conducted Emissions, 6 MHz Channel Bandwidth (4 of 7)



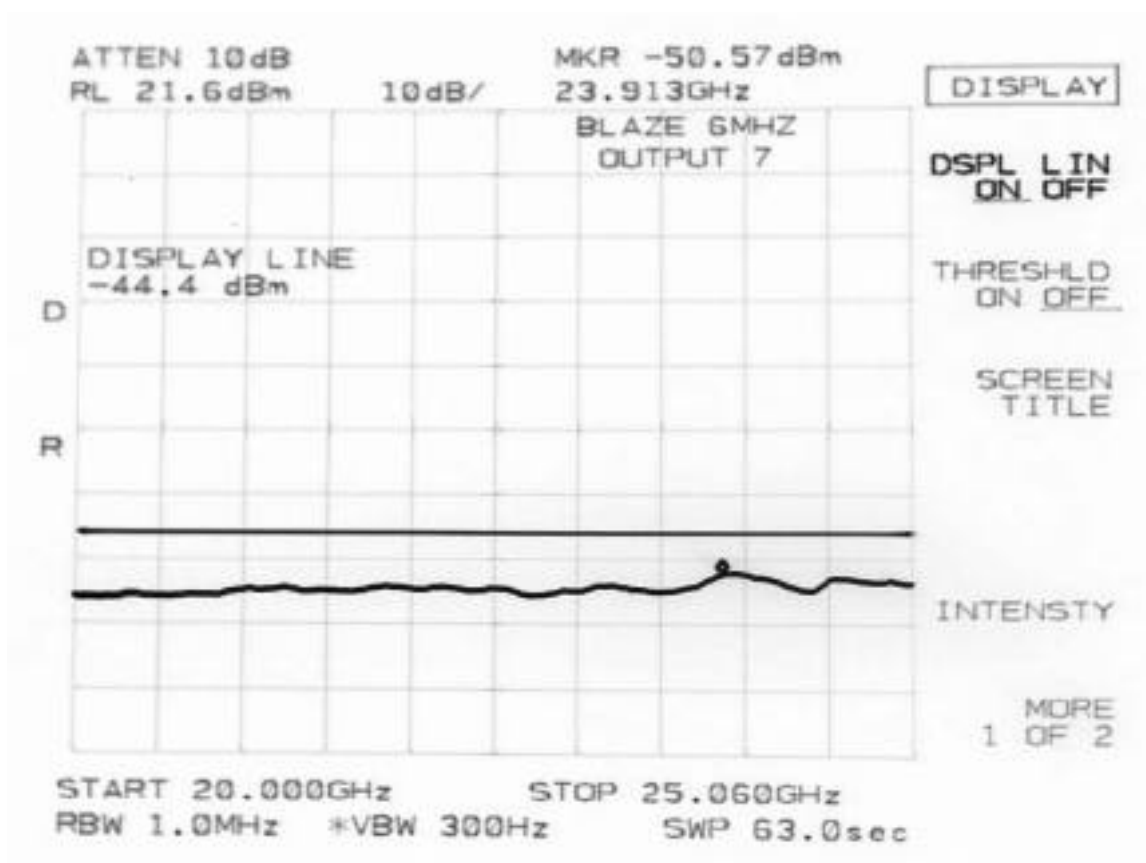
Antenna Conducted Emissions, 6 MHz Channel Bandwidth (5 of 7)



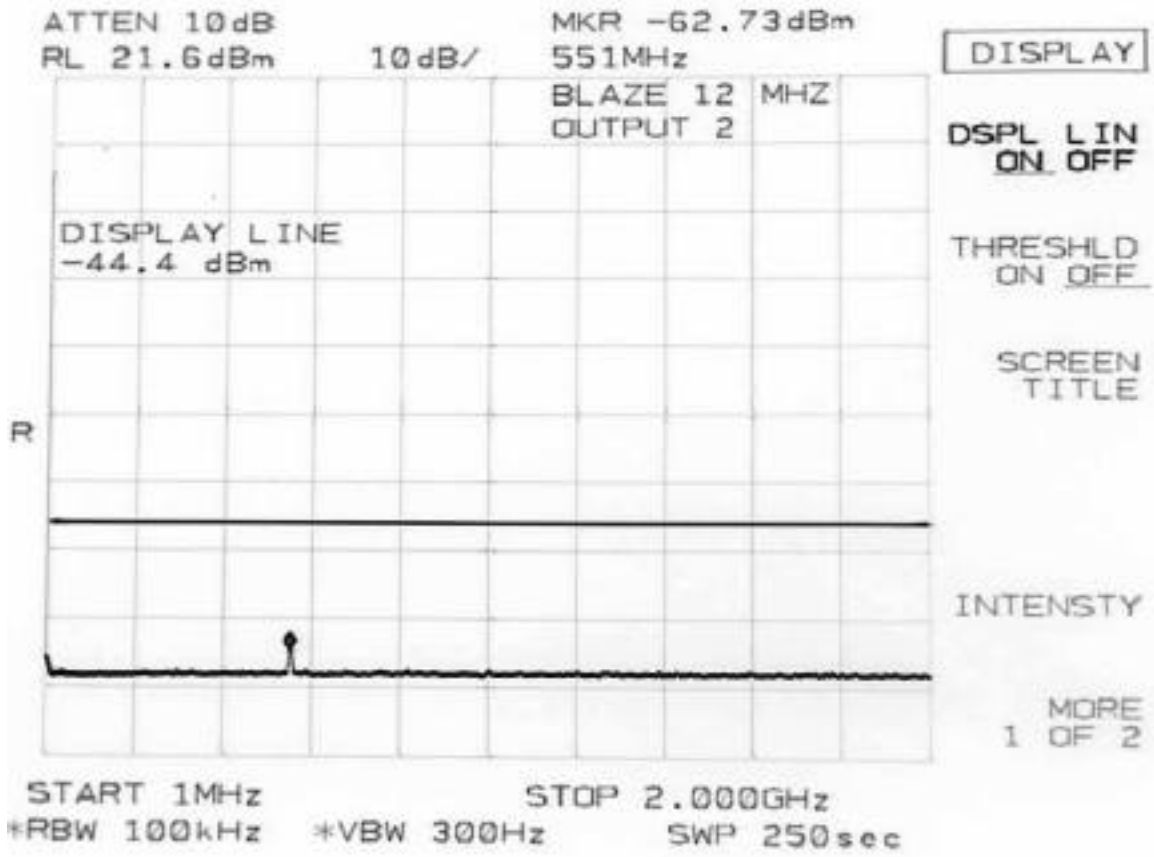
Antenna Conducted Emissions, 6 MHz Channel Bandwidth (6 of 7)



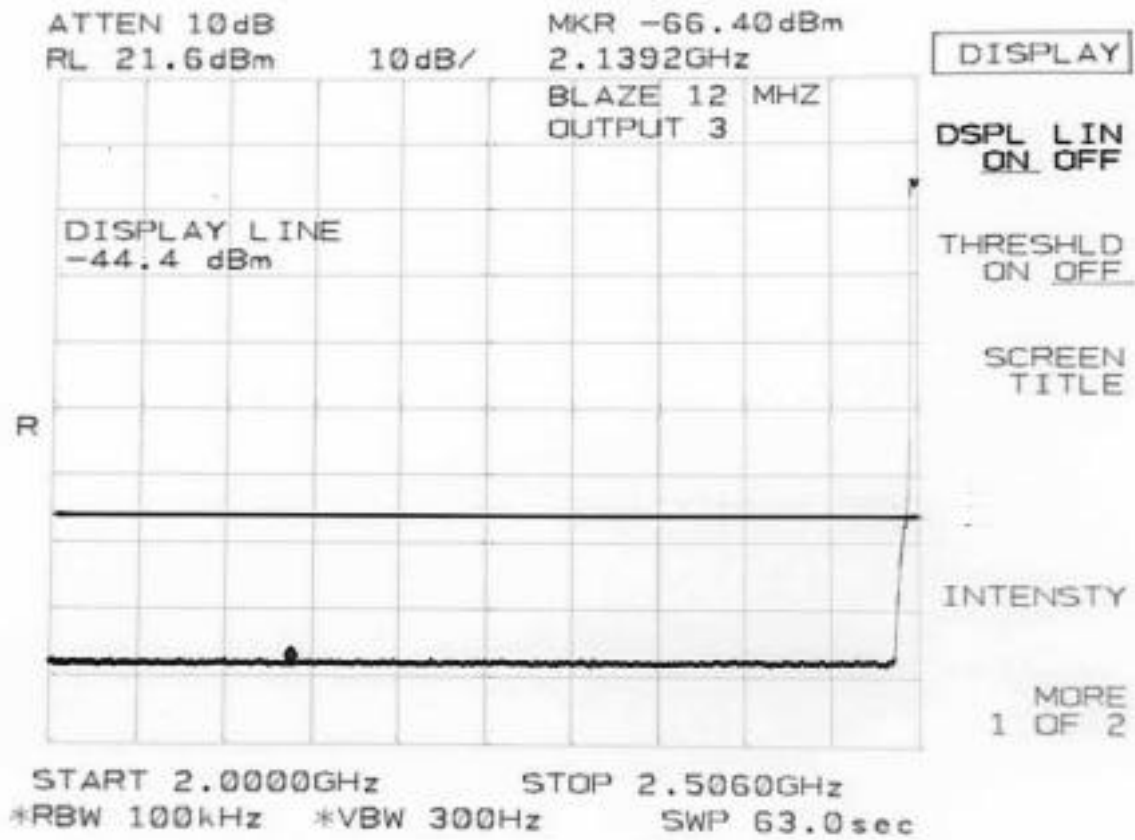
Antenna Conducted Emissions, 6 MHz Channel Bandwidth (7 of 7)



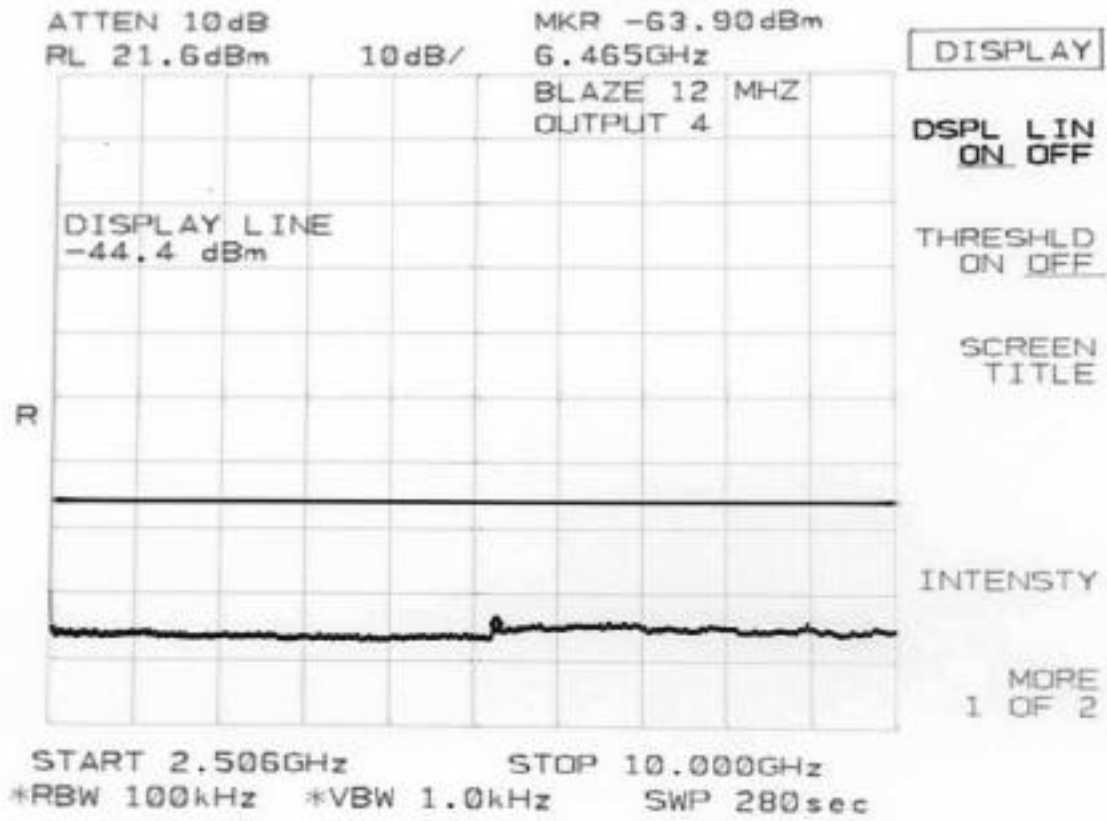
Antenna Conducted Emissions, 12 MHz Channel Bandwidth (2 of 7)



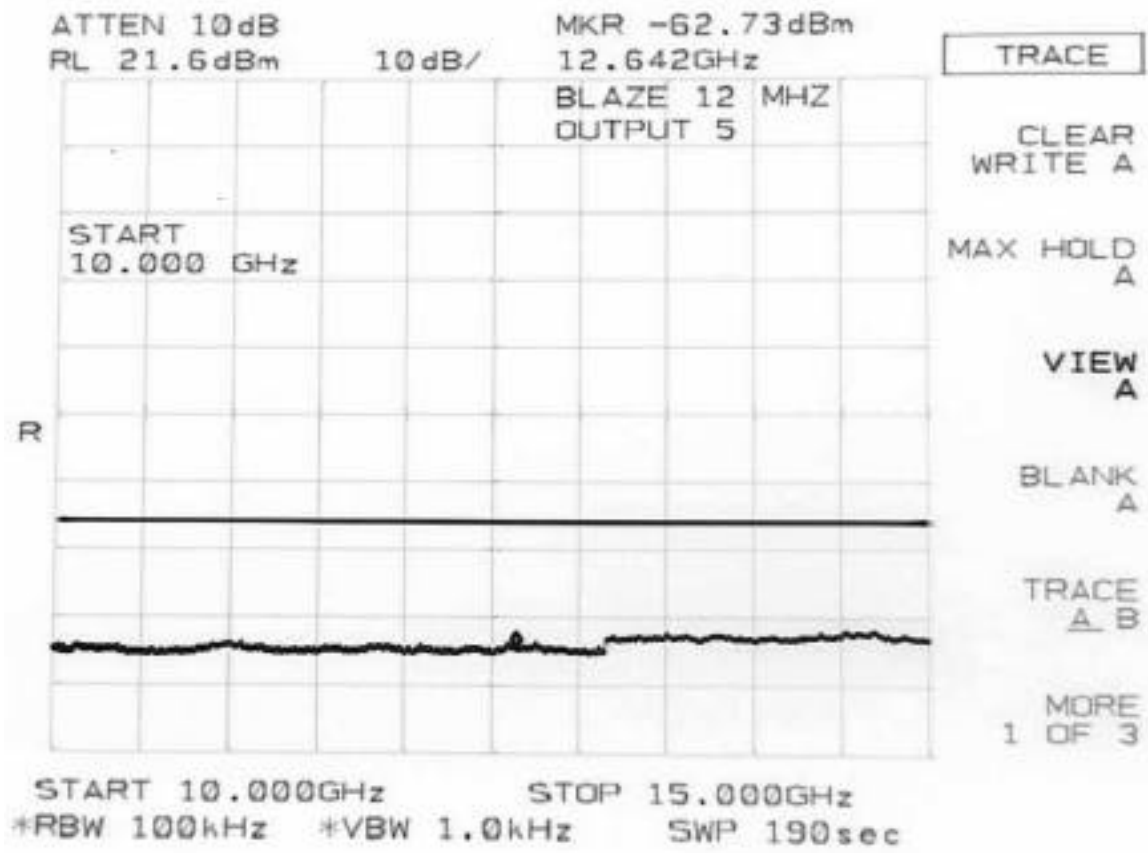
Antenna Conducted Emissions, 12 MHz Channel Bandwidth (3 of 7)



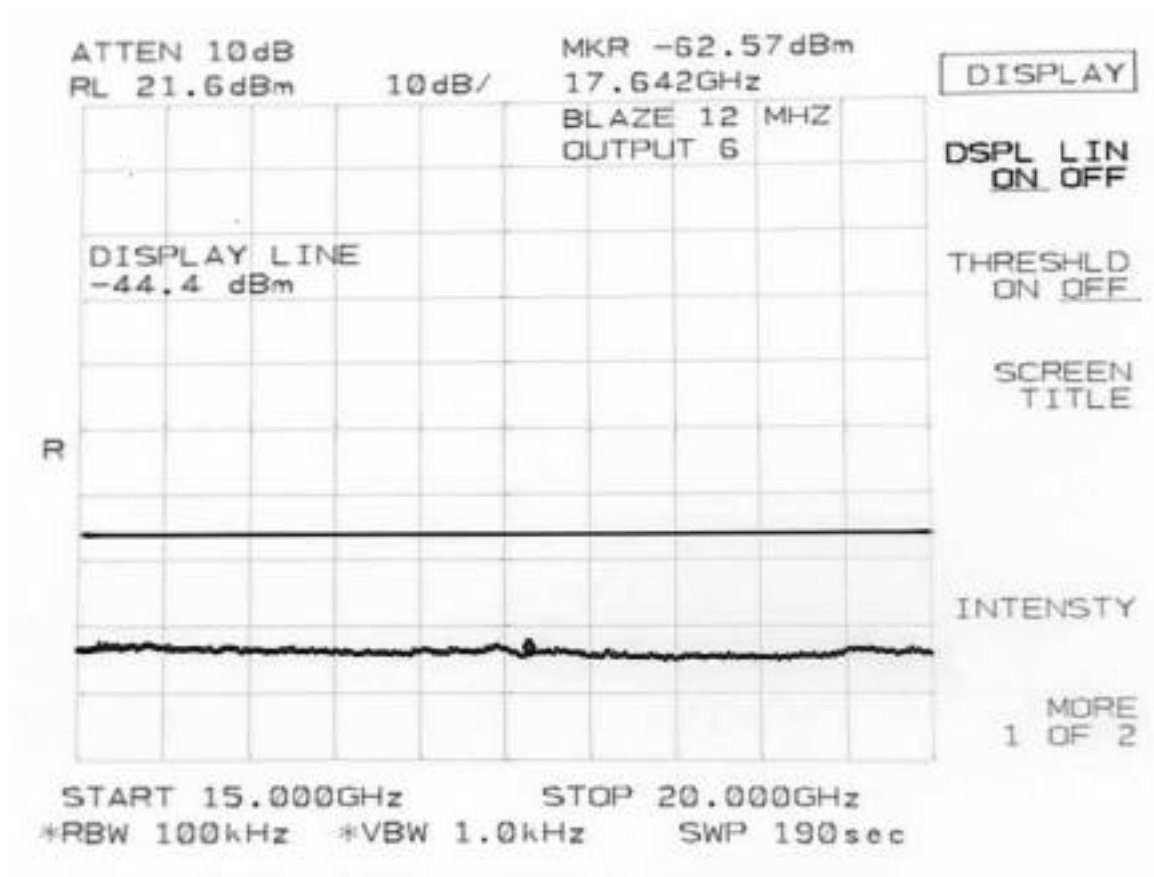
Antenna Conducted Emissions, 12 MHz Channel Bandwidth (4 of 7)



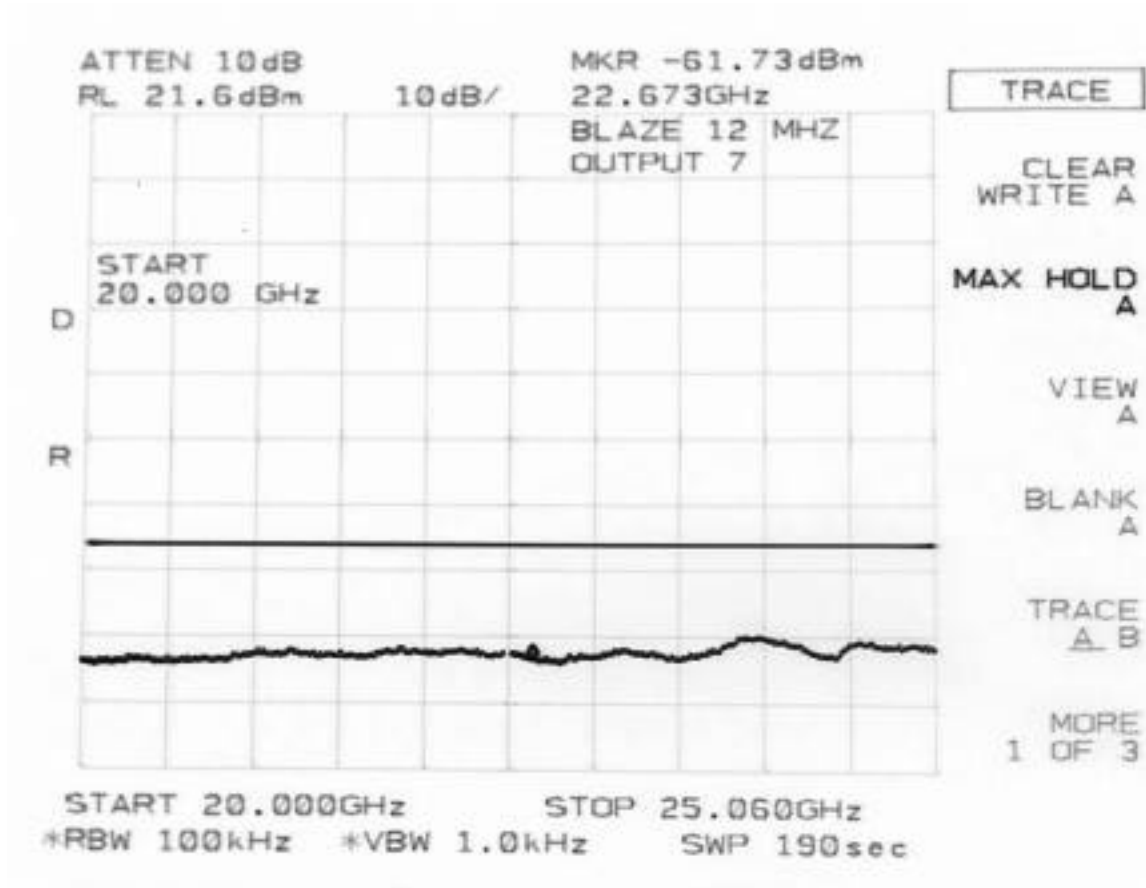
Antenna Conducted Emissions, 12 MHz Channel Bandwidth (5 of 7)



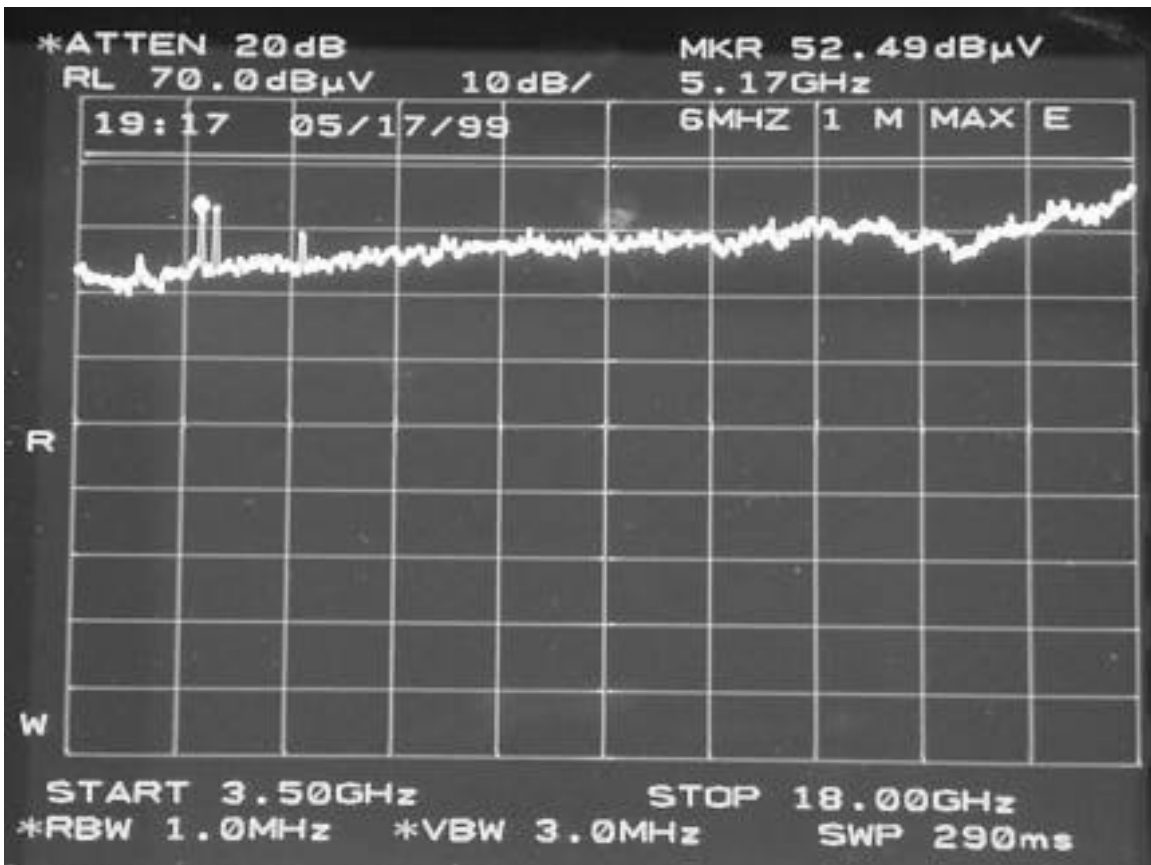
Antenna Conducted Emissions, 12 MHz Channel Bandwidth (6 of 7)



Antenna Conducted Emissions, 12 MHz Channel Bandwidth (7 of 7)



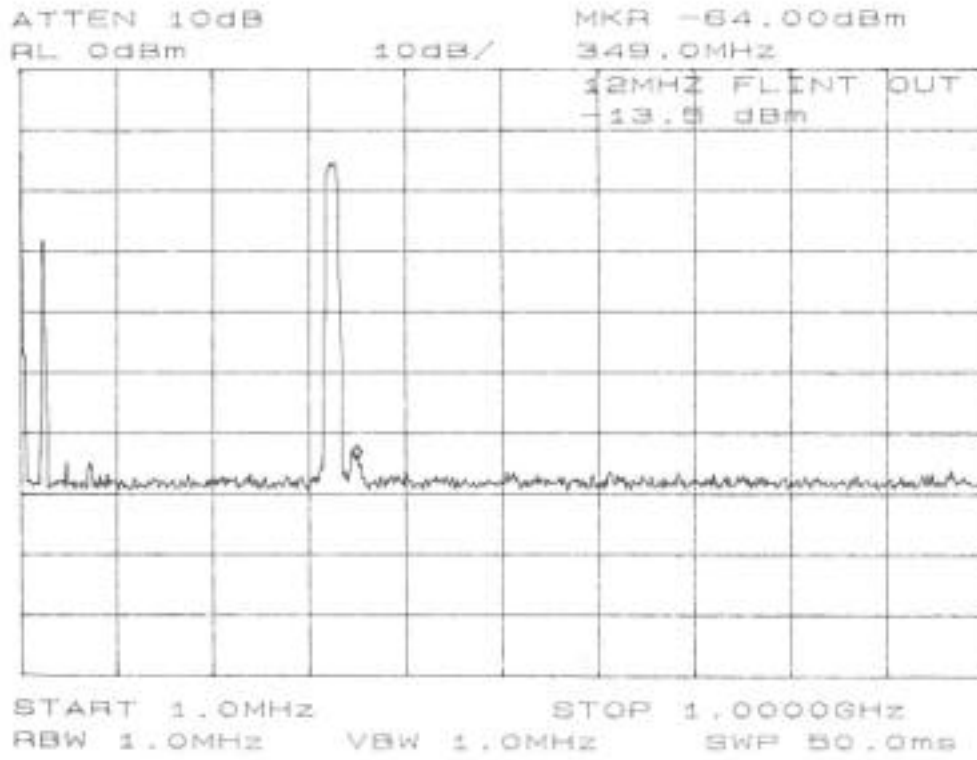
Case Radiated Emissions, 1 meter Separation



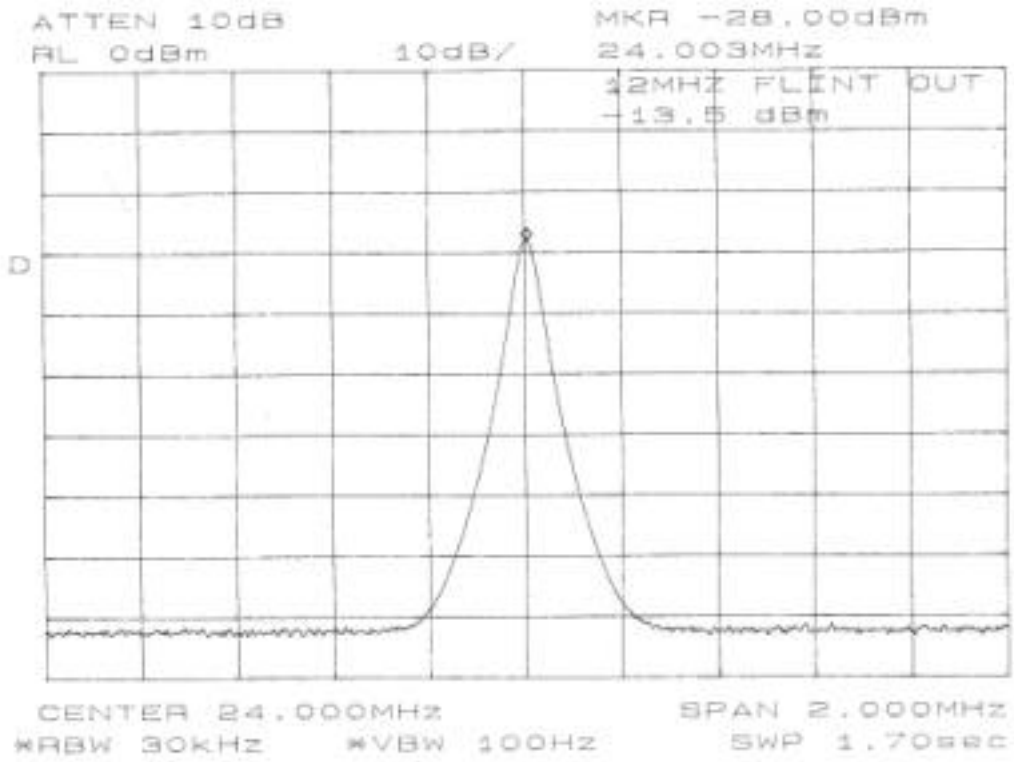
Case Radiated Emissions, 1 meter Separation

EXHIBIT 11 IF Card TX Signals to RF Module

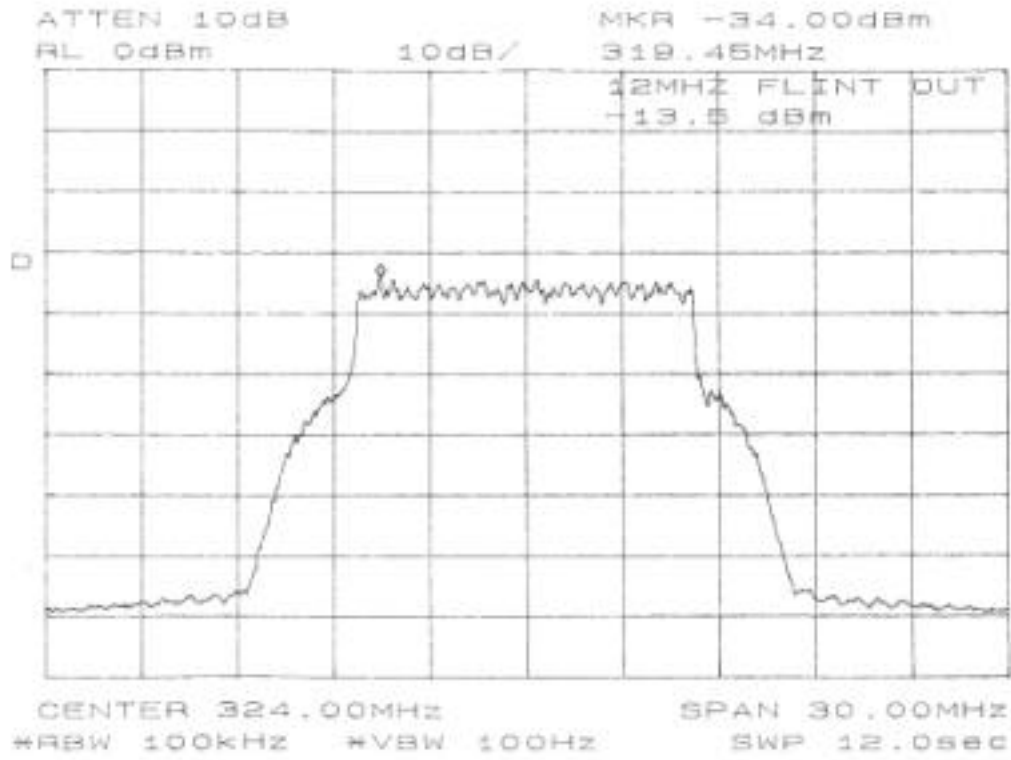
12 MHz output, 1 of 3



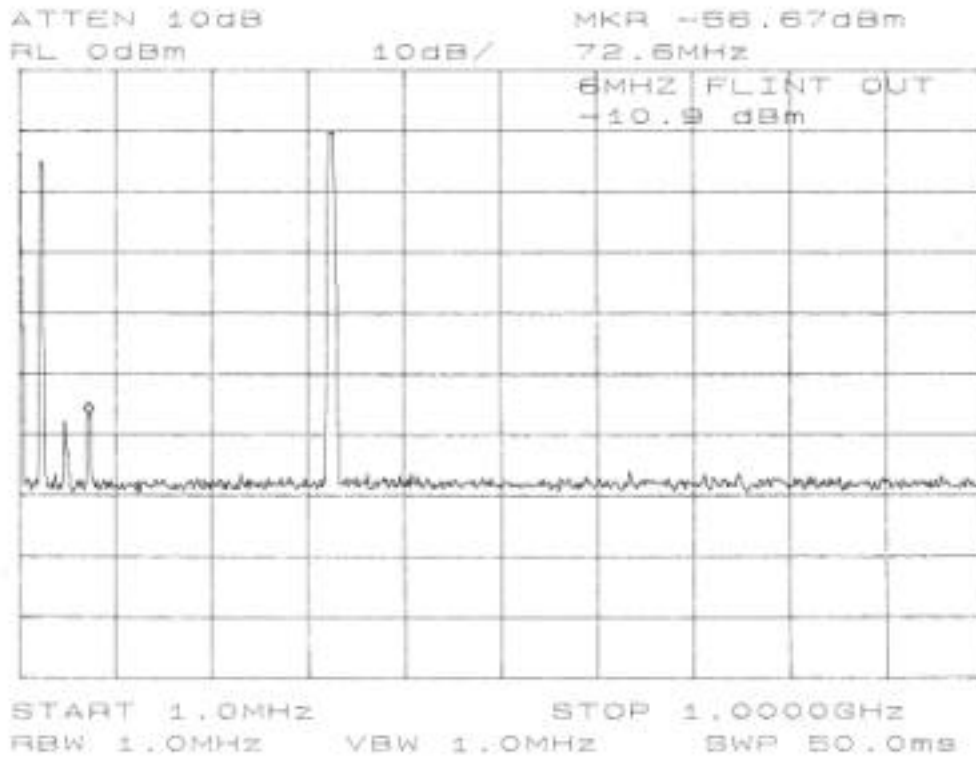
12 MHz output, 2 of 3



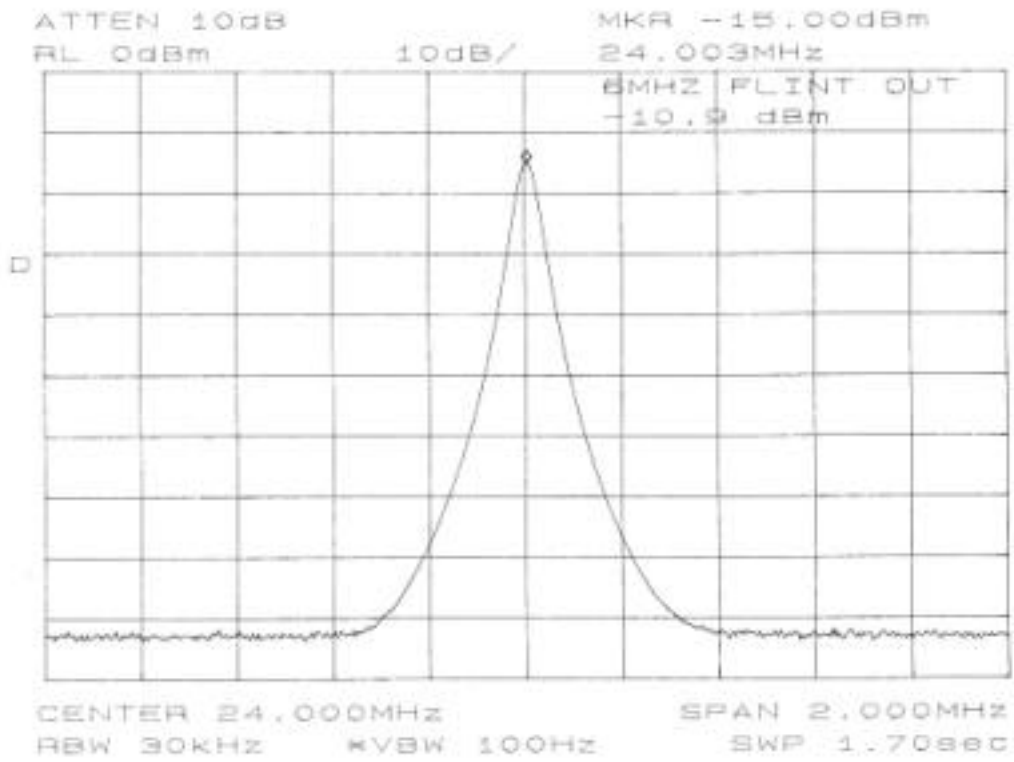
12 MHz output, 3 of 3



6 MHz output, 1 of 3



6 MHz output, 2 of 3



6 MHz output, 3 of 3

