

ITC2500-NA

User Manual V1.0

Contents

List of figures	4
List of tables	5
Glossary	6
1 Introduction	8
1.1 General information	8
1.2 Using the system	8
2 Safety notices	9
2.1 General safety measures	9
2.2 Precautions for handling the battery	10
2.3 Attaching the ITC2500 to a common antenna	10
3 Notices for Customers in the U.S.A and Canada	11
4 System description	12
4.1 ITC2500-NA hardware	12
4.2 Technical data	13
4.3 Functional description of the ITC2500-NA	15
4.3.1 Functional interfaces	15
4.3.2 Wave network configuration with ITC2500-NA	16
4.3.3 Multi-master wave network configuration with ITC2500-NA	16
4.3.4 Emergency operation in the multi-master wave network with ITC2500-NA	17
5 Installation	19
5.1 Turning the ITC2500-NA on/off	19
5.2 Getting started	19
5.3 Power supply	20
5.4 Fuses	20
5.5 Assembly	21
5.6 Electrical connections	21
5.7 Ambient conditions	21
5.8 Grounding and lightning protection	22
5.9 Maintenance instructions	23
5.10 Connecting the battery to the ITC2500-NA	23
5.11 Supplying external devices	24
5.12 Connecting one or two antennas	24
5.13 GPS: Connecting the GPS antenna to the master DAU	27

5.14	Connecting the I/O card to the DAU	31
5.15	Connecting the OIC card to the DAU (for I.SITE II connection)	32
6	Service web interface of the ITC2500-NA	34
6.1	Connection	34
6.2	Login and menu navigation	34
6.3	Monitoring	35
6.3.1	Status	35
6.3.2	Logging	37
6.4	Configuration	39
6.4.1	Base station	39
6.4.2	Paging Network Controller	43
6.4.3	Hardware	44
6.4.4	Network	45
6.5	Digital I/O	46
6.5.1	Digital inputs	46
6.5.2	Digital outputs	46
6.6	Service	46
6.7	Alerting	48
6.8	Appendix	49
6.8.1	TCP/IP port assignments	49
6.8.2	Error codes	49
7	Functional description of the individual components	58
7.1	Transmission/receiving unit (TRx 40/50W)	58
7.2	PS-200W power supply	59
7.2.1	PS200W power supply version, article no. 0710047	60
7.2.2	Battery operation (no mains network)	61
7.3	G-T16R Controller (BSC)	62
7.4	Synchro card (SC2000 0x500)	63
7.5	Digital decoder card (RC or RC09)	66
7.6	GPS receiver card	68
7.7	I/O card	69
8	Module replacement in a service situation	72
8.1	Important notes	72
8.2	Replacing the 12 V 12 Ah battery	72
8.3	Replacing the power supply (PS 150W/PS 150W-B)	73
8.4	Replacing the transceiver module (TRx 40/50W)	74

8.5	Replacing the controller (BSC)	75
8.6	Replacing the RC09 card	77
8.7	Replacing the SC card	78
8.8	Replacing the I/O card	79
9	Replacement/spare parts and optional cards	80

List of figures

FIGURE 1: ITC2500-NA, FRONT	12
FIGURE 2: ITC2500-NA, BACK.....	13
FIGURE 3: TYPICAL WAVE NETWORK WITH ITC2500-NA.....	16
FIGURE 4: MULTI-MASTER WAVE NETWORK WITH ITC2500-NA.....	17
FIGURE 5: EMERGENCY OPERATION IN A MULTI-MASTER WAVE NETWORK.....	18
FIGURE 6: GROUNDING POINT ON THE ITC2500-NA	22
FIGURE 7: CONNECTING THE BATTERY TO THE ITC2500-NA	23
FIGURE 8: CONNECTING EXTERNAL DEVICES TO BE SUPPLIED	24

FIGURE 9: REMOVING THE BACK PANEL FROM THE ITC2500-NA.....	25
FIGURE 10: JUMPER SETTINGS FOR ONE OR TWO ACTIVE ANTENNA PORTS.....	25
FIGURE 11: SLIDING SWITCH FOR ONE OR TWO ACTIVE ANTENNA PORTS.....	26
FIGURE 12: GPS RECEIVER CARD WITH AVAILABLE GPS ANTENNA AND HOLDER.....	27
FIGURE 13: GPS ANTENNA FROM TRIMBLE (LEFT) AND LIGHTNING PROTECTOR FROM HUBER+SUHNER (RIGHT).....	28
FIGURE 14: HOLDER (NON-BINDING ILLUSTRATION).....	29
FIGURE 15: CONNECTING THE I/O CARD TO THE ITC2500-NA.....	31
FIGURE 16: CORRECTLY CONNECTING THE OIC CARD TO THE SC CARD.....	32
FIGURE 17: REMOVING THE BACK PANEL FROM THE ITC2500-NA.....	33
FIGURE 18: UNPLUGGING THE WIDE RIBBON CABLE FROM THE INTERFACE PRINT ON THE TRX MODULE.....	33
FIGURE 19: LOGIN.....	35
FIGURE 20: MONITORING > STATUS.....	36
FIGURE 21: MONITORING > LOGGING.....	37
FIGURE 22: CONFIGURATION > DAU (GENERAL).....	40
FIGURE 23: CONFIGURATION > SEGMENT AND SCENARIO SETTINGS.....	41
FIGURE 24: CONFIGURATION > DAG.....	43
FIGURE 25: CONFIGURATION > HARDWARE.....	44
FIGURE 26: CONFIGURATION > NETWORK.....	45
FIGURE 27: DIGITAL I/O > DIGITAL INPUTS.....	46
FIGURE 28: SERVICE.....	47
FIGURE 29: ALERTING.....	48
FIGURE 30: TRANSMISSION/RECEIVING UNIT (TRX 40/50W).....	58
FIGURE 31: POWER SUPPLY (PS200W).....	60
FIGURE 32: ITC2500 OPERATION DEPENDING ON FALLING BATTERY VOLTAGE.....	61
FIGURE 33: CONTROLLER (BSC).....	62
FIGURE 34: SYNCHRO CARD (SC).....	63
FIGURE 35: PIN ASSIGNMENT OF THE OPTOCOUPLER OUTPUT ON THE SC CARD.....	64
FIGURE 36: PIN ASSIGNMENT OF THE OPTOCOUPLER INPUTS ON THE SC CARD.....	65
FIGURE 37: DIGITAL DECODER CARD (RC OR RC09).....	66
FIGURE 38: GPS RECEIVER CARD.....	68
FIGURE 39: I/O CARD.....	69
FIGURE 40: PIN ASSIGNMENT OF THE OPTOCOUPLER INPUTS ON THE I/O CARD.....	70
FIGURE 41: PIN ASSIGNMENT OF THE RELAY OUTPUTS ON THE I/O CARD.....	71
FIGURE 42: READING THE VALUES 'RSSI LOW'/'RSSI HIGH' AND 'DELAY RX'/'DELAY RX'.....	74
FIGURE 43: CHECKING THE KERNEL VERSION.....	75
FIGURE 44: CONTROLLER WIRING.....	76
FIGURE 45: WIRING OF THE RC OR RC09 CARD.....	77
FIGURE 46: WIRING OF THE SC CARD.....	78

List of tables

TABLE 1: MONITORING > STATUS.....	37
TABLE 2: MONITORING > LOGGING.....	39
TABLE 3: CONFIGURATION > BASIC DAU PARAMETERS.....	41
TABLE 4: CONFIGURATION > DAU SEGMENTS.....	43
TABLE 5: CONFIGURATION > DAU SCENARIOS.....	43
TABLE 6: CONFIGURATION > DAG.....	44
TABLE 7: CONFIGURATION > HARDWARE.....	45
TABLE 8: CONFIGURATION > NETWORK.....	45
TABLE 9: DIGITAL I/O > SETTINGS.....	46
TABLE 10: SERVICE.....	48
TABLE 11: ALERTING.....	48
TABLE 12: TCP/IP PORT ASSIGNMENTS.....	49
TABLE 13: OVERVIEW OF DAU ERROR CODES.....	57
TABLE 14: FUNCTIONAL DESCRIPTION OF THE POWER SUPPLY LEDS.....	60
TABLE 15: FUNCTIONAL DESCRIPTION OF THE CONTROLLER LEDS.....	62

TABLE 16: FUNCTIONAL DESCRIPTION OF THE SC CARD LEDs.....	64
TABLE 17: FUNCTIONAL DESCRIPTION OF THE RC CARD LEDs	67
TABLE 18: STATUS DISPLAYS OF THE RSSI LEDs	67
TABLE 19: REPLACEMENT/SPARE PARTS AND OPTIONAL CARDS	80

Glossary

AC	Alternating current
BC	Broadcast (telegram type for regular broadcast transmission)
BS	Base station (=ITC)
BSC	Base station controller
COM	Serial interface
CPU	Central processing unit (processor)
DAG	Digital alerting device
DAU	Digital alert converter (used as generic name for ITC)
DFSK	Digital Frequency Shift Keying (digital frequency modulation)
DME	Digital message receiver
EC	European Community
EMS	Electromagnetic safety
EMC	Electromagnetic compatibility
ETSI	European Telecommunications Standards Institute
HD	Hard disk
RU	Rack unit (1RU = 44.45mm)
HF	High frequency

HW	Hardware
IDE	Integrated drive electronics (interface between hard disk and computer)
ITC	Intelligent transceiver controller (Swissphone base station)
LAN	Local area network
LED	Light emitting diode
PNC	Paging network controller
POCSAG	Post Office Code Standardisation Advisory Group
PS	Power supply
PWR	Power
RAM	Random access memory
RSSI	Received signal strength indicator (indicator of the field strength at the receiver)
RIC	Radio identification code (paging address)
R&TTE	Radio and telecommunications terminal equipment
RED	Radio Equipment Directive
Rx	Receiver
SINAD	Signal to noise and distortion
SW	Software
TCP/IP	Transmission Control Protocol/Internet Protocol
HP	Horizontal pitch (1 HP = 5.08 mm)
TRx	Transceiver (transmitter and receiver)
Tx	Transmitter
USB	Universal serial bus
VAC	Voltage alternative current (alternate current)
VDC	Voltage direct current
VGA	Video Graphics Array (a graphics standard)
VHF	Very high frequency
WBC	Wide broadcast (telegram type for fallback emergency broadcast transmission)

1 Introduction

This manual describes the installation, configuration, operation and maintenance of the ITC2500-NA at service level 2 (on a module exchange basis).

1.1 General information

This manual was written for experienced technicians with the skills required to install these systems.

Note: Software and hardware modifications are possible at any time and will be taken into account in future editions of this manual, where applicable.

This manual applies to software Version **5.2** or higher.

1.2 Using the system

The ITC2500-NA is a digital paging base station that receives digital POCSAG alerts synchronously in a radio network and sends them back out again. A synchronous radio paging network can be set up with this digital alert converter.

2 Safety notices

Important:

The ITC2500-NA may only be opened by personnel trained and authorised by Swissphone!

The manufacturer assumes no liability for damage or injuries caused by failure to observe these safety notices or by improper handling of the device!

2.1 General safety measures

- Do not operate the transmitter if individuals are present in the immediate vicinity of the antenna (minimum distance 2 m).
- All devices must be maintained exclusively by a qualified service technician.
- The base station may only be put into operation by Swissphone and a Swissphone contractual or sales partner or by individuals authorised by Swissphone.
- Only put the base station into operation after all open ports have been properly closed and the HF connections have been established.
- The device has to be set up or mounted in a rack so that all phases can be disconnected from the mains network in case of an emergency and for service. The mains plug or equipment plug must be accessible. Another option would be a switch in the building wiring close to the device.
- Only devices that comply with the applicable safety standard (EN 60950-1:2001) may be connected to the ITC2500-NA.
- Only operate the device on a network with 90 V–260 VAC, 50-60 Hz.
- Only operate the base station inside buildings where it is protected against lightning strikes, water and direct sunlight.
- Due to the risk of electric shock, do not open the device unless you have been trained and authorised accordingly by Swissphone.
- Ensure that no moisture, vapours or liquids can get into the device. Do not keep liquids in the vicinity of the device. Do not use any liquid cleaning agents. They may damage the device or cause an electric shock.
- Do not install the device in the vicinity of heat sources.
- To prevent damage to the device and avoid the risk of injury, only use original parts or parts recommended by your specialist dealer. Failure to observe this warning voids the device warranty. Repairs and any other modifications may only be carried out by qualified personnel.

2.2 Precautions for handling the battery

Note the following precautions:

- Never expose the battery to open flames.
- Do not short circuit the connection contacts.
- Do not open the battery.
- If diluted sulphuric acid from a damaged battery comes into contact with the skin or clothing, rinse with water immediately. If diluted sulphuric acid gets into the eyes, rinse immediately with plenty of water and consult a doctor.
- Always read the corresponding instructions before using the battery.
- We recommend replacing the battery every three to five years.
- Charge the battery as soon as possible after it is discharged.
- Do not store the battery in the vicinity of fire.
- Lead acid batteries generally self-discharge by three to five per cent per month. The discharge curve of the battery used by Swissphone (pbq 12-12) is relatively flat up to 80 per cent of the nominal capacity and drops at an increasing rate afterwards. We do not recommend allowing the battery to self-discharge to less than 60 per cent of the remaining capacity. This corresponds to a no-load voltage of approximately 12.6 V (battery not connected). The battery should be charged at this point.
- If the battery is not going to be used for an extended period of time, store it in a cool place, but not below 0°C!
- Charge the battery at least once every six months.
- Do not put partly discharged batteries into storage.

Note: If the digital alert converter is to be stored for an extended period of time, Swissphone recommends disconnecting the battery from the digital alert converter to prevent possible fast discharge of the battery.

2.3 Attaching the ITC2500 to a common antenna

In case of common site installation, a waveguide circulator has to be used. Without additional circulator, the ITC2500 is only single-site compliant.

3 Notices for Customers in the U.S.A and Canada

NOTICE:

This device complies with Part 15 of the FCC Rules. For Canada, CAN ICES-3 (A)/NMB-3(A) applies. Operation is subject to the following two conditions:

- (1) this device may not cause harmful interference, and
- (2) this device must accept any interference received, including interference that may cause undesired operation.

NOTICE:

Changes or modifications made to this equipment not expressly approved by Swissphone may void the FCC authorization to operate this equipment.

FCC Radio Frequency Interference Statement:

NOTE: This equipment has been tested and found to comply with the limits for a Class A digital device, pursuant to Part 15 of the FCC Rules. These limits are designed to provide reasonable protection against harmful interference when the equipment is operated in a commercial environment. This equipment generates, uses, and can radiate radio frequency energy and, if not installed and used in accordance with the instruction manual, may cause harmful interference to radio communications. Operation of this equipment in a residential area is likely to cause harmful interference in which case the user will be required to correct the interference at his own expense.

Class A digital device: A digital device that is marketed for use in a commercial, industrial or business environment, exclusive of a device which is marketed for use by the general public or is intended to be used in the home.

4 System description

4.1 ITC2500-NA hardware

Front:



Figure 1: ITC2500-NA, front

The ITC2500-NA consists of the following components (modules):

- 1) Power supply (PS 200W)
- 2) Base station controller (G-T16R)
- 3) GPS card
- 4) POCSAG decoder card (RC09)
- 5) Synchro card (SC2000 0x500)
- 6) I/O card (SC2000 extension)
- 7) Dummy plates
- 8) Transmitter/receiver (TRx 50W)

Back:

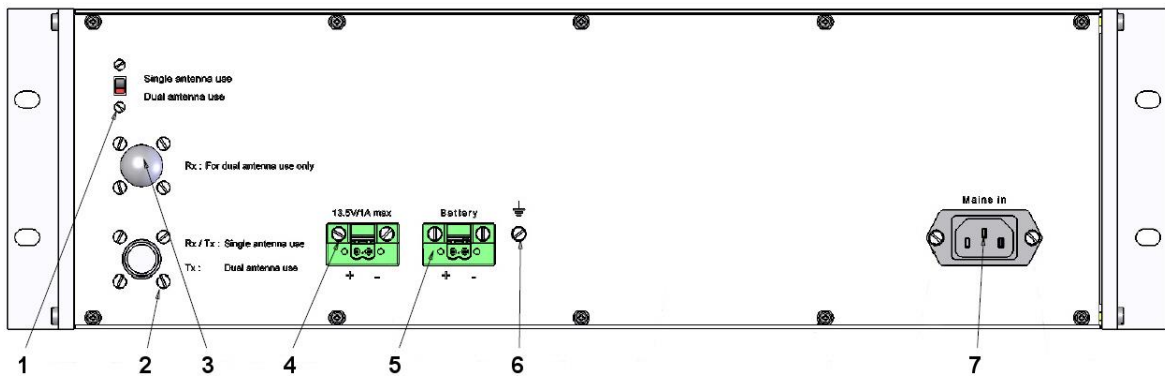

Figure 2: ITC2500-NA, back

The following connections are found on the back of the ITC2500-NA:

- 1) Sliding switch¹ for using one or two antenna ports
- 2) Coaxial connection type N, 50 Ohm, respectively for transmitting (Tx) and receiving (Rx) in single-antenna operation (standard) or for transmission antenna (Tx) in dual-antenna operation
- 3) Coaxial connection type N, 50 Ohm, for receiving antenna (Rx) in dual-antenna operation
- 4) Screw-type terminal connection to supply external devices with 13.5 V/1 A max.
- 5) Screw-type terminal connection for the external battery Pb 12 V/12 Ah (Battery)
- 6) Battery ground connection
- 7) Mains connection 230 V (Mains in)

4.2 Technical data

Type:	ITC2500-NA
Dimensions (WxHxD):	483 mm (19" rack) x 134 mm (3RU) x 315 mm
Weight:	8.5 kg
Protection type:	IP 20/IP42 ²
Temperature range:	-25 to +55°C
Power supply:	90–264 VAC/ 47–63 Hz
Mains fuse:	T4 A/250 V
Emergency power supply:	External backup battery 12 V
Backup fuse:	T12.5 A/250 V
Battery operation:	>4h at 25W transmitting power and Tx:Rx = 1:4 (@ 12 Ah battery)
Power consumption:	Max. 200 W
Frequency band:	VHF: 136–174 MHz UHF: 400–470 MHz

¹ Internal jumpers are used to configure the setting on DAU versions without a sliding switch

² IP42 when base station is installed in wall housing

	UHF: 450-520 MHz
Transmitting power:	VHF: 10-50W, UHF: 10-40W
Transmission rates:	512/1200/2400 bps
Channel spacing:	12.5 kHz
Conformity:	ETS 300113, ETS 300086, EN 60950, EN 50081-2, EN 50082-2, EN 61000-3-2/3

4.3 Functional description of the ITC2500-NA

4.3.1 Functional interfaces

Interfaces on the master ITC:

Purpose	ITC input		ITC output	
	HW interface	Protocol	HW interface	Protocol
Alerting/ monitoring	Ethernet RJ45	Swissphone protocol ³ via TCP/IP	N-type 50Ω	POCSAG on paging frequency
Alerting	RS232 D-Sub9	MIP11++ ⁴		

Interfaces on the slave ITC:

Purpose	ITC input		ITC output	
	HW interface	Protocol	HW interface	Protocol
Alerting/ monitoring	N-type 50Ω	POCSAG on paging frequency	N-type 50Ω	POCSAG on paging frequency
Alerting (on next rings)	RS232 D-Sub9	MIP11++		

3 This protocol is used by Swissphone alerting devices (for instance, Digicom). A control centre can communicate with the Swissphone alerting device using the public Swissphone TMIP protocol to send an alert.

4 Swissphone public access protocol

4.3.2 Wave network configuration with ITC2500-NA

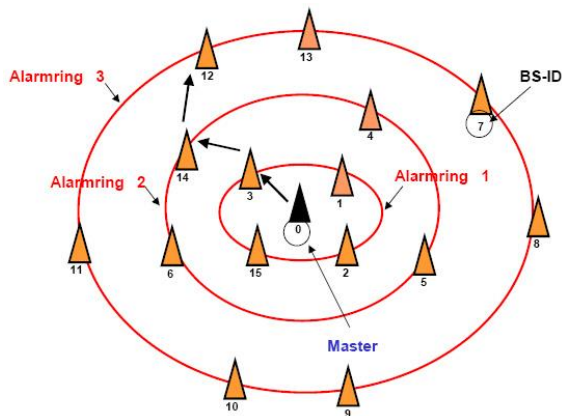

Figure 3: Typical wave network with ITC2500-NA

The transmission data is transmitted by a digital alerting device (DAG) directly to the master DAU (DAU 0) using a TCP/IP protocol. It transmits the incoming alert via radio. The digital message receivers (DMEs) within the radio coverage of the master DAU are alerted. The slave DAUs on alert ring 1 receive the alerts at the same time. These DAUs synchronously transmit the alert message via radio to each other once it has been received completely. The message receivers within the radio coverage of the transmitting slave DAUs are alerted. The slave DAUs on alert ring 2 receive the alert at the same time and so on, passing on the alert through the entire coverage area.

In addition to alerting, it is possible to query or configure the entire network or each individual DAU with targeted system messages.

4.3.3 Multi-master wave network configuration with ITC2500-NA

The fundamental idea of multi-master networks is to alert large regions quickly. When multiple subnets (for instance, several regions) that each consist of a wave network with a master DAU are linked, alerting is synchronised from a central, supra-regional control centre. Multi-master mode makes it possible to alert a larger region consisting of linked subnets in the same alerting time. The master DAUs of the subnets receive the alert data and the precise transmission time from the control centre. At the specified transmission time, the master DAUs transmit their alerts in a bit-synchronous manner by synchronising the transmission using a time reference (for example, via GPS).

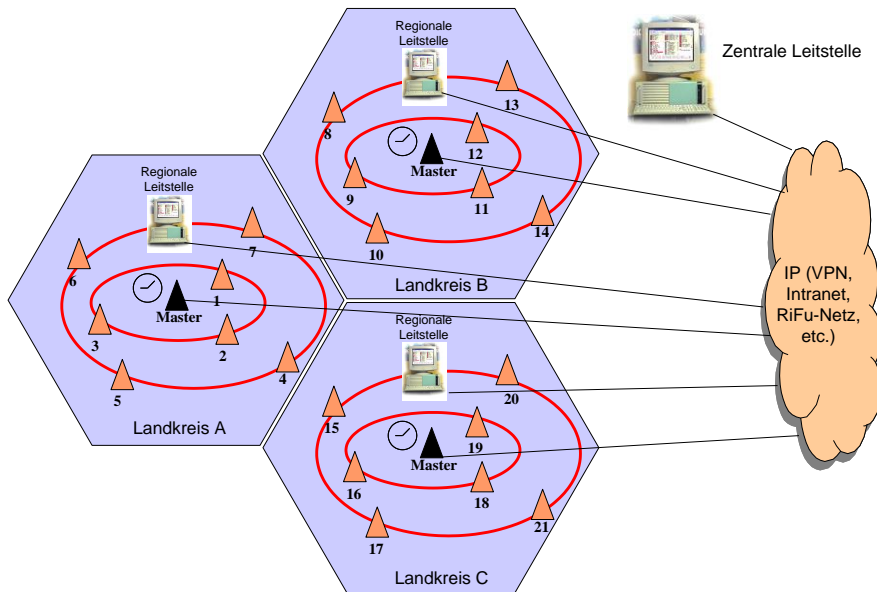

Figure 4: Multi-master wave network with ITC2500-NA

4.3.4 Emergency operation in the multi-master wave network with ITC2500-NA

If the connection between the control centre and one or multiple master DAUs fails or if the time reference is disrupted, full-coverage transmission in emergency operation takes place via the remaining master DAU connections. Information about emergency operation is transferred from the control centre to these master DAUs. They transmit the information in the current alert message to the slave DAUs.

The alert messages received by the slave DAUs are forwarded respectively for a certain alerting ring. Instead of only forwarding incoming messages that belong to the assigned alerting ring as in normal operation, they now also transmit if the alert is destined for a higher ring and it has not sent the message yet. Since the number of rings is higher in emergency operation (1–16), the message is distributed in subnets with failed master DAUs as well.

Example:

Assumptions as shown in the figure below: The master DAUs for districts B and C cannot transmit synchronously (connection failure, time reference disruption). The alerting device only reaches the master DAU for district A. This master DAU sends the alert message with emergency operation information to its slave DAUs through the ring structure (①). The slave DAUs of the other districts B and C, adjacent to district A, are now addressed by the slave DAUs of district A (①+②+③) as though they were stations on an additional ring, and in turn send the message on once more.

Information/figure below:

- District B describes the situation where all slave DAUs on the first ring can hear the master A. Some slave DAUs on the second ring also hear the master A, but ignore the message since it is intended for the first ring. Alerting in district B is in ring form as usual, meaning that the slave DAUs of the first ring send the alert first, followed by the slave DAUs of the second ring.
- District C describes the situation where not all slave DAUs on the first ring hear the master A. Those slave DAUs on the first ring that can hear the message of the master A in turn send the message to the slave DAUs of the second ring and those slave DAUs of the first ring that have not heard the message yet. This way, all slave DAUs that have not heard the message yet send it on.

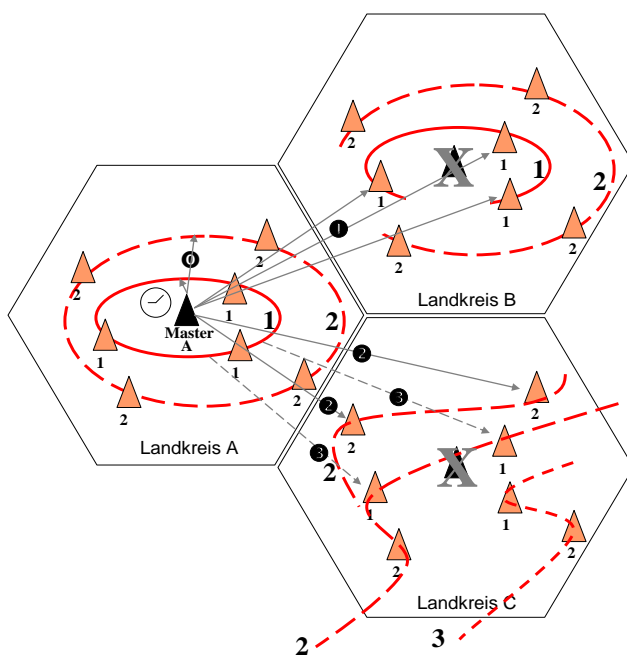

Figure 5: Emergency operation in a multi-master wave network

5 Installation

5.1 Turning the ITC2500-NA on/off

Turn on the ITC2500-NA:

1. Set the main switch to position 1.
2. The ITC2500-NA is fully powered up when all LEDs on the RC and SC card light up twice in succession.

Turn off the ITC2500-NA:

The ITC2500-NA can also be powered down without using the service web interface: Follow these steps:

1. Push the black button on the SC card for more than seven seconds and then release it.
2. The transmit and status LEDs on the SC card flash briefly. If this is not the case, repeat step one.
3. Wait until the transmit and status LEDs on the SC card are lit continuously. The ITC2500-NA is now powered down and can be turned off.
4. Set the main switch to position 0.

5.2 Getting started

Proper assembly and installation are essential for the safe operation of the DAU. Assembly and installation require careful preparation. The ambient conditions at the location, the installation type and the required tools and materials have to be considered.

Installation steps:

Step 1) Planning

- Plan the assembly and installation considering the ambient conditions at the installation location. Adequate ventilation, grounding and lightning protection (see Section 5.8) are required. Pay special attention to ventilation for rack installation.

Step 2) Preparing the DAU

- Inspect the delivery for integrity and damage.
- During transportation, the power supply should be switched off and the battery disconnected from the DAU.
- Add to the DAU with any optional modules:
 1. Install the GPS interface card (S-Com card) if the DAU is to be used as a multi-master DAU (see Section 5.13).
 2. Install the I/O card if the DAU is being expanded from expansion stage I to II (see Section 5.14).
- Activate the internal antenna switch if separate transmitting and receiving antennae are used (see Section 5.12). The antenna switch is inactive by default (meaning only the bottom Tx antenna port is active). This corresponds to using a single transmission and receiving antenna that is screwed to the bottom Tx antenna port.
- Configure the DAU as far as possible using the service web interface.

Step 3) Installation on site

- If the DAU is being used as a master DAU:
 1. Connect a high-quality LAN cable (min. Cat5) to the RJ45 Ethernet interface on the controller for DAU and network control.
 2. Connect the GPS antenna to the GPS interface card if the DAU is being used as a multi-master DAU (see Section 6.6).
- Establish the communication connections:
 3. Connect the input and output lines to the synchro card or the optional I/O card (see Section 6.4 or 6.7).
 4. In case of a local redundancy alerting device: Connect the local alerting device to the serial interface of the controller (communication protocol: MIP11+).
 5. Connect the coaxial cable of the transmission and receiving antenna (see Section 5.12).
- Establish the supply connections:
 6. Connect the fully charged battery (see Section 5.10).
 7. Connect a device to be supplied externally, if needed (see Section 5.11).
 8. Connect the power cable (mains switch of the DAU turned off; position 0).
 9. Turn on the DAU with the mains switch (position 1).
- Perform the final DAU configuration through the service web interface.

Step 4) Functional test

10. The green LEDs of the PS 150W, BSC, RC and SC all have to be lit.
 - If the red power supply LED is flashing, check the battery fuse by first turning off the mains switch and then checking the battery fuse and replacing it if needed.
 - If the yellow power supply LED is lit, the battery is too weak and has to be charged.
11. Check the status display in the service web interface of the DAU. None of the fields in the status window except *Receiver (Rx)* should be marked red. The status of this field changes to green as soon as the DAU is used in the network and receives messages with a sufficient field strength from a neighbouring DAU.
12. Send a test message to a local pager or neighbouring DAU.

Warning:

Improper handling of the base station can lead to injuries or damage to the system.

5.3 Power supply

The DAU can be operated with 90–264 V alternate current. The maximum power consumption is 150 W/1.7 A. Much higher currents may flow briefly upon switching when the power supply is activated. National installation regulations (state of the art) must be observed. The DAU must be connected to the mains network with a three-core cable and protective conductor with a minimum cross-section of 1 mm².

5.4 Fuses

The DAU is protected by two fuses that may only be replaced by trained personnel. The mains fuse is installed in the AC/DC power supply and can only be replaced by Swissphone. A separate fuse protects the emergency power supply. It is installed above the power supply switch on the front of the ITC2500-NA. Fuse specifications:

Mains fuse: T 4A/250V (**can only be replaced by Swissphone**)

Battery fuse: T 12.5 A/250 V

5.5 Assembly

The DAU is intended for installation in a 19" rack. The ITC2500-NA requires three RU in a 19" rack with a depth of 315 mm.

5.6 Electrical connections

After the ITC2500-NA is installed, for instance, in a wall cabinet, the electrical connections still have to be established: These are:

- Mains cable
- VHF coaxial antenna cable (50Ω /N-plug)
- For master DAU, min. cat. 5 cable.
- For multi-master DAU, RS485 cable
- Cable for input/output contacts

5.7 Ambient conditions

The ITC2500-NA can be installed in any location that is suitable for electronic communication equipment. In general, the following limit values must not be exceeded:

Operating temperature range: -25°C to +55°C

Relative humidity: max. 80%

5.8 Grounding and lightning protection

Warning:

Proper grounding and secure lightning protection are extremely important to prevent damage to the ITC2500-NA.

Grounding and lightning protection are related to one another. The following categories can be formed:

- Electrical grounding:
This refers to the ground conductor for potential equalisation of any fault current, for example, from the housing to the installation.
- HF grounding:
This refers to the discharge of HF energy against ground. Shielding fins that prevent or reduce the emission of HF radiation are an example of HF grounding.
- Lightning protection grounding:
Good lightning protection is essential for the safe and reliable operation of a communication system. This is closely related to building potential equalisation.

This manual does not provide comprehensive recommendations and directives for the grounding and lightning protection of communication systems. This information is compiled in the relevant publications from various manufacturers. Please refer to them as needed.

The figure below shows the grounding point on the ITC2500-NA (to be used for installation in a housing, for example):



Figure 6: Grounding point on the ITC2500-NA

5.9 Maintenance instructions

The ITC2500-NA is manufactured using state-of-the-art technology and features software-based control. As a result, virtually no regular maintenance is required.

The following tasks should be completed during maintenance:

- Wipe the station with a soft cloth
- Measure the output
- Measure the frequency (carrier, hub)
- Check the battery state (after 10 minutes of battery operation: battery >12 V)
Note: The battery recommended by Swissphone (pbq 12-12) should be replaced at least once every three years (battery replacement, see Section 5.10).
- Check electrical connections (for instance, antenna ports)
- Check the status of the power supply (LED green)
- Check the battery fuse
- Check the controller (LED green)
- Check the synchro card and decoder card (LED green)
- Check the system status in the status window of the service web interface

5.10 Connecting the battery to the ITC2500-NA

The battery is connected to the battery terminals (labelled *Battery*) on the rear of the ITC2500-NA. The minimum specified cable diameter is 1.5 mm². Swissphone uses a standard 12 V/12 Ah battery (pbq 12-12). The charging current is limited to 2 A.

- Important:**
- Swissphone recommends the following maximum battery capacity:
12 V/65 Ah
 - The battery voltage must never exceed 16 V, otherwise there is a risk of damaging the device. The battery voltage must never be lower than 10.6 V.
 - Never connect the battery under load. The power supply (PS150W) always has to be turned off (switch position 0) before connecting the battery.

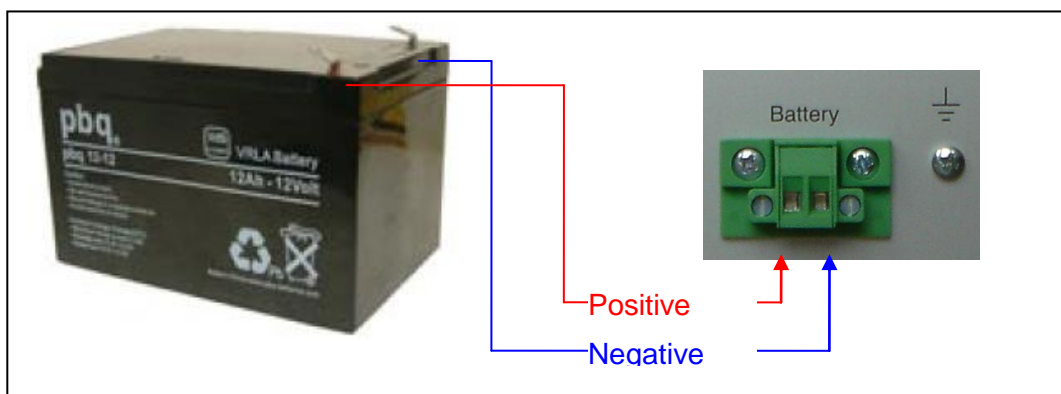

Figure 7: Connecting the battery to the ITC2500-NA

Operating mode:	Power consumption of the DAU on the battery connection (DC):
Standby (Rx only)	9 W
Tx 1 W	24 W
Tx 5 W	37 W
Tx 12 W	50 W
Tx 25 W	75 W
Tx 50 W	

5.11 Supplying external devices

It is also possible to supply external devices with the DAU. The device is connected to the terminal labelled *13.5 V/1 A max* on the rear of the ITC2500-NA. The minimum specified cable diameter is 1.5 mm². An external device can be supplied with a maximum of 13.5 V/1 A.

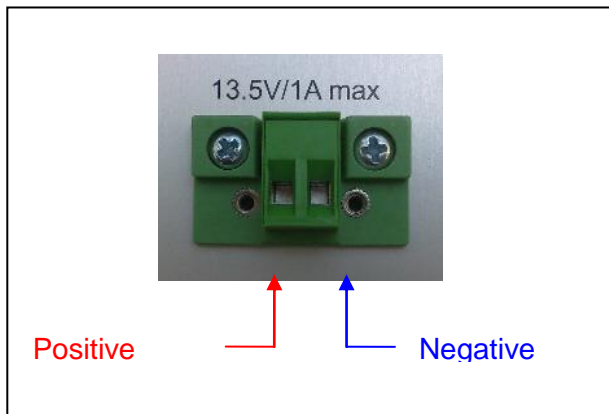

Figure 8: Connecting external devices to be supplied

Note: Supplying an external device puts an added load on the battery in the event of a power failure and as a result, the amount of time the battery is capable of supplying the DAU for is reduced.

5.12 Connecting one or two antennas

The ITC2500-NA is configured for one antenna by default, with the transmitting and receiving antenna connected to the lower antenna port. Reconfigure the DAU as follows to connect two antennas, one for transmitting and one for receiving.

Version with antenna setting via jumper:

1. Turn off the device and disconnect the mains plug and battery.
2. Remove the back panel from the ITC2500-NA by loosening the ten screws.



Figure 9: Removing the back panel from the ITC2500-NA

3. Carefully tilt the back panel downwards.

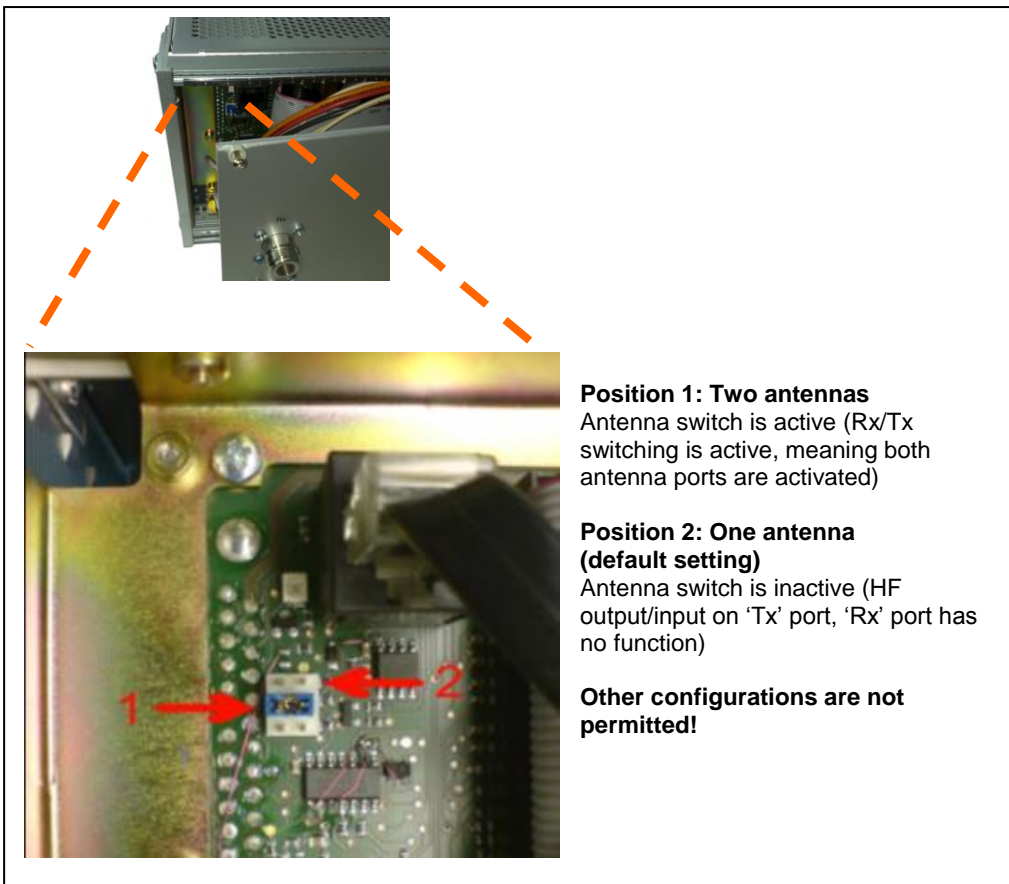

Figure 10: Jumper settings for one or two active antenna ports

4. To use two antenna ports, change the jumper to position 1 (see figure above).
5. Reinstall the back panel.
6. Connect the mains plug and battery and put the DAU back into operation.

Version with antenna setting via sliding switch:

1. Turn off the device.

2. To use two antenna ports, set the sliding switch to position 1 (see figure below).

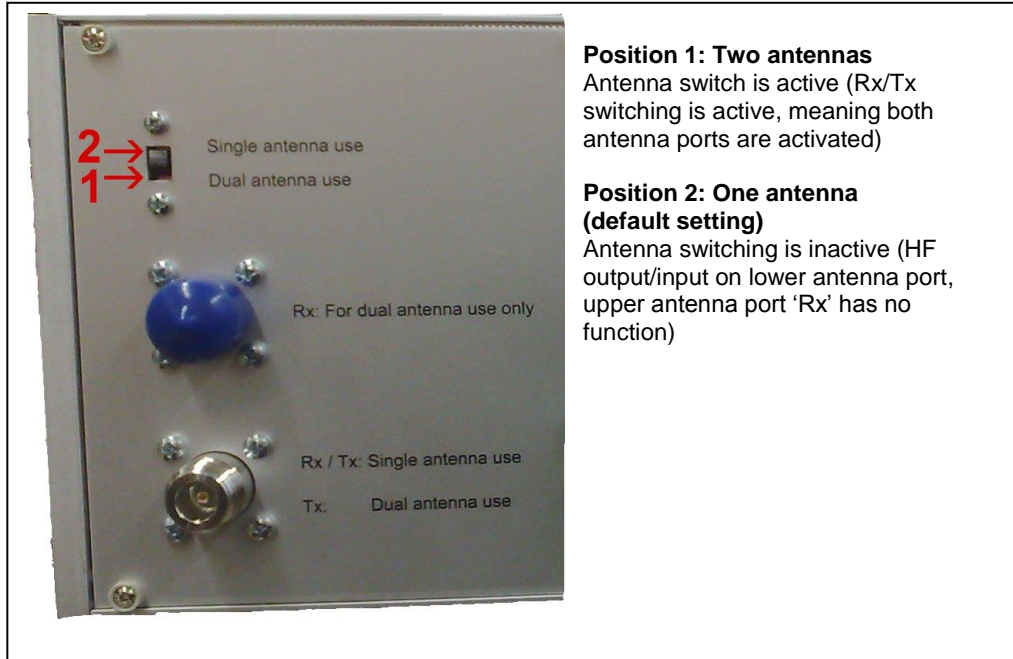

Figure 11: Sliding switch for one or two active antenna ports

3. Remove the blue protective cap when two antenna ports are used.
4. Turn the device on again.

5.13 GPS: Connecting the GPS antenna to the master DAU

The GPS receiver is placed on the card. The GPS signal is received by the GPS antenna and transmitted to the GPS receiver card via the coaxial cable.



Figure 12: GPS receiver card with available GPS antenna and holder

Installing the GPS receiver card in the ITC2500-NA:

1. Turn off the device and disconnect the mains plug and battery.
2. Loosen and remove the dummy board next to the SC card.
3. Insert the GPS receiver card into the empty slot and connect it.
4. Connect the mains plug and battery and put the DAU back into operation.
5. Check whether the green LED is lit.

GPS antenna

We recommend the Bullet III GPS antenna (3.3 V or 5 V) with TNC connector from Trimble and the lightning protector from Huber+Suhner (item no. 3406.19.0003).



Figure 13: GPS antenna from Trimble (left) and lightning protector from Huber+Suhner (right)

Important: The GPS antenna must meet the following requirements:

- Only active GPS antennas may be connected (no passive GPS antennas).
- The GPS antenna must be suitable for operation with voltages of 3.3 V or 5 V.
- The maximum power consumption of the GPS antenna must not exceed 35 mA.
- A combined GPS/**GSM** antenna may not be used.
- The antenna should have a bandwidth of 1575 MHz +/- max. 5 MHz (usually in the range of +/- 2 MHz).
- The GPS signal should have a gain of at least 5 dB from the GPS antenna to the GPS receiver card.

The GPS antenna from Trimble has a TNC connection and the GPS receiver card has an SMA connection. Accordingly, the HF connecting cable must be assembled with an SMA and a TNC connector.

Holder

The antenna holder from Glomex can be used, for example. It is made of stainless steel with a thread for a 1"/14 cap nut and is suitable for horizontal and vertical antenna installation for tubes with a diameter of 30 mm to 80 mm.



Figure 14: Holder (non-binding illustration)

HF cable selection

The recommended Trimble Bullet III 5 V GPS antenna has an LNA gain of 35 dB. 22-metre RG-188 or RG316 cables have a loss of $22\text{m} \times 1.20 \text{ dB/m} = 27 \text{ dB}$.

$35 \text{ dB} - 27 \text{ dB} = 8 \text{ dB}$ total gain (minimum gain).

The cable type to be used depends on the required cable length. With RG-213/RG-217, the cable is so thick that it cannot be crimped directly to an SMA connector but rather to a TNC, BNC or N connector. For this reason, an additional adapter from TNC, BNC or N to SMA must be used.

Antenna gain of the GPS antenna:	Trimble Bullet III, 5 V	+35 dB	
Coaxial cable loss:	Cable type:	Max. length:	-
	RG-316/RG-188 (1.20 dB/m)	25 m	30 dB
	RG-58 PE (0.95 dB/m)	31.5 m	
	RG-142 (0.65 dB/m)	46 m	
	LowLoss240flex (0.41 dB/m)	73 m	
	Only with adapter plug (due to large cable thickness):		
	RG-213 (0.34 dB/m)	88 m	
	RG-217 (0.25 dB/m)	120 m	
	1/4" Cellflex (0.18 dB/m)	165 m	

Minimum total gain	+5 dB
--------------------	-------

5.14 Connecting the I/O card to the DAU

The I/O card can be installed in the empty slot to the right of the SC card or S-Com card.

1. Turn off the device and disconnect the mains plug and battery.
2. Loosen and remove the dummy board next to the SC card or wide dummy board next to the S-Com card (if installed).
3. Loosen the SC card and pull it out by about 10 cm.
4. Connect the SC card and I/O card with the ribbon cable.



Figure 15: Connecting the I/O card to the ITC2500-NA

5. Carefully install both cards (dummy boards to the right may be removed for easier installation of the cards).
6. If the wide dummy board next to the S-Com card that may be installed is removed, install the narrow dummy board (which is on hand when installing the S-Com card).
7. Connect the mains plug and battery and put the DAU back into operation.
8. Check whether the green LED is lit.

The pin assignment of the I/O card is described in Section 7.7.

5.15 Connecting the OIC card to the DAU (for I.SITE II connection)

The radio coverage of the DAU can be expanded by connecting the I.SITE II. The I.SITE II is a remote transmitter that sends out the same POCSAG message synchronised with the DAU. The OIC card has to be installed in the DAU in order for the DAU to address the I.SITE II. The I.SITE II receives the transmitter control and modulation data from the OIC card over a serial, potential-free RS422 connection.

Note: The I.SITE II transmitter can be removed from the DAU by a maximum of 1200 m of cable length (twisted copper wire 0.6 mm²).

The OIC card can be installed in the empty slot to the right of the SC card or S-Com card.

1. Turn off the device and disconnect the mains plug and battery.
2. Loosen and remove the dummy board next to the SC card or wide dummy board next to the S-Com card (if installed).
3. Loosen the SC card and pull it out entirely.
4. Remove the wide ribbon cable from the SC card leading to the TRx module. Next, connect the new flat ribbon cable supplied with the OIC card to the SC card and OIC card (see figure).

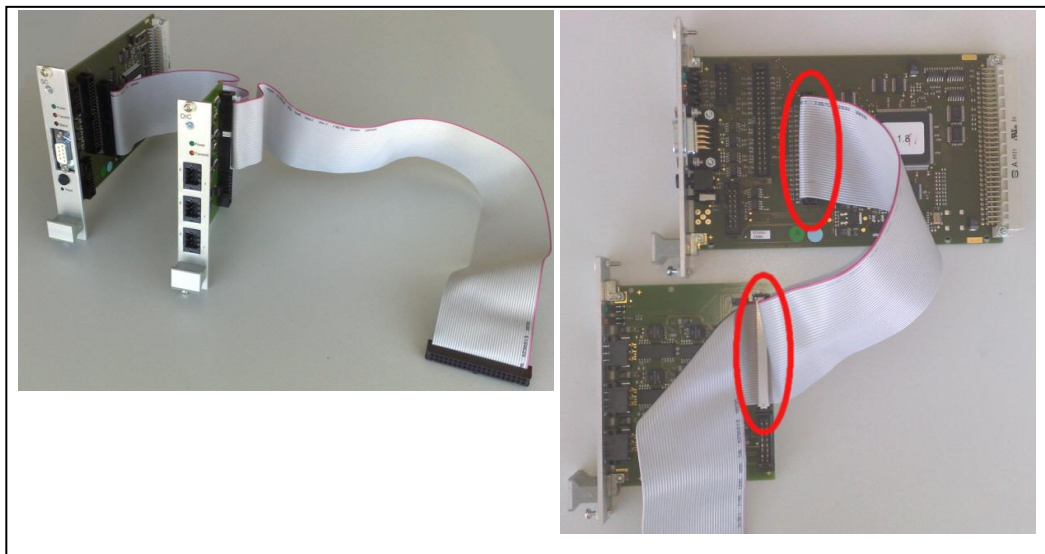

Figure 16: Correctly connecting the OIC card to the SC card

5. Install the SC card and OIC card together (the dummy boards to the right may be removed for easier installation of the cards). The long section of the wide ribbon cable should lead back to the interface print of the TRx module, like the old ribbon cable. It may be necessary to remove the top cover from the ITC2500-NA for easier installation.
6. Remove the back panel from the ITC2500-NA by loosening the ten screws.



Figure 17: Removing the back panel from the ITC2500-NA

7. Carefully tilt the back panel downwards. Unplug the old wide ribbon cable (connection from the SC card to the TRx module) connected to the interface print of the TRx module (see Figure 18).

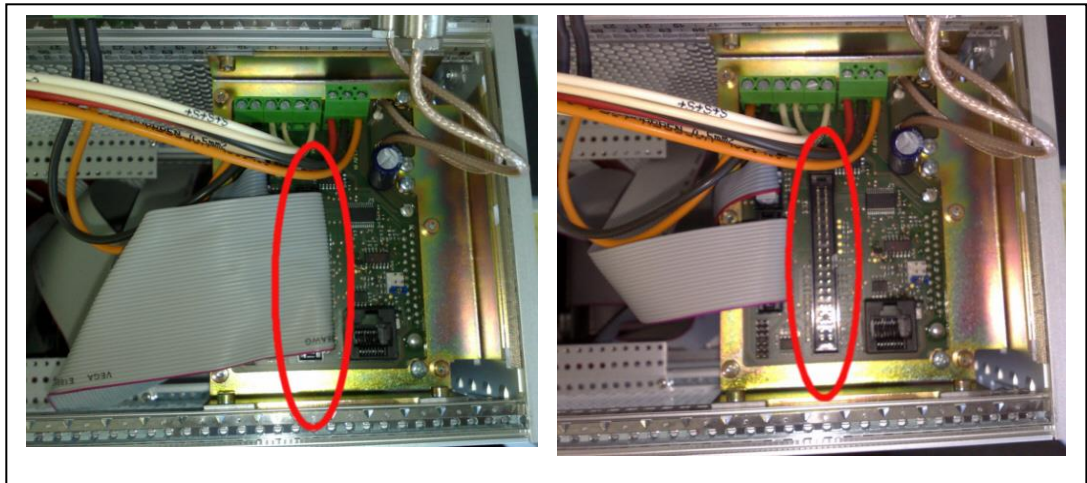

Figure 18: Unplugging the wide ribbon cable from the interface print on the TRx module

8. Connect the new wide ribbon cable supplied with the OIC card to the interface print of the TRx module.
9. Reinstall the back panel.
10. Connect the mains plug and battery and put the DAU back into operation.
11. Check whether the green LED is lit.

Further information about the I.SITE II and OIC card, especially wiring, can be found in the I.SITE II and OIC service manual.

6 Service web interface of the ITC2500-NA

6.1 Connection

The ITC2500-NA is configured via a web interface that can be accessed using a conventional browser⁵ such as Firefox or Internet Explorer. First, a PC or laptop is connected to the Ethernet port on the ITC2500-NA with an RJ45 network cable (LAN). The PC or laptop requires a network card with at least 10Base-T. Enter the IP address of the ITC in the browser to access the main page of the ITC2500-NA.

To ensure communication between the PC and ITC, the IP addresses of the PC and ITC IP addresses must be in the same segment with the same subnet mask. In Windows 7, for example, these settings are configured in *Control Panel > Network and Sharing Center*. The default IP address of a flash card with ITC software 5.x is **192.168.1.2**.

As a result, the following values must be entered in the settings for the network adapter of the PC/laptop:

IP address: **192.168.1.[<>2]; for example, 192.168.1.10**
Subnet mask: **255.255.255.0**

Finally, close all windows by clicking OK and restart the computer. This completes PC setup and it is now possible to begin the configuration process.

6.2 Login and menu navigation

The first time the IP address of the ITC is entered in a browser window, a login dialogue appears on the left side of the screen (Figure 19). The service technician logs in as follows:

User: **'service'**

Password: **'service'**

The password should be changed afterwards (see *Service > Service*; Section 6.6).

⁵ Swissphone recommends using Mozilla Firefox 3 or Microsoft Internet Explorer 9 or higher. Other browser versions may also be used, but have not yet been tested by Swissphone.

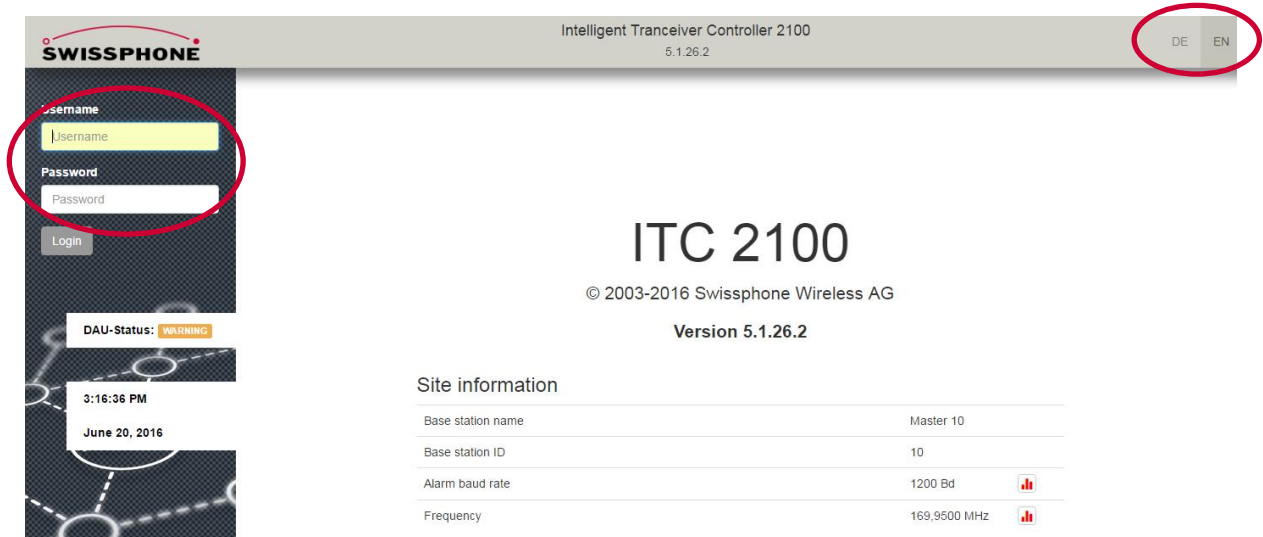

Figure 19: Login

The status of the ITC is also indicated by or . These symbols are used consistently for displaying the status.

The single-page application allows you to show and hide menus with the and arrow keys. Selection lists with stored values are indicated by . Input values are followed by the corresponding symbol indicating the physical unit (for example,). Use

to save configuration changes in the ITC with immediate effect.

Basic ITC information is shown in the main section of the window before login **Fehler! Verweisquelle konnte nicht gefunden werden..** These values are for informational purposes and can be changed under Configuration > DAU (see Section **Fehler! Verweisquelle konnte nicht gefunden werden.**). Choose English (EN) or German (DE) as the menu language at the top right of the window.

6.3 Monitoring

6.3.1 Status

The status of individual components of the ITC and other states (resets, local alerts) are displayed here (Figure 20). These values are for informational purposes.

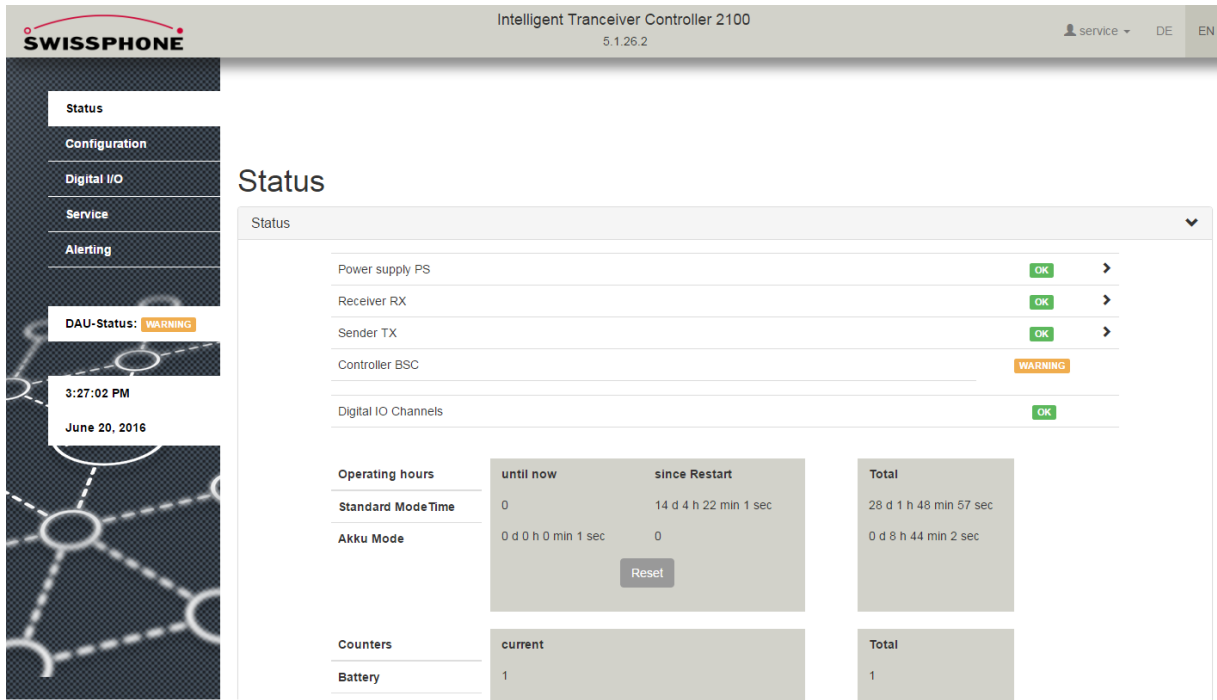

Figure 20: Monitoring > Status

<p>Power supply PS</p>	<p>Battery: Indicates whether the backup battery (if available) is supplying the required voltage (OK) or undervoltage (ERROR). If the value is too low, the DAU shuts down within 30 seconds and only restarted when the mains voltage is restored.</p> <p>Mains: Indicates whether the power supply is supplying the required voltage or not.</p>
<p>Receiver RX</p>	<p>PLL Locking: Indicates whether the transceiver was able to set the desired channel (frequency).</p> <p>Programming: Indicates whether the transceiver was programmed successfully.</p> <p>RC Device: Status of the receiver card</p> <p>Communication: Indicates whether communication with the transceiver is okay.</p> <p>RSSI: Indicates whether the link budget is adequate.</p> <p>RSSI Level: -58 Indicates the output on the HF receiver in dBm. When an alert message is received, the measurement is taken on the DAU's proprietary alert ring.</p>
<p>Transmitter TX</p>	<p>SC Device: Status of the synchronisation card</p> <p>Forward Power: Indicates whether HF output at the output is</p>

	sufficient. Reverse Power: Indicates whether the reflected HF output is excessive.
Controller BSC	Indicates the status of the controller. Possible resets generate a warning; the corresponding counters can be reset.
Digital I/O channels	Indicates the binary states of the I/O channels, either '0'/'low' or '1'/'high'.
Operating hours	Indicates the total operating hours since a restart for operation with the power supply (standard mode time) and with the backup battery (battery mode).
Counter	Indicates the number of battery, system failure and reset events.

Table 1: Monitoring > Status

6.3.2 Logging

Logging (journal) supports a comprehensive analysis of all message traffic as well as numerous system and monitoring commands. Many different filters can also be set to make the analysis and possible troubleshooting even more effective and efficient (Figure 21).

The screenshot shows the web interface for the Intelligent Tranceiver Controller 2100. The top header includes the SWISSPHONE logo and the device name. The left sidebar contains navigation links for Status, Configuration, Digital I/O, Service, and Alerting. The main content area is titled 'Status' and has a 'Journal' tab selected. There are 'Refresh' and 'Auto-Refresh' buttons. Below these are filter options for Time, Interface, Category, Scope, and Severity. The main table displays log entries with columns: Created, Code, Severity, Caption (Interface), Category, and Detail. The log entries include:

Created	Code	Severity	Caption (Interface)	Category	Detail
06/20/2016 3:26:48 PM	2103	WARNING	send response failed	TRANSMISSION	Peer: 172.16.4.179:2501 BROAD_ALARM_CONFIRM DAG_MASTER_ID=10 DAG_REQUEST_ID=t
06/20/2016 3:26:48 PM	2104	WARNING	receive acknowledge failed	RECEPTION	Peer: 172.16.4.179:2501
06/20/2016 3:26:47 PM	1001	NORMAL	transmission received	RECEPTION	-60 dBm CwER1=0/4 (0.0%) CwER2+=0/4 (0.0%) 4800 Baud Data 5 CW resolution: accept because is confirmation 8888D: 'type=\\broadcast-alarm-confirmation (0x97)' codewords=\\2\\ level=\\
06/20/2016 3:26:47 PM	1001	NORMAL	transmission received	RECEPTION	-69 dBm CwER1=0/4 (0.0%) CwER2+=0/4 (0.0%)

Figure 21: Monitoring > Logging

Refresh	Permits a one-time manual update of the log data.
Auto refresh	Permanently updates the log data.
Time	Activating the checkboxes allows the display of the log data to be set to a specific period of time. Note: This is always the local time of the DAU.
Interface	Radio: Filter log entries by DAU-to-DAU telegrams. ITC-COM: Filter log entries by DAG-to-DAU telegrams.
Category	Transmission: Filter log entries by DAU transmission telegrams. Reception: Filter log entries by DAU receiving telegrams (can originate from DAU or DAG). Status: Filter by status messages (see Section 6.3.1). Operation: Filter by orders that were carried out by the services (entries 5xxx; see Section 6.8.2 Fehler! Verweisquelle konnte nicht gefunden werden.) System: Filter by orders that were carried out by the system (entries 7xxx; see Section 6.8.2) Mutation: Filter by changes to the configuration or status values. Digital I/O: Filter by events that occurred on the hardware inputs and outputs.
Scope	Station: Filter by entries intended only for the DAU in question, or in other words, the proprietary ID or proprietary ring. Segment: Filter by entries that apply to a network segment in which this DAU is active. Network: Filter by entries that apply to a network segment of this network in which this DAU is not active. Foreign:

	<p>Entries that come from an external network (POCSAG-based) using an unknown network RIC.</p> <p>Unknown: Entries that come from defective messages where the network RIC could not be determined.</p>
Severity	<p>Normal: Events that occur during normal operation are indicated by NORMAL.</p> <p>Warning: Events that may be related to a problem are indicated with WARNING.</p> <p>Error: Events that make normal operation impossible are indicated with ERROR. Displayed in the event of network errors.</p> <p>Unexpected: Unexpected events are indicated with UNEXPECTED. The corresponding error codes are listed in the manual.</p>
Created	Event entry with the local time of the DAU.
Code	Error code (see Section 6.8.2).
Caption (interface)	Brief description of the log entry
Category	See above
Detail	Detailed information about the log entry

Table 2: Monitoring > Logging

Note: Use the mouse to click an entry and then scroll to the right with the arrow key. This allows you to view all of the content of longer telegrams. The 'Severity' column marks the end.

6.4 Configuration

6.4.1 Base station

To make the ITC correctly available in a network, at least the base station ID, standard frequency, baud rate as well as the transmitting power must be set.

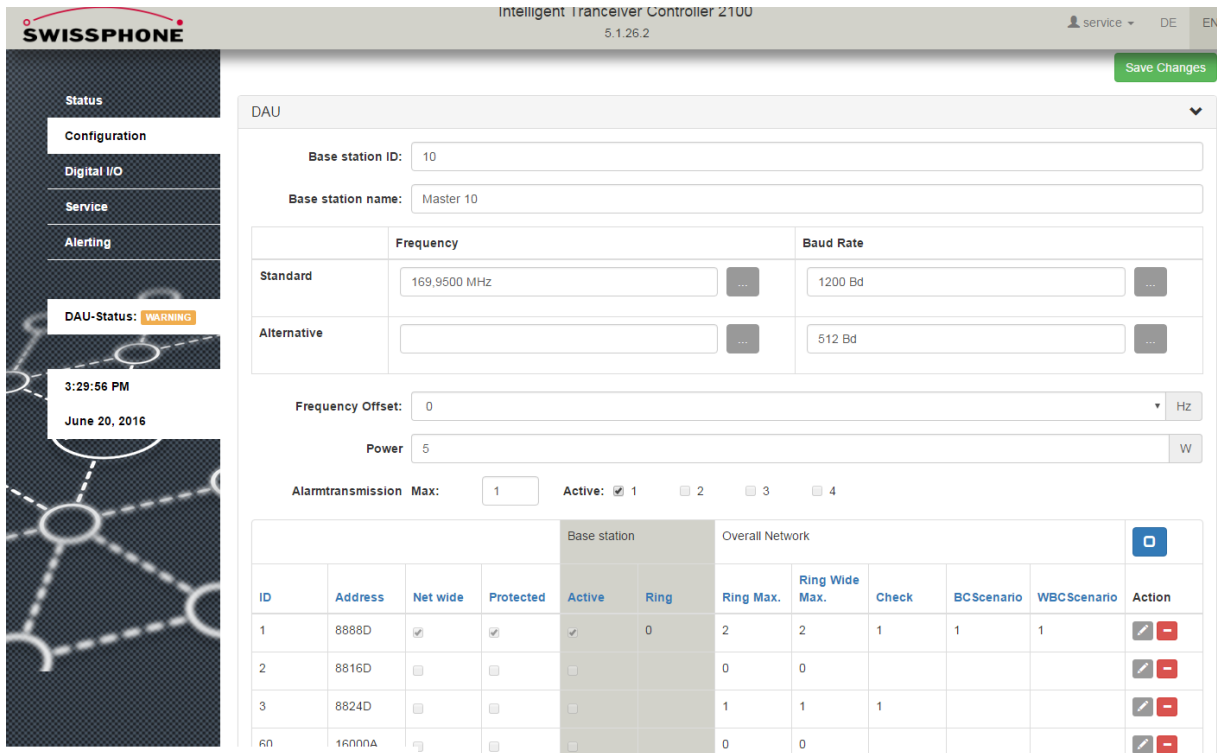

Figure 22: Configuration > DAU (General)

Base station ID	Required	We recommend entering an informative ID. The ID may only contain numeric values in the {0...127} range.
Base station name	Optional	We recommend using an informative name for the DAU.
Standard	Required	Standard carrier frequency and alerting baud rate.
Alternative	Optional	Alternative carrier frequency and alerting baud rate.
Frequency offset	Optional	Can be used to improve reception probability by avoiding radio interference. Warning: Consult a radio network planner for changes
Transmitting power	Required	Can be set in 1 W increments from 5 to 25 W.
Maximum number of multiple transmissions	Required	Used to send out alarms multiple times to increase the supply probability. Values in the {1...4} range are possible. The maximum value must be the same throughout the network and designates the maximum number of times an alert can be sent out.

		Use 'active' to establish whether and how many transmissions are carried out by this DAU. Multiple transmissions are always collision-free.
--	--	---

Table 3: Configuration > Basic DAU Parameters

Segments and feedback scenarios must also be set up correctly defined so that alerting is possible in the corresponding areas and status feedback can be provided (Figure 23).

				Base station		Overall Network					
ID	Address	Net wide	Protected	Active	Ring	Ring Max.	Ring Wide Max.	Check	BCScenario	WBCScenario	Action
1	8888D	<input checked="" type="checkbox"/>	<input checked="" type="checkbox"/>	<input checked="" type="checkbox"/>	0	2	2	1	1	1	
2	8816D	<input type="checkbox"/>	<input type="checkbox"/>	<input type="checkbox"/>		0	0				
3	8824D	<input type="checkbox"/>	<input type="checkbox"/>	<input type="checkbox"/>		1	1	1			
60	16000A	<input type="checkbox"/>	<input type="checkbox"/>	<input type="checkbox"/>		0	0				
<input type="text"/>	<input type="text"/>	<input type="checkbox"/>	<input type="checkbox"/>	<input type="checkbox"/>	<input type="text"/>	<input type="text"/>	<input type="text"/>	<input type="text"/>	<input type="text"/>	<input type="text"/>	

Default Segment:

Scenarios	Scenario ID	Overall network Number of slots for level L1-L8								Base station		
		L1	L2	L3	L4	L5	L6	L7	L8	Level	Slot	
		1	2	2								
	<input type="text"/>	<input type="text"/>	<input type="text"/>	<input type="text"/>	<input type="text"/>	<input type="text"/>	<input type="text"/>	<input type="text"/>	<input type="text"/>	<input type="text"/>	<input type="text"/>	

Figure 23: Configuration > Segment and Scenario Settings

Overall network segment:

A functioning paging network consists of at least one segment that all network DAUs belong to. This segment is active on every DAU and is marked as net wide; it is imperative that this segment be protected in order to avoid inadvertent deletion via the air interface. Network-wide alerting and network management via the air interface take place in this overall network segment. All remaining segments can be added, reconfigured or deleted via this overall network segment.





Sub-segments:

A paging network can have additional (normally local) segments that not all DAUs belong to. These segments can be used for subnetwork alerting. All segments used in a network should be configured on all DAUs, irrespective of whether the DAUs themselves are active in these segments.

Local segment:

A segment (preferably Segment 60) can be configured on every DAU as a local segment. A transmission on only this DAU can then take place, if necessary.

The segments are defined with the following values:

ID	Optional	Segment ID: Numbers in the {1...60} range can be assigned. Note: Define the overall network segment with '1'; number subnets consecutively with '2'...'x'.
Address	Required	Segment address: Type 'RIC' with sub-address, must be in frame 0 (divisible by 8 with no remainder).
Network-wide	Optional	At least one segment needs to be active on all DAUs and therefore marked as 'network-wide'.
Protected	Optional	The overall network segment should definitely be marked as protected. Information: Unprotected network segments can be erased over the air interface.
Active	Optional	In all cases, only segments set to 'active' are used for transmitting alerts. The GUI permits setting no segment as 'active' for testing purposes, but at least one segment needs to be set to 'active' for alerting. Use  to show/hide 'inactive' segments.
Ring	Required	Ring number corresponding to the DAU.
Ring Max.	Required	Maximum number of rings that can be defined for BC.
Ring Wide Max.	Required	Maximum number of rings that can be defined for WBC.
Check	Optional	The DAU evaluates messages with this ring number. Note: For master DAUs, the check ring defines the ring on which it monitors the transmissions.
BC Scenario	Required	Feedback scenario for BC (see Table 5)
WBC Scenario	Required	Feedback scenario ID for WBC (see Table 5)
Action	n.a.	 Add entries  Edit entries  Confirm mutations



		 Cancel mutations  Remove entries
--	--	--

Table 4: Configuration > DAU Segments

The feedback scenarios have to be configured according to significance as follows:

Standard segment	Required	Segment address: Type 'RIC' with sub-address; must be in frame 0 (divisible by 8 with no remainder). The standard segment designates the RIC of the segment used by this DAU for sending out alerts. This applies to alerts triggered via ITC-COM (insofar as no other segment is specified), the user interface or a digital input. The DAU has to be the (local) master in this segment, meaning it has to be in ring 0.
Scenario ID	Required	ID of the feedback scenario; values in the {1...30} range are permitted
Number of slots for levels L1-L8	Required	Slot values in the {1...30} range are permitted for all levels L1-L8
Base station level	Required	The level set for the DAU.
Base station slot	Required	The time slot set for the DAU.

Table 5: Configuration > DAU Scenarios

6.4.2 Paging Network Controller

In order to make authorised PNCs (DAGs) available as clients, their IP address as well as the input and output port must be set (Figure 24).

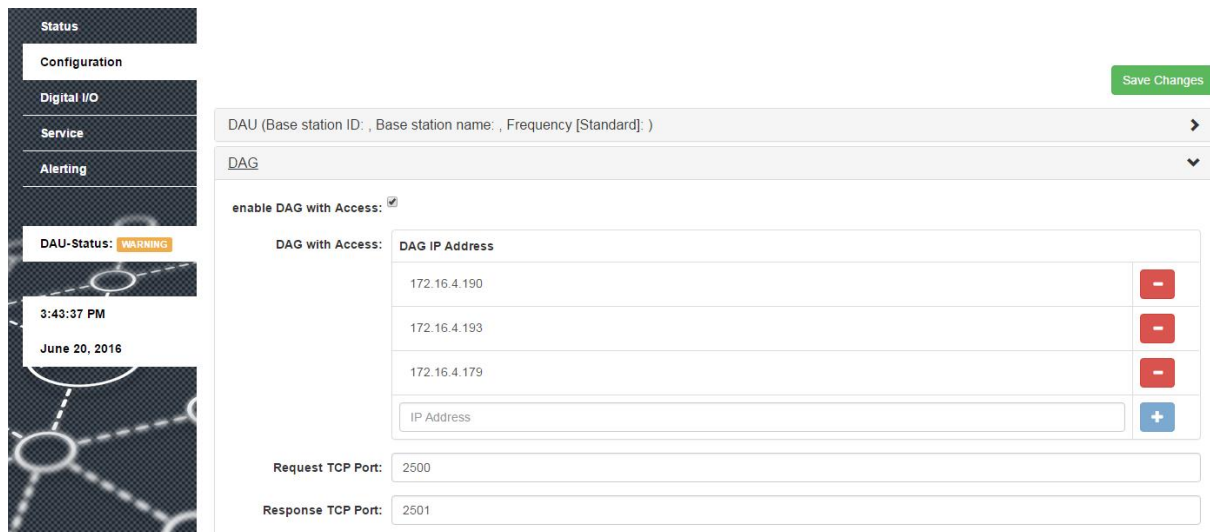

Figure 24: Configuration > DAG



DAG with access rights	All authorised DAGs can be entered here with the corresponding IP addresses. Entries are added with  and deleted with  .
Request TCP port	Default port 2500 (also see Section 6.8.1)
Response TCP port	Default port 2501 (also see Section 6.8.1)

Table 6: Configuration > DAG

6.4.3 Hardware

The hardware parameters depend on the transceiver module in use and must be set correctly, otherwise correct functioning of the DAU within the paging network cannot be guaranteed and the paging network may be disrupted.

These values must be changed accordingly when a transceiver module is replaced.

Note: This configuration can be downloaded and saved on a PC via Service > Maintenance (also see Section 6.6). The hardware parameters, among other things, are stored in the configuration.



Figure 25: Configuration > Hardware

Delay Rx	Delay value of the TRx module in μs . Automatically set by the final test. Warning: If the value is not present, it must be taken from the label on the TRx module and entered here.
Delay Tx	Delay values of the TRx module in μs . Automatically taken from the final test. Warning: If the value is not present, it must be taken from the label

	on the TRx module and entered here.
RSSI Low ADC Value	Offset parameter of the ADC linear equation (value according to final test).
RSSI High ADC Value	Offset parameter of the ADC linear equation (value according to final test).

Table 7: Configuration > Hardware

6.4.4 Network

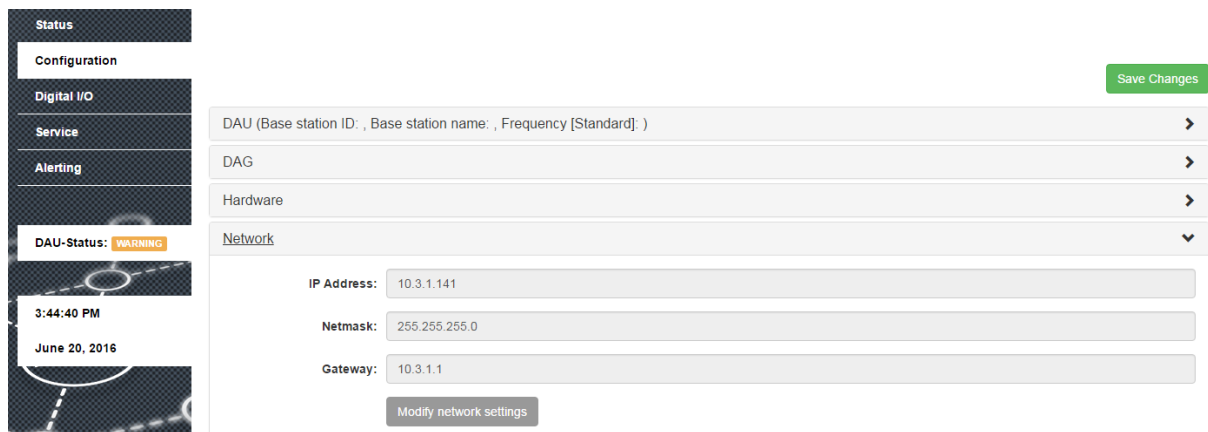

Figure 26: Configuration > Network

IP address	IP address of the DAU.
Network mask	Network mask of the DAU.
Gateway	Gateway connected to the DAU.

Table 8: Configuration > Network

Use the 'Netzwerk-Parameter ändern' button to modify the above settings.

Warning: Clicking the 'Netzwerk-Parameter ändern' button in the pop-up window saves the settings immediately. A corresponding message is displayed at the bottom of the screen in this case.

6.5 Digital I/O

6.5.1 Digital inputs

For input 5, users can click  to store a predefined message text via the local segment and for an RIC.

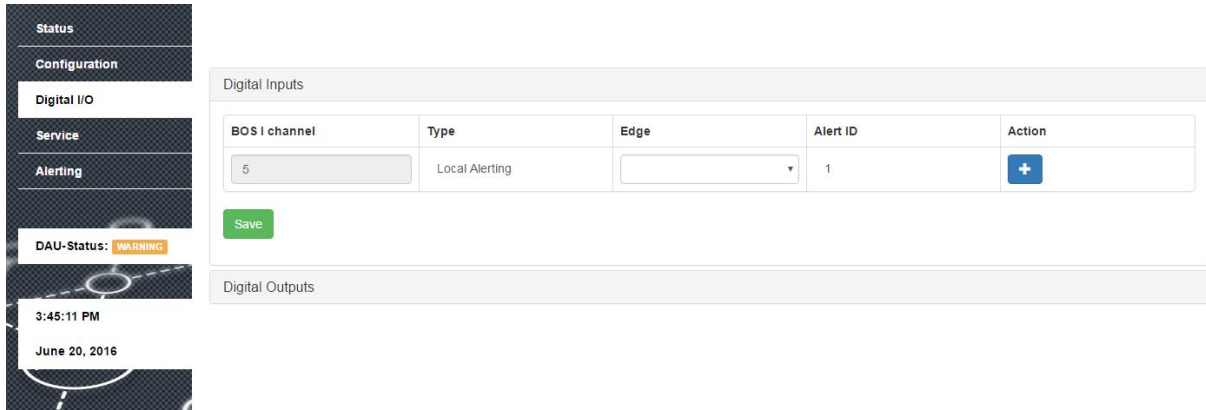

Figure 27: Digital I/O > Digital Inputs

BOS I Channel	Number of the input contact
Type (deactivated)	Local alerting
Flank	Detection can be either on the rising or the falling flank.
Alarm ID (deactivated)	Alarm ID
Action	Set additional inputs.

Table 9: Digital I/O > Settings

6.5.2 Digital outputs

Not yet implemented.

6.6 Service

The service interface is used to upload or store ITC configurations, generate system data for debugging/troubleshooting, update software (install updates) and change the default password.

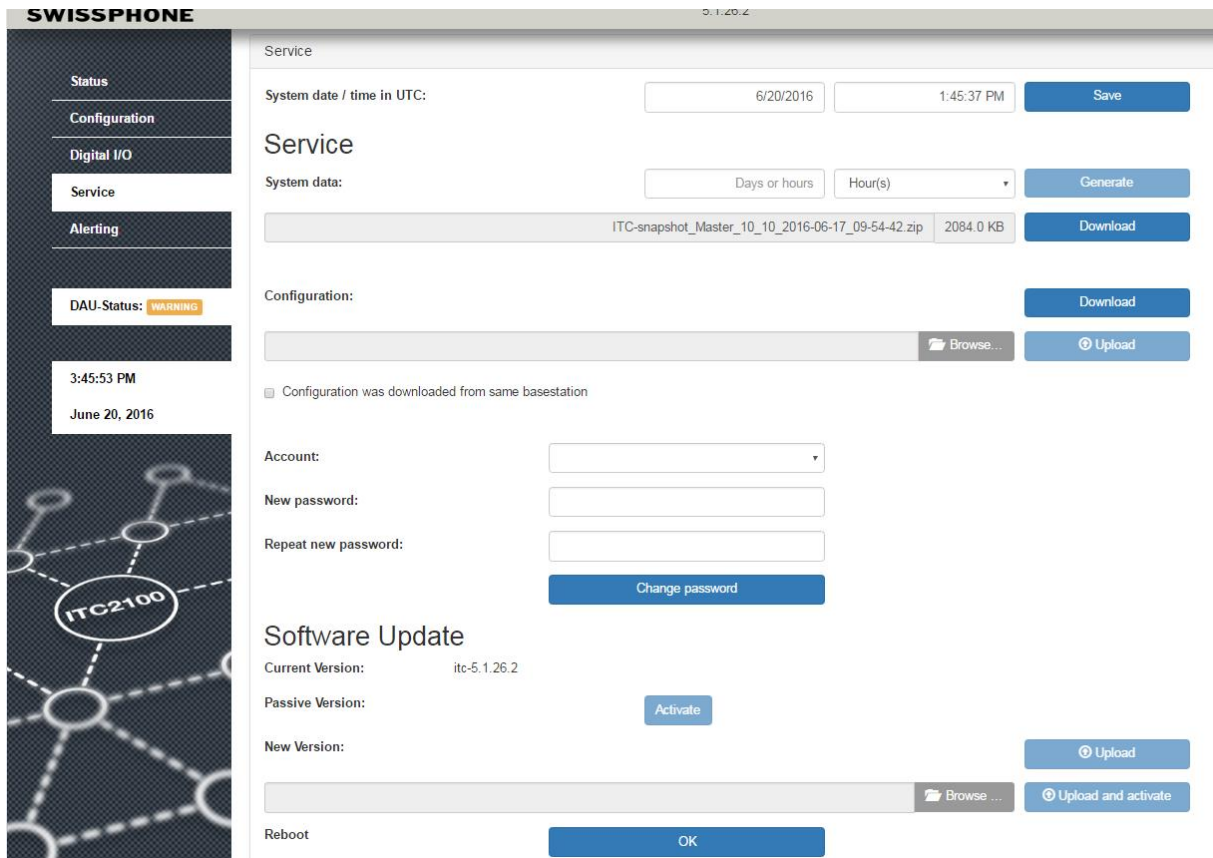
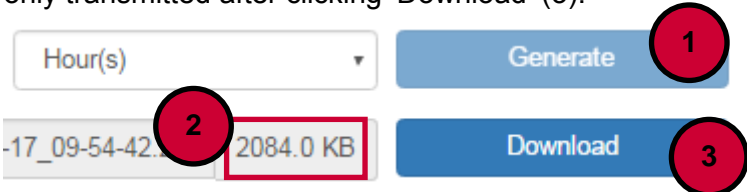

Figure 28: Service

System date/time in UTC	Can be set and changed in the field and stored with the 'Save' button.
Maintenance	
System data	Limit the time range for the log data. The 'Generate' button (1) transmits the size of the log file (2). This is important for slow modem connections. The log file is only transmitted after clicking 'Download' (3). 
Configuration	ITC configurations can be exported (downloaded) and imported (uploaded) as JSON files.
Access to the web interface, new password	After logging in for the first time with the default password, a new password can be assigned here (recommended).
Software update	

Current version	Indicates the software version currently in use.
Passive version	Indicates the alternative software version stored in the system but not in use (can be set as the current version with 'Activate').
New version	Upload a new software version not yet present on the system.
Reboot	Click the 'OK' button to restart the DAU.

Table 10: Service

6.7 Alerting

The 'Alerting' interface is used to send out a freely definable alert in the local segment.

Figure 29: Alerting

Click the 'Save' button to store the defined text message, especially also after logging in again.

Alert	Sends out the text stored under 'Text' in the local segment.
Network segment	Defines the local segment.
RIC/type	Input of the addressee and recipient type.
Alert type	BC or WBC
Text	Text to be sent out

Table 11: Alerting

Note: Use 'Save' to store the configured settings and the text.

6.8 Appendix

6.8.1 TCP/IP port assignments

The following ports are used by default but can be changed.

Warning: If port changes are made on the DAU, the corresponding changes also have to be made on the DAG (PNC)!

Service	Port
ITCCOM (DAU receives from DAG)	2500
ITCCOM (DAU sends to DAG)	2501

Table 12: TCP/IP port assignments

6.8.2 Error codes

The following error codes are available and provide valuable assistance for maintenance and service personnel:

Implemented	Severity	Error code	Description	Category	Comments	Interface	Meaning for service personnel
✓	N	1001	Transmission Received	RECEPTION		RADIO	
✓	N	1002	Transmission Sent	TRANSMISSION		RADIO	
	E	1101	Transmission Abort	RECEPTION		RADIO	
	E	1102	Transmit Failure	TRANSMISSION	The execution of a radio transmission failed.	RADIO	Check status and configuration. If all is OK, file a bug report.
	E	1103	Invalid Transmission Code	RECEPTION		RADIO	
	E	1104	Invalid baud rate	RECEPTION	Transmission in my segment / station with unexpected baud rate.	RADIO	
✓	N	2001	Request	RECEPTION		ITCCOM	

			received				
✓	N	2002	Request acknowledge sent	TRANSMISSION		ITCCOM	
✓	N	2003	Response sent	TRANSMISSION		ITCCOM	
✓	N	2004	Response acknowledge recieved	RECEPTION		ITCCOM	
	N	2005	Request sent	TRANSMISSION	Concept idea for RLP	ITCCOM	
	N	2006	Request acknowledge received	RECEPTION	Concept idea for RLP	ITCCOM	
	N	2007	Response received	RECEPTION	Concept idea for RLP	ITCCOM	
	N	2008	Response acknowledge sent	TRANSMISSION	Concept idea for RLP	ITCCOM	
✓	W	2101	Receive request failed	RECEPTION		ITCCOM	Check network connection and client version
✓	W	2102	Send acknowledge failed	TRANSMISSION		ITCCOM	Check network connection and client version
✓	W	2103	Send response failed	TRANSMISSION		ITCCOM	Check firewall settings and connection
✓	W	2104	Receive acknowledge failed	RECEPTION		ITCCOM	Check network connection and client version
✓	W	2105	Received invalid request	RECEPTION		ITCCOM	Check network connection and client version
	E	21xx	Unauthorized client	RECEPTION	Client IP not in IP list	ITCCOM	Possible security problem or incorrect configuration
	N	3001	Request received	RECEPTION		SONNENBURG	
	N	3002	Response sent	TRANSMISSION		SONNENBURG	
	E	3101	Respose	TRANSMISSION		SONNENBURG	Check serial

			timeout			RG	connection
	E	3102	Invalid request received	RECEPTION		SONNENBU RG	Check client version
	N	4001	AMI Request received	RECEPTION		AMI	
	N	4002	AMI Response sent	TRANSMISSION		AMI	
	E	4101	Invalid AMI request	RECEPTION		AMI	Check client
	E	4102	Unauthorized AMI Request	RECEPTION		AMI	Security problem
✓	N	5001	Testmode started	OPERATION			
✓	N	5002	Testmode stopped	OPERATION			
✓	N	5003	Change to alternate frequency	OPERATION			
✓	N	5004	Change back to standard frequency	OPERATION			
	N	5005	Send local alarm	OPERATION			
✓	E	5101	Radio Network Busy	OPERATION	Request received while busy		Check client version and configuration, Check configuration of network, more than one client sends requests
✓	E	5102	Unknown segment	OPERATION	Segment is not known		Check configuration
✓	E	5103	Inactive segment	OPERATION	Segment is known, but not active		Check configuration
✓	E	5104	Station is no master in segment	OPERATION	Base station is not master for the requested transmission, rejected		Check configuration

	E	5105	Transmission error	OPERATION	'uem' error		Check radio signal quality, antenna, network planning
✓	N	5201	Send Broadcast	OPERATION	Master sends broadcast		
✓	N	5202	Forward Broadcast	OPERATION	Slave Forwards Broadcast		
✓	E	5301	Check Ring Timeout	OPERATION	broadcast 'tmo' error		
	E	5302	Multimaster too late	OPERATION	broadcast 'tla'		Check client time server
	E	5303	Multimaster too early	OPERATION	broadcast 'tea'		Check client time server
✓	N	5401	Send P2P Request	OPERATION	Master sends P2P Request		
✓	N	5402	Forward P2P Request	OPERATION	Slave forwards P2P Request (to final hop)		
✓	N	5403	Send P2P Response	OPERATION	Slave (Final Hop) sends P2P Response		
✓	N	5404	Forward P2P Response	OPERATION	Slave forwards P2P Response (back to master)		
✓	E	5501	P2P Timeout	OPERATION	P2P 'tmo' error		Check radio signal quality, antenna, network planning
✓	N	5801	Push-User-Data	OPERATION	set new user data		
✓	N	5802	Update-User-Data	OPERATION	update user data		
✓	N	5803	Clear-User-Data	OPERATION	clear the available user data		
✓	N	5804	Fetch-User-Data	OPERATION	fetch user data		
✓	N	5805	User-Data timeout	OPERATION	Timeout on user data		
✓	N	6001	Mains power restored	STATUS		ps.mains	
✓	W	6002	Mains power failure	STATUS		ps.mains counters.em	Check mains power supply

						ergency_power_supply	
✓	E	6003	Low battery power	STATUS		ps.battery counters.low_power	Check battery capacity
✓	N	6101	Forward Power changed to Ok	STATUS		tx.forward_power	
✓	W	6102	Forward Power changed to Warning	STATUS		tx.forward_power	Possible problem, check system
✓	N	6111	Reverse Power changed to Ok	STATUS		tx.reverse_power	
✓	W	6112	Reverse Power changed to Warning	STATUS		tx.reverse_power	Possible problem, check system
✓	N	6121	SC Device changed to Ok	STATUS		tx.sc_device	
✓	E	6123	SC Device changed to Error	STATUS		tx.sc_device	Problem, e.g. hardware failure ect.
✓	N	6201	Radio communication changed to Ok	STATUS		rx.communication	
✓	E	6203	Radio communication changed to Error	STATUS		rx.communication	
	N	6209	Radio communication cleared	STATUS		rx.communication	
✓	N	6211	Radio programming changed to Ok	STATUS		rx.programming	
✓	E	6213	Radio programming	STATUS		rx.programming	

			changed to Error				
	N	6219	Radio programming cleared	STATUS		rx.programming	
✓	N	6221	PLL locking changed to Ok	STATUS		rx.pll_locking	
✓	E	6223	PLL locking changed to Error	STATUS		rx.pll_locking	
	N	6229	PLL locking cleared	STATUS		rx.pll_locking	
✓	N	6231	RSSI level changed to OK	STATUS		rx.rssi	
✓	W	6232	RSSI level changed to Warning	STATUS		rx.rssi	
✓	E	6233	RSSI level changed to Error	STATUS		rx.rssi	
✓	N	6239	RSSI level cleared	STATUS		rx.rssi	
✓	N	6241	RC09 firmware version OK	STATUS		rx.rc_device	
✓	W	6242	Wrong RC09 firmware version	STATUS		rx.rc_device	
✓	N	6401	Digital IO status changed to Ok	STATUS		ext.digital_io	
✓	E	6403	Digital IO status changed to Error	STATUS		ext.digital_io	
✓	N	6409	Digital IO status cleared	STATUS		ext.digital_io	
✓	N	7001	System	SYSTEM			

			started				
✓	N	7002	Shutdown with reboot	SYSTEM			
✓	N	7003	Shutdown with halt	SYSTEM			
✓	W	7101	System not properly shut down	SYSTEM	System was turned off without shutting it down		Always use the SC button or the GUI to shut down the system before turning it off.
✓	N	7201	System configuration changed	MUTATION		System Config	
✓	N	7202	Counters reset	MUTATION		status.counters	
✓	N	7203	Timers reset	MUTATION		status.timers	
✓	N	7204	Conditions reset	MUTATION		status.conditions	
✓	N	7205	Digital I/O reset	MUTATION		status.digital_io	
	N	7206	Journal reset	MUTATION		journal	
	N	7207	System Time changed	MUTATION	Hard set of system time	System Time	
	N	7208	System Time adjusted	MUTATION	System time will be slowly adjusted over the next hours	System Time	
	N	7209	Network configuration changed	MUTATION		IPV4 Config	
✓	N	7210	Adjust system time	MUTATION	Adjust or set system time	System Time	
	E	7301	System configuration failed		set system configuration failed	System Config	
✓	E	7310	Adjust system time failed	MUTATION	Adjust or set system time failed	System Time	
✓	N	7401	Digital Input Edge	DIGITAL_IO			
✓	N	7402	Digital Output	DIGITAL_IO			

			Changed				
	N	7403	Siren started	DIGITAL_IO			
	N	7404	Siren stopped	DIGITAL_IO			
	N	7405	Digital IO send alarm	DIGITAL_IO			
	E	7406	Digital IO send alarm failed	DIGITAL_IO			
✓	X	9001	Invalid configuration file	SYSTEM	Configuration file was corrupted and must be reset to default	-	"
✓	X	9003	Invalid status file	SYSTEM	Statusfile was corrupted and must be reset to default	-	"
✓	X	9005	Operating system command failed	SYSTEM	Operation system operation failed unexpectedly.	-	-
	X	90xx	Forward Transmission failed	OPERATION	Transmission was not ready in time for re- transmission	counters.inte rnal_error	Report to customer support
	X	90xx	Service Reset	SYSTEM	Service did no respond and was terminated	-	"
	X	90xx	Service respawn	SYSTEM	Service re- spawned unexpectedly	counters.ser vice_reset	"
	X	90xx	Watchdog event	SYSTEM	System was reset due to a watchdog event NOT implemented	counters.wat chdog	"
	X	90xx	Invalid config rejected	SYSTEM	An invalid internal set config request was rejected	-	"
	X	90xx	Out of memory	SYSTEM	Could not allocate enough	-	-

					memory		
--	--	--	--	--	--------	--	--

Table 13: Overview of DAU error codes

7 Functional description of the individual components

7.1 Transmission/receiving unit (TRx 40/50W)

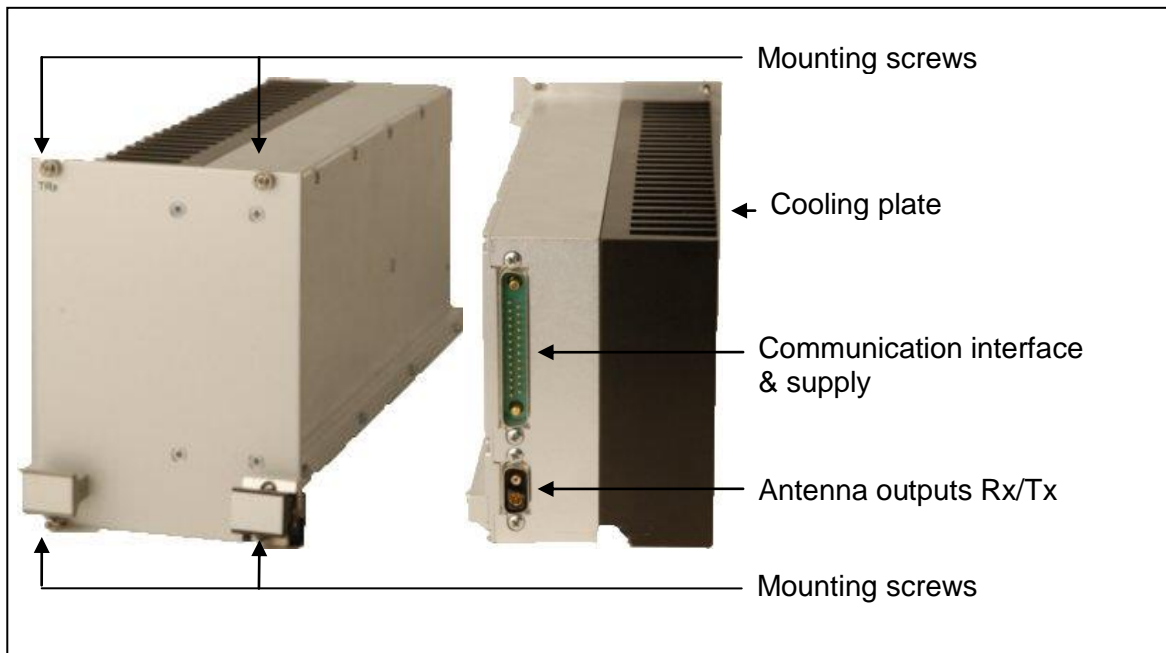

Figure 30: Transmission/receiving unit (TRx 40/50W)

The transmission/receiving unit is specified below:

General radio data

Frequency sub-bands	144–174MHz, 400–470MHz, 450–530MHz
Frequency stability (carrier):	±1.5 ppm
Number of channels (per frequency band):	99
Channel spacing:	12.5 kHz
Modulations/demodulation type:	DFSK ± max. 2.5 kHz (at 12.5 kHz channel spacing)
	FM/PM 300 ... 3000 Hz
Switching bandwidth:	Entire available frequency range
POCSAG transmission rate:	512, 1200 or 2400 baud
Antenna port:	50 Ohm coaxial N-type (1x for transmitting, 1x for receiving)

Transmitter (Tx)

Output power:	10–50W (UHF 40W), configurable in 2 W increments
Intermodulation loss:	> 40 dB (in reference to third-order intermodulation oscillation)

Adjacent channel output:	< -70 dB
Spurious emissions:	< 250 nW (30 MHz to 1 GHz)

Receiver (Rx)

Sensitivity:	<2 μ V (EMF) for analysis of 90% digital alerts <-110 dBm at 12 dB SINAD
Co-channel suppression:	> - 8 dB
Adjacent channel loss:	> 70 dB (at 20 kHz channel spacing)
Spurious loss:	> 70 dB
Blocking:	> 90 dB μ V (\pm 1 MHz to \pm 10 MHz)
Interference power:	< 2 nW (30 MHz to 1 GHz)
Intermodulation loss:	> 70 dB

The transmitting and receiving unit features an antenna switch so that only one antenna has to be installed for transmitting and receiving. The receiver is automatically turned off when the transmitter is turned on.

7.2 PS-200W power supply

The power supply provides power to the entire base station. It meets the following requirements:

Input voltage:	90–264 VAC/47–63 Hz
Power consumption:	Max. 200 W
Max. output voltages/ output currents:	13.8 V/8 A and 5 V/5 A
Deep discharge protection:	Yes
Efficiency:	80%, 10–15 A typical load
Autonomy (with battery operation):	>4 h, with Pb 12 V 12 Ah battery (for 25 W transmitting power and Tx:Rx=1:4 min)
Battery fuse:	250 V/12.5 AT
Power supply fuse:	250 V/4 AT

7.2.1 PS200W power supply version, article no. 0710047

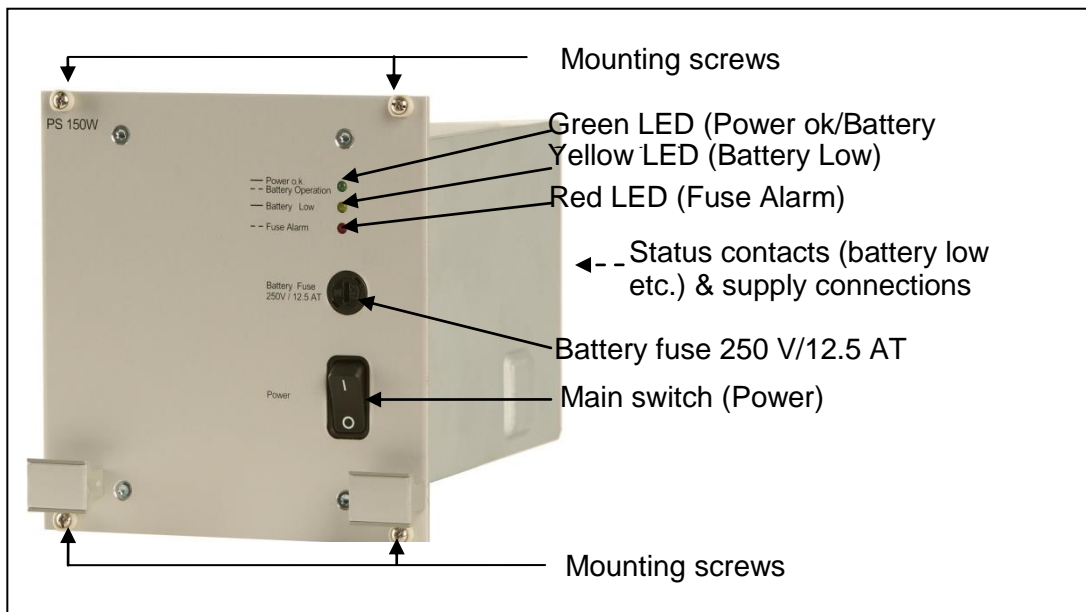

Figure 31: Power supply (PS200W)

LED type		Description
Green	Lit	The base station is on and supplied by 90-264VAC (power ok).
	Flashing	Main supply interrupted, running on battery (battery operation).
	Not lit	The base station is off.
Yellow	Lit	The battery voltage has fallen below a critical value of 10.6 V (battery low) – alerting is no longer possible. The base station assumes a safe state 40 seconds later; the controller shuts down individual processes (LEDs of the controller, SC, RC, I/O card are turned off).
	Not lit	Sufficient battery voltage (over 10.6 V).
Red	Flashing	Defective power supply fuse (fuse alarm).

Table 14: Functional description of the power supply LEDs

7.2.2 Battery operation (no mains network)

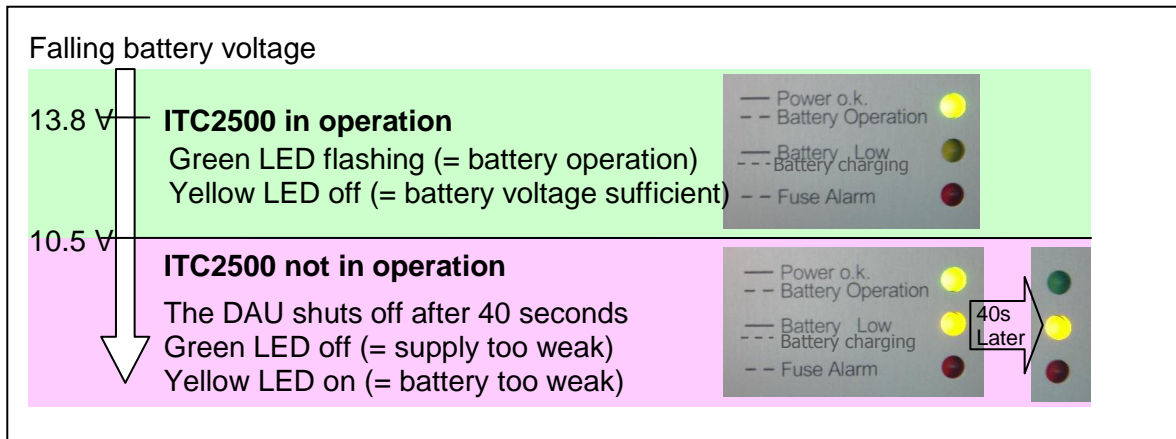

Figure 32: ITC2500 operation depending on falling battery voltage

As soon as the battery voltage falls below 10.6 V in battery operation (no mains network), the DAU is shut off and remains out of operation until the mains supply is restored. As soon as the mains supply is restored, the battery is first charged for about 1.5 minutes, since the battery voltage remains below 10.6 V. The DAU is then powered up and charging of the battery continues.

If necessary (no mains supply and battery voltage under 10.6 V), the battery can be changed and the DAU put back into operation (see Section 5.10) with power from the new battery. The voltage of the new battery must be at least 11.7 V.

7.3 G-T16R Controller (BSC)

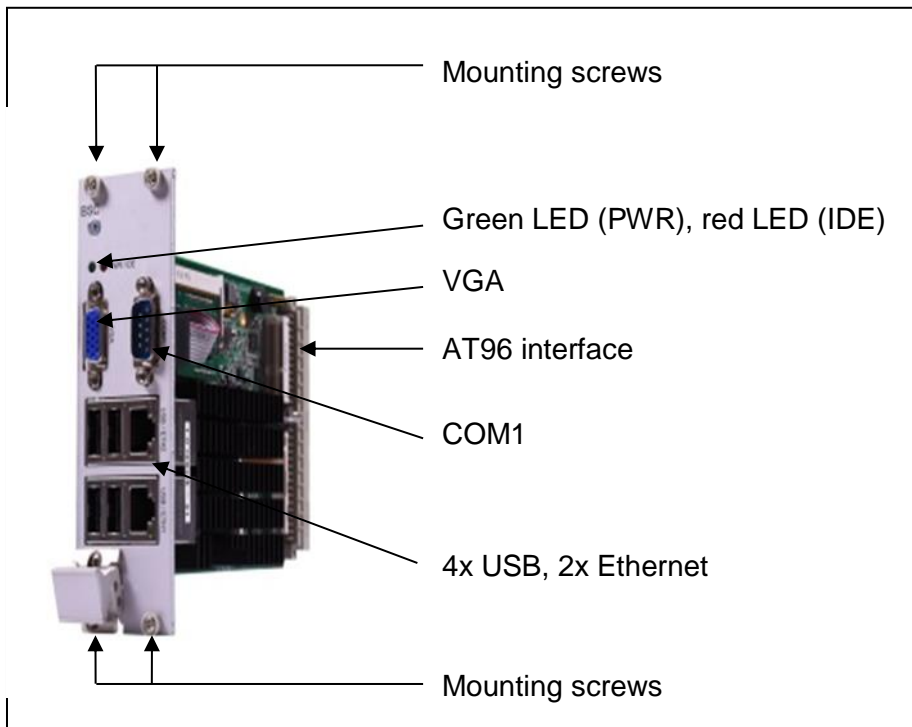

Figure 33: Controller (BSC)

The BSC is a conventional computer (single board computer or embedded PC) equipped with a flash disk as the storage medium. It handles data processing, controlling the inputs/outputs and operating the interfaces. The BSC hardware requirements are as follows:

CPU:	615 MHz, 64-bit
RAM:	1 GB
Flash disk:	2 GB
Operating system:	Linux
Peripheral connections:	1x VGA (1920x1200) 2x Gigabit Ethernet RJ45 4x USB 2.0

The functionality can be checked visually as follows:

Status	Green LED (PWR)	Red LED (IDE)
Normal state	Lit	Off or flashing (during hard disk access)
ITC turned off or BSC not supplied with 5 V voltage	Dark	Dark

Table 15: Functional description of the controller LEDs

7.4 Synchro card (SC2000 0x500)

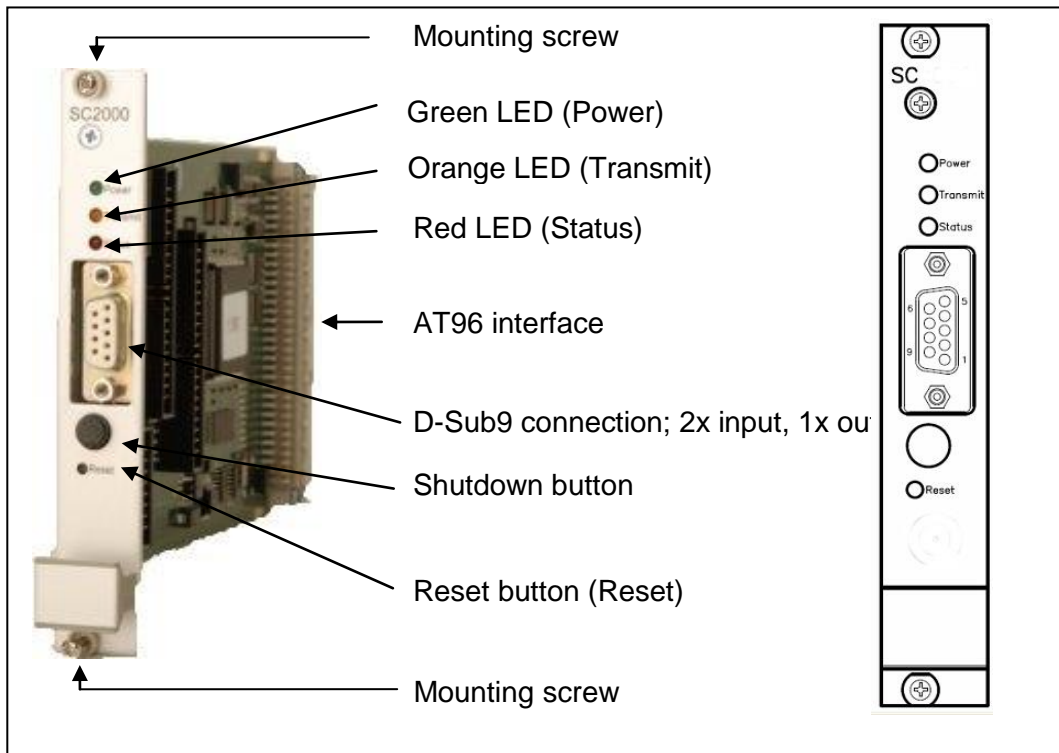

Figure 34: Synchro card (SC)

The synchro card SC is responsible for the synchronised transmission of data to the transmitter. The following functions are also integrated in the synchro module:

- Synch-pulse detection A pulse is sent over the AT96 bus to synchronise the data from the RC card.
- Optocoupler connections for input/output. Voltages between 10 V and 20 V can be applied to the inputs.

At its core, the synchro module consists of an μ s-counter and temporary storage for the transmission data. Standard components and FPGA logic are used. The counter runs for 2^{28} μ s (approx. 4.5 minutes) and then starts at zero again. It can be queried via a register from the BSC. Various registers are available to set the start, stop and switching reference points. The transmission data storage is large enough to allow continuous transmission for at least one minute at 2400 bit/s. The synchro module has the European card format (3 RU) and is connected to the AT96 bus. It features the following sockets, buttons and displays on the front:

- LEDs (power on, send, status).
- Reset button: Resets all registers (excluding the counter) and generates a BSC interrupt.
- Shutdown button (large black button). If this button is pressed for more than seven seconds, the DAU shuts off.

- 9-pin D-Sub interface (used as the optocoupler connection!).

LED type	Description
Green LED (Power) is lit	Power is supplied to the synchro card.
Orange LED (Transmit) is lit	Lit as long as a message is being sent from the synchro card to the transmitter.
Red LED (Status) is lit	A base station status is out of order (for example, output power too low, return power too high etc.)
Red LED (Status) Flashing	The battery voltage is falling below a critical value and the base station is being brought into a safe system state (the BSC shuts down the individual processes).
All LEDs flash briefly	The base station is fully booted up.
All LEDs are lit	The base station is fully powered down and can now be shut off.

Table 16: Functional description of the SC card LEDs

The SC card has two inputs and one output. Together with the I/O card, the total number of inputs and outputs is expanded to seven and eight respectively.

The inputs and outputs on the SC card meet the following requirements:

Number of inputs:	2
Current/voltage range on the opto inputs:	5–25 mA, 5–15 V
Number of outputs:	1
Maximum current/voltage on the opto output:	25 mA, 13.8 V
Connecting plug type:	D-Sub9
Connecting wire diameter:	1 mm ²

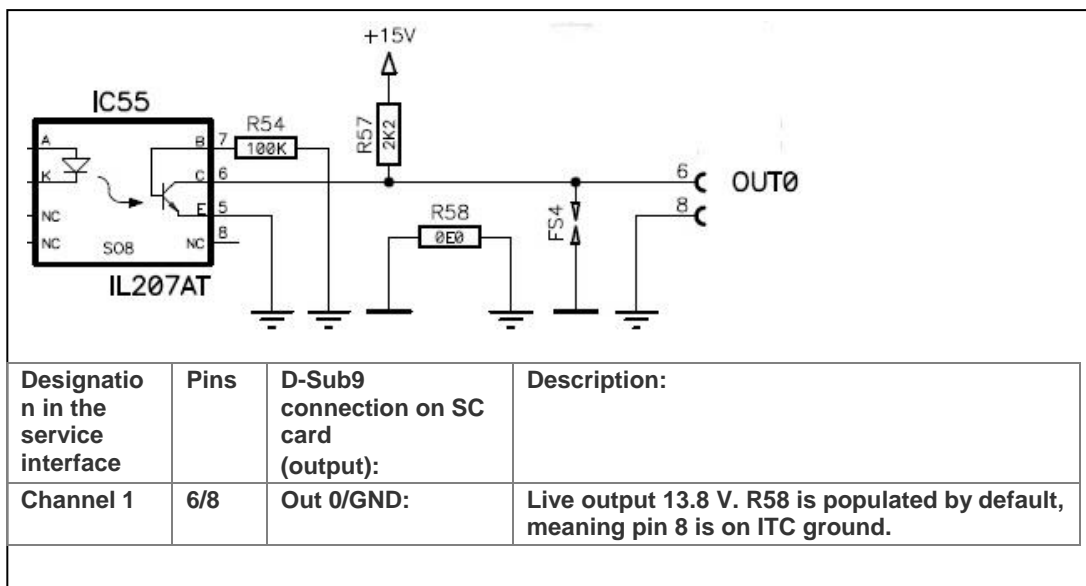

Figure 35: Pin assignment of the optocoupler output on the SC card

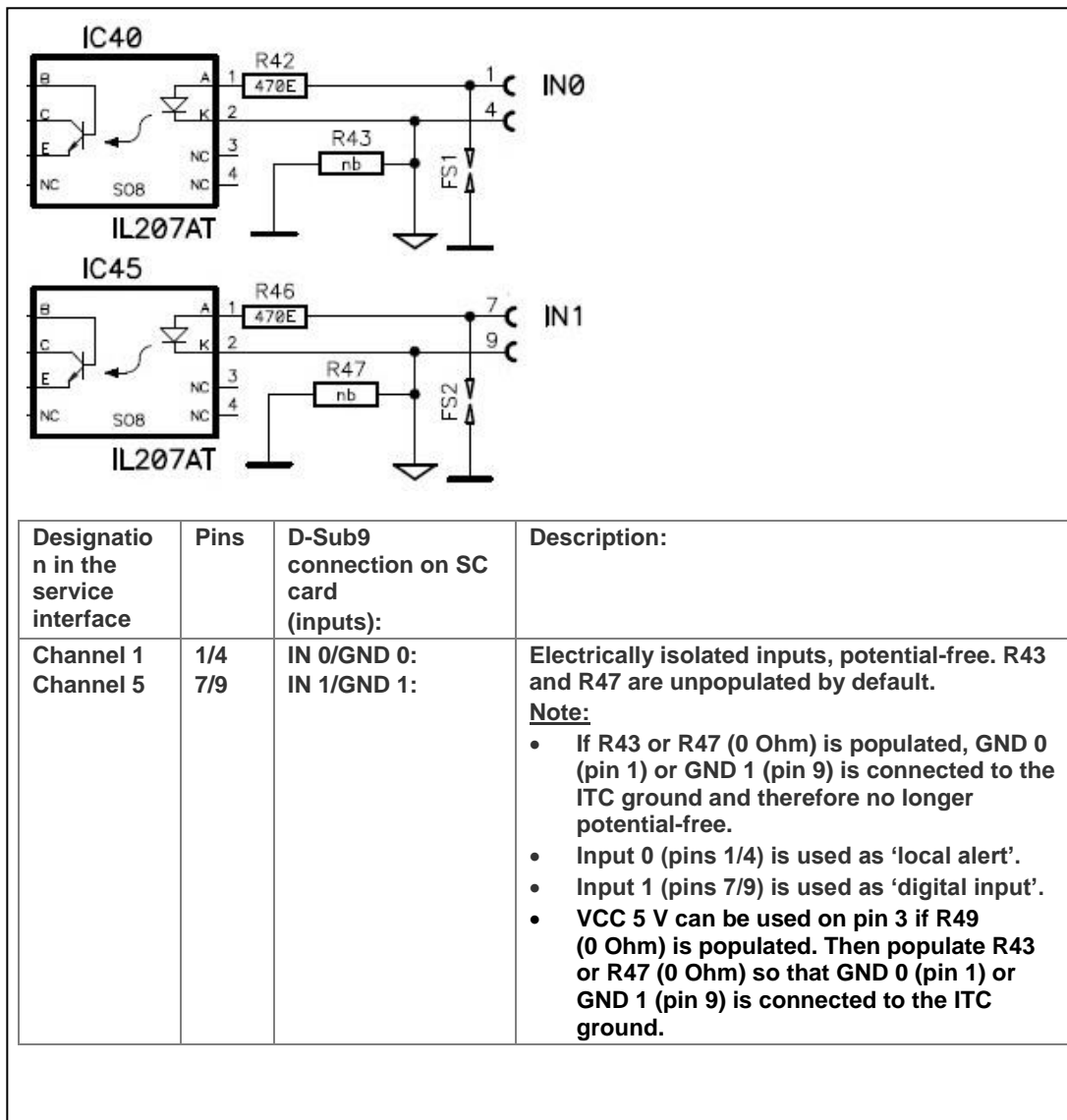

Figure 36: Pin assignment of the optocoupler inputs on the SC card

7.5 Digital decoder card (RC or RC09)

The 'RC' decoder card can decode 512, 1200 and 2400 baud. The 'RC09' decoder card can also decode 4800 baud and is able to recognise the baud rate automatically.

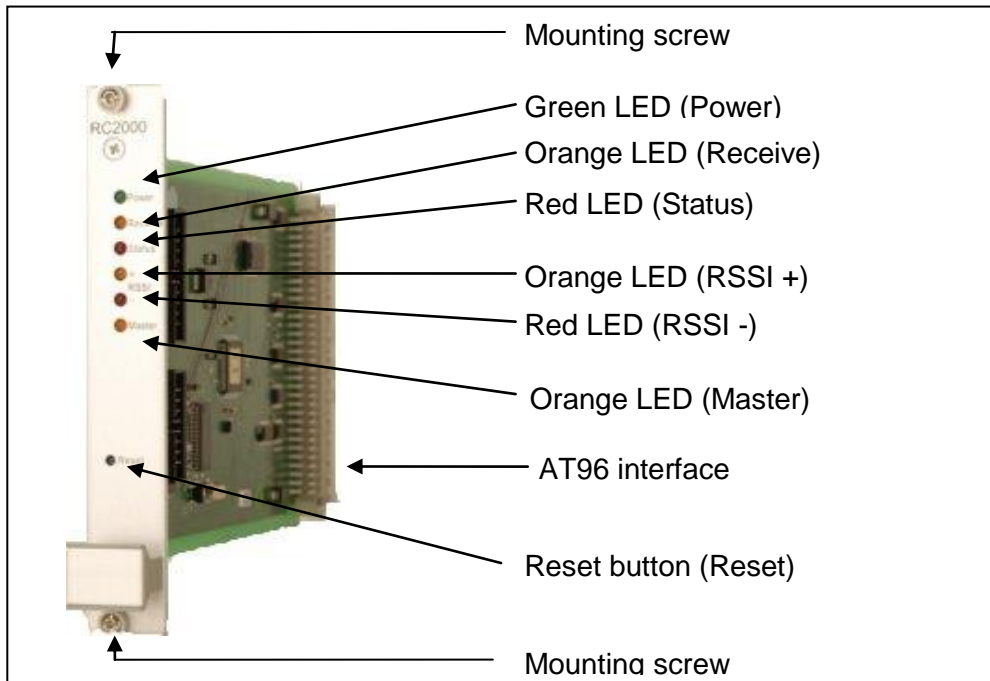

Figure 37: Digital decoder card (RC or RC09)

The decoder card (RC or RC09) is responsible for decoding the received data and transmitting it to the BSC. In addition, the receiver is programmed over an I²C connection. The receiver card has the European card format (3 RU) and is connected to the AT96 bus. The following displays and buttons are located on the front:

- LEDs (Power, Receive, Status, RSSI, Master)
- Reset button: Resets all registers and generates a BSC interrupt

LED type	Description
Green LED (Power) is lit	Power is supplied to the receiver card.
Orange LED (Receive) is lit	Lit when the receiver detects a synch word from the air.
Red LED (Status) is lit	A status of the receiver is out of order (for example, PLL not engaged).
Orange LED (RSSI +) is lit	When this LED is lit, the received field strength is okay, meaning good to very good. Both RSSI LEDs light up when this value falls to a critical level. While the base station is still receiving properly, the receiving equipment has to be checked.
Red LED (RSSI -) is lit	If only this red LED is lit, the received field strength is at an unacceptable level.
Orange LED (Master) is lit	The base station is configured as the master.

Table 17: Functional description of the RC card LEDs

After a restart, the RSSI measurement LED (RSSI +, RSSI -) only lights up after receiving a broadcast message.

The received field strength of a message should be over -90 dBm at the antenna port. This is necessary for a sufficiently large margin (min. 20dB) in the transmission path. The exact value can be read in the Status menu of the service web interface under 'Link receiver (RX)'.

Received field strength		'RSSI +' LED	'RSSI -' LED
Good	> -90 dBm	On	Off
Critical	-90 dBm .. -100 dBm	On	On
Poor	< -100 dBm	Off	On

Table 18: Status displays of the RSSI LEDs

7.6 GPS receiver card

The GPS receiver card is a 3RU card connected to the controller card via the AT96 bus. It features a LEA-5H GPS chip set from uBlox. All passive or active GPS antennas with an operating voltage of +5 V DC (max. 100 mA) can be connected via the SMA jack on the front panel. Together with the synchro card, it is responsible for synchronised data transfer to the transmitter of the radio device (to neighbouring radio base stations). The yellow Sync LED flashes whenever the GPS chip has generated a time pulse. Cable delay compensation is fully configurable to the nanosecond range.

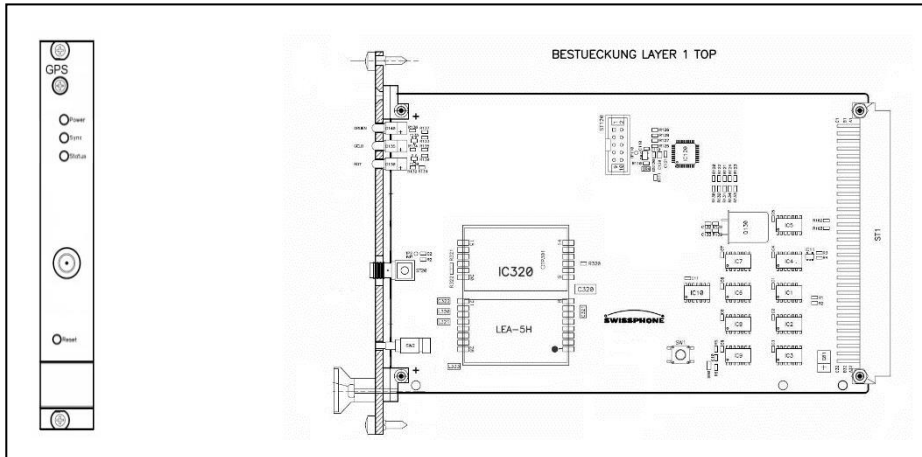

Figure 38: GPS receiver card

Technical data

Type:	Swissphone GPS receiver card	
Dimensions (WxHxD):	20.32 mm (4HP) x 133.35 mm (3RU) x 185 mm	
Power supply:	5 VDC	
Antenna port:	SMA socket	
GPS receiver:	uBlox LEA-5H 50 channels GPS L1 frequency, C/A code GALILEO Open Service L1 frequency	
Time-to-first-fix:	Cold start (autonomous)	29 s
	Warm start (autonomous)	29 s
	Hot start (autonomous)	<1 s
Sensitivity:	Tracking & navigation	-160 dBm
	Acquisition	-160 dBm
	Cold start (autonomous)	-145 dBm
Horizontal position accuracy:	Autonomous	< 2.5 m
	SBAS	< 2 m
Max. navigation update rate:	4 Hz	

7.7 I/O card

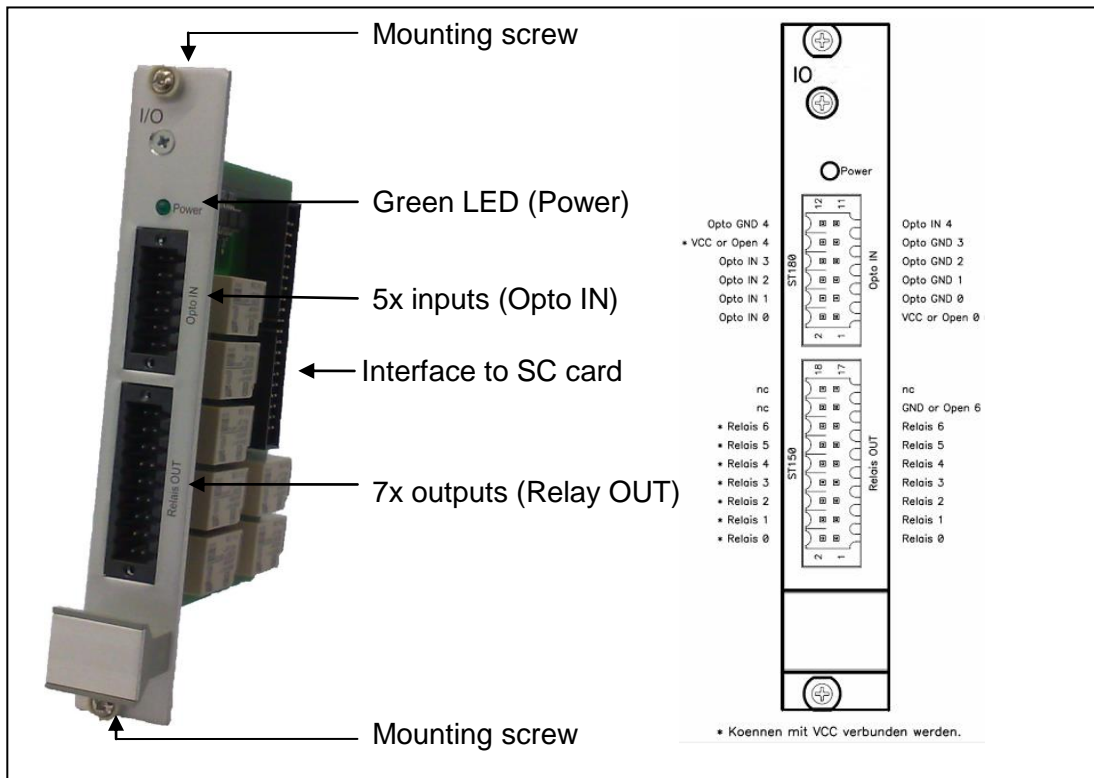

Figure 39: I/O card

The I/O card has five inputs and seven outputs. Adding the SC card expands the total number to seven inputs and eight outputs.

The I/O card meets the following requirements:

Number of inputs:	5
Current/voltage range on the opto inputs:	5–25 mA, 5–15 V
Number of outputs:	7
Nominal current/voltage on the relay outputs:	40 mA, 5 VDC
Maximum voltage on the relay outputs:	6.5 VDC
Connecting plug type:	Weidmüller S2L 3.5 - 18
Connecting wire diameter:	1 mm ²

The assignment of all inputs is described below. On Opto IN 0 and 4, the 13.8 V supply of the I/O card can be used to operate external circuits thanks to an equipment version. The maximum cross-section of the connecting wire is 1 mm².

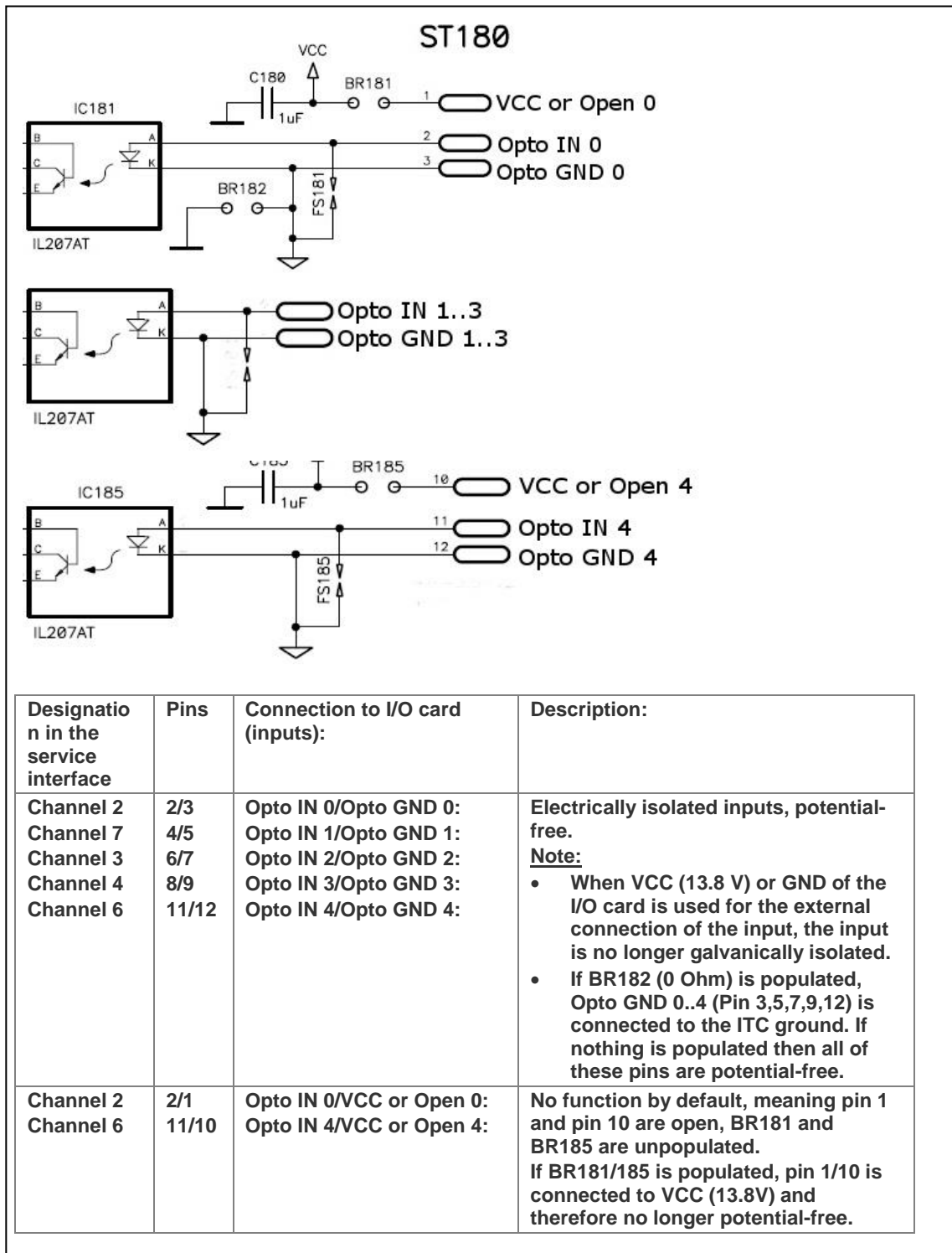

Figure 40: Pin assignment of the optocoupler inputs on the I/O card

The connection of all outputs is described below. On the relay outputs, the 13.8 V supply of the I/O card can be used to operate external circuits thanks to an assembly variant. The

maximum available current draw is 10 A. The maximum cross-section of the connecting wire is 1 mm².

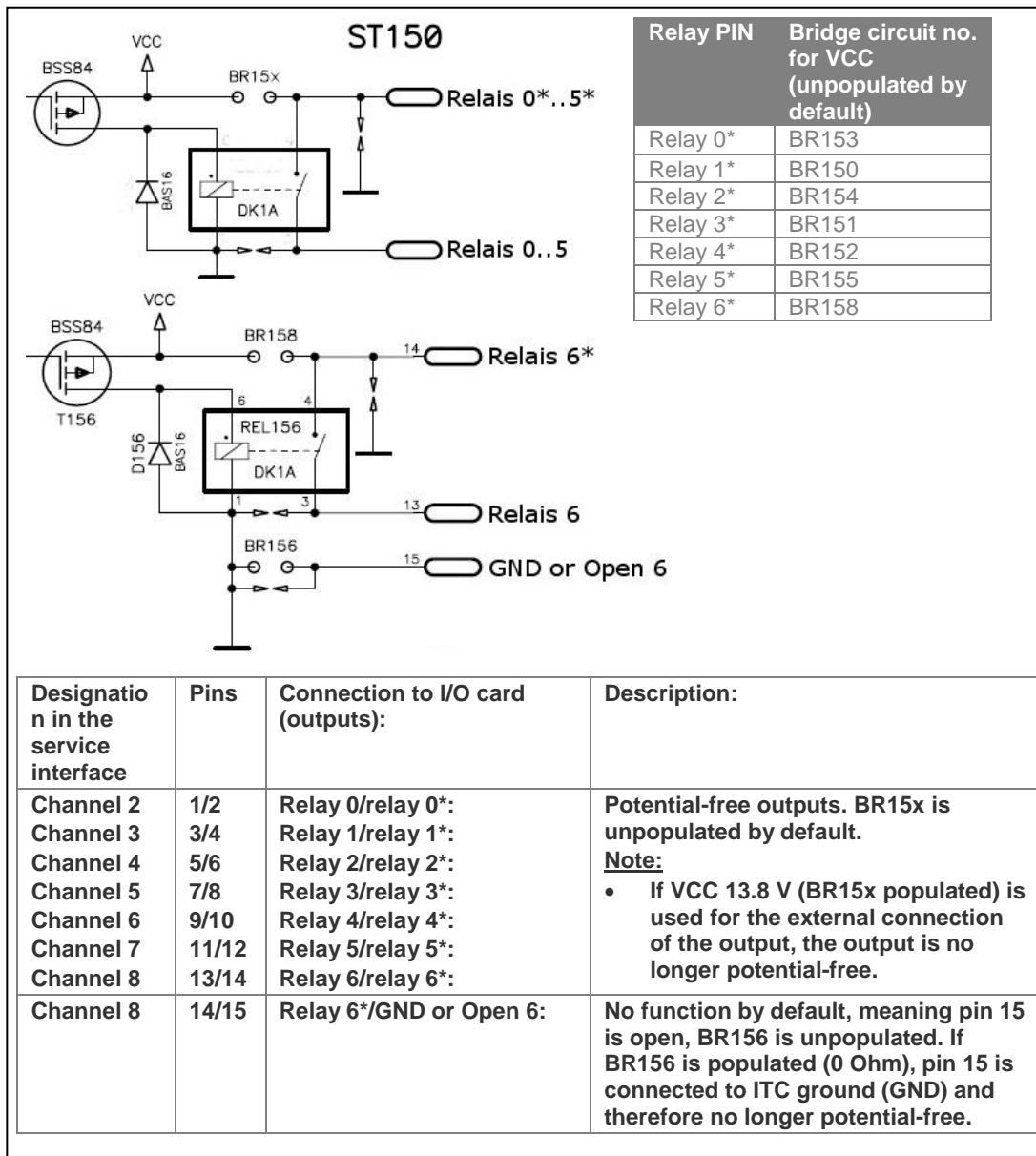

Figure 41: Pin assignment of the relay outputs on the I/O card

8 Module replacement in a service situation

This section describes the service activities on service level 2. These activities may only be carried out by qualified personnel on service level 2 trained by Swissphone.

8.1 Important notes

The ESD directives according to DIN EN 61340-5-1 for the protection of electronic components against electrostatic phenomena must be observed. Always touch the housing of the ITC2500 with one hand before you touch the respective module with your other hand. This is intended to avoid electrostatic charges and therefore prevent damage to the electronic components.

Replacing modules does not delay or extend existing guarantee or warranty periods. Guarantee or warranty periods that have already expired are not renewed by replacing modules.

8.2 Replacing the 12 V 12 Ah battery

Procedure:

- 1) Power down the ITC2500
- 2) Turn off the main switch on the power supply (set switch to '0').
- 3) Disconnect the mains cable
- 4) Disconnect the old battery from the ITC2500
- 5) Connect the new battery to the ITC2500 (see Section 5.10)
Warning: Connect the battery with the correct polarity (+/-). There is no reverse polarity protection!
- 6) Connect the mains cable
- 7) Turn on the main switch on the power supply (set switch to '1'). The ITC2500 boots up.
- 8) Functional control
 - The green LED on the controller card is lit.
 - The green LED on the power supply is lit in green.
 - Check battery operation by disconnecting the mains cable (the ITC2500 should continue running).

8.3 Replacing the power supply (PS 150W/PS 150W-B)

The PS 150W (article no. 0710046) and PS 150W-B (article no. 0710049) power supplies are interchangeable. We recommend using the newer PS 150W-B power supply as a replacement. Procedure:

- 1) Power down the ITC2500
- 2) Turn off the main switch on the power supply (set switch to '0').
- 3) Disconnect the mains cable
- 4) Disconnect the battery from the ITC2500
- 5) Remove the defective power supply.
 - Loosen the four mounting screws (on each of the corners of the front panel).
 - Pull out the power supply.
- 6) Install the new power supply
 - Slide the new power supply into the module guide rails provided.
 - Tighten the four mounting screws (on each of the corners of the front panel).
- 7) Connect the battery

Warning: Connect the battery with the correct polarity (+/-). There is no reverse polarity protection!
- 8) Connect the mains cable
- 9) Turn on the main switch on the power supply (set switch to '1'). The ITC2500 boots up.
- 10) Functional control
 - The green LED on the controller card is lit.
 - The green LED on the power supply is lit in green (=mains supply okay).
 - If the 'Power supply:' field in the status window of the web service interface shows OK and, after clicking the 'Power supply' link, the 'Network operation:' field shows OK, the new power supply is working properly.

8.4 Replacing the transceiver module (TRx 40/50W)

Procedure:

- 1) Power down the ITC2500
- 2) Turn off the main switch on the power supply (set switch to '0').
- 3) Disconnect the mains cable
- 4) Disconnect the coaxial cable for the antenna
- 5) Remove the defective transceiver module
 - Loosen the four mounting screws (on each of the corners of the front panel).
 - Pull out the transceiver module
- 6) Note the parameters of the new transceiver module (for later input in the service web interface). These are the values 'RSSI low', 'RSSI high', 'Delay Rx' and 'Delay Tx' (see Figure 42).



Figure 42: Reading the values 'RSSI low'/'RSSI high' and 'Delay Rx'/'Delay Rx'

- 7) Install the new transceiver module
 - Slide the new transceiver modules into the module guide rails provided
 - Tighten the four mounting screws (on each of the corners of the front panel).
- 8) Connect the coaxial antenna cable
- 9) Connect the mains cable
- 10) Turn on the main switch on the power supply (set switch to '1'). The ITC2500 boots up.
- 11) Enter the Rx/Tx delay and the RSSI voltage values (ADC) of the new transceiver module in the web interface (see Section 6.4.3).
- 12) Functional control
 - The green LED on the controller card is lit.
 - The green LED on the power supply is lit in green (=mains supply okay).
 - In the status window of the web service interface, the fields 'Sender (TX)' and 'Receiver (RX)' are green.

8.5 Replacing the controller (BSC)

The current controller type is described in Section 7.3.

Information: Using the current controller type requires kernel version 5.1.25 or higher. If the kernel version is lower, a flash card with new software must be ordered from Swissphone and installed. The kernel version can be checked in the service web interface under Service > Software Update > Current Version (see Figure 43).

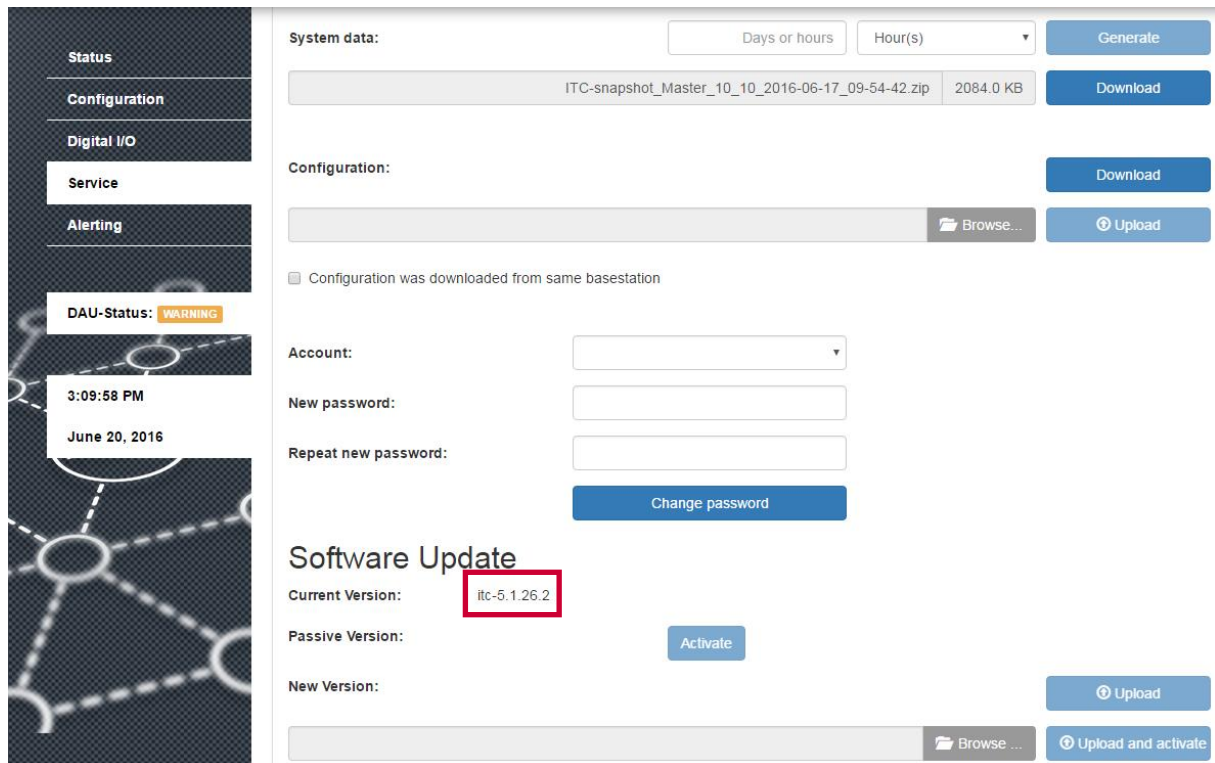

Figure 43: Checking the kernel version

Procedure:

- 1) Power down the ITC2500
- 2) Turn off the main switch on the power supply (set switch to '0').
- 3) Disconnect the mains cable
- 4) Remove the defective controller
 - Loosen the four mounting screws (on each of the corners of the front panel).
 - Pull out the controller card
 - Disconnect the connecting cable from the controller
 - Disconnect the flash card (if still intact) from the controller
- 5) Install the new controller
 - Install the flash card in the controller. Insert a new flash card if necessary (with the latest software version, available from Swissphone)

Important: Do not use the flash card from an old controller type with the new controller type. In this case, be sure to order and use a flash card with the new software version.

- Correctly connect the connecting cable to the controller (see Figure 44)
 - Slide the new controller card into the module guide rails provided
 - Tighten the four mounting screws (on each of the corners of the front panel).
- 6) Connect the mains cable
- 7) Turn on the main switch on the power supply (set switch to '1'). The ITC2500 boots up.
- 8) Functional control
- The green LED on the controller card is lit.
 - In the status window of the web service interface, the 'BS Controller:' field is green or yellow.

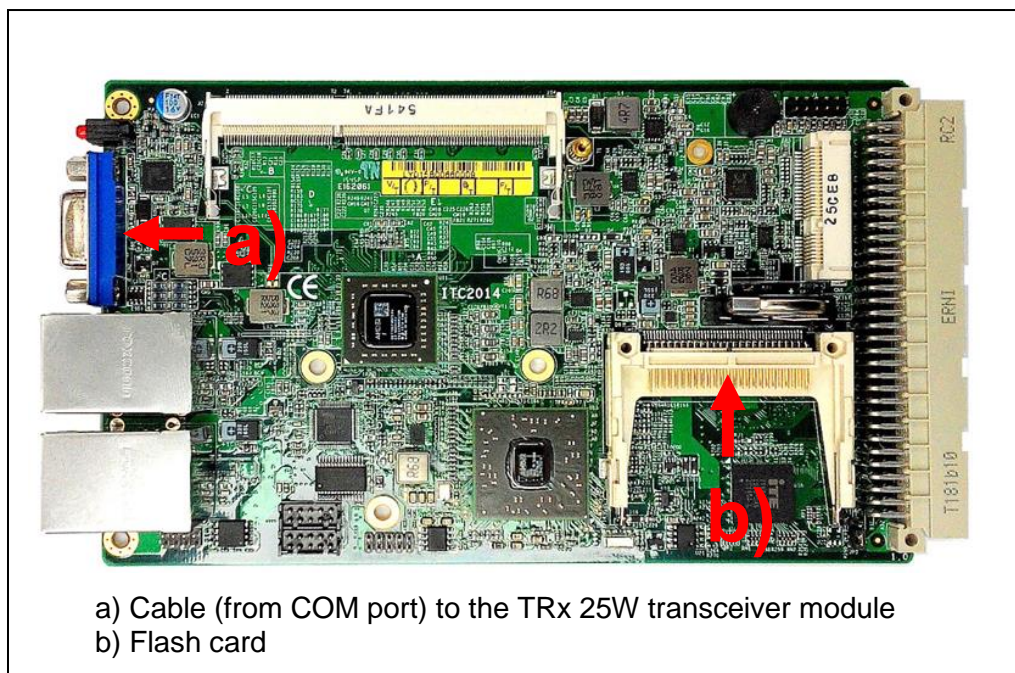

Figure 44: Controller wiring

8.6 Replacing the RC09 card

Procedure:

- 1) Power down the ITC2500
- 2) Turn off the main switch on the power supply (set switch to '0').
- 3) Disconnect the mains cable
- 4) Disconnect the battery from the ITC2500
- 5) Remove the defective RC09 card
 - Loosen the two mounting screws (on each of the corners of the front panel)
 - Pull out the RC09 card
 - Disconnect the connecting cable from the RC09 card
- 6) Install the new RC09 card
 - Correctly connect the connecting cable to the RC09 card (see Figure 45)
 - Slide the new RC09 card into the module guide rails provided
 - Tighten the two mounting screws (on each of the corners of the front panel)
- 7) Connect the mains cable
- 8) Turn on the main switch on the power supply (set switch to '1'). The ITC2500 boots up.
- 9) Functional control
 - The green LED on the RC09 card is lit.
 - 'PLL Locking', 'Programming', 'RC Device' must show **OK** in the web service menu Überwachung > Status > Empfänger RX.

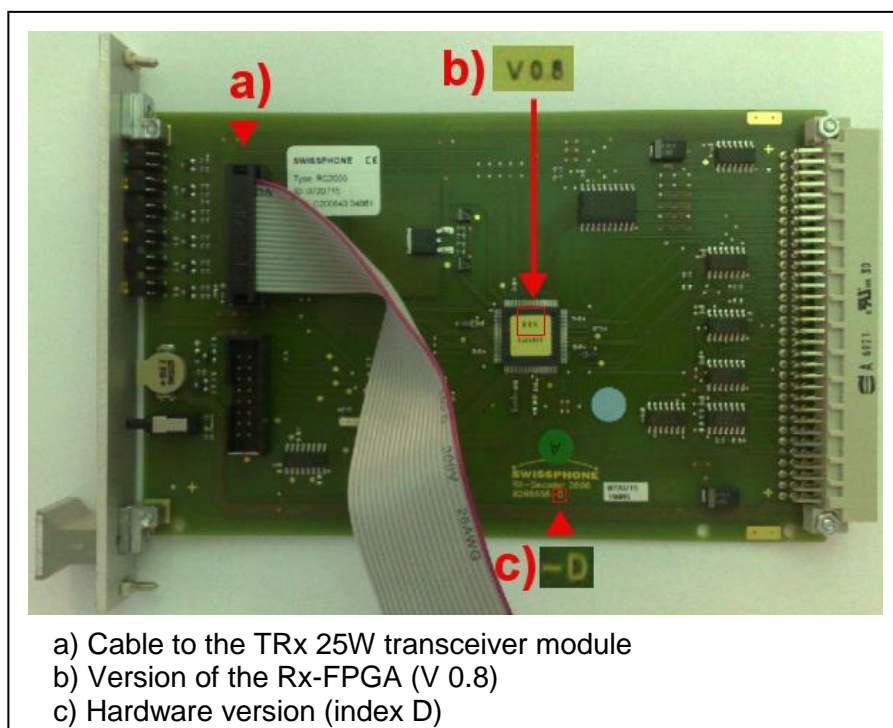

Figure 45: Wiring of the RC or RC09 card

8.7 Replacing the SC card

Important: The FPGA version of the SC card must be V1.8 or higher (see Figure 46).

Procedure:

- 1) Power down the ITC2500
- 2) Turn off the main switch on the power supply (set switch to '0').
- 3) Disconnect the mains cable
- 4) Disconnect the battery from the ITC2500
- 5) Remove the defective SC card
 - Loosen the two mounting screws (on each of the corners of the front panel)
 - Pull out the SC card
 - Disconnect the connecting cable from the SC card
- 6) Install the new SC card
 - Correctly connect the connecting cable to the SC card (see figure below)
 - Slide the new SC card into the module guide rails provided
 - Tighten the two mounting screws (on each of the corners of the front panel)
- 7) Connect the mains cable
- 8) Turn on the main switch on the power supply (set switch to '1'). The ITC2500 boots up.
- 9) Functional control
 - The green LED on the SC card is lit
 - 'SC Device' must show **OK** in the web service menu Überwachung > Status > Sender TX.

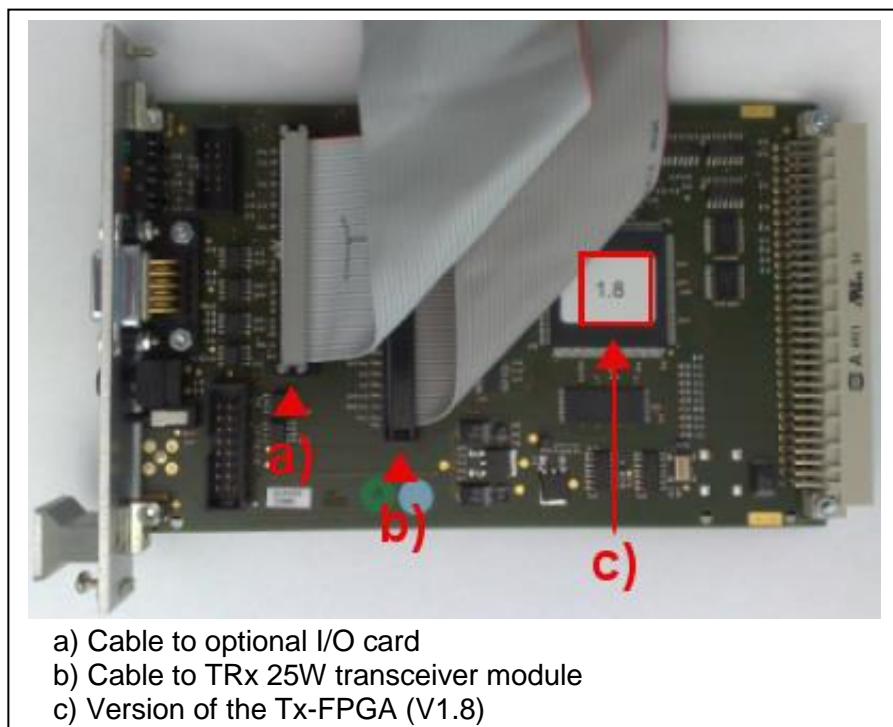

Figure 46: Wiring of the SC card

8.8 Replacing the I/O card

Procedure:

- 1) Power down the ITC2500
- 2) Turn off the main switch on the power supply (set switch to '0').
- 3) Disconnect the mains cable
- 4) Remove the defective I/O card
 - Loosen the two mounting screws (on each of the corners of the front panel)
 - Pull out the I/O card
 - Disconnect the connecting cable
- 5) Install the new I/O card (see Section 5.13)
 - Connect the connecting cable
 - Slide the new I/O card into the module guide rails provided
 - Tighten the two mounting screws (on each of the corners of the front panel)
- 6) Connect the mains cable
- 7) Turn on the main switch on the power supply (set switch to '1'). The ITC2500 boots up.
- 8) Functional control
 - The green LED on the I/O card is lit.
 - In the status window of the web service interface, the 'Hardware components:' field is green.

9 Replacement/spare parts and optional cards

The following components are replaced on a modular basis and can be ordered under the article numbers provided:

Article number	Description
0330095	Pb 12 V/12 Ah battery
0720010	Transceiver module 136-174MHz 50W
0720011	Transceiver module 400-470MHz 40W
0720012	Transceiver module 450-520MHz 40W
0722194	Flash card with current software V5.x.x
0721719	Power Supply Unit AC/DC 13.8V/5V 200W (for US customers only)
0721724	BSC: Controller card GT16R (without flash drive)
0721725	SC: Synchro card 0x500
0722196	RC09: POCSAG decoder card (multi-baud)
0721718	GPS: receiver card
0721706	I/O: interface card

Table 19: Replacement/spare parts and optional cards

Before replacing any components, the ITC2500 must be disconnected from the mains network and battery.



Swissphone always reserves the right to change the content of this document, either in part or in full, without prior notice. All rights reserved. All images and technical drawings used in this document are the property of Swissphone Wireless AG and may not be used without our consent. Company and product names mentioned in this document may be protected by trademark, brand or patent laws.

Manufacturer:

Swissphone Wireless AG
Fälmisstrasse 21
8833 Samstagern, Switzerland