

TEST REPORT

ACCORDING TO: FCC CFR 47 Part 15 subpart C, section 15.231 and subpart B,
RSS-210 issue 10 Annex A, RSS-Gen issue 5, ICES-003 Issue 6:2016

FOR:

Paradox Security Systems Ltd.

Wireless control panel board

Product name: MG5075

FCC ID: KDYMG5075

IC: 2438A-MG5075

This report is in conformity with ISO/IEC 17025. The "A2LA Accredited" symbol endorsement applies only to the tests and calibrations that are listed in the scope of Hermon Laboratories accreditation. The test results relate only to the items tested. This test report shall not be reproduced in any form except in full with the written approval of Hermon Laboratories Ltd.



Table of contents

1	Applicant information	3
2	Equipment under test attributes.....	3
3	Manufacturer information.....	3
4	Test details	3
5	Tests summary.....	4
6	EUT description.....	5
6.1	General information.....	5
6.2	Ports and lines	5
6.3	Changes made in EUT	5
6.4	Test configuration.....	6
6.5	Transmitter characteristics.....	7
7	Transmitter tests according to 47CFR part 15 subpart C and RSS-210 requirements.....	8
7.1	Periodic operation requirements.....	8
7.2	Field strength of emissions	11
7.3	Occupied bandwidth test.....	25
7.4	Conducted emissions	28
7.5	Antenna requirements	31
8	Unintentional emissions according to 47CFR part 15 subpart B and ICES-003 requirements	32
8.1	Conducted emissions	32
8.2	Radiated emission measurements	35
9	APPENDIX A Test equipment and ancillaries used for tests.....	39
10	APPENDIX B Test equipment correction factors.....	40
11	APPENDIX C Measurement uncertainties	43
12	APPENDIX D Test laboratory description	44
13	APPENDIX E Specification references	44
14	APPENDIX G Manufacturer's declaration about periodic operation	45
15	APPENDIX F Abbreviations and acronyms.....	46

1 Applicant information

Client name: Paradox Security Systems Ltd.
Address: 780 Industrial Boulevard St.Eustache, Quebec J7R 5V3 Canada
Telephone: 450-491-7444
Fax: 450-497-1095
E-mail: alexc@paradox.com
Contact name: Mr. Alex Chaplik

2 Equipment under test attributes

Product description: Wireless control panel board
Product type: Transceiver
Product name: MG5075
Serial number: E2000431
Hardware version: 910-2002-160
Software release: V1.03
Receipt date 31-Jun-20

3 Manufacturer information

Manufacturer name: Paradox Security Systems (Bahamas) Ltd
Address: 780 Industrial Boulevard St.Eustache, Quebec J7R 5V3 Canada
Telephone: 450-491-7444
Fax: 450-497-1095
E-Mail: rhamitouche@paradox.com
Contact name: Mr. Rabah Hamitouche



4 Test details

Project ID: 34150
Location: Hermon Laboratories Ltd. P.O. Box 23, Binyamina 3055001, Israel
Test started: 16-Jul-20
Test completed: 19-Jul-20
Test specification(s): FCC 47CFR part 15, subpart C, §15.231 and subpart B;
RSS-210 issue 10 Annex A, RSS-Gen issue 5, ICES-003 Issue 6:2016

5 Tests summary

Test	Status
Transmitter characteristics	
FCC Part 15, Section 231(a) / RSS-210, Section A1.1, Periodic operation requirements	Pass
FCC Part 15, Section 231(a) / RSS-210, Section A1.2, Field strength of emissions	Pass
FCC Part 15, Section 231(c) / RSS-210, Section A1.3, Occupied bandwidth	Pass
FCC Part 15, Section 207 / RSS-Gen, Section 8.8, Conducted emission	Pass
FCC Part 15, Section 203 / RSS-Gen, Section 8.3, Antenna requirements	Pass
Unintentional emissions	
FCC Part 15, Section 107 / ICES-003, Section 6.1 class B, Conducted emission at AC power port	Pass
FCC Part 15, Section 109 / RSS-Gen, Section 7.1.2/ ICES-003, Section 6.2 class B, Radiated emission	Pass

Testing was completed against all relevant requirements of the test standard. The results obtained indicate that the product under test complies in full with the requirements tested. The test results relate only to the items tested. Pass/ fail decision was based on nominal values.

	Name and Title	Date	Signature
Tested by:	Mr. I. Zilberstein, test engineer, EMC & Radio	16-Jul-20 – 19-Jul-20	
Reviewed by:	Mrs. S. Peysahov Sheynin, test engineer, EMC & Radio	13-Aug-20	
Approved by:	Mr. S. Samokha, technical manager, EMC & Radio	23-Aug-20	



6 EUT description

Note: The following data in this clause is provided by the customer and represents his sole responsibility

6.1 General information

The EUT is a wireless control panel board used for alarm systems. The EUT operates at 433.92 MHz. The EUT has a receiver of Class 2.

6.2 Ports and lines

Port type	Port description	Conn. from	Conn. to	Qty.	Cable type	Cable length, m	Indoor / outdoor
Power	Control panel AC	Control panel	AC mains	1	Unshielded	2 m	Indoor
Signal	BELL +/-	Control panel	Open circuit	2	Unshielded	3 m*	Indoor
Signal	Z1-Z5, C	Control panel	Open circuit	7	Unshielded	3 m*	Indoor
Telecom	R1, T1 (PSTN line output)	Control panel	Open circuit	2	Unshielded	3 m*	Indoor
Telecom	RING, TIP (PSTN line input)	Control panel	Open circuit	2	Unshielded	3 m*	Indoor
Signal	PGM-OUT 1 - PGM-OUT 4	Control panel	Open circuit	4	Unshielded	3 m*	Indoor
Interconnecting	AuX +, AUX -, GRN (BUS), YEL (BUS)	Control panel	Open circuit	4	Unshielded	3 m*	Indoor
GND	Ground	Control Panel	Open circuit	1	Unshielded	3m*	Indoor
* maximum length may be over 30 m							

6.3 Changes made in EUT

No changes were implemented in the EUT during testing.



6.4 Test configuration

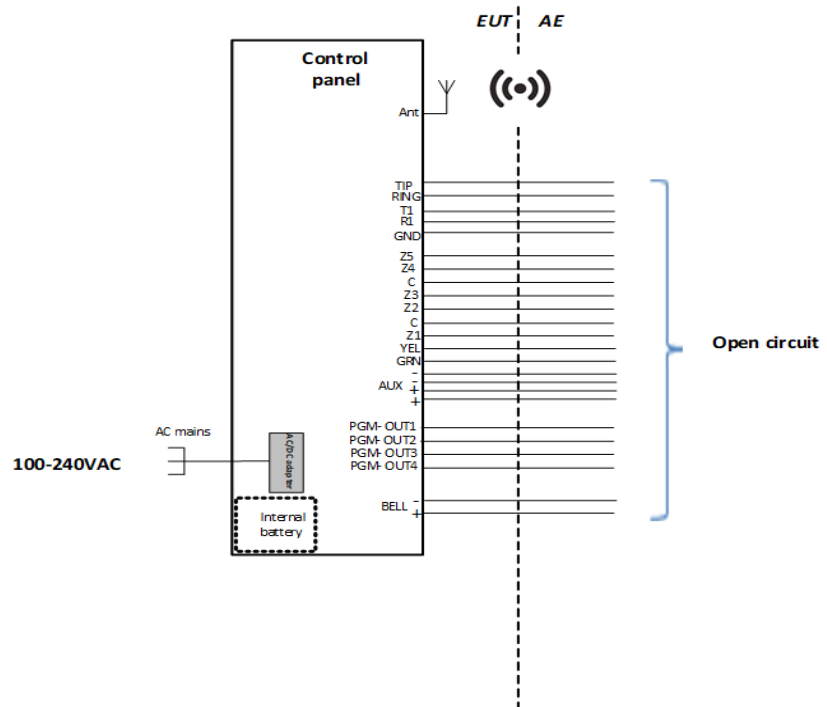



6.5 Transmitter characteristics

Type of equipment						
X	Stand-alone (Equipment with or without its own control provisions)					
	Combined equipment (Equipment where the radio part is fully integrated within another type of equipment)					
	Plug-in card (Equipment intended for a variety of host systems)					
Operating frequency		433.92 MHz				
Maximum rated output power		At transmitter 50 Ω RF output connector				
		Field strength at 3 m distance			91.49 dB(μV/m) – peak 71.92 dB(μV/m) -average	
Is transmitter output power variable?		X	No			
			Yes	continuous variable		
				stepped variable with stepsize		dB
				minimum RF power		dBm
		maximum RF power		dBm		
Antenna connection						
unique coupling	standard connector	X	integral	with temporary RF connector		
				X	without temporary RF connector	
Antenna/s technical characteristics						
Type	Manufacturer	Model number		Gain		
Integral	NA	125-0433-205		0 dbi		
Transmitter aggregate data rate/s		1.67 kbps				
Type of modulation		OOK				
Modulating test signal (baseband)		ID code				
Transmitter power source						
	Battery	Nominal rated voltage	VDC	Battery type		
	DC	Nominal rated voltage	VDC			
X	AC mains	Nominal rated voltage	120 VAC	Frequency	60 Hz	
Common power source for transmitter and receiver			X	yes	no	



Test specification: FCC Part 15, Section 231(a) / RSS-210, Section A1.1, Periodic operation requirements	
Test procedure: Supplier declaration	
Test mode: Compliance	Verdict: PASS
Date(s): 19-Jul-20	
Temperature: 23 °C	Relative Humidity: 55 %
Remarks:	

7 Transmitter tests according to 47CFR part 15 subpart C and RSS-210 requirements

7.1 Periodic operation requirements

7.1.1 General

The EUT was verified for compliance with periodic operation requirements listed below:

- Continuous transmissions such as voice, video and the radio control of toys are not permitted;
- A manually operated transmitter shall employ switch that will automatically deactivate the transmitter within not more than 5 seconds of being released;
- A transmitter activated automatically shall cease transmission within 5 seconds after activation;
- Periodic transmissions, excluding polling or supervision transmissions, at regular predetermined intervals are not permitted;
- Total duration of polling or supervision transmissions, including data, to determine system integrity in security or safety applications shall not exceed 2 seconds per hour;
- Transmission of set-up information for security systems may exceed the transmission duration limits of 5 seconds, provided such transmissions are under the control of a professional installer and do not exceed ten seconds after a manually operated switch is released or a transmitter is activated automatically. Such set-up information may include data.

The rationale for compliance with the above requirements was either test results or supplier declaration. The summary of results is provided in Table 7.1.1.

7.1.2 Test procedure for transmitter shut down test

7.1.2.1 The EUT was set up as shown in Figure 7.1.1.

7.1.2.2 The spectrum analyzer center frequency was adjusted to the EUT carrier, span set to zero and video triggered for transmission.

7.1.2.3 The transmitter was activated either manually or automatically. Once manually operated transmitter was activated, the switch was immediately released.

7.1.2.4 The transmission time was captured and shown in Plot 7.1.1.

7.1.3 Test procedure for measurements of polling / supervision transmission duration

7.1.3.1 The EUT was set up as shown in Figure 7.1.1.

7.1.3.2 The spectrum analyzer center frequency was adjusted to the EUT carrier, span set to zero and video triggered for transmission.

7.1.3.3 The transmission time was captured and shown in Plot 7.1.2, Plot 7.1.3.

Figure 7.1.1 Setup for transmitter shut down test





Test specification: FCC Part 15, Section 231(a) / RSS-210, Section A1.1, Periodic operation requirements	
Test procedure:	Supplier declaration
Test mode:	Compliance
Date(s):	19-Jul-20
Temperature: 23 °C	Relative Humidity: 55 %
Air Pressure: 1008 hPa	Power: 120 VAC, 60 Hz
Remarks:	
Verdict: PASS	

Table 7.1.1 Periodic operation requirements

Requirement	Rationale	Verdict
Continuous transmissions are not permitted	Supplier declaration*	Comply
A manually operated transmitter shall be deactivated within not more than 5 seconds of switch being released	NA	NA
Transmitter activated automatically shall cease transmission within 5 seconds	Plot 7.1.1	Comply
Periodic transmissions at regular predetermined intervals are not permitted	Supplier declaration*	Comply
Total duration of polling or supervision transmissions shall not exceed 2 seconds per hour	Plot 7.1.2, Plot 7.1.3	Comply
Transmission of set-up information for security systems may exceed the transmission duration limits of 5 seconds, provided such transmissions are under the control of a professional installer and do not exceed ten seconds after a manually operated switch is released or a transmitter is activated automatically. Such set-up information may include data.	Supplier declaration	Comply

* Provided in Appendix H.

Plot 7.1.1 Transmitter shut down test result

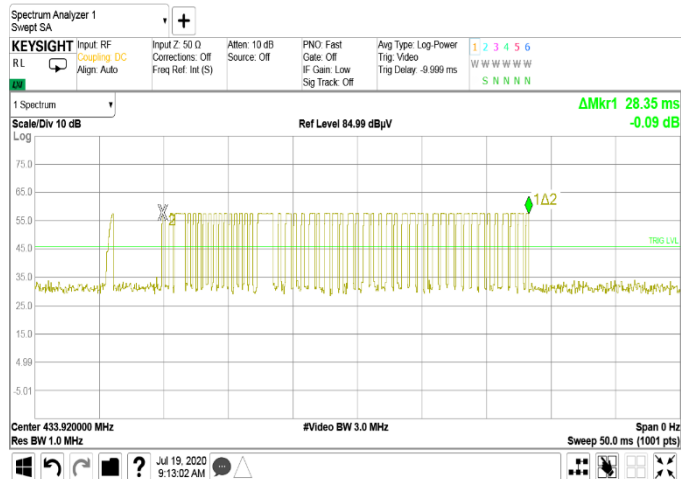



Test specification: FCC Part 15, Section 231(a) / RSS-210, Section A1.1, Periodic operation requirements			
Test procedure: Supplier declaration			
Test mode: Compliance		Verdict: PASS	
Date(s): 19-Jul-20			
Temperature: 23 °C	Relative Humidity: 55 %	Air Pressure: 1008 hPa	Power: 120 VAC, 60 Hz
Remarks:			

Plot 7.1.2 Polling / supervision transmission duration

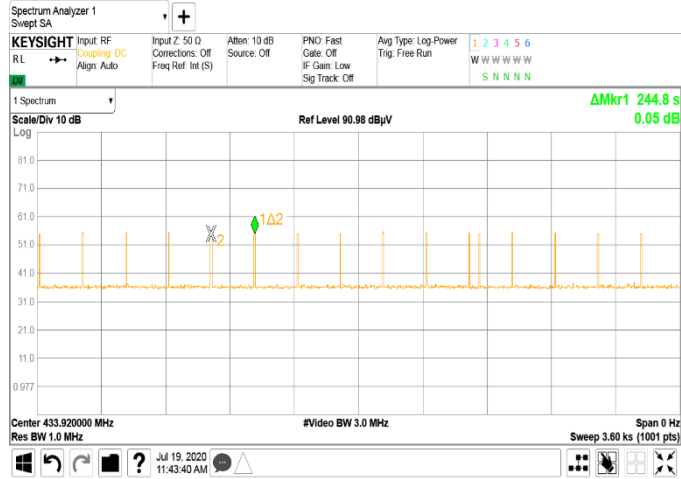

Table 7.1.2 Total duration of polling / supervision transmissions

Duration, ms	Repetition period, ms	Maximum number of transmissions within 1 hour	Total duration within 1 hour, ms
28.35	244.8	15	425.25

Reference numbers of test equipment used

HL 5376	HL 5397						
---------	---------	--	--	--	--	--	--

Full description is given in Appendix A



Test specification: FCC Part 15, Section 231(b) / RSS-210, Section A1. 2, Field strength of emissions			
Test procedure: ANSI C63.10 sections 6.5, 6.6			
Test mode: Compliance		Verdict: PASS	
Date(s): 19-Jul-20			
Temperature: 23 °C	Relative Humidity: 55 %	Air Pressure: 1008 hPa	Power: 120 VAC, 60 Hz
Remarks:			

7.2 Field strength of emissions

7.2.1 General

This test was performed to measure field strength of fundamental and spurious emissions from the EUT. Specification test limits are given in Table 7.2.1 and Table 7.2.2.

Table 7.2.1 Radiated fundamental emission limits

Fundamental frequency, MHz	Field strength at 3 m, dB(μV/m)	
	Peak	Average
433.92	100.8	80.8

Table 7.2.2 Radiated spurious emissions limits

Frequency, MHz	Field strength at 3 m, dB(μV/m)				
	Within restricted bands			Outside restricted bands	
	Peak	Quasi Peak	Average	Peak	Average
0.009 – 0.090	148.5 – 128.5	NA	128.5 – 108.5**	80.8	60.8
0.090 – 0.110	NA	108.5 – 106.8**	NA		
0.110 – 0.490	126.8 – 113.8	NA	106.8 – 93.8**		
0.490 – 1.705	NA	73.8 – 63.0**	NA		
1.705 – 30.0*		69.5			
30 – 88		40.0			
88 – 216		43.5			
216 – 960		46.0			
960 - 1000		54.0			
Above 1000	74.0	NA	54.0		

*- The limit for 3 m test distance was calculated using the inverse square distance extrapolation factor as follows:

$$Lim_{S2} = Lim_{S1} + 40 \log (S_1/S_2),$$

where S₁ and S₂ – standard defined and test distance respectively in meters.

** - The limit decreases linearly with the logarithm of frequency.

Note 1: The fundamental emission limit in dB(μV/m) was calculated as follows:

$$Lim_{AVR} = 20 \times \log(56.81818 \times F - 6136.3636) \text{ - within } 130 - 174 \text{ MHz band;}$$

$$Lim_{AVR} = 20 \times \log(41.6667 \times F - 7083.3333) \text{ - within } 260 - 470 \text{ MHz band,}$$

where F is the carrier frequency in MHz.

The limit for spurious emissions was 20 dB lower than fundamental emission limit.

The above limits provided in terms of average values, peak limit was 20 dB above the average limit.

Note 2: The above field strength limits applied from the lowest radio frequency generated in the device, without going below 9 kHz up to the tenth harmonic of the highest fundamental frequency.



Test specification: FCC Part 15, Section 231(b) / RSS-210, Section A1. 2, Field strength of emissions			
Test procedure: ANSI C63.10 sections 6.5, 6.6			
Test mode: Compliance		Verdict: PASS	
Date(s): 19-Jul-20			
Temperature: 23 °C	Relative Humidity: 55 %	Air Pressure: 1008 hPa	Power: 120 VAC, 60 Hz
Remarks:			

7.2.2 Test procedure for spurious emission field strength measurements in 9 kHz to 30 MHz band

7.2.2.1 The EUT was set up as shown in Figure 7.2.1, energized and the performance check was conducted.

7.2.2.2 The specified frequency range was investigated with antenna connected to spectrum analyzer/ EMI receiver. To find maximum radiation the turntable was rotated 360° and the measuring antenna was rotated around its vertical axis.

7.2.2.3 The worst test results (the lowest margins) were recorded in Table 7.2.3, Table 7.2.4, Table 7.2.6, Table 7.2.7 and shown in the associated plots.

7.2.3 Test procedure for spurious emission field strength measurements above 30 MHz

7.2.3.1 The EUT was set up as shown in Figure 7.2.2, Figure 7.2.3, energized and the performance check was conducted.

7.2.3.2 The specified frequency range was investigated with antenna connected to spectrum analyzer/ EMI receiver. To find maximum radiation the turntable was rotated 360°, the measuring antenna height was changed from 1 to 4 m, its polarization was switched from vertical to horizontal.

7.2.3.3 The worst test results (the lowest margins) were recorded in Table 7.2.3, Table 7.2.4, Table 7.2.6, Table 7.2.7 and shown in the associated plots.

Figure 7.2.1 Setup for spurious emission field strength measurements below 30 MHz

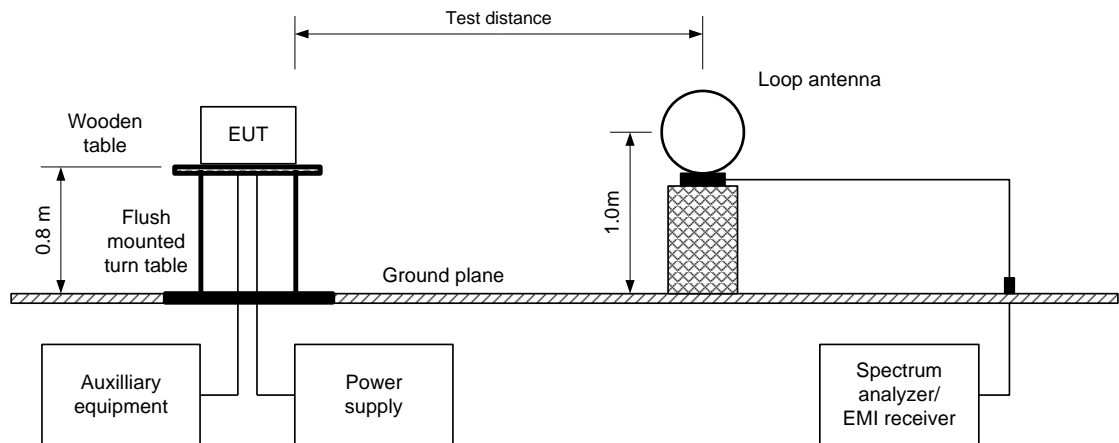



Test specification: FCC Part 15, Section 231(b) / RSS-210, Section A1. 2, Field strength of emissions			
Test procedure: ANSI C63.10 sections 6.5, 6.6			
Test mode: Compliance		Verdict:	PASS
Date(s): 19-Jul-20			
Temperature: 23 °C	Relative Humidity: 55 %	Air Pressure: 1008 hPa	Power: 120 VAC, 60 Hz
Remarks:			

Figure 7.2.2 Setup for spurious emission field strength measurements in 30 -1000 MHz

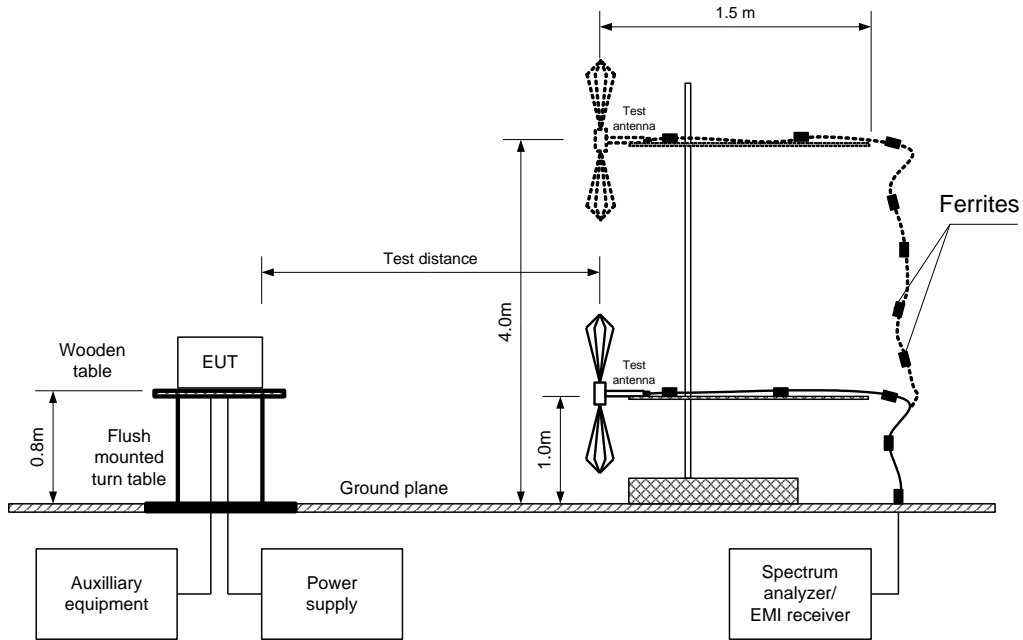
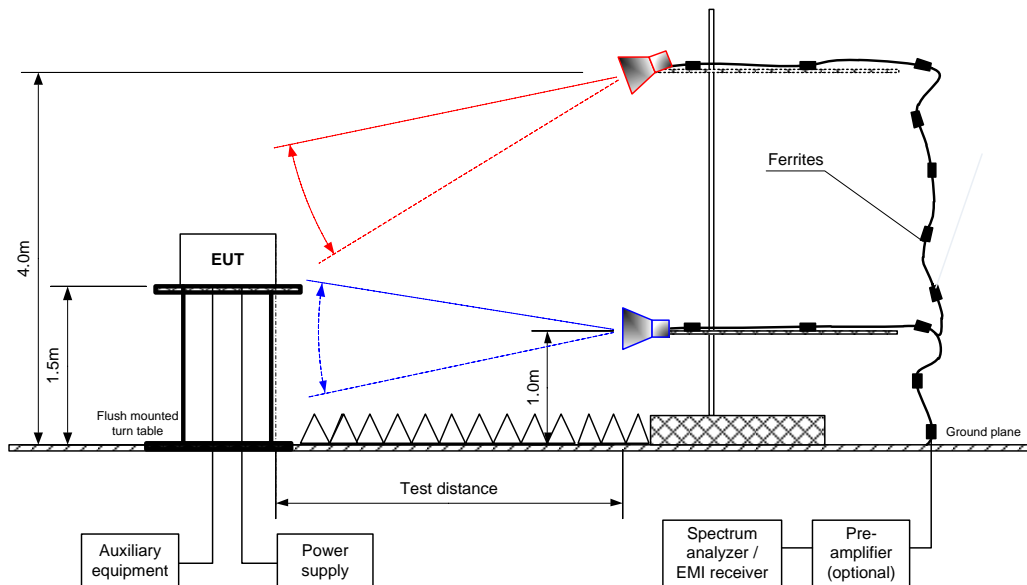

Figure 7.2.3 Setup for spurious emission field strength measurements above 1000 MHz





Test specification: FCC Part 15, Section 231(b) / RSS-210, Section A1. 2, Field strength of emissions			
Test procedure: ANSI C63.10 sections 6.5, 6.6			
Test mode: Compliance		Verdict: PASS	
Date(s): 19-Jul-20			
Temperature: 23 °C	Relative Humidity: 55 %	Air Pressure: 1008 hPa	Power: 120 VAC, 60 Hz
Remarks:			

Table 7.2.3 Field strength of fundamental emission, spurious emissions outside restricted bands below 1 GHz

TEST DISTANCE: 3 m
 EUT POSITION: Typical (Vertical)
 MODULATION: OOK
 BIT RATE: 1.67 kbps
 INVESTIGATED FREQUENCY RANGE: 0.009 – 4500 MHz
 DETECTOR USED: Peak
 RESOLUTION BANDWIDTH: 0.2 kHz (9 kHz – 150 kHz)
 9.0 kHz (150 kHz – 30 MHz)
 120 kHz (30 MHz – 1000 MHz)
 VIDEO BANDWIDTH: ≥ Resolution bandwidth
 TEST ANTENNA TYPE: Active loop (9 kHz – 30 MHz)
 Biconilog (30 MHz – 1000 MHz)

F, MHz	Antenna		Azimuth, degrees*	Peak field strength			Average field strength				Verdict
	Pol.	Height, m		Measured, dB(μV/m)	Limit, dB(μV/m)	Margin, dB**	Measured, dB(μV/m)	Calculated, dB(μV/m)	Limit, dB(μV/m)	Margin, dB**	
Fundamental emission***											
433.9075	V	1.2	40	91.49	100.8	-9.31	91.49	71.92	80.8	-8.88	Pass
Spurious emissions											
36.966	V	1.04	58	31.23	80.8	-49.57	31.23	11.66	60.8	-49.14	Pass
38.588	V	1.02	149	37.76	80.8	-43.04	37.76	18.19	60.8	-42.61	
43.129	V	1.02	14	32.79	80.8	-48.01	32.79	13.22	60.8	-47.58	
66.180	V	1.04	58	26.39	80.8	-54.41	26.39	6.82	60.8	-53.98	
76.277	V	1.04	219	26.77	80.8	-54.03	26.77	7.20	60.8	-53.60	
92.231	V	1.02	104	27.75	80.8	-53.05	27.75	8.18	60.8	-52.62	
288.035	V	1.02	152	31.25	80.8	-49.55	31.25	11.68	60.8	-49.12	

*- EUT front panel refers to 0 degrees position of turntable.

** - Margin, dB = Measured (calculated) value, dB(μV/m) - Limit, dB(μV/m)

Table 7.2.4 Spurious emissions within restricted bands at frequencies above 1 GHz

TEST DISTANCE: 3 m
 EUT POSITION: Typical
 MODULATION: OOK
 BIT RATE: 1.67 kbps
 INVESTIGATED FREQUENCY RANGE: 1000 – 4500 MHz
 DETECTOR USED: Peak
 RESOLUTION BANDWIDTH: 1.0 MHz (above 1000 MHz)
 VIDEO BANDWIDTH: ≥ Resolution bandwidth
 TEST ANTENNA TYPE: Double ridged guide (above 1000 MHz)

F, MHz	Antenna		Azimuth, degrees*	Peak field strength			Average field strength				Verdict
	Pol.	Height, m		Measured, dB(μV/m)	Limit, dB(μV/m)	Margin, dB**	Measured, dB(μV/m)	Calculated, dB(μV/m)	Limit, dB(μV/m)	Margin, dB**	
Spurious emissions											
1301.930	H	2.34	222	36.15	74.0	-37.85	23.44	23.44	54.0	-30.56	Pass

*- EUT front panel refers to 0 degrees position of turntable.

** - Margin, dB = Measured (calculated) value, dB(μV/m) - Limit, dB(μV/m)



Test specification: FCC Part 15, Section 231(b) / RSS-210, Section A1. 2, Field strength of emissions			
Test procedure: ANSI C63.10 sections 6.5, 6.6			
Test mode: Compliance		Verdict: PASS	
Date(s): 19-Jul-20			
Temperature: 23 °C	Relative Humidity: 55 %	Air Pressure: 1008 hPa	Power: 120 VAC, 60 Hz
Remarks:			

Table 7.2.5 Average factor calculation

Transmission pulse		Transmission burst		Transmission train duration, ms	Average factor, dB
Duration, ms	Period, ms	Duration, ms	Period, ms		
10.5	100.0	NA	NA	NA	-19.57

*- Average factor was calculated as follows
for pulse train shorter than 100 ms:

$$Average\ factor = 20 \times \log_{10} \left(\frac{Pulse\ duration}{Pulse\ period} \times \frac{Burst\ duration}{Train\ duration} \times Number\ of\ bursts\ within\ pulse\ train \right)$$

for pulse train longer than 100 ms:

$$Average\ factor = 20 \times \log_{10} \left(\frac{Pulse\ duration}{Pulse\ period} \times \frac{Burst\ duration}{100ms} \times Number\ of\ bursts\ within\ 100ms \right)$$

Table 7.2.6 Field strength of spurious emissions outside restricted bands at frequencies above 1 GHz

TEST DISTANCE: 3 m
 EUT POSITION: Typical
 MODULATION: OOK
 BIT RATE: 1.67 kbps
 INVESTIGATED FREQUENCY RANGE: 0.009 – 4500 MHz
 DETECTOR USED: Peak
 RESOLUTION BANDWIDTH: 0.2 kHz (9 kHz – 150 kHz)
 9.0 kHz (150 kHz – 30 MHz)
 120 kHz (30 MHz – 1000 MHz)
 1.0 MHz (above 1000 MHz)
 VIDEO BANDWIDTH: ≥ Resolution bandwidth
 TEST ANTENNA TYPE: Active loop (9 kHz – 30 MHz)
 Biconilog (30 MHz – 1000 MHz)
 Double ridged guide (above 1000 MHz)

F, MHz	Antenna		Azimuth, degrees*	Peak field strength			Average field strength				Verdict
	Pol.	Height, m		Measured, dB(μV/m)	Limit, dB(μV/m)	Margin, dB**	Measured, dB(μV/m)	Calculated, dB(μV/m)	Limit, dB(μV/m)	Margin, dB**	
Spurious emissions											
1735.921	H	2.65	157	38.57	80.8	-42.23	38.57	19.00	60.8	-41.80	Pass
2169.730	H	2.24	196	41.12	80.8	-39.68	41.12	21.55	60.8	-39.25	Pass
2614.963	H	2.24	360	38.15	80.8	-42.65	38.15	18.58	60.8	-42.22	Pass
3471.566	V	1.62	183	42.61	80.8	-38.19	42.61	23.04	60.8	-37.76	Pass

*- EUT front panel refers to 0 degrees position of turntable.

**- Margin, dB = Measured (calculated) value, dB(μV/m) - Limit, dB(μV/m)



Test specification:	FCC Part 15, Section 231(b) / RSS-210, Section A1. 2, Field strength of emissions		
Test procedure:	ANSI C63.10 sections 6.5, 6.6		
Test mode:	Compliance	Verdict: PASS	
Date(s):	19-Jul-20		
Temperature: 23 °C	Relative Humidity: 55 %	Air Pressure: 1008 hPa	Power: 120 VAC, 60 Hz
Remarks:			

Table 7.2.7 Field strength of emissions below 1 GHz within restricted bands

TEST DISTANCE: 3 m
EUT POSITION: Typical
MODULATION: OOK
BIT RATE: 1.67 kbps
INVESTIGATED FREQUENCY RANGE: 0.009 – 1000 MHz
DETECTOR USED: Peak
RESOLUTION BANDWIDTH: 0.2 kHz (9 kHz – 150 kHz)
9.0 kHz (150 kHz – 30 MHz)
120 kHz (30 MHz – 1000 MHz)
VIDEO BANDWIDTH: ≥ Resolution bandwidth
TEST ANTENNA TYPE: Active loop (9 kHz – 30 MHz)
Biconilog (30 MHz – 1000 MHz)

Frequency, MHz	Peak emission, dB(μV/m)	Quasi-peak			Antenna polarization	Antenna height, m	Turn-table position**, degrees	Verdict
		Measured emission, dB(μV/m)	Limit, dB(μV/m)	Margin, dB*				
Not found								Pass

*- Margin = Measured emission - specification limit.

** - EUT front panel refer to 0 degrees position of turntable.

Reference numbers of test equipment used

HL 4360	HL 5288	HL 4933	HL 0446	HL 5405	HL 3903	HL 5311	HL 5085
---------	---------	---------	---------	---------	---------	---------	---------

Full description is given in Appendix A.



Test specification: FCC Part 15, Section 231(b) / RSS-210, Section A1. 2, Field strength of emissions			
Test procedure: ANSI C63.10 sections 6.5, 6.6			
Test mode: Compliance		Verdict: PASS	
Date(s): 19-Jul-20			
Temperature: 23 °C	Relative Humidity: 55 %	Air Pressure: 1008 hPa	Power: 120 VAC, 60 Hz
Remarks:			

Table 7.2.8 Restricted bands according to FCC 15, Section 205

MHz	MHz	MHz	MHz	MHz	GHz
0.09 - 0.11	8.37625 - 8.38675	73 - 74.6	399.9 - 410	2690 - 2900	10.6 - 12.7
0.495 - 0.505	8.41425 - 8.41475	74.8 - 75.2	608 - 614	3260 - 3267	13.25 - 13.4
2.1735 - 2.1905	12.290 - 12.293	108 - 121.94	960 - 1240	3332 - 3339	14.47 - 14.5
4.125 - 4.128	12.51975 - 12.52025	123 - 138	1300 - 1427	3345.8 - 3358	15.35 - 16.2
4.17725 - 4.17775	12.57675 - 12.57725	149.9 - 150.05	1435 - 1626.5	3600 - 4400	17.7 - 21.4
4.20725 - 4.20775	13.36 - 13.41	156.52475 - 156.52525	1645.5 - 1646.5	4500 - 5150	22.01 - 23.12
6.215 - 6.218	16.420 - 16.423	156.7 - 156.9	1660 - 1710	5350 - 5460	23.6 - 24
6.26775 - 6.26825	16.69475 - 16.69525	162.0125 - 167.17	1718.8 - 1722.2	7250 - 7750	31.2 - 31.8
6.31175 - 6.31225	16.80425 - 16.80475	167.72 - 173.2	2200 - 2300	8025 - 8500	36.43 - 36.5
8.291 - 8.294	25.5 - 25.67	240 - 285	2310 - 2390	9000 - 9200	Above 38.6
8.362 - 8.366	37.5 - 38.25	322 - 335.4	2483.5 - 2500	9300 - 9500	

Table 7.2.9 Restricted bands according to RSS-Gen, Table 3

MHz	MHz	MHz	MHz	MHz	GHz
0.09 - 0.11	8.291 - 8.294	16.80425 - 16.80475	399.9 - 410	3260 - 3267	10.6 - 12.7
2.1735 - 2.190	8.362 - 8.366	25.5 - 25.67	608 - 614	3332 - 3339	13.25 - 13.4
3.020 - 3.026	8.37625 - 8.38675	37.5 - 38.25	960 - 1427	3345.8 - 3358	14.47 - 14.5
4.125 - 4.128	8.41425 - 8.41475	73 - 74.6	1435 - 1626.5	3500 - 4400	15.35 - 16.2
4.17725 - 4.17775	12.290 - 12.293	74.8 - 75.2	1645.5 - 1646.5	4500 - 5150	17.7 - 21.4
4.20725 - 4.20775	12.51975 - 12.52025	108 - 138	1660 - 1710	5350 - 5460	22.01 - 23.12
5.677 - 5.683	12.57675 - 12.57725	156.52475 - 156.52525	1718.8 - 1722.2	7250 - 7750	23.6 - 24.0
6.215 - 6.218	13.36 - 13.41	156.7 - 156.9	2200 - 2300	8025 - 8500	31.2 - 31.8
6.26775 - 6.26825	16.42 - 16.423	240 - 285	2310 - 2390	9000 - 9200	36.43 - 36.5
6.31175 - 6.31225	16.69475 - 16.69525	322 - 335.4	2655 - 2900	9300 - 9500	Above 38.6



Test specification: FCC Part 15, Section 231(b) / RSS-210, Section A1. 2, Field strength of emissions			
Test procedure: ANSI C63.10 sections 6.5, 6.6			
Test mode: Compliance	Verdict: PASS		
Date(s): 19-Jul-20			
Temperature: 23 °C	Relative Humidity: 55 %	Air Pressure: 1008 hPa	Power: 120 VAC, 60 Hz
Remarks:			

Plot 7.2.1 Radiated emission measurements at the fundamental frequency

TEST SITE: Semi anechoic chamber
 TEST DISTANCE: 3 m
 ANTENNA POLARIZATION: Vertical
 EUT POSITION: Typical
 INPUT VOLTAGE: Unom

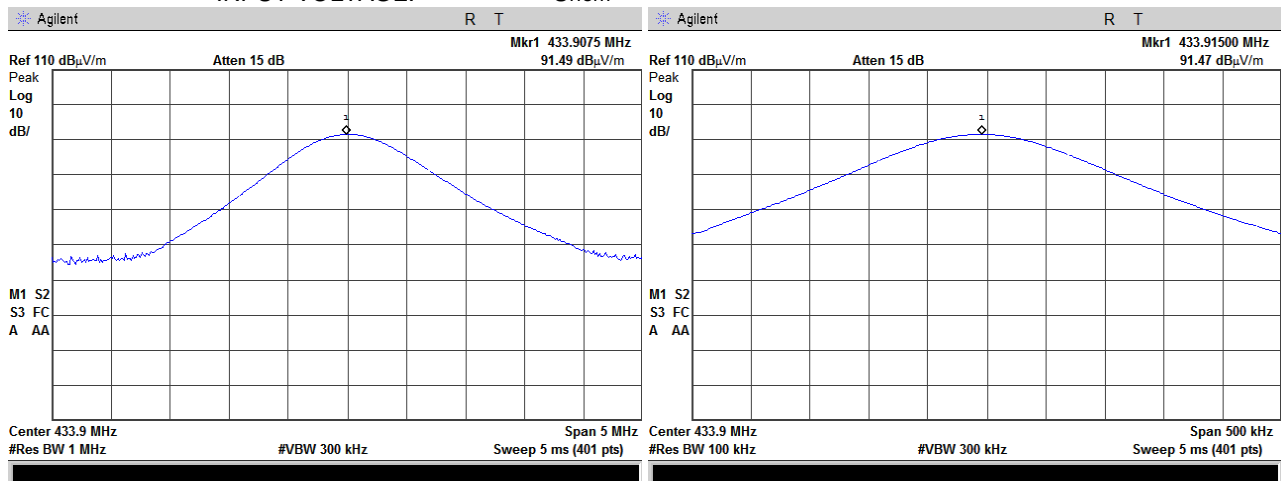

Plot 7.2.2 Radiated emission measurements at the fundamental frequency

TEST SITE: Semi anechoic chamber
 TEST DISTANCE: 3 m
 ANTENNA POLARIZATION: Horizontal
 EUT POSITION: Typical
 INPUT VOLTAGE: Unom

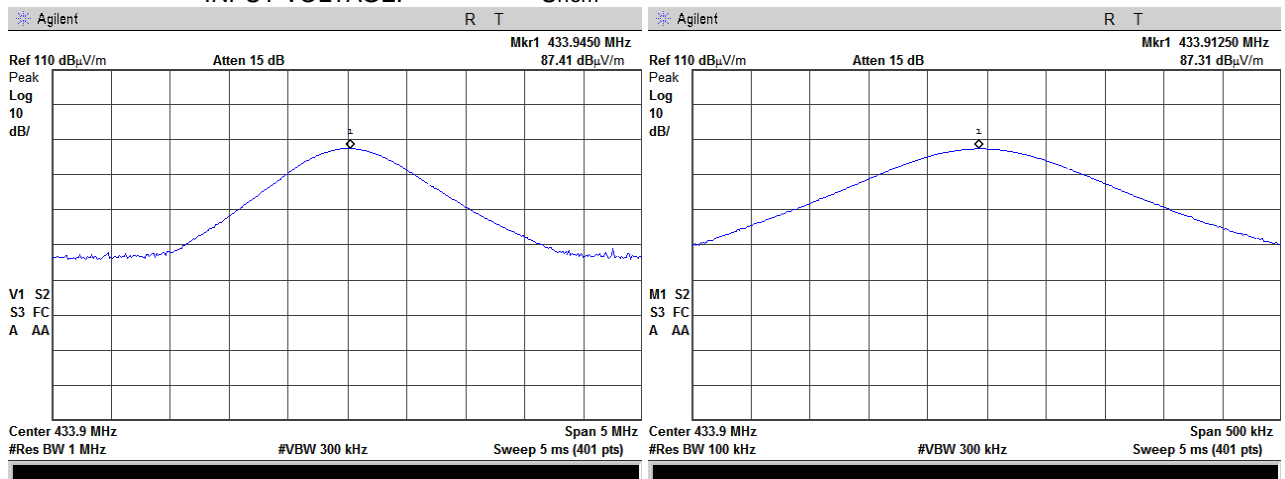



Test specification: FCC Part 15, Section 231(b) / RSS-210, Section A1. 2, Field strength of emissions	
Test procedure: ANSI C63.10 sections 6.5, 6.6	
Test mode: Compliance	Verdict: PASS
Date(s): 19-Jul-20	
Temperature: 23 °C	Relative Humidity: 55 %
Air Pressure: 1008 hPa	Power: 120 VAC, 60 Hz
Remarks:	

Plot 7.2.3 Radiated emission measurements at the fundamental frequency

TEST SITE: Semi anechoic chamber
 TEST DISTANCE: 3 m
 ANTENNA POLARIZATION: Vertical / Horizontal
 EUT POSITION: Typical
 INPUT VOLTAGE: Unom

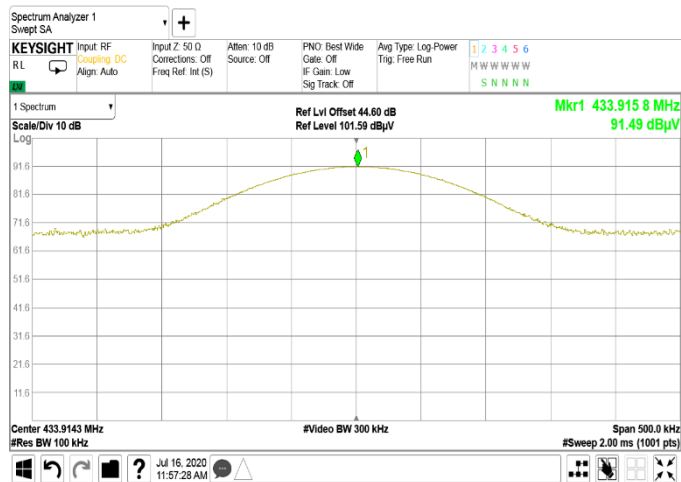

Plot 7.2.4 Radiated emission measurements at the fundamental frequency

TEST SITE: Semi anechoic chamber
 TEST DISTANCE: 3 m
 ANTENNA POLARIZATION: Vertical / Horizontal
 EUT POSITION: Typical
 INPUT VOLTAGE: U= 115% nom

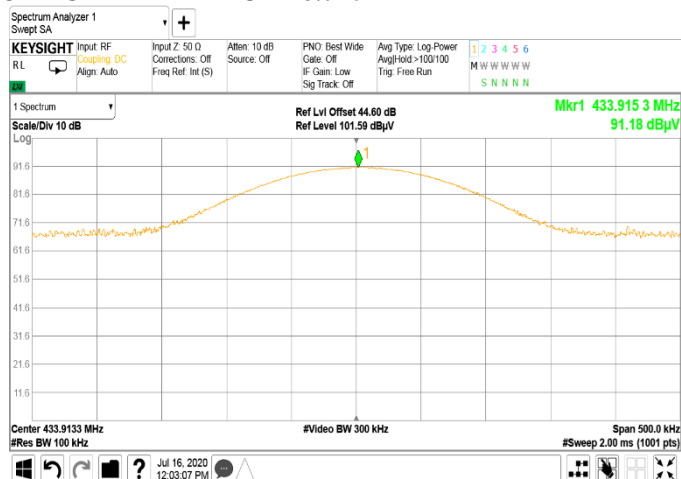



HERMON LABORATORIES

Test specification: FCC Part 15, Section 231(b) / RSS-210, Section A1. 2, Field strength of emissions			
Test procedure: ANSI C63.10 sections 6.5, 6.6			
Test mode: Compliance	Verdict: PASS		
Date(s): 19-Jul-20			
Temperature: 23 °C	Relative Humidity: 55 %	Air Pressure: 1008 hPa	Power: 120 VAC, 60 Hz
Remarks:			

Plot 7.2.5 Radiated emission measurements at the fundamental frequency

TEST SITE: Semi anechoic chamber
TEST DISTANCE: 3 m
ANTENNA POLARIZATION: Vertical / Horizontal
EUT POSITION: Typical
INPUT VOLTAGE: U= 85% nom

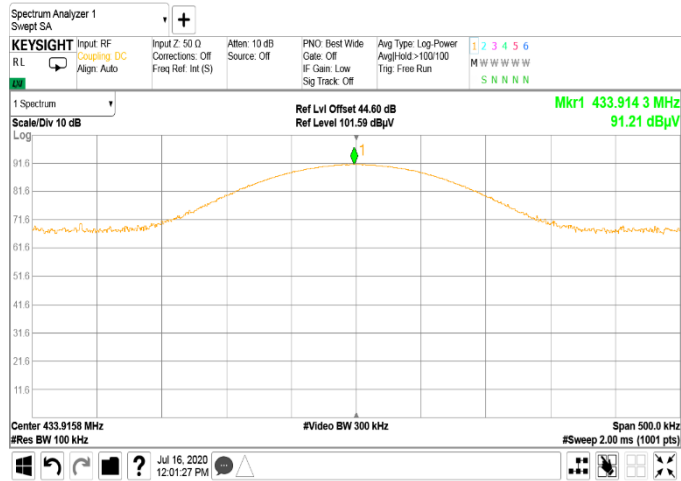



Test specification: FCC Part 15, Section 231(b) / RSS-210, Section A1. 2, Field strength of emissions			
Test procedure: ANSI C63.10 sections 6.5, 6.6			
Test mode: Compliance		Verdict: PASS	
Date(s): 19-Jul-20			
Temperature: 23 °C	Relative Humidity: 55 %	Air Pressure: 1008 hPa	Power: 120 VAC, 60 Hz
Remarks:			

Plot 7.2.6 Radiated emission measurements from 9 kHz to 150 kHz

TEST SITE: Semi anechoic chamber
 TEST DISTANCE: 3 m
 ANTENNA POLARIZATION: Vertical
 EUT POSITION: Typical (Vertical)

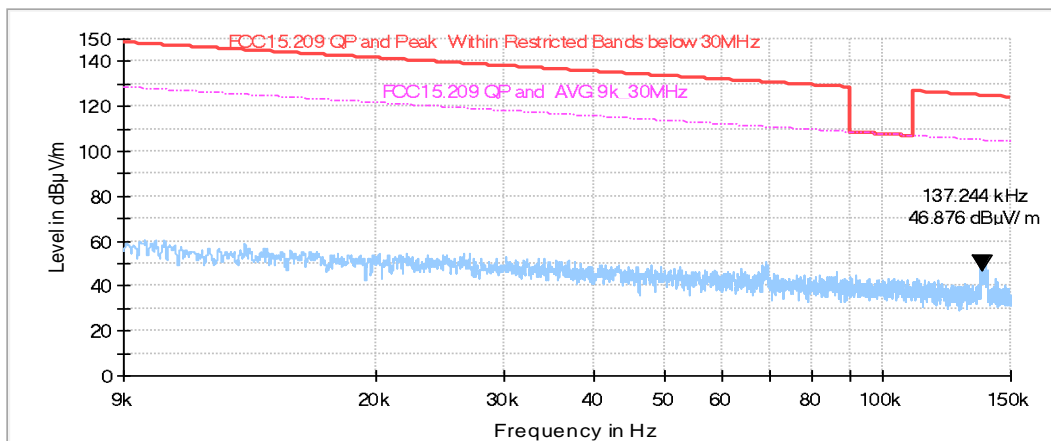

Plot 7.2.7 Radiated emission measurements from 0.15 kHz to 30 MHz

TEST SITE: Semi anechoic chamber
 TEST DISTANCE: 3 m
 ANTENNA POLARIZATION: Vertical
 EUT POSITION: Typical (Vertical)

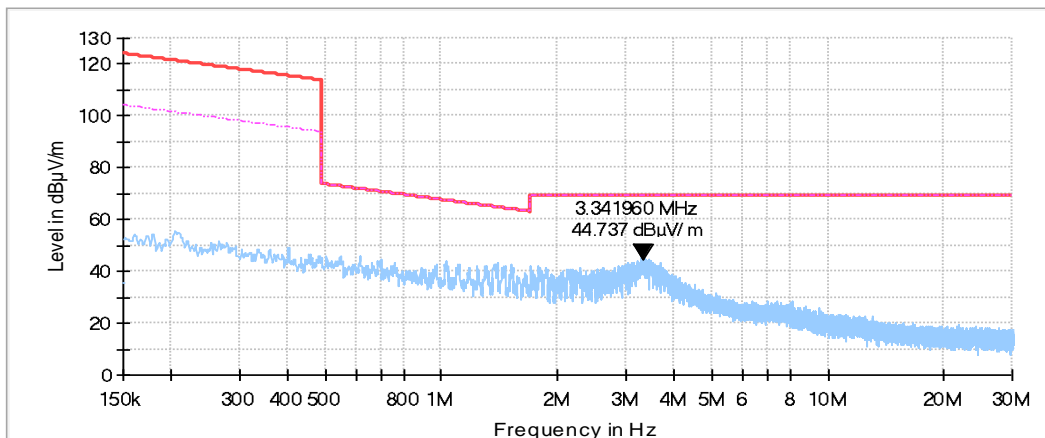



Test specification: FCC Part 15, Section 231(b) / RSS-210, Section A1. 2, Field strength of emissions			
Test procedure: ANSI C63.10 sections 6.5, 6.6			
Test mode: Compliance	Verdict: PASS		
Date(s): 19-Jul-20			
Temperature: 23 °C	Relative Humidity: 55 %	Air Pressure: 1008 hPa	Power: 120 VAC, 60 Hz
Remarks:			

Plot 7.2.8 Radiated emission measurements from 30 to 600 MHz

TEST SITE: Semi anechoic chamber
 TEST DISTANCE: 3 m
 ANTENNA POLARIZATION: Vertical and Horizontal
 EUT POSITION: Typical (Vertical)

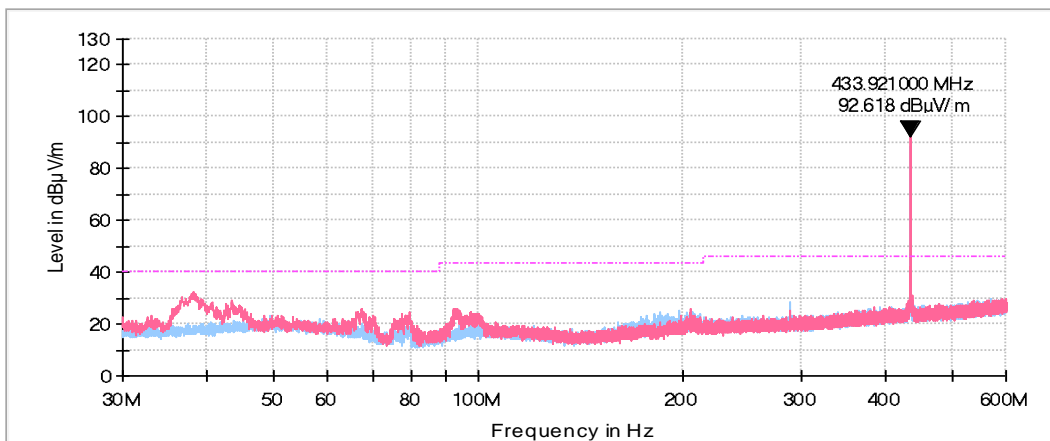

Plot 7.2.9 Radiated emission measurements from 600 to 1000 MHz

TEST SITE: Semi anechoic chamber
 TEST DISTANCE: 3 m
 ANTENNA POLARIZATION: Vertical and Horizontal
 EUT POSITION: Typical (Vertical)

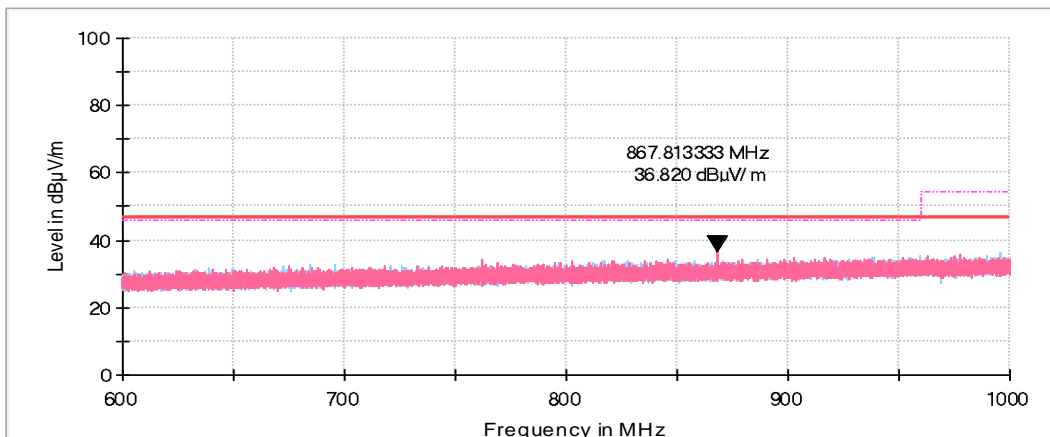



Test specification: FCC Part 15, Section 231(b) / RSS-210, Section A1. 2, Field strength of emissions			
Test procedure: ANSI C63.10 sections 6.5, 6.6			
Test mode: Compliance	Verdict: PASS		
Date(s): 19-Jul-20			
Temperature: 23 °C	Relative Humidity: 55 %	Air Pressure: 1008 hPa	Power: 120 VAC, 60 Hz
Remarks:			

Plot 7.2.10 Radiated emission measurements from 1000 to 4500 MHz

TEST SITE: Semi anechoic chamber
TEST DISTANCE: 3 m
ANTENNA POLARIZATION: Vertical and Horizontal
EUT POSITION: Typical (Vertical)

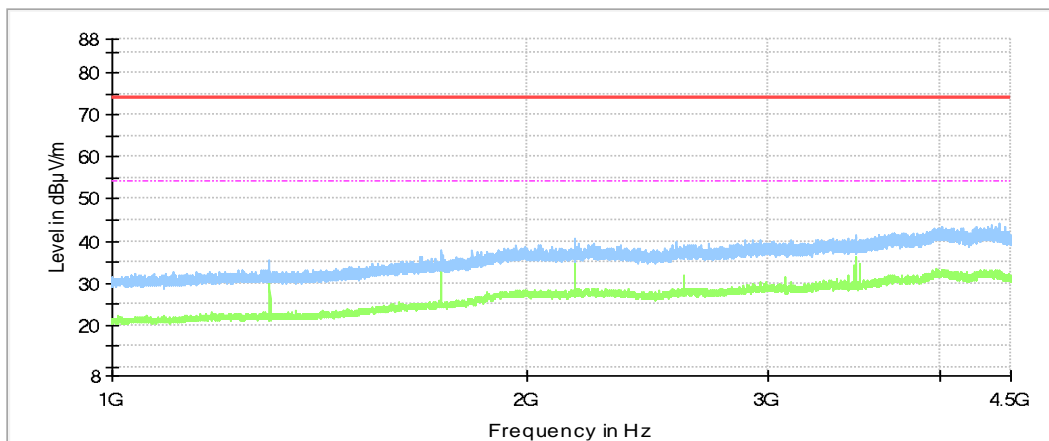



HERMON LABORATORIES

Test specification: FCC Part 15, Section 231(b) / RSS-210, Section A1. 2, Field strength of emissions	
Test procedure: ANSI C63.10 sections 6.5, 6.6	
Test mode: Compliance	Verdict: PASS
Date(s): 19-Jul-20	
Temperature: 23 °C	Relative Humidity: 55 %
Air Pressure: 1008 hPa	Power: 120 VAC, 60 Hz
Remarks:	

Plot 7.2.11 Transmission pulse period

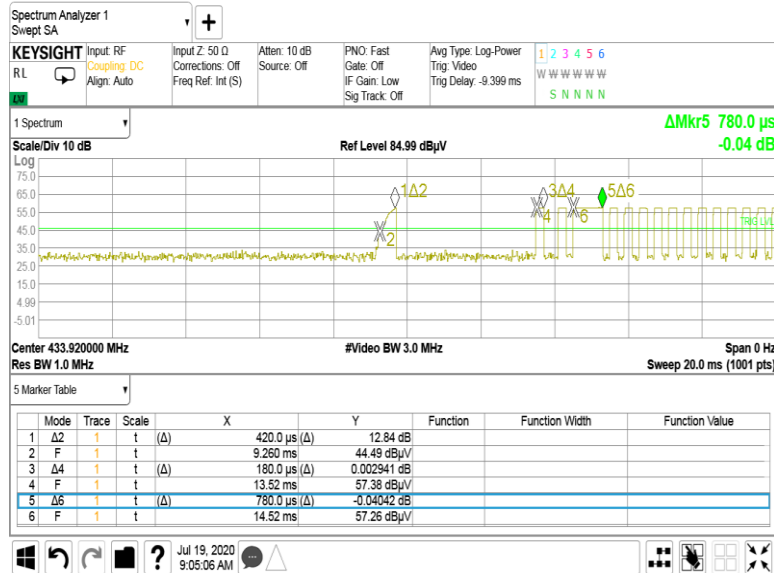

Plot 7.2.12 Transmission burst duration

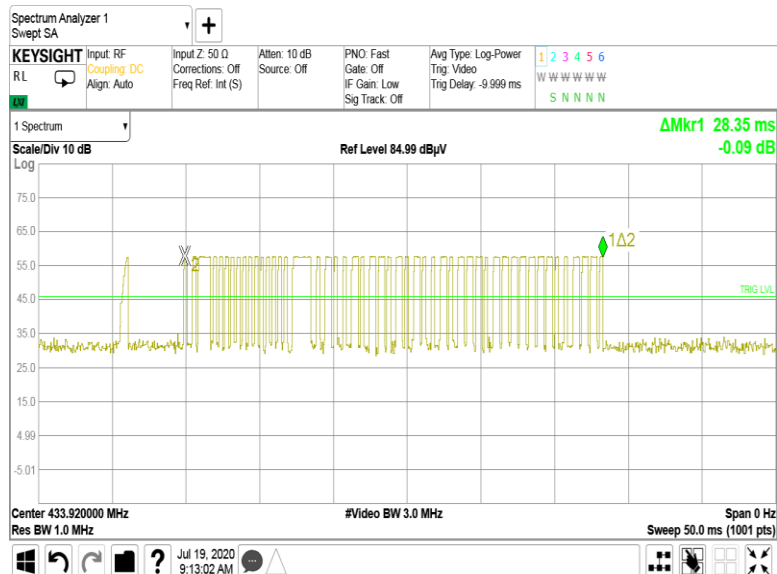



Test specification: FCC Part 15, Section 231(c) / RSS-210, Section A1.3, Occupied bandwidth			
Test procedure: ANSI C63.10 section 6.9.2			
Test mode: Compliance		Verdict: PASS	
Date(s): 16-Jul-20			
Temperature: 24 °C	Relative Humidity: 51 %	Air Pressure: 1011 hPa	Power: 120 VAC, 60 Hz
Remarks:			

7.3 Occupied bandwidth test

7.3.1 General

This test was performed to measure transmitter occupied bandwidth. Specification test limits are given in Table 7.3.1.

Table 7.3.1 Occupied bandwidth limits

Assigned frequency, MHz	Modulation envelope reference points*, dBc	Maximum allowed bandwidth, % of the carrier frequency
70 - 900	20.0	0.25
Above 900		0.50

*- Modulation envelope reference points provided in terms of attenuation below modulated carrier.

7.3.2 Test procedure

7.3.2.1 The EUT was set up as shown in Figure 7.3.1, energized and its proper operation was checked.

7.3.2.2 The EUT was set to transmit modulated carrier.

7.3.2.3 The transmitter occupied bandwidth was measured with spectrum analyzer as frequency delta between reference points on modulation envelope and provided in Table 7.3.2 and associated plot.

Figure 7.3.1 Occupied bandwidth test setup





Test specification: FCC Part 15, Section 231(c) / RSS-210, Section A1.3, Occupied bandwidth			
Test procedure: ANSI C63.10 section 6.9.2			
Test mode: Compliance		Verdict: PASS	
Date(s): 16-Jul-20			
Temperature: 24 °C	Relative Humidity: 51 %	Air Pressure: 1011 hPa	Power: 120 VAC, 60 Hz
Remarks:			

Table 7.3.2 Occupied bandwidth test results

DETECTOR USED: Peak hold
 RESOLUTION BANDWIDTH: 1 kHz
 VIDEO BANDWIDTH: 3 kHz
 MODULATION ENVELOPE REFERENCE POINTS: 99%
 MODULATION: OOK
 BIT RATE: 1.67 kbps

MODULATION ENVELOPE REFERENCE POINTS 20 dBc

Carrier frequency, MHz	Occupied bandwidth, kHz	Limit		Margin, kHz	Verdict
		% of the carrier frequency	kHz		
433.92	53.72	0.25	1084.8	1031.08	Pass

MODULATION ENVELOPE REFERENCE POINTS 99%

Carrier frequency, MHz	Occupied bandwidth, kHz	Limit		Margin, kHz	Verdict
		% of the carrier frequency	kHz		
433.92	25.63	0.25	1084.8	1058.8	Pass

Reference numbers of test equipment used

HL 0337	HL 3901	HL 5376						
---------	---------	---------	--	--	--	--	--	--

Full description is given in Appendix A.



HERMON LABORATORIES

Test specification: FCC Part 15, Section 231(c) / RSS-210, Section A1.3, Occupied bandwidth			
Test procedure: ANSI C63.10 section 6.9.2			
Test mode: Compliance		Verdict: PASS	
Date(s): 16-Jul-20			
Temperature: 24 °C	Relative Humidity: 51 %	Air Pressure: 1011 hPa	Power: 120 VAC, 60 Hz
Remarks:			

Plot 7.3.1 The 20 dBc occupied bandwidth test result

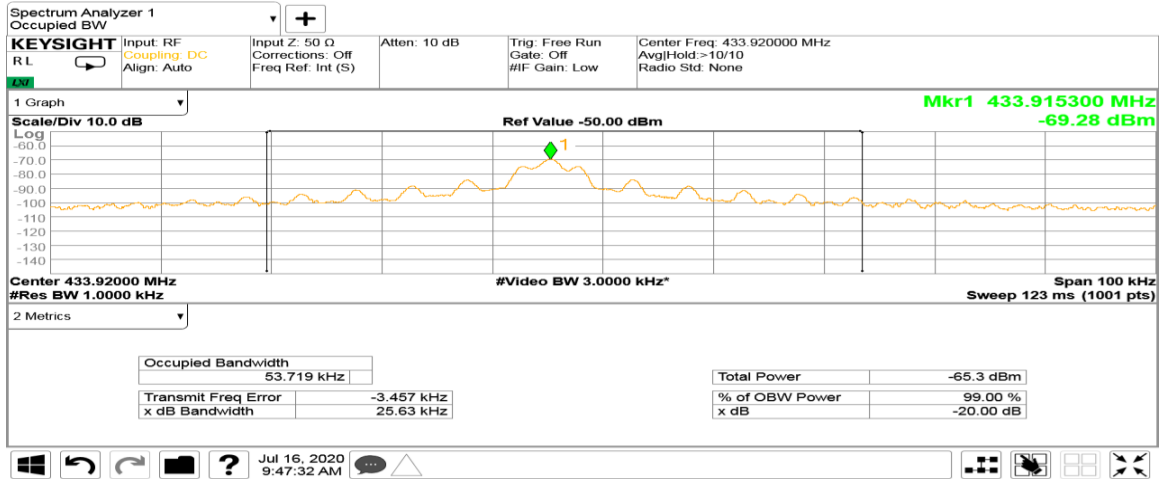

Plot 7.3.2 The 99% occupied bandwidth test result

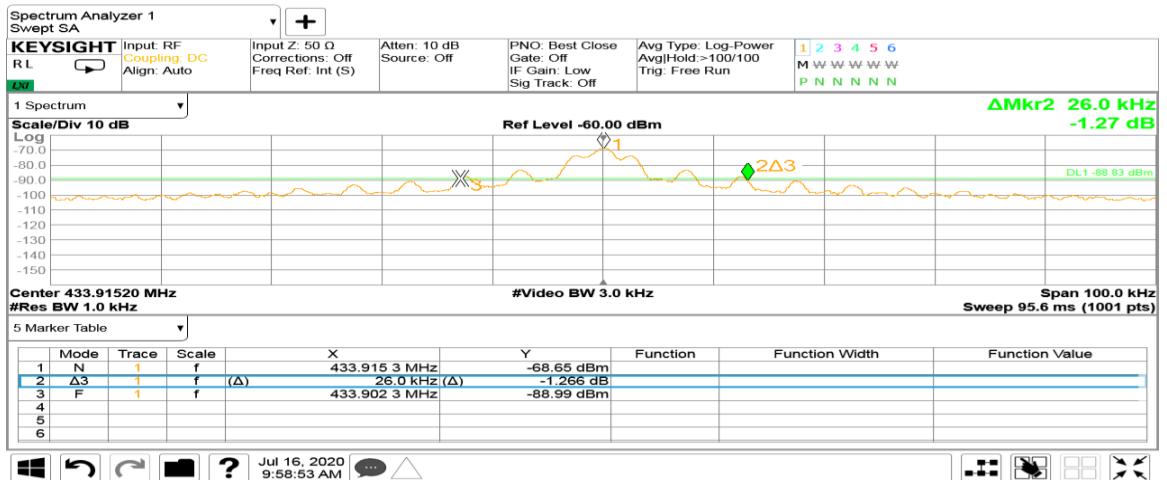



Test specification: FCC Part 15, Section 207 / RSS-Gen, Section 8.8, Conducted emission			
Test procedure: ANSI C63.4, Section 7.3 and 12.2.4			
Test mode: Compliance		Verdict: PASS	
Date(s): 16-Jul-20			
Temperature: 23 °C	Relative Humidity: 42 %	Air Pressure: 1012 hPa	Power: 120 VAC, 60 Hz
Remarks:			

7.4 Conducted emissions

7.4.1 General

This test was performed to measure common mode conducted emissions at the power port. Specification test limits are given in Table 7.4.1.

Table 7.4.1 Limits for conducted emissions

Frequency, MHz	Class B limit, dB(μV)	
	QP	AVRG
0.15 - 0.5	66 - 56*	56 - 46*
0.5 - 5.0	56	46
5.0 - 30	60	50

* - The limit decreases linearly with the logarithm of frequency.

7.4.2 Test procedure

7.4.2.1 The EUT was set up as shown in Figure 7.4.1, energized and the performance check was conducted.

7.4.2.2 The measurements were performed at power terminals with the LISN, connected to a spectrum analyzer while unused coaxial connector of the LISN was terminated with 50 Ohm.

7.4.2.3 The position of the device cables was varied to determine maximum emission level.

Figure 7.4.1 Setup for conducted emission measurements, table-top equipment

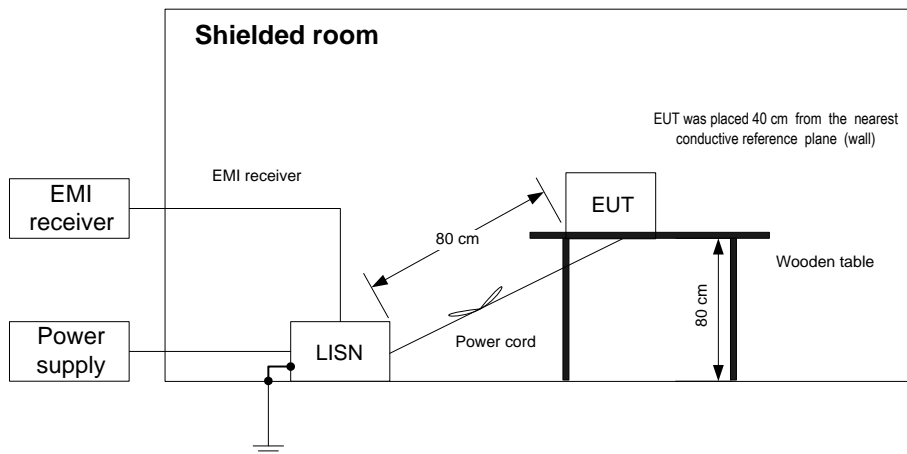

Reference numbers of test equipment used

HL 5707	HL 0787	HL 5476	HL 2888	HL 1205			
---------	---------	---------	---------	---------	--	--	--

Full description is given in Appendix A.



HERMON LABORATORIES

Test specification: FCC Part 15, Section 207 / RSS-Gen, Section 8.8, Conducted emission			
Test procedure: ANSI C63.4, Section 7.3 and 12.2.4			
Test mode: Compliance		Verdict: PASS	
Date(s): 16-Jul-20			
Temperature: 23 °C	Relative Humidity: 42 %	Air Pressure: 1012 hPa	Power: 120 VAC, 60 Hz
Remarks:			

Plot 7.4.1 Conducted emission measurements test results

LINE: L1
EUT OPERATING MODE: Transmit
LIMIT: QUASI-PEAK, AVERAGE
DETECTOR: PEAK

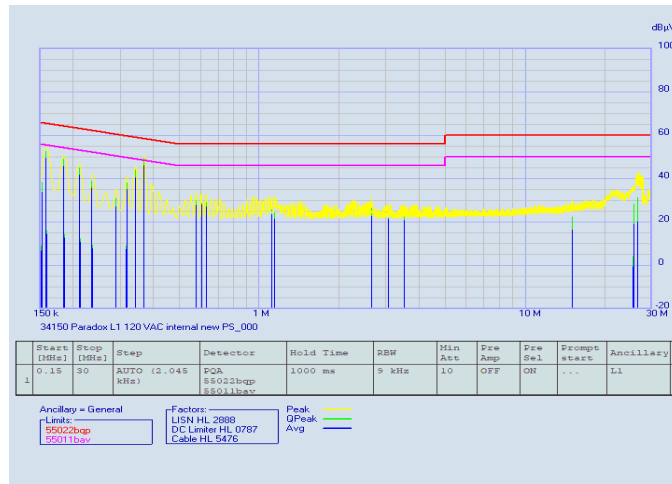

34150 Paradox L1 120 VAC internal new PS_000 16-07-2020 16:14:51
Rel. SW 2.37 (June 2019)
Rel. FW 1.93 01/10/19
Margin: 20 dB

	Frequency [MHz]	QPeak [dBµV]	Limit 55022bqp [dBµV]	Delta [dB]	Avg [dBµV]	Limit 55011bav [dBµV]	Delta [dB]	Factor LISN HL 2.. [dB]	Factor DC Limite.. [dB]	Factor Cable HL .. [dB]
1	0.15818	52.63	65.56	-12.93	49.44	55.56	-6.12	0.08	10.00	0.12
2	0.184765	49.05	64.27	-15.22	45.77	54.27	-8.50	0.08	10.00	0.12
3	0.21135	44.84	63.15	-18.31	41.50	53.15	-11.65	0.08	10.00	0.12
4	0.23589	39.08	62.24	---	35.55	52.24	-16.69	0.08	10.00	0.12
5	0.31769	38.12	59.77	---	34.96	49.77	-14.81	0.08	10.00	0.13
6	0.34223	43.87	59.15	-15.28	40.48	49.15	-8.67	0.08	10.00	0.13
7	0.368815	49.31	58.53	-9.22	46.08	48.53	-2.45	0.08	10.00	0.14
8	0.57945	30.16	56.00	---	27.66	46.00	-18.34	0.10	10.00	0.16
9	0.606035	30.32	56.00	---	27.87	46.00	-18.13	0.10	10.00	0.16
10	0.63262	28.92	56.00	---	26.85	46.00	-19.15	0.10	10.00	0.16



HERMON LABORATORIES

Test specification: FCC Part 15, Section 207 / RSS-Gen, Section 8.8, Conducted emission			
Test procedure: ANSI C63.4, Section 7.3 and 12.2.4			
Test mode: Compliance		Verdict: PASS	
Date(s): 16-Jul-20			
Temperature: 23 °C	Relative Humidity: 42 %	Air Pressure: 1012 hPa	Power: 120 VAC, 60 Hz
Remarks:			

Plot 7.4.2 Conducted emission measurements test results

LINE: L2
EUT OPERATING MODE: Transmit
LIMIT: QUASI-PEAK, AVERAGE
DETECTOR: PEAK

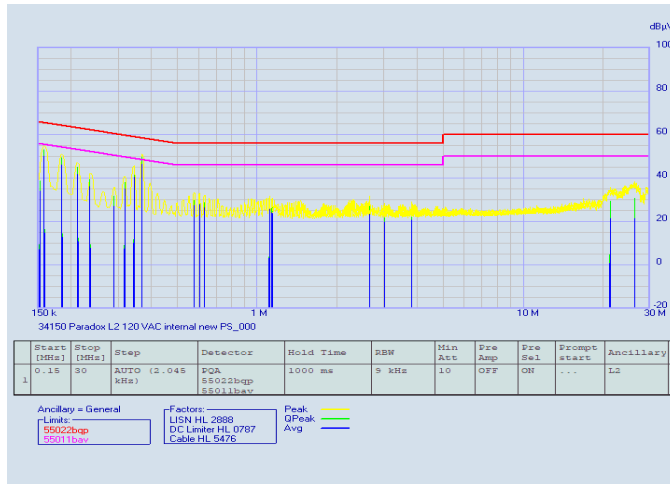

34150 Paradox L2 120 VAC internal new PS_000 16-07-2020 16:19:52
Rel. SW 2.37 (June 2019)
Rel. FW 1.93 01/10/19
Margin: 20 dB

Frequency [MHz]	QPeak [dBµV]	Limit 55022bqp [dBµV]	Delta [dB]	Avg [dBµV]	Limit 55011bav [dBµV]	Delta [dB]	Factor LISN HL 2688 [dB]	Factor DC Liner HL 0787 [dB]	Factor Cable HL 5476 [dB]
1	0.15818	52.93	-12.63	49.88	55.56	-5.68	0.08	10.00	0.12
2	0.184765	49.22	-15.05	46.11	54.27	-8.16	0.08	10.00	0.12
3	0.21135	45.12	-18.03	41.83	53.15	-11.32	0.08	10.00	0.12
4	0.23589	39.41	---	35.92	52.24	-16.32	0.08	10.00	0.12
5	0.31769	38.12	---	34.93	49.77	-14.84	0.08	10.00	0.13
6	0.344275	43.72	-15.38	40.40	49.10	-8.70	0.08	10.00	0.13
7	0.368815	49.57	-8.96	46.31	48.53	-2.22	0.08	10.00	0.14
8	0.57945	29.83	---	27.32	46.00	-18.68	0.10	10.00	0.16
9	0.606035	29.93	---	27.51	46.00	-18.49	0.10	10.00	0.16
10	0.63262	28.62	---	26.47	46.00	-19.53	0.10	10.00	0.16



Test specification: FCC Part 15, Section 203 / RSS-Gen, Section 6.8, Antenna requirements			
Test procedure: Visual inspection / supplier declaration			
Test mode: Compliance		Verdict: PASS	
Date(s): 16-Jul-20			
Temperature: 24 °C	Relative Humidity: 51 %	Air Pressure: 1011 hPa	Power: 120 VAC, 60 Hz
Remarks:			

7.5 Antenna requirements

The EUT was verified for compliance with antenna requirements. A transmitter shall be designed to ensure that no antenna other than that furnished by the responsible party will be used with the device. It may be either permanently attached or employs a unique antenna connector for every antenna proposed for use with the EUT. This requirement does not apply to professionally installed transmitters.

The rationale for compliance with the above requirements was either visual inspection results or supplier declaration. The summary of results is provided in Table 7.5.1.

Table 7.5.1 Antenna requirements

Requirement	Rationale	Verdict
The transmitter antenna is permanently attached	NA	Comply
The transmitter employs a unique antenna connector	NA	
The transmitter requires professional installation	Supplier declaration	



Test specification: FCC 47 CFR, Section 15.107 / ICES-003, Section 6.1, Class B, AC power lines conducted emissions			
Test procedure: ANSI C63.4, Section 7.3			
Test mode: Compliance		Verdict: PASS	
Date(s): 16-Jul-20			
Temperature: 24 °C	Relative Humidity: 51 %	Air Pressure: 1011 hPa	Power: 120 VAC, 60 Hz
Remarks:			

8 Unintentional emissions according to 47CFR part 15 subpart B and ICES-003 requirements

8.1 Conducted emissions

8.1.1 General

This test was performed to measure common mode conducted emissions at the power port. Specification test limits are given in Table 8.1.1.

Table 8.1.1 Limits for conducted emissions

Frequency, MHz	Class B limit, dB(μV)	
	QP	AVRG
0.15 - 0.5	66 - 56*	56 - 46*
0.5 - 5.0	56	46
5.0 - 30	60	50

* - The limit decreases linearly with the logarithm of frequency.

8.1.2 Test procedure

8.1.2.1 The EUT was set up as shown in Figure 8.1.1 energized and the performance check was conducted.

8.1.2.2 The measurements were performed at power terminals with the LISN, connected to a spectrum analyzer while unused coaxial connector of the LISN was terminated with 50 Ohm.

8.1.2.3 The position of the device cables was varied to determine maximum emission level.

Figure 8.1.1 Setup for conducted emission measurements, table-top equipment

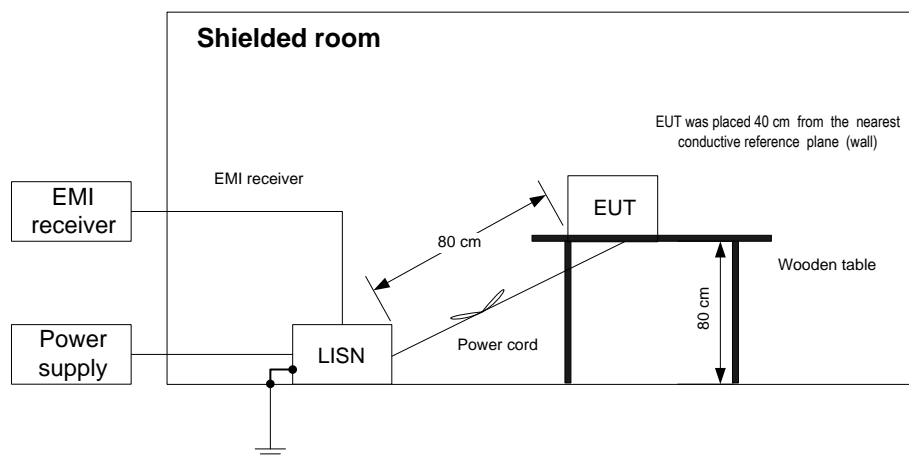

Reference numbers of test equipment used

HL 5707	HL 0787	HL 5476	HL 2888	HL 1205		
---------	---------	---------	---------	---------	--	--

Full description is given in Appendix A.



HERMON LABORATORIES

Test specification: FCC 47 CFR, Section 15.107 / ICES-003, Section 6.1, Class B, AC power lines conducted emissions			
Test procedure: ANSI C63.4, Section 7.3			
Test mode: Compliance		Verdict: PASS	
Date(s): 16-Jul-20			
Temperature: 24 °C	Relative Humidity: 51 %	Air Pressure: 1011 hPa	Power: 120 VAC, 60 Hz
Remarks:			

Plot 8.1.1 Conducted emission measurements, AC mains input of control panel

LINE: L1
EUT OPERATING MODE: Transmit
LIMIT: QUASI-PEAK, AVERAGE
DETECTOR: PEAK

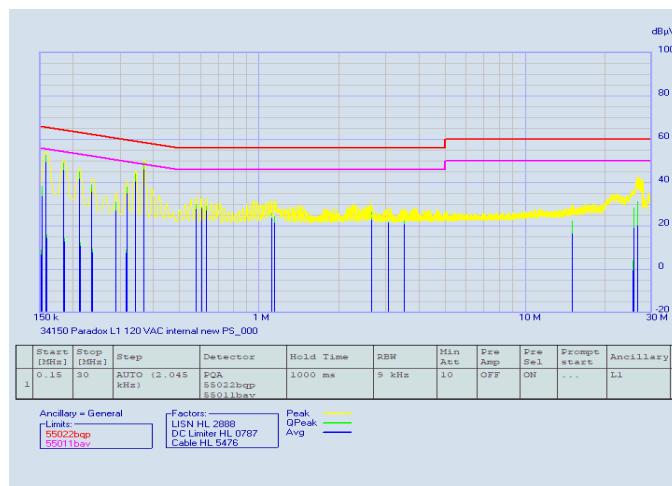

34150 Paradox L1 120 VAC internal new PS_000 16-07-2020 16:14:51
Rel. SW 2.37 (June 2019)
Rel. FW 1.93 01/10/19
Margin: 20 dB

	Frequency [MHz]	QPeak [dBµV]	Limit 55022bqp [dBµV]	Delta [dB]	Avg [dBµV]	Limit 55011bav [dBµV]	Delta [dB]	Factor LISN HL 2.. [dB]	Factor DC Limite.. [dB]	Factor Cable HL .. [dB]
1	0.15818	52.63	65.56	-12.93	49.44	55.56	-6.12	0.08	10.00	0.12
2	0.184765	49.05	64.27	-15.22	45.77	54.27	-8.50	0.08	10.00	0.12
3	0.21135	44.84	63.15	-18.31	41.50	53.15	-11.65	0.08	10.00	0.12
4	0.23589	39.08	62.24	---	35.55	52.24	-16.69	0.08	10.00	0.12
5	0.31769	38.12	59.77	---	34.96	49.77	-14.81	0.08	10.00	0.13
6	0.34223	43.87	59.15	-15.28	40.48	49.15	-8.67	0.08	10.00	0.13
7	0.368815	49.31	58.53	-9.22	46.08	48.53	-2.45	0.08	10.00	0.14
8	0.57945	30.16	56.00	---	27.66	46.00	-18.34	0.10	10.00	0.16
9	0.606035	30.32	56.00	---	27.87	46.00	-18.13	0.10	10.00	0.16
10	0.63262	28.92	56.00	---	26.85	46.00	-19.15	0.10	10.00	0.16



HERMON LABORATORIES

Test specification: FCC 47 CFR, Section 15.107 / ICES-003, Section 6.1, Class B, AC power lines conducted emissions			
Test procedure: ANSI C63.4, Section 7.3			
Test mode: Compliance		Verdict: PASS	
Date(s): 16-Jul-20			
Temperature: 24 °C	Relative Humidity: 51 %	Air Pressure: 1011 hPa	Power: 120 VAC, 60 Hz
Remarks:			

Plot 8.1.2 Conducted emission measurements, AC mains input of control panel

LINE: L2
EUT OPERATING MODE: Transmit
LIMIT: QUASI-PEAK, AVERAGE
DETECTOR: PEAK

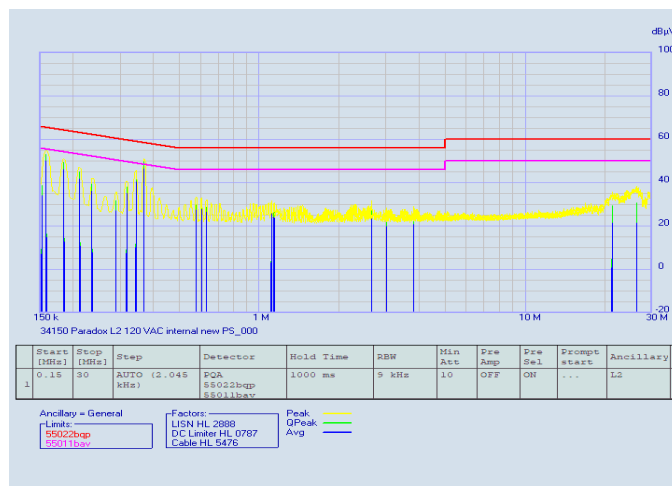

34150 Paradox L2 120 VAC internal new PS_000 16-07-2020 16:19:52
Rel. SW 2.37 (June 2019)
Rel. FW 1.93 01/10/19
Margin: 20 dB

Frequency [MHz]	QPeak [dBµV]	Limit 55022bqp [dBµV]	Delta [dB]	Avg [dBµV]	Limit 55011bav [dBµV]	Delta [dB]	Factor LISN HL 2888 [dB]	Factor DC Limite.. [dB]	Factor Cable HL .. [dB]	
1	0.15818	52.93	65.56	-12.63	49.88	55.56	-5.68	0.08	10.00	0.12
2	0.184765	49.22	64.27	-15.05	46.11	54.27	-8.16	0.08	10.00	0.12
3	0.21135	45.12	63.15	-18.03	41.83	53.15	-11.32	0.08	10.00	0.12
4	0.23589	39.41	62.24	---	35.92	52.24	-16.32	0.08	10.00	0.12
5	0.31769	38.12	59.77	---	34.93	49.77	-14.84	0.08	10.00	0.13
6	0.344275	43.72	59.10	-15.38	40.40	49.10	-8.70	0.08	10.00	0.13
7	0.368815	49.57	58.53	-8.96	46.31	48.53	-2.22	0.08	10.00	0.14
8	0.57945	29.83	56.00	---	27.32	46.00	-18.68	0.10	10.00	0.16
9	0.606035	29.93	56.00	---	27.51	46.00	-18.49	0.10	10.00	0.16
10	0.63262	28.62	56.00	---	26.47	46.00	-19.53	0.10	10.00	0.16



Test specification: FCC 47 CFR, Section 15.109 / ICES-003, Section 6.2, Class B, Radiated emissions			
Test procedure: ANSI C63.4, Section 8.3			
Test mode: Compliance		Verdict: PASS	
Date(s): 16-Jul-20			
Temperature: 24 °C	Relative Humidity: 51 %	Air Pressure: 1011 hPa	Power: 120 VAC, 60 Hz
Remarks:			

8.2 Radiated emission measurements

8.2.1 General

This test was performed to measure radiated emissions from the EUT enclosure. Specification test limits are given in Table 8.2.1.

Table 8.2.1 Radiated emission test limits

Frequency, MHz	Class B limit, dB(μ V/m)		Class A limit, dB(μ V/m)	
	10 m distance	3 m distance	10 m distance	3 m distance
30 - 88	29.5*	40.0	39.0	49.5*
88 - 216	33.0*	43.5	43.5	54.0*
216 - 960	35.5*	46.0	46.4	56.9*
Above 960	43.5*	54.0	49.5	60.0*

* The limit for test distance other than specified was calculated using the inverse linear distance extrapolation factor as follows: $Lim_{S_2} = Lim_{S_1} + 20 \log(S_1/S_2)$, where S_1 and S_2 – standard defined and test distance respectively in meters.

8.2.2 Test procedure

8.2.2.1 30 – 1000 MHz range. The EUT was set up as shown in Figure 8.2.1 and the associated photographs, energized and the EUT performance was checked.

8.2.2.2 The measurements were performed in the semi anechoic chamber at 3 m test distance. The specified frequency range was investigated with the antenna connected to the EMI receiver. To find the highest emission the turntable was rotated 360° and the measuring antenna height was swept from 1 to 4 m in both, vertical and horizontal polarizations. The EUT cables position was varied to maximize emission.

8.2.2.3 1000 – 40000 MHz range. The EUT was set up as shown in Figure 8.2.2 and the associated photographs, energized and the EUT performance was checked.

8.2.2.4 The measurements were performed in the semi anechoic chamber at 3 m test distance. The specified frequency range was investigated with the antenna connected to the EMI receiver. To find the highest emission the turntable was rotated 360° and the measuring antenna height was swept from 1 to 4 m in both, vertical and horizontal polarizations. In order to stay within the 3 dB beamwidth while keeping the antenna height scanned from 1 to 4 m, a few sweeps with different antenna angles over the entire height were performed.

8.2.2.5 The worst test results with respect to the limits were recorded in Table 8.2.2 and shown in the associated plots.



Test specification: FCC 47 CFR, Section 15.109 / ICES-003, Section 6.2, Class B, Radiated emissions			
Test procedure: ANSI C63.4, Section 8.3			
Test mode: Compliance		Verdict:	PASS
Date(s): 16-Jul-20			
Temperature: 24 °C	Relative Humidity: 51 %	Air Pressure: 1011 hPa	Power: 120 VAC, 60 Hz
Remarks:			

Figure 8.2.1 Setup for radiated emission measurements in 30 – 1000 MHz range, table-top EUT

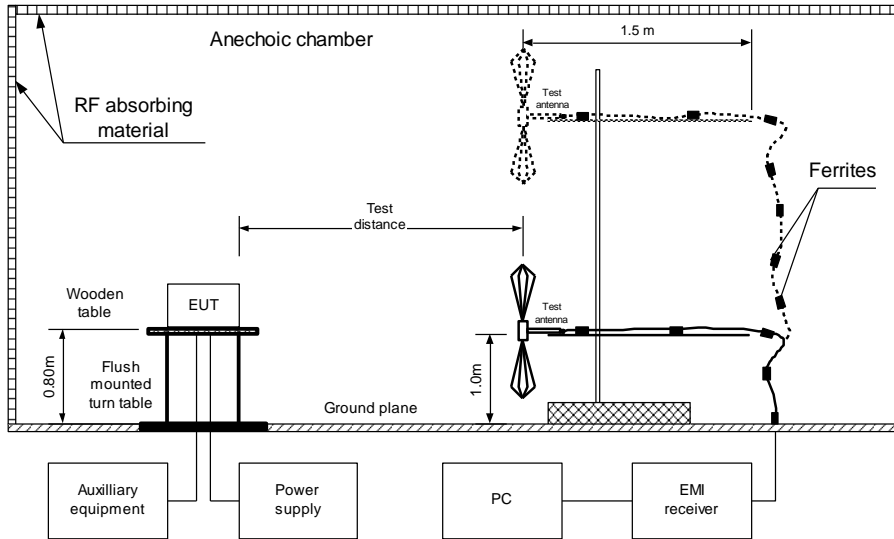
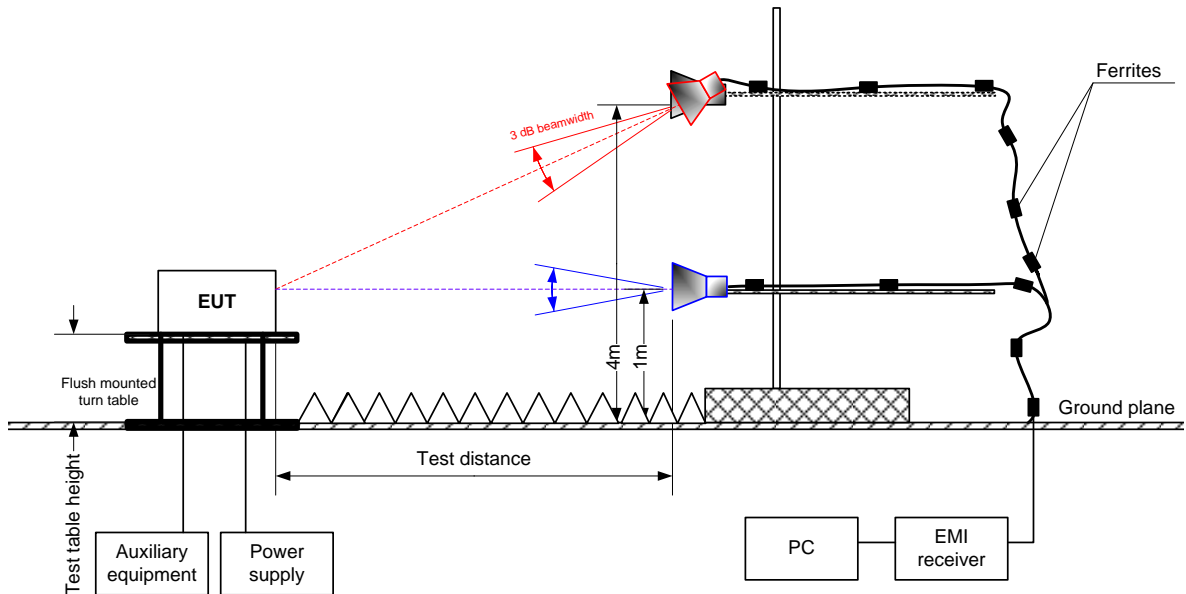

Figure 8.2.2 Setup for radiated emission measurements in 1000 – 6000 MHz range, table-top EUT





Test specification: FCC 47 CFR, Section 15.109 / ICES-003, Section 6.2, Class B, Radiated emissions			
Test procedure: ANSI C63.4, Section 8.3			
Test mode: Compliance		Verdict: PASS	
Date(s): 16-Jul-20			
Temperature: 24 °C	Relative Humidity: 51 %	Air Pressure: 1011 hPa	Power: 120 VAC, 60 Hz
Remarks:			

Table 8.2.2 Radiated emission test results

EUT SET UP: TABLE-TOP
LIMIT: Class B
EUT OPERATING MODE: Stand-by and Receive
TEST SITE: SEMI ANECHOIC CHAMBER
TEST DISTANCE: 3 m
FREQUENCY RANGE: 30 MHz – 1000 MHz
RESOLUTION BANDWIDTH: 120 kHz

Frequency, MHz	Peak emission, dB(µV/m)	Quasi-peak			Antenna polarization	Antenna height, m	Turn-table position**, degrees	Verdict
		Measured emission, dB(µV/m)	Limit, dB(µV/m)	Margin, dB*				
36.966	31.23	25.22	40.0	-14.78	Vertical	1.04	58	Pass
38.588	37.76	31.77	40.0	-8.23	Vertical	1.02	149	
43.129	32.79	26.43	40.0	-13.57	Vertical	1.02	14	
66.180	26.39	21.90	40.0	-18.10	Vertical	1.04	58	
76.277	26.77	20.44	40.0	-19.56	Vertical	1.04	219	
92.231	27.75	22.62	43.5	-20.88	Vertical	1.02	104	
288.035	31.25	28.22	46.0	-17.78	Horizontal	1.02	152	

TEST SITE: SEMI ANECHOIC CHAMBER
TEST DISTANCE: 3 m
DETECTORS USED: PEAK / AVERAGE
FREQUENCY RANGE: 1000 MHz – 5000 MHz
RESOLUTION BANDWIDTH: 1000 kHz

Frequency, MHz	Peak			Average			Antenna polarization	Antenna height, m	Turn-table position**, degrees	Verdict
	Measured emission, dB(µV/m)	Limit, dB(µV/m)	Margin, dB*	Measured emission, dB(µV/m)	Limit, dB(µV/m)	Margin, dB*				
No emissions were found										Pass

*- Margin = Measured emission - specification limit.
**- EUT front panel refer to 0 degrees position of turntable.

Reference numbers of test equipment used

HL 3903	HL 4360	HL 4933	HL 5288	HL 5405			
---------	---------	---------	---------	---------	--	--	--

Full description is given in Appendix A.



Test specification: FCC 47 CFR, Section 15.109 / ICES-003, Section 6.2, Class B, Radiated emissions			
Test procedure: ANSI C63.4, Section 8.3			
Test mode: Compliance		Verdict: PASS	
Date(s): 16-Jul-20			
Temperature: 24 °C	Relative Humidity: 51 %	Air Pressure: 1011 hPa	Power: 120 VAC, 60 Hz
Remarks:			

Plot 8.2.1 Radiated emission measurements in 30 - 1000 MHz range, vertical and horizontal antenna polarization

TEST SITE: Semi anechoic chamber
LIMIT: Class B
TEST DISTANCE: 3 m
EUT OPERATING MODE: Receive / Stand-by

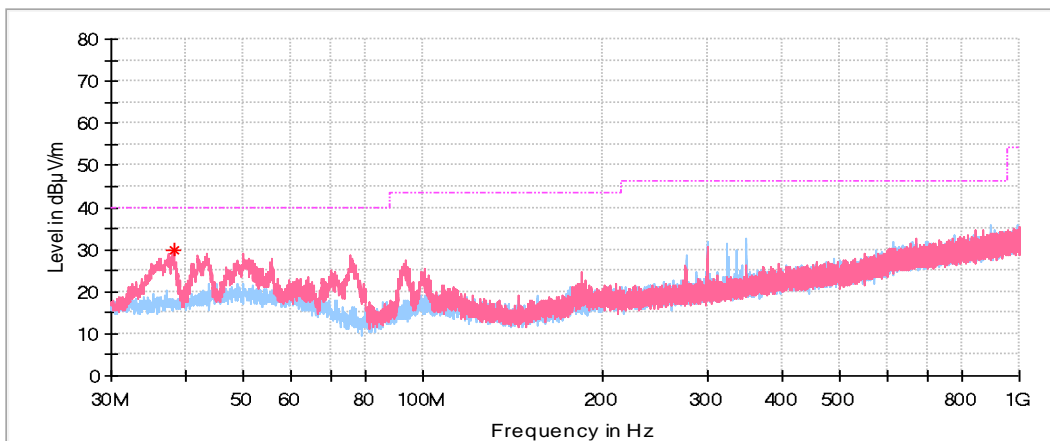

Plot 8.2.2 Radiated emission measurements above 1000 MHz, vertical and horizontal antenna polarization

TEST SITE: Semi anechoic chamber
LIMIT: Class B
TEST DISTANCE: 3 m
EUT OPERATING MODE: Receive / Stand-by

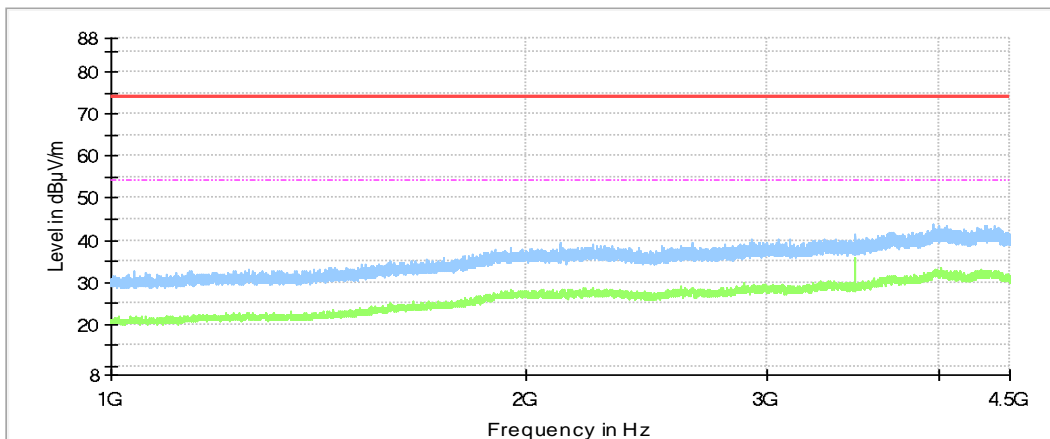

9 APPENDIX A Test equipment and ancillaries used for tests

HL No	Description	Manufacturer	Model	Ser. No.	Last Cal./ Check	Due Cal./ Check
0337	Probe Set, Hand held, 5 probes	Electro-Metrics	EHFP-30	238	25-Jun-20	25-Jun-21
0446	Antenna, Loop, Active, 10 (9) kHz - 30 MHz	EMCO	6502	2857	24-Feb-20	24-Feb-21
0787	Transient Limiter 9 kHz-200 MHz	Hewlett Packard	11947A	3107A01877	08-Oct-19	08-Oct-20
1205	One phase voltage regulator, 2kVA, 0-250V	Hermon Laboratories	TDGC-2	109	21-Apr-20	21-Apr-21
2888	LISN Two-line V-Network 50 Ohm / 50 uH + 5 Ohm, 16A, MIL STD 461E, CISPR 16-1	Rolf Heine	NNB-2/16Z	02/10018	17-Mar-20	17-Mar-21
3901	Microwave Cable Assembly, 40.0 GHz, 3.5 m, SMA/SMA	Huber-Suhner	SUCOFL EX 102A	1225/2A	06-Apr-20	06-Apr-21
3903	Microwave Cable Assembly, 40.0 GHz, 1.5 m, SMA/SMA	Huber-Suhner	SUCOFL EX 102A	1226/2A	06-Apr-20	06-Apr-21
4360	EMI Test Receiver, 20 Hz to 40 GHz.	Rohde & Schwarz	ESU40	100322	20-Jan-20	20-Jan-21
4933	Active Horn Antenna, 1 GHz to 18 GHz	COM-POWER CORPORATION	AHA-118	701046	06-Jan-20	06-Jan-21
5085	Attenuator, 4 dB, DC - 6 GHz, 1 W	Mini-Circuits	UNAT-4+	NA	22-May-20	22-May-21
5288	Trilog Antenna, 25 MHz - 8 GHz, 100W	Frankonia	ALX-8000E	00809	08-Feb-19	08-Feb-22
5311	Controller	Dolev Ltd	FC-06	FC06.1-2016-024	23-Apr-20	23-Apr-21
5376	EXA Signal Analyzer, 10 Hz - 32 GHz	Keysight Technologies	N9010B	MY57470404	18-Mar-20	18-Mar-21
5397	H-field near field probe, 3 cm	ETS Lindgren	7405-902	NA	31-Jul-18	31-Jul-20
5405	RF cable, 18 GHz, N-N, 6 m	Huber-Suhner	SF118/11 N(x2)	500023/118	11-Aug-19	11-Aug-20
5476	Cable, BNC/BNC, 10.5 m	Western wire	MIL-C-17G	NA	14-May-20	14-May-21
5707	EMI receiver	PMM / Narda	PMM 9010F	060WW91101	22-Nov-19	22-Nov-21

10 APPENDIX B Test equipment correction factors

HL 0446: Active Loop Antenna
EMCO, model: 6502, s/n 2857

Frequency,	Measured antenna factor, dBS/m	Measurement uncertainty, dB
10	-33.4	±1.0
20	-37.8	±1.0
50	-40.5	±1.0
75	-41.0	±1.0
100	-41.2	±1.0
150	-41.2	±1.0
250	-41.1	±1.0
500	-41.2	±1.0
750	-41.3	±1.0
1000	-41.3	±1.0

Frequency,	Measured antenna factor, dBS/m	Measurement uncertainty, dB
2000	-41.4	±1.0
3000	-41.4	±1.0
4000	-41.5	±1.0
5000	-41.5	±1.0
10000	-41.7	±1.0
15000	-42.1	±1.0
20000	-42.7	±1.0
25000	-44.2	±1.0
30000	-45.8	±1.0

The antenna factor shall be added to receiver reading in dB μ V to obtain field strength in dB μ A/m.

HL 4933: Active Horn Antenna
COM-POWER CORPORATION, model: AHA-118, s/n 701046

Frequency, MHz	Measured antenna factor (with preamplifier), dB/m
1000	-16.1
1500	-15.1
2000	-10.9
2500	-11.9
3000	-11.1
3500	-10.6
4000	-8.6
4500	-8.3
5000	-5.9
5500	-5.7
6000	-3.3
6500	-4.0
7000	-2.2
7500	-1.7
8000	1.1
8500	-0.8
9000	-1.5
9500	-0.2

Frequency, MHz	Measured antenna factor (with preamplifier), dB/m
10000	1.8
10500	1.0
11000	0.3
11500	-0.5
12000	3.1
12500	1.4
13000	-0.3
13500	-0.4
14000	2.5
14500	2.2
15000	1.9
15500	0.5
16000	2.1
16500	1.2
17000	0.6
17500	3.1
18000	4.2

The antenna factor shall be added to receiver reading in dB μ V to obtain field strength in dB μ V/m.

HL 5288: Trilog Antenna
 Frankonia, model: ALX-8000E, s/n: 00809
 30-1000 MHz

Frequency, MHz	Antenna factor, dB/m
30	14.96
35	15.33
40	16.37
45	17.56
50	17.95
60	16.87
70	13.22
80	10.56
90	13.61
100	15.46
120	14.03
140	12.23

Frequency, MHz	Antenna factor, dB/m
160	12.67
180	13.34
200	15.40
250	16.42
300	17.28
400	19.98
500	21.11
600	22.90
700	24.13
800	25.25
900	26.35
1000	27.18

The antenna factor shall be added to receiver reading in dB μ V to obtain field strength in dB μ V/m.

above 1000 MHz

Frequency, MHz	Antenna factor, dB/m
1000	26.9
1100	28.1
1200	28.4
1300	29.6
1400	29.1
1500	30.4
1600	30.7
1700	31.5
1800	32.3
1900	32.6
2000	32.5
2100	32.9
2200	33.5
2300	33.2
2400	33.7
2500	34.6
2600	34.7
2700	34.6
2800	35.0
2900	35.5
3000	36.2
3100	36.8
3200	36.8
3300	37.0
3400	37.5
3500	38.2

Frequency, MHz	Antenna factor, dB/m
3600	38.9
3700	39.4
3800	39.4
3900	39.6
4000	39.7
4100	39.8
4200	40.5
4300	40.9
4400	41.1
4500	41.4
4600	41.3
4700	41.6
4800	41.9
4900	42.3
5000	42.7
5100	43.0
5200	42.9
5300	43.5
5400	43.6
5500	44.3
5600	44.7
5700	45.0
5800	45.0
5900	45.3
6000	45.9

The antenna factor shall be added to receiver reading in dB μ V to obtain field strength in dB μ V/m.

HL 5405: RF Cable
 Huber-Suhner, model: SF118/11N(x2), s/n: 500023/118
 Calibration date: 01-Aug-2018

Set / Applied, MHz	Measured, dB	Uncertainty, dB
0.1	0.01	±0.07
50	0.23	±0.07
100	0.32	±0.07
200	0.45	±0.08
300	0.55	±0.08
400	0.64	±0.08
500	0.71	±0.08
600	0.78	±0.08
700	0.85	±0.08
800	0.91	±0.08
900	0.97	±0.08
1000	1.02	±0.08
1100	1.07	±0.08
1200	1.12	±0.08
1300	1.16	±0.08
1400	1.21	±0.08
1500	1.25	±0.08
1600	1.30	±0.08
1700	1.34	±0.08
1800	1.38	±0.08
1900	1.42	±0.08
2000	1.47	±0.08
2500	1.64	±0.10
3000	1.81	±0.10
3500	1.97	±0.10
4000	2.11	±0.10
4500	2.25	±0.10
5000	2.38	±0.10
5500	2.48	±0.10
6000	2.59	±0.10
6500	2.72	±0.10
7000	2.84	±0.13
7500	2.97	±0.13
8000	3.08	±0.13
8500	3.21	±0.13
9000	3.31	±0.13
9500	3.42	±0.13
10000	3.52	±0.13

11 APPENDIX C Measurement uncertainties

Expanded uncertainty at 95% confidence in Hermon Labs EMC measurements

Test description	Expanded uncertainty
Conducted emissions with LISN	9 kHz to 150 kHz: ± 3.9 dB 150 kHz to 30 MHz: ± 3.8 dB
Radiated emissions at 10 m measuring distance Horizontal polarization Vertical polarization	Biconilog antenna: ± 5.0 dB Biconical antenna: ± 5.0 dB Log periodic antenna: ± 5.1 dB Double ridged horn antenna: ± 5.3 dB Biconilog antenna: ± 5.5 dB Biconical antenna: ± 5.5 dB Log periodic antenna: ± 5.6 dB Double ridged horn antenna: ± 5.8 dB
Radiated emissions at 3 m measuring distance Horizontal polarization Vertical polarization	Biconilog antenna: ± 5.3 dB Biconical antenna: ± 5.0 dB Log periodic antenna: ± 5.3 dB Double ridged horn antenna: ± 5.3 dB Biconilog antenna: ± 6.0 dB Biconical antenna: ± 5.7 dB Log periodic antenna: ± 6.0 dB Double ridged horn antenna: ± 6.0 dB
Conducted emissions at RF antenna connector	9 kHz to 2.9 GHz: ± 2.6 dB 2.9 GHz to 6.46 GHz: ± 3.5 dB 6.46 GHz to 13.2 GHz: ± 4.3 dB 13.2 GHz to 22.0 GHz: ± 5.0 dB 22.0 GHz to 26.8 GHz: ± 5.5 dB 26.8 GHz to 40.0 GHz: ± 4.8 dB
Duty cycle, timing (Tx ON / OFF) and average factor measurements	± 1.0 %
Occupied bandwidth	± 8.0 %

Hermon Laboratories is accredited by A2LA for calibration according to present requirements of ISO/IEC 17025 and NCSL Z540-1. The accreditation is granted to perform calibration of parameters that are listed in the Scope of Hermon Laboratories Accreditation.

Hermon Laboratories calibrates its reference and transfer standards by calibration laboratories accredited to ISO/IEC 17025 by a mutually recognized Accreditation Body or by a recognized national metrology institute. All reference and transfer standards used in the calibration system are traceable to national or international standards.

In-house calibration of all test and measurement equipment is performed on a regular basis according to Hermon Laboratories calibration procedures, manufacturer calibration/verification procedures or procedures defined in the relevant standards. The Hermon Laboratories test and measurement equipment is calibrated within the tolerances specified by the manufacturers and/or by the relevant standards.

12 APPENDIX D Test laboratory description

Tests were performed at Hermon Laboratories Ltd., which is a fully independent, private, EMC, Radio, Safety, Environmental and Telecommunication testing facility.

Hermon Laboratories is recognized and accredited by the Federal Communications Commission (USA) for relevant parts of Code of Federal Regulations 47 (CFR 47), Test Firm Registration Number is 927748, Designation Number is IL1001; Recognized by Innovation, Science and Economic Development Canada for wireless and terminal testing (ISED), ISED #2186A, CAB identifier is IL1001; Certified by VCCI, Japan (the registration numbers are R-10808 for OATS, R-1082 for anechoic chamber, G-10869 for RE measurements above 1 GHz, C-10845 for conducted emissions site and T-11606 for conducted emissions at telecommunication ports).

The laboratory is accredited by American Association for Laboratory Accreditation (USA) according to ISO/IEC 17025 for electromagnetic compatibility, product safety, telecommunications testing, environmental simulation and calibration (for exact scope please refer to Certificate No. 839.01, 839.03 and 839.04).

Address: P.O. Box 23, Binyamina 3055001, Israel.
Telephone: +972 4628 8001
Fax: +972 4628 8277
e-mail: mail@hermonlabs.com
website: www.hermonlabs.com

Person for contact: Mr. Michael Nikishin, EMC&Radio group manager

13 APPENDIX E Specification references

47CFR part 15: 2019	Radio Frequency Devices.
ANSI C63.10: 2013	American National Standard of Procedures for Compliance Testing of Unlicensed Wireless Devices
ANSI C63.4: 2014	American National Standard for Methods of Measurement of Radio-Noise Emissions from Low-Voltage Electrical and Electronic Equipment in the Range of 9 kHz to 40 GHz.
RSS-210 Issue 10: 2019	Licence-Exempt Radio Apparatus: Category I Equipment
RSS-Gen Issue 5: 2018	General Requirements and Information for the certification of Radiocommunication Equipment
ICES-003 Issue 6: 2016	Information Technology Equipment (Including Digital Apparatus) – Limits and methods of measurement

14 APPENDIX F Manufacturer's declaration about periodic operation



August 16th, 2020

To: Hermon Laboratories

Attention: Mr. Sergey Samokha

Manufacturer's Declaration

We, Paradox Security Systems Ltd. located in 780 Industrial Boulevard St-Eustache, Quebec J7R 5V3, Canada declare under our sole responsibility that the product Wireless Control Panel MG5075 is operate on 433.92 MHz and designed to comply and satisfy periodic operational requirements.

MG5075 panel does not allow continuous transmitting (such as voice, video and radio control).

The Wireless Control Panel MG5075 is not manually operated device.

The transmissions of MG5075 are not periodical and occur upon intrusion only.

MG5075 panel is an intrusion alarm system device and will send automatically its synchronization message to two-way devices (wireless sirens and wireless keypads) in a certain interval (once in 4 minutes).

Since, there is no periodical behavior except synchronization transmissions, there are no predetermined intervals of any kind included in device's algorithm.

Alex Chaplik
Certification Manager

Ref : FCC Declaration MG5075_rev0

780 boul. Industriel, St-Eustache (Montréal), Québec, Canada J7R 5V3 Tel. : (450) 491-7444
PARADOX.COM

15 APPENDIX G Abbreviations and acronyms

A	ampere
AC	alternating current
A/m	ampere per meter
AM	amplitude modulation
AVRG	average (detector)
cm	centimeter
dB	decibel
dBm	decibel referred to one milliwatt
dB(μ V)	decibel referred to one microvolt
dB(μ V/m)	decibel referred to one microvolt per meter
dB(μ A)	decibel referred to one microampere
DC	direct current
EIRP	equivalent isotropically radiated power
ERP	effective radiated power
EUT	equipment under test
F	frequency
GHz	gigahertz
GND	ground
H	height
HL	Hermon laboratories
Hz	hertz
k	kilo
kHz	kilohertz
LO	local oscillator
m	meter
MHz	megahertz
min	minute
mm	millimeter
ms	millisecond
μ s	microsecond
NA	not applicable
NB	narrow band
OATS	open area test site
Ω	Ohm
PM	pulse modulation
PS	power supply
ppm	part per million (10^{-6})
QP	quasi-peak
RE	radiated emission
RF	radio frequency
rms	root mean square
Rx	receive
s	second
T	temperature
Tx	transmit
V	volt
WB	wideband

END OF TEST REPORT