



# SPORTON International Inc.

No. 52, Hwa Ya 1st Rd., Kwei-Shan Hsiang, TaoYuan Hsien, Taiwan, R.O.C.  
Ph: 886-3-327-3456 / FAX: 886-3-327-0973 / www.sporton.com.tw

## FCC RADIO TEST REPORT

Applicant's company	Belkin International, Inc.
Applicant Address	501 West Walnut Street, Compton, CA 90220-5221, U.S.A.
FCC ID	K7SF5D8235V3

Product Name	N+ Wireless Router
Brand Name	Belkin
Model Name	F5D8235-4 v3
Test Rule	47 CFR FCC Part 15 Subpart C § 15.247
Test Freq. Range	2400 ~ 2483.5MHz
Received Date	Jun. 24, 2009
Final Test Date	Aug. 11, 2009
Submission Type	Original Equipment



### Statement

**Test result included in this report is for the Draft n and 802.11b/g part of the product.**

The test result in this report refers exclusively to the presented test model / sample.

Without written approval of SPORTON International Inc., the test report shall not be reproduced except in full.

The measurements and test results shown in this test report were made in accordance with the procedures and found in compliance with the limit given in **ANSI C63.4-2003** and **47 CFR FCC Part 15 Subpart C**.

The test equipment used to perform the test is calibrated and traceable to NML/ROC.



## Table of Contents

<b>1. CERTIFICATE OF COMPLIANCE .....</b>	<b>1</b>
<b>2. SUMMARY OF THE TEST RESULT .....</b>	<b>2</b>
<b>3. GENERAL INFORMATION .....</b>	<b>3</b>
3.1. Product Details.....	3
3.2. Accessories.....	5
3.3. Table for Filed Antenna.....	5
3.4. Table for Carrier Frequencies .....	6
3.5. Table for Test Modes.....	6
3.6. Table for Testing Locations.....	7
3.7. Table for Supporting Units .....	7
3.8. Table for Parameters of Test Software Setting .....	8
3.9. Test Configurations .....	9
<b>4. TEST RESULT .....</b>	<b>11</b>
4.1. AC Power Line Conducted Emissions Measurement.....	11
4.2. Maximum Conducted Output Power Measurement.....	15
4.3. Power Spectral Density Measurement .....	28
4.4. 6dB Spectrum Bandwidth Measurement .....	37
4.5. Radiated Emissions Measurement .....	46
4.6. Band Edge Emissions Measurement .....	76
4.7. Antenna Requirements .....	85
<b>5. LIST OF MEASURING EQUIPMENTS .....</b>	<b>86</b>
<b>6. TEST LOCATION.....</b>	<b>87</b>
<b>7. TAF CERTIFICATE OF ACCREDITATION .....</b>	<b>88</b>
<b>APPENDIX A. PHOTOGRAPHS OF EUT.....</b>	<b>A1 ~ A15</b>
<b>APPENDIX B. TEST PHOTOS.....</b>	<b>B1 ~ B5</b>
<b>APPENDIX C. MAXIMUM PERMISSIBLE EXPOSURE.....</b>	<b>C1 ~C3</b>







## 1. CERTIFICATE OF COMPLIANCE

Product Name : N+ Wireless Router  
Brand Name : Belkin  
Model Name : F5D8235-4 v3  
Applicant : Belkin International, Inc.  
Test Rule Part(s) : 47 CFR FCC Part 15 Subpart C § 15.247

Sporton International as requested by the applicant to evaluate the EMC performance of the product sample received on Jun. 24, 2009 would like to declare that the tested sample has been evaluated and found to be in compliance with the tested rule parts. The data recorded as well as the test configuration specified is true and accurate for showing the sample's EMC nature.

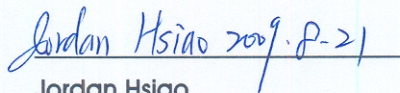
A handwritten signature in blue ink that reads "Jordan Hsiao 2009.8.21". The signature is written over a horizontal line.

Jordan Hsiao

SPORTON INTERNATIONAL INC.



## 2. SUMMARY OF THE TEST RESULT

Applied Standard: 47 CFR FCC Part 15 Subpart C				
Part	Rule Section	Description of Test	Result	Under Limit
4.1	15.207	AC Power Line Conducted Emissions	Complies	13.18 dB
4.2	15.247(b)(3)	Maximum Conducted Output Power	Complies	5.85 dB
4.3	15.247(e)	Power Spectral Density	Complies	9.65 dB
4.4	15.247(a)(2)	6dB Spectrum Bandwidth	Complies	-
4.5	15.247(d)	Radiated Emissions	Complies	0.12 dB
4.6	15.247(d)	Band Edge Emissions	Complies	0.09 dB
4.7	15.203	Antenna Requirements	Complies	-

Test Items	Uncertainty	Remark
AC Power Line Conducted Emissions	±2.3dB	Confidence levels of 95%
Maximum Conducted Output Power	±0.8dB	Confidence levels of 95%
Power Spectral Density	±0.5dB	Confidence levels of 95%
6dB Spectrum Bandwidth	±8.5×10 <sup>-8</sup>	Confidence levels of 95%
Radiated Emissions (9kHz~30MHz)	±0.8dB	Confidence levels of 95%
Radiated Emissions (30MHz~1000MHz)	±1.9dB	Confidence levels of 95%
Radiated / Band Edge Emissions (1GHz~18GHz)	±1.9dB	Confidence levels of 95%
Radiated Emissions (18GHz~40GHz)	±1.9dB	Confidence levels of 95%
Temperature	±0.7°C	Confidence levels of 95%
Humidity	±3.2%	Confidence levels of 95%
DC / AC Power Source	±1.4%	Confidence levels of 95%

### 3. GENERAL INFORMATION

#### 3.1. Product Details

##### Draft n

Items	Description
Product Type	WLAN (2TX, 2RX)
Radio Type	Intentional Transceiver
Power Type	From Power Adapter
Modulation	see the below table for draft n
Data Modulation	OFDM (BPSK / QPSK / 16QAM / 64QAM)
Data Rate (Mbps)	see the below table for Draft n
Frequency Range	2400 ~ 2483.5MHz
Channel Number	11 for 20MHz bandwidth ; 7 for 40MHz bandwidth
Channel Band Width (99%)	MCS8 (20MHz): 17.56 MHz ; MCS8 (40MHz): 36.32 MHz
Conducted Output Power	MCS8 (20MHz): 24.15 dBm ; MCS8 (40MHz): 16.77 dBm
Carrier Frequencies	Please refer to section 3.4
Antenna	Please refer to section 3.3

##### 802.11b/g

Items	Description
Product Type	802.11b/g :WLAN (1TX, 1RX)
Radio Type	Intentional Transceiver
Power Type	From Power Adapter
Modulation	DSSS for IEEE 802.11b ; OFDM for IEEE 802.11g
Data Modulation	DSSS (BPSK / QPSK / CCK) ; OFDM (BPSK / QPSK / 16QAM / 64QAM)
Data Rate (Mbps)	DSSS (1/ 2/ 5.5/11) ; OFDM (6/9/12/18/24/36/48/54)
Frequency Range	2400 ~ 2483.5MHz
Channel Number	11
Channel Band Width (99%)	11b: 10.08 MHz ; 11g: 16.36 MHz
Conducted Output Power	11b: 14.59 dBm ; 11g: 21.03 dBm
Carrier Frequencies	Please refer to section 3.4
Antenna	Please refer to section 3.3

**Antenna & Band width**

Antenna	Single (TX)		Two (TX)	
	20 MHz	40 MHz	20 MHz	40 MHz
Band width Mode				
802.11b	V	X	X	X
802.11g	V	X	X	X
Draft n	X	X	V	V

**Draft n spec**

MCS Index	Nss	Modulation	R	NBPCS	NCBPS		NDBPS		Datarate(Mbps)			
					20MHz	40MHz	20MHz	40MHz	800nsGI		400nsGI	
									20MHz	40MHz	20MHz	40MHz
0	1	BPSK	1/2	1	52	108	26	54	6.5	13.5	7.200	15
1	1	QPSK	1/2	2	104	216	52	108	13.0	27.0	14.400	30
2	1	QPSK	3/4	2	104	216	78	162	19.5	40.5	21.700	45
3	1	16-QAM	1/2	4	208	432	104	216	26.0	54.0	28.900	60
4	1	16-QAM	3/4	4	208	432	156	324	39.0	81.0	43.300	90
5	1	64-QAM	2/3	6	312	648	208	432	52.0	108.0	57.800	120
6	1	64-QAM	3/4	6	312	648	234	486	58.5	121.5	65.000	135
7	1	64-QAM	5/6	6	312	648	260	540	65.0	135.0	72.200	150
8	2	BPSK	1/2	1	104	216	52	108	13.0	27.0	14.444	30
9	2	QPSK	1/2	2	208	432	104	216	26.0	54.0	28.889	60
10	2	QPSK	3/4	2	208	432	156	324	39.0	81.0	43.333	90
11	2	16-QAM	1/2	4	416	864	208	432	52.0	108.0	57.778	120
12	2	16-QAM	3/4	4	416	864	312	648	78.0	162.0	86.667	180
13	2	64-QAM	2/3	6	624	1296	416	864	104.0	216.0	115.556	240
14	2	64-QAM	3/4	6	624	1296	468	972	117.0	243.0	130.000	270
15	2	64-QAM	5/6	6	624	1296	520	1080	130.0	270.0	144.444	300

Symbol	Explanation
NSS	Number of spatial streams
R	Code rate
NBPCS	Number of coded bits per single carrier
NCBPS	Number of coded bits per symbol
NDBPS	Number of data bits per symbol
GI	guard interval

### 3.2. Accessories

Power	Brand	Model	Rating
Adapter 1	Foxlink	FA-1501250SUA	Input: 100-240VAC, 50/60Hz, 0.5A Output: 15VDC, 1.25A

### 3.3. Table for Filed Antenna

Ant.	Brand	Model Name	Antenna Type	Connector	Gain (dBi)	Remark
A (J8)	Arcadyan	120300029300J	Dipole Antenna	N/A	2.0	TX/RX
B (J7)	Arcadyan	120300029300J	Dipole Antenna	N/A	2.0	TX/RX

Note: The EUT has two antennas, the two antenna ports are with transmitter/receiver diversity function.

#### For 802.11b/g Mode:

Due to Ant. A & Ant. B are identical and the “J8” generated higher output power than “J7”. All the test were base on this setting and recorded in this report.

#### For Draft n Mode:

Ant. A and Ant. B can be used as transmitting/receiving antenna.

Ant. A and Ant. B will transmit/receive the same signal simultaneously.

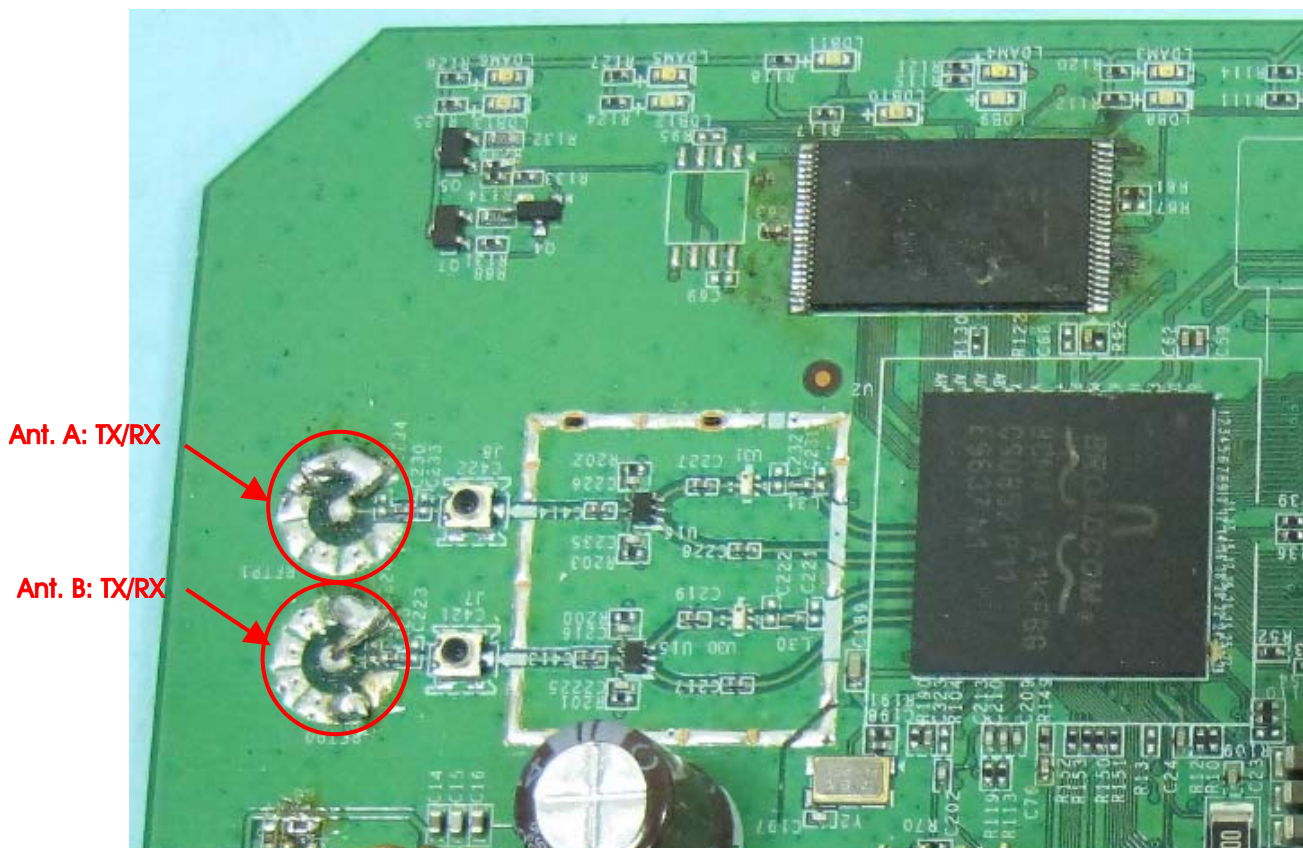



### 3.4. Table for Carrier Frequencies

There are two bandwidth systems for draft n.

For both 20MHz bandwidth systems, use Channel 1~Channel 11.

For both 40MHz bandwidth systems, use Channel 3~Channel 9.

Frequency Band	Channel No.	Frequency	Channel No.	Frequency
2400~2483.5MHz	1	2412 MHz	7	2442 MHz
	2	2417 MHz	8	2447 MHz
	3	2422 MHz	9	2452 MHz
	4	2427 MHz	10	2457 MHz
	5	2432 MHz	11	2462 MHz
	6	2437 MHz		

### 3.5. Table for Test Modes

Preliminary tests were performed in different data rate to find the worst radiated emission. The data rate shown in the table below is the worst-case rate with respect to the specific test item. Investigation has been done on all the possible configurations for searching the worst cases. The following table is a list of the test modes shown in this test report.

Test Items	Mode	Data Rate	Channel	Antenna
AC Power Line Conducted Emissions	Normal Link	-	-	-
Maximum Peak Conducted Output Power	MCS8/20MHz	13 Mbps	1/6/11	A / B / A+B
	MCS8/40MHz	27 Mbps	3/6/9	A / B / A+B
	11b/BPSK	1 Mbps	1/6/11	A
	11g/BPSK	6 Mbps	1/6/11	A
Power Spectral Density 6dB Spectrum Bandwidth	MCS8/20MHz	13 Mbps	1/6/11	A+B
	MCS8/40MHz	27 Mbps	3/6/9	A+B
	11b/BPSK	1 Mbps	1/6/11	A
	11g/BPSK	6 Mbps	1/6/11	A
Radiated Emissions 9kHz~1GHz	Normal Link	-	-	-
Radiated Emissions 1GHz~10 <sup>th</sup> Harmonic	MCS8/20MHz	13 Mbps	1/6/11	A+B
	MCS8/40MHz	27 Mbps	3/6/9	A+B
	11b/BPSK	1 Mbps	1/6/11	A
	11g/BPSK	6 Mbps	1/6/11	A
Band Edge Emissions	MCS8/20MHz	13 Mbps	1/11	A+B
	MCS8/40MHz	27 Mbps	3/9	A+B
	11b/BPSK	1 Mbps	1/11	A
	11g/BPSK	6 Mbps	1/11	A

### 3.6. Table for Testing Locations

Test Site No.	Site Category	Location	FCC Reg. No.	IC File No.	VCCI Reg. No
03CH03-HY	SAC	Hwa Ya	480872	IC 4088	-
CO04-HY	Conduction	Hwa Ya	480872	IC 4088	-
TH01-HY	OVEN Room	Hwa Ya	-	-	-

Open Area Test Site (OATS); Semi Anechoic Chamber (SAC); Fully Anechoic Chamber (FAC).

Please refer section 6 for Test Site Address.

### 3.7. Table for Supporting Units

Support Unit	Brand	Model	FCC ID
Notebook	DELL	D400	E2K24GBRL
Notebook	DELL	M1330	E2KWM3945ABG
Notebook	DELL	1200	E2K4965AGNM
HUB	Laneed	LD-LSW16C/AT	N/A
FLASH DISK	SCANDISK	SDCZ6-4096KB	N/A

### 3.8. Table for Parameters of Test Software Setting

During testing, Channel & Power Controlling Software provided by the customer was used to control the operating channel as well as the output power level. The RF output power selection is for the setting of RF output power expected by the customer and is going to be fixed on the firmware of the final end product.

#### Power Parameters of Draft n MCS8 20MHz

Test Software Version	DOS		
Frequency	2412 MHz	2437 MHz	2462 MHz
Ant. A / Ant. B	40	72	34

#### Power Parameters of Draft n MCS8 40MHz

Test Software Version	DOS		
Frequency	2422 MHz	2437 MHz	2452 MHz
Ant. A / Ant. B	36	46	33

#### Power Parameters of IEEE 802.11b

Test Software Version	DOS		
Frequency	2412 MHz	2437 MHz	2462 MHz
Ant. A	50	50	50

#### Power Parameters of IEEE 802.11g

Test Software Version	DOS		
Frequency	2412 MHz	2437 MHz	2462 MHz
Ant. A	41	72	40

During the test, the following programs under WIN XP were executed:

At the same time, "DOS" was executed the test program to control the EUT continuously transmit RF signal. Executed "USB read write.bat" to traffic data to link with the remote workstation by LAN and WLAN through the RJ-45 Cable.

### 3.9. Test Configurations

#### 3.9.1. Radiation Emissions Test Configuration

Test Configuration: 9KHz~1GHz

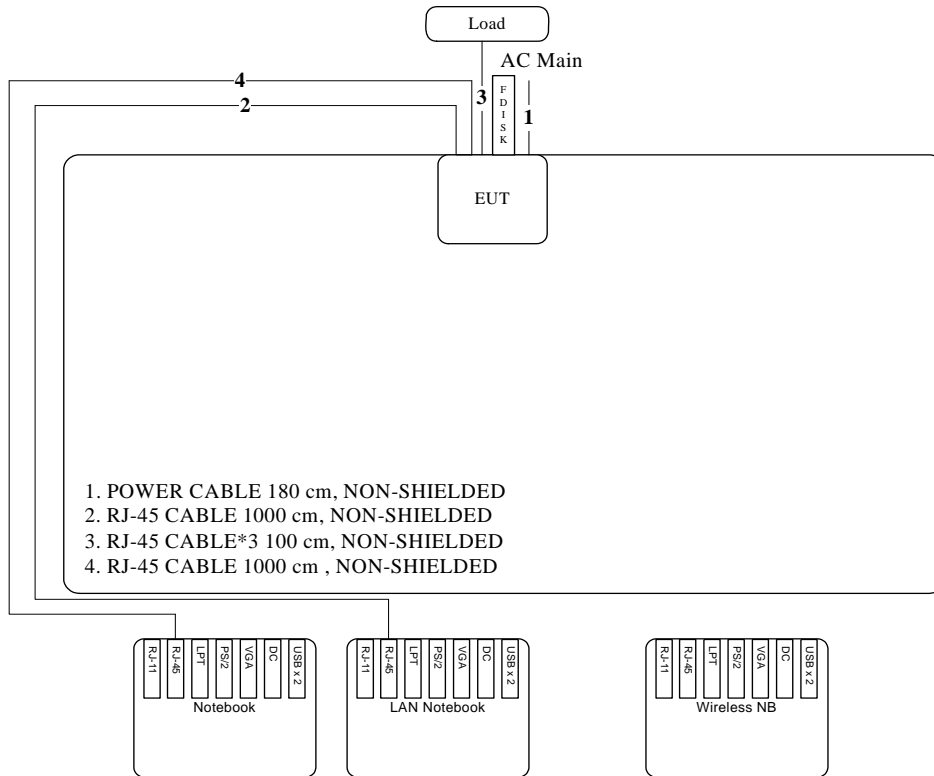

Test Configuration: above 1GHz

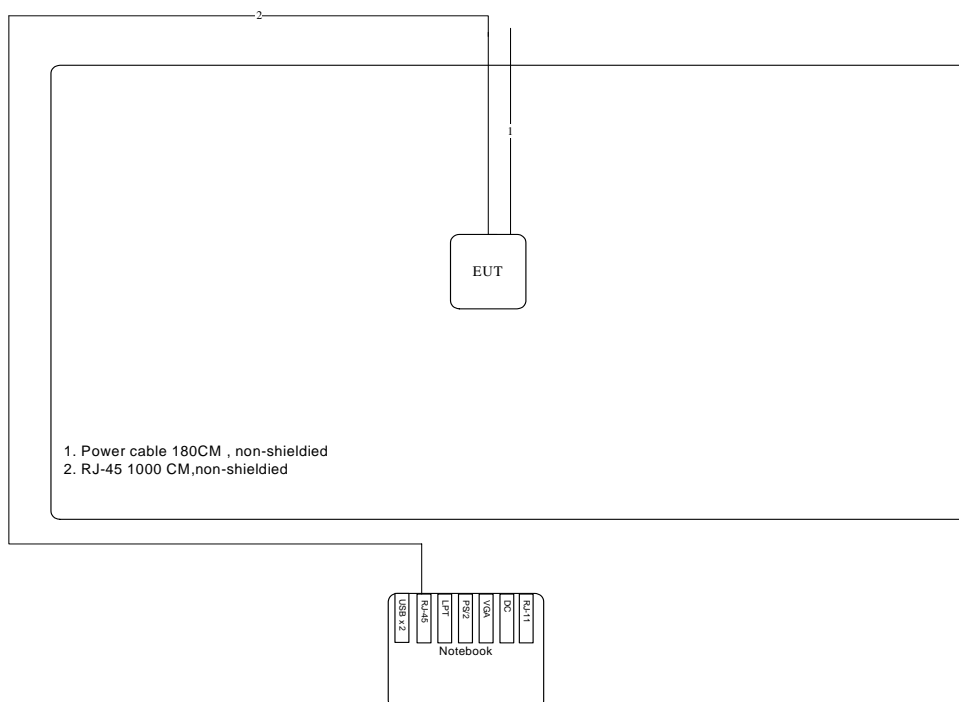



### 3.9.2. AC Power Line Conduction Emissions Test Configuration

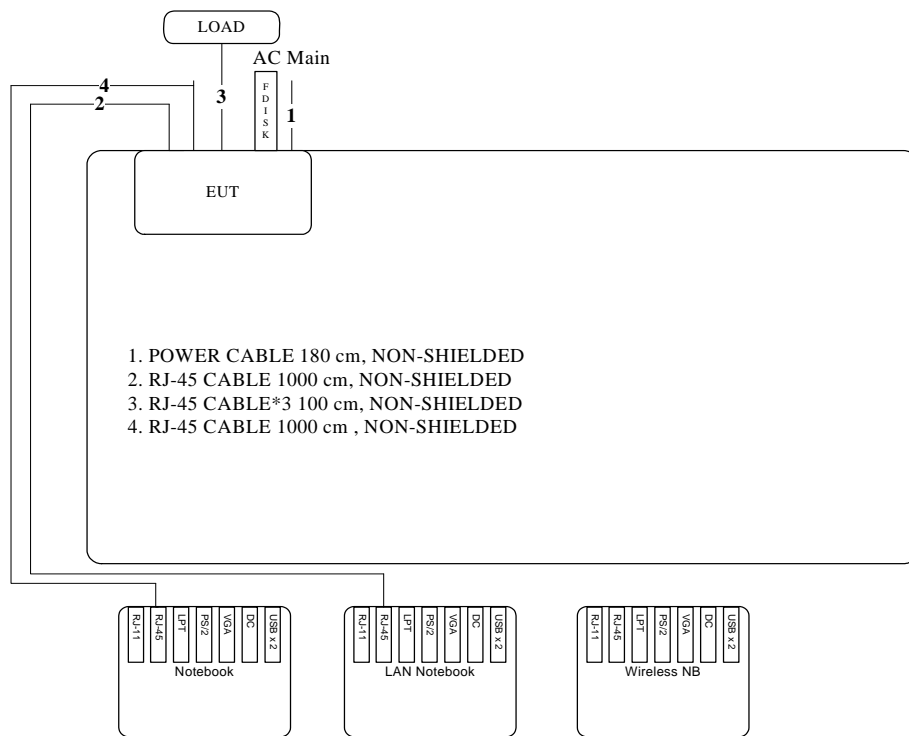

## 4. TEST RESULT

### 4.1. AC Power Line Conducted Emissions Measurement

#### 4.1.1. Limit

For this product which is designed to be connected to the AC power line, the radio frequency voltage that is conducted back onto the AC power line on any frequency or frequencies within the band 150 kHz to 30 MHz shall not exceed below limits table.

Frequency (MHz)	QP Limit (dBuV)	AV Limit (dBuV)
0.15~0.5	66~56	56~46
0.5~5	56	46
5~30	60	50

#### 4.1.2. Measuring Instruments and Setting

Please refer to section 5 of equipments list in this report. The following table is the setting of the receiver.

Receiver Parameters	Setting
Attenuation	10 dB
Start Frequency	0.15 MHz
Stop Frequency	30 MHz
IF Bandwidth	9 KHz

#### 4.1.3. Test Procedures

1. Configure the EUT according to ANSI C63.4. The EUT or host of EUT has to be placed 0.4 meter far from the conducting wall of the shielding room and at least 80 centimeters from any other grounded conducting surface.
2. Connect EUT or host of EUT to the power mains through a line impedance stabilization network (LISN).
3. All the support units are connected to the other LISNs. The LISN should provide 50uH/50ohms coupling impedance.
4. The frequency range from 150 KHz to 30 MHz was searched.
5. Set the test-receiver system to Peak Detect Function and Specified Bandwidth with Maximum Hold Mode.
6. The measurement has to be done between each power line and ground at the power terminal.

#### 4.1.4. Test Setup Layout

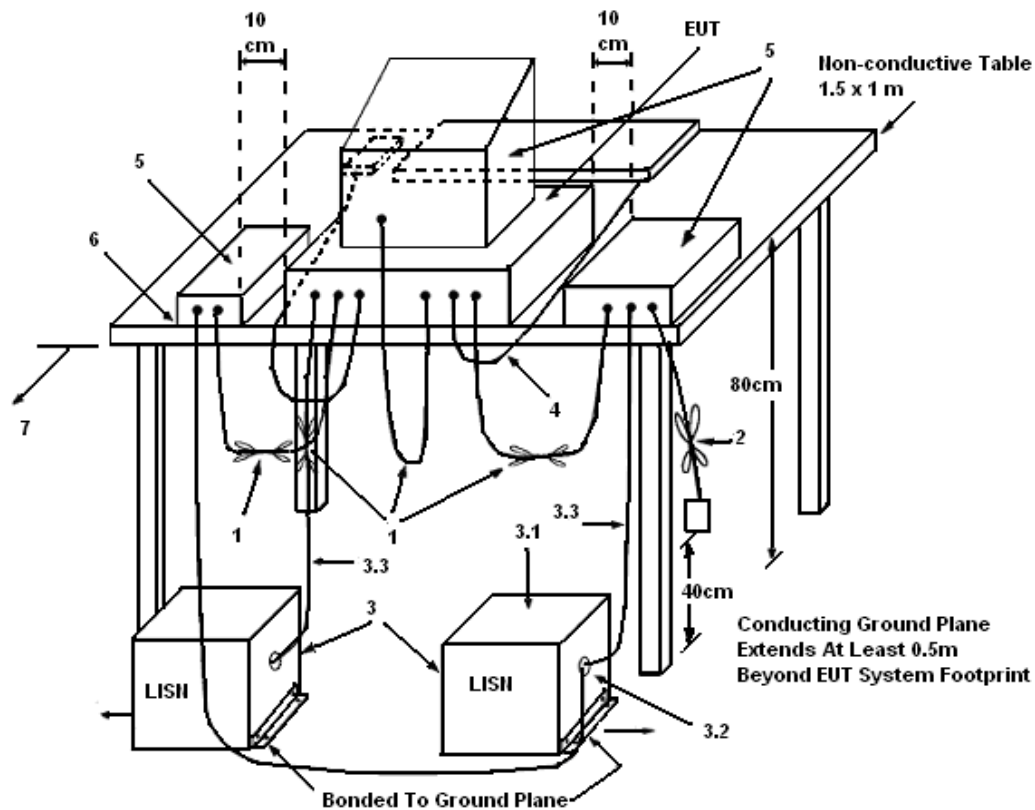

#### LEGEND:

- (1) Interconnecting cables that hang closer than 40 cm to the ground plane shall be folded back and forth in the center forming a bundle 30 to 40 cm long.
- (2) I/O cables that are not connected to a peripheral shall be bundled in the center. The end of the cable may be terminated, if required, using the correct terminating impedance. The overall length shall not exceed 1 m.
- (3) EUT connected to one LISN. Unused LISN measuring port connectors shall be terminated in 50 Ω. LISN can be placed on top of, or immediately beneath, reference ground plane.
  - (3.1) All other equipment powered from additional LISN(s).
  - (3.2) Multiple outlet strip can be used for multiple power cords of non-EUT equipment.
  - (3.3) LISN at least 80 cm from nearest part of EUT chassis.
- (4) Cables of hand-operated devices, such as keyboards, mice, etc., shall be placed as for normal use.
- (5) Non-EUT components of EUT system being tested.
- (6) Rear of EUT, including peripherals, shall all be aligned and flush with rear of tabletop.
- (7) Rear of tabletop shall be 40 cm removed from a vertical conducting plane that is bonded to the ground plane.

#### 4.1.5. Test Deviation

There is no deviation with the original standard.

#### 4.1.6. EUT Operation during Test

The EUT was placed on the test table and programmed in normal function.

#### 4.1.7. Results of AC Power Line Conducted Emissions Measurement

Temperature	24.1°C	Humidity	53.1%
Test Engineer	Aric Li	Phase	Line
Configuration	Normal Link		

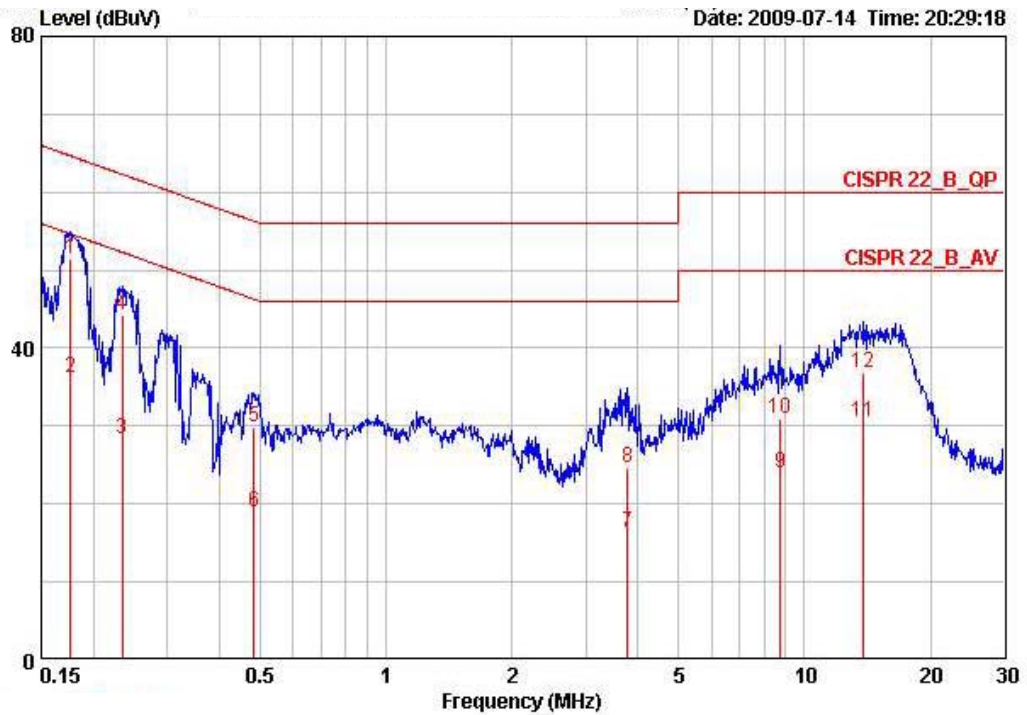

	Freq	Level	Over Limit	Limit Line	Read Level	LISN Factor	Cable Loss	Remark
	MHz	dBuV	dB	dBuV	dBuV	dB	dB	
1	0.17584	51.43	-13.25	64.68	51.17	0.06	0.20	QP
2	0.17584	36.21	-18.47	54.68	35.95	0.06	0.20	AVERAGE
3	0.23409	28.44	-23.87	52.30	28.19	0.05	0.20	AVERAGE
4	0.23409	44.19	-18.12	62.30	43.94	0.05	0.20	QP
5	0.48375	29.94	-26.33	56.27	29.81	0.03	0.10	QP
6	0.48375	19.04	-27.23	46.27	18.91	0.03	0.10	AVERAGE
7	3.779	16.38	-29.62	46.00	15.98	0.10	0.30	AVERAGE
8	3.779	24.65	-31.35	56.00	24.25	0.10	0.30	QP
9	8.776	24.05	-25.95	50.00	23.44	0.31	0.30	AVERAGE
10	8.776	30.93	-29.07	60.00	30.32	0.31	0.30	QP
11	13.841	30.52	-19.48	50.00	29.61	0.51	0.40	AVERAGE
12	13.841	36.75	-23.25	60.00	35.84	0.51	0.40	QP



Temperature	24.1°C	Humidity	53.1%
Test Engineer	Aric Li	Phase	Neutral
Configuration	Normal Link		

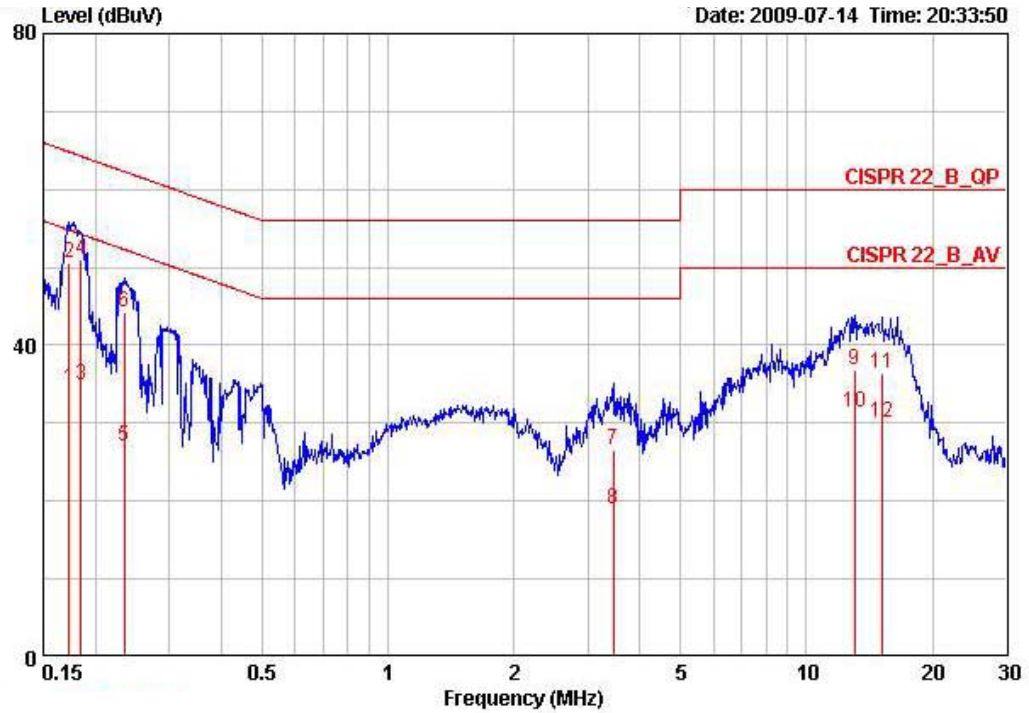

	Freq	Level	Over	Limit	Read	LISN	Cable	Remark
	MHz	dBuV	dB	dBuV	dBuV	dB	dB	
1	0.17307	34.46	-20.35	54.81	34.17	0.09	0.20	AVERAGE
2	0.17307	50.67	-14.14	64.81	50.38	0.09	0.20	QP
3	0.18507	34.80	-19.46	54.26	34.51	0.09	0.20	AVERAGE
4	0.18507	51.08	-13.18	64.26	50.79	0.09	0.20	QP
5	0.23409	26.95	-25.36	52.30	26.67	0.08	0.20	AVERAGE
6	0.23409	44.16	-18.15	62.30	43.88	0.08	0.20	QP
7	3.454	26.59	-29.41	56.00	26.17	0.13	0.29	QP
8	3.454	18.97	-27.03	46.00	18.55	0.13	0.29	AVERAGE
9	13.057	36.84	-23.16	60.00	35.93	0.51	0.40	QP
10	13.057	31.36	-18.64	50.00	30.45	0.51	0.40	AVERAGE
11	15.226	36.36	-23.64	60.00	35.38	0.58	0.40	QP
12	15.226	30.13	-19.87	50.00	29.15	0.58	0.40	AVERAGE

Note:

Level = Read Level + LISN Factor + Cable Loss.

## 4.2. Maximum Conducted Output Power Measurement

### 4.2.1. Limit

For systems using digital modulation in the 2400-2483.5MHz, the limit for peak output power is 30dBm. The limited has to be reduced by the amount in dB that the gain of the antenna exceed 6dBi. In case of point-to-point operation, the limit has to be reduced by 1dB for every 3dB that the directional gain of the antenna exceeds 6dBi.

### 4.2.2. Measuring Instruments and Setting

Please refer to section 5 of equipments list in this report. The following table is the setting of the spectrum analyzer.

Spectrum Parameter	Setting
Attenuation	Auto
Span Frequency	Encompass the entire emissions bandwidth (EBW) of the signal
RB	1MHz
VB	3MHz
Detector	RMS
Trace	Max Hold
Sweep Time	Auto

### 4.2.3. Test Procedures

1. The transmitter output (antenna port) was connected to the spectrum analyzer.
2. Test was performed in accordance with Measurement of Digital Transmission Systems Operating under Section 15.247 March 23, 2005.
3. When measuring maximum conducted output power with multiple antenna systems, add every result of the values by mathematic formula.

### 4.2.4. Test Setup Layout

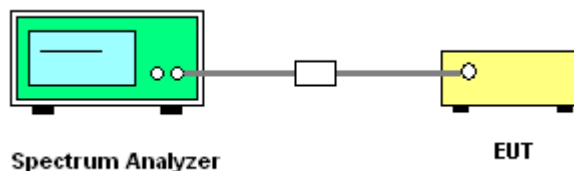

### 4.2.5. Test Deviation

There is no deviation with the original standard.

### 4.2.6. EUT Operation during Test

The EUT was programmed to be in continuously transmitting mode.

#### 4.2.7. Test Result of Maximum Conducted Output Power

<b>Temperature</b>	23°C	<b>Humidity</b>	58%
<b>Test Engineer</b>	Johnson Chang	<b>Configurations</b>	Draft n

##### Configuration Draft n MCS8 20MHz Ant. A

Channel	Frequency	Conducted Power (dBm)	Max. Limit (dBm)	Result
1	2412 MHz	14.20	30.00	Complies
6	2437 MHz	21.02	30.00	Complies
11	2462 MHz	14.27	30.00	Complies

##### Configuration Draft n MCS8 20MHz Ant. B

Channel	Frequency	Conducted Power (dBm)	Max. Limit (dBm)	Result
1	2412 MHz	13.77	30.00	Complies
6	2437 MHz	21.25	30.00	Complies
11	2462 MHz	13.55	30.00	Complies

##### Configuration Draft n MCS8 20MHz Ant. A + Ant. B

Channel	Frequency	Conducted Power (dBm)	Max. Limit (dBm)	Result
1	2412 MHz	17.00	30.00	Complies
6	2437 MHz	24.15	30.00	Complies
11	2462 MHz	16.94	30.00	Complies

**Configuration Draft n MCS8 40MHz Ant. A**

Channel	Frequency	Conducted Power (dBm)	Max. Limit (dBm)	Result
3	2422 MHz	11.17	30.00	Complies
6	2437 MHz	13.48	30.00	Complies
9	2452 MHz	9.94	30.00	Complies

**Configuration Draft n MCS8 40MHz Ant. B**

Channel	Frequency	Conducted Power (dBm)	Max. Limit (dBm)	Result
3	2422 MHz	11.70	30.00	Complies
6	2437 MHz	14.03	30.00	Complies
9	2452 MHz	10.61	30.00	Complies

**Configuration Draft n MCS8 40MHz Ant. A + Ant. B**

Channel	Frequency	Conducted Power (dBm)	Max. Limit (dBm)	Result
3	2422 MHz	14.45	30.00	Complies
6	2437 MHz	16.77	30.00	Complies
9	2452 MHz	13.30	30.00	Complies



<b>Temperature</b>	23°C	<b>Humidity</b>	58%
<b>Test Engineer</b>	Johnson Chang	<b>Configurations</b>	802.11b/g

**Configuration IEEE 802.11b Ant. A**

Channel	Frequency	Conducted Power (dBm)	Max. Limit (dBm)	Result
1	2412 MHz	13.77	30.00	<b>Complies</b>
6	2437 MHz	14.59	30.00	<b>Complies</b>
11	2462 MHz	13.73	30.00	<b>Complies</b>

**Configuration IEEE 802.11g Ant. A**

Channel	Frequency	Conducted Power (dBm)	Max. Limit (dBm)	Result
1	2412 MHz	12.88	30.00	<b>Complies</b>
6	2437 MHz	21.03	30.00	<b>Complies</b>
11	2462 MHz	13.25	30.00	<b>Complies</b>

Conducted Output Power Plot on Configuration Draft n MCS8 20MHz Ant. A / 2412 MHz

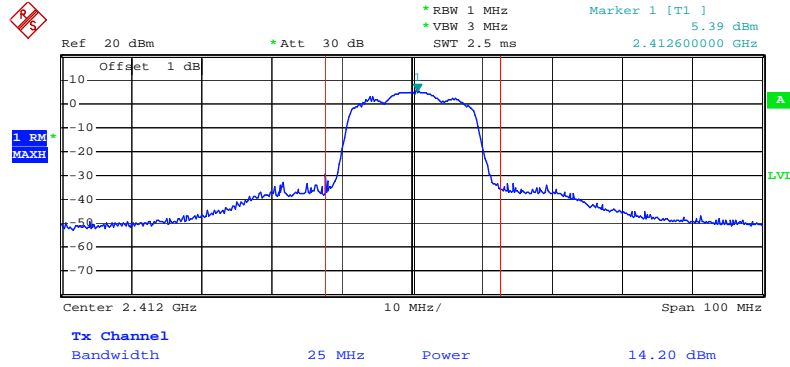

Date: 11.AUG.2009 14:42:28

Conducted Output Power Plot on Configuration Draft n MCS8 20MHz Ant. A / 2437 MHz

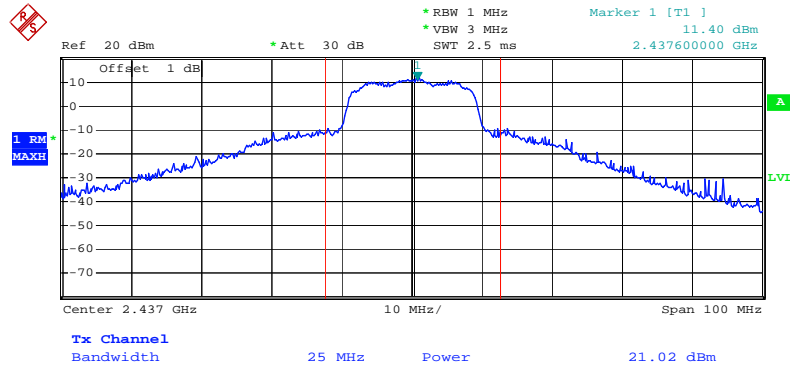

Date: 11.AUG.2009 14:39:16

### Conducted Output Power Plot on Configuration Draft n MCS8 20MHz Ant. A / 2462 MHz

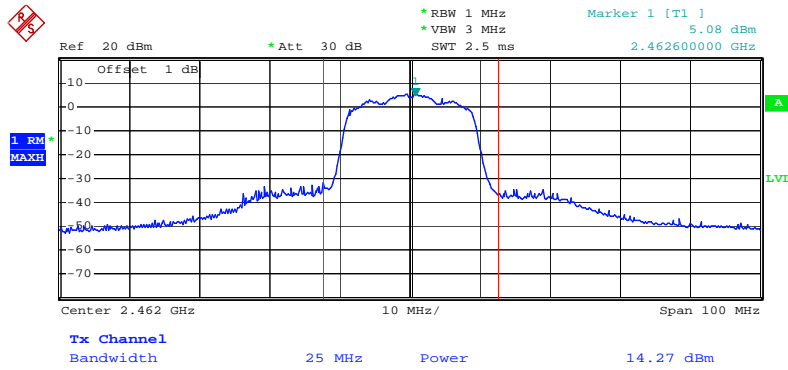

Date: 11.AUG.2009 14:43:56

### Conducted Output Power Plot on Configuration Draft n MCS8 20MHz Ant. B / 2412 MHz

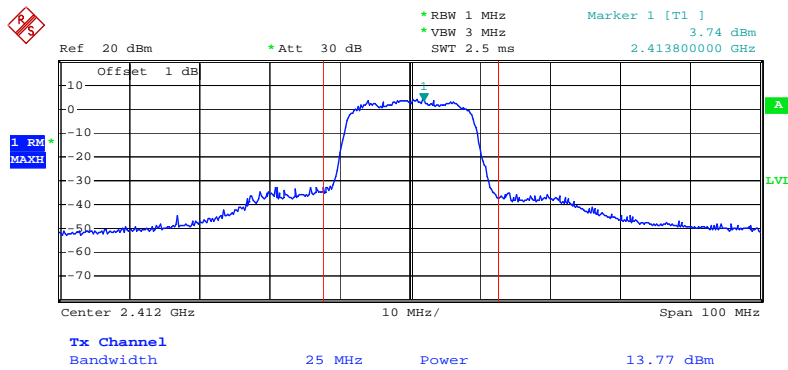

Date: 11.AUG.2009 14:41:39

### Conducted Output Power Plot on Configuration Draft n MCS8 20MHz Ant. B / 2437 MHz

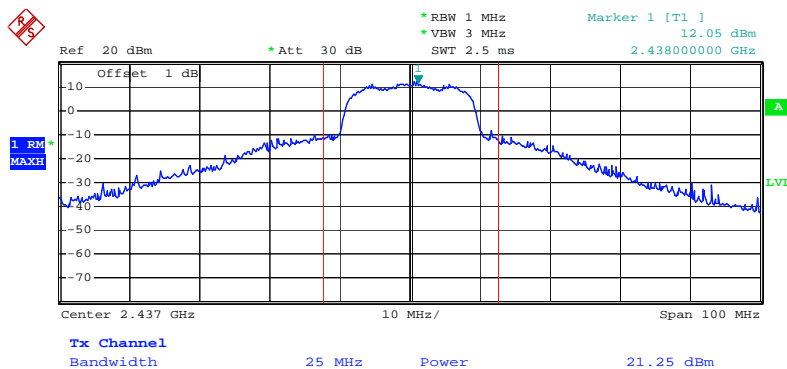

Date: 11.AUG.2009 14:40:18

### Conducted Output Power Plot on Configuration Draft n MCS8 20MHz Ant. B / 2462 MHz

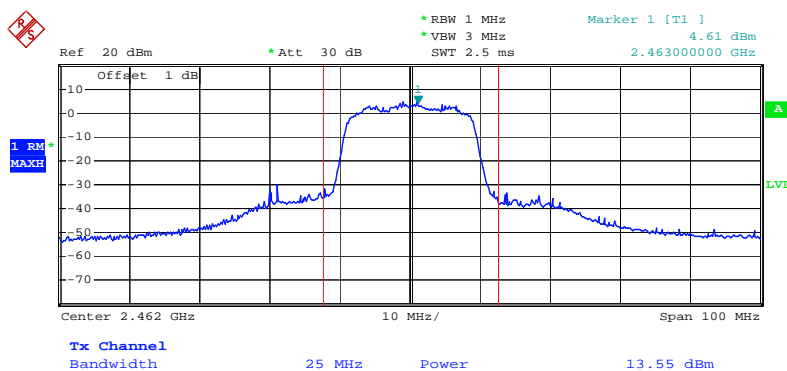

Date: 11.AUG.2009 14:44:28

### Conducted Output Power Plot on Configuration Draft n MCS8 40MHz Ant. A / 2422 MHz

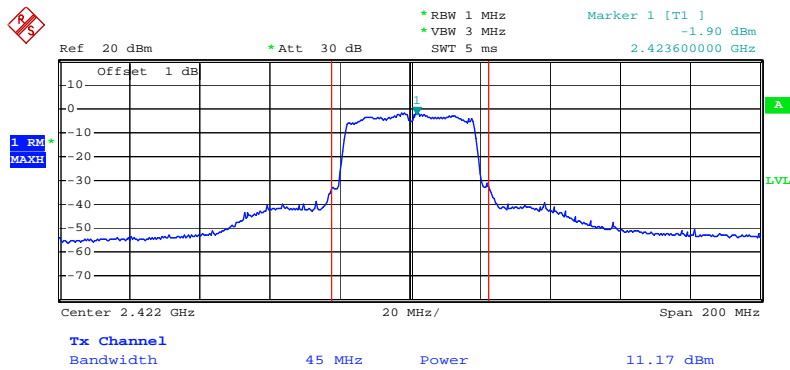

Date: 11.AUG.2009 14:47:27

### Conducted Output Power Plot on Configuration Draft n MCS8 40MHz Ant. A / 2437 MHz

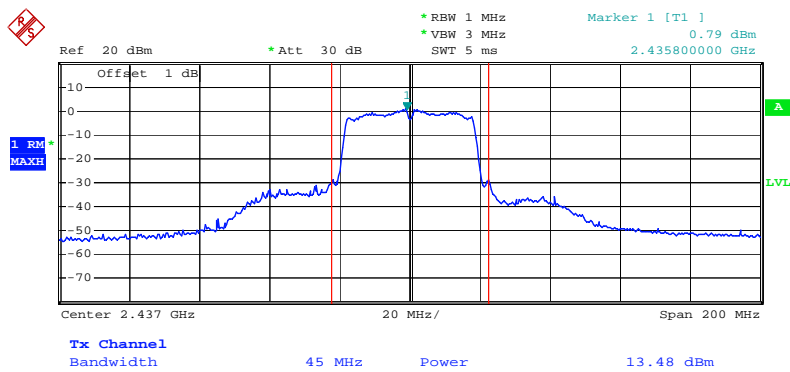

Date: 11.AUG.2009 14:48:53

### Conducted Output Power Plot on Configuration Draft n MCS8 40MHz Ant. A / 2452 MHz

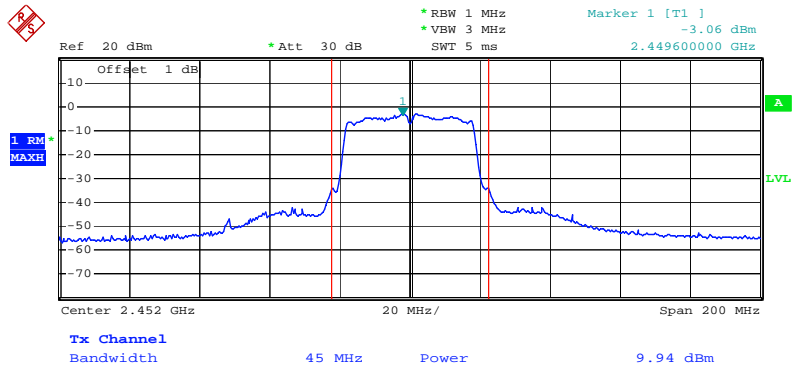

Date: 11.AUG.2009 14:51:25

### Conducted Output Power Plot on Configuration Draft n MCS8 40MHz Ant. B / 2422 MHz

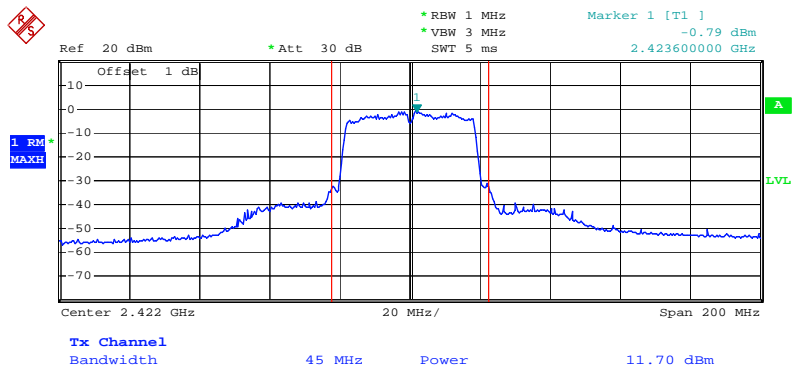

Date: 11.AUG.2009 14:46:49



### Conducted Output Power Plot on Configuration Draft n MCS8 40MHz Ant. B / 2437 MHz

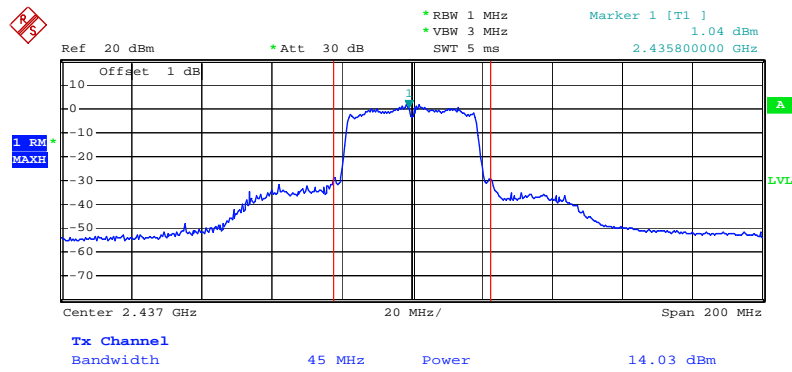

Date: 11.AUG.2009 14:49:29

### Conducted Output Power Plot on Configuration Draft n MCS8 40MHz Ant. B / 2452 MHz

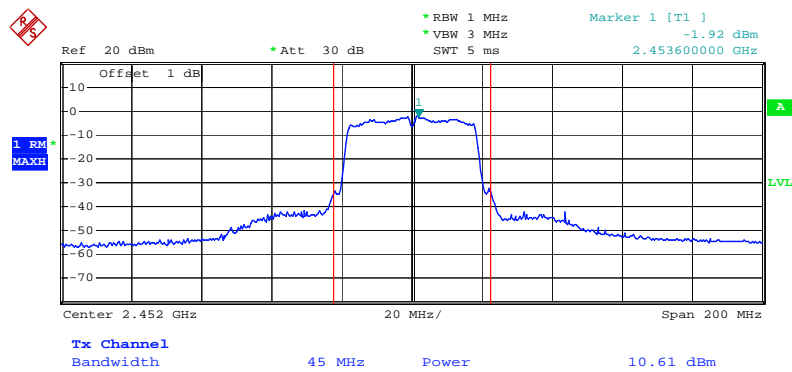

Date: 11.AUG.2009 14:50:48

**Conducted Output Power Plot on Configuration IEEE 802.11b Ant. A / 2412 MHz**

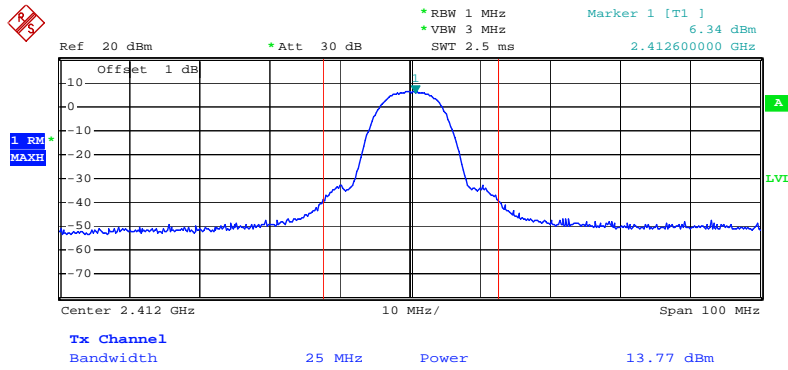

Date: 11.AUG.2009 14:58:18

**Conducted Output Power Plot on Configuration IEEE 802.11b Ant. A / 2437 MHz**

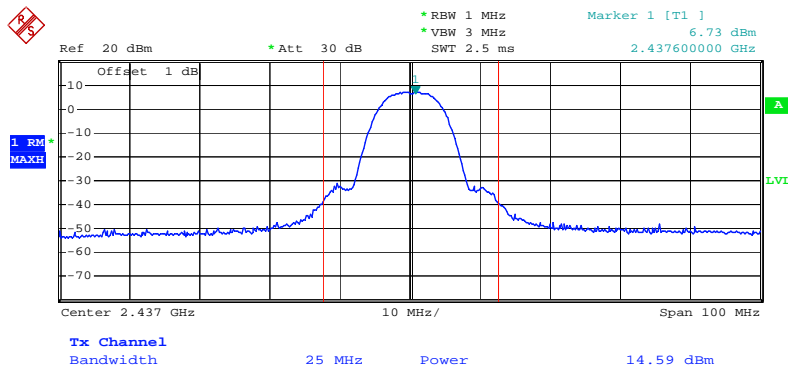

Date: 11.AUG.2009 14:57:19

### Conducted Output Power Plot on Configuration IEEE 802.11b Ant. A / 2462 MHz

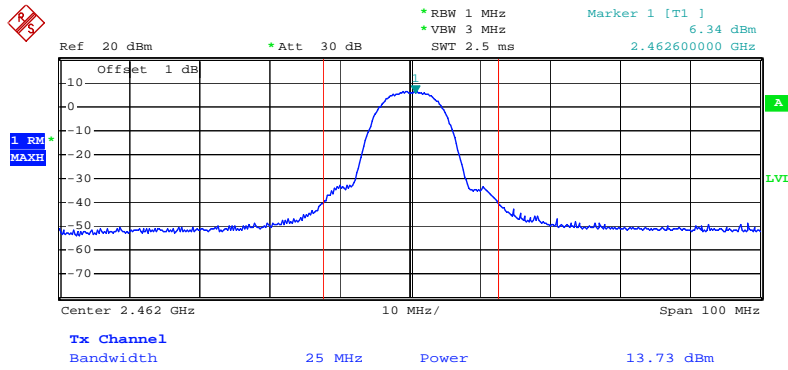

Date: 11.AUG.2009 14:59:21

### Conducted Output Power Plot on Configuration IEEE 802.11g Ant. A / 2412 MHz

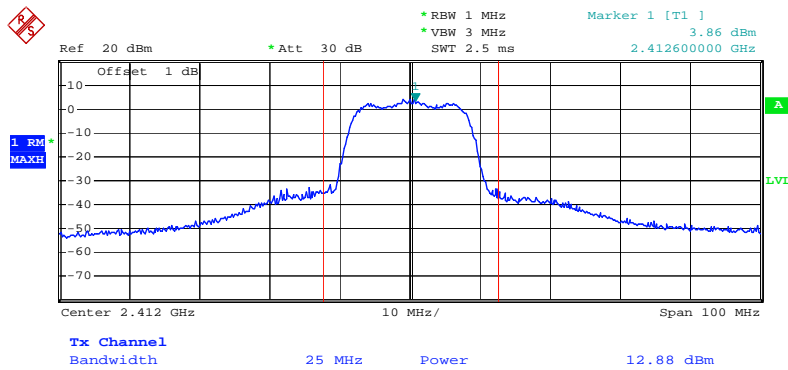

Date: 11.AUG.2009 14:53:18

Conducted Output Power Plot on Configuration IEEE 802.11g Ant. A / 2437 MHz

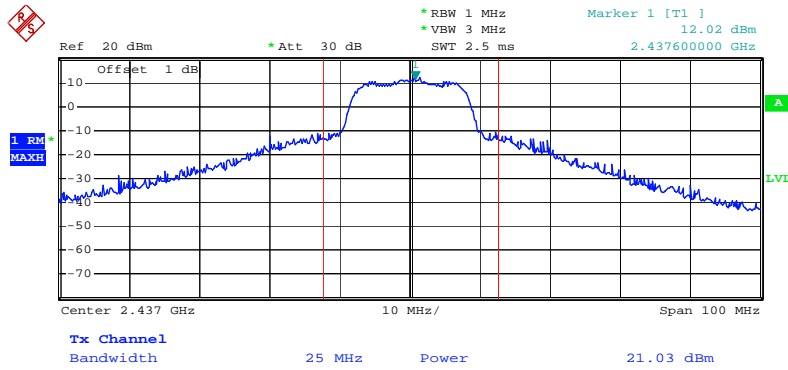

Date: 11.AUG.2009 14:54:48

Conducted Output Power Plot on Configuration IEEE 802.11g Ant. A / 2462 MHz

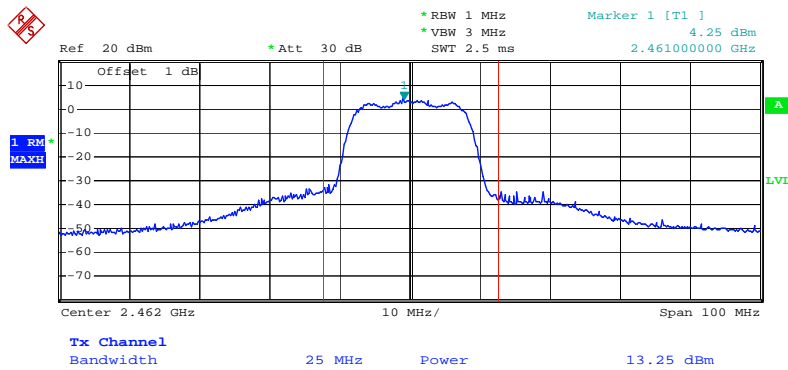

Date: 11.AUG.2009 14:55:56

### 4.3. Power Spectral Density Measurement

#### 4.3.1. Limit

For digitally modulated systems, the power spectral density conducted from the intentional radiator to the antenna shall not be greater than 8 dBm in any 3 kHz band during any time interval of continuous transmission.

#### 4.3.2. Measuring Instruments and Setting

Please refer to section 5 of equipments list in this report. The following table is the setting of Spectrum Analyzer.

Spectrum Parameter	Setting
Attenuation	Auto
Span Frequency	30 kHz
RB	3 kHz
VB	30 kHz
Detector	Peak
Trace	Max Hold
Sweep Time	10s

#### 4.3.3. Test Procedures

1. The transmitter output (antenna port) was connected to the spectrum analyzer.
2. Set RBW of spectrum analyzer to 3kHz and VBW to 30kHz. Set Detector to Peak, Trace to Max Hold.
3. Mark the frequency with maximum peak power as the center of the display of the spectrum.
4. Set the span to 30kHz and the sweep time to 10s and record the maximum peak value.
5. Measuring multiple antennas, the connector is required to link with spectrum analyzer through a combiner.

#### 4.3.4. Test Setup Layout

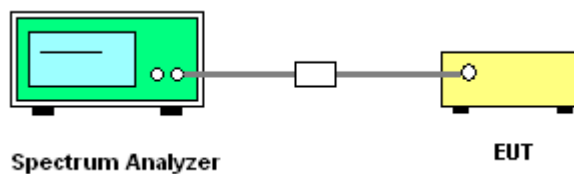

#### 4.3.5. Test Deviation

There is no deviation with the original standard.

#### 4.3.6. EUT Operation during Test

The EUT was programmed to be in continuously transmitting mode.

#### 4.3.7. Test Result of Power Spectral Density

<b>Temperature</b>	23°C	<b>Humidity</b>	58%
<b>Test Engineer</b>	Johnson Chang	<b>Configurations</b>	Draft n

##### Configuration Draft n MCS8 20MHz Ant. A + Ant. B

Channel	Frequency	Power Density (dBm/3kHz)	Max. Limit (dBm/3kHz)	Result
1	2412 MHz	-8.33	8.00	Complies
6	2437 MHz	-1.65	8.00	Complies
11	2462 MHz	-12.44	8.00	Complies

##### Configuration Draft n MCS8 40MHz Ant. A + Ant. B

Channel	Frequency	Power Density (dBm/3kHz)	Max. Limit (dBm/3kHz)	Result
3	2422 MHz	-13.27	8.00	Complies
6	2437 MHz	-10.57	8.00	Complies
9	2452 MHz	-14.31	8.00	Complies



<b>Temperature</b>	23°C	<b>Humidity</b>	58%
<b>Test Engineer</b>	Johnson Chang	<b>Configurations</b>	802.11b/g

**Configuration IEEE 802.11b Ant. A**

Channel	Frequency	Power Density (dBm/3kHz)	Max. Limit (dBm/3kHz)	Result
1	2412 MHz	-7.62	8.00	Complies
6	2437 MHz	-6.75	8.00	Complies
11	2462 MHz	-8.25	8.00	Complies

**Configuration IEEE 802.11g Ant. A**

Channel	Frequency	Power Density (dBm/3kHz)	Max. Limit (dBm/3kHz)	Result
1	2412 MHz	-11.98	8.00	Complies
6	2437 MHz	-3.90	8.00	Complies
11	2462 MHz	-12.43	8.00	Complies

Power Density Plot on Configuration Drafft n MCS8 20MHz Ant. A + Ant. B / 2412 MHz

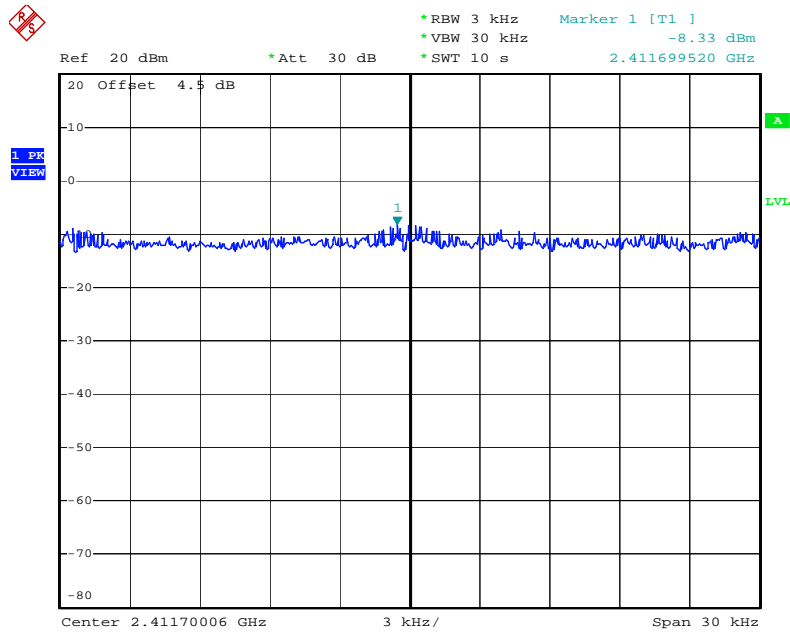

Date: 11.AUG.2009 15:29:40

Power Density Plot on Configuration Drafft n MCS8 20MHz Ant. A + Ant. B / 2437 MHz

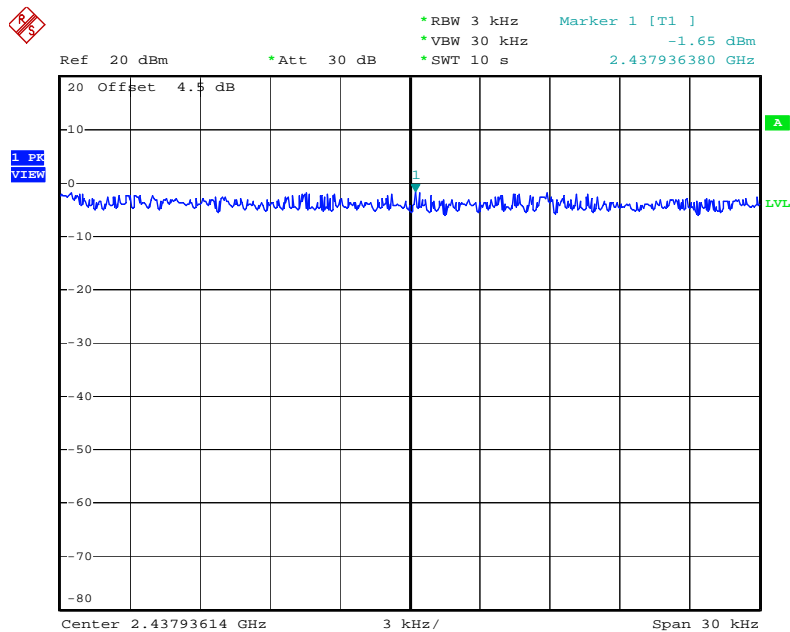

Date: 11.AUG.2009 15:32:23

**Power Density Plot on Configuration Drafft n MCS8 20MHz Ant. A + Ant. B / 2462 MHz**

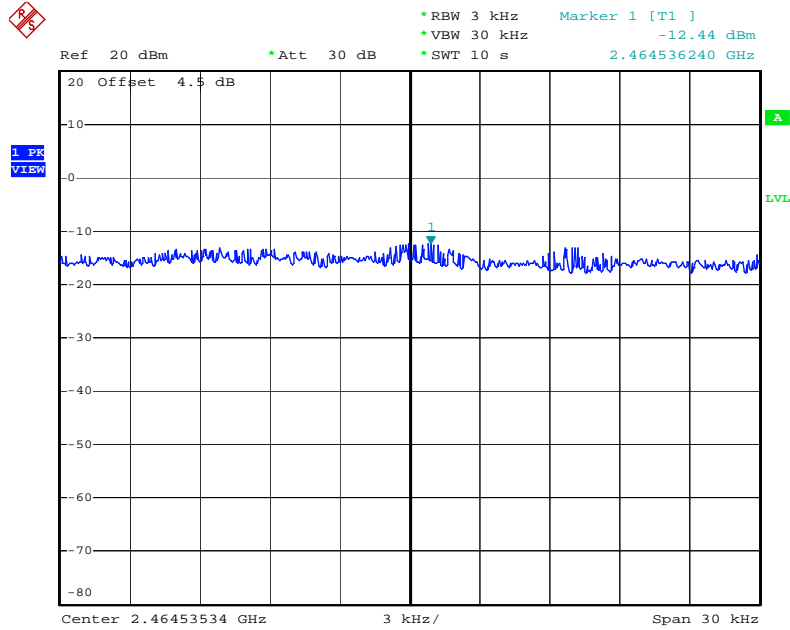

Date: 11.AUG.2009 15:34:56

**Power Density Plot on Configuration Drafft n MCS8 40MHz Ant. A + Ant. B / 2422 MHz**

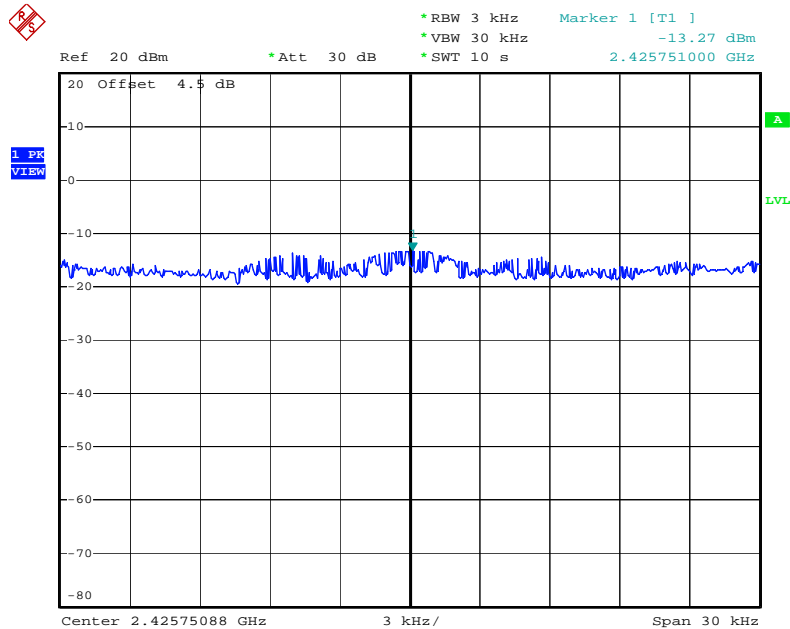

Date: 11.AUG.2009 15:42:57

**Power Density Plot on Configuration Drafft n MCS8 40MHz Ant. A + Ant. B / 2437 MHz**

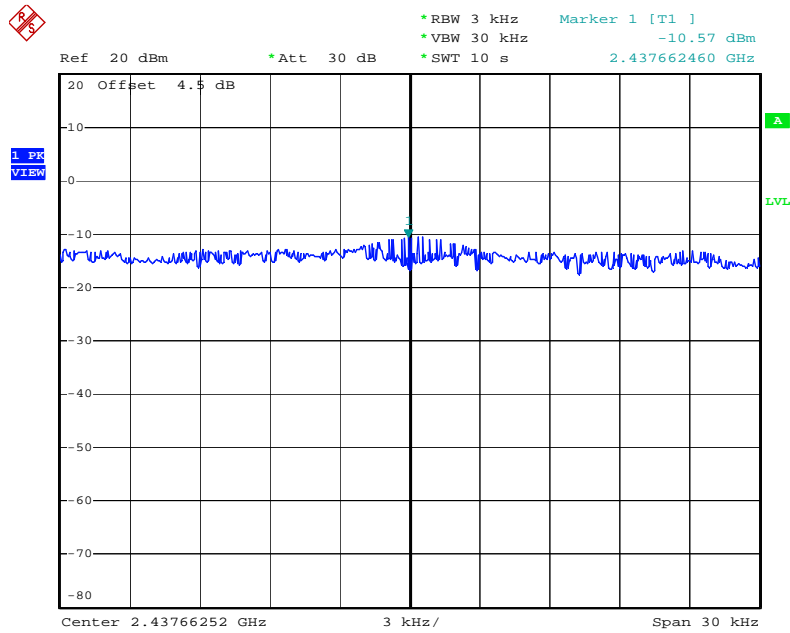

Date: 11.AUG.2009 15:45:43

**Power Density Plot on Configuration Drafft n MCS8 40MHz Ant. A + Ant. B / 2452 MHz**

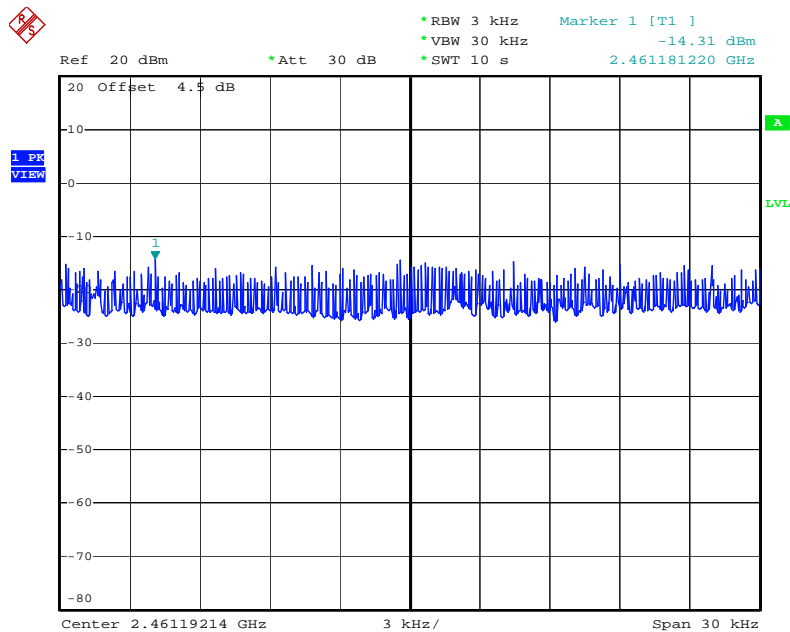

Date: 11.AUG.2009 15:38:54

### Power Density Plot on Configuration IEEE 802.11b Ant. A / 2412 MHz

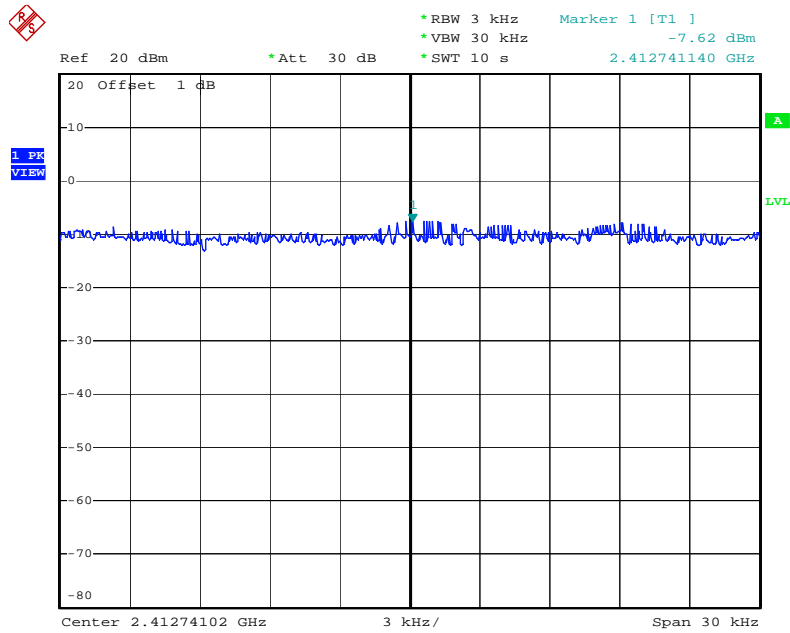

Date: 11.AUG.2009 15:05:50

### Power Density Plot on Configuration IEEE 802.11b Ant. A / 2437 MHz

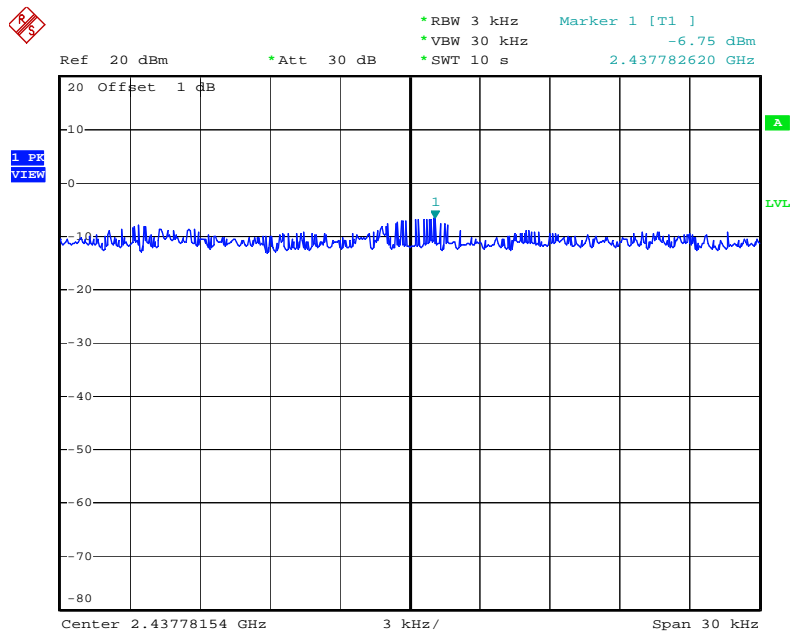

Date: 11.AUG.2009 15:08:19

**Power Density Plot on Configuration IEEE 802.11b Ant. A / 2462 MHz**

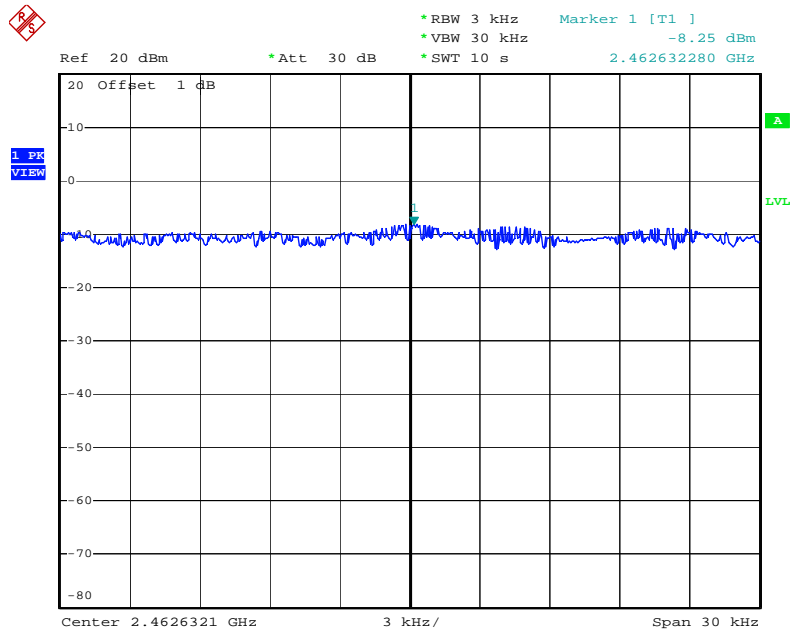

Date: 11.AUG.2009 15:11:32

**Power Density Plot on Configuration IEEE 802.11g Ant. A / 2412 MHz**

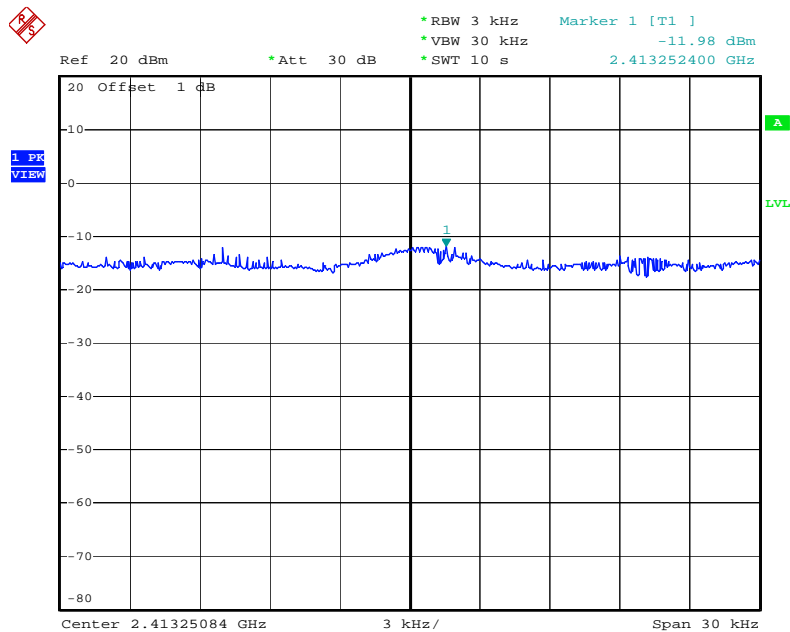

Date: 11.AUG.2009 15:22:48



Power Density Plot on Configuration IEEE 802.11g Ant. A / 2437 MHz

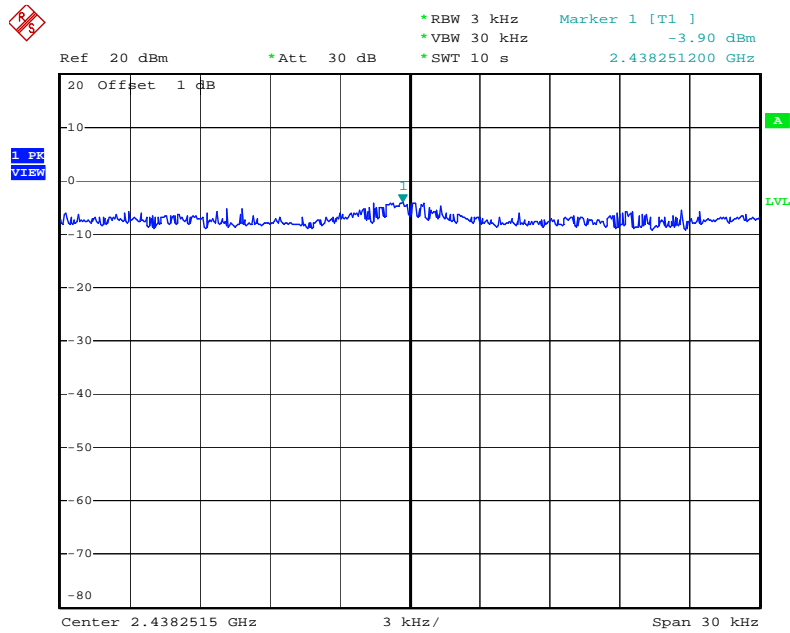

Date: 11.AUG.2009 15:19:08

Power Density Plot on Configuration IEEE 802.11g Ant. A / 2462 MHz

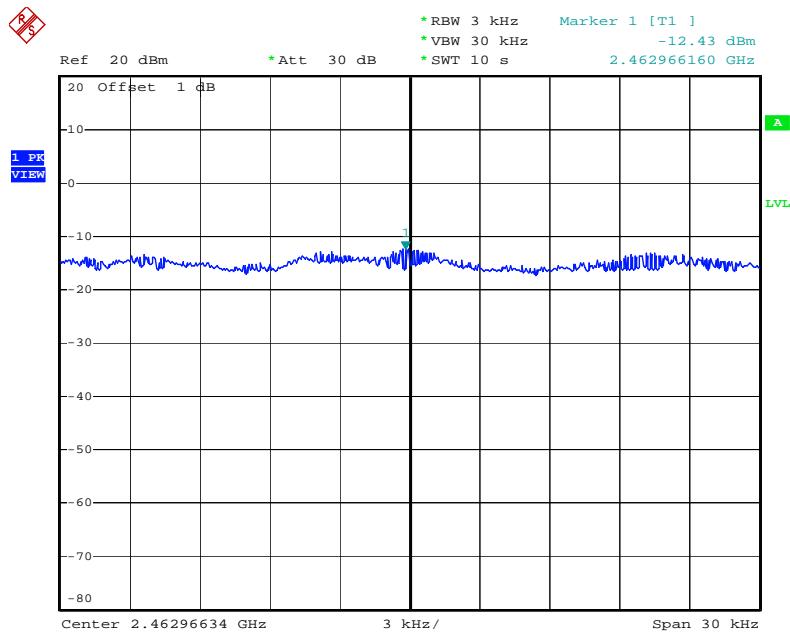

Date: 11.AUG.2009 15:14:12

## 4.4. 6dB Spectrum Bandwidth Measurement

### 4.4.1. Limit

For digital modulation systems, the minimum 6 dB bandwidth shall be at least 500 kHz.

### 4.4.2. Measuring Instruments and Setting

Please refer to section 5 of equipments list in this report. The following table is the setting of the Spectrum Analyzer.

Spectrum Parameters	Setting
Attenuation	Auto
Span Frequency	> 6dB Bandwidth
RB	100 kHz
VB	100 kHz
Detector	Peak
Trace	Max Hold
Sweep Time	Auto

### 4.4.3. Test Procedures

1. The transmitter output (antenna port) was connected to the spectrum analyzer in peak hold mode.
2. The resolution bandwidth of 100 kHz and the video bandwidth of 100 kHz were used.
3. Measured the spectrum width with power higher than 6dB below carrier.
4. Measuring multiple antennas, the connector is required to link with spectrum analyzer through a combiner.

### 4.4.4. Test Setup Layout

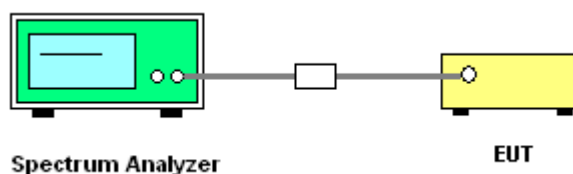

### 4.4.5. Test Deviation

There is no deviation with the original standard.

### 4.4.6. EUT Operation during Test

The EUT was programmed to be in continuously transmitting mode.

## 4.4.7. Test Result of 6dB Spectrum Bandwidth

<b>Temperature</b>	23°C	<b>Humidity</b>	58%
<b>Test Engineer</b>	Johnson Chang	<b>Configurations</b>	Draft n

## Configuration Draft n MCS8 20MHz Ant. A + Ant. B

Channel	Frequency	6dB Bandwidth (MHz)	99% Occupied Bandwidth (MHz)	Min. Limit (kHz)	Test Result
1	2412 MHz	13.92	17.56	500	Complies
6	2437 MHz	15.04	17.56	500	Complies
11	2462 MHz	14.44	17.56	500	Complies

## Configuration Draft n MCS8 40MHz Ant. A + Ant. B

Channel	Frequency	6dB Bandwidth (MHz)	99% Occupied Bandwidth (MHz)	Min. Limit (kHz)	Test Result
3	2422 MHz	33.04	36.32	500	Complies
6	2437 MHz	32.96	36.08	500	Complies
9	2452 MHz	32.64	36.08	500	Complies

<b>Temperature</b>	23°C	<b>Humidity</b>	58%
<b>Test Engineer</b>	Johnson Chang	<b>Configurations</b>	802.11b/g

**Configuration IEEE 802.11b Ant. A**

Channel	Frequency	6dB Bandwidth (MHz)	99% Occupied Bandwidth (MHz)	Min. Limit (kHz)	Test Result
1	2412 MHz	8.04	10.08	500	Complies
6	2437 MHz	8.08	10.08	500	Complies
11	2462 MHz	8.00	10.08	500	Complies

**Configuration IEEE 802.11g Ant. A**

Channel	Frequency	6dB Bandwidth (MHz)	99% Occupied Bandwidth (MHz)	Min. Limit (kHz)	Test Result
1	2412 MHz	14.96	16.36	500	Complies
6	2437 MHz	14.08	16.36	500	Complies
11	2462 MHz	15.16	16.36	500	Complies

6 dB Bandwidth Plot on Configuration Draft n MCS8 20MHz Ant. A + Ant. B / 2412 MHz

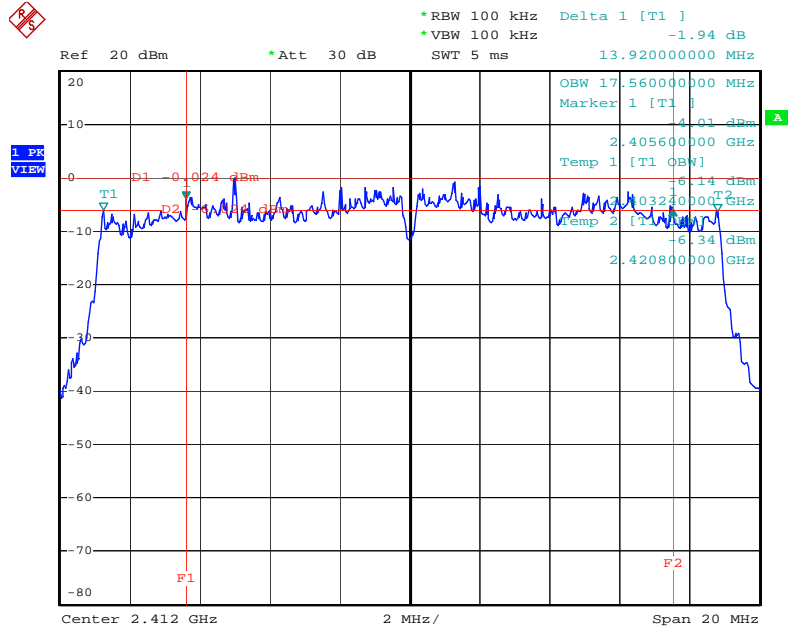

Date: 11.AUG.2009 15:28:13

6 dB Bandwidth Plot on Configuration Draft n MCS8 20MHz Ant. A + Ant. B / 2437 MHz

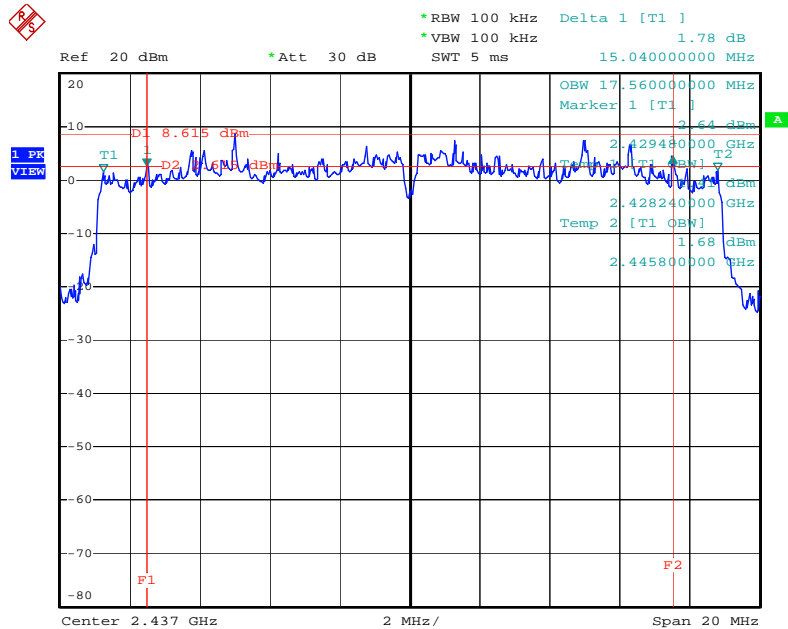

Date: 11.AUG.2009 15:30:55

6 dB Bandwidth Plot on Configuration Draft n MCS8 20MHz Ant. A + Ant. B / 2462 MHz

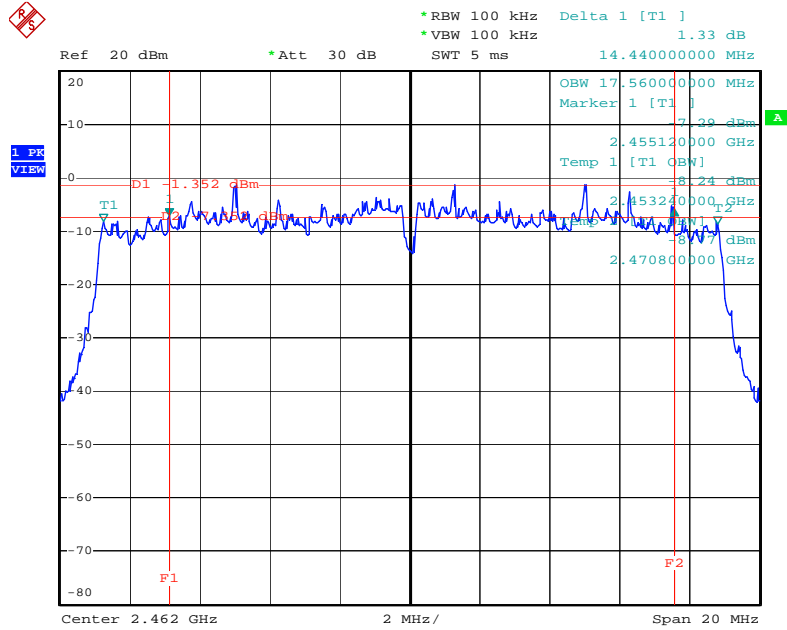

Date: 11.AUG.2009 15:33:29

6 dB Bandwidth Plot on Configuration Draft n MCS8 40MHz Ant. A + Ant. B / 2422 MHz

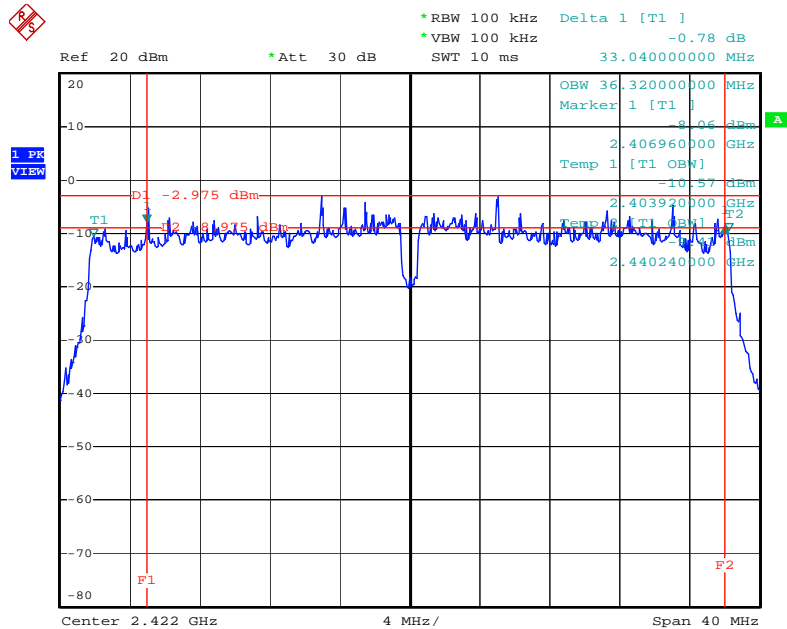

Date: 11.AUG.2009 15:41:30



6 dB Bandwidth Plot on Configuration Draft n MCS8 40MHz Ant. A + Ant. B / 2437 MHz

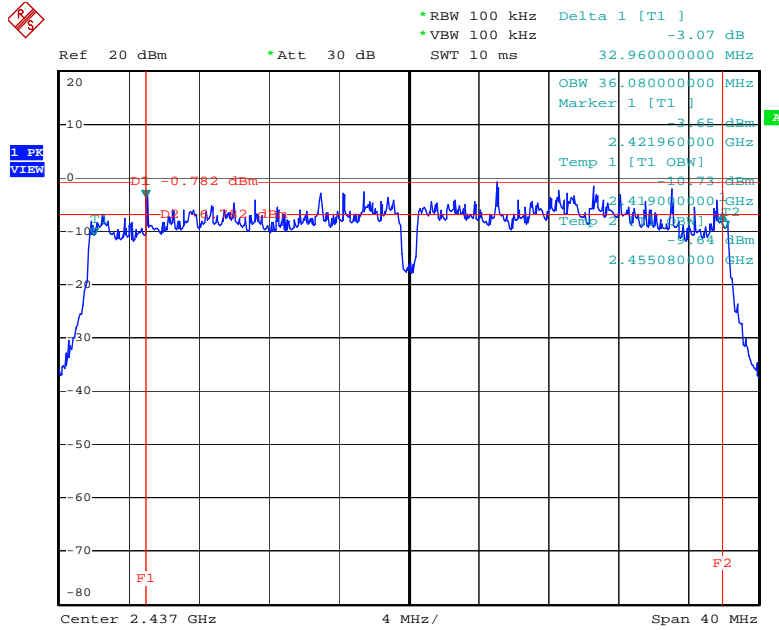

Date: 11.AUG.2009 15:44:15

6 dB Bandwidth Plot on Configuration Draft n MCS8 40MHz Ant. A + Ant. B / 2452 MHz

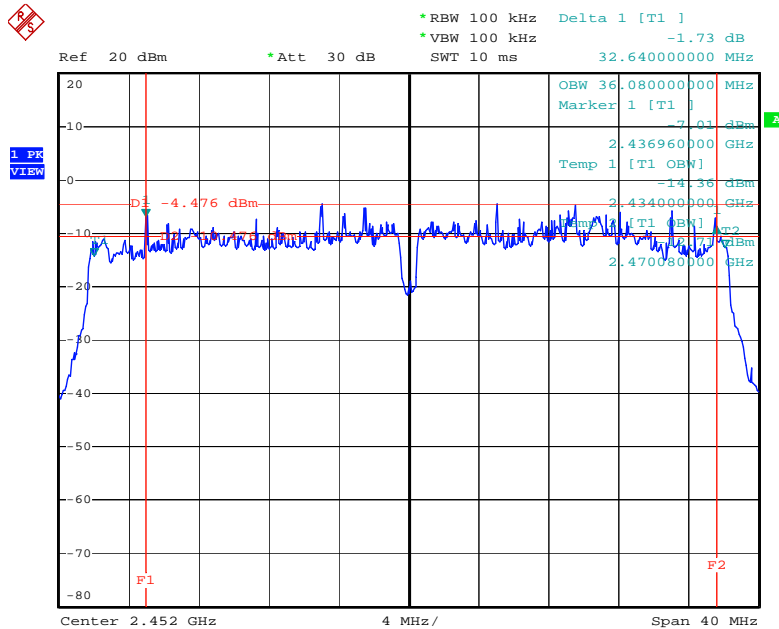

Date: 11.AUG.2009 15:37:27

6 dB Bandwidth Plot on Configuration IEEE 802.11b Ant. A / 2412 MHz

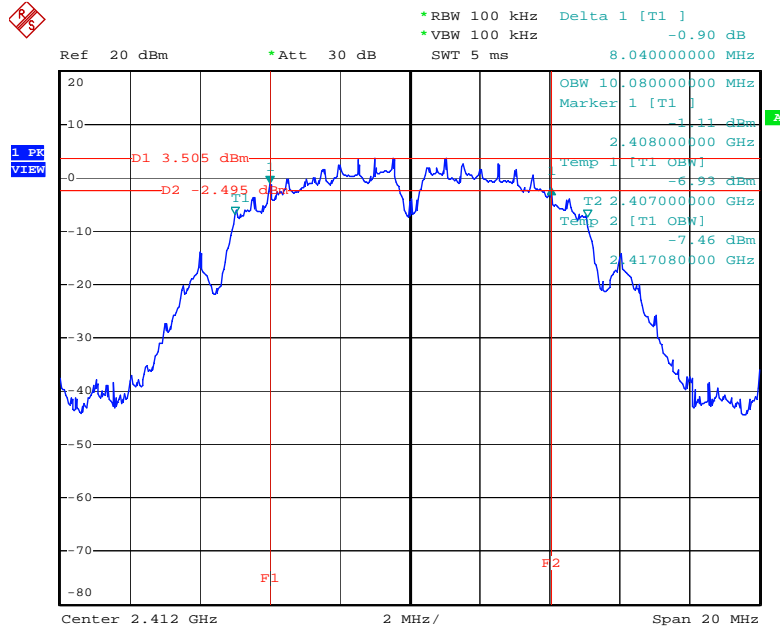

Date: 11.AUG.2009 15:04:22

6 dB Bandwidth Plot on Configuration IEEE 802.11b Ant. A / 2437 MHz

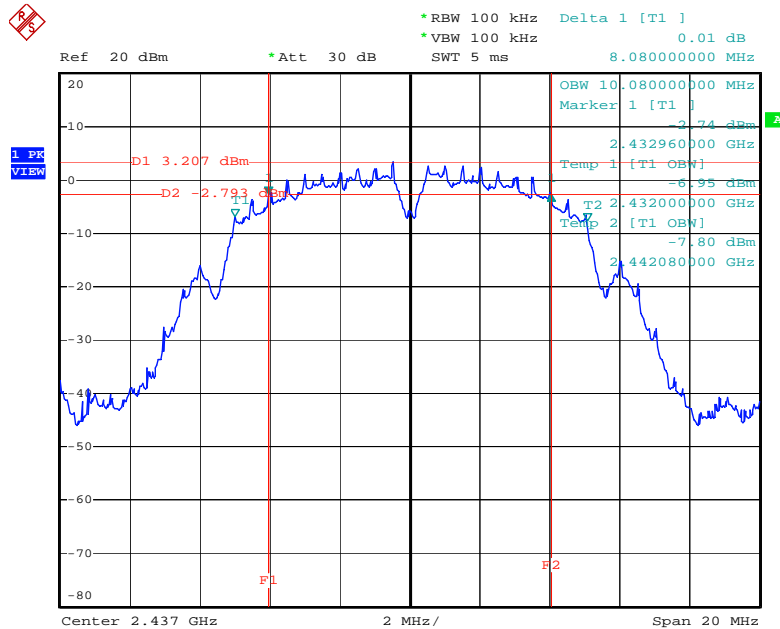

Date: 11.AUG.2009 15:06:51

6 dB Bandwidth Plot on Configuration IEEE 802.11b Ant. A / 2462 MHz

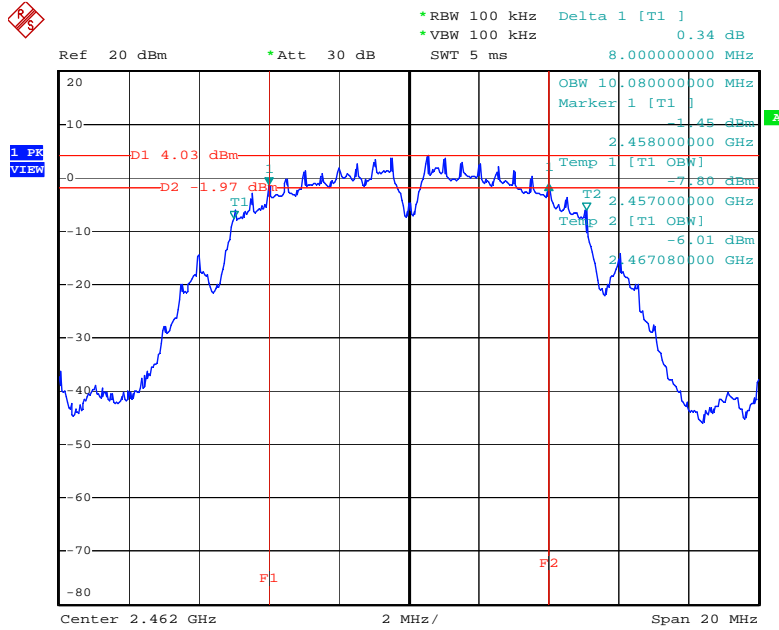

Date: 11.AUG.2009 15:10:05

6 dB Bandwidth Plot on Configuration IEEE 802.11g Ant. A / 2412 MHz

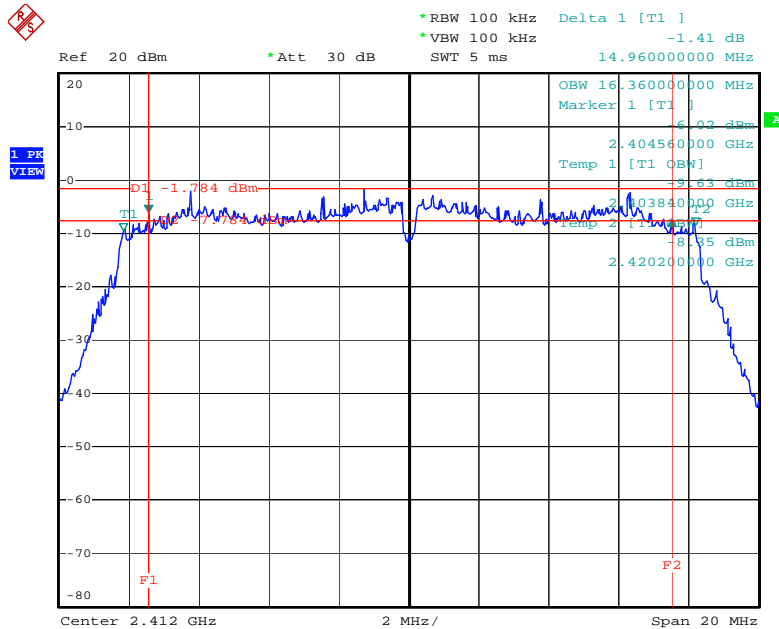

Date: 11.AUG.2009 15:55:47

### 6 dB Bandwidth Plot on Configuration IEEE 802.11g Ant. A / 2437 MHz

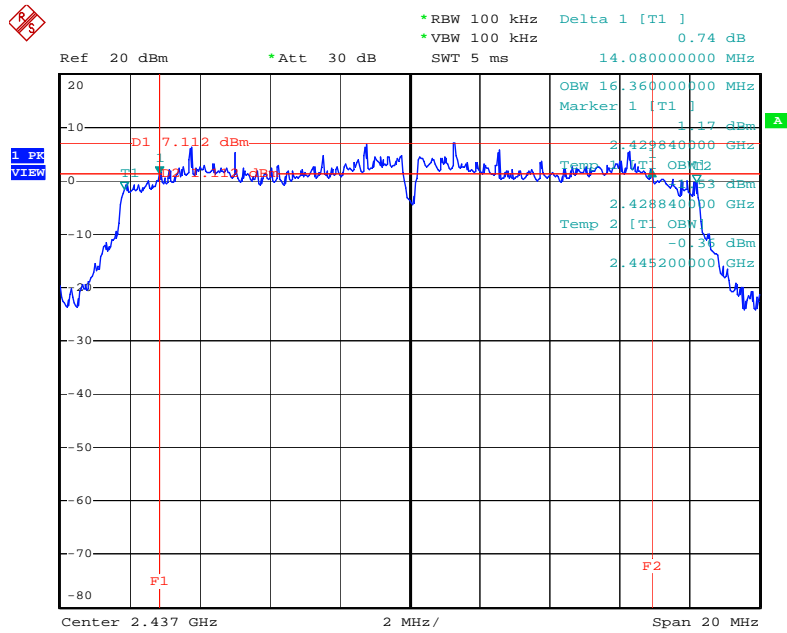

Date: 11.AUG.2009 15:17:40

### 6 dB Bandwidth Plot on Configuration IEEE 802.11g Ant. A / 2462 MHz

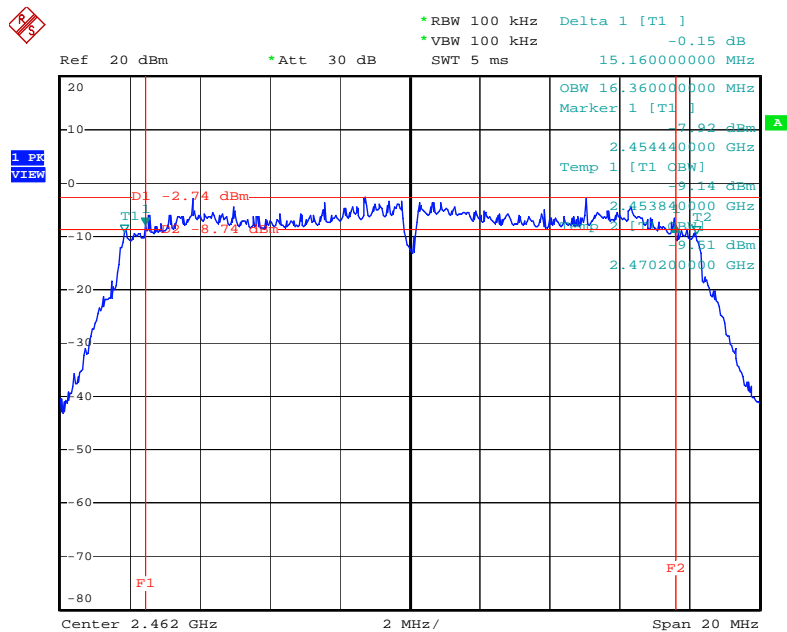

Date: 11.AUG.2009 15:12:44

## 4.5. Radiated Emissions Measurement

### 4.5.1. Limit

20dBc in any 100 kHz bandwidth outside the operating frequency band. In case the emission fall within the restricted band specified on 15.205(a), then the 15.209(a) limit in the table below has to be followed.

Frequencies (MHz)	Field Strength (micorvolts/meter)	Measurement Distance (meters)
0.009~0.490	2400/F(KHz)	300
0.490~1.705	24000/F(KHz)	30
1.705~30.0	30	30
30~88	100	3
88~216	150	3
216~960	200	3
Above 960	500	3

### 4.5.2. Measuring Instruments and Setting

Please refer to section 5 of equipments list in this report. The following table is the setting of spectrum analyzer and receiver.

Spectrum Parameter	Setting
Attenuation	Auto
Start Frequency	1000 MHz
Stop Frequency	10th carrier harmonic
RB / VB (Emission in restricted band)	1MHz / 1MHz for Peak, 1 MHz / 10Hz for Average
RB / VB (Emission in non-restricted band)	1MHz / 1MHz for peak

Receiver Parameter	Setting
Attenuation	Auto
Start ~ Stop Frequency	9kHz~150kHz / RB 200Hz for QP
Start ~ Stop Frequency	150kHz~30MHz / RB 9kHz for QP
Start ~ Stop Frequency	30MHz~1000MHz / RB 120kHz for QP

#### 4.5.3. Test Procedures

1. Configure the EUT according to ANSI C63.4. The EUT was placed on the top of the turntable 0.8 meter above ground. The phase center of the receiving antenna mounted on the top of a height-variable antenna tower was placed 3 meters far away from the turntable.
2. Power on the EUT and all the supporting units. The turntable was rotated by 360 degrees to determine the position of the highest radiation.
3. The height of the broadband receiving antenna was varied between one meter and four meters above ground to find the maximum emissions field strength of both horizontal and vertical polarization.
4. For each suspected emissions, the antenna tower was scan (from 1 m to 4 m) and then the turntable was rotated (from 0 degree to 360 degrees) to find the maximum reading.
5. Set the test-receiver system to Peak or CISPR quasi-peak Detect Function with specified bandwidth under Maximum Hold Mode.
6. For emissions above 1GHz, use 1MHz VBW and RBW for peak reading. Then 1MHz RBW and 10Hz VBW for average reading in spectrum analyzer.
7. When the radiated emissions limits are expressed in terms of the average value of the emissions, and pulsed operation is employed, the measurement field strength shall be determined by averaging over one complete pulse train, including blanking intervals, as long as the pulse train does not exceed 0.1 seconds. As an alternative (provided the transmitter operates for longer than 0.1 seconds) or in cases where the pulse train exceeds 0.1 seconds, the measured field strength shall be determined from the average absolute voltage during a 0.1 second interval during which the field strength is at its maximum value.
8. If the emissions level of the EUT in peak mode was 3 dB lower than the average limit specified, then testing will be stopped and peak values of EUT will be reported, otherwise, the emissions which do not have 3 dB margin will be repeated one by one using the quasi-peak method for below 1GHz.
9. For testing above 1GHz, the emissions level of the EUT in peak mode was lower than average limit (that means the emissions level in peak mode also complies with the limit in average mode), then testing will be stopped and peak values of EUT will be reported, otherwise, the emissions will be measured in average mode again and reported.
10. In case the emission is lower than 30MHz, loop antenna has to be used for measurement and the recorded data should be QP measured by receiver. High – Low scan is not required in this case.

#### 4.5.4. Test Setup Layout

For radiated emissions below 30MHz

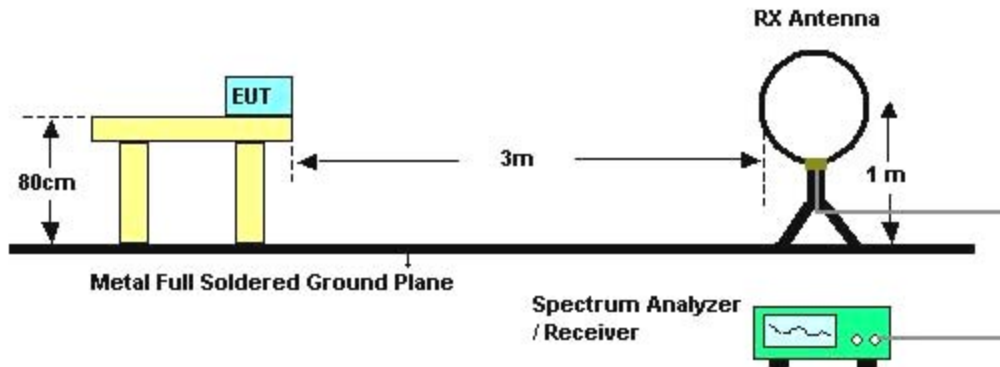

For radiated emissions above 30MHz

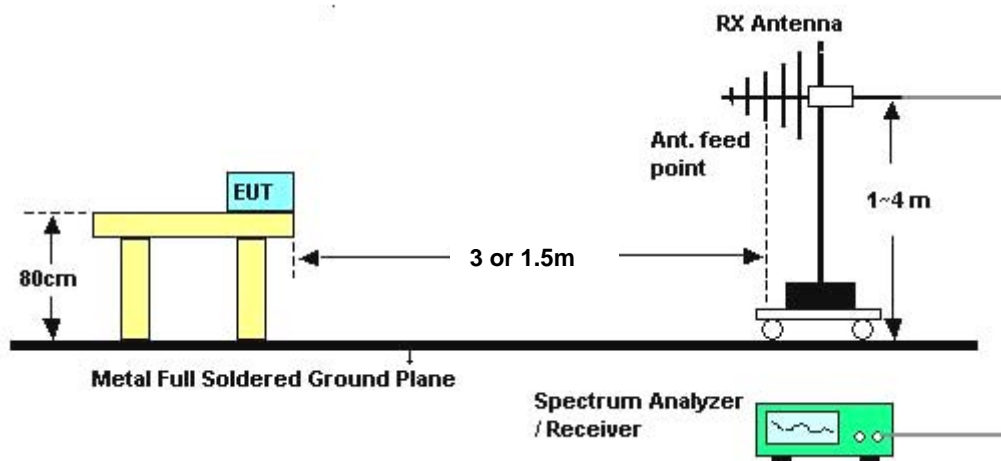

Above 10 GHz shall be extrapolated to the specified distance using an extrapolation factor of 20 dB/decade from 3m to 1.5m.

Distance extrapolation factor =  $20 \log (\text{specific distance [3m]} / \text{test distance [1.5m]})$  (dB);

Limit line = specific limits (dBuV) + distance extrapolation factor [6 dB].

#### 4.5.5. Test Deviation

There is no deviation with the original standard.

#### 4.5.6. EUT Operation during Test

The EUT was programmed to be in continuously transmitting mode.

#### 4.5.7. Results of Radiated Emissions (9kHz~30MHz)

<b>Temperature</b>	24°C	<b>Humidity</b>	56%
<b>Test Engineer</b>	Beck Wu	<b>Configurations</b>	Normal Link

<b>Freq. (MHz)</b>	<b>Level (dBuV)</b>	<b>Over Limit (dB)</b>	<b>Limit Line (dBuV)</b>	<b>Remark</b>
-	-	-	-	See Note

**Note:**

The amplitude of spurious emissions which are attenuated by more than 20 dB below the permissible value has no need to be reported.

Distance extrapolation factor =  $40 \log(\text{specific distance} / \text{test distance})$  (dB);

Limit line = specific limits (dBuV) + distance extrapolation factor.



4.5.8. Results of Radiated Emissions (30MHz~1GHz)

Temperature	24°C	Humidity	56%
Test Engineer	Beck Wu	Configurations	Normal Link

Horizontal

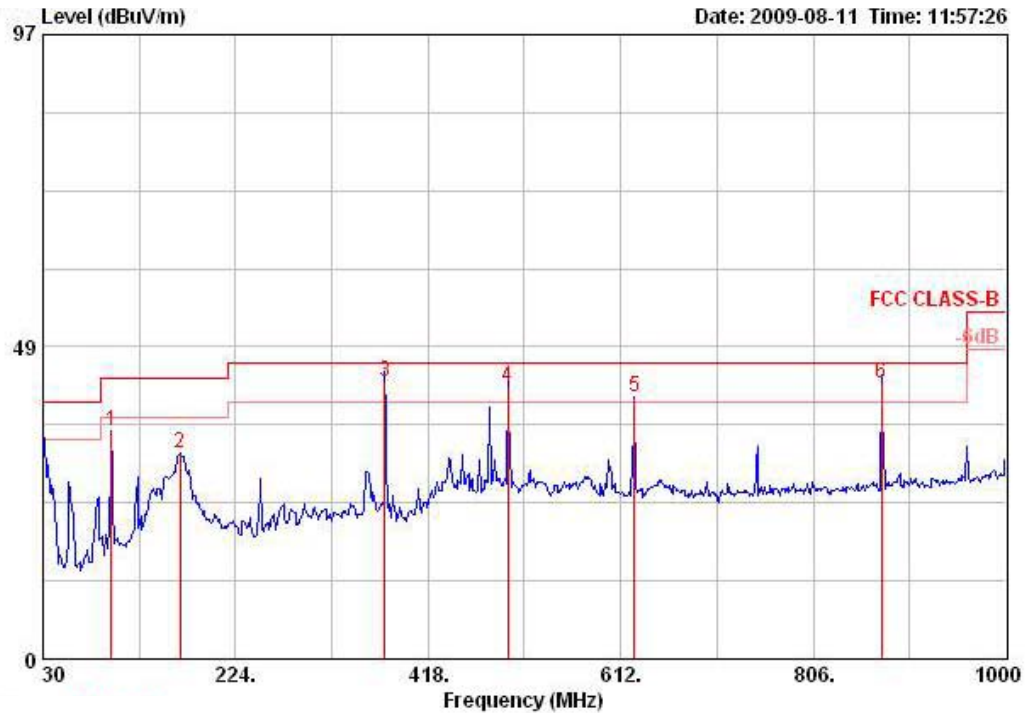

	Freq	Level	Over Limit	Limit Line	Read Level	Antenna Factor	Cable Loss	Preamp Factor	Remark	Ant Pos	Table Pos	Pol/Phase
	MHz	dBuV/m	dB	dBuV/m	dBuV	dB/m	dB	dB		cm	deg	
1	98.870	35.41	-8.09	43.50	51.05	10.79	1.18	27.61	Peak	100	0	HORIZONTAL
2	167.740	32.11	-11.39	43.50	45.22	12.61	1.54	27.26	Peak	100	0	HORIZONTAL
3 @	374.350	42.99	-3.01	46.00	52.78	15.38	2.25	27.42	QP	100	169	HORIZONTAL
4 !	498.510	42.42	-3.58	46.00	50.21	17.60	2.70	28.09	QP	100	200	HORIZONTAL
5 !	625.580	40.73	-5.27	46.00	46.90	18.85	3.05	28.07	Peak	100	0	HORIZONTAL
6 !	874.870	42.75	-3.25	46.00	46.36	20.34	3.50	27.45	QP	100	210	HORIZONTAL

**Vertical**

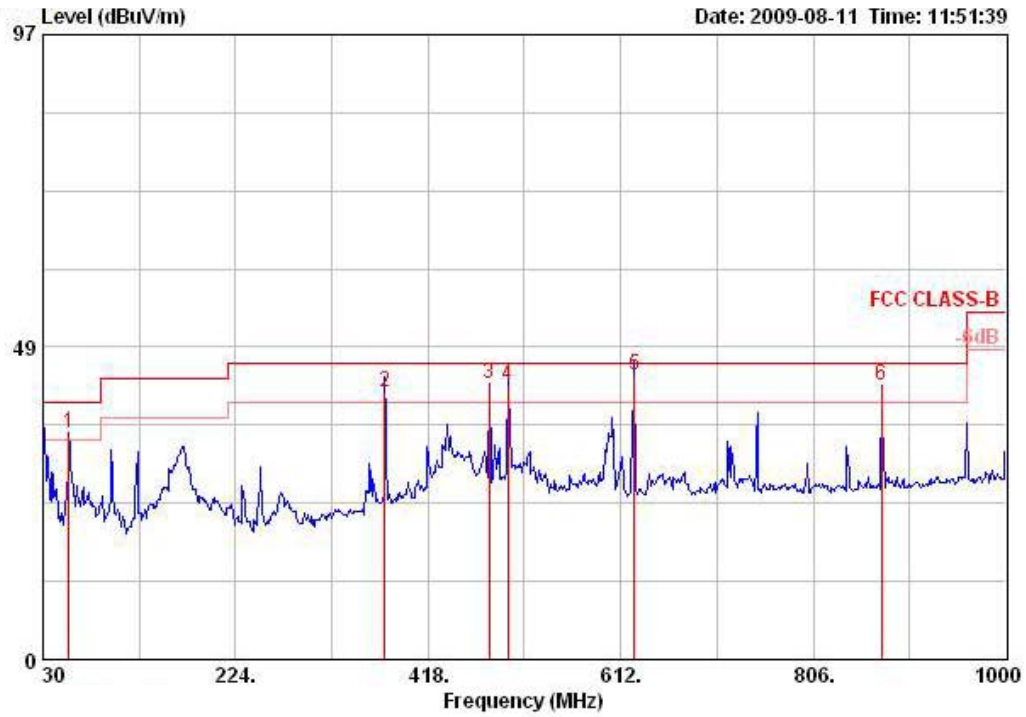

	Freq	Level	Over Limit	Limit Line	Read Level	Antenna Factor	Cable Loss	Preamp Factor	Remark	Ant Pos	Table Pos	Pol/Phase
	MHz	dBuV/m	dB	dBuV/m	dBuV	dB/m	dB	dB		cm	deg	
1 !	56.190	35.27	-4.73	40.00	54.78	7.47	0.80	27.78	Peak	400	0	VERTICAL
2 !	374.350	41.47	-4.53	46.00	51.26	15.38	2.25	27.42	QP	100	182	VERTICAL
3 !	479.110	42.70	-3.30	46.00	50.74	17.30	2.66	27.99	Peak	400	0	VERTICAL
4 !	498.510	42.44	-3.56	46.00	50.23	17.60	2.70	28.09	QP	100	120	VERTICAL
5 @	625.580	44.09	-1.91	46.00	50.26	18.85	3.05	28.07	QP	100	178	VERTICAL
6 !	874.870	42.49	-3.51	46.00	46.10	20.34	3.50	27.45	Peak	400	0	VERTICAL

**Note:**

The amplitude of spurious emissions which are attenuated by more than 20 dB below the permissible value has no need to be reported.

Emission level (dBUV/m) = 20 log Emission level (uV/m).

Corrected Reading: Antenna Factor + Cable Loss + Read Level - Preamp Factor = Level.

4.5.9. Results for Radiated Emissions (1GHz~10<sup>th</sup> Harmonic)

Temperature	24°C	Humidity	56%
Test Engineer	Beck Wu	Configurations	Draft n MCS8 20MHz Ch 1 / Ant. A + Ant. B

Horizontal

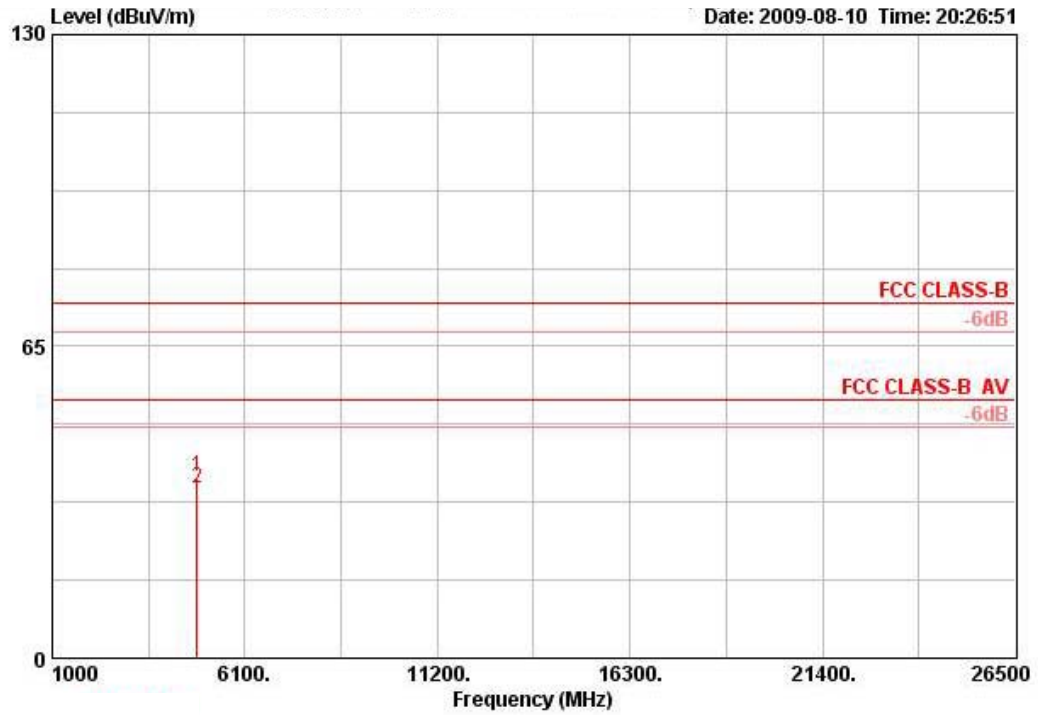

	Freq	Level	Limit	Over	Read	Cable	Preamp	Antenna	Table	Ant	Remark	Pol/Phase
	MHz	dBuV/m	dBuV/m	dB	dBuV	dB	dB	dB/m	deg	cm		
1	4823.010	37.96	74.00	-36.04	35.98	3.96	35.04	33.06	132	150	PEAK	HORIZONTAL
2	4823.080	35.51	54.00	-18.49	33.53	3.96	35.04	33.06	132	150	AVERAGE	HORIZONTAL

**Vertical**

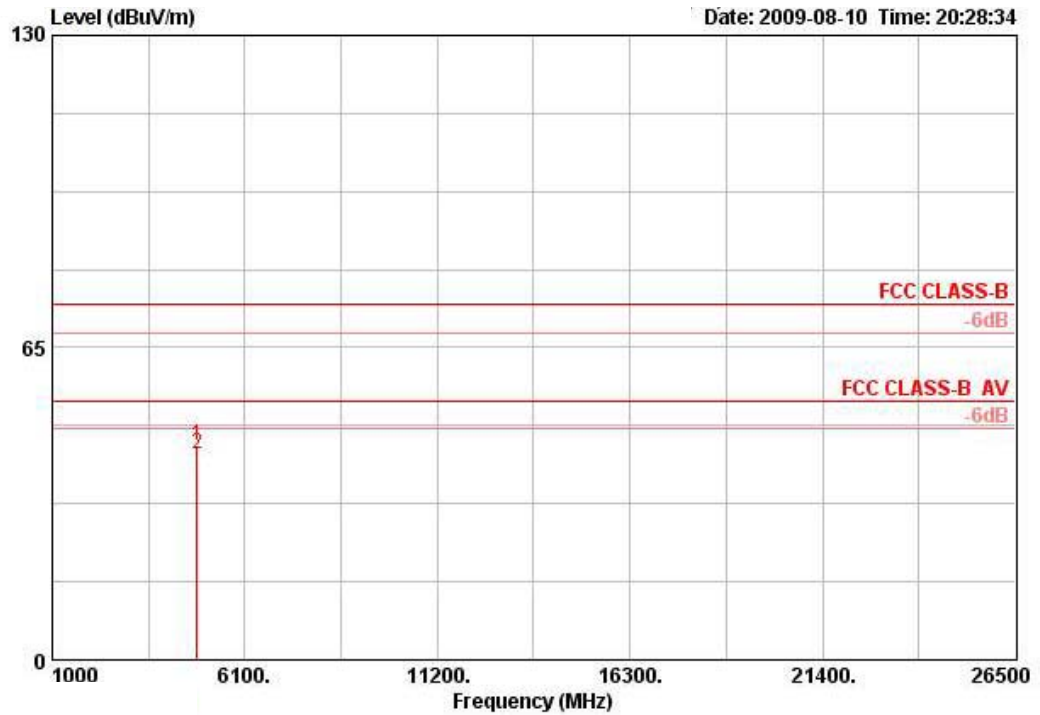

	Freq	Level	Limit	Over	Read	Cable	Preamp	Antenna	Table	Ant	Remark	Pol/Phase
	MHz	dBuV/m	dBuV/m	dB	dBuV	dB	dB	dB/m	deg	cm		
1	4824.470	44.54	74.00	-29.46	42.56	3.96	35.04	33.06	281	119	PEAK	VERTICAL
2	4824.730	42.95	54.00	-11.05	40.97	3.96	35.04	33.06	281	119	AVERAGE	VERTICAL

<b>Temperature</b>	24°C	<b>Humidity</b>	56%
<b>Test Engineer</b>	Beck Wu	<b>Configurations</b>	Draft n MCS8 20MHz Ch 6 / Ant. A + Ant. B

**Horizontal**

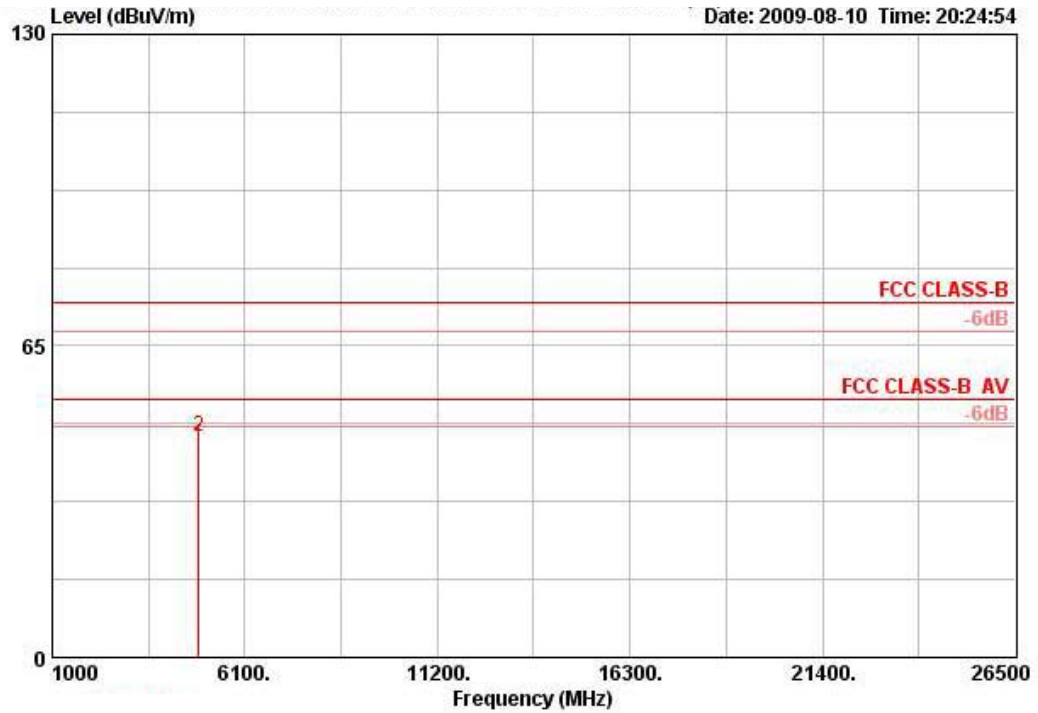

	Freq	Level	Limit	Over	Read	Cable	Preamp	Antenna	Table	Ant	Remark	Pol/Phase
	MHz	dBuV/m	dBuV/m	dB	dBuV	dB	dB	dB/m	deg	cm		
1	4874.120	44.28	54.00	-9.72	42.19	3.97	35.03	33.16	132	150	AVERAGE	HORIZONTAL
2	4874.940	45.97	74.00	-28.03	43.87	3.97	35.03	33.16	132	150	PEAK	HORIZONTAL

**Vertical**

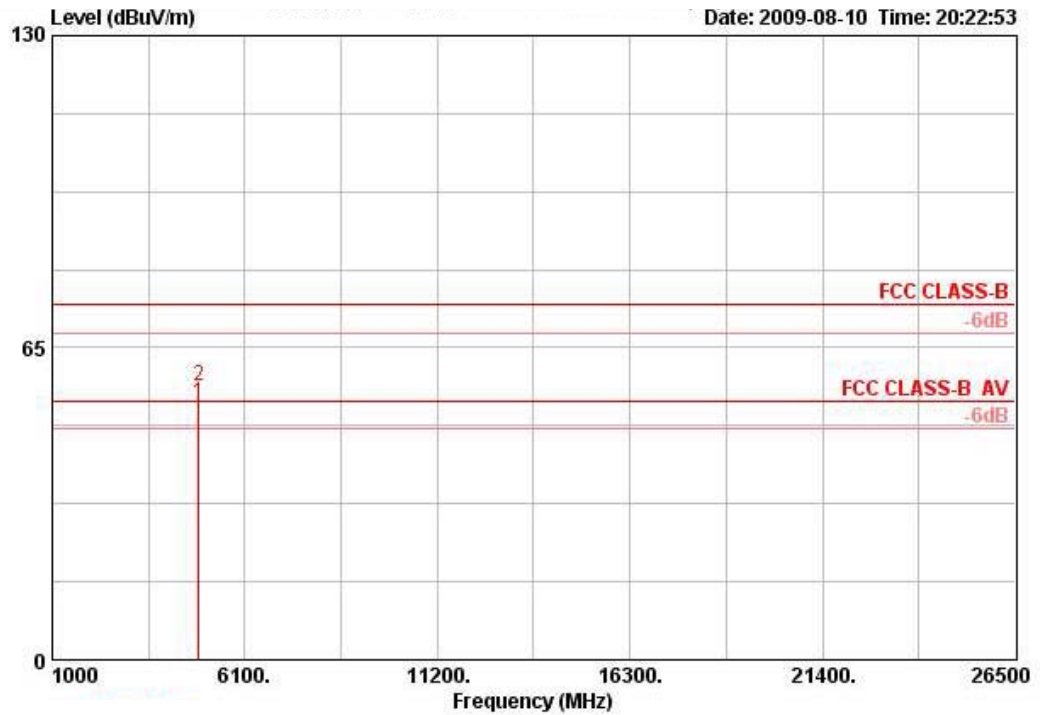

	Freq	Level	Limit	Over	Read	Cable	Preamp	Antenna	Table	Ant	Remark	Pol/Phase
	MHz	dBuV/m	dBuV/m	dB	dBuV	dB	dB	dB/m	deg	cm		
1	4873.720	53.56	54.00	-0.44	51.46	3.97	35.03	33.16	269	145	AVERAGE	VERTICAL
2	4874.150	57.20	74.00	-16.80	55.10	3.97	35.03	33.16	269	145	PEAK	VERTICAL

Temperature	24°C	Humidity	56%
Test Engineer	Beck Wu	Configurations	Draft n MCS8 20MHz Ch11 / Ant. A + Ant. B

**Horizontal**

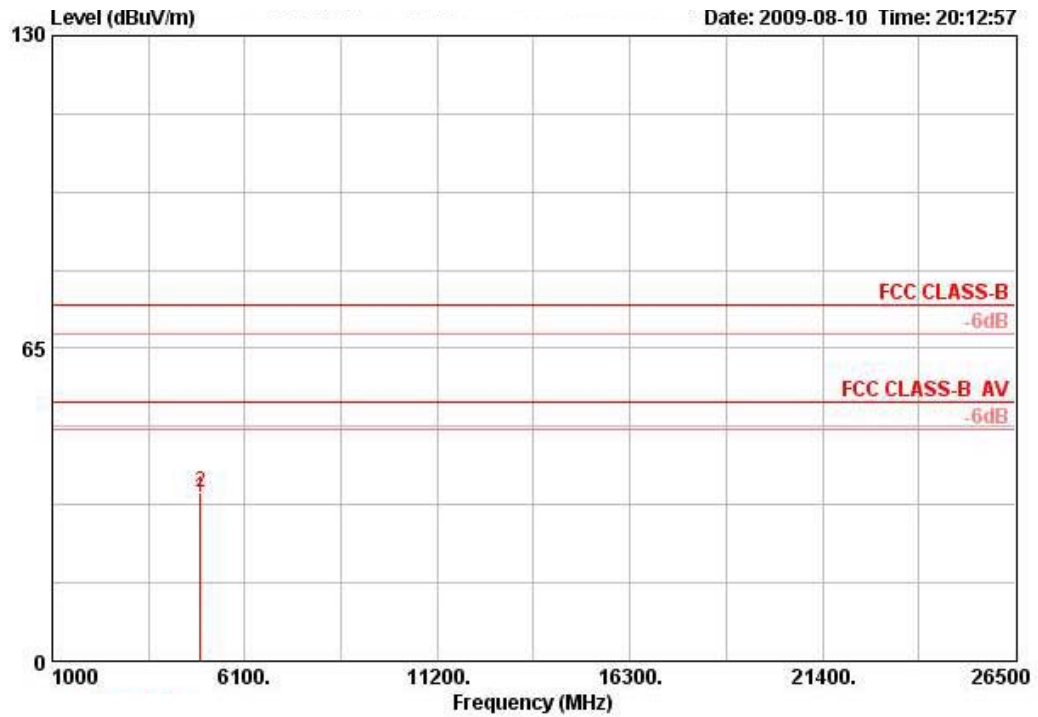

	Freq	Level	Limit	Over	Read	Cable	Preamp	Antenna	Table	Ant	Remark	Pol/Phase
	MHz	dBuV/m	dBuV/m	dB	dBuV	dB	dB	dB/m	deg	cm		
1	4924.660	34.06	54.00	-19.94	31.84	3.97	35.02	33.26	314	100	AVERAGE	HORIZONTAL
2	4925.460	35.07	74.00	-38.93	32.85	3.97	35.02	33.26	314	100	PEAK	HORIZONTAL

**Vertical**

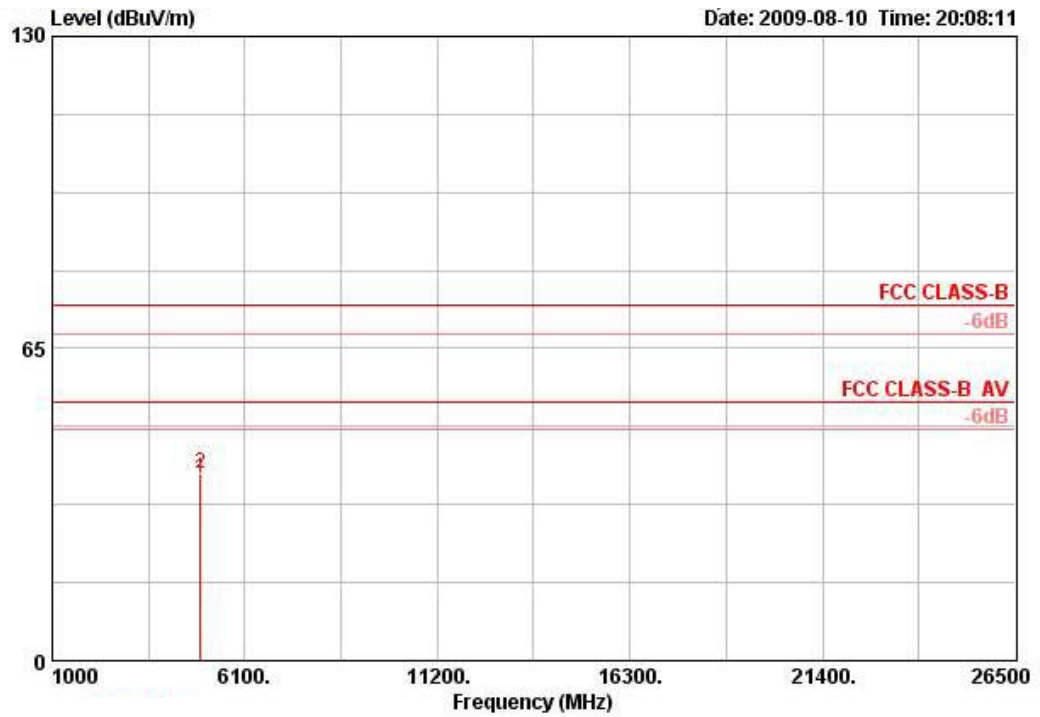

	Freq	Level	Limit	Over	Read	Cable	Preamp	Antenna	Table	Ant	Remark	Pol/Phase
	MHz	dBuV/m	dBuV/m	dB	dBuV	dB	dB	dB/m	deg	cm		
1	4924.660	37.80	54.00	-16.20	35.59	3.97	35.02	33.26	360	116	AVERAGE	VERTICAL
2	4924.660	38.80	74.00	-35.20	36.59	3.97	35.02	33.26	360	116	PEAK	VERTICAL



Temperature	24°C	Humidity	56%
Test Engineer	Beck Wu	Configurations	Draft n MCS8 40MHz Ch 3 / Ant. A + Ant. B

**Horizontal**

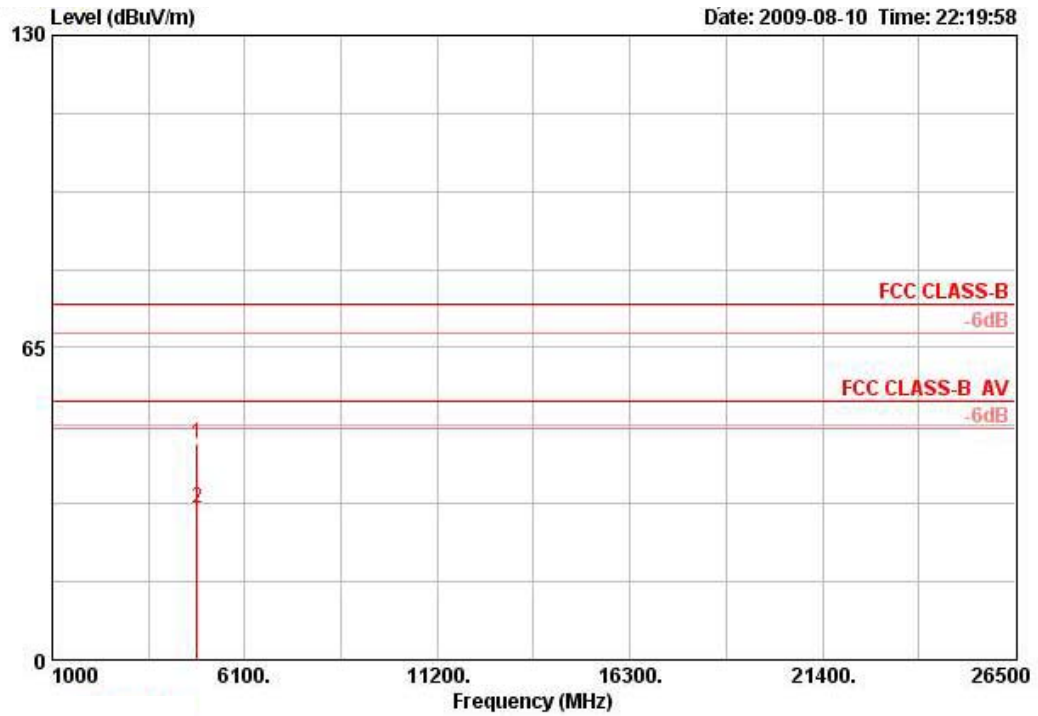

	Freq	Level	Limit	Over	Read	Cable	Preamp	Antenna	Table	Ant	Remark	Pol/Phase
	MHz	dBuV/m	dBuV/m	dB	dBuV	dB	dB	dB/m	deg	cm		
1	4844.004	45.06	74.00	-28.94	43.03	3.96	35.03	33.09	262	100	PEAK	HORIZONTAL
2	4844.025	31.40	54.00	-22.60	29.37	3.96	35.03	33.09	262	100	AVERAGE	HORIZONTAL

**Vertical**

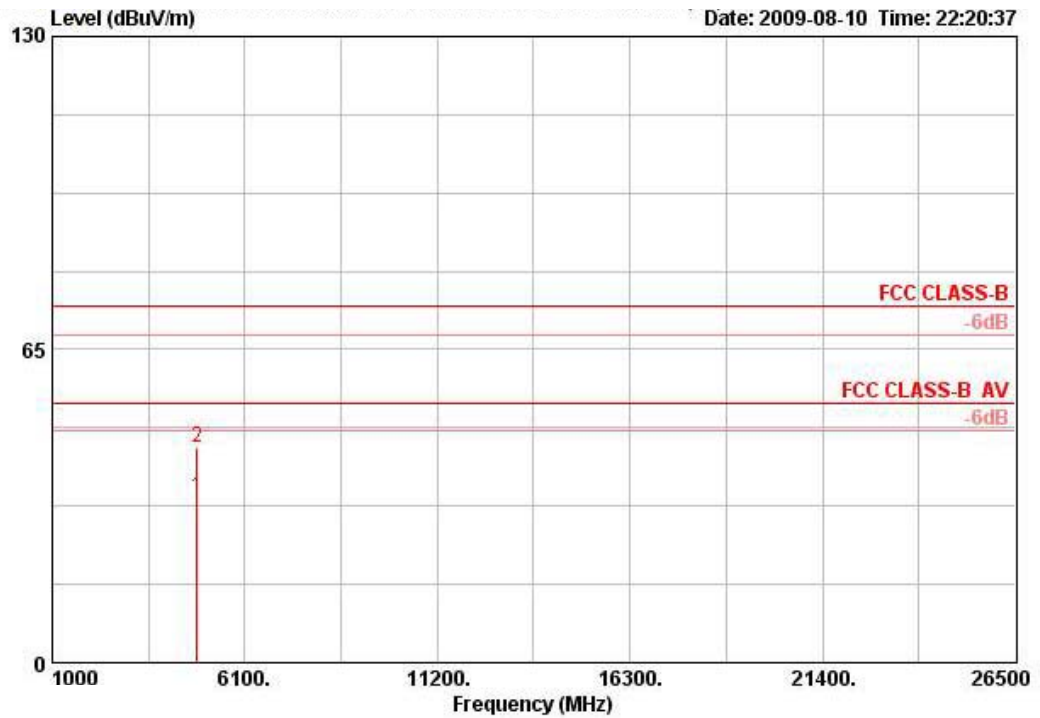

	Freq	Level	Limit	Over	Read	Cable	Preamp	Antenna	Table	Ant		
	MHz	dBuV/m	dBuV/m	dB	dBuV	dB	dB	dB/m	deg	cm	Remark	Pol/Phase
1	4843.979	34.35	54.00	-19.65	32.33	3.96	35.03	33.09	185	100	AVERAGE	VERTICAL
2	4843.991	44.66	74.00	-29.34	42.64	3.96	35.03	33.09	185	100	PEAK	VERTICAL

Temperature	24°C	Humidity	56%
Test Engineer	Beck Wu	Configurations	Draft n MCS8 40MHz Ch 6 / Ant. A + Ant. B

**Horizontal**

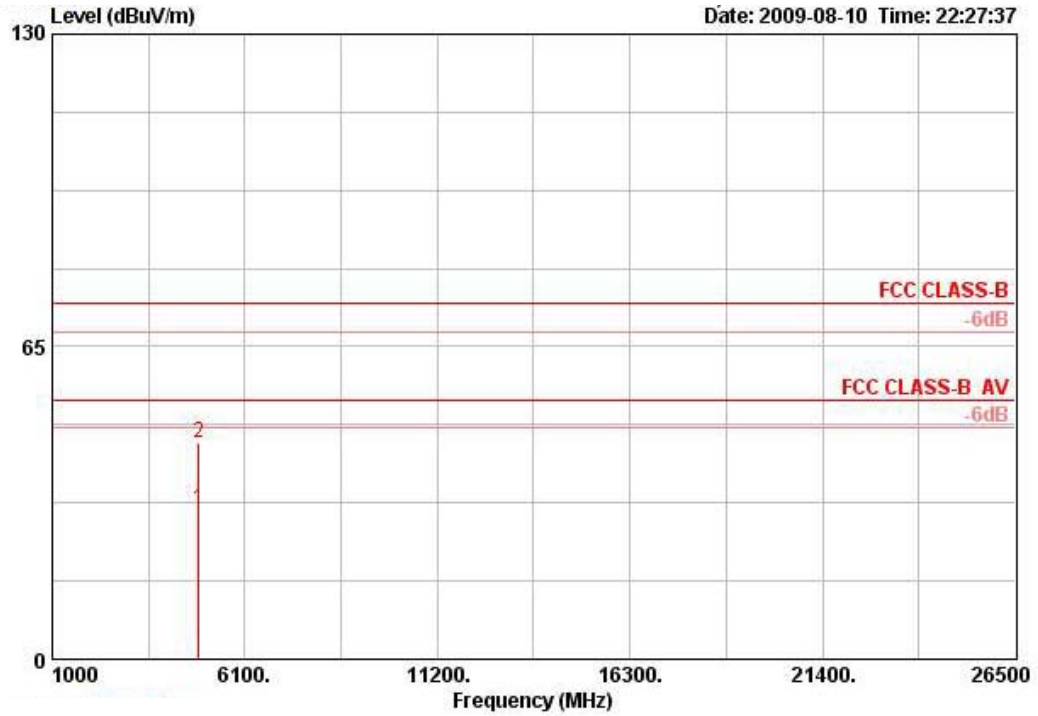

	Freq	Level	Limit	Over	Read	Cable	Preamp	Antenna	Table	Ant	Remark	Pol/Phase
	MHz	dBuV/m	dBuV/m	dB	dBuV	dB	dB	dB/m	deg	cm		
1	4873.975	31.20	54.00	-22.80	29.10	3.97	35.03	33.16	272	100	AVERAGE	HORIZONTAL
2	4873.997	45.14	74.00	-28.86	43.04	3.97	35.03	33.16	272	100	PEAK	HORIZONTAL

**Vertical**

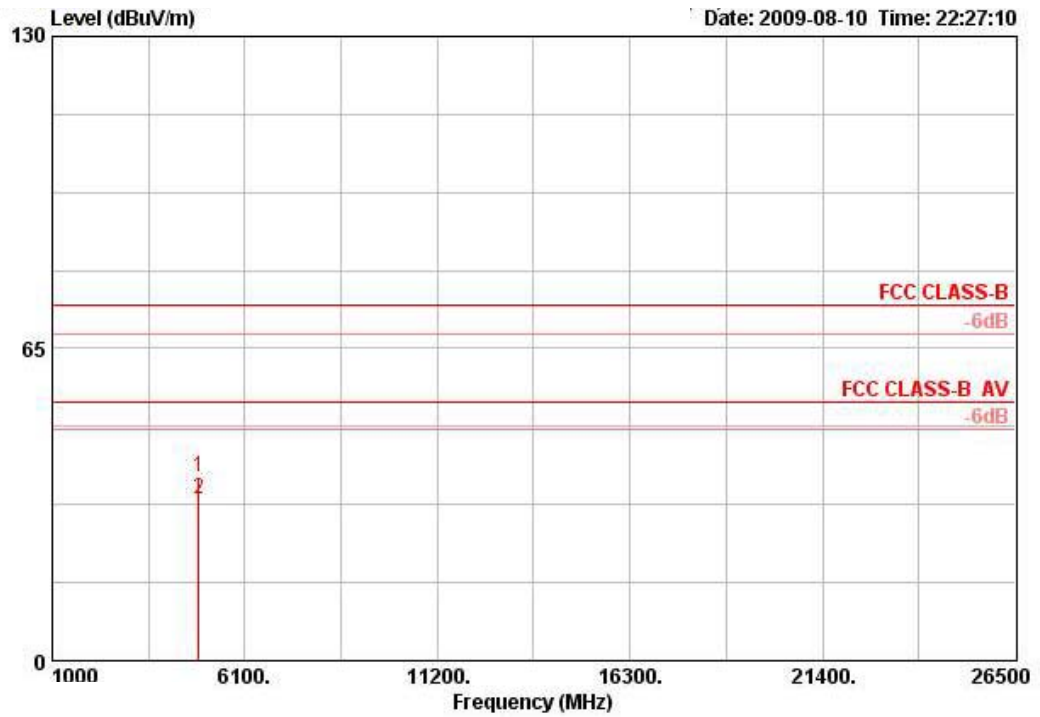

	Freq	Level	Limit	Over	Read	Cable	Preamp	Antenna	Table	Ant		
	MHz	dBuV/m	dBuV/m	dB	dBuV	dB	dB	dB/m	deg	cm	Remark	Pol/Phase
1	4873.976	38.38	74.00	-35.62	36.28	3.97	35.03	33.16	176	100	PEAK	VERTICAL
2	4873.986	33.49	54.00	-20.51	31.39	3.97	35.03	33.16	176	100	AVERAGE	VERTICAL

Temperature	24°C	Humidity	56%
Test Engineer	Beck Wu	Configurations	Draft n MCS8 40MHz Ch 9 / Ant. A + Ant. B

**Horizontal**

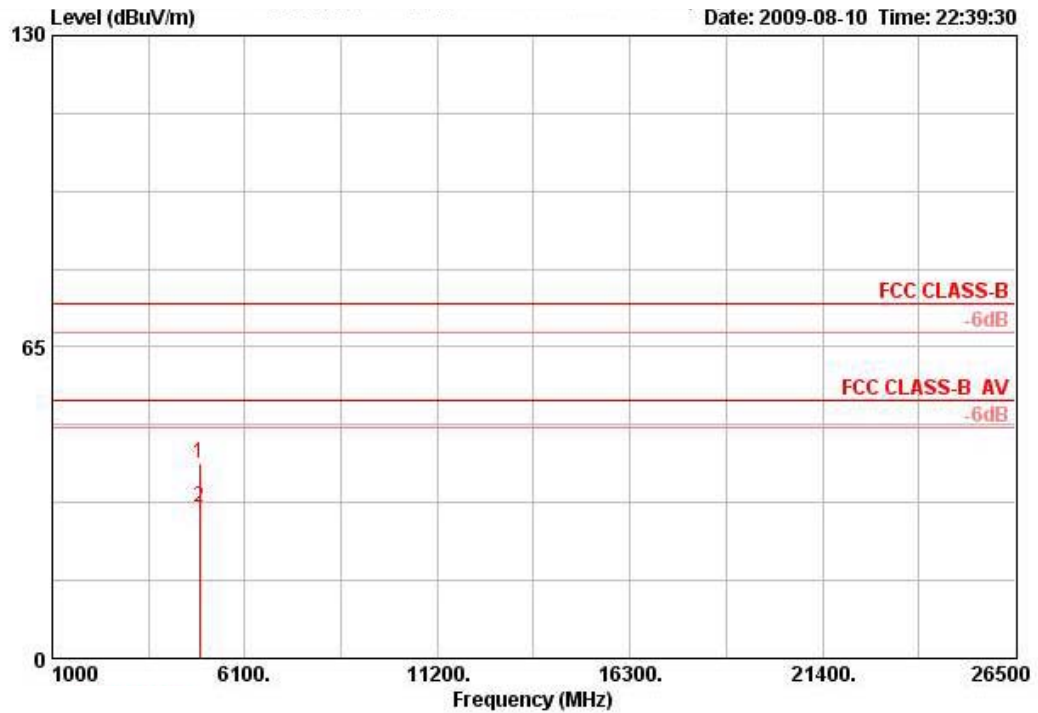

	Freq	Level	Limit	Over	Read	Cable	Preamp	Antenna	Table	Ant		
	MHz	dBuV/m	dBuV/m	dB	dBuV	dB	dB	dB/m	deg	cm	Remark	Pol/Phase
1	4903.976	40.83	74.00	-33.17	38.69	3.97	35.02	33.19	81	100	PEAK	HORIZONTAL
2	4904.025	31.54	54.00	-22.46	29.40	3.97	35.02	33.19	81	100	AVERAGE	HORIZONTAL

**Vertical**

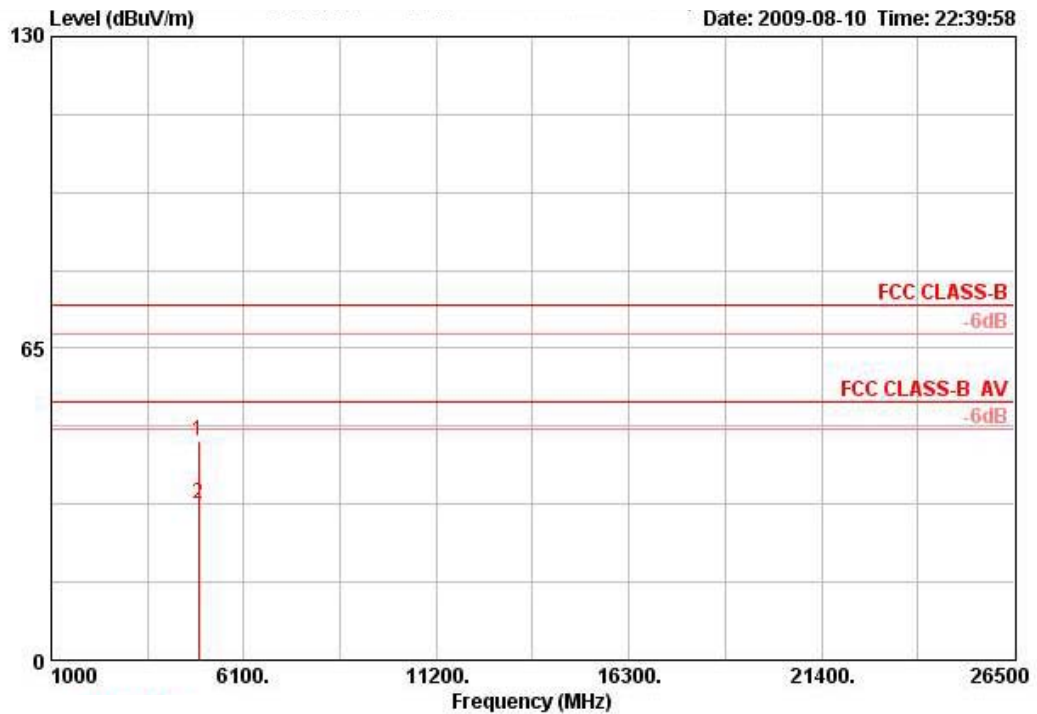

	Freq	Level	Limit	Over	Read	Cable	Preamp	Antenna	Table	Ant	Remark	Pol/Phase
	MHz	dBuV/m	dBuV/m	dB	dBuV	dB	dB	dB/m	deg	cm		
1	4903.988	45.55	74.00	-28.45	43.40	3.97	35.02	33.19	181	100	PEAK	VERTICAL
2	4904.001	32.63	54.00	-21.37	30.49	3.97	35.02	33.19	181	100	AVERAGE	VERTICAL

**Note:**

The amplitude of spurious emissions which are attenuated by more than 20 dB below the permissible value has no need to be reported.

Emission level (dBUV/m) = 20 log Emission level (uV/m).

Corrected Reading: Antenna Factor + Cable Loss + Read Level - Preamp Factor = Level.

Temperature	24°C	Humidity	56%
Test Engineer	Beck Wu	Configurations	802.11b CH 1 / Ant. A

**Horizontal**

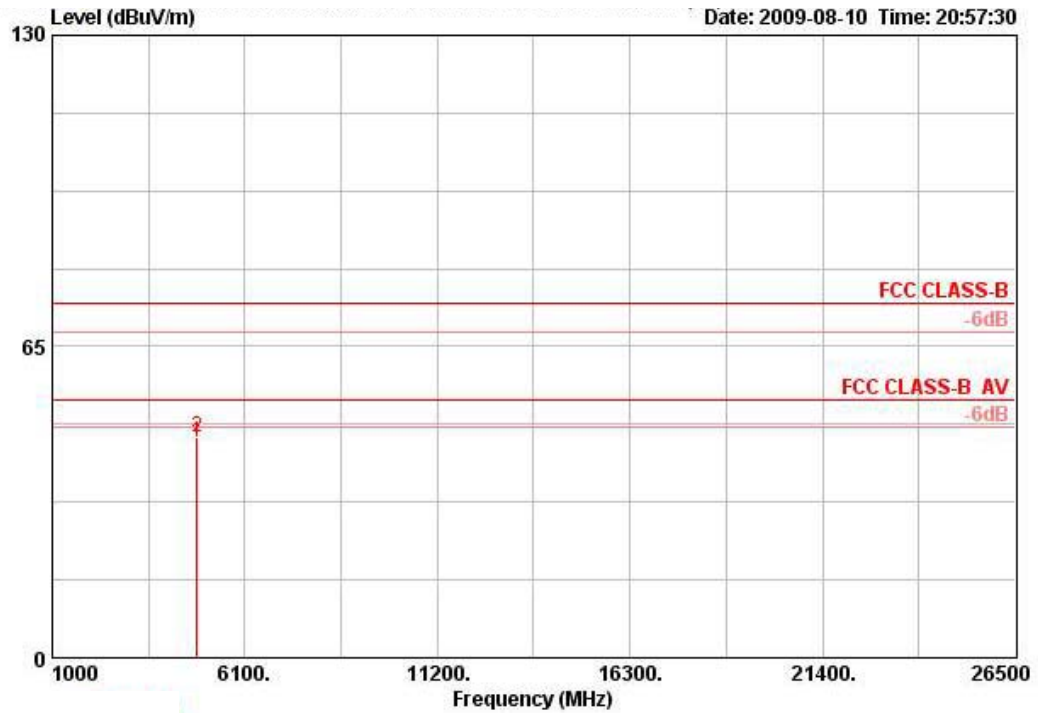

	Freq	Level	Limit	Over	Read	Cable	Preamp	Antenna	Table	Ant	Remark	Pol/Phase
	MHz	dBuV/m	dBuV/m	dB	dBuV	dB	dB	dB/m	deg	cm		
1	4823.984	45.00	54.00	-9.00	43.02	3.96	35.04	33.06	173	114	AVERAGE	HORIZONTAL
2	4824.036	46.14	74.00	-27.86	44.16	3.96	35.04	33.06	173	114	PEAK	HORIZONTAL

**Vertical**

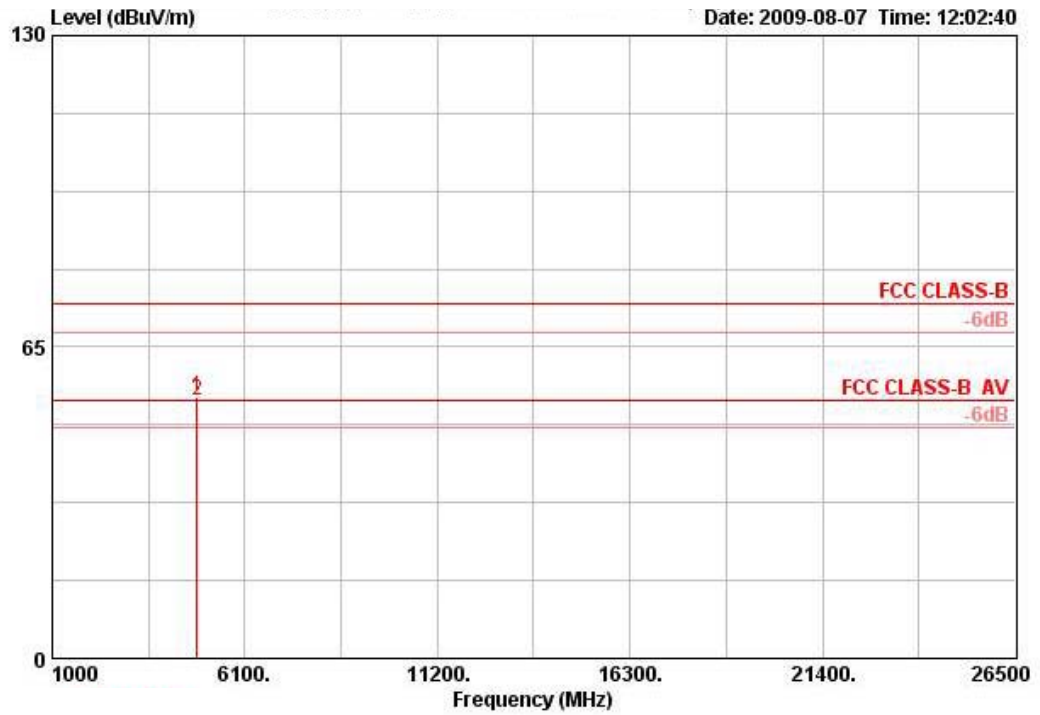

	Freq	Level	Limit	Over	Read	Cable	Preamp	Antenna	Table	Ant	Remark	Pol/Phase
	MHz	dBuV/m	dBuV/m	dB	dBuV	dB	dB	dB/m	deg	cm		
1	4823.988	54.73	74.00	-19.27	52.75	3.96	35.04	33.06	269	134	PEAK	VERTICAL
2	4824.000	53.88	54.00	-0.12	51.90	3.96	35.04	33.06	269	134	AVERAGE	VERTICAL



Temperature	24°C	Humidity	56%
Test Engineer	Beck Wu	Configurations	802.11b CH 6 / Ant. A

Horizontal

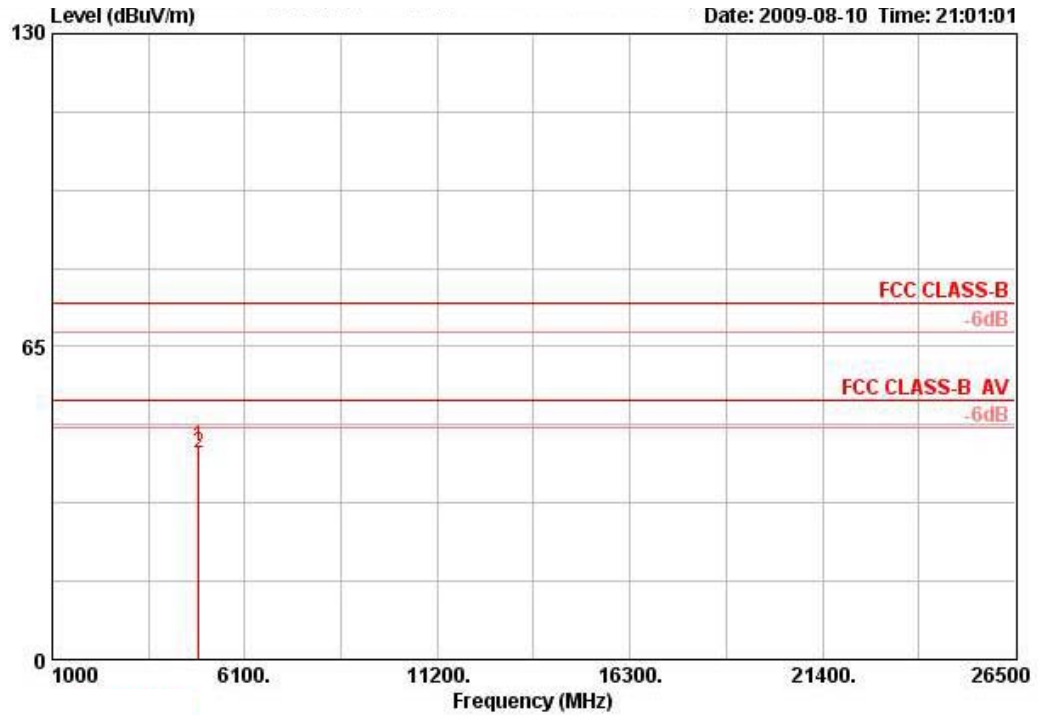

	Freq	Level	Limit	Over	Read	Cable	Preamp	Antenna	Table	Ant	Remark	Pol/Phase
	MHz	dBuV/m	dBuV/m	dB	dBuV	Loss	Factor	Factor	Pos	Pos		
						dB	dB	dB/m	deg	cm		
1	4873.850	44.21	74.00	-29.79	42.12	3.97	35.03	33.16	196	103	PEAK	HORIZONTAL
2	4873.966	42.73	54.00	-11.27	40.63	3.97	35.03	33.16	196	103	AVERAGE	HORIZONTAL

**Vertical**

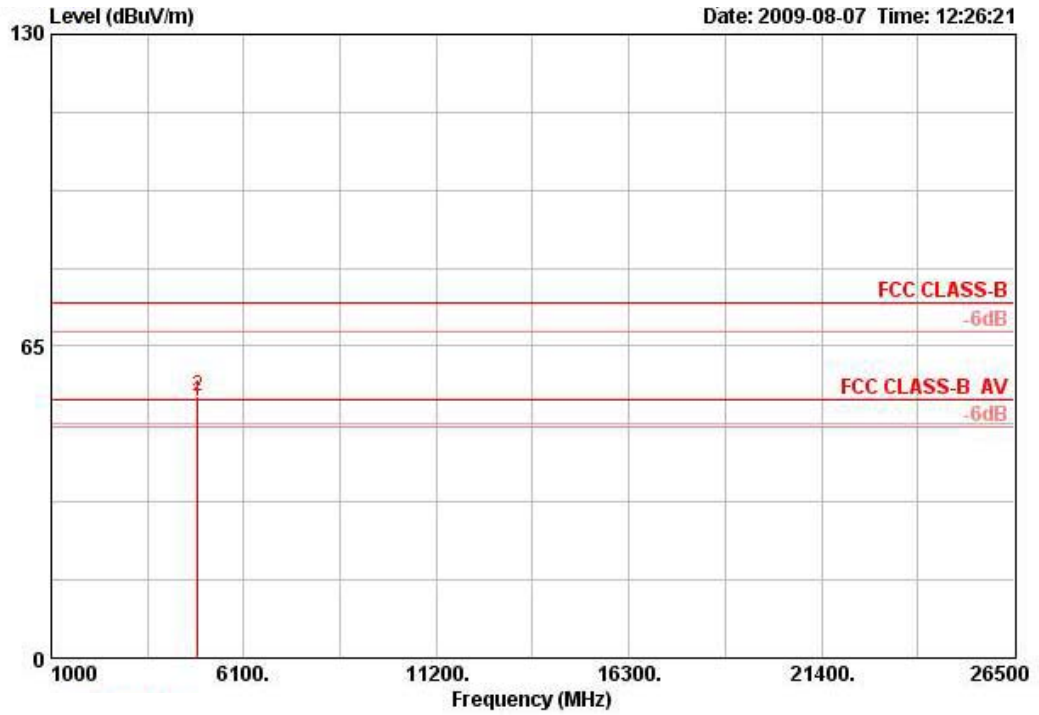

	Freq	Level	Limit	Over	Read	Cable	Preamp	Antenna	Table	Ant	Remark	Pol/Phase
	MHz	dBuV/m	dBuV/m	dB	dBuV	dB	dB	dB/m	deg	cm		
1	4874.000	53.51	54.00	-0.49	51.41	3.97	35.03	33.16	266	147	AVERAGE	VERTICAL
2	4874.023	54.72	74.00	-19.28	52.62	3.97	35.03	33.16	266	147	PEAK	VERTICAL

Temperature	24°C	Humidity	56%
Test Engineer	Beck Wu	Configurations	802.11b CH 11 / Ant. A

**Horizontal**

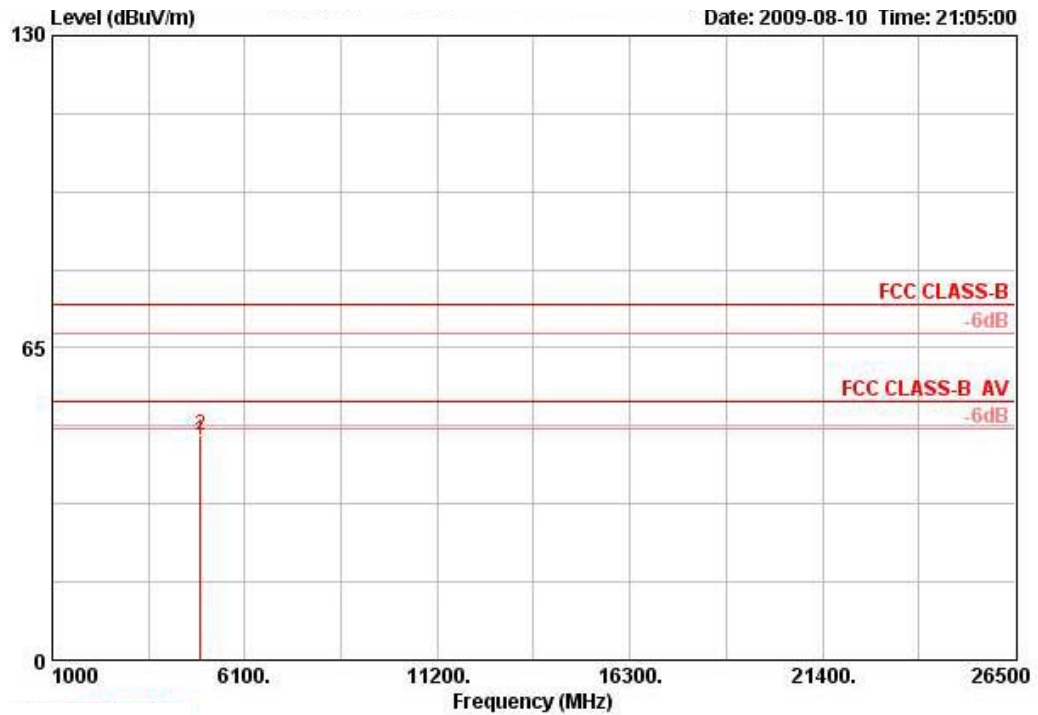

	Freq	Level	Limit	Over	Read	Cable	Preamp	Antenna	Table	Ant	Remark	Pol/Phase
	MHz	dBuV/m	dBuV/m	dB	dBuV	dB	dB	dB/m	deg	cm		
1	4924.028	45.72	54.00	-8.28	43.50	3.97	35.02	33.26	137	127	AVERAGE	HORIZONTAL
2	4924.028	46.73	74.00	-27.27	44.52	3.97	35.02	33.26	137	127	PEAK	HORIZONTAL

**Vertical**

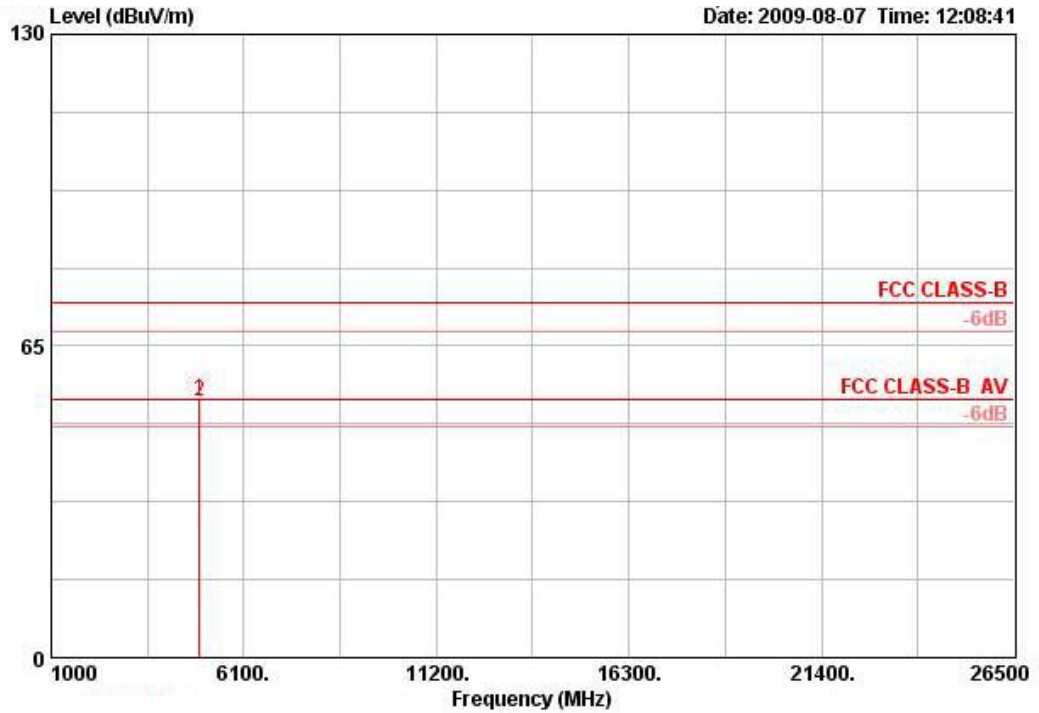

	Freq	Level	Limit	Over	Read	Cable	Preamp	Antenna	Table	Ant	Remark	Pol/Phase
	MHz	dBuV/m	dBuV/m	dB	dBuV	dB	dB	dB/m	deg	cm		
1	4924.042	53.97	74.00	-20.03	51.75	3.97	35.02	33.26	251	117	PEAK	VERTICAL
2	4924.050	53.54	54.00	-0.46	51.32	3.97	35.02	33.26	251	117	AVERAGE	VERTICAL

Temperature	24°C	Humidity	56%
Test Engineer	Beck Wu	Configurations	802.11g CH 1 / Ant. A

**Horizontal**

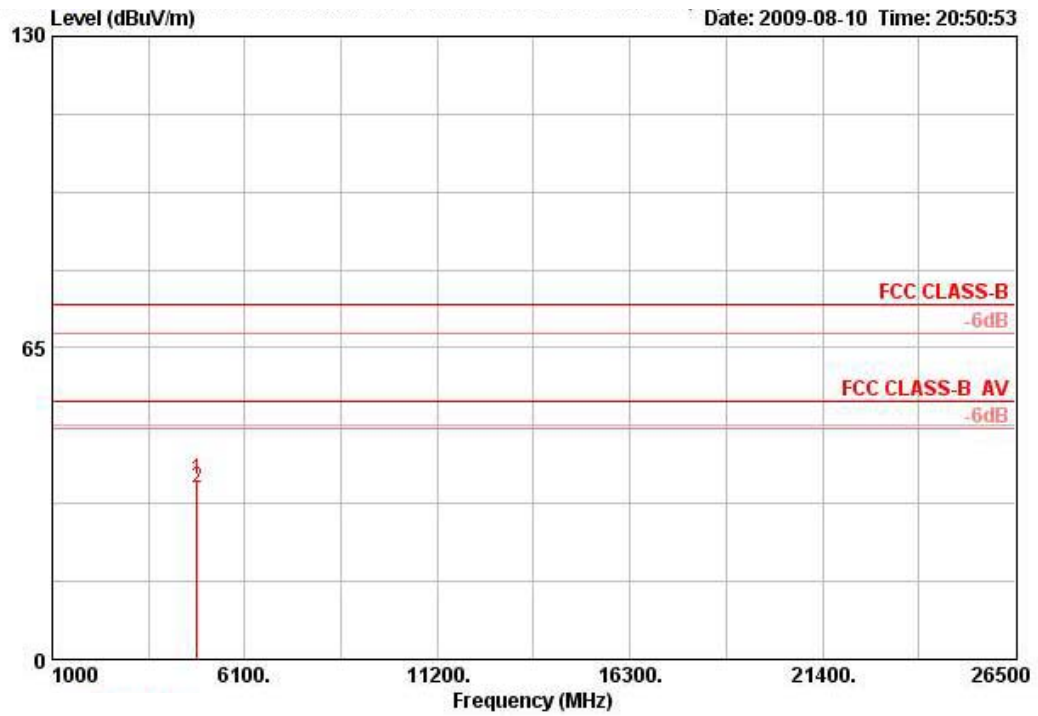

	Freq	Level	Limit	Over	Read	Cable	Preamp	Antenna	Table	Ant	Remark	Pol/Phase
	MHz	dBuV/m	dBuV/m	dB	dBuV	dB	dB	dB/m	deg	cm		
1	4824.368	37.70	74.00	-36.30	35.72	3.96	35.04	33.06	131	130	PEAK	HORIZONTAL
2	4824.544	35.71	54.00	-18.29	33.73	3.96	35.04	33.06	131	130	AVERAGE	HORIZONTAL

**Vertical**

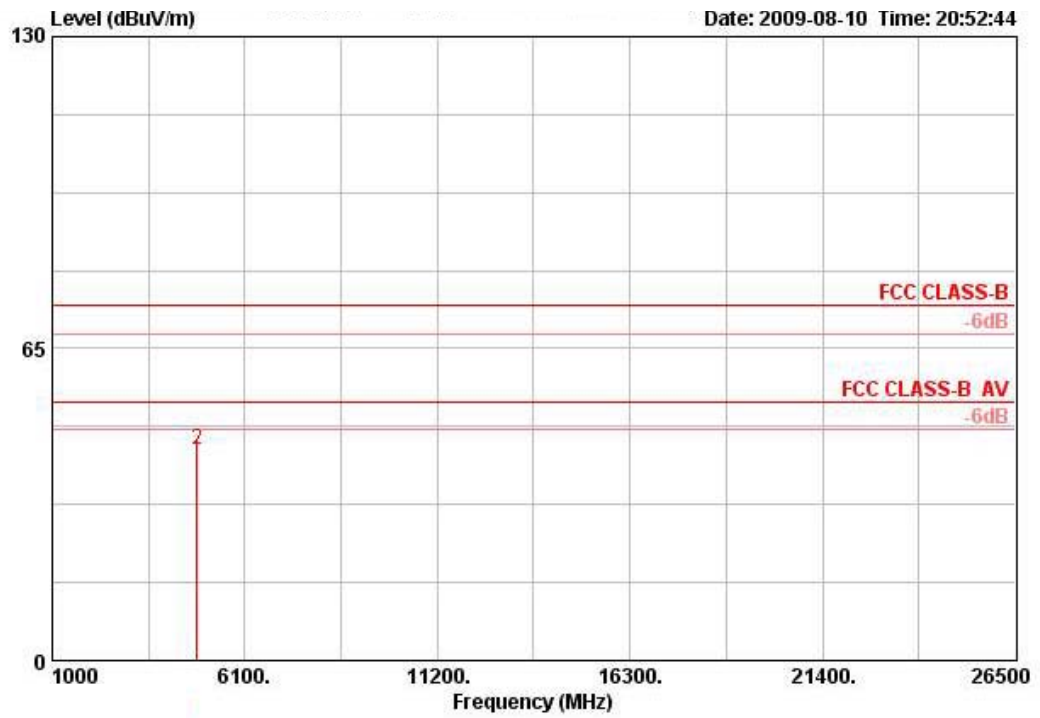

	Freq	Level	Limit	Over	Read	Cable	Preamp	Antenna	Table	Ant	Remark	Pol/Phase
	MHz	dBuV/m	dBuV/m	dB	dBuV	dB	dB	dB/m	deg	cm		
1	4824.616	41.84	54.00	-12.16	39.86	3.96	35.04	33.06	282	131	AVERAGE	VERTICAL
2	4824.688	44.09	74.00	-29.91	42.11	3.96	35.04	33.06	282	131	PEAK	VERTICAL

Temperature	24°C	Humidity	56%
Test Engineer	Beck Wu	Configurations	802.11g CH 6 / Ant. A

**Horizontal**

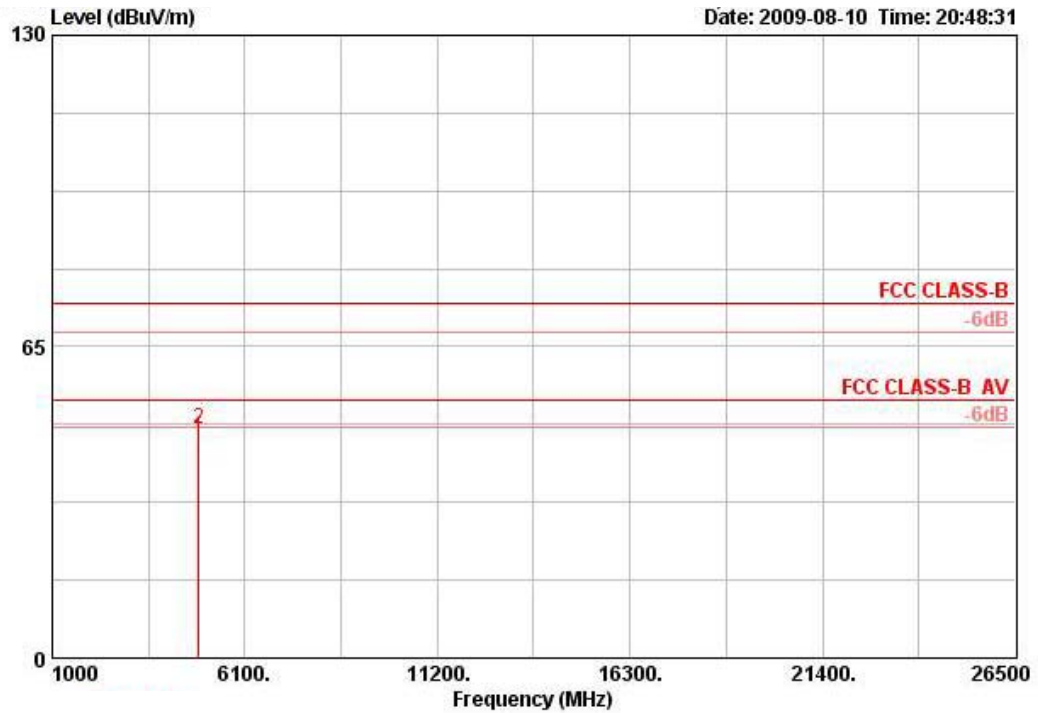

	Freq	Level	Limit	Over	Read	Cable	Preamp	Antenna	Table	Ant	Remark	Pol/Phase
	MHz	dBuV/m	dBuV/m	dB	dBuV	dB	dB	dB/m	deg	cm		
1	4873.892	45.89	54.00	-8.11	43.79	3.97	35.03	33.16	131	130	AVERAGE	HORIZONTAL
2	4873.908	47.82	74.00	-26.18	45.72	3.97	35.03	33.16	131	130	PEAK	HORIZONTAL

**Vertical**

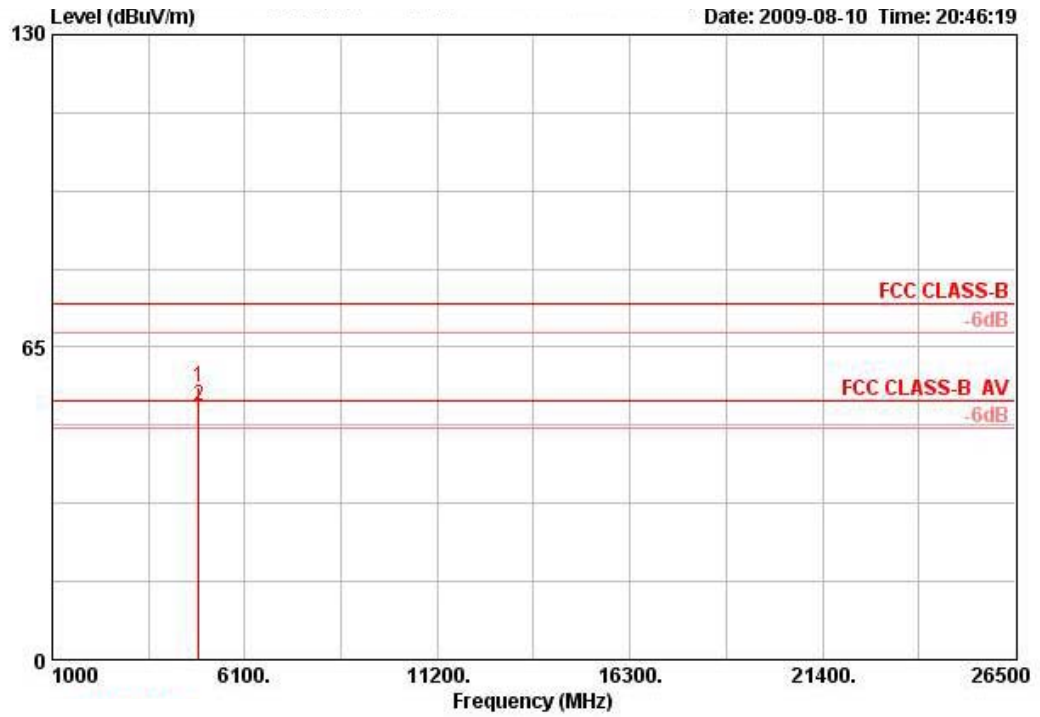

	Freq	Level	Limit	Over	Read	Cable	Preamp	Antenna	Table	Rnt		
	MHz	dBuV/m	dBuV/m	dB	dBuV	dB	dB	dB/m	deg	cm	Remark	Pol/Phase
1	4873.984	56.82	74.00	-17.18	54.72	3.97	35.03	33.16	280	130	PEAK	VERTICAL
2	4874.050	52.87	54.00	-1.13	50.77	3.97	35.03	33.16	280	130	AVERAGE	VERTICAL



Temperature	24°C	Humidity	56%
Test Engineer	Beck Wu	Configurations	802.11g CH 11 / Ant. A

**Horizontal**

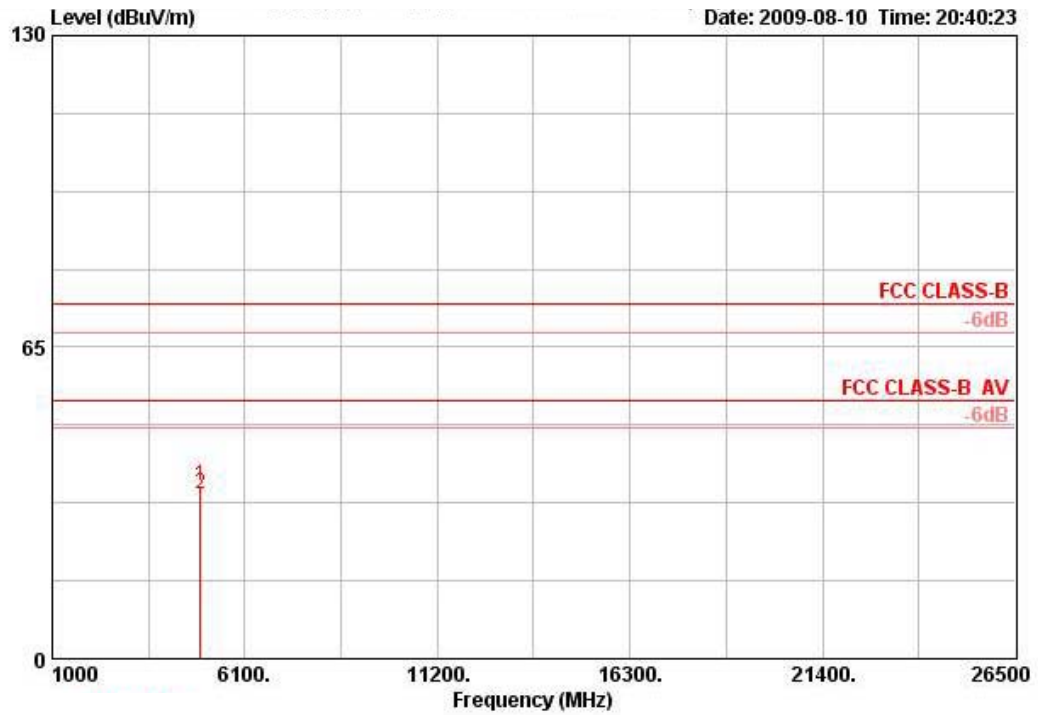

	Freq	Level	Limit	Over	Read	Cable	Preamp	Antenna	Table	Ant	Remark	Pol/Phase
	MHz	dBuV/m	dBuV/m	dB	dBuV	dB	dB	dB/m	deg	cm		
1	4923.750	36.24	74.00	-37.76	34.02	3.97	35.02	33.26	322	115	PEAK	HORIZONTAL
2	4924.086	34.24	54.00	-19.76	32.02	3.97	35.02	33.26	322	115	AVERAGE	HORIZONTAL

**Vertical**

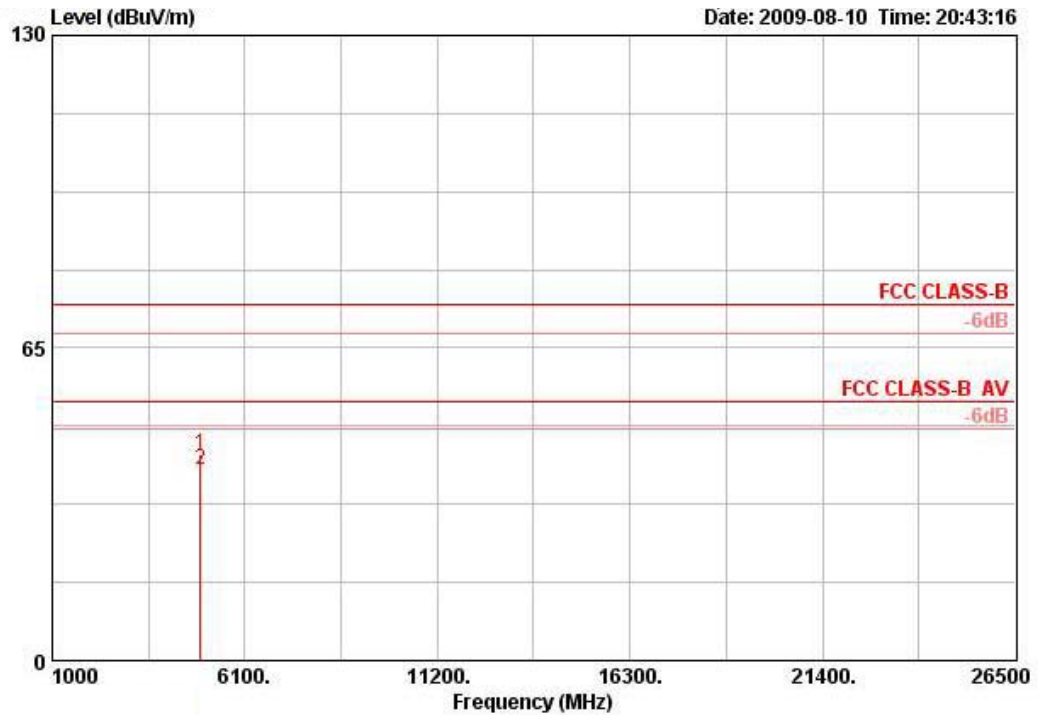

	Freq	Level	Limit	Over	Read	Cable	Preamp	Antenna	Table	Rnt		
	MHz	dBuV/m	dBuV/m	dB	dBuV	dB	dB	dB/m	deg	cm	Remark	Pol/Phase
1	4924.053	42.85	74.00	-31.15	40.63	3.97	35.02	33.26	282	115	PEAK	VERTICAL
2	4924.171	39.63	54.00	-14.37	37.41	3.97	35.02	33.26	282	115	AVERAGE	VERTICAL

**Note:**

The amplitude of spurious emissions that are attenuated by more than 20dB below the permissible value has no need to be reported.

Emission level (dBUV/m) = 20 log Emission level (uV/m).

Corrected Reading: Antenna Factor + Cable Loss + Read Level - Preamp Factor = Level.

## 4.6. Band Edge Emissions Measurement

### 4.6.1. Limit

20dBc in any 100 kHz bandwidth outside the operating frequency band. In case the emission fall within the restricted band specified on 15.205(a), then the 15.209(a) limit in the table below has to be followed.

Frequencies (MHz)	Field Strength (micovolts/meter)	Measurement Distance (meters)
0.009~0.490	2400/F(KHz)	300
0.490~1.705	24000/F(KHz)	30
1.705~30.0	30	30
30~88	100	3
88~216	150	3
216~960	200	3
Above 960	500	3

### 4.6.2. Measuring Instruments and Setting

Please refer to section 5 of equipments list in this report. The following table is the setting of the spectrum analyzer.

Spectrum Parameter	Setting
Attenuation	Auto
Span Frequency	100 MHz
RB / VB (Emission in restricted band)	1 MHz / 1MHz for Peak, 1 MHz / 10Hz for Average
RB / VB (Emission in non-restricted band)	100 KHz /100 KHz for Peak

### 4.6.3. Test Procedures

1. The test procedure is the same as section 4.5.3, only the frequency range investigated is limited to 100MHz around bandedges.
2. In case the emission is fail due to the used RB/VB is too wide, marker-delta method of FCC Public Notice DA00-705 will be followed.

### 4.6.4. Test Setup Layout

This test setup layout is the same as that shown in section 4.5.4.

### 4.6.5. Test Deviation

There is no deviation with the original standard.

### 4.6.6. EUT Operation during Test

The EUT was programmed to be in continuously transmitting mode.

## 4.6.7. Test Result of Band Edge and Fundamental Emissions

Temperature	24°C	Humidity	56%
Test Engineer	Beck Wu	Configurations	Draft n MCS8 20MHz Ch 1, 6, 11 / Ant. A + Ant. B
Test Date	Aug. 10, 2009		

## Channel 1

	Freq	Level	Limit Line	Over Limit	Read Level	Cable Loss	Preamp Factor	Antenna Factor	Table Pos	Ant Pos	Remark	Pol/Phase
	MHz	dBuV/m	dBuV/m	dB	dBuV	dB	dB	dB/m	deg	cm		
1 ☺	2390.000	46.24	54.00	-7.76	15.31	2.76	0.00	28.17	29	120	AVERAGE	HORIZONTAL
2	2390.000	48.70	74.00	-25.30	17.77	2.76	0.00	28.17	29	120	PEAK	HORIZONTAL
3 ☺	2412.800	85.05			54.07	2.77	0.00	28.21	29	120	AVERAGE	HORIZONTAL
4 ☺	2413.000	86.44			55.46	2.77	0.00	28.21	29	120	PEAK	HORIZONTAL

Item 3, 4 are the fundamental frequency at 2412 MHz

## Channel 6

	Freq	Level	Limit Line	Over Limit	Read Level	Cable Loss	Preamp Factor	Antenna Factor	Table Pos	Ant Pos	Remark	Pol/Phase
	MHz	dBuV/m	dBuV/m	dB	dBuV	dB	dB	dB/m	deg	cm		
1 ☺	2390.000	52.22	54.00	-1.78	21.29	2.76	0.00	28.17	54	116	AVERAGE	VERTICAL
2	2390.000	60.23	74.00	-13.77	29.29	2.76	0.00	28.17	54	116	PEAK	VERTICAL
3 ☺	2435.800	107.66			76.58	2.78	0.00	28.29	54	116	AVERAGE	VERTICAL
4 ☺	2438.000	111.45			80.38	2.78	0.00	28.29	54	116	PEAK	VERTICAL
5	2483.500	54.44	74.00	-19.56	23.26	2.81	0.00	28.37	54	116	PEAK	VERTICAL
6 ☺	2483.500	50.37	54.00	-3.63	19.19	2.81	0.00	28.37	54	116	AVERAGE	VERTICAL

Item 3, 4 are the fundamental frequency at 2437MHz.

## Channel 11

	Freq	Level	Limit Line	Over Limit	Read Level	Cable Loss	Preamp Factor	Antenna Factor	Table Pos	Ant Pos	Remark	Pol/Phase
	MHz	dBuV/m	dBuV/m	dB	dBuV	dB	dB	dB/m	deg	cm		
1 ☺	2460.800	95.74			64.62	2.80	0.00	28.33	277	121	AVERAGE	VERTICAL
2 ☺	2462.000	99.36			68.23	2.80	0.00	28.33	277	121	PEAK	VERTICAL
3 ☺	2483.500	53.02	54.00	-0.98	21.84	2.81	0.00	28.37	277	121	AVERAGE	VERTICAL
4	2483.500	56.81	74.00	-17.19	25.63	2.81	0.00	28.37	277	121	PEAK	VERTICAL

Item 1, 2 are the fundamental frequency at 2462 MHz.

<b>Temperature</b>	24°C	<b>Humidity</b>	56%
<b>Test Engineer</b>	Beck Wu	<b>Configurations</b>	Draft n MCS8 40MHz Ch 3, 6, 9 / Ant. A + Ant. B
<b>Test Date</b>	Aug. 10, 2009		

**Channel 3**

	Freq	Level	Limit Line	Over Limit	Read Level	Cable Loss	Preamp Factor	Antenna Factor	Table Pos	Ant Pos	Remark	Pol/Phase
	MHz	dBuV/m	dBuV/m	dB	dBuV	dB	dB	dB/m	deg	cm		
1 ☺	2389.600	61.70	74.00	-12.30	30.77	2.76	0.00	28.17	330	122	PEAK	VERTICAL
2 ☺	2390.000	53.49	54.00	-0.51	22.56	2.76	0.00	28.17	330	122	AVERAGE	VERTICAL
3 ☺	2424.800	96.64			65.62	2.77	0.00	28.25	330	122	PEAK	VERTICAL
4 ☺	2425.200	90.86			59.84	2.77	0.00	28.25	330	122	AVERAGE	VERTICAL

Item 3, 4 are the fundamental frequency at 2422 MHz.

**Channel 6**

	Freq	Level	Limit Line	Over Limit	Read Level	Cable Loss	Preamp Factor	Antenna Factor	Table Pos	Ant Pos	Remark	Pol/Phase
	MHz	dBuV/m	dBuV/m	dB	dBuV	dB	dB	dB/m	deg	cm		
1 ☺	2390.000	53.61	54.00	-0.39	22.68	2.76	0.00	28.17	86	124	AVERAGE	VERTICAL
2	2390.000	57.75	74.00	-16.25	26.82	2.76	0.00	28.17	86	124	PEAK	VERTICAL
3 ☺	2446.200	102.93			71.86	2.78	0.00	28.29	86	124	PEAK	VERTICAL
4 ☺	2448.200	97.10			66.02	2.78	0.00	28.29	86	124	AVERAGE	VERTICAL
5 ☺	2483.500	51.19	54.00	-2.81	20.01	2.81	0.00	28.37	86	124	AVERAGE	VERTICAL
6	2483.600	58.19	74.00	-15.81	27.01	2.81	0.00	28.37	86	124	Peak	VERTICAL

Item 3, 4 are the fundamental frequency at 2437MHz.

**Channel 9**

	Freq	Level	Limit Line	Over Limit	Read Level	Cable Loss	Preamp Factor	Antenna Factor	Table Pos	Ant Pos	Remark	Pol/Phase
	MHz	dBuV/m	dBuV/m	dB	dBuV	dB	dB	dB/m	deg	cm		
1 ☺	2450.400	95.49			64.41	2.78	0.00	28.29	259	118	AVERAGE	VERTICAL
2 ☺	2454.000	99.90			68.78	2.78	0.00	28.33	259	118	PEAK	VERTICAL
3 ☺	2486.700	53.66	54.00	-0.34	22.44	2.81	0.00	28.41	259	118	AVERAGE	VERTICAL
4	2486.700	58.93	74.00	-15.07	27.71	2.81	0.00	28.41	259	118	PEAK	VERTICAL

Item 1, 2 are the fundamental frequency at 2452 MHz.

Note:

Emission level (dBuV/m) = 20 log Emission level (uV/m).

Corrected Reading: Antenna Factor + Cable Loss + Read Level - Preamp Factor = Level.

Temperature	24°C	Humidity	56%
Test Engineer	Beck Wu	Configurations	802.11b CH 1, 6, 11 / Ant. A
Test Date	Aug. 10, 2009		

**Channel 1**

	Freq	Level	Limit Line	Over Limit	Read Level	Cable Loss	Preamp Factor	Antenna Factor	Table Pos	Ant Pos	Remark	Pol/Phase
	MHz	dBuV/m	dBuV/m	dB	dBuV	dB	dB	dB/m	deg	cm		
1 ☺	2390.000	46.64	54.00	-7.36	15.71	2.76	0.00	28.17	306	117	AVERAGE	VERTICAL
2	2390.000	50.52	74.00	-23.48	19.59	2.76	0.00	28.17	306	117	PEAK	VERTICAL
3 ☺	2412.400	105.01			74.03	2.77	0.00	28.21	306	117	PEAK	VERTICAL
4 ☺	2412.800	103.79			72.80	2.77	0.00	28.21	306	117	AVERAGE	VERTICAL

Item 3, 4 are the fundamental frequency at 2412 MHz.

**Channel 6**

	Freq	Level	Limit Line	Over Limit	Read Level	Cable Loss	Preamp Factor	Antenna Factor	Table Pos	Ant Pos	Remark	Pol/Phase
	MHz	dBuV/m	dBuV/m	dB	dBuV	dB	dB	dB/m	deg	cm		
1	2390.000	51.77	74.00	-22.23	20.84	2.76	0.00	28.17	53	115	Peak	VERTICAL
2 ☺	2390.000	45.77	54.00	-8.23	14.84	2.76	0.00	28.17	53	115	Average	VERTICAL
3 ☺	2437.600	109.22			78.15	2.78	0.00	28.29	53	115	PEAK	VERTICAL
4 ☺	2438.800	104.24			73.17	2.78	0.00	28.29	53	115	AVERAGE	VERTICAL
5	2483.500	50.41	74.00	-23.59	19.23	2.81	0.00	28.37	53	115	Peak	VERTICAL
6 ☺	2483.500	46.41	54.00	-7.59	15.23	2.81	0.00	28.37	53	115	Average	VERTICAL

Item 3, 4 are the fundamental frequency at 2437MHz.

**Channel 11**

	Freq	Level	Limit Line	Over Limit	Read Level	Cable Loss	Preamp Factor	Antenna Factor	Table Pos	Ant Pos	Remark	Pol/Phase
	MHz	dBuV/m	dBuV/m	dB	dBuV	dB	dB	dB/m	deg	cm		
1 ☺	2461.200	105.29			74.16	2.80	0.00	28.33	101	118	AVERAGE	VERTICAL
2 ☺	2462.600	105.54			74.42	2.80	0.00	28.33	101	118	PEAK	VERTICAL
3 ☺	2483.500	46.65	54.00	-7.35	15.47	2.81	0.00	28.37	101	118	AVERAGE	VERTICAL
4	2483.500	51.14	74.00	-22.86	19.96	2.81	0.00	28.37	101	118	PEAK	VERTICAL

Item 1, 2 are the fundamental frequency at 2462 MHz.



Temperature	24°C	Humidity	56%
Test Engineer	Beck Wu	Configurations	802.11g CH 1, 6, 11 / Ant. A
Test Date	Aug. 10, 2009		

**Channel 1**

	Freq	Level	Limit Line	Over Limit	Read Level	Cable Loss	Preamp Factor	Antenna Factor	Table Pos	Ant Pos	Remark	Pol/Phase
	MHz	dBuV/m	dBuV/m	dB	dBuV	dB	dB	dB/m	deg	cm		
1 ☺	2390.000	45.82	54.00	-8.18	14.89	2.76	0.00	28.17	29	118	AVERAGE	HORIZONTAL
2	2390.000	48.83	74.00	-25.17	17.90	2.76	0.00	28.17	29	118	PEAK	HORIZONTAL
3 ☺	2413.000	84.85			53.87	2.77	0.00	28.21	29	118	AVERAGE	HORIZONTAL
4 ☺	2414.400	86.43			55.44	2.77	0.00	28.21	29	118	PEAK	HORIZONTAL

Item 3, 4 are the fundamental frequency at 2412 MHz.

**Channel 6**

	Freq	Level	Limit Line	Over Limit	Read Level	Cable Loss	Preamp Factor	Antenna Factor	Table Pos	Ant Pos	Remark	Pol/Phase
	MHz	dBuV/m	dBuV/m	dB	dBuV	dB	dB	dB/m	deg	cm		
1	2390.000	55.63	74.00	-18.37	24.70	2.76	0.00	28.17	272	120	PEAK	VERTICAL
2 ☺	2390.000	49.96	54.00	-4.04	19.03	2.76	0.00	28.17	272	120	AVERAGE	VERTICAL
3 ☺	2435.200	110.47			79.39	2.78	0.00	28.29	272	120	PEAK	VERTICAL
4 ☺	2436.200	108.25			77.18	2.78	0.00	28.29	272	120	AVERAGE	VERTICAL
5 ☺	2483.500	52.46	54.00	-1.54	21.28	2.81	0.00	28.37	272	120	AVERAGE	VERTICAL
6	2484.700	59.98	74.00	-14.02	28.80	2.81	0.00	28.37	272	120	PEAK	VERTICAL

Item 3, 4 are the fundamental frequency at 2437 MHz.

**Channel 11**

	Freq	Level	Limit Line	Over Limit	Read Level	Cable Loss	Preamp Factor	Antenna Factor	Table Pos	Ant Pos	Remark	Pol/Phase
	MHz	dBuV/m	dBuV/m	dB	dBuV	dB	dB	dB/m	deg	cm		
1 ☺	2462.800	98.99			67.86	2.80	0.00	28.33	203	100	AVERAGE	VERTICAL
2 ☺	2463.000	101.65			70.53	2.80	0.00	28.33	203	100	PEAK	VERTICAL
3 ☺	2483.500	53.91	54.00	-0.09	22.73	2.81	0.00	28.37	203	100	AVERAGE	VERTICAL
4	2483.500	58.90	74.00	-15.10	27.72	2.81	0.00	28.37	203	100	PEAK	VERTICAL

Item 1, 2 are the fundamental frequency at 2462 MHz.

Note:

Emission level (dBuV/m) = 20 log Emission level (uV/m).

Corrected Reading: Antenna Factor + Cable Loss + Read Level - Preamp Factor = Level.

**For Emission not in Restricted Band**

**Low Band Edge Plot on Configuration Drafft n MCS8 20MHz Ant. A + Ant. B / 2412 MHz**

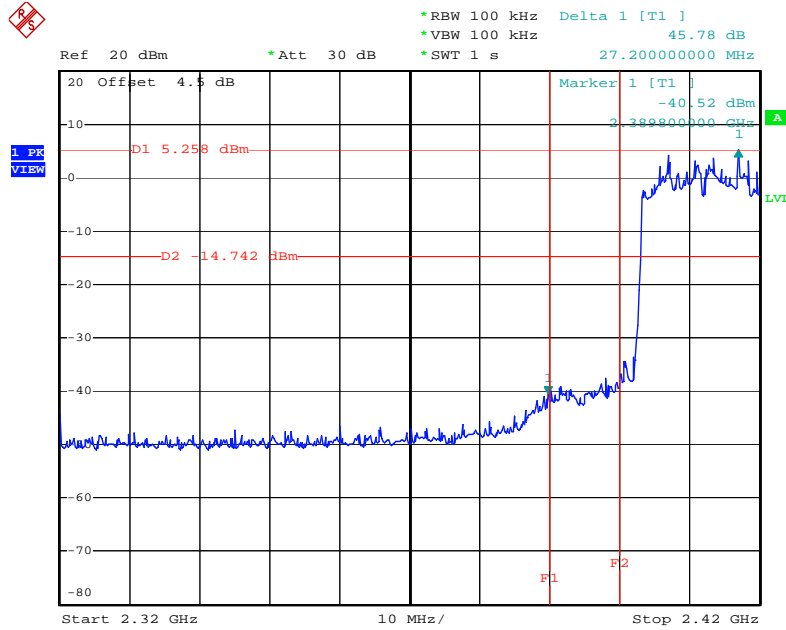

Date: 11.AUG.2009 15:29:48

**High Band Edge Plot on Configuration Drafft n MCS8 20MHz Ant. A + Ant. B / 2462 MHz**

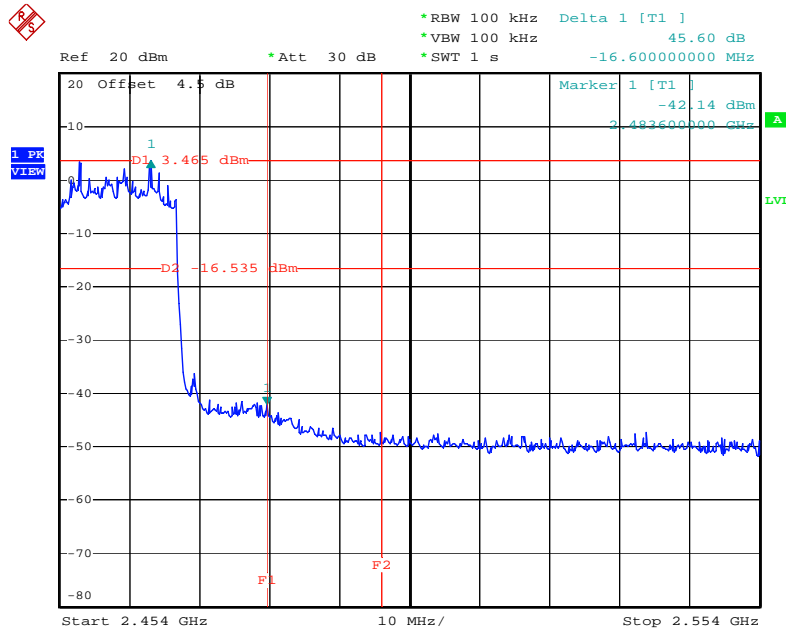

Date: 11.AUG.2009 15:35:04



For Emission not in Restricted Band

Low Band Edge Plot on Configuration Drafft n MCS8 40MHz Ant. A + Ant. B / 2422 MHz

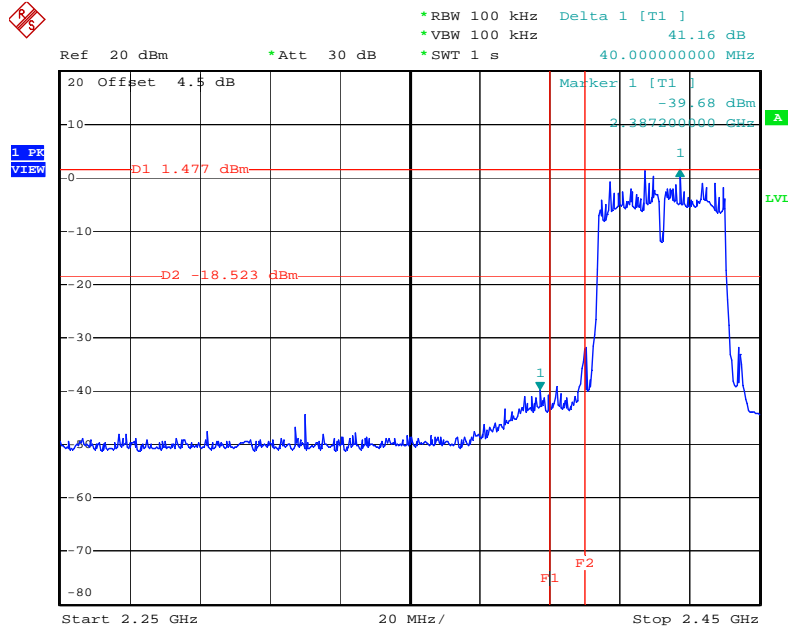

Date: 11.AUG.2009 15:43:05

High Band Edge Plot on Configuration Drafft n MCS8 40MHz Ant. A + Ant. B / 2452 MHz

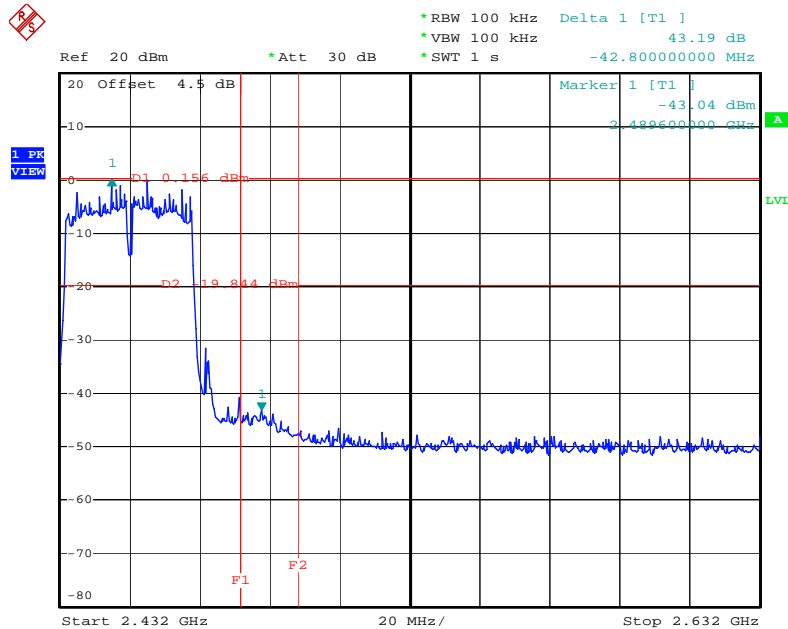

Date: 11.AUG.2009 15:39:02

### Low Band Edge Plot on Configuration IEEE 802.11b Ant. A / 2412 MHz

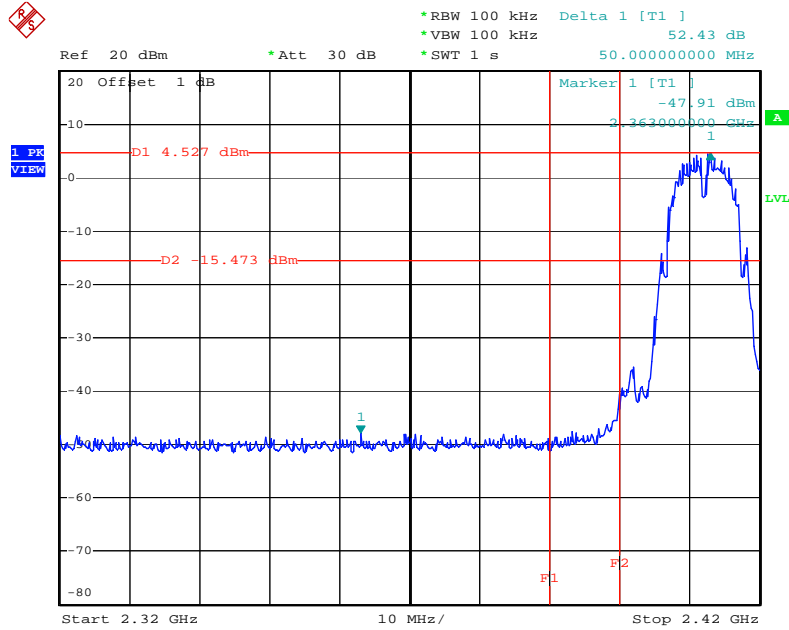

Date: 11.AUG.2009 15:05:58

### High Band Edge Plot on Configuration IEEE 802.11b Ant. A / 2462 MHz

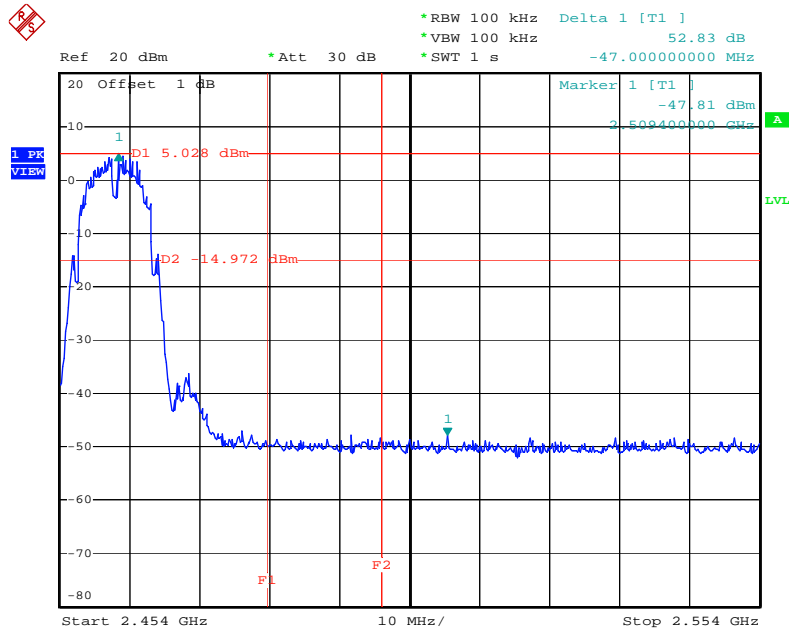

Date: 11.AUG.2009 15:11:40

### Low Band Edge Plot on Configuration IEEE 802.11g Ant. A / 2412 MHz

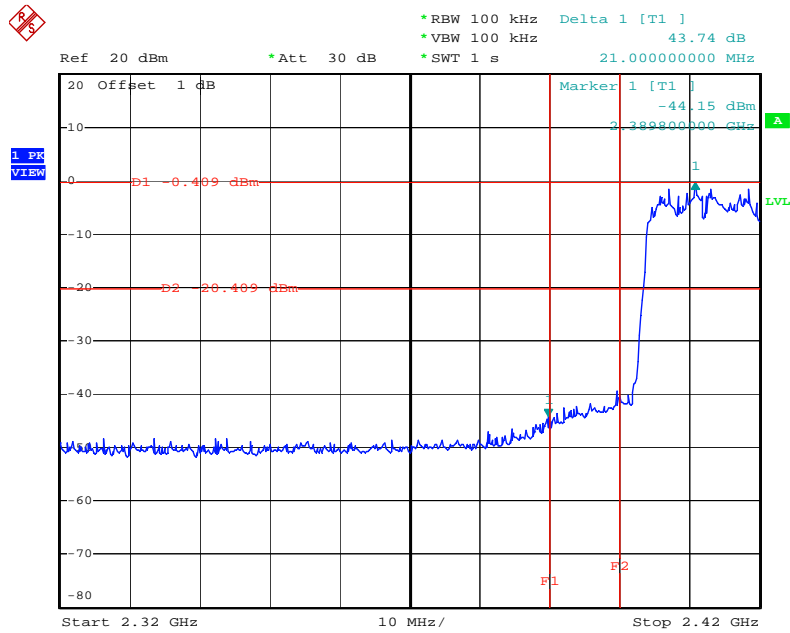

Date: 11.AUG.2009 15:22:57

### High Band Edge Plot on Configuration IEEE 802.11g Ant. A / 2462 MHz

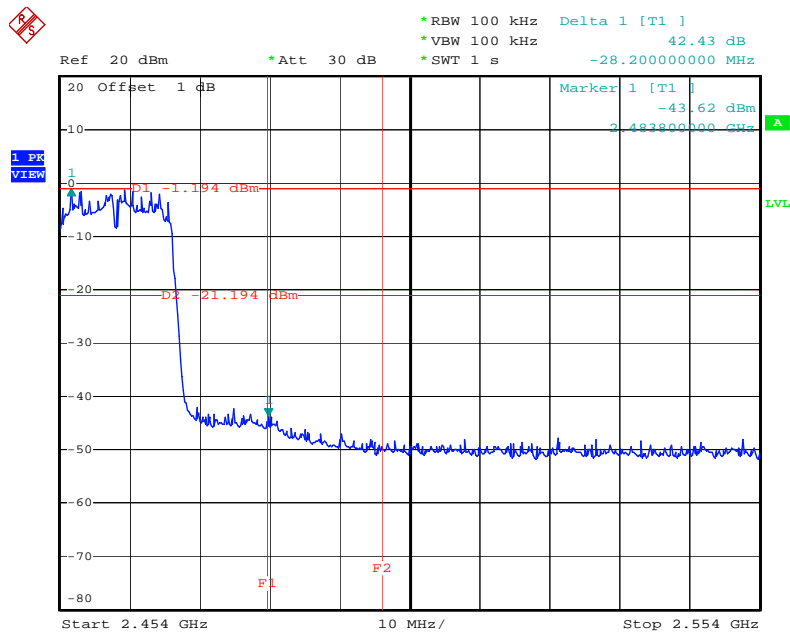

Date: 11.AUG.2009 15:14:20

## 4.7. Antenna Requirements

### 4.7.1. Limit

Except for special regulations, the Low-power Radio-frequency Devices must not be equipped with any jacket for installing an antenna with extension cable. An intentional radiator shall be designed to ensure that no antenna other than that furnished by the responsible party shall be used with the device. The use of a permanently attached antenna or of an antenna that uses a unique coupling to the intentional radiator shall be considered sufficient to comply with the provisions of this Section. The manufacturer may design the unit so that the user can replace a broken antenna, but the use of a standard antenna jack or electrical connector is prohibited. Further, this requirement does not apply to intentional radiators that must be professionally installed.

### 4.7.2. Antenna Connector Construction

Please refer to section 3.3 in this test report; antenna connector complied with the requirements.

## 5. LIST OF MEASURING EQUIPMENTS

Instrument	Manufacturer	Model No.	Serial No.	Characteristics	Calibration Date	Remark
EMC Receiver	R&S	ESCS 30	100174	9kHz – 2.75GHz	Apr. 15, 2009	Conduction (CO04-HY)
LISN	MessTec	NNB-2/16Z	99079	9kHz – 30MHz	Mar. 23, 2009	Conduction (CO04-HY)
LISN (Support Unit)	EMCO	3810/2NM	9703-1839	9kHz – 30MHz	Mar. 22, 2009	Conduction (CO04-HY)
RF Cable-CON	UTIFLEX	3102-26886-4	CB049	9kHz – 30MHz	Apr. 20, 2009	Conduction (CO04-HY)
ISN	SCHAFFNER	ISN T400	21653	9kHz – 30MHz	Jun. 11, 2009	Conduction (CO04-HY)
EMI Filter	LINDGREN	LRE-2030	2651	< 450 Hz	N/A	Conduction (CO04-HY)
3m Semi Anechoic Chamber	SIDT FRANKONIA	SAC-3M	03CH03-HY	30 MHz - 1 GHz 3m	Jun. 07, 2009	Radiation (03CH03-HY)
Amplifier	SCHAFFNER	COA9231A	18667	9 kHz - 2 GHz	Jan. 23, 2009	Radiation (03CH03-HY)
Amplifier	Agilent	8449B	3008A02120	1 GHz - 26.5 GHz	Jul. 21, 2009	Radiation (03CH03-HY)
Amplifier	MITEQ	AMF-6F-260400	9121372	26.5 GHz - 40 GHz	Apr. 06, 2009*	Radiation (03CH03-HY)
Spectrum Analyzer	R&S	FSP30	100305	9 kHz - 40 GHz	Feb. 03, 2009	Radiation (03CH03-HY)
Loop Antenna	R&S	HFH2-Z2	860004/001	9 kHz - 30 MHz	Jul. 28, 2008*	Radiation (03CH03-HY)
Bilog Antenna	SCHAFFNER	CBL 6112D	22237	30 MHz – 1 GHz	Jul. 18, 2009	Radiation (03CH03-HY)
Horn Antenna	EMCO	3115	6741	1GHz ~ 18GHz	Apr. 28, 2009	Radiation (03CH03-HY)
Horn Antenna	SCHWARZBECK	BBHA9170	BBHA9170154	15 GHz - 40 GHz	Jan.16, 2009	Radiation (03CH03-HY)
RF Cable-R03m	Jye Bao	RG142	CB021	30 MHz - 1 GHz	Jan. 05, 2009	Radiation (03CH03-HY)
RF Cable-HIGH	SUHNER	SUCOFLEX 106	03CH03-HY	1 GHz - 40 GHz	Jan. 05, 2009	Radiation (03CH03-HY)
Turn Table	HD	DS 420	420/650/00	0 – 360 degree	N/A	Radiation (03CH03-HY)
Antenna Mast	HD	MA 240	240/560/00	1 m - 4 m	N/A	Radiation (03CH03-HY)
Spectrum Analyzer	R&S	FSU26.5	100015	20Hz ~ 26.5GHz	Oct. 28, 2008	Conducted (TH01-HY)
Power Meter	R&S	NRVS	100444	DC ~ 40GHz	Jul. 31, 2009	Conducted (TH01-HY)
Power Sensor	R&S	NRV-Z51	100666	DC ~ 30GHz	Aug. 05, 2009	Conducted (TH01-HY)
Power Sensor	R&S	NRV-Z32	100057	30MHz ~ 6GHz	Jul. 31, 2009	Conducted (TH01-HY)
AC Power Source	HPC	HPA-500W	HPA-9100024	AC 0 ~ 300V	Jul. 12, 2009*	Conducted (TH01-HY)
DC Power Source	G.W.	GPC-6030D	C671845	DC 1V ~ 60V	Mar. 13, 2009	Conducted (TH01-HY)
Temp. and Humidity Chamber	Giant Force	GTH-225-20-S	MAB0103-001	N/A	Aug. 06, 2009	Conducted (TH01-HY)
RF CABLE-1m	Jye Bao	RG142	CB034-1m	20MHz ~ 7GHz	Dec. 01, 2008	Conducted (TH01-HY)
RF CABLE-2m	Jye Bao	RG142	CB035-2m	20MHz ~ 1GHz	Dec. 01, 2008	Conducted (TH01-HY)
Vector Signal Generator	R&S	SMU200A	102098	100kHz ~ 6GHz	Feb. 13, 2009	Conducted (TH01-HY)
Signal Generator	R&S	SMR40	100116	10MHz ~ 40GHz	Mar. 25, 2009	Conducted (TH01-HY)

Note: Calibration Interval of instruments listed above is one year.

Note: \*Calibration Interval of instruments listed above is two year.

## 6. TEST LOCATION

SHIJR	ADD : 6Fl., No. 106, Sec. 1, Shintai 5th Rd., Shijr City, Taipei, Taiwan 221, R.O.C. TEL : 886-2-2696-2468 FAX : 886-2-2696-2255
HWA YA	ADD : No. 52, Hwa Ya 1st Rd., Kwei-Shan Hsiang, Tao Yuan Hsien, Taiwan, R.O.C. TEL : 886-3-327-3456 FAX : 886-3-318-0055
LINKOU	ADD : No. 30-2, Dingfu Tsuen, Linkou Shiang, Taipei, Taiwan 244, R.O.C TEL : 886-2-2601-1640 FAX : 886-2-2601-1695
DUNGHU	ADD : No. 3, Lane 238, Kangle St., Neihu Chiu, Taipei, Taiwan 114, R.O.C. TEL : 886-2-2631-4739 FAX : 886-2-2631-9740
JUNGHE	ADD : 7Fl., No. 758, Jungjeng Rd., Junghe City, Taipei, Taiwan 235, R.O.C. TEL : 886-2-8227-2020 FAX : 886-2-8227-2626
NEIHU	ADD : 4Fl., No. 339, Hsin Hu 2 <sup>nd</sup> Rd., Taipei 114, Taiwan, R.O.C. TEL : 886-2-2794-8886 FAX : 886-2-2794-9777
JHUBEI	ADD : No.8, Lane 724, Bo-ai St., Jhubei City, HsinChu County 302, Taiwan, R.O.C. TEL : 886-3-656-9065 FAX : 886-3-656-9085

## 7. TAF CERTIFICATE OF ACCREDITATION



Certificate No. : L1190-070110

財團法人全國認證基金會  
Taiwan Accreditation Foundation

### Certificate of Accreditation

This is to certify that

**Sporton International Inc.**

**EMC & Wireless Communications Laboratory**

No.52, Hwa Ya 1st Rd., Hwa Ya Technology Park, Kwei-Shan Hsiang, Tao Yuan Hsien,  
Taiwan, R.O.C.

is accredited in respect of laboratory

Accreditation Criteria : ISO/IEC 17025:2005  
Accreditation Number : 1190  
Originally Accredited : December 15, 2003  
Effective Period : January 10, 2007 to January 09, 2010  
Accredited Scope : Testing Field, see described in the Appendix  
Specific Accreditation Program : Accreditation Program for Designated Testing Laboratory  
for Commodities Inspection  
: Accreditation Program for Telecommunication Equipment  
Testing Laboratory



Jay-San Chen  
President, Taiwan Accreditation Foundation  
Date : January 10, 2007

P1, total 9 pages

The Appendix forms an integral part of this Certificate, which shall be invalid when used without the Appendix.