

HCT CO., LTD.

CERTIFICATE OF COMPLIANCE FCC Certification

Applicant Name: Pantech Co.,Ltd.	Date of Issue: September 02, 2011
Address: Pantech Bldg, I-2, DMC, Sangam-dong, Mapo-gu, Seoul, 121-792, Korea	Location: HCT CO., LTD., 105-1, Jangam-ri, Majang-Myeon, Icheon-si, Kyunggi-Do, Korea
	Test Report No.: HCTR1109FR06
	HCT FRN: 0005866421

FCC ID:	JYCP4100
APPLICANT:	Pantech Co., Ltd.

FCC Model(s):	P4100
EUT Type:	GSM/WCDMA/LTE Phone with Bluetooth / WLAN
FCC Classification:	Licensed Portable Transmitter Held to Ear (PCE)
FCC Rule Part(s):	§2 , § 22 , §27
Tx Frequency:	710 MHz (LTE – Band 17), 1712.5 MHz – 1752.5 MHz (LTE – Band 4), 826.5 MHz – 846.5 MHz (LTE – Band 5)
Max. RF Output Power:	Band 17, 10 MHz : 0.106 W ERP (QPSK) (20.26 dBm) 0.118 W ERP (16-QAM) (20.75 dBm) Band 17, 5 MHz : 0.108 W ERP (QPSK) (20.34 dBm) 0.119 W ERP (16-QAM) (20.78 dBm) Band 5, 10 MHz : 0.257 W ERP (QPSK) (24.10 dBm) 0.263 W ERP (16-QAM) (24.21 dBm) Band 5, 5 MHz : 0.314 W ERP (QPSK) (24.97 dBm) 0.263 W ERP (16-QAM) (24.20 dBm) Band 4, 10 MHz : 0.603 W EIRP (QPSK) (27.81 dBm) 0.582 W EIRP (16-QAM) (27.65 dBm) Band 4, 5 MHz : 0.599 W EIRP (QPSK) (27.78 dBm) 0.628 W EIRP (16-QAM) (27.98 dBm)
Emission Designator(s):	Band 17, 10 MHz : 9M12G7D (QPSK) / 9M16W7D (16-QAM) Band 17, 5 MHz : 4M78G7D (QPSK) / 4M80W7D (16-QAM) Band 5, 10 MHz : 8M96G7D (QPSK) / 8M95W7D (16-QAM) Band 5, 5 MHz : 4M47G7D (QPSK) / 4M47W7D (16-QAM) Band 4, 10 MHz : 8M94G7D (QPSK) / 8M93W7D (16-QAM) Band 4, 5MHz : 4M46G7D (QPSK) / 4M48W7D (16-QAM)

The measurements shown in this report were made in accordance with the procedures specified in §2.947. I assume full responsibility for the accuracy and completeness of these measurements, and for the qualifications of all persons taking them.

HCT CO., LTD. Certifies that no party to this application has subject to a denial of Federal benefits that includes FCC benefits pursuant to section 5301 of the Anti-Drug Abuse Act of 1998,21 U.S. C.853(a)

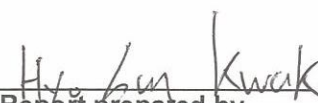
Report prepared by
: Hyo Sun Kwak
Test engineer of RF Team

Approved by
: Sang Jun Lee
Manager of RF Team

This report only responds to the tested sample and may not be reproduced, except in full, without written approval of the HCT Co., Ltd.

FCC CERTIFICATION REPORT				www.hct.co.kr
Test Report No. HCTR1109FR06	Date of Issue: September 02, 2011	EUT Type: GSM/WCDMA/LTE Phone with Bluetooth / WLAN	FCC ID: JYCP4100	Page 1 of 67

Version

TEST REPORT NO.	DATE	DESCRIPTION
HCTR1109FR06	September 02, 2011	First Approval Report

Table of Contents

1. GENERAL INFORMATION		4
2. INTRODUCTION		5
2.1. EUT DESCRIPTION.....		5
2.2. MEASURING INSTRUMENT CALIBRATION.....		5
2.3. TEST FACILITY		5
3. DESCRIPTION OF TESTS		6
3.1 EFFECTIVE RADIATED POWER/EQUIVALENT ISOTROPIC RADIATED POWER.....		6
3.2 OCCUPIED BANDWIDTH.		7
3.3 BLOCK B FREQUENCY RANGE (704 – 710 and 734 – 740 MHz).....		8
3.4 AWS – MOBILE FREQUENCY BLOCKS		8
3.5 CELLULAR – MOBILE FREQUENCY BLOCKS		8
3.6 PEAK-AVERAGE RATIO.		9
3.7 SPURIOUS AND HARMONIC EMISSIONS AT ANTENNA TERMINAL.....		9
3.8 RADIATED SPURIOUS AND HARMONIC EMISSIONS		10
3.9 FREQUENCY STABILITY / VARIATION OF AMBIENT TEMPERATURE		11
4. LIST OF TEST EQUIPMENT		12
5. SUMMARY OF TEST RESULTS		13
6. SAMPLE CALCULATION		14
7. TEST DATA		15
7.1 CONDUCTED OUTPUT POWER		15
7.2 EFFECTIVE RADIATED POWER OUTPUT		19
7.3 EQUIVALENT ISOTROPIC RADIATED POWER OUTPUT		20
7.4 RADIATED SPURIOUS EMISSIONS.....		22
7.4.1 RADIATED SPURIOUS EMISSIONS (Band 17)		22
7.4.2 RADIATED SPURIOUS EMISSIONS (Band 17)		23
7.4.3 RADIATED SPURIOUS EMISSIONS (Band 4)		24
7.4.4 RADIATED SPURIOUS EMISSIONS (Band 4)		25
7.4.5 RADIATED SPURIOUS EMISSIONS (Band 5)		26
7.4.6 RADIATED SPURIOUS EMISSIONS (Band 5)		27
7.5 FREQUENCY STABILITY / VARIATION OF AMBIENT TEMPERATURE		28
7.5.1 FREQUENCY STABILITY (LTE Band 17).....		28
7.5.2 FREQUENCY STABILITY (LTE Band 4).....		29
7.5.3 FREQUENCY STABILITY (LTE Band 5).....		30
8. TEST PLOTS.....		31



MEASUREMENT REPORT

1. GENERAL INFORMATION

Applicant Name: Pantech Co., Ltd.

Address: Pantech Bldg, I-2, DMC, Sangam-Dong, Mapo-gu, Seoul, 121-792, Korea

FCC ID: JYCP4100

Application Type: Certification

FCC Classification: Licensed Portable Transmitter Held to Ear (PCE)

FCC Rule Part(s): §2 , § 22 , §27

EUT Type: GSM/WCDMA/LTE Phone with Bluetooth / WLAN

FCC Model(s): P4100

Tx Frequency: 710 MHz (LTE – Band 17), 1712.5 MHz – 1752.5 MHz (LTE – Band 4), 826.5 MHz – 846.5 MHz (LTE – Band 5)

Max. RF Output Power:

Band 17, 10 MHz :	0.106 W ERP (QPSK) (20.26 dBm)
	0.118 W ERP (16-QAM) (20.75 dBm)
Band 17, 5 MHz :	0.108 W ERP (QPSK) (20.34 dBm)
	0.119 W ERP (16-QAM) (20.78 dBm)
Band 5, 10 MHz :	0.257 W ERP (QPSK) (24.10 dBm)
	0.263 W ERP (16-QAM) (24.21 dBm)
Band 5, 5 MHz :	0.314 W ERP (QPSK) (24.97 dBm)
	0.263 W ERP (16-QAM) (24.20 dBm)
Band 4, 10 MHz :	0.603 W EIRP (QPSK) (27.81 dBm)
	0.582 W EIRP (16-QAM) (27.65 dBm)
Band 4, 5 MHz :	0.599 W EIRP (QPSK) (27.78 dBm)
	0.628 W EIRP (16-QAM) (27.98 dBm)

Emission Designator(s):

Band 17, 10 MHz :	9M12G7D (QPSK) / 9M16W7D (16-QAM)
Band 17, 5 MHz :	4M78G7D (QPSK) / 4M80W7D (16-QAM)
Band 5, 10 MHz :	8M96G7D (QPSK) / 8M95W7D (16-QAM)
Band 5, 5 MHz :	4M47G7D (QPSK) / 4M47W7D (16-QAM)
Band 4, 10 MHz :	8M94G7D (QPSK) / 8M93W7D (16-QAM)
Band 4, 5MHz :	4M46G7D (QPSK) / 4M48W7D (16-QAM)

Date(s) of Tests: August 17, 2011 ~ August 31, 2011

Antenna Specification Manufacturer: DONGNAM Co.,Ltd
Antenna type: INTENNA Antenna
Peak Gain: 1.10 dBi

FCC CERTIFICATION REPORT				www.hct.co.kr
Test Report No. HCTR1109FR06	Date of Issue: September 02, 2011	EUT Type: GSM/WCDMA/LTE Phone with Bluetooth / WLAN	FCC ID: JYCP4100	Page 4 of 67



2. INTRODUCTION

2.1. EUT DESCRIPTION

The Pantech Co., Ltd. P4100 GSM/WCDMA/LTE Phone with Bluetooth / WLAN consists of GSM850, GSM1900, GPRS Class10, GPRS mode Class B(GPRS and GSM, but not simultaneously), EDGE, WCDMA850, WCDMA1900, HSDPA and HSUPA.

2.2. MEASURING INSTRUMENT CALIBRATION

The measuring equipment, which was utilized in performing the tests documented herein, has been calibrated in accordance with the manufacturer's recommendations for utilizing calibration equipment, which is traceable to recognized national standards.

2.3. TEST FACILITY

The SAC(Semi-Anechoic Chamber) and conducted measurement facility used to collect the radiated data are located at the 105-1, Jangam-ri, Majang-Myeon, Icheon-si, Kyunggi-Do, 467-811, Korea. The site is constructed in conformance with the requirements of ANSI C63.4 and CISPR Publication 22. Detailed description of test facility was submitted to the Commission and accepted dated March 02, 2011 (Registration Number: 90661)

FCC CERTIFICATION REPORT				www.hct.co.kr
Test Report No. HCTR1109FR06	Date of Issue: September 02, 2011	EUT Type: GSM/WCDMA/LTE Phone with Bluetooth / WLAN	FCC ID: JYCP4100	Page 5 of 67

3. DESCRIPTION OF TESTS

3.1 EFFECTIVE RADIATED POWER/EQUIVALENT ISOTROPIC RADIATED POWER

Test Set-up

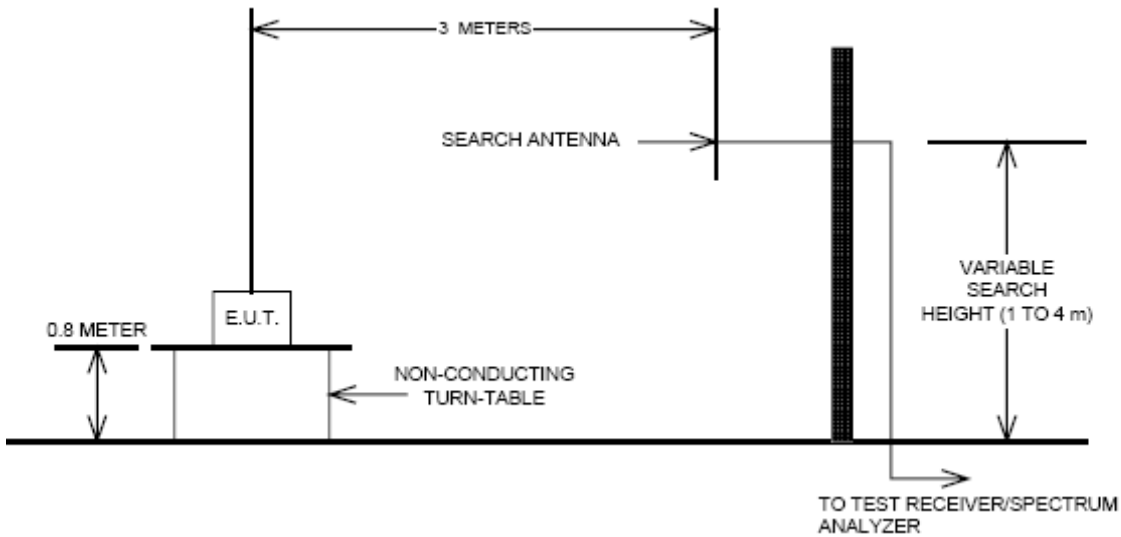

Test Procedure

Radiated emission measurements were performed at an SAC(Semi-Anechoic Chamber)

The equipment under test is placed on a non-conductive styrofoam resin table 3-meters from the receive antenna. A styrofoam turntable was rotated 360° and the receiving antenna scanned from 1-4m in order to capture the maximum emission. A half wave dipole was substituted in place of the EUT. This dipole antenna was driven by a signal generator and the previously recorded signal was duplicated.

The maximum EIRP was calculated by adding the forward power to the calibrated source plus its appropriate gain value. These steps were carried out with the receiving antenna in both vertical and horizontal polarization. For readings above 1GHz, the above procedure is repeated using horn antennas and the difference between the gain of the horn and an isotropic antenna are taken into consideration.

3.2 OCCUPIED BANDWIDTH.

Test set-up

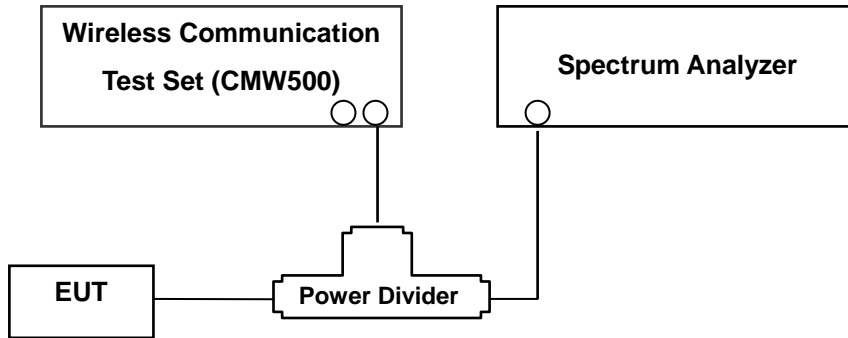

(Configuration of conducted Emission measurement)
 Test Procedure

The EUT was setup to maximum output power at its lowest channel. The occupied bandwidth was measured using a spectrum analyzer. The measurements are repeated for the highest and a middle channel. The EUT's occupied bandwidth is measured as the width of the signal between two points, one below the carrier center frequency and one above the carrier frequency, outside of which all emissions are attenuated at least 26 dB below the transmitter power. Plots of the EUT's occupied bandwidth are shown herein.

3.3 BLOCK B FREQUENCY RANGE (704 – 710 and 734 – 740 MHz)

§27.5(c)

Three paired channel blocks of 12 MHz each are available for assignment as follows : Block A: 698 – 704 MHz and 728 – 734 MHz ; Block B : 704 – 710 MHz and 734 – 740 MHz ; and Block C : 710 – 716 MHz and 740 – 746 MHz. Two unpaired channel blocks of 6 MHz each are available for assignment as follows : Block D : 716 – 722 MHz ; and Block E : 722- 728 MHz.

3.4 AWS – MOBILE FREQUENCY BLOCKS

§27.5(h)

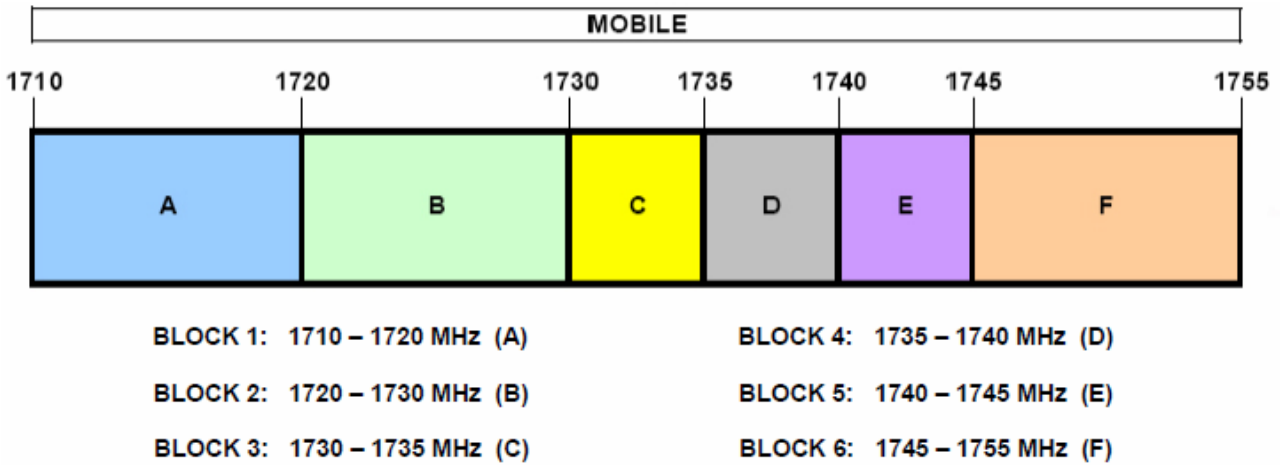

3.5 CELLULAR – MOBILE FREQUENCY BLOCKS

§22.917(a)

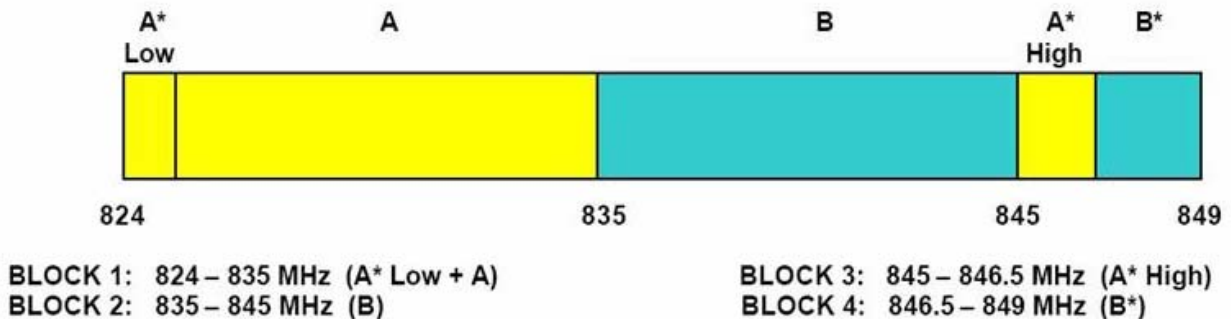



3.6 PEAK-AVERAGE RATIO.

§27.50(d)(5)

A peak to average ratio measurement is performed at the conducted port of the EUT. The spectrum analyzers Complementary Cumulative Distribution Function (CCDF) measurement profile is used to determine the largest deviation between the average and the peak power of the EUT in a given bandwidth. The CCDF curve shows how much time the peak waveform spends at or above a given average power level. The percent of time the signal spends at or above the level defines the probability for that particular power level.

3.7 SPURIOUS AND HARMONIC EMISSIONS AT ANTENNA TERMINAL.

Test Procedure

The level of the carrier and the various conducted spurious and harmonic frequencies is measured by means of a calibrated spectrum analyzer.

The EUT was setup to maximum output power at its lowest channel. The Resolution BW of the analyzer is set to 1 % of the emission bandwidth to show compliance with the – 13 dBm limit, in the 1 MHz bands immediately outside and adjacent to the edge of the frequency block. The 1 MHz RBW was used to scan from 30 MHz to 26.5 GHz. A display line was placed at – 13 dBm to show compliance. The high, lowest and a middle channel were tested for out of band measurements.

- Band Edge Requirement : In the 1MHz bands immediately outside and adjacent to the frequency block, a resolution bandwidth of at least 1 percent of the emission bandwidth of the fundamental emission of the transmitter may be employed to measure the out of band Emissions. Limit, -13dBm.

FCC CERTIFICATION REPORT				www.hct.co.kr
Test Report No. HCTR1109FR06	Date of Issue: September 02, 2011	EUT Type: GSM/WCDMA/LTE Phone with Bluetooth / WLAN	FCC ID: JYCP4100	Page 9 of 67

3.8 RADIATED SPURIOUS AND HARMONIC EMISSIONS

Test Set-up

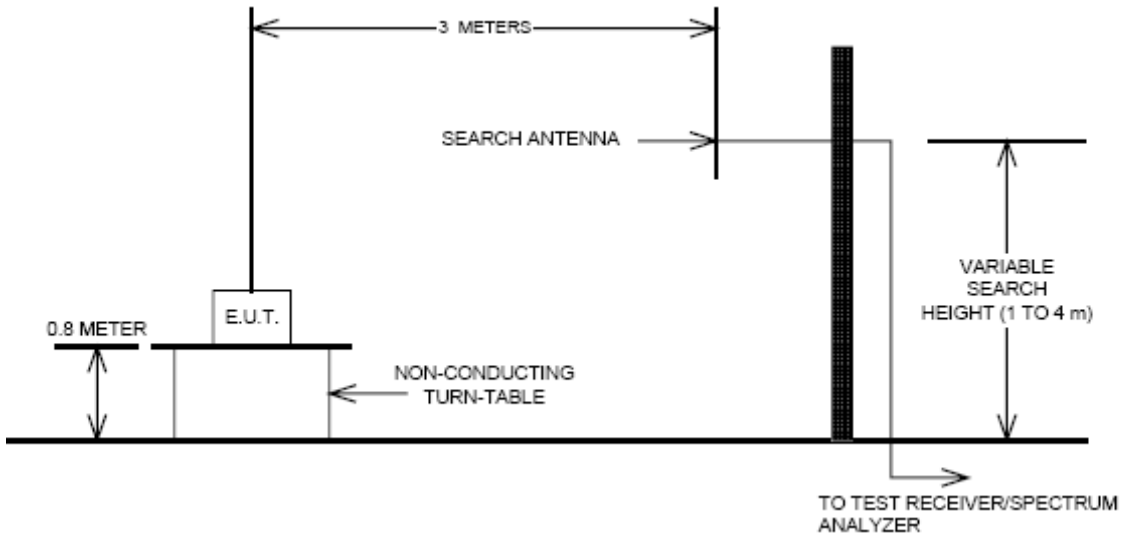

The measurement facilities used for this test have been documented in previous filings with the commission pursuant to section § 2.948. The SAC(Semi-Anechoic Chamber) meets requirements in ANSI C63.4 –2003. A mast capable of lifting the receiving antenna from a height of one to four meters is used together with a rotatable styrofoam platform mounted at three from the antenna mast.

- 1) The unit mounted on a styrofoam turntable 1.5 m × 1.0 m × 0.80 m is 0.8 meter above test site ground level.
- 2) During the emission test, the turntable is rotated and the EUT is manipulated to find the configuration resulting in maximum emission under normal condition of installation and operation.
- 3) The antenna height and polarization are also varied from 1 to 4 meters until the maximum signal is found.
- 4) The spectrum shall be scanned up to the 10th harmonic of the fundamental frequency.

Test Procedure

The equipment under test is placed on a non-conductive styrofoam resin table 3-meters from the receive antenna. A styrofoam turntable was rotated 360° and the receiving antenna scanned from 1-4m in order to capture the maximum emission. A half wave dipole was substituted in place of the EUT. This dipole antenna was driven by a signal generator and the previously recorded signal was duplicated.

The maximum EIRP was calculated by adding the forward power to the calibrated source plus its appropriate gain value. These steps were carried out with the receiving antenna in both vertical and horizontal polarization. For readings above 1GHz, the above procedure is repeated using horn antennas and the difference between the gain of the horn and an isotropic antenna are taken into consideration.

3.9 FREQUENCY STABILITY / VARIATION OF AMBIENT TEMPERATURE

Test Set-up

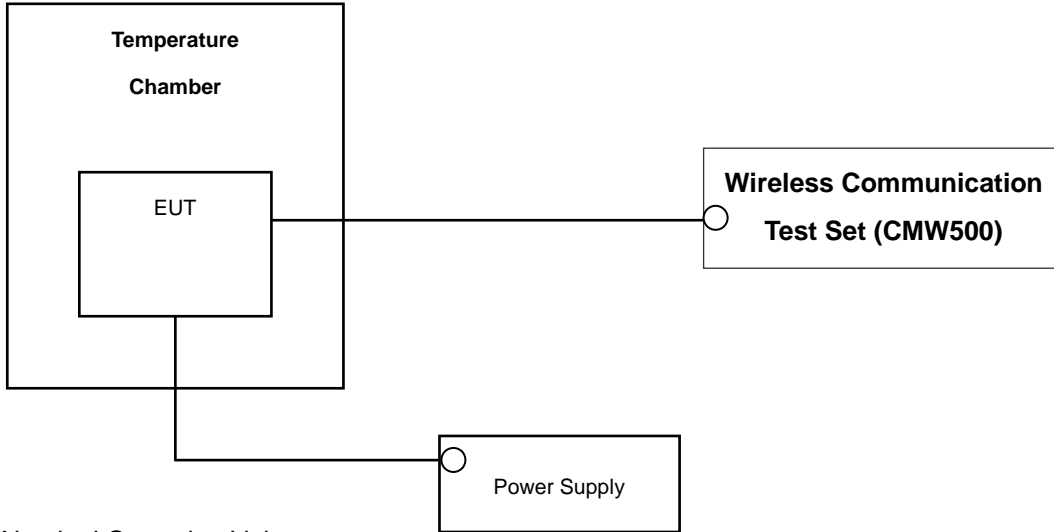

* Nominal Operating Voltage

Test Procedure

The frequency stability of the transmitter is measured by:

a.) **Temperature:** The temperature is varied from - 30 °C to + 50 °C using an environmental chamber.

b.) **Primary Supply Voltage:** The primary supply voltage is varied from battery end point to 115 % of the voltage normally at the input to the device or at the power supply terminals if cables are not normally supplied.

Specification — the frequency stability shall be sufficient to ensure that the fundamental emission stays within the authorized frequency block. The frequency stability of the transmitter shall be maintained within $\pm 0.00025\%$ (± 2.5 ppm) of the center frequency.

Time Period and Procedure:

The carrier frequency of the transmitter is measured at room temperature (20°C to provide a reference).

1. The equipment is turned on in a “standby” condition for one minute before applying power to the transmitter. Measurement of the carrier frequency of the transmitter is made within one minute after applying power to the transmitter.

2. Frequency measurements are made at 10°C intervals ranging from -30°C to +50°C. A period of at least one half-hour is provided to allow stabilization of the equipment at each temperature level.

NOTE: The EUT is tested down to the battery endpoint.

4. LIST OF TEST EQUIPMENT

Manufacture	Model/ Equipment	Serial Number	Calibration Interval	Calibration Due
R&S	N9020A	MY51110020	Annual	04/16/2012
Agilent	E4416A/ Power Meter	GB41291412	Annual	01/04/2012
Agilent	E9327A/ Power Sensor	MY4442009	Annual	05/02/2012
R&S	CMW500/ Base Station	1201.0002K50_10395	Annual	04/20/2012
MITEQ	AMF-6D-001180-35-20P/AMP	990893	Annual	05/02/2012
Wainwright	WHK1.2/15G-10EF/H.P.F	2	Annual	05/02/2012
Wainwright	WHK3.3/18G-10EF/H.P.F	1	Annual	05/02/2012
Agilent	775D/ Dual Directional Coupler	12922	Annual	12/29/2011
Agilent	11636B/ Power Divider	11377	Annual	12/29/2011
Digital	EP-3010/ Power Supply	3110117	Annual	01/04/2012
Schwarzbeck	UHAP/ Dipole Antenna	949	Biennial	03/18/2012
Schwarzbeck	UHAP/ Dipole Antenna	950	Biennial	03/18/2012
Korea Engineering	KR-1005L / Chamber	KRAB07063-2CH	Annual	12/28/2011
Schwarzbeck	BBHA 9120D/ Horn Antenna	296	Biennial	09/23/2011
Schwarzbeck	BBHA 9120D/ Horn Antenna	147	Biennial	04/13/2012
Agilent	E4440A/Spectrum Analyzer	US45303008	Annual	05/12/2012
Rohde & Schwarz	FSP30 / Spectrum Analyzer	839117/011	Annual	03/23/2012

5. SUMMARY OF TEST RESULTS

FCC Part Section(s)	Test Description	Test Limit	Test Condition	Test Result
2.1049, 22.917(a) 27.53(h)(1)	Occupied Bandwidth	N/A	CONDUCTED	PASS
2.1051, 22.917(a) 27.53(h)	Band Edge / Spurious and Harmonic Emissions at Antenna Terminal.	$< 43 + 10 \log_{10} (P[\text{Watts}])$ at Band Edge and for all-of-band emissions		PASS
27.50(d)(5)	Peak-Average Ratio	$< 13 \text{ dB}$		PASS
2.1046	Conducted Output Power	N/A		PASS
2.1055, 22.355 27.54	Frequency stability / variation of ambient temperature	$< 2.5 \text{ ppm}$		PASS
22.913(a)(2) 27.50(c)(10)	Effective Radiated Power	$< 3 \text{ Watts max. ERP}$	RADIATED	PASS
27.50(d)(4)	Equivalent Isotropic Radiated Power	$< 1 \text{ Watts max. EIRP}$		
2.1053, 22.917(a) 27.53(h), 27.53(g)	Undesirable Out-of-Band Emissions	$< 43 + 10 \log_{10} (P[\text{Watts}])$ for all out-of-band emissions		PASS

6. SAMPLE CALCULATION

A. ERP Sample Calculation

Mode	Ch./ Freq.		Measured Level(dBm)	Substitute LEVEL(dBm)	Ant. Gain	C.L	Pol.	ERP	
	channel	Freq.(MHz)						W	dBm
LTE	23230	782	-11.56	34.28	-8.32	1.17	H	0.30	24.79

ERP = SubstituteLEVEL(dBm) + Ant. Gain – CL(Cable Loss)

- 1) The EUT mounted on a wooden tripod is 0.8 meter above test site ground level.
- 2) During the test , the turn table is rotated and the antenna height is also varied from 1 to 4 meters until the maximum signal is found.
- 3) Record the field strength meter's level.
- 4) Replace the EUT with dipole/Horn antenna that is connected to a calibrated signal generator.
- 5) Increase the signal generator output till the field strength meter's level is equal to the item (3).
- 6) The signal generator output level with Ant. Gain and cable loss are the rating of effective radiated power (**ERP**).

B. Emission Designator

QPSK Modulation

Emission Designator = 8M95G7D

LTE BW = 8.95 MHz

G = Phase Modulation

7 = Quantized/Digital Info

D = Amplitude/Angle Modulated

16QAM Modulation

Emission Designator = 8M94W7D

LTE BW = 8.94 MHz

D = Amplitude/Angle Modulated

7 = Quantized/Digital Info

W = Combination (Audio/Data)

7. TEST DATA

7.1 CONDUCTED OUTPUT POWER

A base station simulator was used to establish communication with the EUT. The base station simulator parameters were set to produce the maximum power from the EUT. This device was tested under all configurations and the highest power is reported. Conducted Output Powers of EUT are reported below.

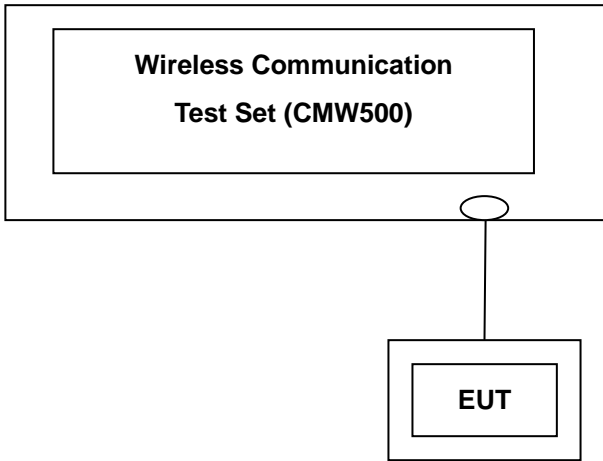

Test Result

Band	Frequency(Mhz)	Channel	Resource Block Size	Resource Block Offset	Average Power [dBm]	
					QPSK	16-QAM
LTE	710	23790	1	0	23.31	21.85
			1	49	23.02	22.01
			25	13	21.87	21.05
			50	0	21.77	21.10

LTE Conducted Average Output Powers (10 MHz Band 17 LTE)

Band	Frequency(Mhz)	Channel	Resource Block Size	Resource Block Offset	Average Power [dBm]	
					QPSK	16-QAM
LTE	1715	20000	1	0	22.74	22.00
			1	49	22.78	22.15
			25	13	22.76	21.89
			50	0	22.80	21.84

LTE Conducted Average Output Powers (10 MHz Band 4 LTE – Low Channel)

Band	Frequency(Mhz)	Channel	Resource Block Size	Resource Block Offset	Average Power [dBm]	
					QPSK	16-QAM
LTE	1730	20175	1	0	23.25	21.88
			1	49	23.03	21.87
			25	13	21.90	21.06
			50	0	22.04	21.19

LTE Conducted Average Output Powers (10 MHz Band 4 LTE – Mid Channel)

Band	Frequency(Mhz)	Channel	Resource Block Size	Resource Block Offset	Average Power [dBm]	
					QPSK	16-QAM
LTE	1750	20350	1	0	23.26	22.01
			1	49	23.25	22.03
			25	13	21.94	21.06
			50	0	22.21	21.39

LTE Conducted Average Output Powers (10 MHz Band 4 LTE – High Channel)

Band	Frequency(Mhz)	Channel	Resource Block Size	Resource Block Offset	Average Power [dBm]	
					QPSK	16-QAM
LTE	829.00	20450	1	0	22.84	21.70
			1	49	22.85	21.74
			25	13	22.16	21.27
			50	0	21.81	21.05

LTE Conducted Average Output Powers (10 MHz Band 5 LTE – Low Channel)

Band	Frequency(Mhz)	Channel	Resource Block Size	Resource Block Offset	Average Power [dBm]	
					QPSK	16-QAM
LTE	836.50	20525	1	0	23.04	21.89
			1	49	22.83	21.73
			25	13	21.66	20.90
			50	0	22.22	21.30

LTE Conducted Average Output Powers (10 MHz Band 5 LTE – Mid Channel)

Band	Frequency(Mhz)	Channel	Resource Block Size	Resource Block Offset	Average Power [dBm]	
					QPSK	16-QAM
LTE	844.00	20600	1	0	23.23	22.12
			1	49	23.00	21.77
			25	13	21.87	20.91
			50	0	21.92	21.13

LTE Conducted Average Output Powers (10 MHz Band 5 LTE – High Channel)

Band	Frequency(Mhz)	Channel	Resource Block Size	Resource Block Offset	Average Power [dBm]	
					QPSK	16-QAM
LTE	710	23790	1	0	22.64	21.50
			1	24	22.76	21.67
			12	6	22.06	21.17
			25	0	21.86	20.81

LTE Conducted Average Output Powers (5 MHz Band 17 LTE)

Band	Frequency(Mhz)	Channel	Resource Block Size	Resource Block Offset	Average Power [dBm]	
					QPSK	16-QAM
LTE	1712.5	19975	1	0	23.09	22.27
			1	24	23.10	22.11
			12	6	21.98	20.91
			25	0	22.16	21.11

LTE Conducted Average Output Powers (5 MHz Band 4 LTE – Low Channel)

Band	Frequency(Mhz)	Channel	Resource Block Size	Resource Block Offset	Average Power [dBm]	
					QPSK	16-QAM
LTE	1732.5	20175	1	0	23.20	22.17
			1	24	23.17	22.07
			12	6	21.92	20.85
			25	0	22.10	21.09

LTE Conducted Average Output Powers (5 MHz Band 4 LTE – Mid Channel)

Band	Frequency(Mhz)	Channel	Resource Block Size	Resource Block Offset	Average Power [dBm]	
					QPSK	16-QAM
LTE	1752.5	20375	1	0	23.24	22.08
			1	24	23.21	22.19
			12	6	21.81	20.82
			25	0	22.21	21.24

LTE Conducted Average Output Powers (5 MHz Band 4 LTE – High Channel)

Band	Frequency(Mhz)	Channel	Resource Block Size	Resource Block Offset	Average Power [dBm]	
					QPSK	16-QAM
LTE	826.5	20425	1	0	22.84	21.95
			1	24	22.89	22.14
			12	6	21.82	20.81
			25	0	21.98	21.10

LTE Conducted Average Output Powers (5 MHz Band 5 LTE – Low Channel)

Band	Frequency(Mhz)	Channel	Resource Block Size	Resource Block Offset	Average Power [dBm]	
					QPSK	16-QAM
LTE	836.50	20525	1	0	22.93	21.94
			1	24	22.72	22.27
			12	6	21.97	20.92
			25	0	21.92	21.23

LTE Conducted Average Output Powers (5 MHz Band 5 LTE – Mid Channel)

Band	Frequency(Mhz)	Channel	Resource Block Size	Resource Block Offset	Average Power [dBm]	
					QPSK	16-QAM
LTE	846.50	20625	1	0	22.76	22.33
			1	24	22.53	21.98
			12	6	21.98	20.98
			25	0	21.96	20.91

LTE Conducted Average Output Powers (5 MHz Band 5 LTE – High Channel)

Note : Detecting mode is average.

7.2 EFFECTIVE RADIATED POWER OUTPUT

Freq (MHz)	Bandwidth	Modulation	Measured Level (dBm)	Substitute Level (dBm)	Ant. Gain(dBd)	C.L	Pol	ERP	
								W	dBm
710.00	10 MHz	QPSK	-16.73	31.82	-10.12	1.44	V	0.11	20.26
	10 MHz	16-QAM	-16.24	32.31	-10.12	1.44	V	0.12	20.75
	5 MHz	QPSK	-16.65	31.90	-10.12	1.44	V	0.11	20.34
	5 MHz	16-QAM	-16.21	32.34	-10.12	1.44	V	0.12	20.78

Effective Radiated Power Data (Band 17)

Note: Worst case is 1 resource block.

NOTES:

Effective Radiated Power Output Measurements by Substitution Method

according to ANSI/TIA/EIA-603-C-2004, Aug. 17, 2004:

The EUT was placed on a non-conductive styrofoam resin table 3-meters from the receive antenna. The receive antenna height and turntable rotation was adjusted for the highest reading on the receive spectrum analyzer. For 1 MHz BW signals, a peak detector is used, with RBW = VBW = 1 MHz. For 10 MHz BW signals, a peak detector is used, with RBW = VBW = 10 MHz. A half-wave dipole was substituted in place of the EUT. This dipole antenna was driven by a signal generator and the level of the signal generator was adjusted to obtain the same receive spectrum analyzer reading. The conducted power at the terminals of the dipole is measured. The ERP is recorded.

Also, we have done x, y, z planes in EUT and horizontal and vertical polarization in detecting antenna. The worst case of the EUT is x plane in LTE mode. Also worst case of detecting Antenna is horizontal polarization in LTE mode.

7.3 EQUIVALENT ISOTROPIC RADIATED POWER OUTPUT

Freq (MHz)	Bandwidth	Modulation	Measured Level (dBm)	Substitute Level (dBm)	Ant. Gain(dBi)	C.L	Pol	ERP	
								W	dBm
1715.00	10 MHz	QPSK	-14.81	18.62	9.98	2.69	H	0.39	25.91
		16-QAM	-14.86	18.57	9.98	2.69	H	0.39	25.86
1732.50		QPSK	-12.96	20.45	10.06	2.70	H	0.60	27.81
		16-QAM	-13.12	20.29	10.06	2.70	H	0.58	27.65
1750.00		QPSK	-13.24	20.14	10.14	2.68	H	0.57	27.59
		16-QAM	-13.21	20.17	10.14	2.68	H	0.58	27.62

Equivalent Isotropic Radiated Power Output Data (Band 4 – 10 MHz)

Freq (MHz)	Bandwidth	Modulation	Measured Level (dBm)	Substitute Level (dBm)	Ant. Gain(dBd)	C.L	Pol	ERP	
								W	dBm
1712.50	5 MHz	QPSK	-13.64	19.79	9.98	2.69	H	0.51	27.08
		16-QAM	-13.92	19.51	9.98	2.69	H	0.48	26.80
1732.50		QPSK	-12.99	20.42	10.06	2.70	H	0.60	27.78
		16-QAM	-12.79	20.62	10.06	2.70	H	0.63	27.98
1752.50		QPSK	-13.70	19.68	10.14	2.68	H	0.52	27.13
		16-QAM	-14.03	19.35	10.14	2.68	H	0.48	26.80

Equivalent Isotropic Radiated Power Output Data (Band 4 – 5 MHz)

Note: Worst case is 1 resource block.

NOTES:

Effective Radiated Power Output Measurements by Substitution Method

according to ANSI/TIA/EIA-603-C-2004, Aug. 17, 2004:

The EUT was placed on a non-conductive styrofoam resin table 3-meters from the receive antenna. The receive antenna height and turntable rotation was adjusted for the highest reading on the receive spectrum analyzer. For 1 MHz BW signals, a peak detector is used, with RBW = VBW = 1 MHz. For 10 MHz BW signals, a peak detector is used, with RBW = VBW = 10 MHz. A half-wave dipole was substituted in place of the EUT. This dipole antenna was driven by a signal generator and the level of the signal generator was adjusted to obtain the same receive spectrum analyzer reading. The conducted power at the terminals of the Horn antenna is measured. The difference between the gain of the horn and an isotropic antenna is taken into consideration and the EIRP is recorded.

Also, we have done x, y, z planes in EUT and horizontal and vertical polarization in detecting antenna. The worst case of the EUT is x plane in LTE mode. Also worst case of detecting Antenna is horizontal polarization in LTE mode.

Freq (MHz)	Bandwidth	Modulation	Measured Level (dBm)	Substitute Level (dBm)	Ant. Gain(dBi)	C.L	Pol	ERP	
								W	dBm
829.00	10 MHz	QPSK	-16.08	32.85	-10.54	1.61	H	0.12	20.70
		16-QAM	-16.12	32.81	-10.54	1.61	H	0.12	20.66
836.50		QPSK	-12.65	36.27	-10.50	1.67	H	0.26	24.10
		16-QAM	-12.54	36.38	-10.50	1.67	H	0.26	24.21
844.00		QPSK	-16.45	32.61	-10.47	1.64	H	0.11	20.50
		16-QAM	-16.43	32.63	-10.47	1.64	H	0.11	20.52

Equivalent Isotropic Radiated Power Output Data (Band 5 – 10 MHz)

Freq (MHz)	Bandwidth	Modulation	Measured Level (dBm)	Substitute Level (dBm)	Ant. Gain(dBd)	C.L	Pol	ERP	
								W	dBm
826.50	5 MHz	QPSK	-14.70	34.23	-10.54	1.61	V	0.16	22.08
		16-QAM	-14.79	34.14	-10.54	1.61	V	0.16	21.99
836.60		QPSK	-11.78	37.14	-10.50	1.67	V	0.31	24.97
		16-QAM	-12.55	36.37	-10.50	1.67	V	0.26	24.20
846.50		QPSK	-14.39	34.67	-10.47	1.64	V	0.18	22.56
		16-QAM	-14.53	34.53	-10.47	1.64	V	0.17	22.42

Equivalent Isotropic Radiated Power Output Data (Band 5 – 5 MHz)

Note: Worst case is 1 resource block.

NOTES:

Effective Radiated Power Output Measurements by Substitution Method

according to ANSI/TIA/EIA-603-C-2004, Aug. 17, 2004:

The EUT was placed on a non-conductive styrofoam resin table 3-meters from the receive antenna. The receive antenna height and turntable rotation was adjusted for the highest reading on the receive spectrum analyzer. For 1 MHz BW signals, a peak detector is used, with RBW = VBW = 1 MHz. For 10 MHz BW signals, a peak detector is used, with RBW = VBW = 10 MHz. A half-wave dipole was substituted in place of the EUT. This dipole antenna was driven by a signal generator and the level of the signal generator was adjusted to obtain the same receive spectrum analyzer reading. The conducted power at the terminals of the Horn antenna is measured. The difference between the gain of the horn and an isotropic antenna is taken into consideration and the EIRP is recorded.

Also, we have done x, y, z planes in EUT and horizontal and vertical polarization in detecting antenna. The worst case of the EUT is z plane (10 MHz x plane) in LTE mode. Also worst case of detecting Antenna is vertical polarization (10 MHz in horizontal polarization) LTE mode.

7.4 RADIATED SPURIOUS EMISSIONS

7.4.1 RADIATED SPURIOUS EMISSIONS (Band 17)

- ▣ OPERATING FREQUENCY : 710.00 MHz
- ▣ MEASURED OUTPUT POWER: 20.75 dBm = 0.118W
- ▣ MODULATION SIGNAL: 10 MHz 16-QAM
- ▣ DISTANCE: 3 meters
- ▣ LIMIT: - (43 + 10 log₁₀ (W)) = - 33.75 dBc

Ch	Freq (MHz)	Measured Level (dBm)	Ant. Gain (dBd)	Substitute Level (dBm)	C.L	Pol	ERP (dBm)	dBc
23790 (710.00)	1420.00	-43.93	7.69	-52.48	2.44	H	-47.23	-67.98
	2130.00	-30.16	10.61	-37.23	3.24	H	-29.86	-50.61
	2840.00	-	-	-	-	-	-	-

- NOTES:**
1. Radiated Spurious Emission Measurements at 3 meters by Substitution Method according to ANSI/TIA/EIA-603-C-2004, Aug. 17, 2004:
 2. The magnitude of spurious emissions attenuated more than 20dB below the limit above 5th Harmonic for all channel.
 3. we have done x, y, z planes in EUT and horizontal and vertical polarization in detecting antenna.
 4. Worst case is 1 resource block.

7.4.2 RADIATED SPURIOUS EMISSIONS (Band 17)

- ▣ OPERATING FREQUENCY : 710.00 MHz
- ▣ MEASURED OUTPUT POWER: 20.78 dBm = 0.119W
- ▣ MODULATION SIGNAL: 5 MHz 16-QAM
- ▣ DISTANCE: 3 meters
- ▣ LIMIT: - (43 + 10 log₁₀ (W)) = - 33.78 dBc

Ch	Freq (MHz)	Measured Level (dBm)	Ant. Gain (dBd)	Substitute Level (dBm)	C.L	Pol	ERP (dBm)	dBc
23790 (710.00)	1420.00	-48.58	7.69	-57.13	2.44	H	-51.88	-72.66
	2130.00	-42.32	10.61	-49.39	3.24	H	-42.02	-62.80
	2840.00							

- NOTES:**
1. Radiated Spurious Emission Measurements at 3 meters by Substitution Method according to ANSI/TIA/EIA-603-C-2004, Aug. 17, 2004:
 2. The magnitude of spurious emissions attenuated more than 20dB below the limit above 5th Harmonic for all channel.
 3. we have done x, y, z planes in EUT and horizontal and vertical polarization in detecting antenna.
 4. Worst case is 1 resource block.

7.4.3 RADIATED SPURIOUS EMISSIONS (Band 4)

- ▣ OPERATING FREQUENCY : 1732.50 MHz
- ▣ MEASURED OUTPUT POWER: 27.81 dBm = 0.603W
- ▣ MODULATION SIGNAL: 10 MHz QPSK
- ▣ DISTANCE: 3 meters
- ▣ LIMIT: - (43 + 10 log₁₀ (W)) = - 40.81 dBc

Ch	Freq (MHz)	Measured Level (dBm)	Ant. Gain (dBd)	Substitute Level (dBm)	C.L	Pol	ERP (dBm)	dBc
20000 (1715.00)	3430.00	-42.35	12.09	-50.30	5.14	H	-43.35	-71.16
	5145.00	-49.14	12.49	-49.49	6.34	H	-43.34	-71.15
	6860.00	-	-	-	-	-	-	-
20175 (1732.50)	3465.00	-47.04	12.12	-55.70	4.56	H	-48.14	-75.95
	5197.50	-	-	-	-	-	-	-
	6930.00	-	-	-	-	-	-	-
20350 (1750.00)	3500.00	-46.46	12.22	-53.91	5.07	H	-46.76	-74.57
	5250.00	-47.37	12.52	-49.07	6.32	H	-42.87	-70.68
	7000.00	-	-	-	-	-	-	-

- NOTES:**
1. Radiated Spurious Emission Measurements at 3 meters by Substitution Method according to ANSI/TIA/EIA-603-C-2004, Aug. 17, 2004:
 2. The magnitude of spurious emissions attenuated more than 20dB below the limit above 5th Harmonic for all channel.
 3. we have done x, y, z planes in EUT and horizontal and vertical polarization in detecting antenna.
 4. Worst case is 1 resource block.

7.4.4 RADIATED SPURIOUS EMISSIONS (Band 4)

- ▣ OPERATING FREQUENCY : 1732.50 MHz
- ▣ MEASURED OUTPUT POWER: 27.98 dBm = 0.628W
- ▣ MODULATION SIGNAL: 5 MHz 16-QAM
- ▣ DISTANCE: 3 meters
- ▣ LIMIT: - (43 + 10 log₁₀ (W)) = - 40.98 dBc

Ch	Freq (MHz)	Measured Level (dBm)	Ant. Gain (dBd)	Substitute Level (dBm)	C.L	Pol	ERP (dBm)	dBc
20000 (1715.00)	3430.00	-46.94	12.09	-54.89	5.14	H	-47.94	-75.92
	5145.00	-49.46	12.49	-49.81	6.34	H	-43.66	-71.64
	6860.00	-	-	-	-	-	-	-
20175 (1732.50)	3465.00	-45.89	12.12	-54.55	4.56	H	-46.99	-74.97
	5197.50	-44.43	12.50	-45.29	6.54	H	-39.33	-67.31
	6930.00	-	-	-	-	-	-	-
20350 (1750.00)	3500.00	-46.47	12.22	-53.92	5.07	H	-46.77	-74.75
	5250.00	-49.55	12.52	-51.25	6.32	H	-45.05	-73.03
	7000.00	-	-	-	-	-	-	-

- NOTES:**
1. Radiated Spurious Emission Measurements at 3 meters by Substitution Method according to ANSI/TIA/EIA-603-C-2004, Aug. 17, 2004:
 2. The magnitude of spurious emissions attenuated more than 20dB below the limit above 5th Harmonic for all channel.
 3. we have done x, y, z planes in EUT and horizontal and vertical polarization in detecting antenna.
 4. Worst case is 1 resource block.

7.4.5 RADIATED SPURIOUS EMISSIONS (Band 5)

- ▣ OPERATING FREQUENCY : 836.50 MHz
- ▣ MEASURED OUTPUT POWER: 24.21 dBm = 0.263W
- ▣ MODULATION SIGNAL: 10 MHz 16-QAM
- ▣ DISTANCE: 3 meters
- ▣ LIMIT: - (43 + 10 log₁₀ (W)) = - 37.21 dBc

Ch	Freq (MHz)	Measured Level (dBm)	Ant. Gain (dBd)	Substitute Level (dBm)	C.L	Pol	ERP (dBm)	dBc
20450 (829.00)	1,658.00	-48.10	9.66	-58.43	2.63	H	-51.40	-75.61
	2,487.00	-35.67	10.79	-43.51	3.55	H	-36.27	-60.48
	3,316.00	-51.10	11.76	-59.47	4.79	V	-52.50	-76.71
20525 (836.50)	1,673.00	-46.92	9.77	-57.32	2.67	H	-50.22	-74.43
	2,509.50	-31.81	10.82	-39.72	3.61	H	-32.51	-56.72
	3,346.00	-50.83	11.87	-59.56	4.94	V	-52.63	-76.84
20600 (844.00)	1,688.00	-45.95	9.94	-56.78	2.61	H	-49.45	-73.66
	2,532.00	-32.63	10.84	-40.97	3.60	H	-33.73	-57.94
	3,376.00	-49.66	11.98	-58.43	4.11	V	-50.56	-74.77

- NOTES:**
1. Radiated Spurious Emission Measurements at 3 meters by Substitution Method according to ANSI/TIA/EIA-603-C-2004, Aug. 17, 2004:
 2. The magnitude of spurious emissions attenuated more than 20dB below the limit above 5th Harmonic for all channel.
 3. we have done x, y, z planes in EUT and horizontal and vertical polarization in detecting antenna.
 4. Worst case is 1 resource block.

7.4.6 RADIATED SPURIOUS EMISSIONS (Band 5)

- ▣ OPERATING FREQUENCY : 846.50 MHz
- ▣ MEASURED OUTPUT POWER: 24.97 dBm = 0.314W
- ▣ MODULATION SIGNAL: 5 MHz QPSK
- ▣ DISTANCE: 3 meters
- ▣ LIMIT: - (43 + 10 log₁₀ (W)) = - 37.97 dBc

Ch	Freq (MHz)	Measured Level (dBm)	Ant. Gain (dBd)	Substitute Level (dBm)	C.L	Pol	ERP (dBm)	dBc
20425 (826.50)	1,653.00	-46.67	9.66	-57.00	2.63	H	-49.97	-74.94
	2,479.50	-33.38	10.79	-41.22	3.55	H	-33.98	-58.95
	3,306.00	-50.53	11.76	-58.90	4.79	V	-51.93	-76.90
20525 (836.50)	1,673.00	-40.71	9.77	-51.11	2.67	H	-44.01	-68.98
	2,509.50	-30.12	10.82	-38.03	3.61	H	-30.82	-55.79
	3,346.00	-51.03	11.87	-59.76	4.94	V	-52.83	-77.80
20625 (846.50)	1,693.00	-45.88	9.94	-56.71	2.61	H	-49.38	-74.35
	2,539.50	-30.75	10.84	-39.09	3.60	H	-31.85	-56.82
	3,386.00	-50.12	11.98	-58.89	4.11	V	-51.02	-75.99

- NOTES:**
1. Radiated Spurious Emission Measurements at 3 meters by Substitution Method according to ANSI/TIA/EIA-603-C-2004, Aug. 17, 2004:
 2. The magnitude of spurious emissions attenuated more than 20dB below the limit above 5th Harmonic for all channel.
 3. we have done x, y, z planes in EUT and horizontal and vertical polarization in detecting antenna.
 4. Worst case is 1 resource block.

7.5 FREQUENCY STABILITY / VARIATION OF AMBIENT TEMPERATURE

7.5.1 FREQUENCY STABILITY (LTE Band 17)

OPERATING FREQUENCY: 710,000,000 Hz
 CHANNEL: 23790
 REFERENCE VOLTAGE: 3.7 VDC
 DEVIATION LIM IT: ± 0.000 25 % or 2.5 ppm

Voltage (%)	Power (VDC)	Temp. (°C)	Frequency (Hz)	Frequency Error (Hz)	Deviation (%)	ppm
100%	3.700	+20(Ref)	709 999 986	0	0.000 000	0.000
100%		-30	709 999 983	-3.71	-0.000 001	-0.005
100%		-20	709 999 978	-8.48	-0.000 001	-0.012
100%		-10	709 999 985	-1.42	0.000 000	-0.002
100%		0	709 999 990	4.06	0.000 001	0.006
100%		+10	710 000 000	13.43	0.000 002	0.019
100%		+30	710 000 009	22.77	0.000 003	0.032
100%		+40	709 999 963	-23.12	-0.000 003	-0.033
100%		+50	710 000 015	28.31	0.000 004	0.040
115%		4.255	+20	709 999 977	-9.47	-0.000 001
Batt. Endpoint	3.400	+20	709 999 960	-26.66	-0.000 004	-0.038

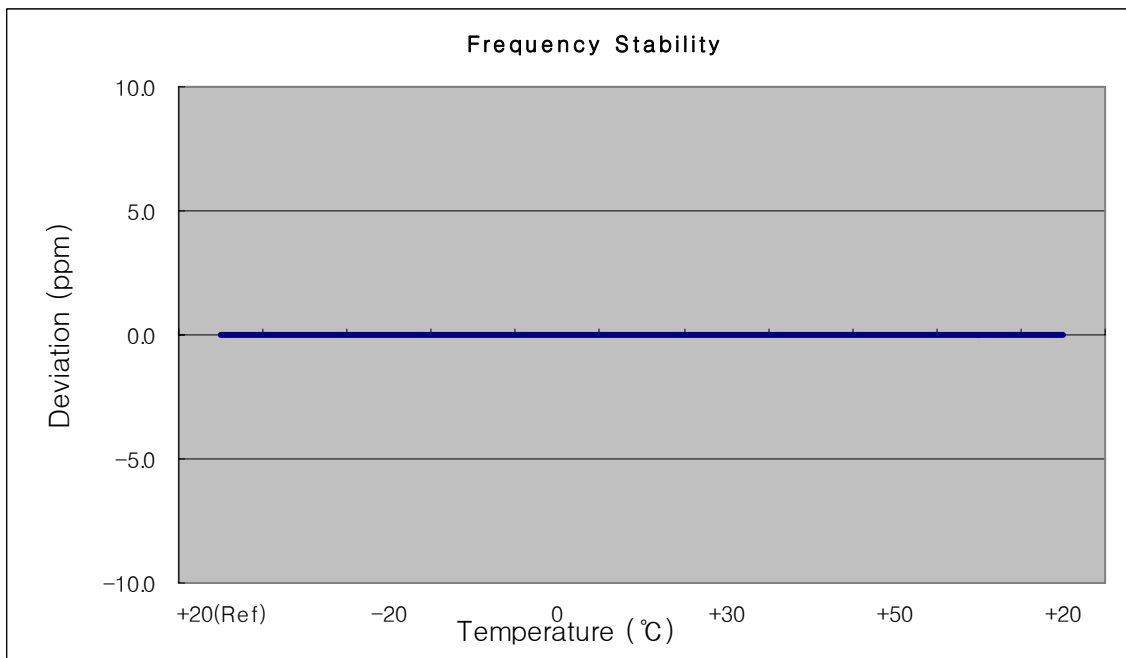

7.5.2 FREQUENCY STABILITY (LTE Band 4)

OPERATING FREQUENCY: 1732,500,000 Hz
 CHANNEL: 20175
 REFERENCE VOLTAGE: 3.70 VDC
 DEVIATION LIM IT: ± 0.000 25 % or 2.5 ppm

Voltage (%)	Power (VDC)	Temp. (°C)	Frequency (Hz)	Frequency Error (Hz)	Deviation (%)	ppm
100%	3.700	+20(Ref)	1732 500 009	0	0.000 000	0.000
100%		-30	1732 500 040	31.43	0.000 002	0.018
100%		-20	1732 500 040	31.45	0.000 002	0.018
100%		-10	1732 500 041	32.47	0.000 002	0.019
100%		0	1732 499 964	-44.98	-0.000 003	-0.026
100%		+10	1732 499 999	-9.53	-0.000 001	-0.006
100%		+30	1732 500 002	-6.84	0.000 000	-0.004
100%		+40	1732 499 943	-65.39	-0.000 004	-0.038
100%		+50	1732 500 036	27.55	0.000 002	0.016
115%		4.255	+20	1732 500 040	31.24	0.000 002
Batt. Endpoint	3.400	+20	1732 499 981	-27.47	-0.000 002	-0.016

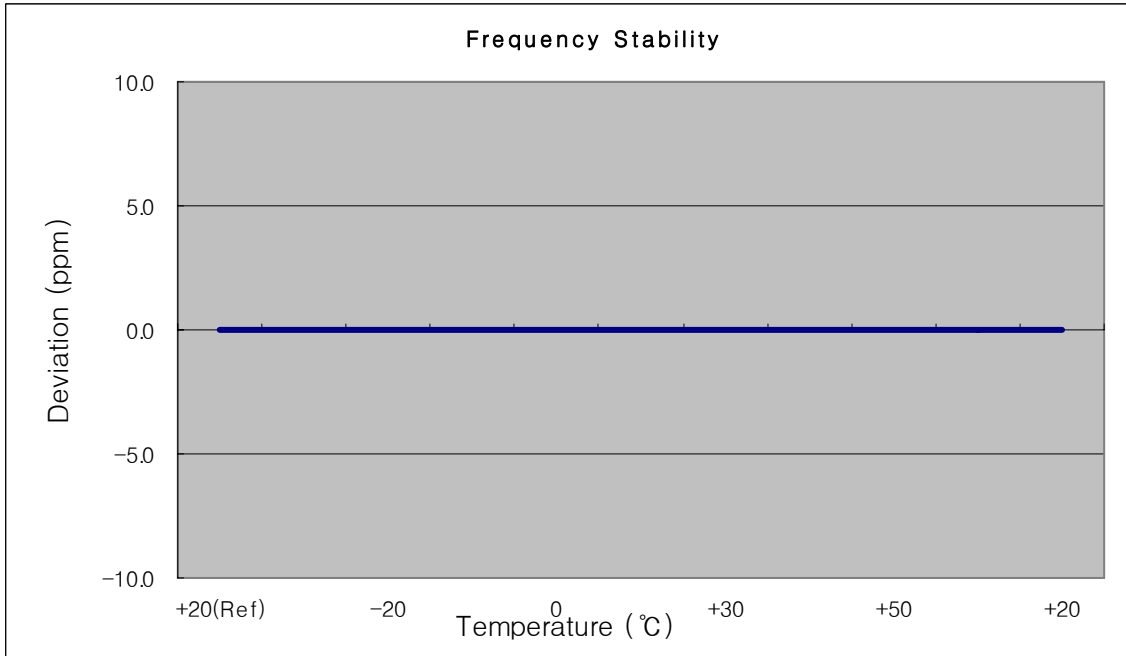

7.5.3 FREQUENCY STABILITY (LTE Band 5)

OPERATING FREQUENCY: 836,500,000 Hz
 CHANNEL: 20525
 REFERENCE VOLTAGE: 3.70 VDC
 DEVIATION LIM IT: ± 0.000 25 % or 2.5 ppm

Voltage (%)	Power (VDC)	Temp. (°C)	Frequency (Hz)	Frequency Error (Hz)	Deviation (%)	ppm
100%	3.700	+20(Ref)	836 500 007	0	0.000 000	0.000
100%		-30	836 500 014	7.52	0.000 001	0.009
100%		-20	836 500 001	-5.56	-0.000 001	-0.007
100%		-10	836 500 025	18.00	0.000 002	0.022
100%		0	836 500 033	26.38	0.000 003	0.032
100%		+10	836 499 994	-12.39	-0.000 001	-0.015
100%		+30	836 500 037	30.61	0.000 004	0.037
100%		+40	836 500 022	14.98	0.000 002	0.018
100%		+50	836 499 991	-15.81	-0.000 002	-0.019
115%		4.255	+20	836 500 015	8.48	0.000 001
Batt. Endpoint	3.400	+20	836 499 992	-14.58	-0.000 002	-0.017

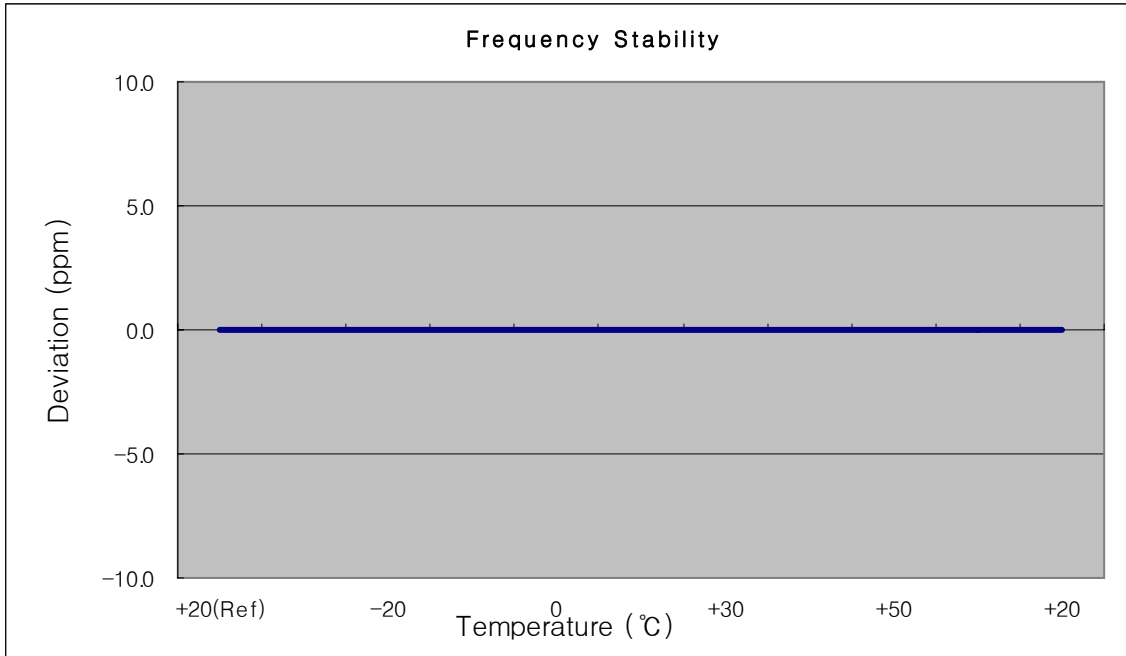

8. TEST PLOTS

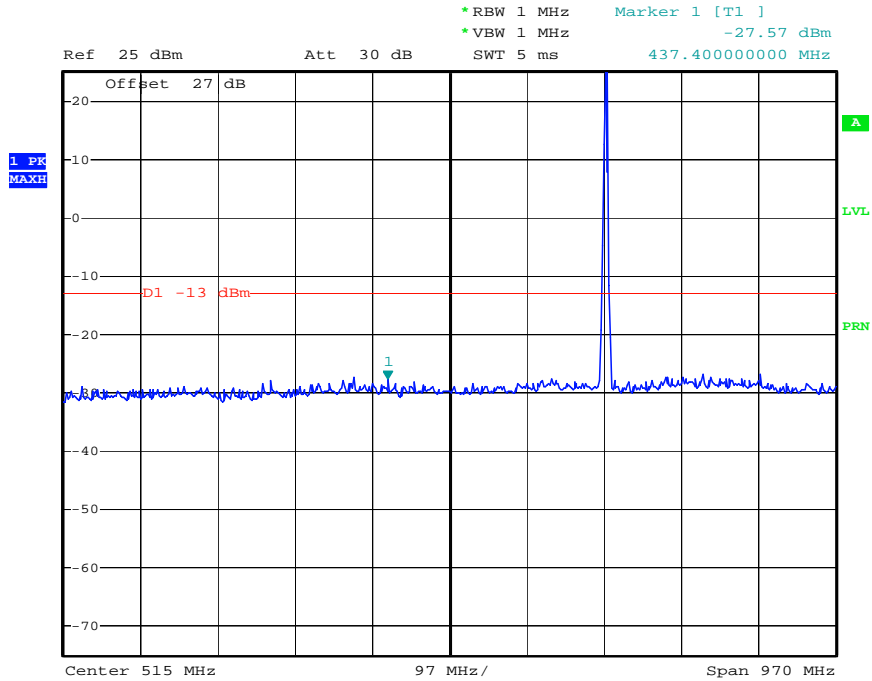

Date: 30.AUG.2011 10:17:11

Conducted Spurious Plot (10 MHz BW, QPSK, Band 17 -710 MHz)

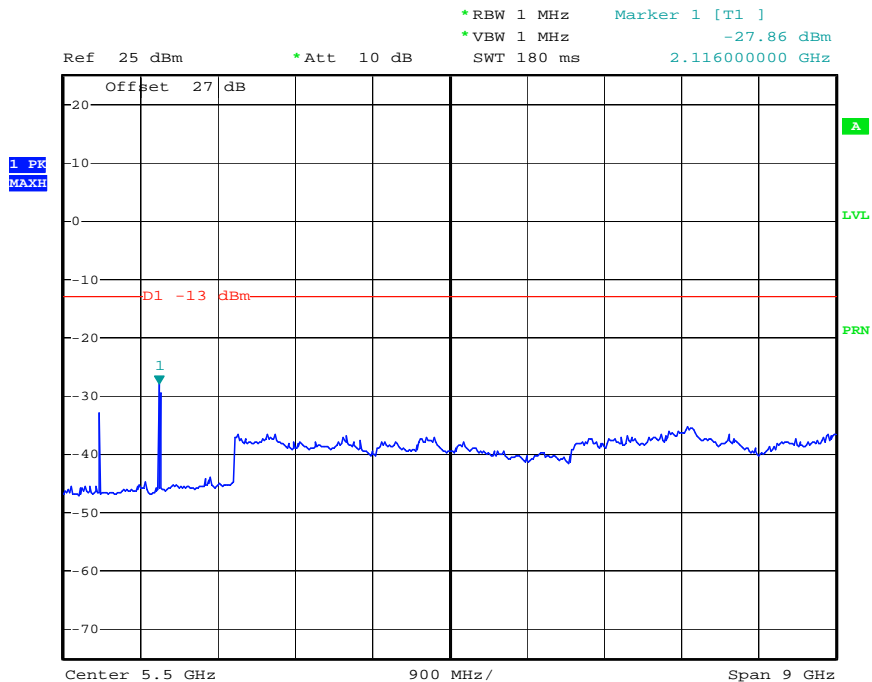

Date: 30.AUG.2011 10:35:24

Conducted Spurious Plot (10 MHz BW, QPSK, Band 17 -710 MHz)

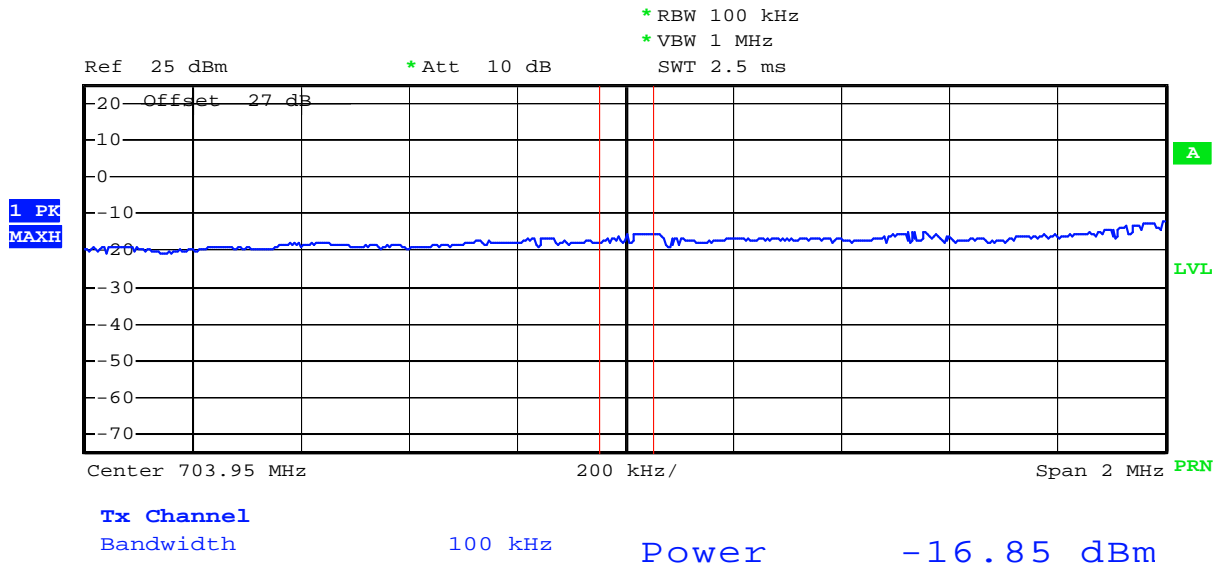

Date: 30.AUG.2011 11:23:35

Lower Band Edge Plot (10MHz BW, QPSK, Band 17)

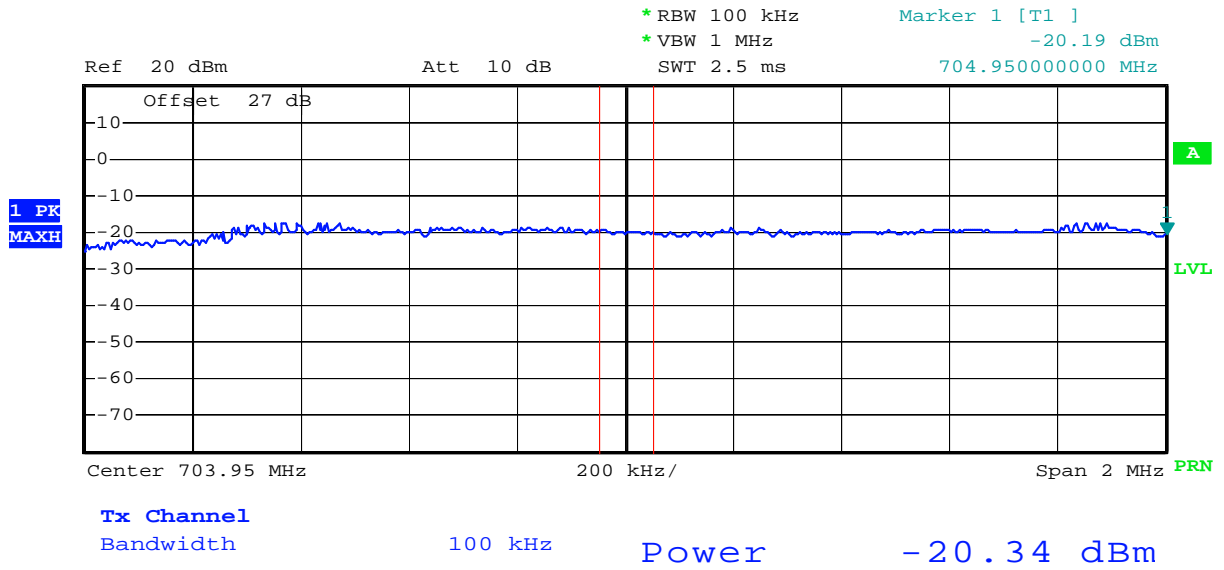

Date: 30.AUG.2011 11:41:01

Lower Band Edge Plot (5 MHz BW, QPSK, Band 17)

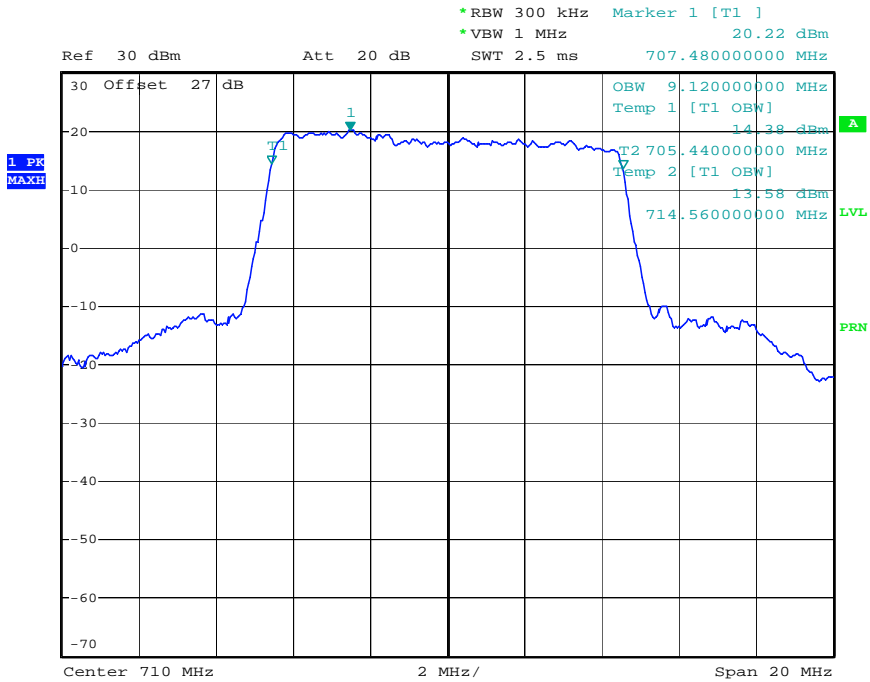

Date: 30.AUG.2011 11:29:52

Occupied Bandwidth Plot (10MHz BW, QPSK, Band 17)

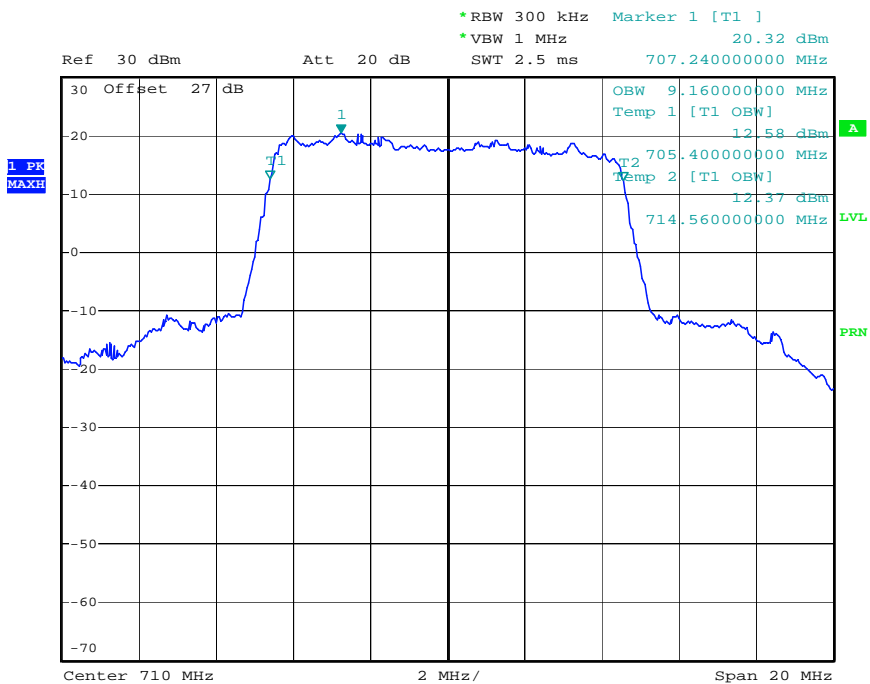

Date: 30.AUG.2011 11:32:13

Occupied Bandwidth Plot (10MHz BW, 16-QAM, Band 17)

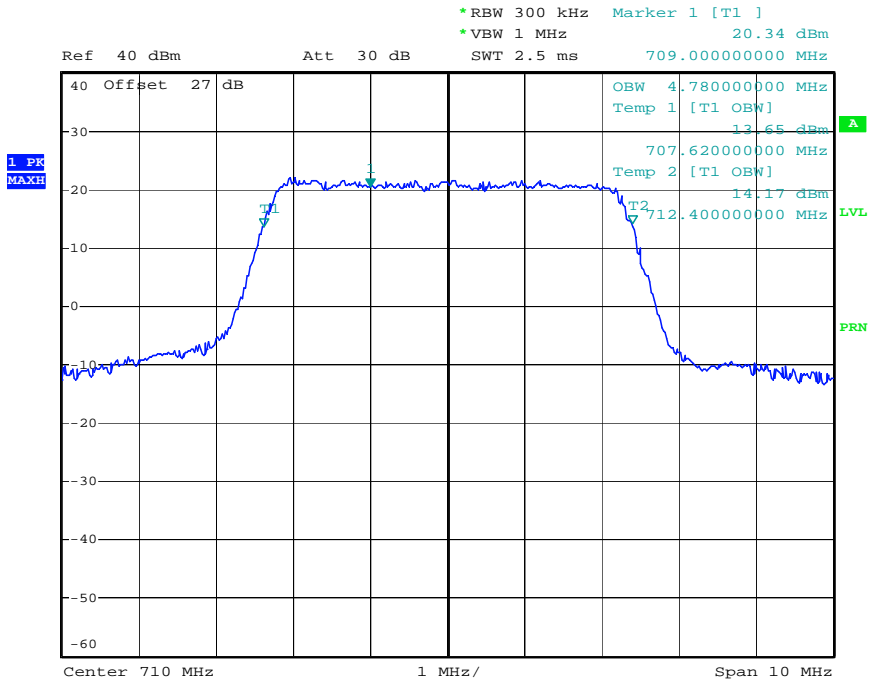

Date: 30.AUG.2011 12:43:47

Occupied Bandwidth Plot (5 MHz BW, QPSK, Band 17)

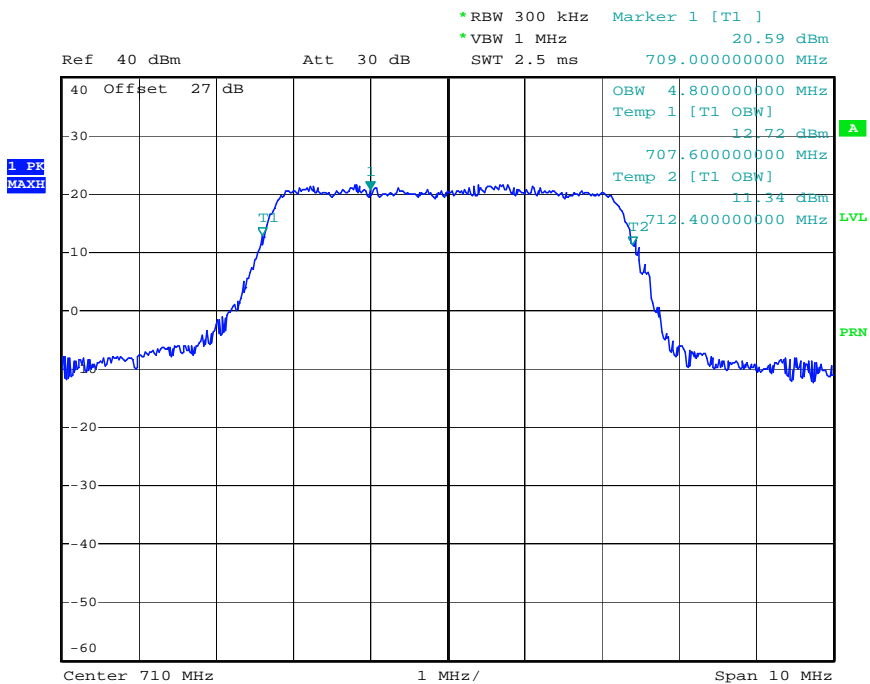

Date: 30.AUG.2011 12:45:30

Occupied Bandwidth Plot (5 MHz BW, 16-QAM, Band 17)

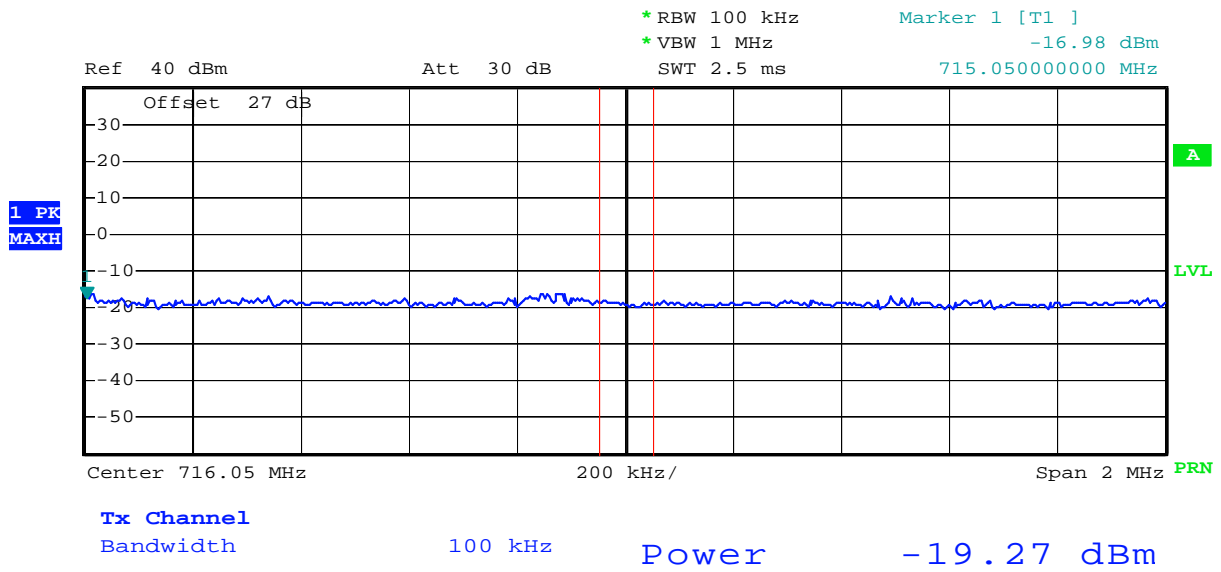

Date: 30.AUG.2011 12:50:43

Upper Band Edge Plot (10MHz BW, 16-QAM, Band 17)

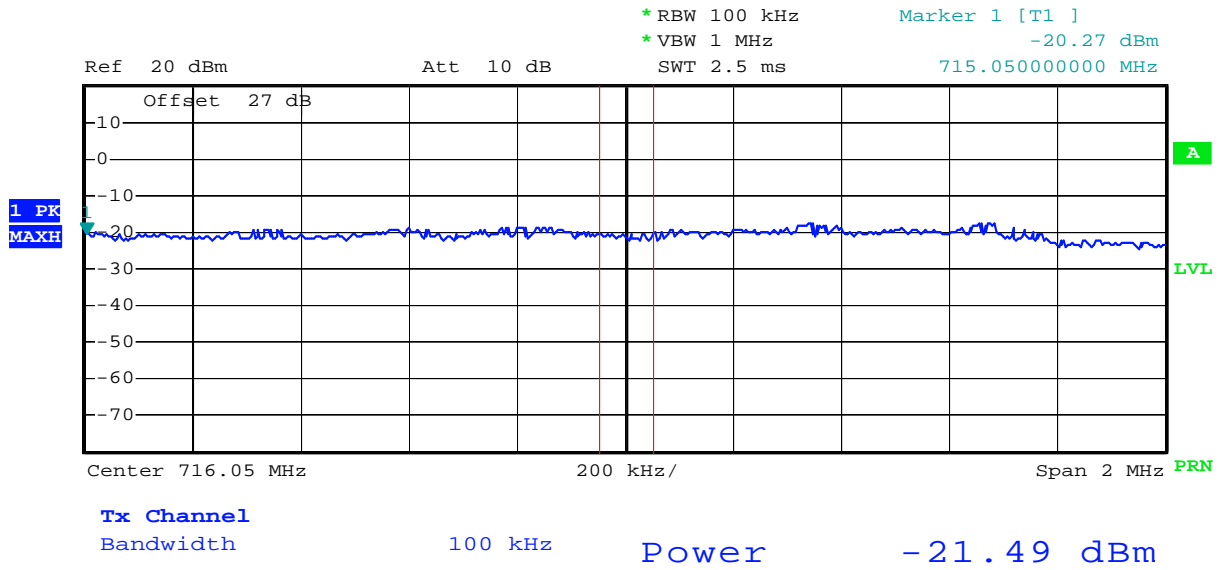

Date: 30.AUG.2011 11:40:14

Upper Band Edge Plot (5 MHz BW, 16-QAM, Band 17)

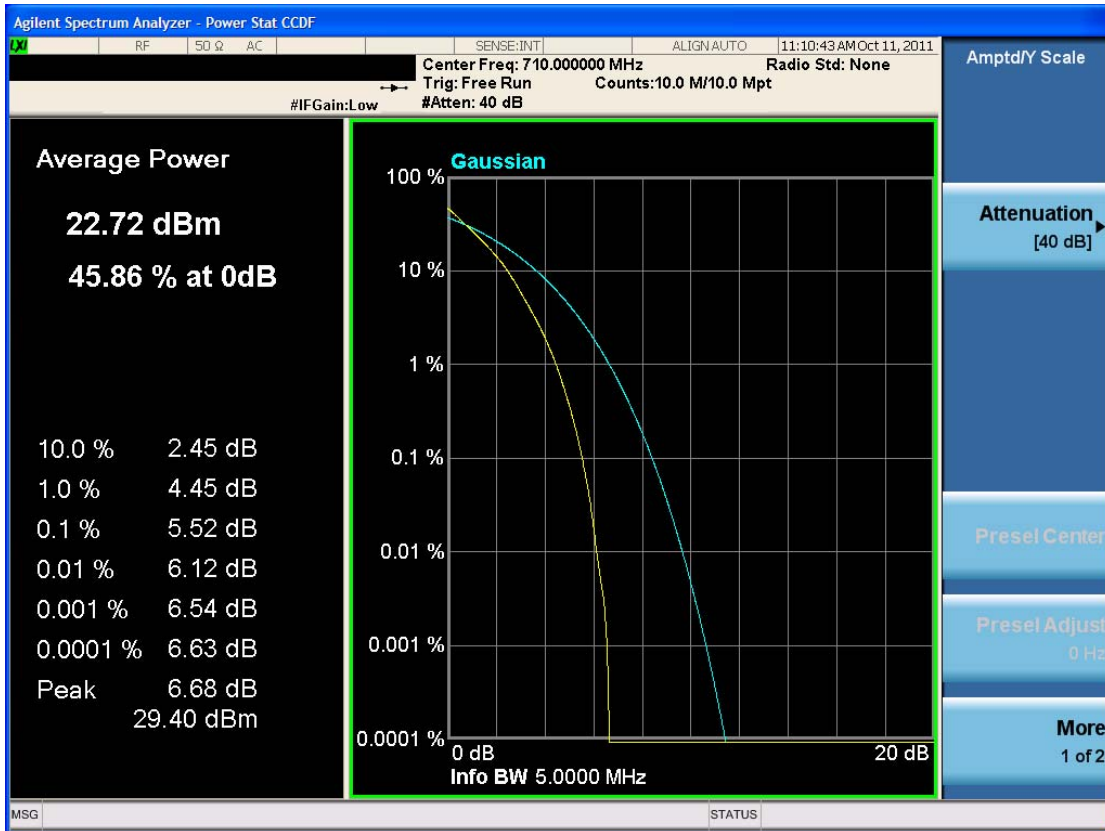

Peak-Average Ratio Plot (5 MHz BW, QPSK, Band 17 – Mid Channel)



Peak-Average Ratio Plot (5 MHz BW, 16QAM, Band 17 – Mid Channel)

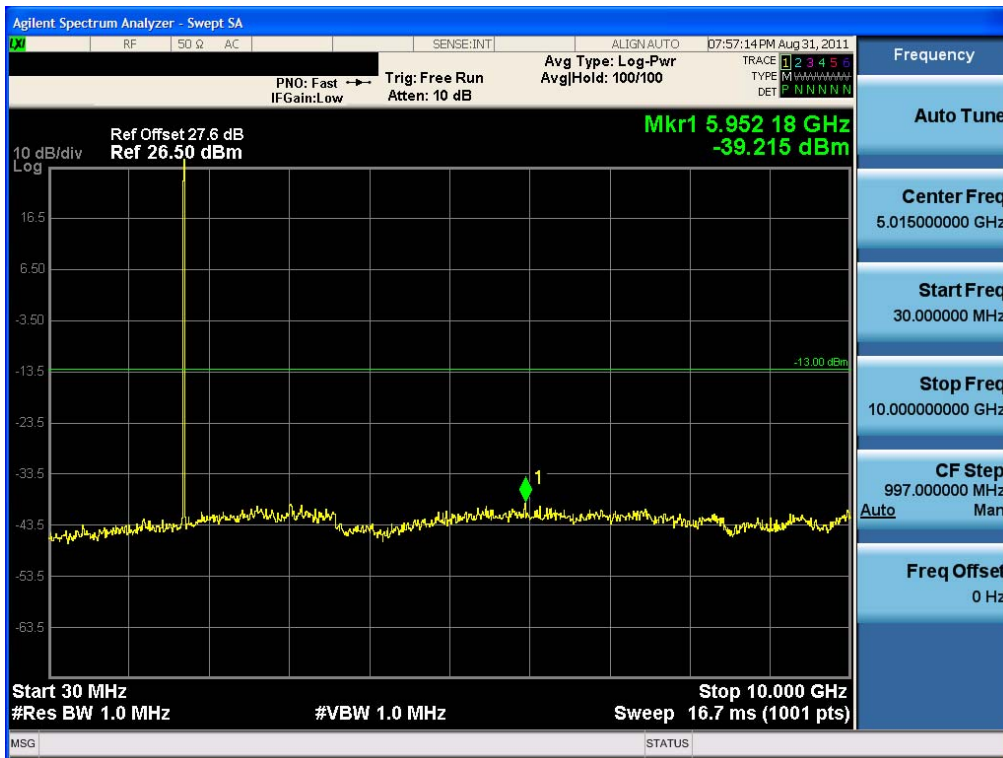

Conducted Spurious Plot (5 MHz BW, 16-QAM, Band 4 – Low Channel)



Conducted Spurious Plot (5 MHz BW, 16-QAM, Band 4 – Low Channel)

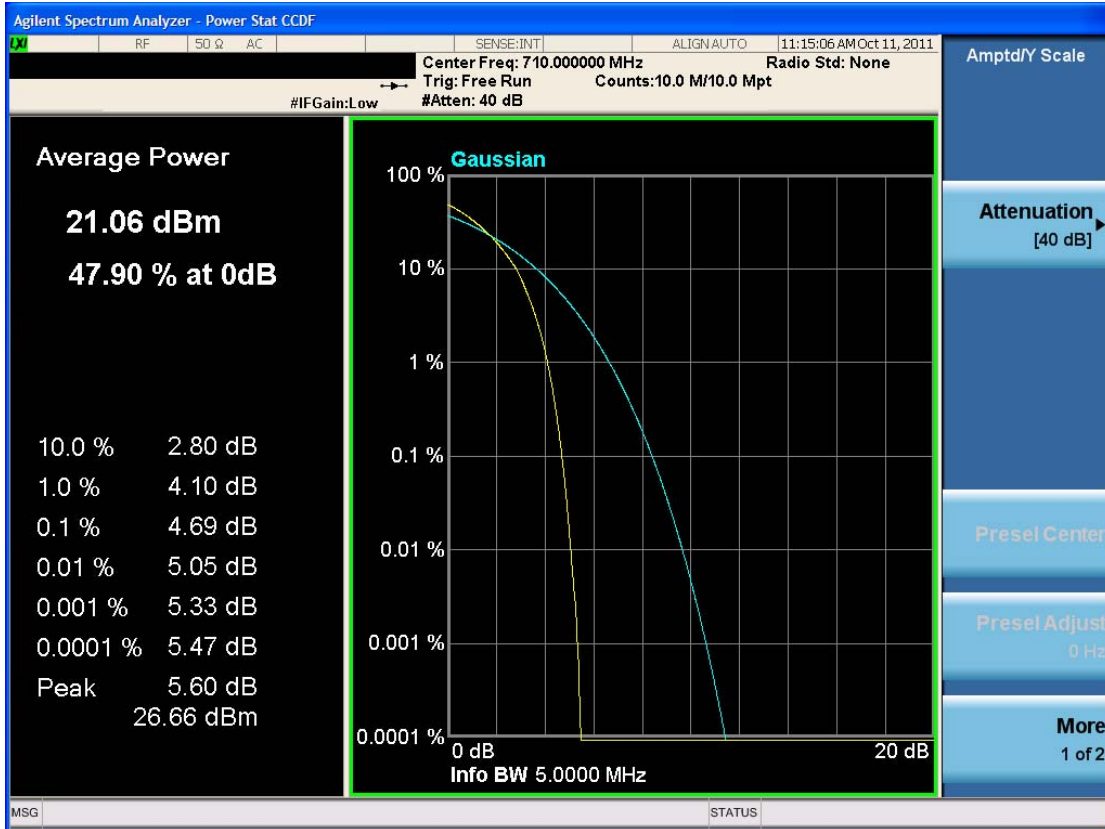

Peak-Average Ratio Plot (10 MHz BW, QPSK, Band 17 – Mid Channel)

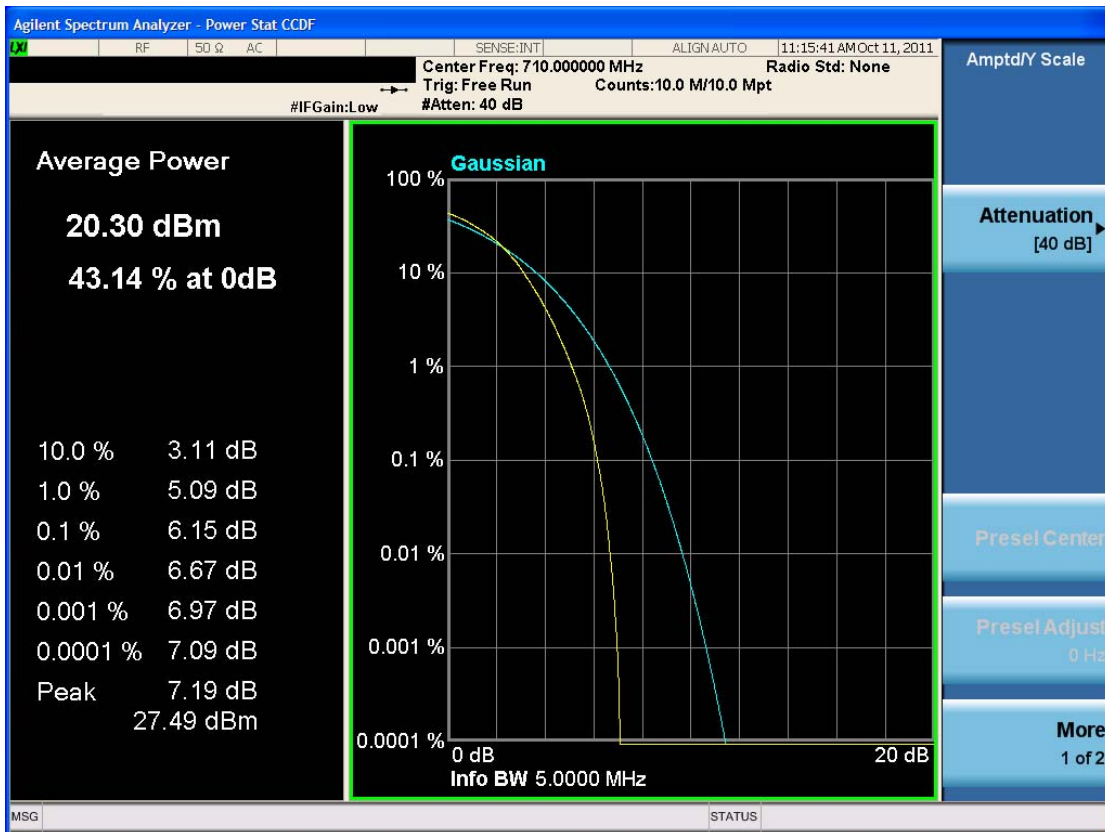

Peak-Average Ratio Plot (10 MHz BW, 16QAM, Band 17 – Mid Channel)



Band Edge Plot (5 MHz BW, QPSK, AWS Band – Low Channel)

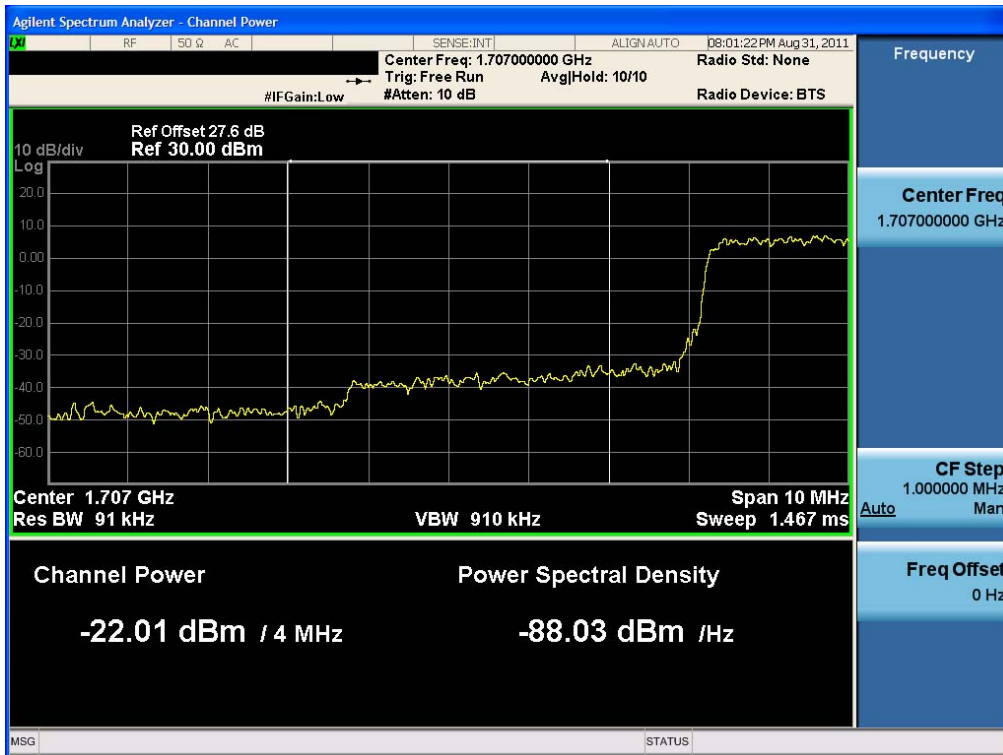

Extended Band Edge Plot (5 MHz BW, QPSK, AWS Band – Low Channel)

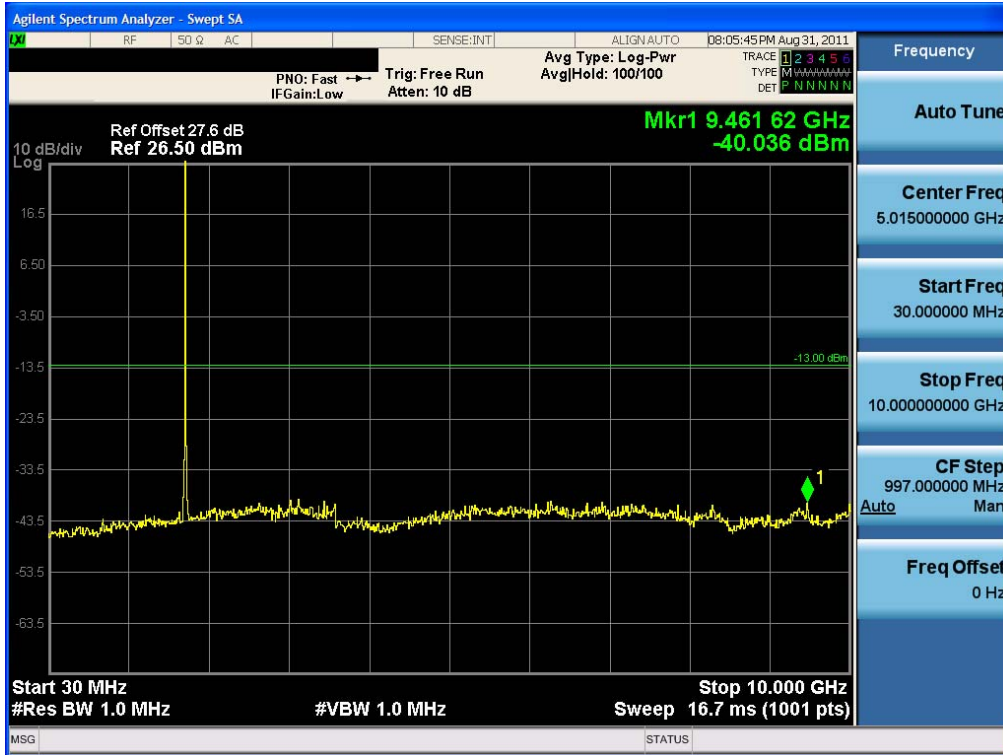

Conducted Spurious Plot (5 MHz BW, QPSK, Band 4 – Mid Channel)



Conducted Spurious Plot (5 MHz BW, QPSK, Band 4 – Mid Channel)

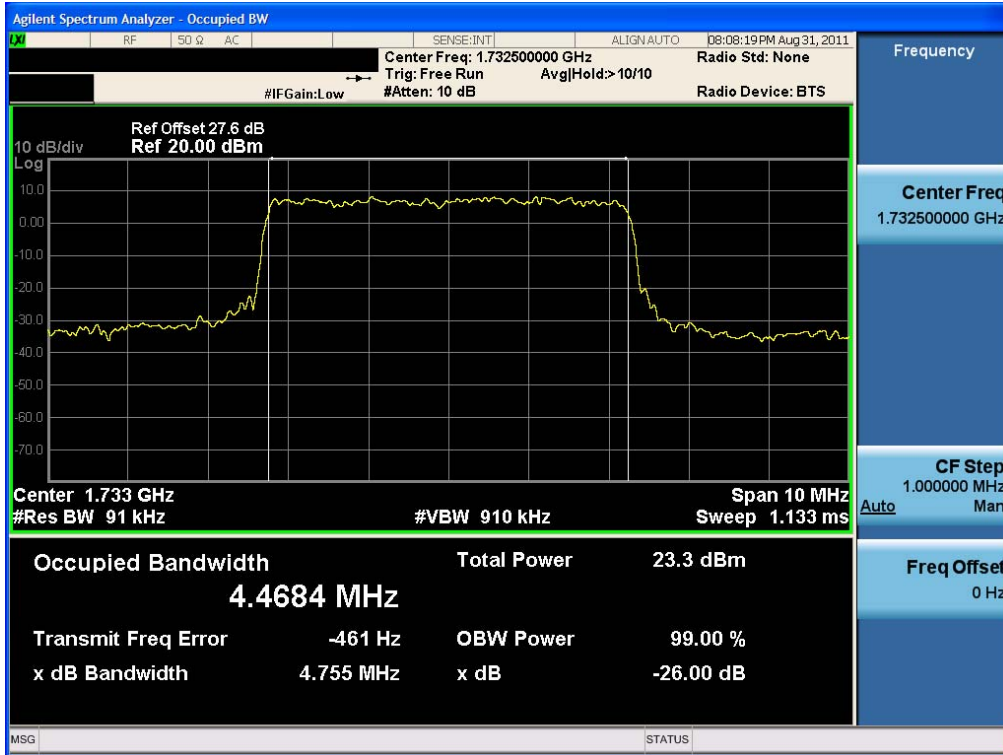

Occupied Bandwidth Plot (5 MHz BW, QPSK, Band 4 –Mid Channel)

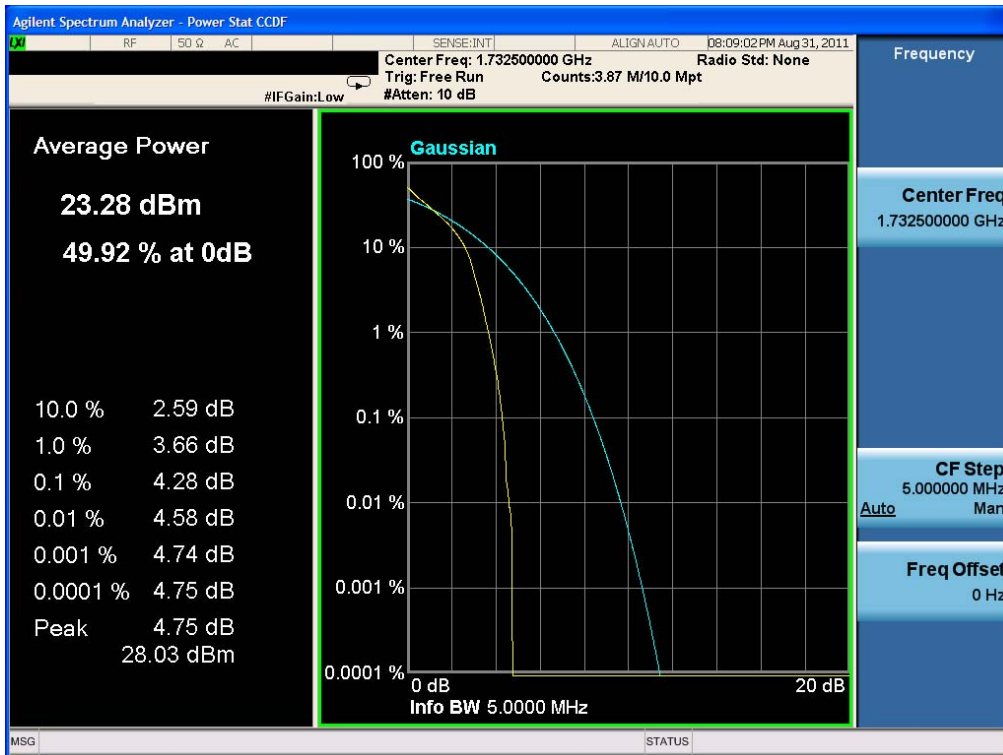

Peak-Average Ratio Plot (5 MHz BW, QPSK, Band 4 – Mid Channel)



Occupied Bandwidth Plot (5 MHz BW, 16-QAM, Band 4 –Mid Channel)

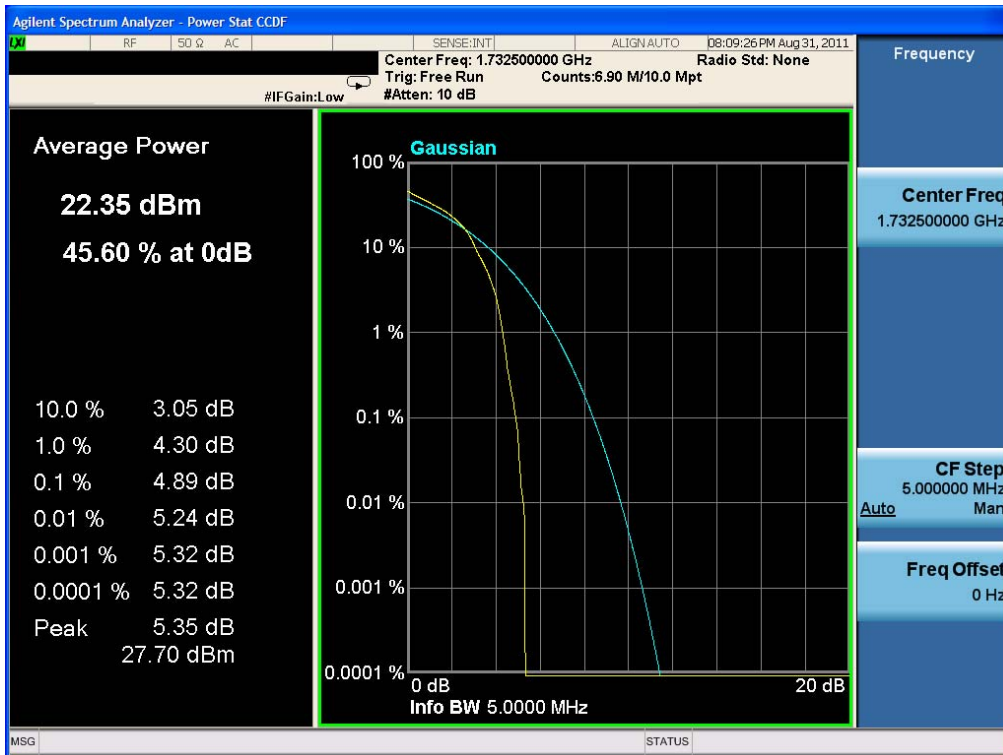

Peak-Average Ratio Plot (5 MHz BW, 16-QAM, Band 4 – Mid Channel)



Conducted Spurious Plot (5 MHz BW, QPSK, Band 4 – High Channel)



Conducted Spurious Plot (5 MHz BW, QPSK, Band 4 – High Channel)



Band Edge Plot (5 MHz BW, QPSK, Band 4 – High Channel)



Extended Band Edge Plot (5 MHz BW, QPSK, Band 4 – High Channel)

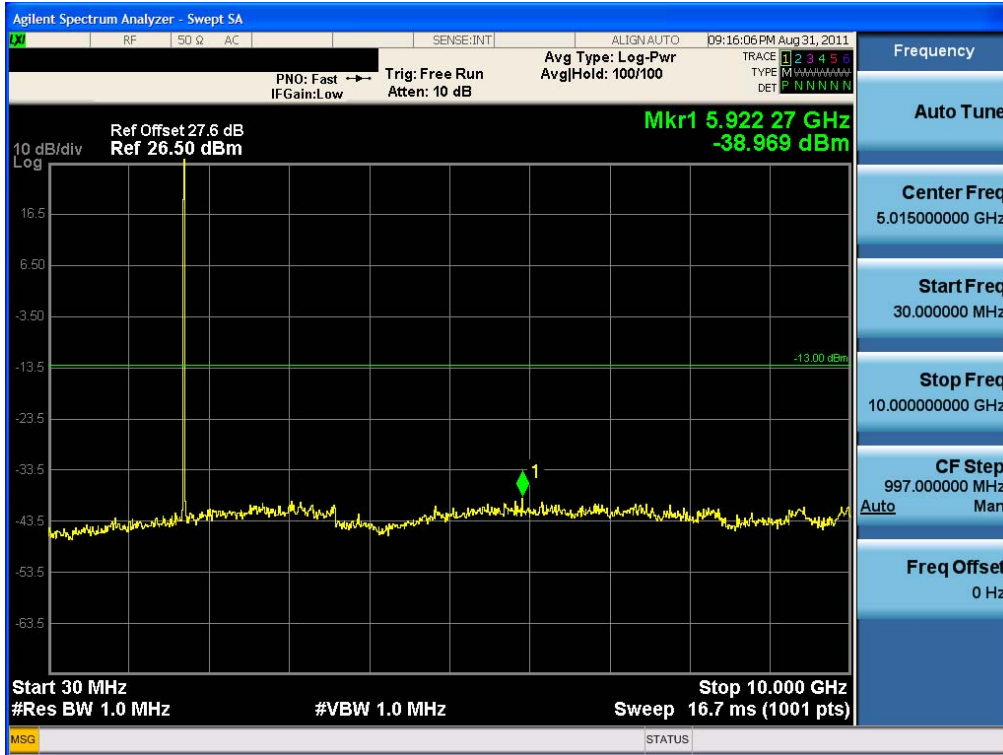

Conducted Spurious Plot (10 MHz BW, QPSK, Band 4 – Low Channel)



Conducted Spurious Plot (10 MHz BW, QPSK, Band 4 – Low Channel)



Band Edge Plot (10 MHz BW, QPSK, Band 4 – Low Channel)



Extended Band Edge Plot (10 MHz BW, QPSK, Band 4 – Low Channel)

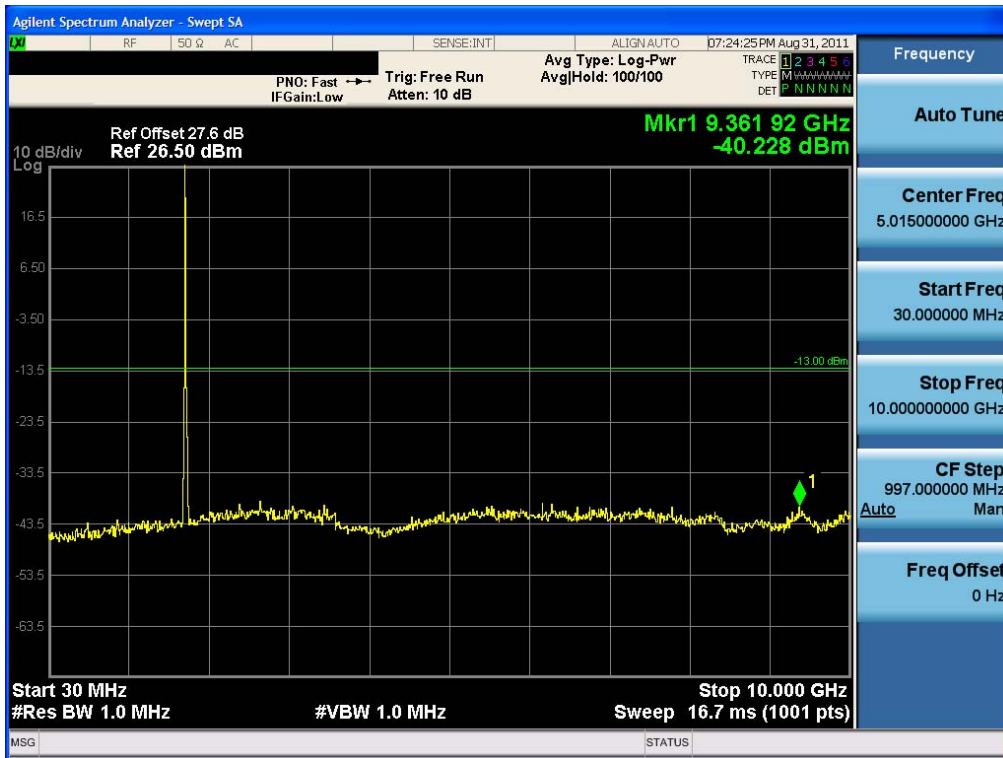

Conducted Spurious Plot (10 MHz BW, QPSK, Band 4 – Mid Channel)



Conducted Spurious Plot (10 MHz BW, QPSK, Band 4 – Mid Channel)



Occupied Bandwidth Plot (10 MHz BW, QPSK, Band 4 –Mid Channel)

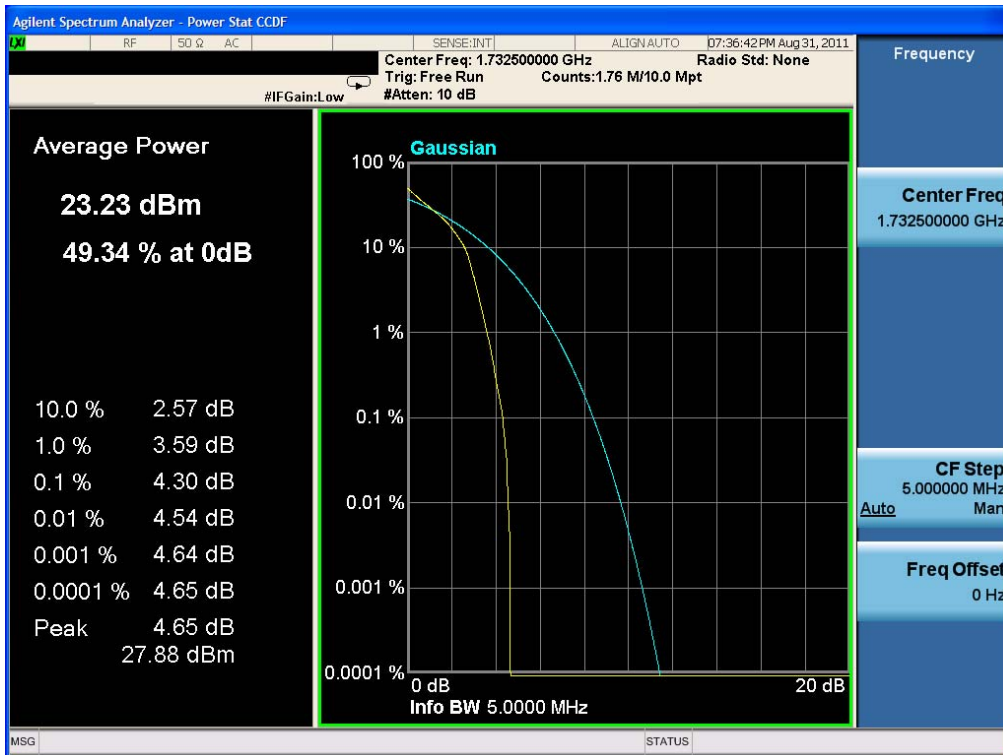

Peak-Average Ratio Plot (10 MHz BW, QPSK, Band 4 – Mid Channel)