



MET Laboratories, Inc. *Safety Certification - EMI - Telecom Environmental Simulation*

914 WEST PATAPSCO AVENUE • BALTIMORE, MARYLAND 21230-3432 • PHONE (410) 354-3300 • FAX (410) 354-3313
33439 WESTERN AVENUE • UNION CITY, CALIFORNIA 94587 • PHONE (510) 489-6300 • FAX (510) 489-6372
3162 BELICK STREET • SANTA CLARA, CA 95054 • PHONE (408) 748-3585 • FAX (510) 489-6372
13501 MCCALLEN PASS • AUSTIN, TEXAS 78753 • PHONE (512) 287-2500 • FAX (512) 287-2513

December 5, 2018

HID Global Corporation
611 Center Ridge Dr.
Austin, TX 78753

Dear Robert Cresswell,

Enclosed is the EMC Wireless test report for compliance testing of the HID Global Corporation, OMNIKEY 5127 Modular Mini as tested to the requirements of Title 47 of the CFR, Ch. 1, Part 15 Subpart C for Intentional Radiators.

Thank you for using the services of MET Laboratories, Inc. If you have any questions regarding these results or if MET can be of further service to you, please feel free to contact me.

Sincerely yours,
MET LABORATORIES, INC.

Joel Huna
Documentation Department

Reference: (\HID Global Corporation\EMCA99642-FCC15C Rev. 1)

Certificates and reports shall not be reproduced except in full, without the written permission of MET Laboratories, Inc. While use of the A2LA logo in this report reflects MET accreditation under these programs, the report must not be used by the client to claim product certification, approval, or endorsement by A2LA or any agency of the Federal Government. This letter of transmittal is not a part of the attached report.



The Nation's First Licensed Nationally Recognized Testing Laboratory

Electromagnetic Compatibility Criteria Test Report

for the

**HID Global Corporation
OMNIKEY 5127 Modular Mini**

Tested under
the FCC Certification Rules
contained in
Part 15 Subpart C for Intentional Radiators

MET Report: EMCA99642-FCC15C Rev. 1

December 5, 2018

Prepared For:

**HID Global Corporation
611 Center Ridge Dr.
Austin, TX 78753**

Prepared By:
MET Laboratories, Inc.
13501 McCallen Pass
Austin, TX 78753

Electromagnetic Compatibility Criteria Test Report

for the

**HID Global Corporation
OMNIKEY 5127 Modular Mini**

Tested under
the FCC Certification Rules
contained in
Part 15 Subpart C for Intentional Radiators



Giuliano Messina, Project Engineer
Electromagnetic Compatibility Lab



Joel Huna
Documentation Department

Engineering Statement: The measurements shown in this report were made in accordance with the procedures indicated, and the emissions from this equipment were found to be within the limits applicable. I assume full responsibility for the accuracy and completeness of these measurements, and for the qualifications of all persons taking them. It is further stated that upon the basis of the measurements made, the equipment tested is capable of operation in accordance with the requirements of the FCC Rules Part 15 Subpart C under normal use and maintenance.

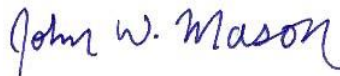

John Mason,
Director, Electromagnetic Compatibility Lab

Report Status Sheet

Revision	Report Date	Reason for Revision
∅	October 1, 2018	Initial Issue.
1	December 5, 2018	TCB Comments.

Table of Contents

I.	Executive Summary	1
	A. Purpose of Test	2
	B. Executive Summary	2
II.	Equipment Configuration	3
	A. Overview.....	4
	B. References.....	5
	C. Test Site	5
	D. Measurement Uncertainty	5
	E. Description of Test Sample.....	6
	F. Equipment Configuration.....	6
	G. Support Equipment	6
	H. Ports and Cabling Information.....	6
	I. Mode of Operation.....	7
	J. Method of Monitoring EUT Operation	7
	K. Modifications	7
	a) Modifications to EUT.....	7
	b) Modifications to Test Standard.....	7
	L. Disposition of EUT.....	7
III.	Electromagnetic Compatibility Criteria for Intentional Radiators.....	8
	§ 15.203 Antenna Requirement.....	9
	§ 15.207(a) Conducted Emissions Limits.....	10
	§ 15.247(d) Radiated Spurious Emissions Requirements and Band Edge	14
	20dB Bandwidth.....	18
	§ 15.247 125 kHz SAR Exclusion Calculation	19
IV.	Test Equipment	20
V.	Certification & User’s Manual Information.....	22
	A. Certification Information	23
	B. Label and User’s Manual Information	27

List of Tables

Table 1. Executive Summary of EMC Part 15 Compliance Testing	2
Table 2. EUT Summary Table.....	4
Table 3. References	5
Table 4. Uncertainty Calculations Summary.....	5
Table 5. Equipment Configuration	6
Table 6. Support Equipment.....	6
Table 7. Ports and Cabling Information	6
Table 8. Antenna List	9
Table 9. Conducted Limits for Intentional Radiators from FCC Part 15 § 15.207(a)	10
Table 10. Conducted Emissions, Bonding Measurements	11
Table 11. Conducted Emissions, Test Results.....	11
Table 12. Relevant Restricted Bands of Operation	14
Table 13. Radiated Emissions Limits Calculated from FCC Part 15, § 15.209 (a)	14
Table 14. Test Equipment List	21

List of Plots

Plot 1. Conducted Emissions, Line.....	12
Plot 2. Conducted Emissions, Neutral	12
Plot 3. Radiated Emissions, 0.009 – 0.150 MHz, 0 degrees	15
Plot 4. Radiated Emissions, 0.009 – 0.150 MHz, 90 degrees.....	15
Plot 5. Radiated Emissions, 0.150 – 0.490 MHz, 0 degrees.....	15
Plot 6. Radiated Emissions, 0.150 – 0.490 MHz, 90 degrees.....	16
Plot 7. Radiated Emissions, 0.490 – 1.250 MHz, 0 degrees.....	16
Plot 8. Radiated Emissions, 0.490 – 1.250 MHz, 90 degrees.....	16
Plot 9. 20 dB Bandwidth	18

List of Figures

Figure 1. Block Diagram of Test Configuration.....	6
--	---

List of Photographs

Photograph 1. Conducted Emissions, Overall Test Setup	13
Photograph 2. Conducted Emissions, LISN Connection.....	13
Photograph 3. Radiated Emissions, 0.009 MHz – 1.250 MHz, Antenna View	17
Photograph 4. Radiated Emissions, 0.009 – 1.250 MHz, Rear View	17

List of Terms and Abbreviations

AC	Alternating Current
ACF	Antenna Correction Factor
Cal	Calibration
<i>d</i>	Measurement Distance
dB	Decibels
dB μ A	Decibels above one microamp
dB μ V	Decibels above one microvolt
dB μ A/m	Decibels above one microamp per meter
dB μ V/m	Decibels above one microvolt per meter
DC	Direct Current
E	Electric Field
DSL	Digital Subscriber Line
ESD	Electrostatic Discharge
EUT	Equipment Under Test
<i>f</i>	Frequency
FCC	Federal Communications Commission
GRP	Ground Reference Plane
H	Magnetic Field
HCP	Horizontal Coupling Plane
Hz	Hertz
IEC	International Electrotechnical Commission
kHz	kilohertz
kPa	kilopascal
kV	kilovolt
LISN	Line Impedance Stabilization Network
MHz	Megahertz
μ H	microhenry
μ	microfarad
μ s	microseconds
NEBS	Network Equipment-Building System
PRF	Pulse Repetition Frequency
RF	Radio Frequency
RMS	Root-Mean-Square
TWT	Traveling Wave Tube
V/m	Volts per meter
VCP	Vertical Coupling Plane

I. Executive Summary

A. Purpose of Test

An EMC evaluation was performed to determine compliance of the HID Global Corporation OMNIKEY 5127 Modular Mini, with the requirements of Part 15, Subpart C. All references are to the most current version of Title 47 of the Code of Federal Regulations in effect. In accordance with §2.1033, the following data is presented in support of the Certification of the OMNIKEY 5127 Modular Mini. HID Global Corporation should retain a copy of this document which should be kept on file for at least two years after the manufacturing of the OMNIKEY 5127 Modular Mini, has been **permanently** discontinued.

B. Executive Summary

The following tests were conducted on a sample of the equipment for the purpose of demonstrating compliance with Part 15, Subpart C, in accordance with HID Global Corporation, purchase order number 1110960792. All tests were conducted using measurement procedure ANSI C63.10:2013.

FCC Reference 47 CFR Part 15 Subpart C	Description	Compliance
Part 15 §15.203	Antenna Requirement	Compliant
Part 15 §15.207(a)	Conducted Emission Limits	Compliant
Part 15 §15.209; §15.205	Radiated Spurious Emissions Requirements	Compliant
Part 15; §15.215	20 dB Occupied Bandwidth	Compliant
Part 2 §2.1093	Radio Frequency radiation exposure, portable devices	Compliant

Table 1. Executive Summary of EMC Part 15 Compliance Testing

II. Equipment Configuration

A. Overview

MET Laboratories, Inc. was contracted by HID Global Corporation to perform testing on the OMNIKEY 5127 Modular Mini, under HID Global Corporation's purchase order number 1110960792.

This document describes the test setups, test methods, required test equipment, and the test limit criteria used to perform compliance testing of the HID Global Corporation, OMNIKEY 5127 Modular Mini.

The results obtained relate only to the item(s) tested.

Model(s) Tested:	OMNIKEY 5127 Modular Mini	
Model(s) Covered:	OMNIKEY 5127 Modular Mini	
EUT Specifications:	Primary Power: 5VDC	
	FCC ID: JQ6-5127MODMIN	
	Type of Modulations:	FSK
	Equipment Code:	DCD
	Peak RF Output Power:	-77.598 dBm
	EUT Frequency Ranges:	125kHz
	Antenna Type:	Coil
	Antenna Gain:	1.0 dBi
Analysis:	The results obtained relate only to the item(s) tested.	
Environmental Test Conditions:	Temperature: 15-35° C	
	Relative Humidity: 30-60%	
	Barometric Pressure: 860-1060 mbar	
Evaluated by:	Giuliano Messina	
Report Date(s):	December 5, 2018	

Table 2. EUT Summary Table

B. References

CFR 47, Part 15, Subpart C	Federal Communication Commission, Code of Federal Regulations, Title 47, Part 15: General Rules and Regulations, Allocation, Assignment, and Use of Radio Frequencies
ANSI C63.4:2014	Methods and Measurements of Radio-Noise Emissions from Low-Voltage Electrical And Electronic Equipment in the Range of 9 kHz to 40 GHz
ISO/IEC 17025:2005	General Requirements for the Competence of Testing and Calibration Laboratories
ANSI C63.10:2013	American National Standard for Testing Unlicensed Wireless Devices

Table 3. References

C. Test Site

All testing was performed at MET Laboratories, Inc., 13501 McCallen Pass, Austin, TX 78753. All equipment used in making physical determinations is accurate and bears recent traceability to the National Institute of Standards and Technology.

Radiated Emissions measurements were performed in a 10 meter semi-anechoic chamber (equivalent to an Open Area Test Site). In accordance with §2.948(a)(3), a complete site description is contained at MET Laboratories.

D. Measurement Uncertainty

Test Method	Typical Expanded Uncertainty	K	Confidence Level
RF Frequencies	±4.52 Hz	2	95%
Radiated Emissions	±2.95 dB	2	95%

Table 4. Uncertainty Calculations Summary

E. Description of Test Sample

The HID Global Corporation OMNIKEY 5127 Modular Mini, Equipment Under Test (EUT), is an RF card reader with Bluetooth connection capability.

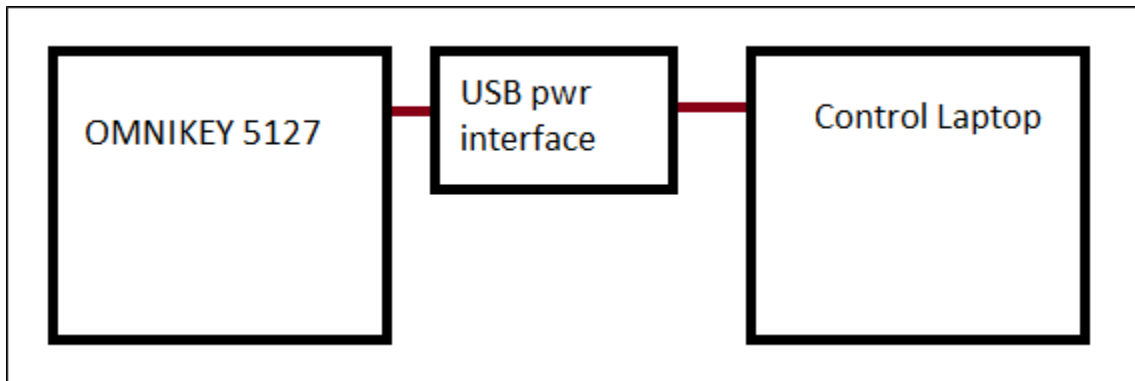

Figure 1. Block Diagram of Test Configuration

F. Equipment Configuration

The EUT was set up as outlined in Figure 1, Block Diagram of Test Setup. All cards, racks, etc., incorporated as part of the EUT is included in the following list.

Ref. ID	Name / Description	Model Number	Part Number	Serial Number	Revision
N/A	Modular Mini	OmniKey 5127CK	N/A	N/A	N/A

Table 5. Equipment Configuration

G. Support Equipment

Support equipment necessary for the operation and testing of the EUT is included in the following list.

Ref. ID	Name / Description	Manufacturer	Model Number
N/A	Laptop	Dell	E6410
N/A	USB power interface board	HID	N/A

Table 6. Support Equipment

H. Ports and Cabling Information

Ref. ID	Port Name on EUT	Cable Description	Qty.	Length (m)	Shielded (Y/N)	Termination Point
N/A	Power	Ribbon connector	1	0.1	N	Power interface board
N/A	NA	USB to Serial	1	1	N	Laptop

Table 7. Ports and Cabling Information

I. Mode of Operation

The EUT was powered via USB connection to the laptop. A customer-supplied interface provided monitoring of the transmitter's functionality.

J. Method of Monitoring EUT Operation

A spectrum analyzer was used to confirm that the EUT accepted control commands and provided the correct output based on those commands.

K. Modifications

a) Modifications to EUT

No modifications were made to the EUT.

b) Modifications to Test Standard

No modifications were made to the test standard.

L. Disposition of EUT

The test sample including all support equipment submitted to the Electro-Magnetic Compatibility Lab for testing was returned to HID Global Corporation upon completion of testing.

III. Electromagnetic Compatibility Criteria for Intentional Radiators

Electromagnetic Compatibility Criteria for Intentional Radiators

§ 15.203 Antenna Requirement

Test Requirement: § 15.203: An intentional radiator shall be designed to ensure that no antenna other than that furnished by the responsible party shall be used with the device. The use of a permanently attached antenna or of an antenna that uses a unique coupling to the intentional radiator shall be considered sufficient to comply with the provisions of this section. The manufacturer may design the unit so that a broken antenna can be replaced by the user, but the use of a standard antenna jack or electrical connector is prohibited.

The structure and application of the EUT were analyzed to determine compliance with Section 15.203 of the Rules. Section 15.203 states that the subject device must meet at least one of the following criteria:

- a.) Antenna must be permanently attached to the unit.
- b.) Antenna must use a unique type of connector to attach to the EUT.
- c.) Unit must be professionally installed. Installer shall be responsible for verifying that the correct antenna is employed with the unit.

Results: The EUT as tested is compliant to criteria A of §15.203. The antenna has a non-standard connector and permanently attached to the unit.

Test Engineer(s): Giuliano Messina

Test Date(s): June 25, 2018

Antenna Type	Antenna Gain
Coil	1.0 dBi

Table 8. Antenna List

Electromagnetic Compatibility Criteria for Intentional Radiators

§ 15.207(a) Conducted Emissions Limits

Test Requirement(s): § 15.207 (a): For an intentional radiator that is designed to be connected to the public utility (AC) power line, the radio frequency voltage that is conducted back onto the AC power line on any frequency or frequencies, within the band 150 kHz to 30MHz, shall not exceed the limits in the following table, as measured using a 50 μ H/50 Ω line impedance stabilization network (LISN). Compliance with the provisions of this paragraph shall be based on the measurement of the radio frequency voltage between each power line and ground at the power terminal. The lower limit applies at the boundary between the frequency ranges.

Frequency range (MHz)	§ 15.207(a), Conducted Limit (dB μ V)	
	Quasi-Peak	Average
* 0.15 - 0.5	66 - 56	56 - 46
0.5 - 5	56	46
5 - 30	60	50

Table 9. Conducted Limits for Intentional Radiators from FCC Part 15 § 15.207(a)

Note: *Decreases with the logarithm of the frequency.

Test Procedure: The EUT was placed on a 0.8 m-high wooden table above a ground plane. The EUT was situated such that the back of the EUT was 0.4 m from one wall of the vertical ground plane, and the remaining sides of the EUT were no closer than 0.8 m from any other conductive surface. The EUT was powered from a 50 Ω /50 μ H Line Impedance Stabilization Network (LISN). The EMC receiver scanned the frequency range from 150 kHz to 30 MHz. Conducted Emissions measurements were made in accordance with *ANSI C63.4-2014 "Methods and Measurements of Radio-Noise Emissions from Low-Voltage Electrical and Electronic Equipment in the Range of 9kHz to 40 GHz"*. The measurements were performed over the frequency range of 0.15 MHz to 30 MHz using a 50 Ω /50 μ H LISN as the input transducer to an EMI receiver. For the purpose of this testing, the transmitter was turned on during scans.

Test Results: The EUT was compliant with this requirement. Measured emissions were within applicable limits.

Test Engineer(s): Giuliano Messina and Jonathan Tavira

Test Date(s): July 16, 2018

Meas. Location	Meas.	Limit	Pass/Fail
Bonding measurement from LISN ground to ground plane	1.19 mΩ	< 2.5 mΩ	Pass

Table 10. Conducted Emissions, Bonding Measurements

Line	Freq (MHz)	QP Amplitude	QP Limit	Delta	Pass	Average Amplitude	Average Limit	Delta	Pass	Notes
ACLine	0.154	48.8	65.782	-16.982	Pass	32.5	55.782	-23.282	Pass	None
ACLine	0.174	45.2	64.771	-19.571	Pass	30.2	54.771	-24.571	Pass	None
ACLine	0.190	44.5	64.042	-19.542	Pass	27.7	54.042	-26.342	Pass	None
ACLine	0.206	41.9	63.372	-21.472	Pass	27.3	53.372	-26.072	Pass	None
ACLine	0.410	28.8	57.671	-28.871	Pass	21.7	47.671	-25.971	Pass	None
ACLine	20.678	30.3	60	-29.7	Pass	25.2	50	-24.8	Pass	None
ACNeutral	0.174	45.5	64.771	-19.271	Pass	30.6	54.771	-24.171	Pass	None
ACNeutral	0.206	41	63.372	-22.372	Pass	27.1	53.372	-26.272	Pass	None
ACNeutral	0.242	36.1	62.038	-25.938	Pass	24	52.038	-28.038	Pass	None
ACNeutral	0.394	27.2	58.001	-30.801	Pass	19.9	48.001	-28.101	Pass	None
ACNeutral	0.426	30.5	57.354	-26.854	Pass	21.4	47.354	-25.954	Pass	None
ACNeutral	18.938	27.2	60	-32.8	Pass	22.1	50	-27.9	Pass	None

Table 11. Conducted Emissions, Test Results

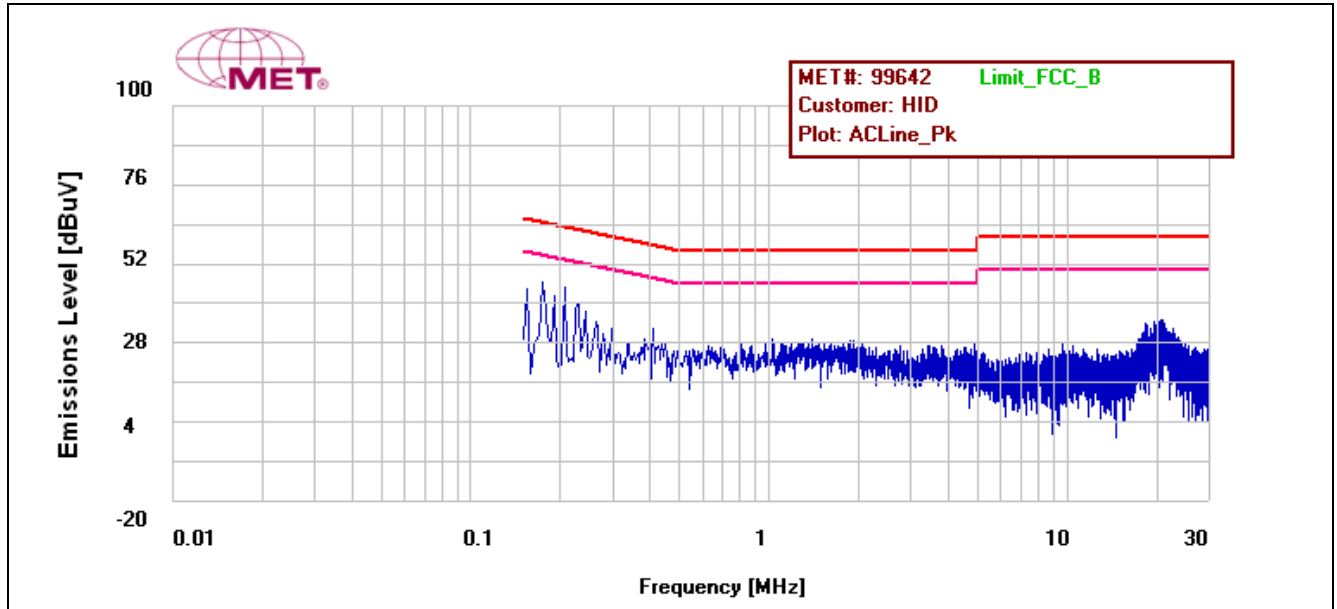

Plot 1. Conducted Emissions, Line

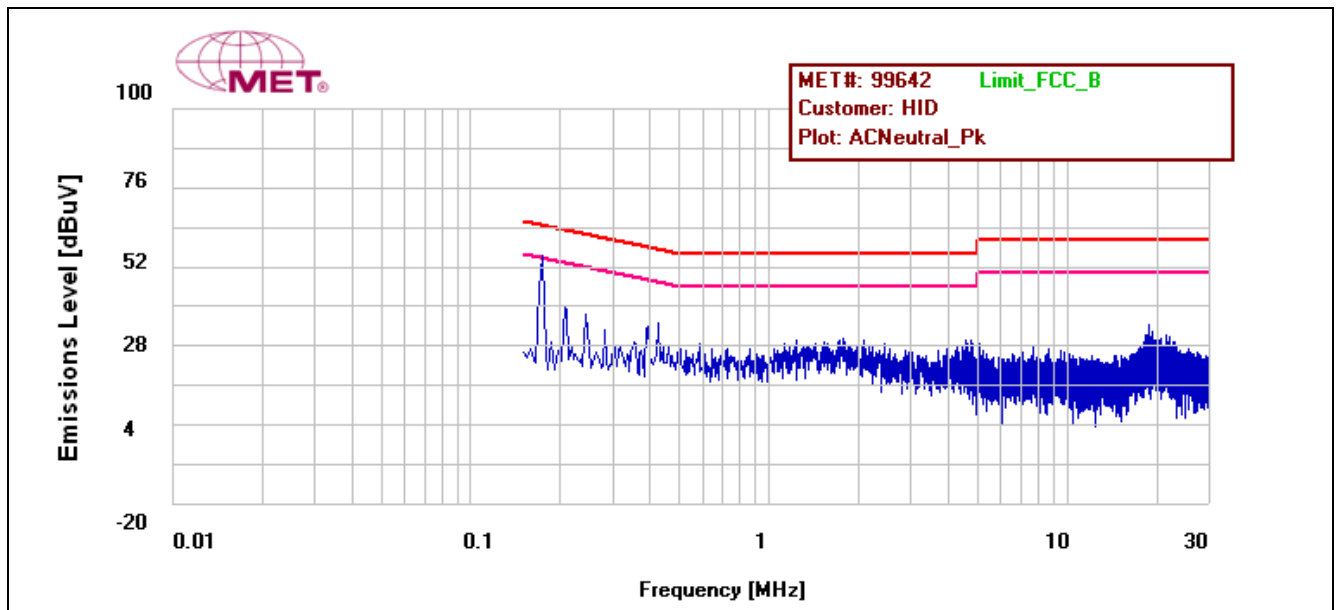

Plot 2. Conducted Emissions, Neutral

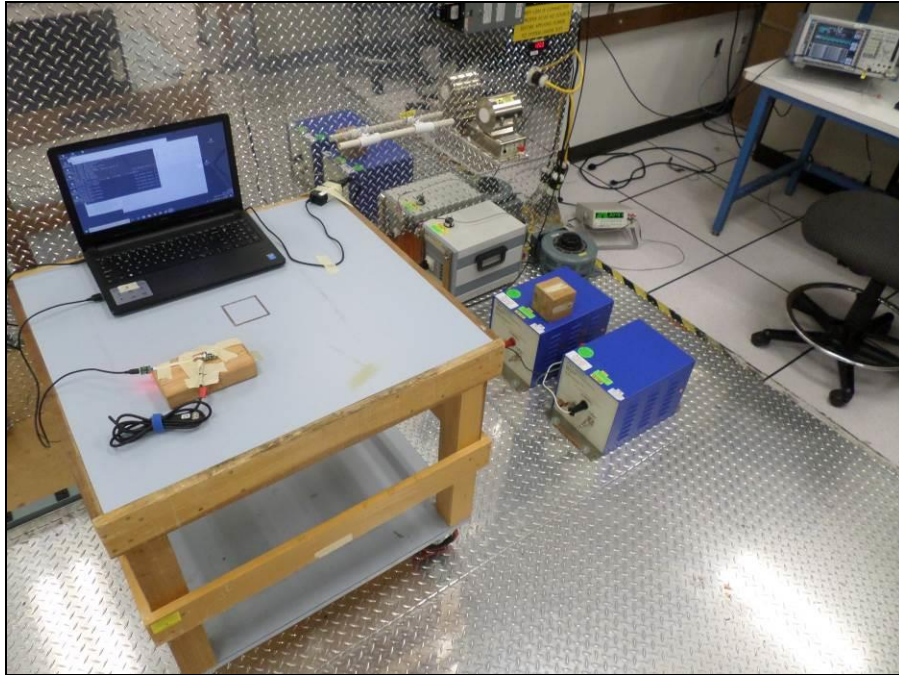

Photograph 1. Conducted Emissions, Overall Test Setup

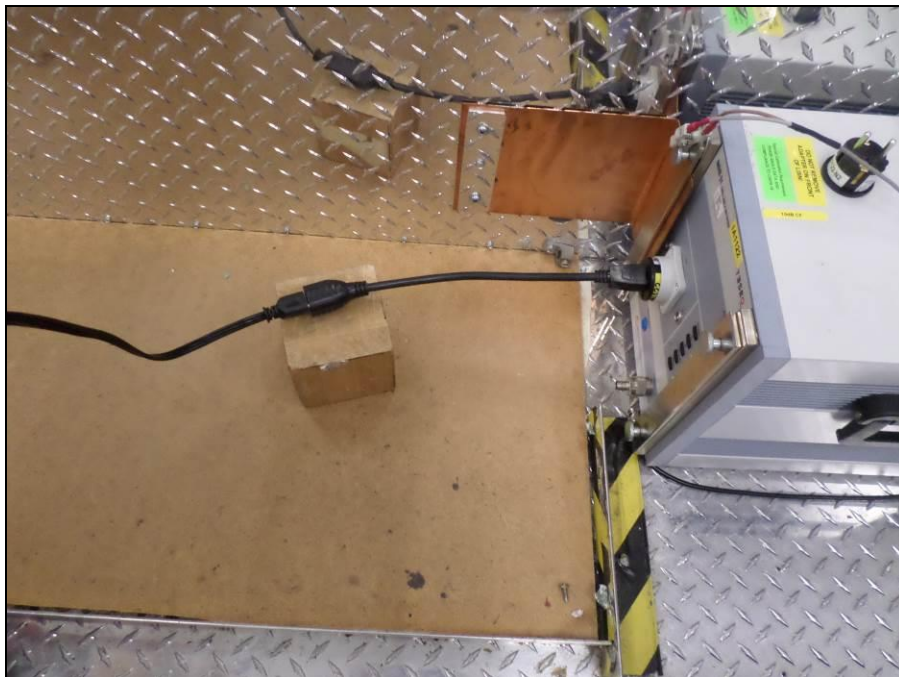

Photograph 2. Conducted Emissions, LISN Connection

Electromagnetic Compatibility Criteria for Intentional Radiators

§ 15.209 Radiated Spurious Emissions Requirements and Band Edge

Test Requirements: §15.209; §15.205: Emissions outside the frequency band.

§15.205(a): Except as shown in paragraph (d) of this section, only spurious emissions are permitted in any of the frequency bands listed below:

MHz
0.090–0.110
¹ 0.495–0.505

Table 12. Relevant Restricted Bands of Operation

¹ Until February 1, 1999, this restricted band shall be 0.490 – 0.510 MHz.

Test Requirement(s): § 15.209 (a): Except as provided elsewhere in this subpart, the emissions from an intentional radiator shall not exceed the field strength levels specified in Table 13.

Frequency (MHz)	Field strength (microvolts/meter)	Measurement distance (meters)
0.009-0.490	2400/F(kHz)	300
0.490-1.705	24000/F(kHz)	30

Table 13. Radiated Emissions Limits Calculated from FCC Part 15, § 15.209 (a)

Test Procedures: The transmitter was turned on. Measurements were performed up to the 10th harmonic as per ANSI C63.10. The EUT was rotated orthogonally through all three axes and with the active loop antenna at parallel and perpendicular polarities. Plots shown are corrected for both antenna correction factor and distance.

Test Results: The EUT was compliant with the Radiated Spurious Emission limits of § 15.209. Measured emissions were within applicable limits.

Test Engineer(s): Giuliano Messina

Test Date(s): June 25, 2018

Radiated Spurious Emissions, Test Results

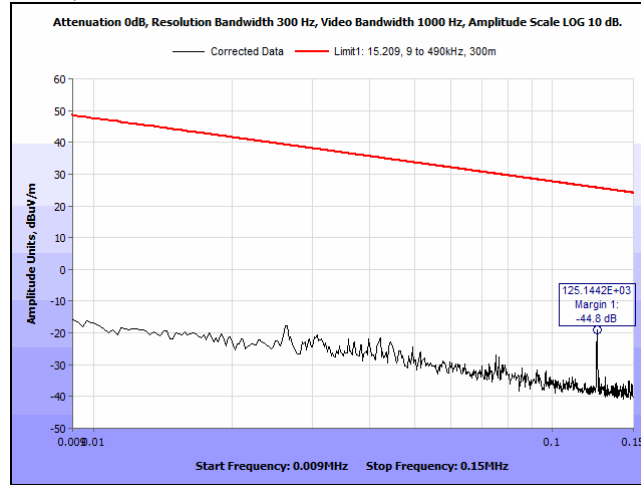

Plot 3. Radiated Emissions, 0.009 – 0.150 MHz, 0 degrees

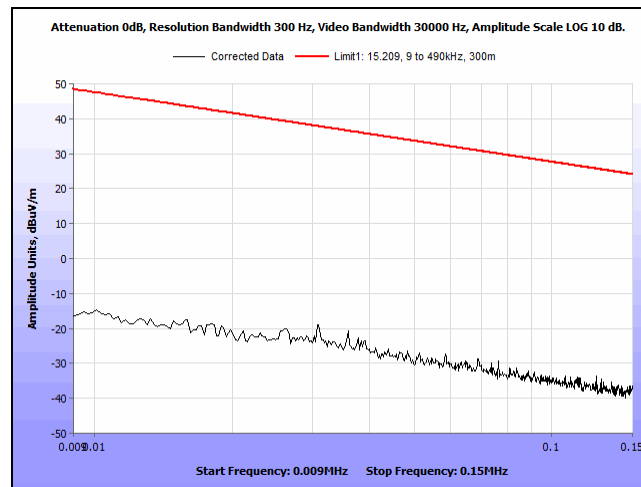

Plot 4. Radiated Emissions, 0.009 – 0.150 MHz, 90 degrees

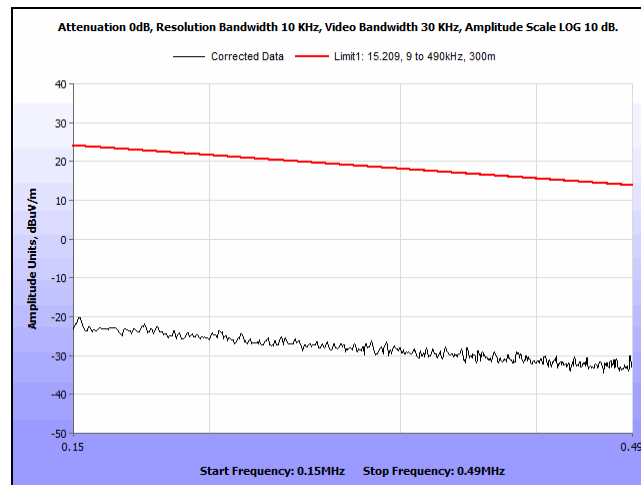

Plot 5. Radiated Emissions, 0.150 – 0.490 MHz, 0 degrees

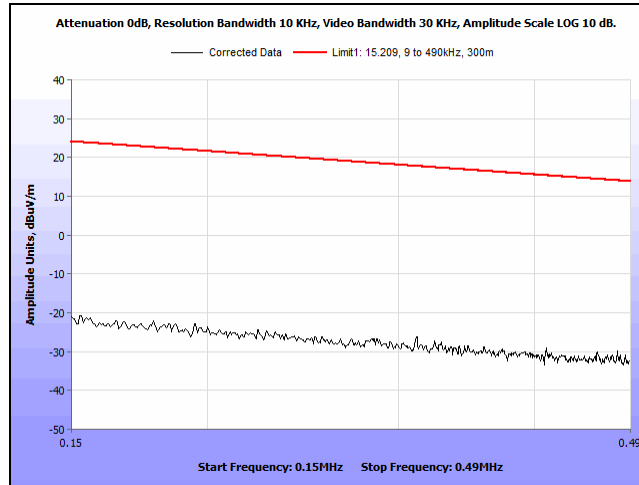

Plot 6. Radiated Emissions, 0.150 – 0.490 MHz, 90 degrees

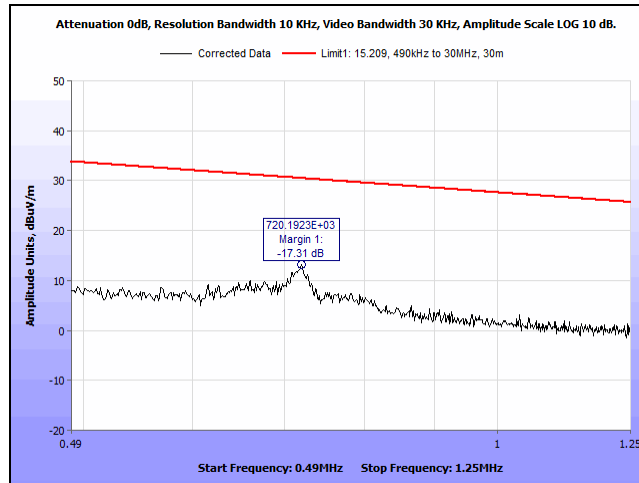

Plot 7. Radiated Emissions, 0.490 – 1.250 MHz, 0 degrees

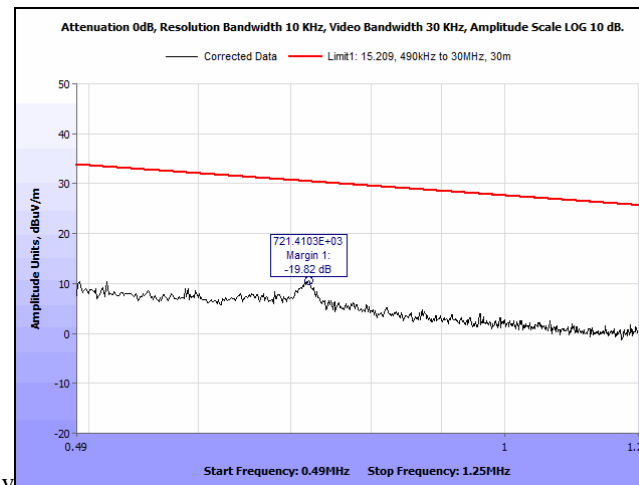

Plot 8. Radiated Emissions, 0.490 – 1.250 MHz, 90 degrees

Radiated Spurious Emissions Test Setup

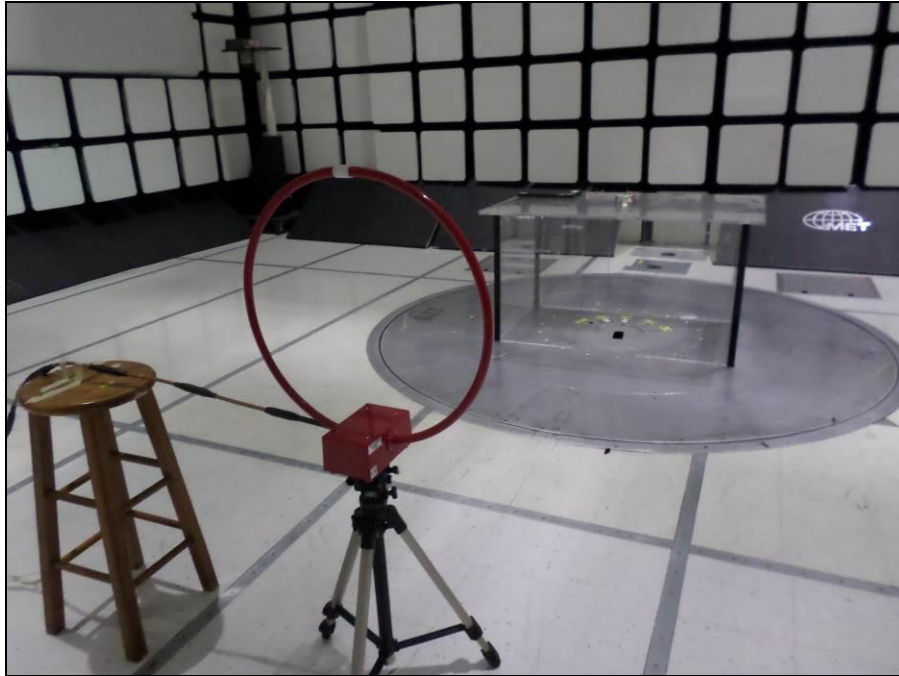

Photograph 3. Radiated Emissions, 0.009 MHz – 1.250 MHz, Antenna View

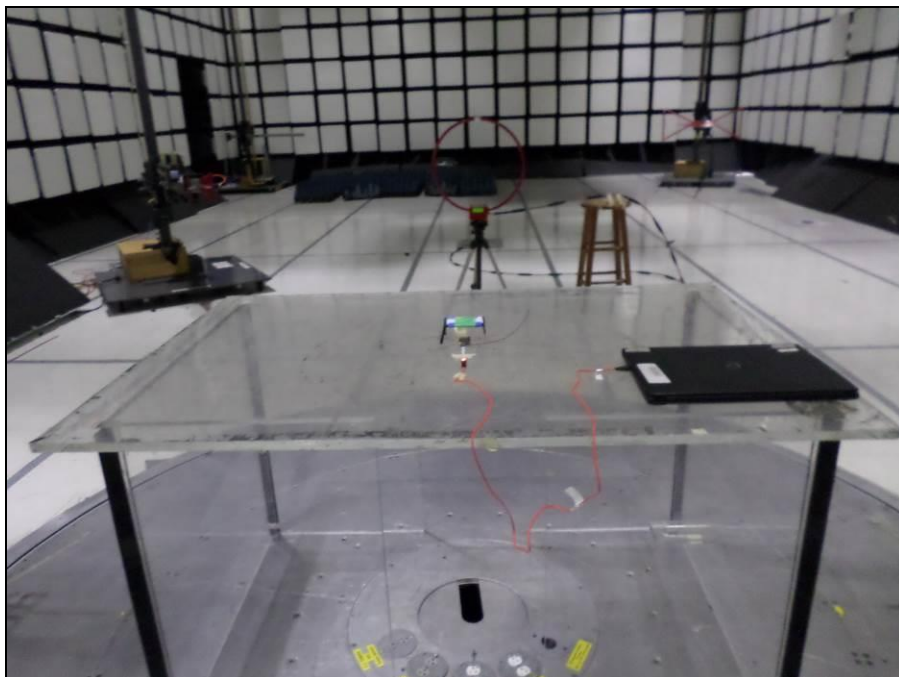

Photograph 4. Radiated Emissions, 0.009 – 1.250 MHz, Rear View

Electromagnetic Compatibility Criteria for Intentional Radiators

20 dB Bandwidth

Test Procedure: The transmitter was on and transmitting at the highest output power. The bandwidth of the fundamental frequency was measured with the spectrum analyzer, VBW > RBW. The 20 dB Bandwidth was measured and recorded.

Test Results The EUT was compliant with this requirement.
 The 20 dB Bandwidth was determined from the plot below.

Test Engineer(s): Giuliano Messina

Test Date(s): June 29, 2018

20 dB Bandwidth Test Results

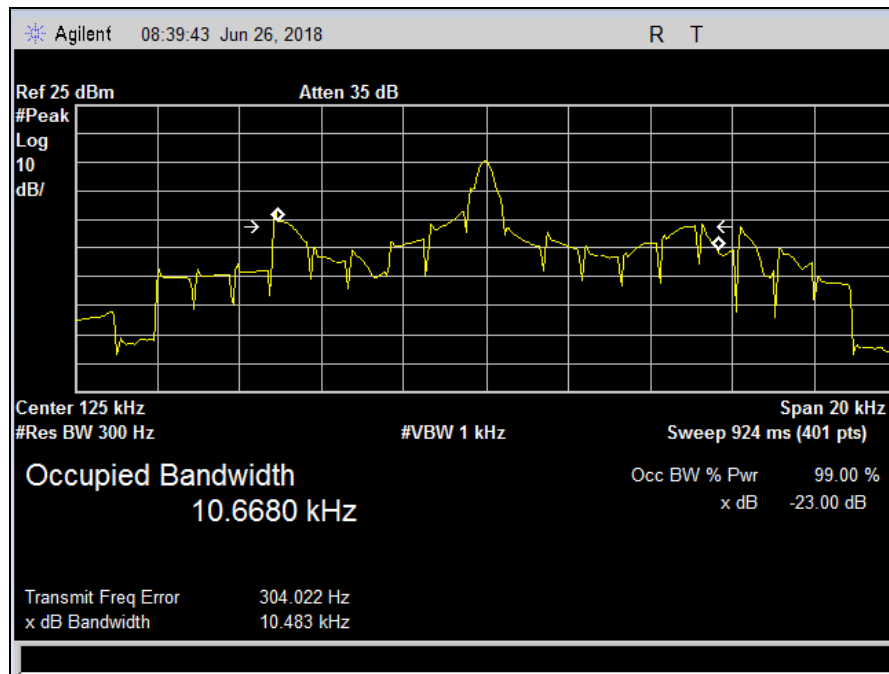

Plot 9. 20 dB Bandwidth

Electromagnetic Compatibility Criteria for Intentional Radiators

§ 2.1093 125 kHz SAR Exclusion Calculation

Per KDB 447498, Section 4.3.1 (c)(2), applicable for frequencies below 100 MHz and test separation distances ≤ 50 mm:

1. Using the information from 4.3.1 (b), the formula from 4.3.1 (a), and using the 1-g SAR limit of 3.0:
Power allowed at numeric threshold for 50 mm and 100 MHz in step 4.3.1 (a) =

$$\left(\frac{3}{\sqrt{0.1}}\right) * 50 \text{ mm} = 474.34 \text{ mW}$$

2. Using information from 4.3.1 (c)(1) and the formula from 4.3.1 (b), defined at 50 mm and 100 MHz:

$$\left(\text{Power allowed at numeric threshold for 50 mm in step 4.3.1 (a)}\right) +$$

$$\left(\text{test separation distance} - 50 \text{ mm}\right) * \left(\frac{f [\text{MHz}]}{150}\right)$$

$$(474.34 \text{ mW}) + (50 \text{ mm} - 50 \text{ mm}) * \left(\frac{100 \text{ MHz}}{150}\right) = 474.34 \text{ mW}$$

3. Using the information from 4.3.1 (c)(2) and the formula from 4.3.1 (c)(1), defined at 0.125 MHz, the final max power should be:

Max Power of 13.56MHz Transmitter under the 1g SAR Limit =

$$\frac{1}{2} * 474.34 \text{ mW} \left[1 + \log\left(\frac{100 \text{ MHz}}{0.125 \text{ MHz}}\right)\right] = 925.69 \text{ mW}$$

FCC						
Frequency (MHz)	Corrected Meter Reading (dBuV/m)	TX Power (dbm)	TX Power (mW)	1.0-g SAR Limit (mW)	Margin (mW)	Result
0.125	-19.14	-77.598	1.742E-8	925.69	925.69	Pass

IV. Test Equipment

Test Equipment

Calibrated test equipment utilized during testing was maintained in a current state of calibration per the requirements of ISO/IEC 17025:2005.

MET Asset #	Nomenclature	Manufacturer	Model	Last Cal Date	Cal Due Date
1A1176	Loop Antenna	ETS-Lindgren	6502	1/31/2018	7/31/2019
1A1184	Spectrum Analyzer	Agilent	E4407B	4/20/2018	4/20/2019
1A1083	EMI Test Receiver	Rohde & Schwarz	ESU40	9/12/2017	10/12/2018
1A1106	10m Chamber (FCC)	ETS	Semi-Anechoic	See Note	
1A1073	Multi Device Controller	ETS EMCO	2090	See Note	
1A1074	System Controller	Panasonic	WV-CU101	See Note	

Table 14. Test Equipment List

Note: Functionally tested equipment is verified using calibrated instrumentation at the time of testing.

V. Certification & User's Manual Information

Certification & User's Manual Information

A. Certification Information

The following is extracted from Title 47 of the Code of Federal Regulations, Part 2, Subpart I — Marketing of Radio frequency devices:

§ 2.801 Radio-frequency device defined.

As used in this part, a radio-frequency device is any device which in its operation is capable of Emitting radio-frequency energy by radiation, conduction, or other means. Radio- frequency devices include, but are not limited to:

- (a) The various types of radio communication transmitting devices described throughout this chapter.
- (b) *The incidental, unintentional and intentional radiators defined in Part 15 of this chapter.*
- (c) The industrial, scientific, and medical equipment described in Part 18 of this chapter.
- (d) Any part or component thereof which in use emits radio-frequency energy by radiation, conduction, or other means.

§ 2.803 Marketing of radio frequency devices prior to equipment authorization.

- (a) Except as provided elsewhere in this chapter, no person shall sell or lease, or offer for sale or lease (including advertising for sale or lease), or import, ship or distribute for the purpose of selling or leasing or offering for sale or lease, any radio frequency device unless:
 - (1) In the case of a device subject to certification, such device has been authorized by the Commission in accordance with the rules in this chapter and is properly identified and labeled as required by §2.925 and other relevant sections in this chapter; or
 - (2) In the case of a device that is not required to have a grant of equipment authorization issued by the Commission, but which must comply with the specified technical standards prior to use, such device also complies with all applicable administrative (including verification of the equipment or authorization under a Declaration of Conformity, where required), technical, labeling and identification requirements specified in this chapter.
- (d) Notwithstanding the provisions of paragraph (a) of this section, the offer for sale solely to business, commercial, industrial, scientific or medical users (but not an offer for sale to other parties or to end users located in a residential environment) of a radio frequency device that is in the conceptual, developmental, design or pre-production stage is permitted prior to equipment authorization or, for devices not subject to the equipment authorization requirements, prior to a determination of compliance with the applicable technical requirements *provided* that the prospective buyer is advised in writing at the time of the offer for sale that the equipment is subject to the FCC rules and that the equipment will comply with the appropriate rules before delivery to the buyer or to centers of distribution.

- (e)(1) Notwithstanding the provisions of paragraph (a) of this section, prior to equipment authorization or determination of compliance with the applicable technical requirements any radio frequency device may be operated, but not marketed, for the following purposes and under the following conditions:
- (i) *Compliance testing*;
 - (ii) Demonstrations at a trade show provided the notice contained in paragraph (c) of this section is displayed in a conspicuous location on, or immediately adjacent to, the device;
 - (iii) Demonstrations at an exhibition conducted at a business, commercial, industrial, scientific or medical location, but excluding locations in a residential environment, provided the notice contained in paragraphs (c) or (d) of this section, as appropriate, is displayed in a conspicuous location on, or immediately adjacent to, the device;
 - (iv) Evaluation of product performance and determination of customer acceptability, provided such operation takes place at the manufacturer's facilities during developmental, design or pre-production states; or
 - (v) Evaluation of product performance and determination of customer acceptability where customer acceptability of a radio frequency device cannot be determined at the manufacturer's facilities because of size or unique capability of the device, provided the device is operated at a business, commercial, industrial, scientific or medical user's site, but not at a residential site, during the development, design or pre-production stages.
- (e)(2) For the purpose of paragraphs (e)(1)(iv) and (e)(1)(v) of this section, the term *manufacturer's facilities* includes the facilities of the party responsible for compliance with the regulations and the manufacturer's premises, as well as the facilities of other entities working under the authorization of the responsible party in connection with the development and manufacture, but not the marketing, of the equipment.
- (f) For radio frequency devices subject to verification and sold solely to business, commercial, industrial, scientific and medical users (excluding products sold to other parties or for operation in a residential environment), parties responsible for verification of the devices shall have the option of ensuring compliance with the applicable technical specifications of this chapter at each end user's location after installation, provided that the purchase or lease agreement includes a proviso that such a determination of compliance be made and is the responsibility of the party responsible for verification of the equipment.

Certification & User's Manual Information

The following is extracted from Title 47 of the Code of Federal Regulations, Part 2, Subpart J — Equipment Authorization Procedures:

§ 2.901 Basis and Purpose

- (a) In order to carry out its responsibilities under the Communications Act and the various treaties and international regulations, and in order to promote efficient use of the radio spectrum, the Commission has developed technical standards for radio frequency equipment and parts or components thereof. The technical standards applicable to individual types of equipment are found in that part of the rules governing the service wherein the equipment is to be operated.¹ *In addition to the technical standards provided, the rules governing the service may require that such equipment be verified by the manufacturer or importer, be authorized under a Declaration of Conformity, or receive an equipment authorization from the Commission by one of the following procedures: certification or registration.*
- (b) The following sections describe the verification procedure, the procedure for a Declaration of Conformity, and the procedures to be followed in obtaining certification from the Commission and the conditions attendant to such a grant.

§ 2.907 Certification.

- (a) Certification is an equipment authorization issued by the Commission, based on representation and test data submitted by the applicant.
- (b) Certification attaches to all units subsequently marketed by the grantee which are identical (see Section 2.908) to the sample tested except for permissive changes or other variations authorized by the Commission pursuant to Section 2.1043.

¹ In this case, the equipment is subject to the rules of Part 15. More specifically, the equipment falls under Subpart B (of Part 15), which deals with unintentional radiators.

Certification & User's Manual Information

§ 2.948 Description of measurement facilities.

- (a) Each party making measurements of equipment that is subject to an equipment authorization under Part 15 or Part 18 of this chapter, regardless of whether the measurements are filed with the Commission or kept on file by the party responsible for compliance of equipment marketed within the U.S. or its possessions, shall compile a description of the measurement facilities employed.
- (1) If the measured equipment is subject to the verification procedure, the description of the measurement facilities shall be retained by the party responsible for verification of the equipment.
- (i) *If the equipment is verified through measurements performed by an independent laboratory, it is acceptable for the party responsible for verification of the equipment to rely upon the description of the measurement facilities retained by or placed on file with the Commission by that laboratory. In this situation, the party responsible for the verification of the equipment is not required to retain a duplicate copy of the description of the measurement facilities.*
- (ii) If the equipment is verified based on measurements performed at the installation site of the equipment, no specific site calibration data is required. It is acceptable to retain the description of the measurement facilities at the site at which the measurements were performed.
- (2) If the equipment is to be authorized by the Commission under the certification procedure, the description of the measurement facilities shall be filed with the Commission's Laboratory in Columbia, Maryland. The data describing the measurement facilities need only be filed once but must be updated as changes are made to the measurement facilities or as otherwise described in this section. At least every three years, the organization responsible for filing the data with the Commission shall certify that the data on file is current.

Certification & User's Manual Information

1. Label and User's Manual Information

The following is extracted from Title 47 of the Code of Federal Regulations, Part 15, Subpart A — General:

§ 15.19 Labeling requirements.

(a) *In addition to the requirements in Part 2 of this chapter, a device subject to certification or verification shall be labeled as follows:*

- (1) Receivers associated with the operation of a licensed radio service, e.g., FM broadcast under Part 73 of this chapter, land mobile operation under Part 90, etc., shall bear the following statement in a conspicuous location on the device:

This device complies with Part 15 of the FCC Rules. Operation is subject to the condition that this device does not cause harmful interference.

- (2) A stand-alone cable input selector switch, shall bear the following statement in a conspicuous location on the device:

This device is verified to comply with Part 15 of the FCC Rules for use with cable television service.

- (3) All other devices shall bear the following statement in a conspicuous location on the device:

This device complies with Part 15 of the FCC Rules. Operation is subject to the following two conditions: (1) This device may not cause harmful interference, and (2) this device must accept any interference received, including interference that may cause undesired operation.

- (4) Where a device is constructed in two or more sections connected by wires and marketed together, the statement specified under paragraph (a) of this section is required to be affixed only to the main control unit.

- (5) When the device is so small or for such use that it is not practicable to place the statement specified under paragraph (a) of this section on it, the information required by this paragraph shall be placed in a prominent location in the instruction manual or pamphlet supplied to the user or, alternatively, shall be placed on the container in which the device is marketed. However, the FCC identifier or the unique identifier, as appropriate, must be displayed on the device.

§ 15.21 Information to user.

The user's manual or instruction manual for an intentional or unintentional radiator shall caution the user that changes or modifications not expressly approved by the party responsible for compliance could void the user's authority to operate the equipment.

Verification & User's Manual Information

The following is extracted from Title 47 of the Code of Federal Regulations, Part 15, Subpart B — Unintentional Radiators:

§ 15.105 Information to the user.

- (a) For a Class A digital device or peripheral, the instructions furnished the user shall include the following or similar statement, placed in a prominent location in the text of the manual:

Note: This equipment has been tested and found to comply with the limits for a Class A digital device, pursuant to Part 15 of the FCC Rules. These limits are designed to provide reasonable protection against harmful interference when the equipment is operated in a commercial environment. This equipment generates, uses, and can radiate radio frequency energy and, if not installed and used in accordance with the instruction manual, may cause harmful interference to radio communications. Operation of this equipment in a residential area is likely to cause harmful interference in which case the user will be required to correct the interference at own expense.

- (b) For a Class B digital device or peripheral, the instructions furnished the user shall include the following or similar statement, placed in a prominent location in the text of the manual:

Note: This equipment has been tested and found to comply with the limits for a Class B digital device, pursuant to Part 15 of the FCC Rules. These limits are designed to provide reasonable protection against harmful interference when the equipment is operated in a residential environment. This equipment generates, uses, and can radiate radio frequency energy and, if not installed and used in accordance with the instruction manual, may cause harmful interference to radio communications. However, there is no guarantee that interference will not occur in a particular installation. If this equipment does cause harmful interference to radio or television reception, which can be determined by turning the equipment off and on, the user is encouraged to try to correct the interference by one or more of the following measures:

- Reorient or relocate the receiving antenna.
- Increase the separation between the equipment and receiver.
- Connect the equipment into an outlet on a circuit different from that to which the receiver is connected.
- Consult the dealer or an experienced radio/TV technician for help.

End of Report