

Report on the RF Testing of:

KYOCERA Corporation
Mobile Phone, Model: EB1056
FCC ID: JOYEB1056

In accordance with FCC Part 27 Subpart C
and FCC Part 27 Subpart H

Prepared for: KYOCERA Corporation
Yokohama Office 2-1-1 Kagahara, Tsuzuki-ku
Yokohama-shi, Kanagawa, Japan
Phone: +81-45-943-6253 Fax: +81-45-943-6314



Japan

Add value.
Inspire trust.

COMMERCIAL-IN-CONFIDENCE

Document Number: JPD-TR-21028-0

SIGNATURE

NAME	JOB TITLE	RESPONSIBLE FOR	ISSUE DATE
Hiroaki Suzuki	Deputy Manager of RF Group	Approved Signatory	2021.05.18

Signatures in this approval box have checked this document in line with the requirements of TÜV SÜD Japan Ltd. document control rules.

EXECUTIVE SUMMARY

A sample(s) of this product was tested and found to be compliant with FCC Part 27 Subpart C and FCC Part 27 Subpart H.



DISCLAIMER AND COPYRIGHT

The results in this report are applicable only to the equipment tested.
This report shall not be re-produced except in full without the written approval of TÜV SÜD Japan Ltd.
Client provided data, for which TÜV SÜD Japan Ltd. take no responsibility, which can affect validity of results within this report is clearly identified.

ACCREDITATION

This test report must not be used by the client to claim product certification, approval, or endorsement by A2LA or any agency of the U.S. Government.

TÜV SÜD Japan Ltd.
Yonezawa Testing Center
5-4149-7 Hachimanpara,
Yonezawa-shi, Yamagata,
992-1128 Japan

Phone: +81 (0) 238 28 2881
Fax: +81 (0) 238 28 2888
www.tuv-sud.jp

Contents

1	Summary of Test	3
1.1	Modification history of the test report.....	3
1.2	Standards.....	3
1.3	Test methods.....	3
1.4	Deviation from standards.....	3
1.5	List of applied test(s) of the EUT.....	3
1.6	Test information.....	3
1.7	Test set up.....	3
1.8	Test period.....	3
2	Equipment Under Test	4
2.1	EUT information.....	4
2.2	Modification to the EUT.....	5
2.3	Variation of family model(s).....	5
2.4	Description of test mode.....	5
3	Configuration of Equipment	6
3.1	Equipment used.....	6
3.2	System configuration.....	6
4	Test Result	7
4.1	Effective Radiated Power.....	7
4.2	Peak to Average Ratio.....	10
4.3	Occupied Bandwidth.....	13
4.4	Band Edge Spurious and Harmonic at Antenna Terminals.....	16
4.5	Radiated Emissions and Harmonic Emissions.....	37
4.6	Frequency Stability.....	41
5	Measurement Uncertainty	43
6	Laboratory Information	44
	Appendix A. Test Equipment	45

1 Summary of Test

1.1 Modification history of the test report

Document Number	Modification History	Issue Date
JPD-TR-21028-0	First Issue	Refer to the cover page

1.2 Standards

CFR47 FCC Part 27 Subpart C
CFR47 FCC Part 27 Subpart H

1.3 Test methods

KDB 971168 D01 Power Meas License Digital Systems v03r01
ANSI/TIA/EIA 603-E-2016
ANSI C63.26-2015

1.4 Deviation from standards

None

1.5 List of applied test(s) of the EUT

Test item section	Test item	Condition	Result	Remark
2.1046	Conducted Output Power	Conducted	PASS	*1
27.50	Effective Radiated Power	Radiated	PASS	-
27.50	Peak to Average Ratio	Conducted	PASS	-
2.1049	Occupied Bandwidth	Conducted	PASS	-
27.53 2.1051	Band Edge Spurious and Harmonic at Antenna Terminal	Conducted	PASS	-
27.53 2.1053	Radiated emissions and Harmonic Emissions	Radiated	PASS	-
27.54 2.1055	Frequency Stability	Conducted	PASS	-

*1: Refer to RF Exposure Report (Test Report_SAR)

1.6 Test information

None

1.7 Test set up

Table-top

1.8 Test period

20-April-2021 - 7-May-2021

2 Equipment Under Test

All information in this chapter was provided by the applicant.

2.1 EUT information

Applicant	KYOCERA Corporation Yokohama Office 2-1-1 Kagahara, Tsuzuki-ku Yokohama-shi, Kanagawa, Japan Phone: +81-45-943-6253 Fax: +81-45-943-6314
Equipment Under Test (EUT)	Mobile Phone
Model number	EB1056
Serial number	350771280003684, 350771280003668, 358451750000674
Trade name	Kyocera
Number of sample(s)	3
EUT condition	Pre-Production
Power rating	Battery: DC 3.8 V
Size	(W) 51.3 mm × (D) 112.9 mm × (H) 18.0 mm
Environment	Indoor and Outdoor use
Terminal limitation	-20°C to 60°C
Hardware version	DMT
Software version	0.030PR
Firmware version	Not applicable
RF Specification	
Frequency of Operation	Up Link LTE Band X VII: 704-716 MHz Down Link LTE Band X VII: 734-746 MHz
Modulation type	QPSK, 16QAM
Emission designator	BW 5M QPSK: 4M52G7D, 16QAM: 4M52W7D BW 10M QPSK: 8M97G7D, 16QAM: 9M01W7D
Effective Radiated Power (E.R.P.)	QPSK: 0.4677 W (26.7 dBm) 16QAM: 0.3802 W (25.8 dBm)
Antenna type	Internal antenna
Antenna gain	-0.4 dBi

2.2 Modification to the EUT

The table below details modifications made to the EUT during the test project.

Modification State	Description of Modification	Modification fitted by	Date of Modification
Model: EB1056, Serial Number: 350771280003684, 350771280003668, 358451750000674			
0	As supplied by the applicant	Not Applicable	Not Applicable

2.3 Variation of family model(s)

2.3.1 List of family model(s)

EB1056 has model with camera and without camera.

2.3.2 Reason for selection of EUT

Not applicable

2.4 Description of test mode

The EUT had been tested under operating condition.
There are three channels have been tested as following:

Band	Modulation	Bandwidth	Channel	Frequency [MHz]
LTE Band X VII	QPSK, 16QAM	5 MHz	23755	706.5
			23790	710.0
			23825	713.5
		10 MHz	23780	709.0
			23790	710.0
			23800	711.0

The field strength of spurious emissions was measured at each position of all three axis X, Y and Z to compare the level, and the maximum noise.

The worst emission was found in X-axis, Open, Without camera and the worst case recorded.

Pre-scan has been conducted to determine the worst-case mode from all possible combinations between available modulations, data rates and antenna ports.

3 Configuration of Equipment

Numbers assigned to equipment on the diagram in “3.2 System configuration” correspond to the list in “3.1 Equipment used”.

This test configuration is based on the manufacture’s instruction.

Cabling and setup(s) were taken into consideration and test data was taken under worse case condition.

3.1 Equipment used

No.	Equipment	Company	Model No.	Serial No.	FCC ID/DoC	Comment
1	Mobile Phone	KYOCERA	EB1056	350771280003684, 350771280003668, 358451750000674	JOYEB1056	EUT

3.2 System configuration

1. Mobile Phone
(EUT)

4 Test Result

4.1 Effective Radiated Power

4.1.1 Measurement procedure

[FCC 27.50]

<Step 1>

The EUT and support equipment are placed on a 1 meter x 1 meter surface, 0.8 meter height styrene foam table. Radiated emission measurements are performed at 3 meter distance with the broadband antenna (Log periodic antenna). The antenna is positioned both the horizontal and vertical planes of polarization and height is varied 1 to 4 meters and stopped at height producing the maximum emission. The bandwidth of the spectrum analyzer is set to 1 MHz. The turntable is rotated by 360 degrees and stopped at azimuth of producing the maximum emission.

<Step 2>

The substitution antenna is replaced by the transmitter antenna (EUT).

The frequency of the signal generator is adjusted to the measurement frequency.

Level of the signal generator is adjusted to the level that is obtained from step 1, and record the emission level of signal generator.

The spectrum analyzer is set to;

- a) Span = 1.5 times the OBW
- b) RBW = 1-5% of the expected OBW, not to exceed 1 MHz
- c) VBW $\geq 3 \times$ RBW
- d) Number of sweep points $\geq 2 \times$ span / RBW
- e) Sweep time = auto-couple
- f) Detector = RMS (power averaging)
- g) If the EUT can be configured to transmit continuously (i.e., burst duty cycle $\geq 98\%$), then set the trigger to free run.
- h) If the EUT cannot be configured to transmit continuously (i.e., burst duty cycle $< 98\%$), then use a sweep trigger with the level set to enable triggering only on full power bursts and configure the EUT to transmit at full power for the entire duration of each sweep. Ensure that the sweep time is less than or equal to the transmission burst duration.
- i) Trace average at least 100 traces in power averaging (i.e., RMS) mode.
- j) Compute the power by integrating the spectrum across the OBW of the signal using the instrument's band power measurement function, with the band limits set equal to the OBW band edges.

If the instrument does not have a band power function, then sum the spectrum levels (in linear power units) at intervals equal to the RBW extending across the entire OBW of the spectrum.

- Test configuration

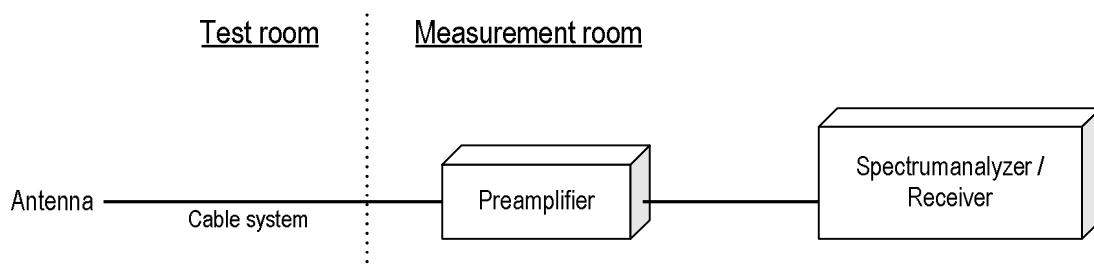

4.1.2 Calculation method

Result (ERP) = Ant. Input - Cable loss + Antenna Gain
 Margin = Limit – Result (ERP)

Example:

Limit @ 710MHz : 34.7 dBm

Ant. Input = 25.5 dBm Cable loss = 0.7 dB Ant. Gain = -10.1 dBd

Result = 25.5 - 0.7 + (-10.1) = 14.7 dBm

Margin = 34.7 – 14.7 = 20.0 dB

4.1.3 Limit

3 W (34.7 dBm)

4.1.4 Test data

Date	: 20-April-2021	Test engineer	: <u>Chiaki Kanno</u>
Temperature	: 22.2 [°C]		
Humidity	: 35.6 [%]		
Test place	: 3m Semi-anechoic chamber		
Date	: 21-April-2021	Test engineer	: <u>Chiaki Kanno</u>
Temperature	: 22.1 [°C]		
Humidity	: 32.8 [%]		
Test place	: 3m Semi-anechoic chamber		
Date	: 22-April-2021	Test engineer	: <u>Chiaki Kanno</u>
Temperature	: 21.6 [°C]		
Humidity	: 31.2 [%]		
Test place	: 3m Semi-anechoic chamber		

**[LTE Band X VII – Open, Without camera]
QPSK, BW 5MHz**

H/V	Frequency [MHz]	S.A Reading [dBm]	Ant. Input [dBm]	Cable loss [dB]	Ant.Gain [dBd]	Result [dBm]	Limit [dBm]	Margin [dB]
H	706.5	-9.4	32.5	0.7	-5.6	26.2	34.70	8.5
H	710.0	-9.1	33.0	0.7	-5.6	26.7	34.70	8.0
H	713.5	-9.6	32.7	0.7	-5.7	26.3	34.70	8.4

16QAM, BW 5MHz

H/V	Frequency [MHz]	S.A Reading [dBm]	Ant. Input [dBm]	Cable loss [dB]	Ant.Gain [dBd]	Result [dBm]	Limit [dBm]	Margin [dB]
H	706.5	-10.1	31.8	0.7	-5.6	25.5	34.70	9.2
H	710.0	-10.0	32.1	0.7	-5.6	25.8	34.70	8.9
H	713.5	-10.6	31.7	0.7	-5.7	25.3	34.70	9.4

QPSK, BW 10MHz

H/V	Frequency [MHz]	S.A Reading [dBm]	Ant. Input [dBm]	Cable loss [dB]	Ant.Gain [dBd]	Result [dBm]	Limit [dBm]	Margin [dB]
H	709.0	-9.1	32.9	0.7	-5.6	26.6	34.70	8.1
H	710.0	-9.2	32.9	0.7	-5.6	26.6	34.70	8.1
H	711.0	-9.4	32.7	0.7	-5.6	26.4	34.70	8.3

16QAM, BW 10MHz

H/V	Frequency [MHz]	S.A Reading [dBm]	Ant. Input [dBm]	Cable loss [dB]	Ant.Gain [dBd]	Result [dBm]	Limit [dBm]	Margin [dB]
H	709.0	-10.1	31.9	0.7	-5.6	25.6	34.70	9.1
H	710.0	-10.0	32.1	0.7	-5.6	25.8	34.70	8.9
H	711.0	-10.0	32.1	0.7	-5.6	25.8	34.70	8.9

4.2 Peak to Average Ratio

4.2.1 Measurement procedure

[FCC 27.50]

The peak to average ratio was measured with a spectrum analyzer connected to the antenna terminal.

The spectrum analyzer is set to;

- a) Power Stat CCDF mode
- b) Set resolution / measurement bandwidth \geq signal's occupied bandwidth.
- c) Set the number of counts to a value that stabilizes the measured CCDF curve.
- d) Set the measurement interval as follows:
 - 1) For continuous transmissions, set to 1ms.
 - 2) For burst transmissions, employ an external trigger that is synchronized with the EUT burst timing sequence, or use the internal burst trigger with a trigger level that allows the burst duration.
- e) Record the maximum PAPR level associated with a probability of 0.1%.

- Test configuration

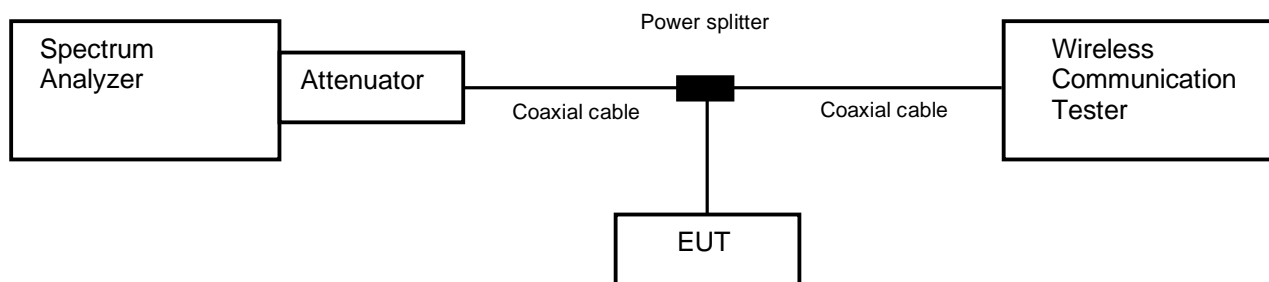

4.2.2 Limit

13 dB or less

4.2.3 Measurement result

Date : 26-April-2021
 Temperature : 21.3 [°C]
 Humidity : 27.1 [%]
 Test place : Shielded room No.4

Test engineer : Taiki Watanabe

Band	Channel	Frequency [MHz]	Modulation	BW [MHz]	RB	Peak to Average Power Ratio [dB]	Limit [dB]
LTE Band X VII	23790	710.0	QPSK	5	25-0	5.07	13
				10	50-0	4.59	13
			16QAM	5	25-0	5.92	13
				10	50-0	6.18	13

4.2.4 Trace data

[LTE Band X VII]
 Channel: 23790
 QPSK, BW 5MHz, RB25-0



QPSK, BW 10MHz, RB50-0

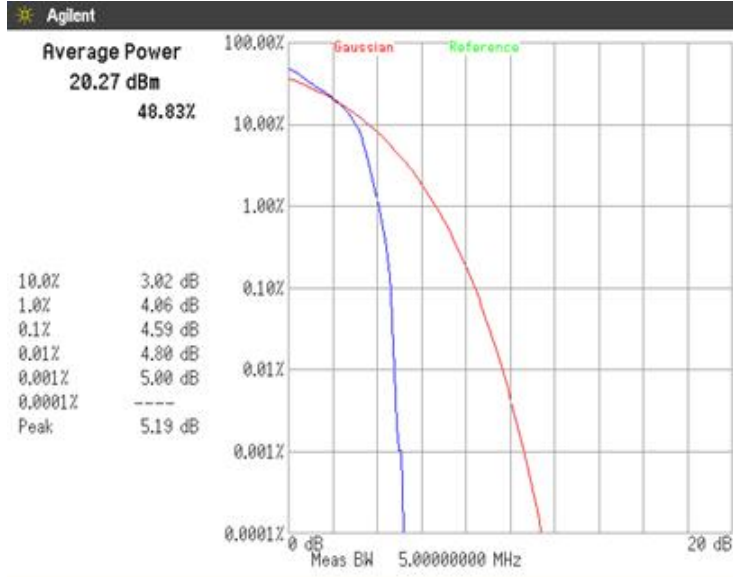

16QAM, BW 5MHz, RB25-0

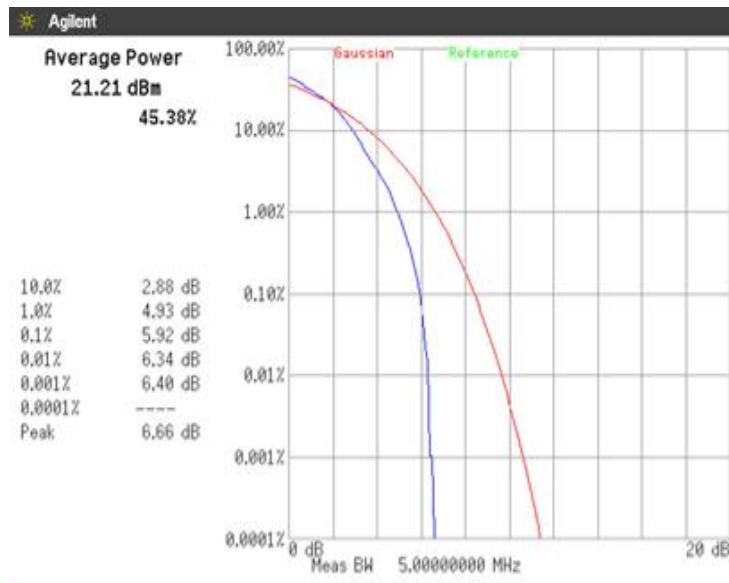

16QAM, BW 10MHz, RB50-0



4.3 Occupied Bandwidth

4.3.1 Measurement procedure

[FCC 2.1049]

The Occupied bandwidth was measured with a spectrum analyzer connected to the antenna terminal.

The spectrum analyzer is set to;

- a) RBW = 1-5% of the expected OBW & VBW ≥ 3 x RBW
- b) Detector = Peak
- c) Trace mode = Max hold
- d) Sweep time = auto-couple

- Test configuration

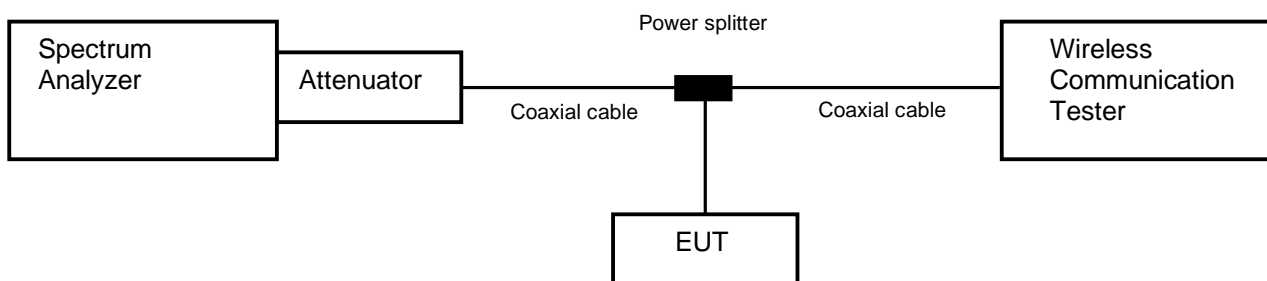

4.3.2 Limit

None

4.3.3 Measurement result

Date : 26-April-2021
 Temperature : 21.3 [°C]
 Humidity : 27.1 [%]
 Test place : Shielded room No.4

Test engineer :

Taiki Watanabe

BW	Mode	UL RB Allocation	UL RB Start	Frequency [MHz]	26dB Bandwidth [MHz]	99% OBW [MHz]
5MHz	QPSK	12	7	710.0	3.472	2.3888
		25	0		5.048	4.5182
5MHz	16QAM	12	7	710.0	3.360	2.3218
		25	0		5.036	4.5210
10MHz	QPSK	25	12	710.0	5.882	4.6738
		50	0		9.976	8.9706
10MHz	16QAM	25	12	710.0	6.395	4.6818
		50	0		9.929	9.0145



4.3.4 Trace data

[LTE Band X VII]
Channel: 23790

QPSK, BW 5MHz
RB12-7

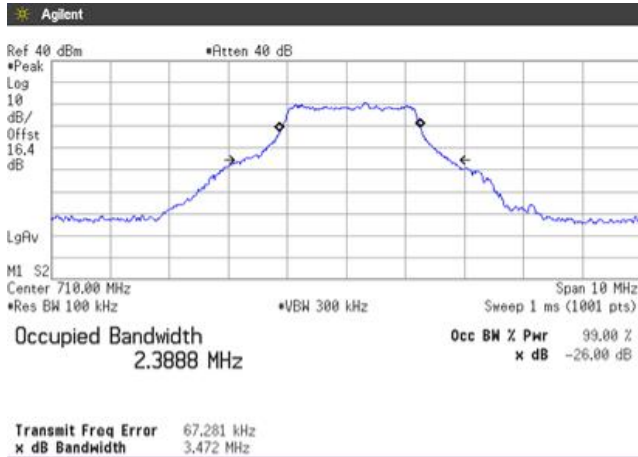

RB25-0

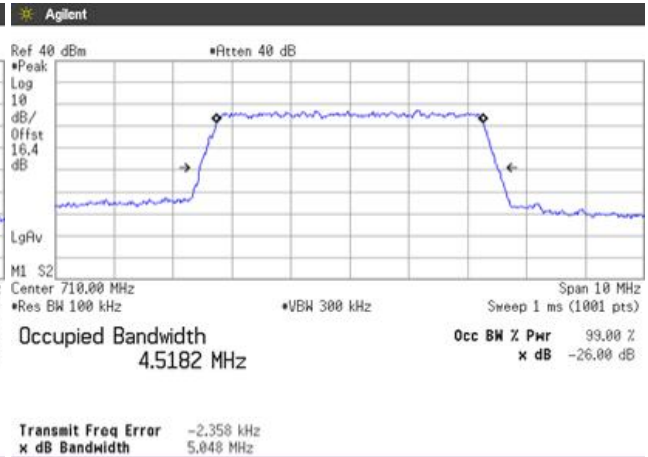

16QAM, BW 5MHz
RB12-7

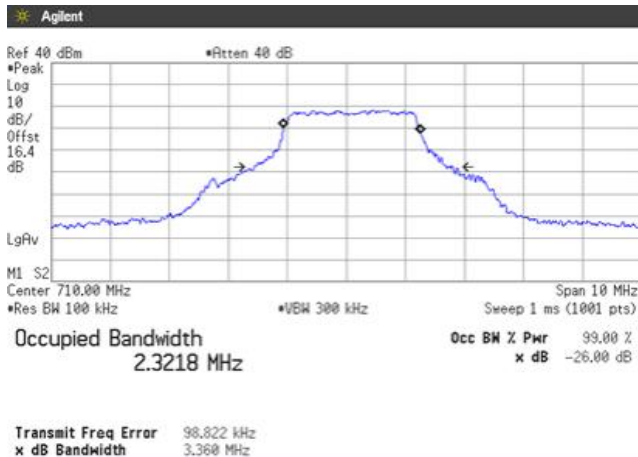

RB25-0

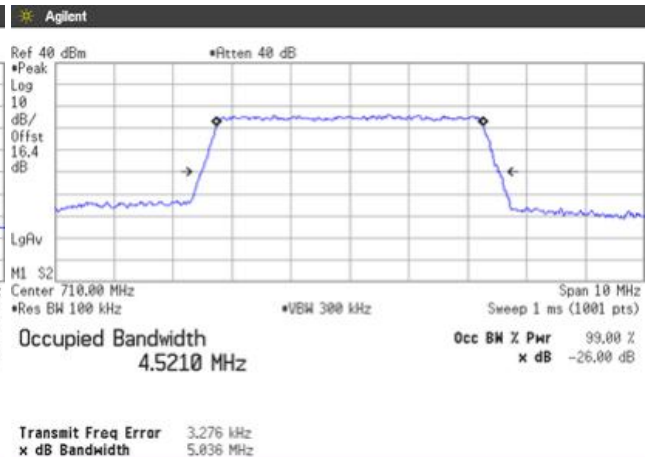



QPSK, BW 10MHz
RB25-12

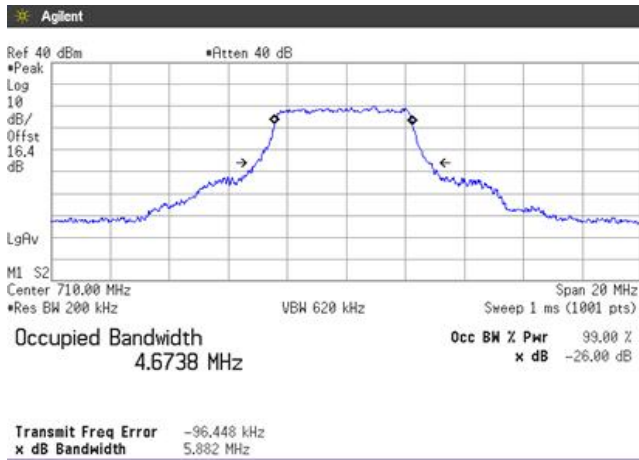

RB50-0

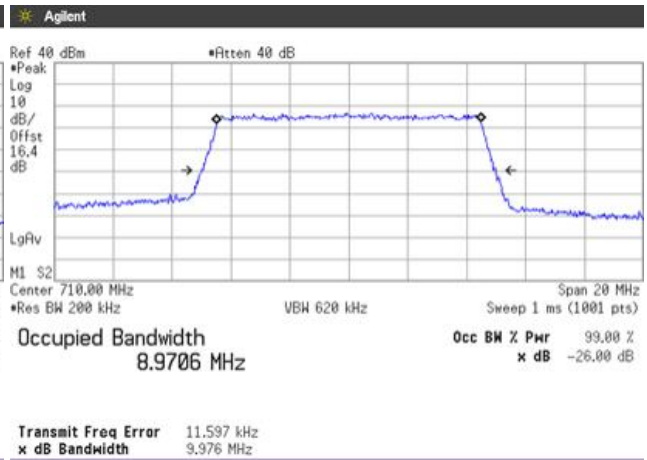

16QAM, BW 10MHz
RB25-12

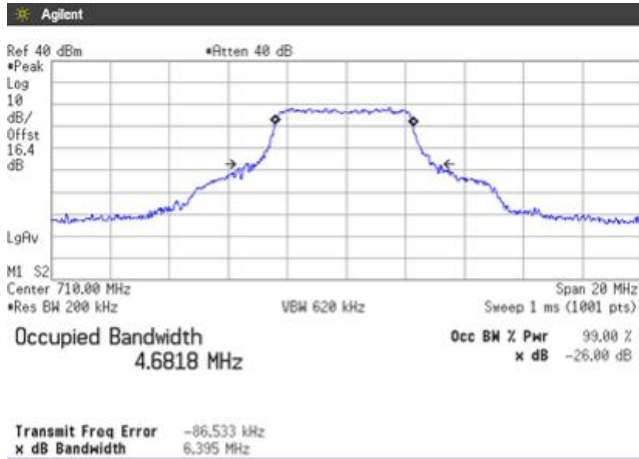

RB50-0

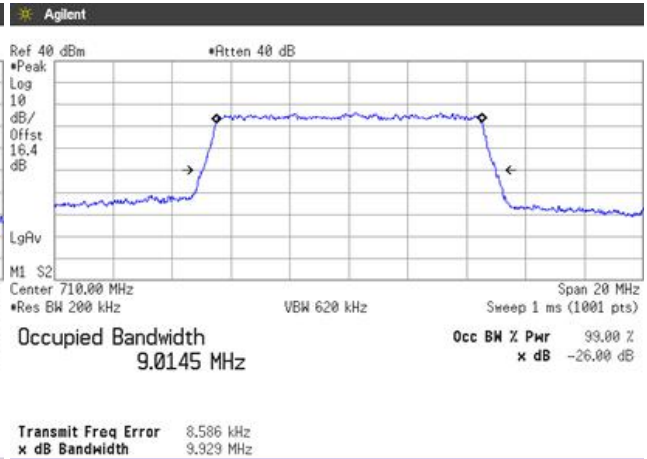

4.4 Band Edge Spurious and Harmonic at Antenna Terminals

4.4.1 Measurement procedure

[FCC 27.53, 2.1051]

The band edge spurious and harmonic was measured with a spectrum analyzer connected to the antenna terminal.

The spectrum analyzer is set to;

<Band Edge>

- Span was set large enough so as to capture all out of band emissions near the band edge
- RBW \geq 1% of the emission bandwidth or 2% of the emission bandwidth
- VBW \geq 3 x RBW
- Detector = RMS
- Trace mode = Max hold
- Sweep time = auto-couple
- Number of sweep point \geq 2 x span / RBW

<Spurious Emissions>

- RBW = 1MHz & VBW \geq 3 x RBW
- Detector = Peak
- Trace mode = Max hold
- Sweep time = auto-couple
- Number of sweep point \geq 2 x span / RBW

- Test configuration

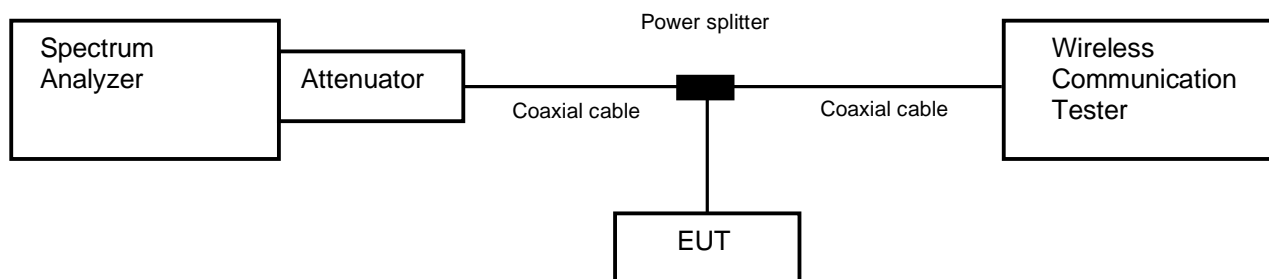

4.4.2 Limit

-13 dB or less



4.4.3 Measurement result

Date : 26-April-2021
 Temperature : 21.3 [°C]
 Humidity : 27.1 [%]
 Test place : Shielded room No.4

Test engineer : Taiki Watanabe

Band	Modulation	Bandwidth	Results	
LTE Band X VII	QPSK	5MHz	See the trace data	PASS
		10MHz	See the trace data	PASS
	16QAM	5MHz	See the trace data	PASS
		10MHz	See the trace data	PASS

4.4.4 Trace data

[LTE Band X VII]
 (Band Edge)
 QPSK, BW 5MHz, RB1-0
 Channel: Low

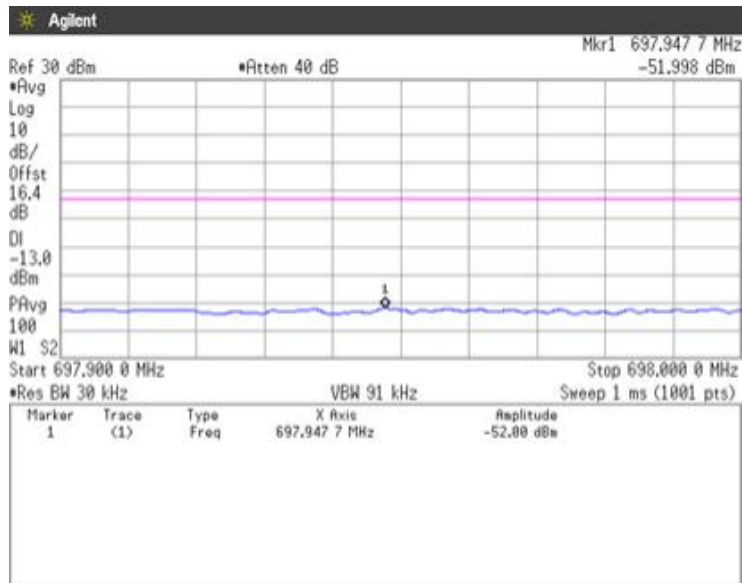
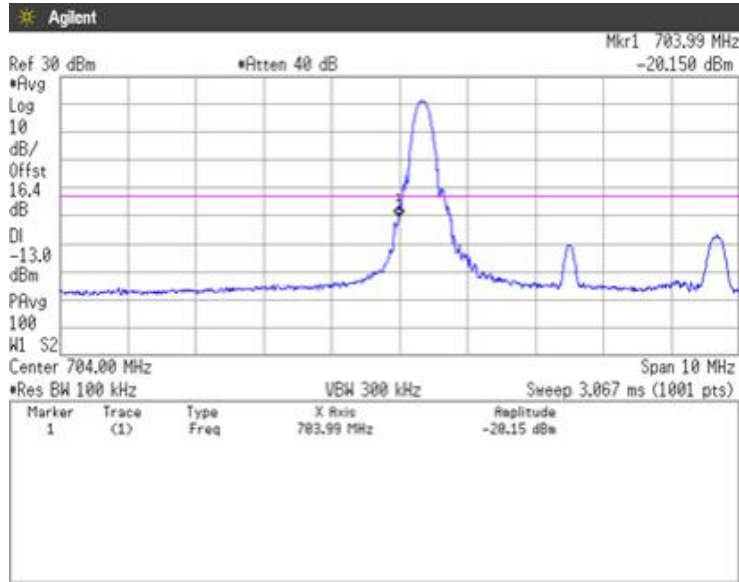



QPSK, BW 5MHz, RB1-24
Channel: High

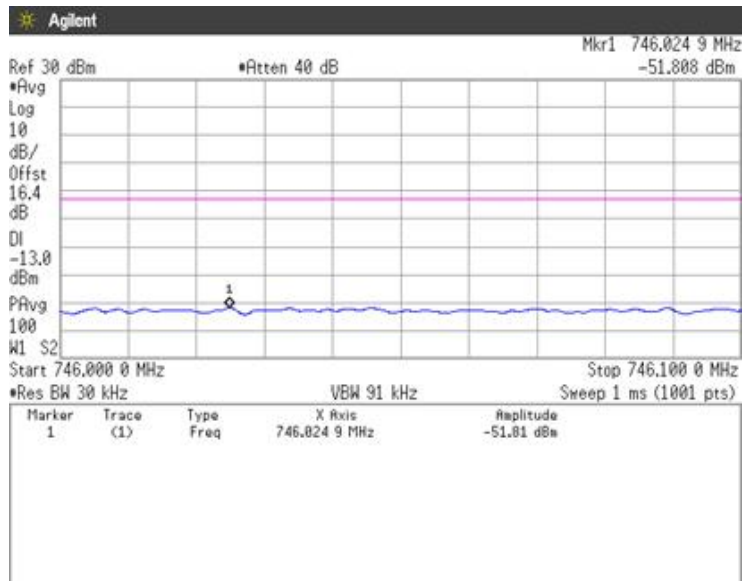
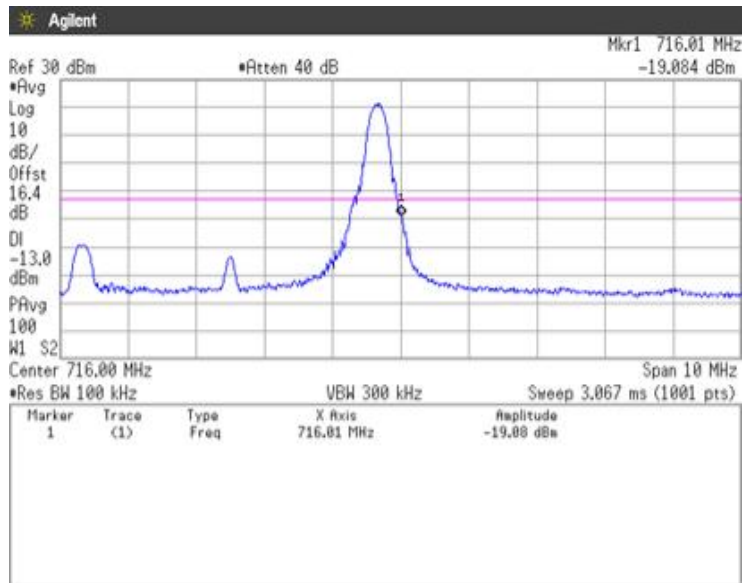



QPSK, BW 5MHz, RB25-0
Channel: Low

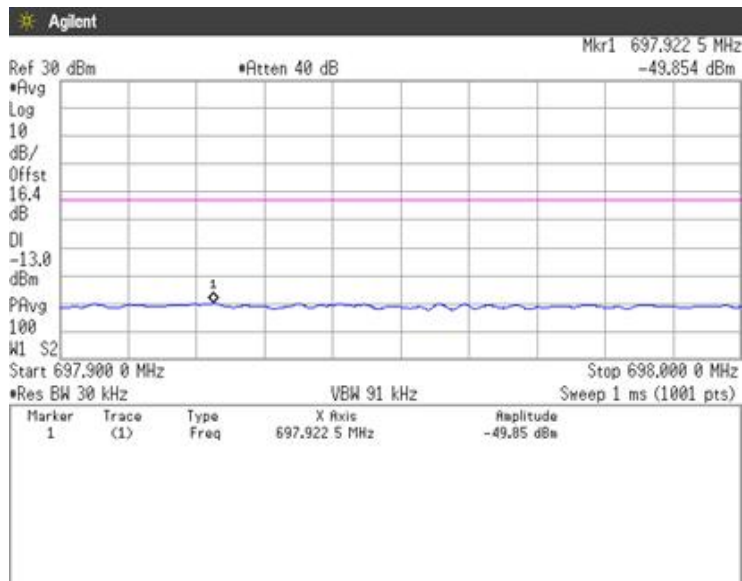
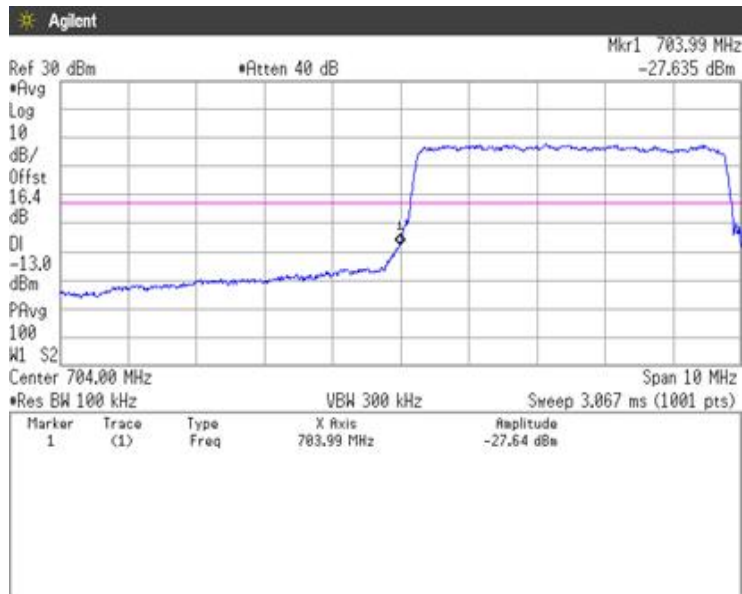



Japan

QPSK, BW 5MHz, RB25-0
Channel: High

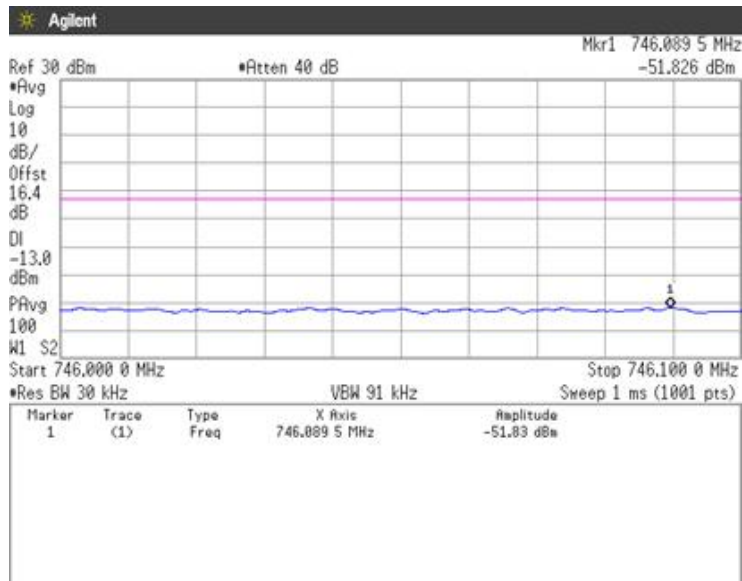
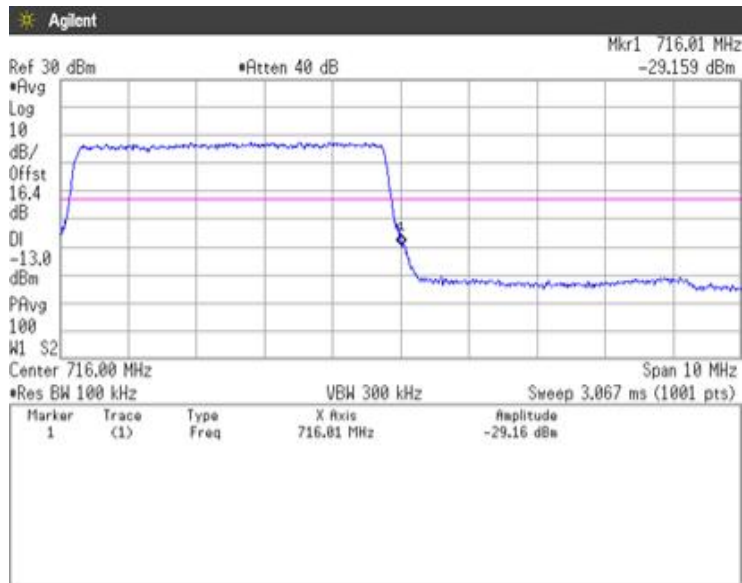

16QAM, BW 5MHz, RB1-0
Channel: Low

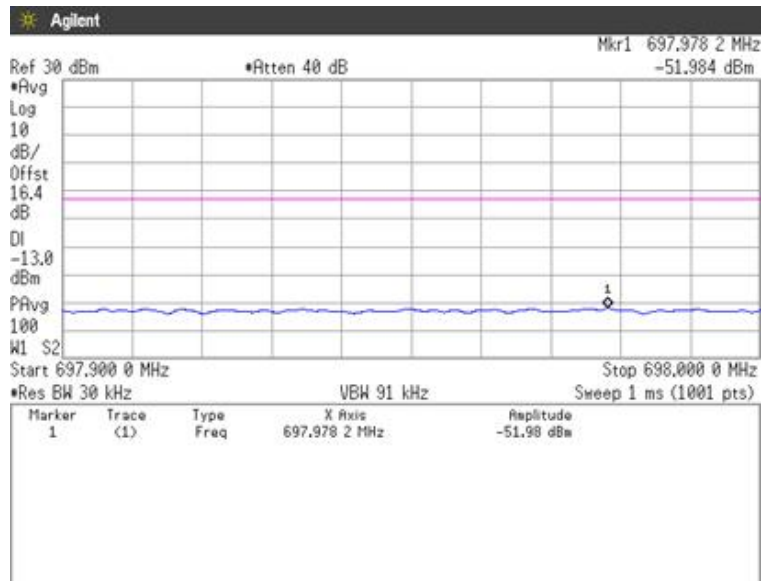
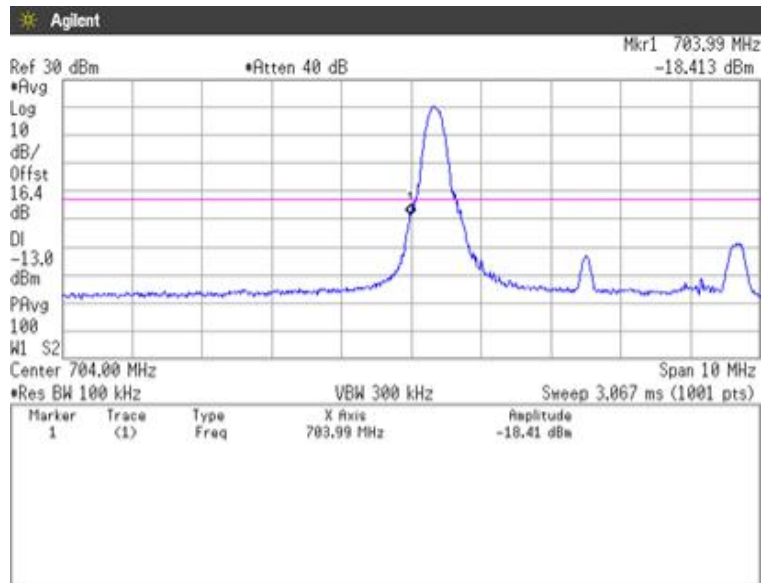

16QAM, BW 5MHz, RB1-24
Channel: High

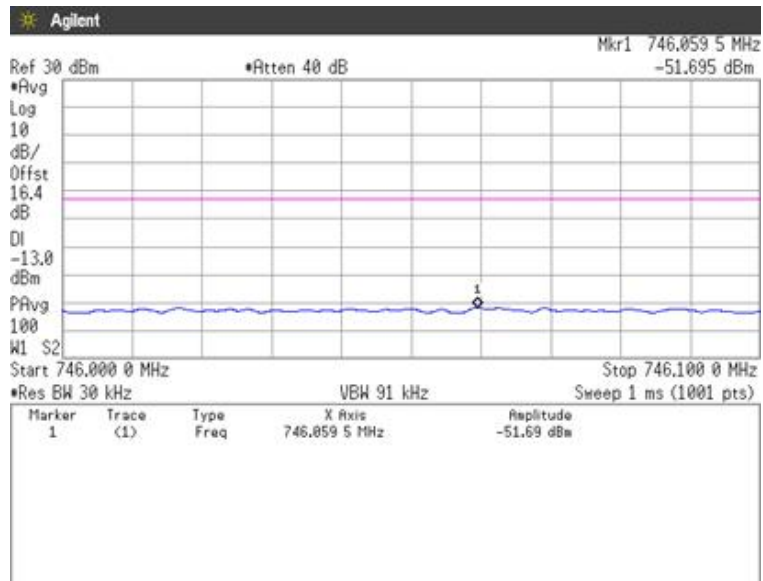
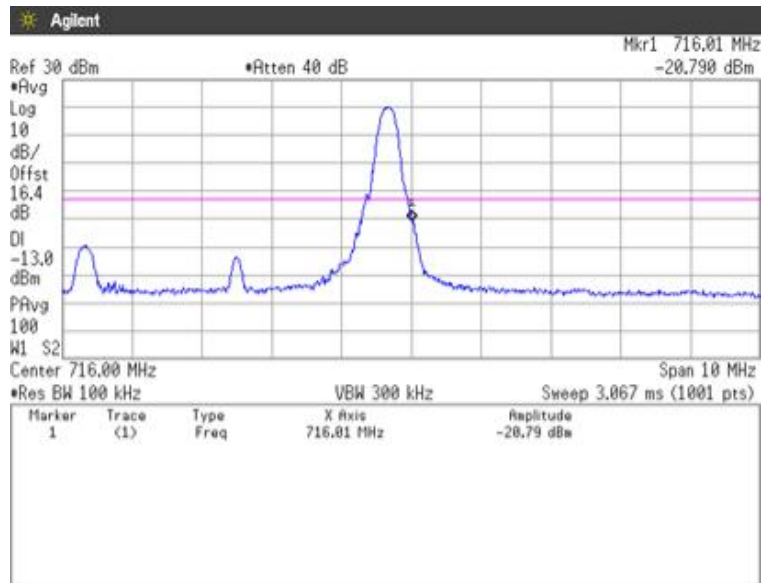



16QAM, BW 5MHz, RB25-0
Channel: Low

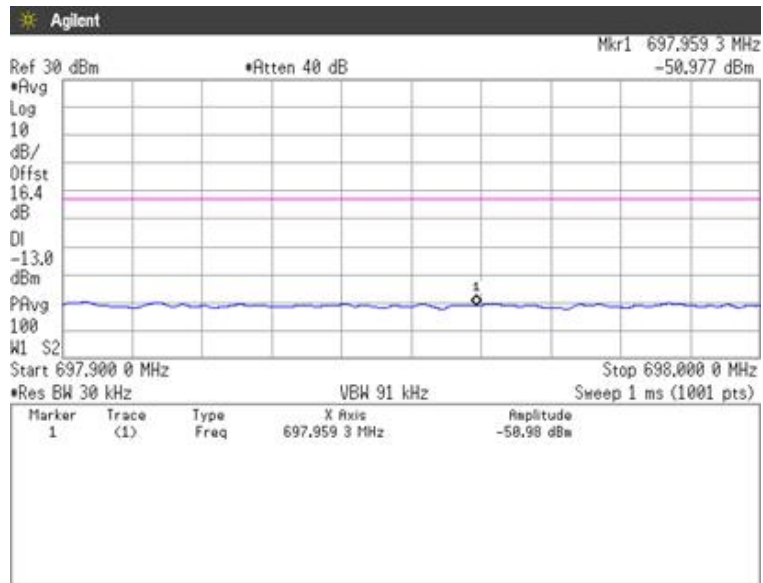
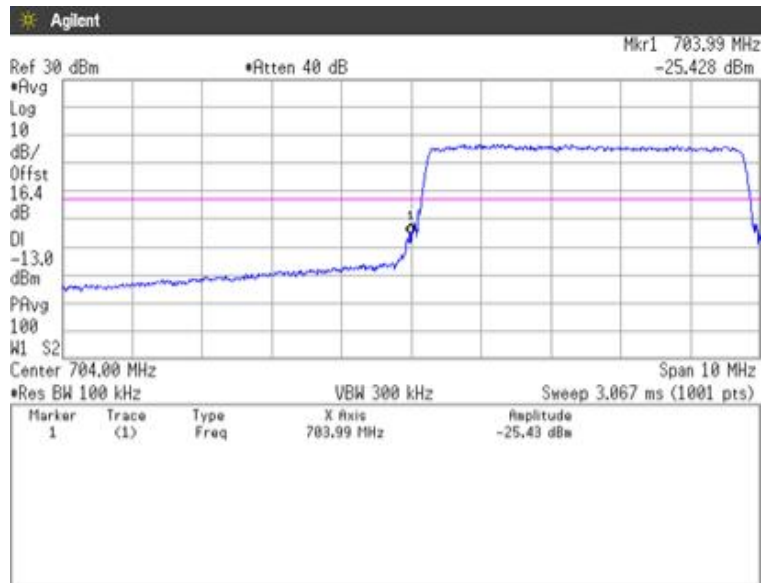

16QAM, BW 5MHz, RB25-0
Channel: High

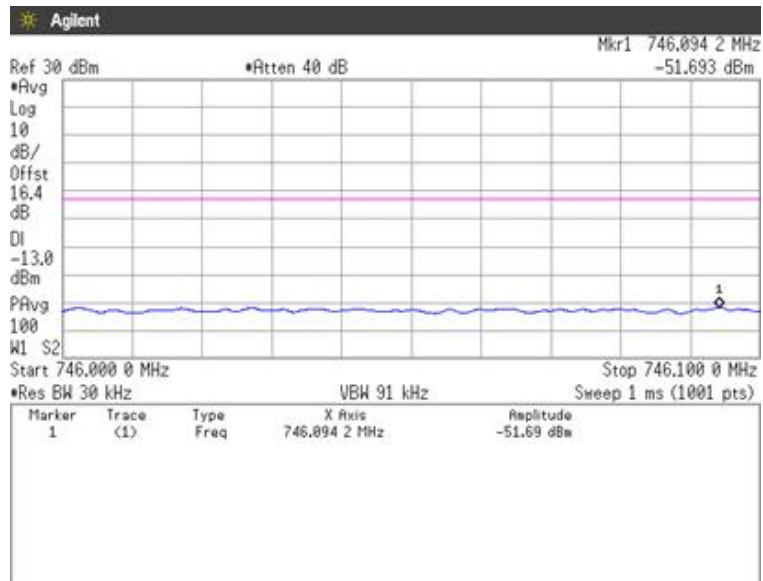
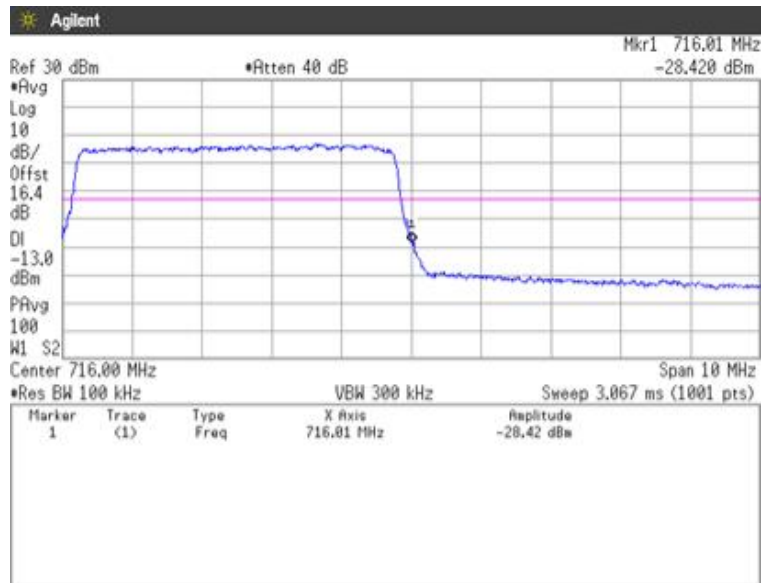

QPSK, BW 10MHz, RB1-0
Channel: Low

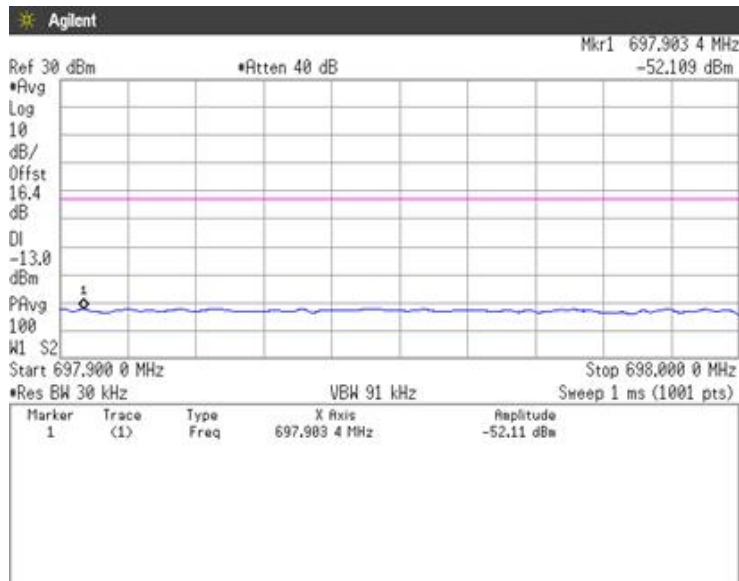
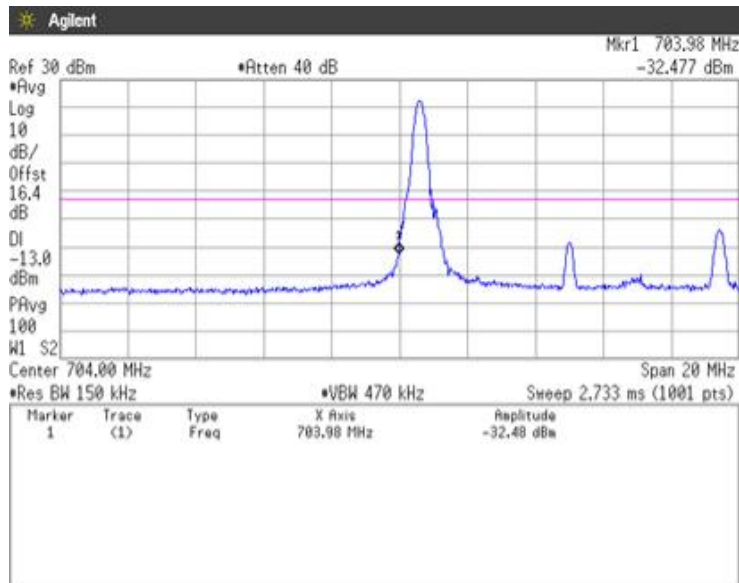



QPSK, BW 10MHz, RB1-49
Channel: High

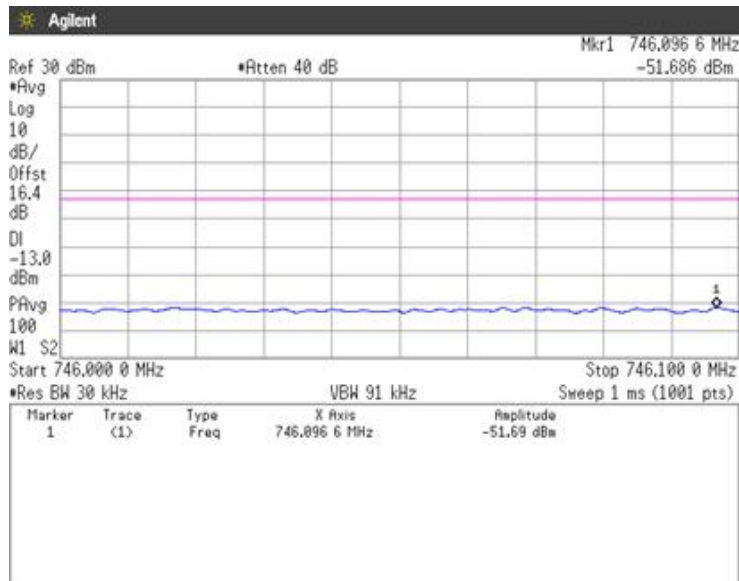
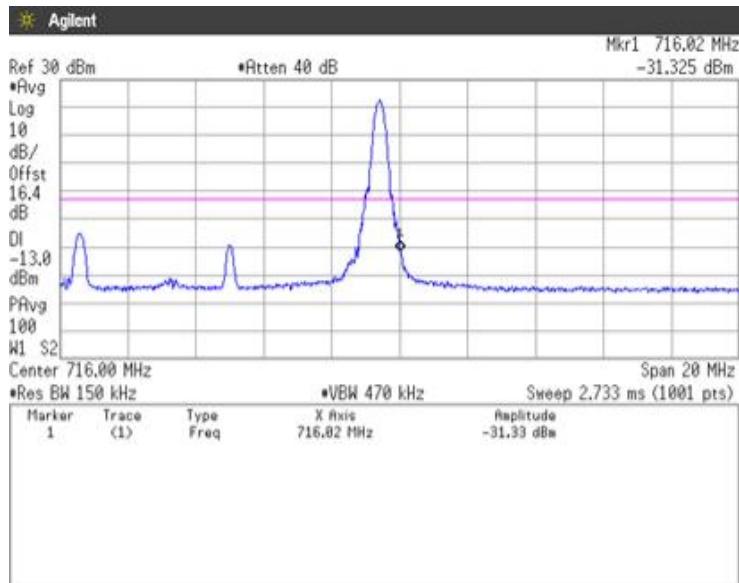



QPSK, BW 10MHz, RB50-0
Channel: Low

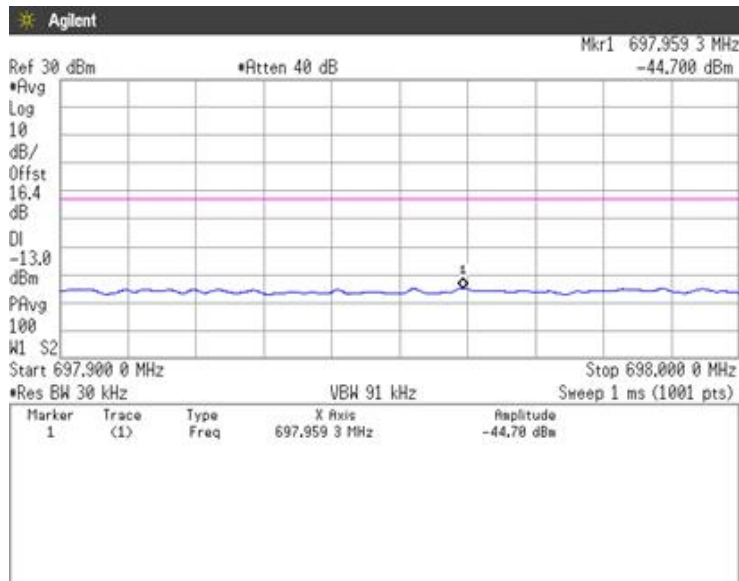
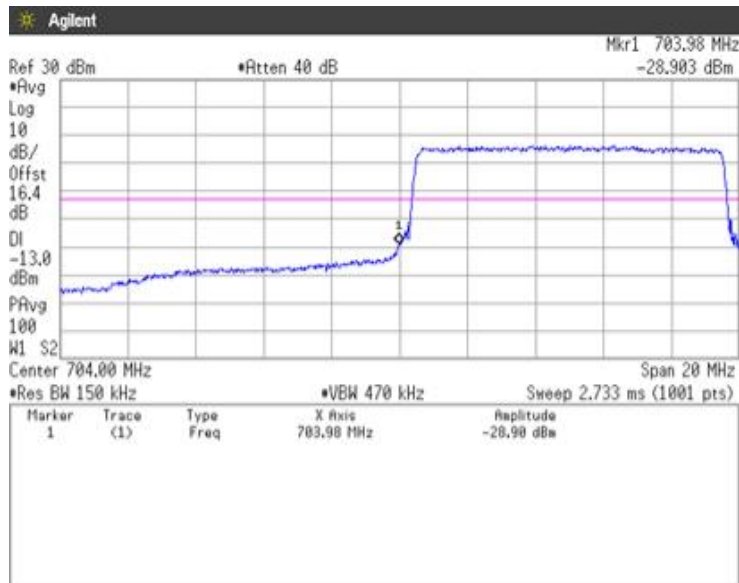



QPSK, BW 10MHz, RB50-0
Channel: High

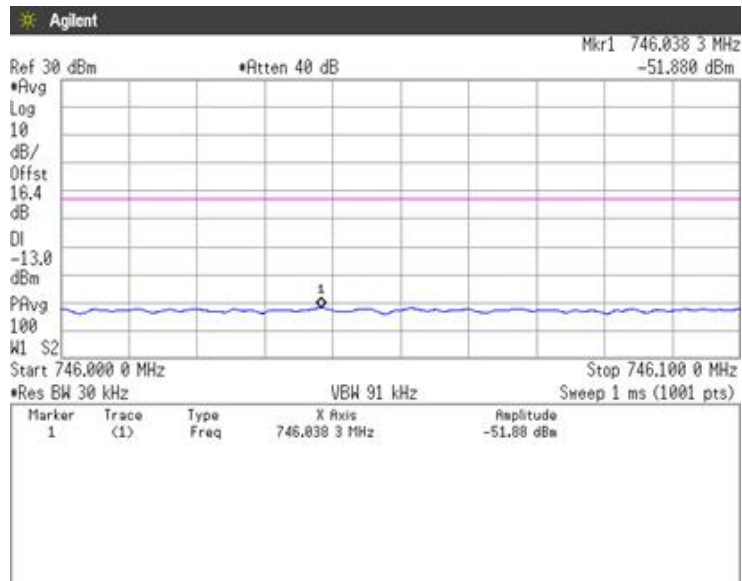
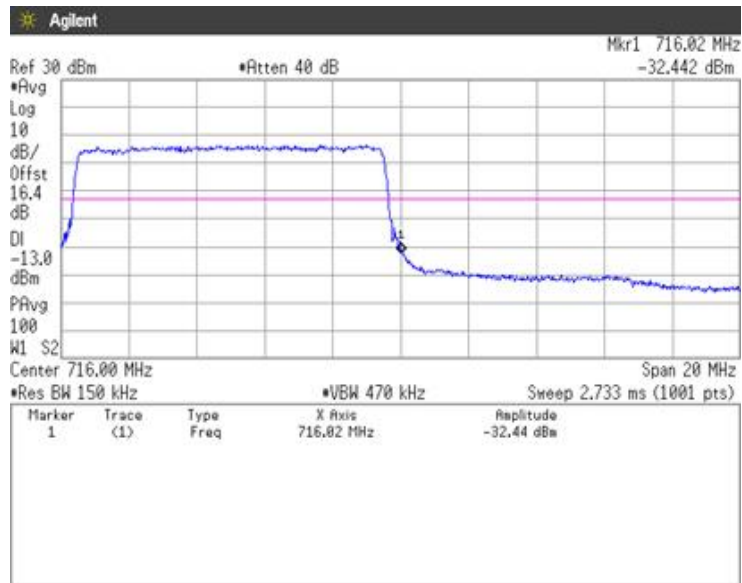



Japan

16QAM, BW 10MHz, RB1-0
Channel: Low

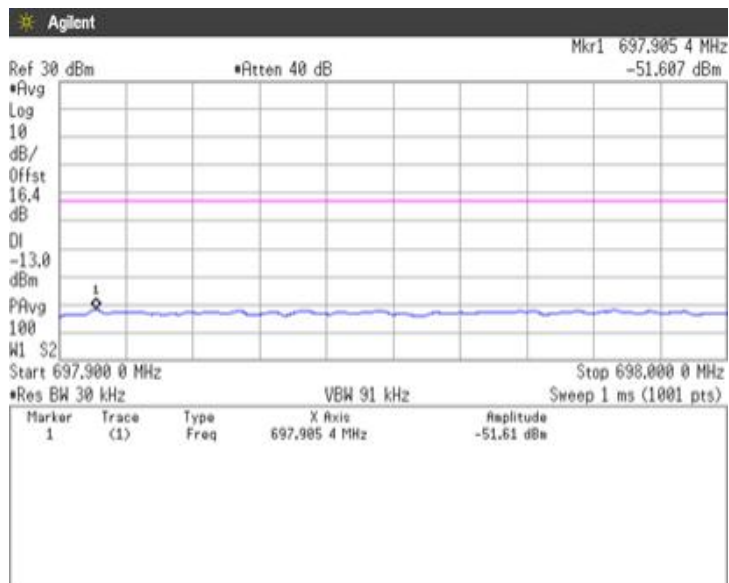
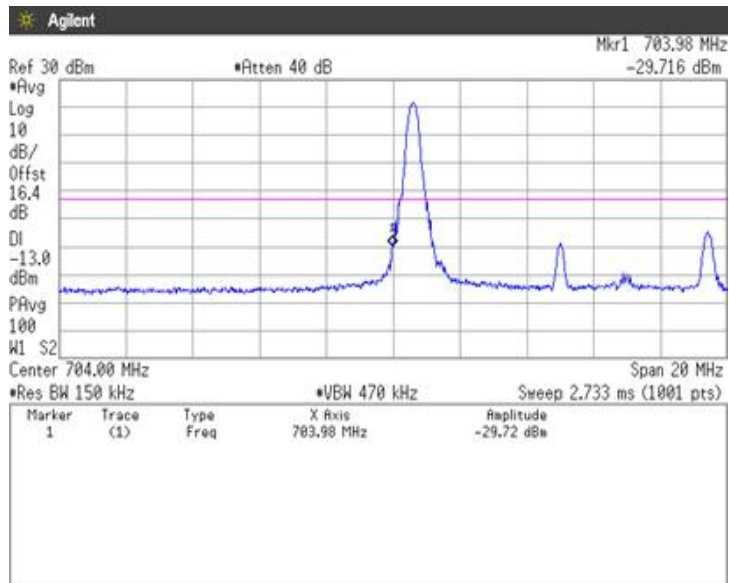



16QAM, BW 10MHz, RB1-49
Channel: High

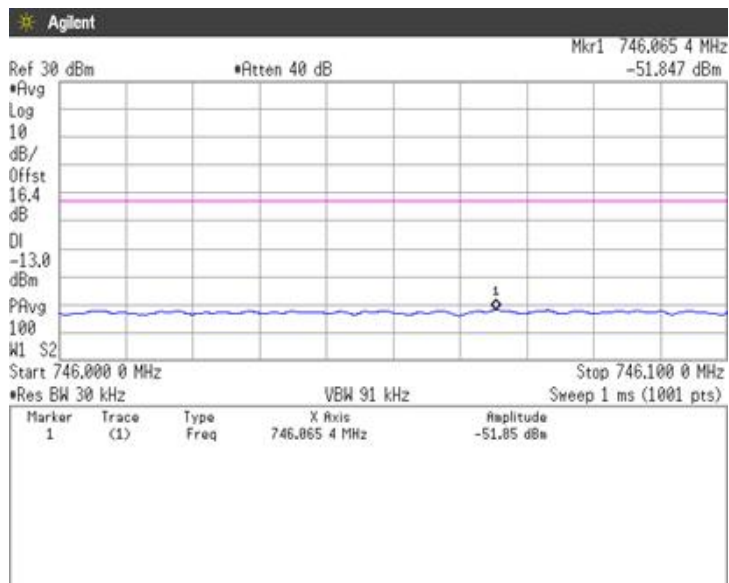
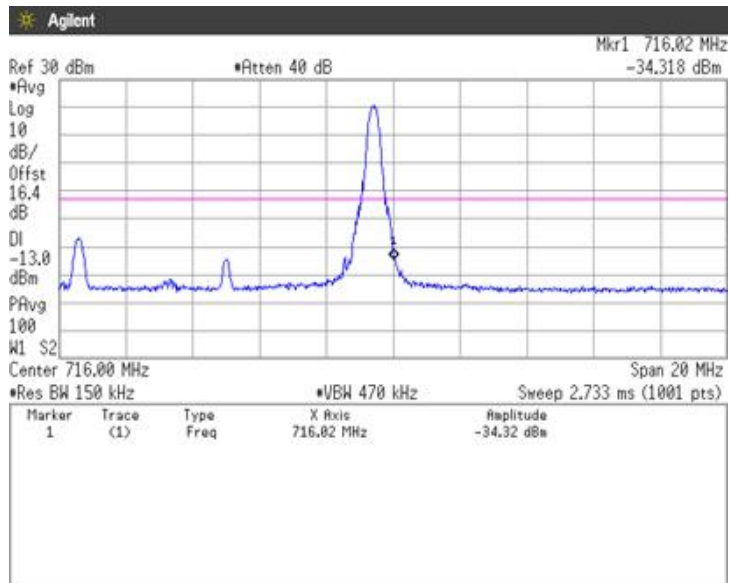



16QAM, BW 10MHz, RB50-0
Channel: Low

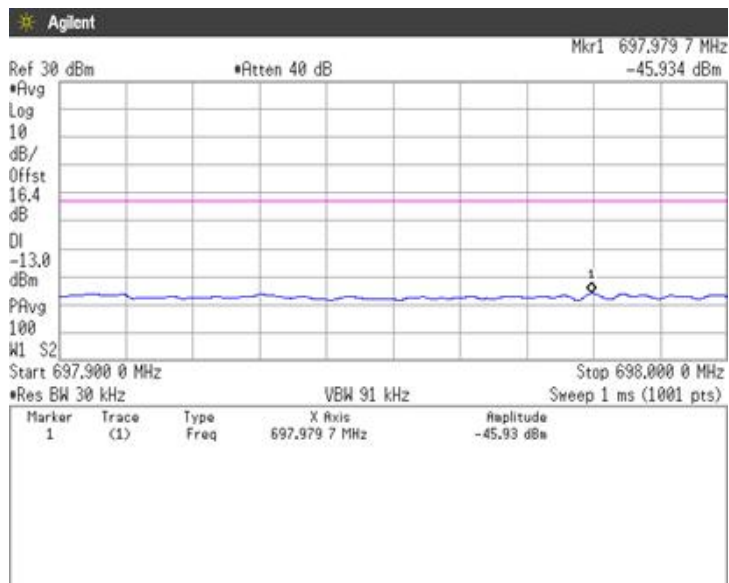
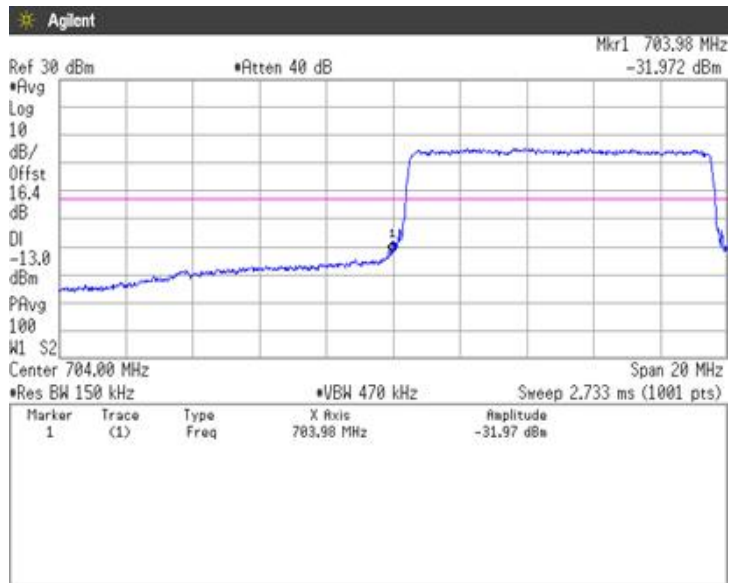



16QAM, BW 10MHz, RB50-0
Channel: High

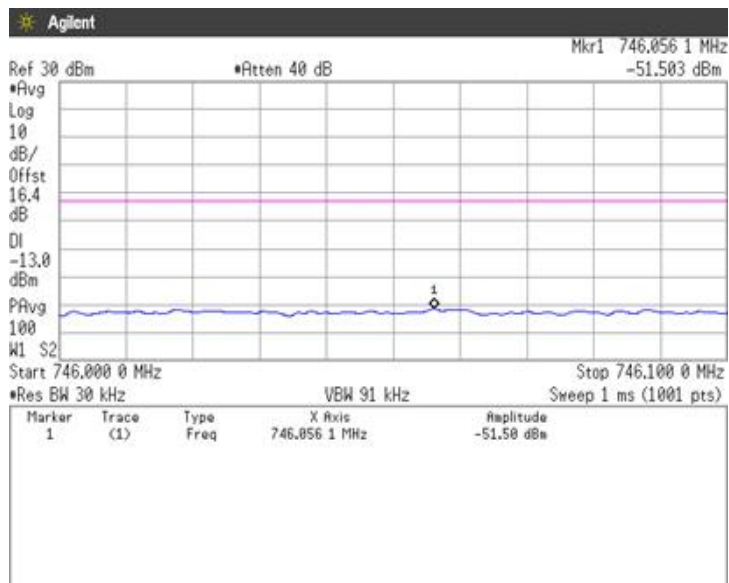
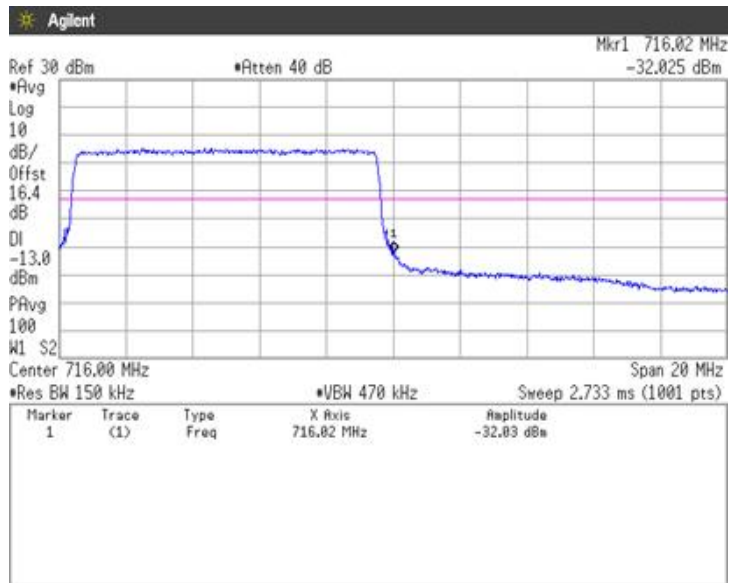



(Spurious Emissions)

Note: Conducted spurious test was measured in the worst case of Effective Radiated Power.

QPSK, BW 5MHz, RB1-13

Channel: 23755

30MHz-5GHz

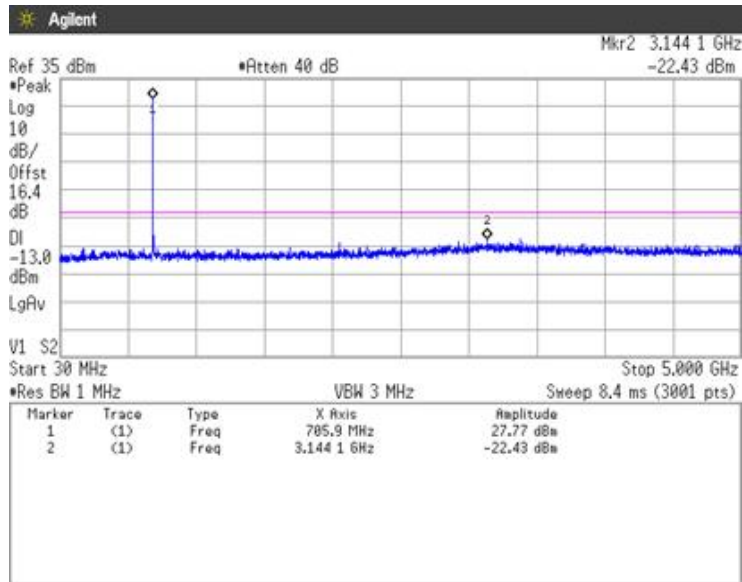

5GHz-10GHz

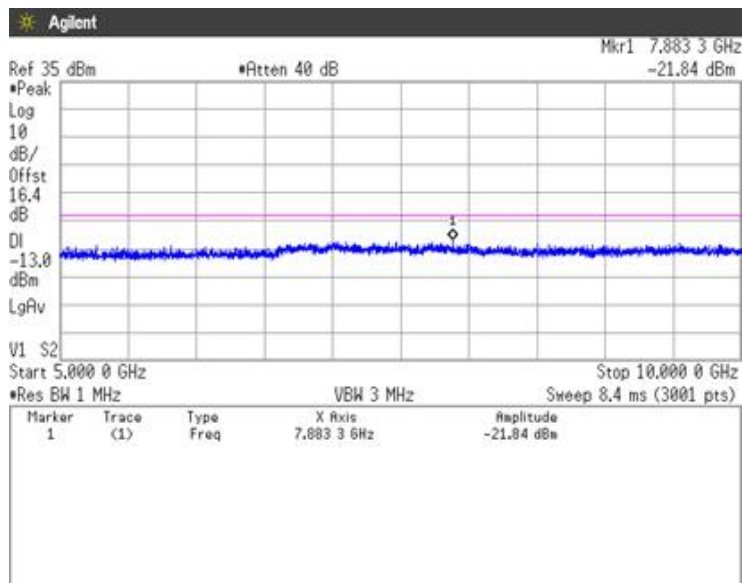



**Channel: 23790
30MHz-5GHz**

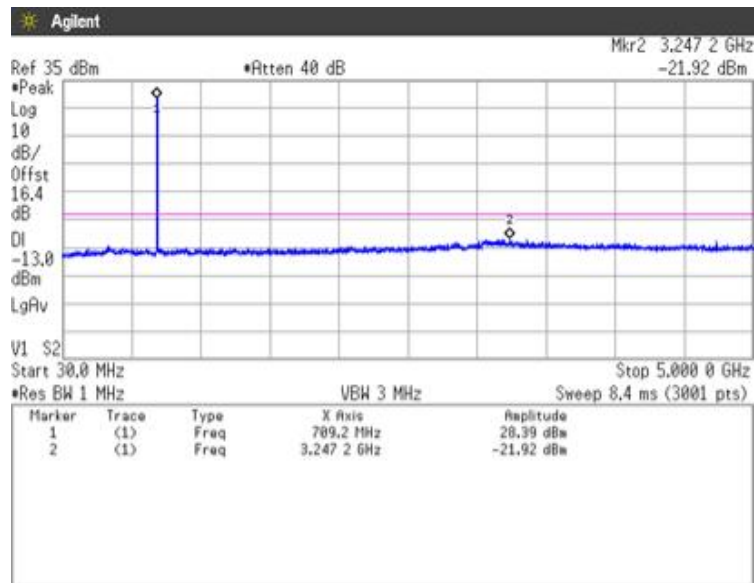

5GHz-10GHz

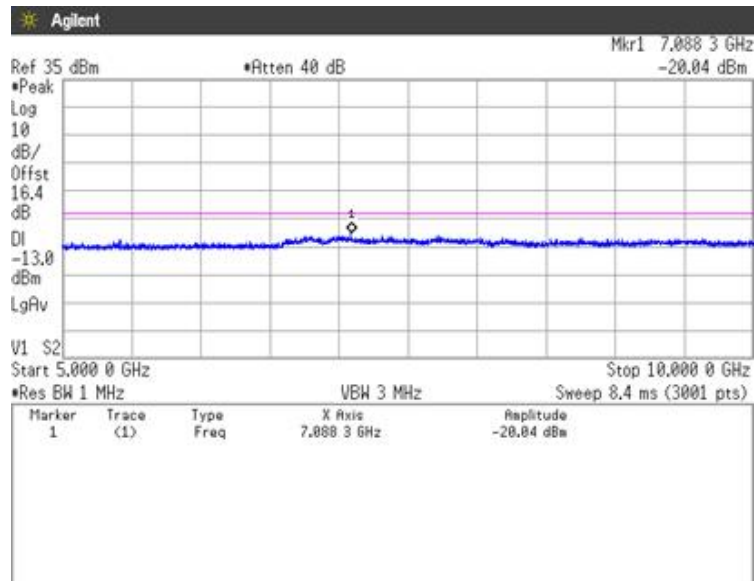



Japan

**Channel: 23825
30MHz-5GHz**

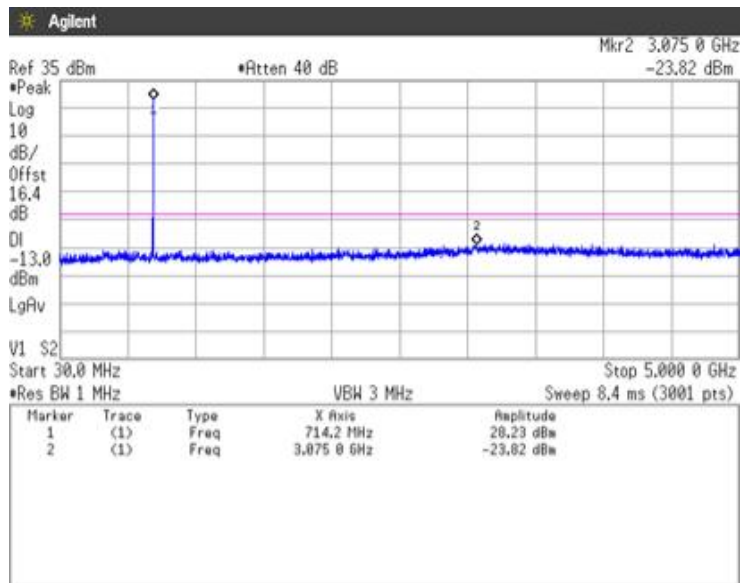

5GHz-10GHz

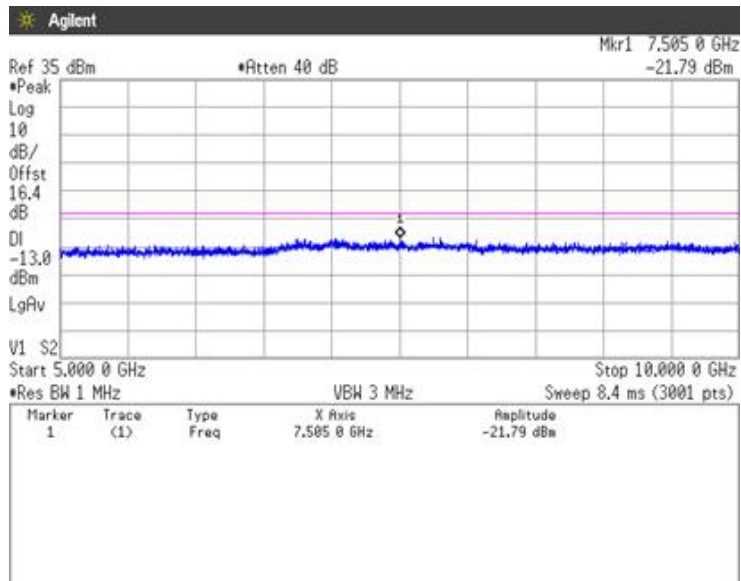

4.5 Radiated Emissions and Harmonic Emissions

4.5.1 Measurement procedure

[FCC 27.53, 2.1053]

<Step 1>

The EUT and support equipment are placed on a 1 meter x 1 meter surface, 0.8 meter height (Below 1GHz) or 0.6 meter x 0.6 meter surface, 1.5 meter height (Above 1GHz) styrene foam table. Radiated emission measurements are performed at 3 meter distance with the broadband antenna (Biconical antenna, Log periodic antenna and double ridged guide antenna). The antenna is positioned both the horizontal and vertical planes of polarization and height is varied 1 to 4 meters and stopped at height producing the maximum emission.

The bandwidth of the spectrum analyzer is set to 1 MHz. The turntable is rotated by 360 degrees and stopped at azimuth of producing the maximum emission. The frequency is investigated up to 20GHz.

<Step 2>

The substitution antenna is replaced by the transmitter antenna (EUT).

The frequency of the signal generator is adjusted to the measurement frequency.

Level of the signal generator is adjusted to the level that is obtained from step 1, and record the emission level of signal generator.

The spectrum analyzer is set to;

- RBW = 100 kHz for below 1GHz and 1MHz for above 1GHz / VBW \geq 3 x RBW
- Detector = Peak
- Trace mode = Max hold
- Sweep time = auto-couple

- Test configuration

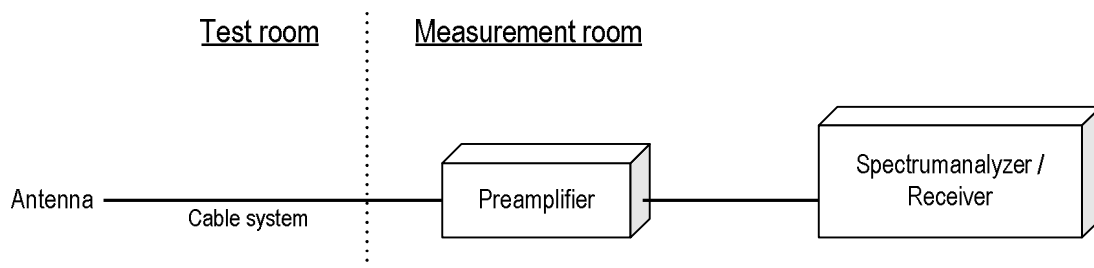



4.5.2 Calculation method

Result (EIRP) = Ant. Input - Cable loss + Antenna Gain
Margin = Limit – Result (EIRP)

Example:

Limit @ 1420 MHz : -13.0 dBm
Ant. Input = -55.6 dBm Cable loss = 1.0dB Ant. Gain = 5.9 dBi
Result = -55.6 - 1.0 + 5.9 = -50.7 dBm
Margin = -13.0 - (-50.7) = 37.7 dB

4.5.3 Limit

-13 dBm or less

4.5.4 Test data

Date	: 26-April-2021	Test engineer	:	<u>Chiaki Kanno</u>
Temperature	: 22.1 [°C]			
Humidity	: 33.7 [%]			
Test place	: 3m Semi-anechoic chamber			
Date	: 28-April-2021	Test engineer	:	<u>Chiaki Kanno</u>
Temperature	: 22.8 [°C]			
Humidity	: 18.1 [%]			
Test place	: 3m Semi-anechoic chamber			

[LTE Band X VII - Open, Without camera]**QPSK, BW 5MHz****Channel: 23755**

H/V	Frequency [MHz]	S.A Reading [dBm]	Ant. Input [dBm]	Cable loss [dB]	Ant.Gain [dBi]	Result [dBm]	Limit [dBm]	Margin [dB]
H	1413.0	-53.8	-51.7	1.0	4.4	-48.2	-13.0	35.2

Channel: 23790

H/V	Frequency [MHz]	S.A Reading [dBm]	Ant. Input [dBm]	Cable loss [dB]	Ant.Gain [dBi]	Result [dBm]	Limit [dBm]	Margin [dB]
H	1420.0	-51.9	-49.6	1.0	4.6	-46.0	-13.0	33.0

Channel: 23825

H/V	Frequency [MHz]	S.A Reading [dBm]	Ant. Input [dBm]	Cable loss [dB]	Ant.Gain [dBi]	Result [dBm]	Limit [dBm]	Margin [dB]
H	1427.0	-51.0	-49.0	1.0	4.8	-45.2	-13.0	32.2

16QAM, BW 5MHz**Channel: 23755**

H/V	Frequency [MHz]	S.A Reading [dBm]	Ant. Input [dBm]	Cable loss [dB]	Ant.Gain [dBi]	Result [dBm]	Limit [dBm]	Margin [dB]
H	1413.0	-54.1	-52.0	1.0	4.4	-48.5	-13.0	35.5

Channel: 23790

H/V	Frequency [MHz]	S.A Reading [dBm]	Ant. Input [dBm]	Cable loss [dB]	Ant.Gain [dBi]	Result [dBm]	Limit [dBm]	Margin [dB]
H	1420.0	-52.4	-50.1	1.0	4.6	-46.5	-13.0	33.5

Channel: 23825

H/V	Frequency [MHz]	S.A Reading [dBm]	Ant. Input [dBm]	Cable loss [dB]	Ant.Gain [dBi]	Result [dBm]	Limit [dBm]	Margin [dB]
H	1427.0	-51.2	-49.2	1.0	4.8	-45.4	-13.0	32.4

QPSK, BW 10MHz**Channel: 23780**

H/V	Frequency [MHz]	S.A Reading [dBm]	Ant. Input [dBm]	Cable loss [dB]	Ant.Gain [dBi]	Result [dBm]	Limit [dBm]	Margin [dB]
H	1418.0	-51.7	-49.4	1.0	4.6	-45.8	-13.0	32.8

Channel: 23790

H/V	Frequency [MHz]	S.A Reading [dBm]	Ant. Input [dBm]	Cable loss [dB]	Ant.Gain [dBi]	Result [dBm]	Limit [dBm]	Margin [dB]
H	1420.0	-51.5	-49.2	1.0	4.6	-45.6	-13.0	32.6

Channel: 23800

H/V	Frequency [MHz]	S.A Reading [dBm]	Ant. Input [dBm]	Cable loss [dB]	Ant.Gain [dBi]	Result [dBm]	Limit [dBm]	Margin [dB]
H	1422.0	-51.8	-49.3	1.0	4.7	-45.6	-13.0	32.6

16QAM, BW 10MHz**Channel: 23780**

H/V	Frequency [MHz]	S.A Reading [dBm]	Ant. Input [dBm]	Cable loss [dB]	Ant.Gain [dBi]	Result [dBm]	Limit [dBm]	Margin [dB]
H	1418.0	-51.7	-49.4	1.0	4.6	-45.8	-13.0	32.8

Channel: 23790

H/V	Frequency [MHz]	S.A Reading [dBm]	Ant. Input [dBm]	Cable loss [dB]	Ant.Gain [dBi]	Result [dBm]	Limit [dBm]	Margin [dB]
H	1420.0	-51.7	-49.4	1.0	4.6	-45.8	-13.0	32.8

Channel: 23800

H/V	Frequency [MHz]	S.A Reading [dBm]	Ant. Input [dBm]	Cable loss [dB]	Ant.Gain [dBi]	Result [dBm]	Limit [dBm]	Margin [dB]
H	1422.0	-51.9	-49.4	1.0	4.7	-45.7	-13.0	32.7

4.6 Frequency Stability

4.6.1 Measurement procedure

[FCC 27.54, 2.1055]

The EUT was placed of an inside of an constant temperature chamber as the temperature in the chamber was varied between -30°C and +50°C. The temperature was incremented by 10°C intervals and the unit was allowed to stabilize at each measurement. The frequency drift was measured with the normal Temperature and voltage tolerance and it is presented as the ppm unit.

- Test configuration

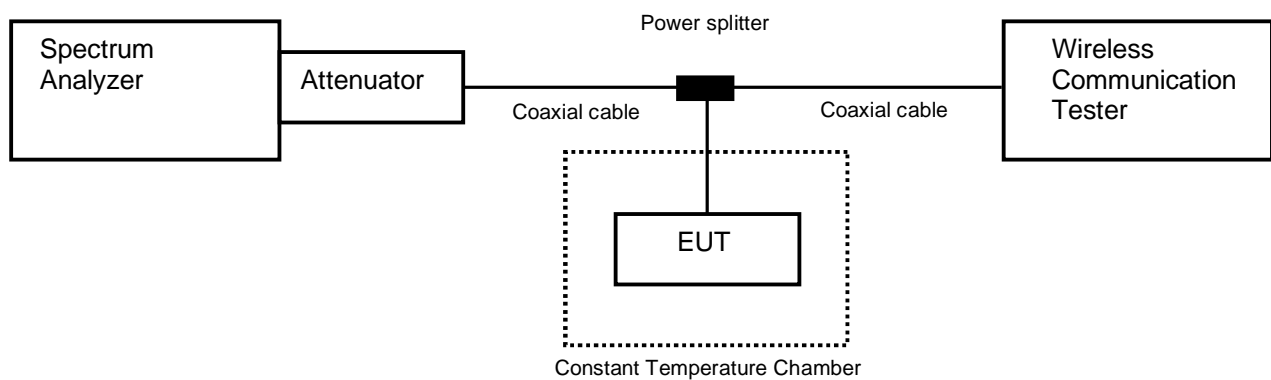

4.6.2 Limit

±2.5 ppm

4.6.3 Measurement result

Date : 7-May-2021
 Temperature : 21.3 [°C]
 Humidity : 28.3 [%]
 Test place : Shielded room No.4

Test engineer : Taiki Watanabe

**[LTE Band XII]
QPSK, BW 10MHz
Channel: 23095**

Limit: $\pm 0.00025\% = \pm 2.5\text{ppm}$					
Power Supply [V]	Temperature [°C]	Measurements Frequency [Hz]	Frequency Tolerance [ppm]	Limit [ppm]	Result
3.80	25(Ref.)	710,000,009	0.00000	± 2.5	Pass
	50	709,999,994	-0.02018	± 2.5	Pass
	40	709,999,983	-0.03563	± 2.5	Pass
	30	710,000,011	0.00279	± 2.5	Pass
	20	709,999,988	-0.02977	± 2.5	Pass
	10	709,999,992	-0.02383	± 2.5	Pass
	0	709,999,994	-0.02132	± 2.5	Pass
	-10	709,999,993	-0.02177	± 2.5	Pass
	-20	710,000,012	0.00527	± 2.5	Pass
	-30	710,000,008	-0.00028	± 2.5	Pass
3.42	25	709,999,990	-0.02649	± 2.5	Pass
4.18	25	709,999,994	-0.02062	± 2.5	Pass



Calculation;

Frequency Tolerance (ppm) = Measurements Frequency (Hz) – Reference Frequency (Hz) / Reference Frequency (Hz) x 1000000

5 Measurement Uncertainty

Expanded uncertainties stated are calculated with a coverage Factor k=2.
 Please note that these results are not taken into account when measurement uncertainty considerations contained in ETSI TR 100 028 Parts 1 and 2 determining compliance or non-compliance with test result.

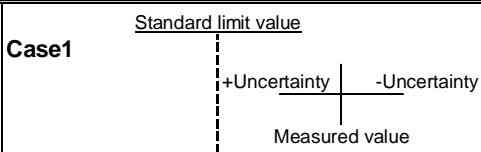
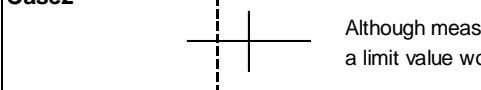
Test item	Measurement uncertainty
Conducted emission, AMN (9 kHz – 150 kHz)	±3.7 dB
Conducted emission, AMN (150 kHz – 30 MHz)	±3.3 dB
Radiated emission (9kHz – 30 MHz)	±3.2 dB
Radiated emission (30 MHz – 1000 MHz)	±5.3 dB
Radiated emission (1 GHz – 6 GHz)	±4.8 dB
Radiated emission (6 GHz – 18 GHz)	±4.5 dB
Radiated emission (18 GHz – 40 GHz)	±6.4 dB
Radio Frequency	±1.4 * 10 ⁻⁸
RF power, conducted	±0.8 dB
Adjacent channel power	±2.4 dB
Temperature	±0.6 °C
Humidity	±1.2 %
Voltage (DC)	±0.4 %
Voltage (AC, <10kHz)	±0.2 %

Judge	Measured value and standard limit value	
PASS	 <p>Standard limit value</p> <p>Case1</p> <p>+Uncertainty -Uncertainty</p> <p>Measured value</p>	Even if it takes uncertainty into consideration, a standard limit value is fulfilled.
	 <p>Case2</p>	Although measured value is in a standard limit value, a limit value won't be fulfilled if uncertainty is taken into consideration.
FAIL	 <p>Case3</p>	Although measured value exceeds a standard limit value, a limit value will be fulfilled if uncertainty is taken into consideration.
	 <p>Case4</p>	Even if it takes uncertainty into consideration, a standard limit value isn't fulfilled.



Japan

6 Laboratory Information

Testing was performed and the report was issued at:

TÜV SÜD Japan Ltd. Yonezawa Testing Center

Address: 5-4149-7 Hachimanpara, Yonezawa-shi, Yamagata, 992-1128 Japan

Phone: +81-238-28-2881

Fax: +81-238-28-2888

Accreditation and Registration

A2LA

Certificate #3686.03

VLAC

Accreditation No.: VLAC-013

BSMI

Laboratory Code: SL2-IN-E-6018, SL2-A1-E-6018

Innovation, Science and Economic Development Canada

ISED#: 4224A

VCCI Council

Registration number	Expiration date
A-0166	03-July-2021

Appendix A. Test Equipment

Antenna port conducted test

Equipment	Company	Model No.	Serial No.	Cal. Due	Cal. Date
Spectrum analyzer	Agilent Technologies	E4440A	US44302655	31-Aug-2021	20-Aug-2020
Attenuator	Weinschel	56-10	J4993	31-Dec-2021	14-Dec-2020
Microwave cable	HUBER+SUHNER	SUCOFLEX 104/1m	199120/4	31-Dec-2021	14-Dec-2020
Microwave cable	HUBER+SUHNER	SUCOFLEX104/1.5m	322087/4	31-Jul-2021	21-Jul-2020
Power divider	Keysight	11636B	MY51359874	30-Sep-2021	29-Sep-2020
Wideband Radio Frequency Tester	ROHDE&SCHWARZ	CMW500	116338	30-Sep-2021	02-Sep-2020
Temperature and humidity chamber	ESPEC	PL1KP	14007261	30-Sep-2021	02-Sep-2020

Radiated emission

Equipment	Company	Model No.	Serial No.	Cal. Due	Cal. Date
EMI Receiver	ROHDE&SCHWARZ	ESCI	100765	30-Sep-2021	28-Sep-2020
Spectrum analyzer	Agilent Technologies	E4447A	MY46180188	31-Mar-2022	11-Mar-2021
Spectrum analyzer	Agilent Technologies	E4440A	US40420937	31-Dec-2021	11-Dec-2020
Spectrum analyzer	ROHDE&SCHWARZ	FSV40	101731	30-Jun-2021	22-Jun-2020
Preamplifier	SONOMA	310	372170	30-Sep-2021	29-Sep-2020
Biconical antenna	Schwarzbeck	VHBB9124/BBA9106	1333	31-Dec-2021	15-Dec-2020
Log periodic antenna	Schwarzbeck	VUJSLP9111B	344	30-Apr-2021	17-Apr-2020
			345	31-Oct-2021	19-Oct-2020
Attenuator	TOYO Connector	NA-PJ-6/6dB	N/A(S541)	30-Sep-2021	29-Sep-2020
Attenuator	TAMAGAWA.ELEC	CFA-10/3dB	N/A(S503)	31-Jul-2021	20-Jul-2020
Preamplifier	TSJ	MLA-100M18-B02-40	1929118	31-Dec-2021	15-Dec-2020
Attenuator	AEROFLEX	26A-10	081217-08	31-Dec-2021	14-Dec-2020
Double ridged guide antenna	ETS LINDGREN	3117	00052315	30-Apr-2021	08-Apr-2020
			00224193	31-Mar-2022	30-Mar-2021
Attenuator	HUBER+SUHNER	6803.17.B	N/A(2340)	31-Dec-2021	15-Dec-2020
Double ridged guide antenna	A.H.Systems Inc.	SAS-574	469	30-Sep-2021	02-Sep-2020
Preamplifier	TSJ	MLA-1840-B03-35	1240332	30-Sep-2021	02-Sep-2020
Notch Filter	Micro-Tronics	BRM50706	003	31-Jul-2021	21-Jul-2020
Signal generator	ROHDE&SCHWARZ	SMB100A	177525	31-Dec-2021	23-Dec-2020
RF power amplifier	R&K	CGA020M602-2633R	B40240	31-May-2021	15-May-2020
Microwave cable	HUBER+SUHNER	SUCOFLEX102/2m	31648	31-Mar-2022	10-Mar-2021
Dipole antenna	Schwarzbeck	VHAP	1020	31-Aug-2021	13-Aug-2020
Dipole antenna	Schwarzbeck	UHAP	994	31-Aug-2021	06-Aug-2020
Double ridged guide antenna	ETS LINDGREN	3117	00218815	31-Dec-2021	07-Dec-2020
Wideband Radio Frequency Tester	ROHDE&SCHWARZ	CMW500	126079	31-Oct-2021	21-Oct-2020
Wideband Radio Frequency Tester	ROHDE&SCHWARZ	CMW500	116338	30-Sep-2021	02-Sep-2020
Microwave cable	HUBER+SUHNER	SUCOFLEX104/9m	MY30037/4	31-Dec-2021	15-Dec-2020
		SUCOFLEX104/1m	my24610/4	31-Dec-2021	15-Dec-2020
		SUCOFLEX104/8m	SN MY30033/4	31-Dec-2021	15-Dec-2020
		SUCOFLEX104	MY32976/4	31-Dec-2021	15-Dec-2020
		SUCOFLEX104/1.5m	SN MY28404/4	31-Dec-2021	15-Dec-2020
		SUCOFLEX104/7m	41625/6	31-Dec-2021	15-Dec-2020
PC	DELL	DIMENSION E521	75465BX	N/A	N/A
Software	TOYO Corporation	EP5/RE-AJ	0611193/V6.0.140	N/A	N/A
Absorber	RIKEN	PFP30	N/A	N/A	N/A
3m Semi an-echoic Chamber	TOKIN	N/A	N/A(9002-NSA)	31-May-2021	29-May-2020
3m Semi an-echoic Chamber	TOKIN	N/A	N/A(9002-SVSWR)	31-May-2021	28-May-2020

*: The calibrations of the above equipment are traceable to NIST or equivalent standards of the reference organizations.