



FCC - TEST REPORT

Report Number : 68.950.20.0014.01 Date of Issue: February 27, 2020

Model : ATH-ANC300TW

Product Type : WIRELESS HEADPHONES

Applicant : Audio-Technica Corporation

Address : 2-46-1 Nishi-naruse, Machida Tokyo 194-8666 Japan

Factory : Charter Media (Dongguan) Co., Ltd.

Address : Dabandi Industrial Zone, Daning District, Humen Town,
523930 Dongguan City, Guangdong Province,
PEOPLE'S REPUBLIC OF CHINA

Test Result : Positive Negative

Total pages including Appendices : 49

TÜV SÜD CERTIFICATION AND TESTING (CHINA) CO., LTD. SHENZHEN BRANCH is a subcontractor to TÜV SÜD Product Service GmbH according to the principles outlined in ISO 17025. TÜV SÜD CERTIFICATION AND TESTING (CHINA) CO., LTD. SHENZHEN BRANCH reports apply only to the specific samples tested under stated test conditions. Construction of the actual test samples has been documented. It is the manufacturer's responsibility to assure that additional production units of this model are manufactured with identical electrical and mechanical components. The manufacturer/importer is responsible to the Competent Authorities in Europe for any modifications made to the production units which result in non-compliance to the relevant regulations TÜV SÜD CERTIFICATION AND TESTING (CHINA) CO., LTD. SHENZHEN BRANCH shall have no liability for any deductions, inferences or generalizations drawn by the client or others from TÜV SÜD CERTIFICATION AND TESTING (CHINA) CO., LTD. SHENZHEN BRANCH issued reports. This report is the confidential property of the client. As a mutual protection to our clients, the public and ourselves, extracts from the test report shall not be reproduced except in full without our written approval.



1 Table of Contents

1	Table of Contents	2
2	Details about the Test Laboratory.....	3
3	Description of the Equipment Under Test.....	4
4	Summary of Test Standards	5
5	Summary of Test Results	6
6	General Remarks	7
7	Test Setups	8
8	Systems test configuration	9
9	Technical Requirement	10
9.1	Conducted peak output power.....	10
9.2	20 dB bandwidth and 99% Occupied Bandwidth.....	17
9.3	Carrier Frequency Separation	27
9.4	Number of hopping frequencies.....	30
9.5	Dwell Time	32
9.6	Spurious RF conducted emissions.....	35
9.7	Band edge testing	39
9.8	Spurious radiated emissions for transmitter	44
10	Test Equipment List.....	48
11	System Measurement Uncertainty.....	49



2 Details about the Test Laboratory

Details about the Test Laboratory

Test Site 1

Company name: TÜV SÜD Certification and Testing (China) Co., Ltd. Shenzhen Branch
Building 12 & 13, Zhiheng Wisdomland Business Park, Nantou Checkpoint
Road 2, Nanshan District
Shenzhen 518052
P.R. China

Telephone: 86 755 8828 6998

Fax: 86 755 8288 5299

FCC Registration No.: 514049

3 Description of the Equipment Under Test

Product:	WIRELESS HEADPHONES
Model no.:	ATH-ANC300TW
FCC ID:	JFZANC300TW-R
Options and accessories:	USB Cable, Charging Case
Rating:	Headphones: 3.8VDC, 75mAh (Supplied by Built Li-ion battery) Charging case: 5VDC (Charged by USB port) 3.7VDC, 700mAh (Supplied by Polymer Li-ion Rechargeable battery)
RF Transmission Frequency:	2402MHz-2480MHz
No. of Operated Channel:	79
Modulation:	GFSK, $\pi/4$ -DQPSK, 8-DPSK
Antenna Type:	FPC Inverted-F antenna
Antenna Gain:	2.0dBi
Description of the EUT:	The Equipment Under Test (EUT) is a WIRELESS HEADPHONES operated at 2.4GHz



4 Summary of Test Standards

Test Standards	
FCC Part 15 Subpart C 10-1-2017 Edition	PART 15 - RADIO FREQUENCY DEVICES Subpart C - Intentional Radiators

All the test methods were according to Public Notice DA 00-705 -Frequency Hopper Spread Spectrum Test Procedure, KDB558074 D01 v05r02 and ANSI C63.10-2013.



5 Summary of Test Results

Technical Requirements				
FCC Part 15 Subpart C				
Test Condition		Pages	Test Result	Test Site
§15.207	Conducted emission AC power port	--	N/A	--
§15.247(b)(1)	Conducted peak output power	10	Pass	Site 1
§15.247(e)	Power spectral density*	--	N/A	--
§15.247(a)(2)	6dB bandwidth	--	N/A	--
§15.247(a)(1)	20dB bandwidth and 99% Occupied Bandwidth	17	Pass	Site 1
§15.247(a)(1)	Carrier frequency separation	27	Pass	Site 1
§15.247(a)(1)(iii)	Number of hopping frequencies	30	Pass	Site 1
§15.247(a)(1)(iii)	Dwell Time	32	Pass	Site 1
§15.247(d)	Spurious RF conducted emissions	35	Pass	Site 1
§15.247(d)	Band edge	39	Pass	Site 1
§15.247(d) & §15.209 & §15.205	Spurious radiated emissions for transmitter and receiver	44	Pass	Site 1
§15.203	Antenna requirement	See note 1	Pass	--

Note 1: N/A=Not Applicable.

Note 2: The EUT uses a FPC Inverted-F antenna, which gain is 2.0dBi. In accordance to §15.203, it is considered sufficiently to comply with the provisions of this section.



6 General Remarks

Remarks

This submittal(s) (test report) is intended for FCC ID: JFZANC300TW-R complies with Section 15.205, 15.209, 15.247 of the FCC Part 15, Subpart C.

ATH-ANC300TW is a Bluetooth Headset with Bluetooth 5.0. The TX and RX range is 2402MHz-2480MHz.

Note: The report is for BDR+EDR only.

SUMMARY:

All tests according to the regulations cited on page 5 were

- Performed

- **Not** Performed

The Equipment Under Test

- **Fulfills** the general approval requirements.

- **Does not** fulfill the general approval requirements.

Sample Received Date: November 21, 2019

Testing Start Date: November 21, 2019

Testing End Date: January 3, 2020

Reviewed by:

Prepared by:

Tested by:

John Zhi
EMC Project Manager

Mark Chen
EMC Project Engineer

Tree Zhan
EMC Test Engineer

7 Test Setups

7.1 Radiated test setups

Below 1GHz

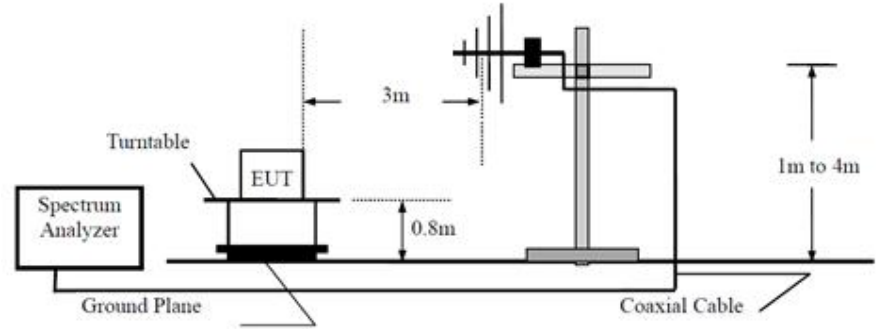

Above 1GHz

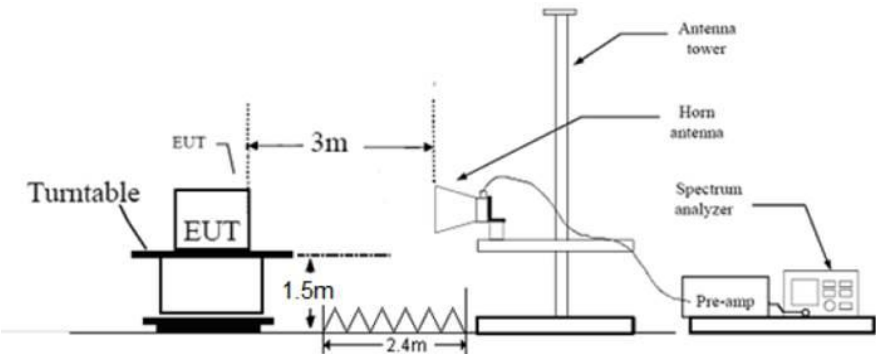

7.2 Conducted RF test setups

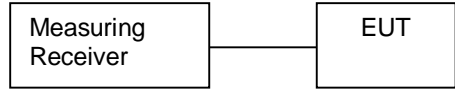

8 Systems test configuration

Auxiliary Equipment Used during Test:

DESCRIPTION	MANUFACTURER	MODEL NO.	S/N
Notebook	Lenovo	X220	---

Test software: Bluetooth 3 Test Tool, which used to control the EUT in continues transmitting mode

The system was configured to hopping mode and non-hopping mode.

Hopping mode: typical working mode (normal hopping status)

Non-hopping mode: The system was configured to operate at a signal channel transmitting. The test software allows the configuration and operation at the worst-case duty and the highest transmit power.



9 Technical Requirement

9.1 Conducted peak output power

Test Method

1. Use the following spectrum analyzer settings:
 Span = approximately 5 times the 20dB bandwidth, centered on a hopping channel
 RBW > the 20dB bandwidth of the emission being measured, VBW ≥ RBW,
 Sweep = auto, Detector function = peak, Trace = max hold
2. Add a correction factor to the display.
3. Allow the trace to stabilize. Use the marker-to-peak function to set the marker to the peak of the emission. The indicated level is the peak output power

Limits

Frequency Range MHz	Limit W	Limit dBm
2400-2483.5	≤1	≤30



Conducted peak output power

Bluetooth Mode GFSK modulation Test Result

Frequency MHz	Conducted Peak Output Power dBm	Result
Low channel 2402MHz	3.96	Pass
Middle channel 2441MHz	3.6	Pass
High channel 2480MHz	3.13	Pass

Low channel 2402MHz



Date: 3 JAN 2020 11:09:33



Middle channel 2441MHz

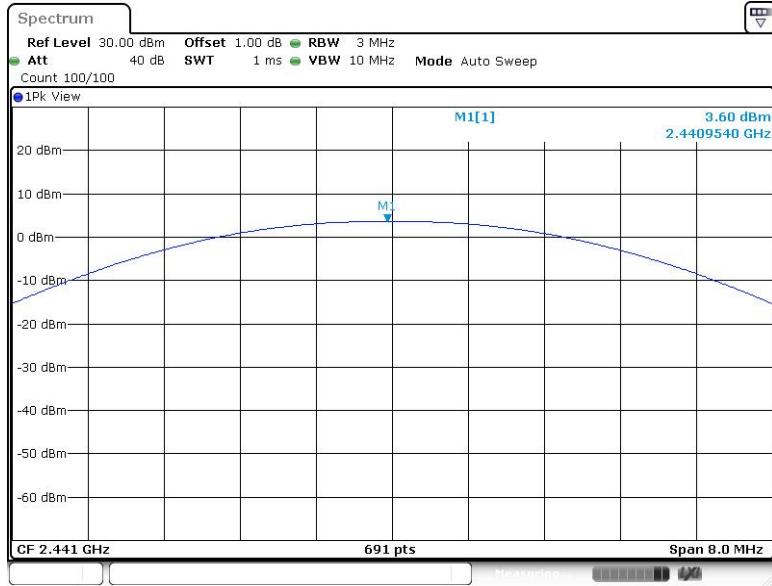

Date: 3 JAN 2020 11:10:01

High channel 2480MHz

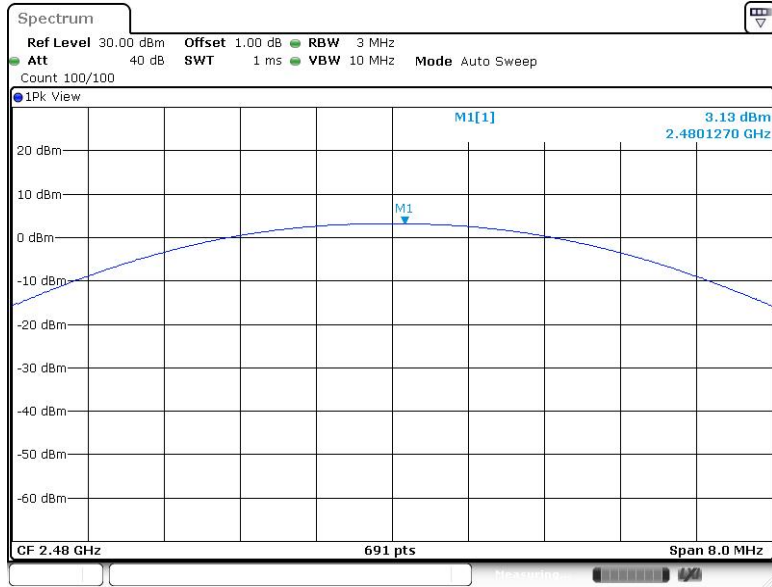

Date: 3 JAN 2020 11:10:28



Bluetooth Mode $\pi/4$ -DQPSK modulation Test Result
Conducted

Frequency MHz	Peak Output Power dBm	Result
Low channel 2402MHz	4.36	Pass
Middle channel 2441MHz	4.11	Pass
High channel 2480MHz	3.86	Pass

Low channel 2402MHz

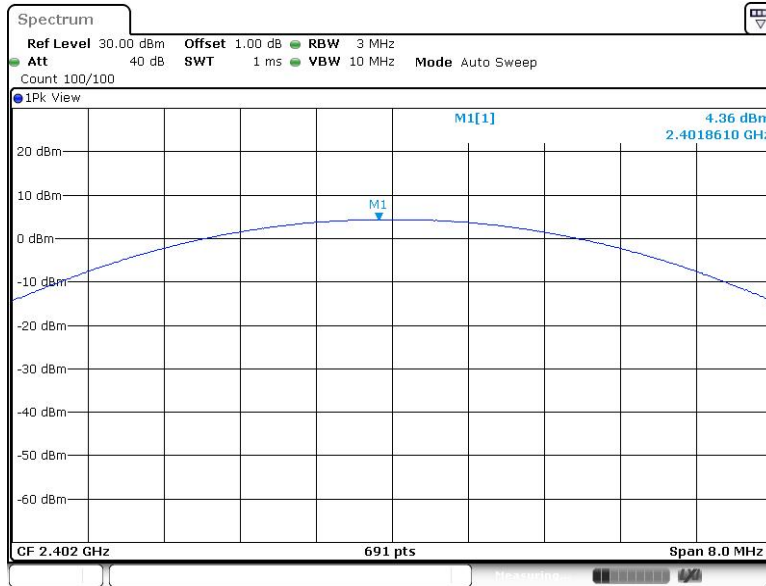

Date: 3 JAN 2020 11:11:18

Middle channel 2441MHz

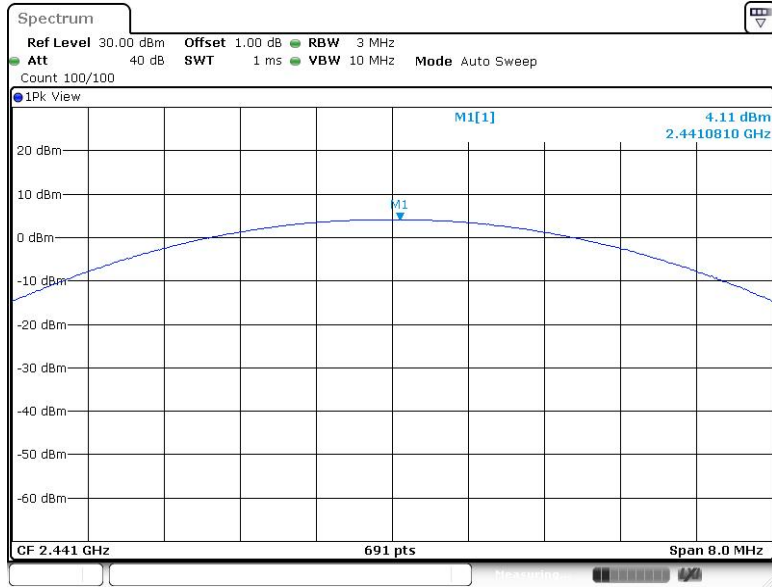

Date: 3 JAN 2020 11:17:01

High channel 2480MHz

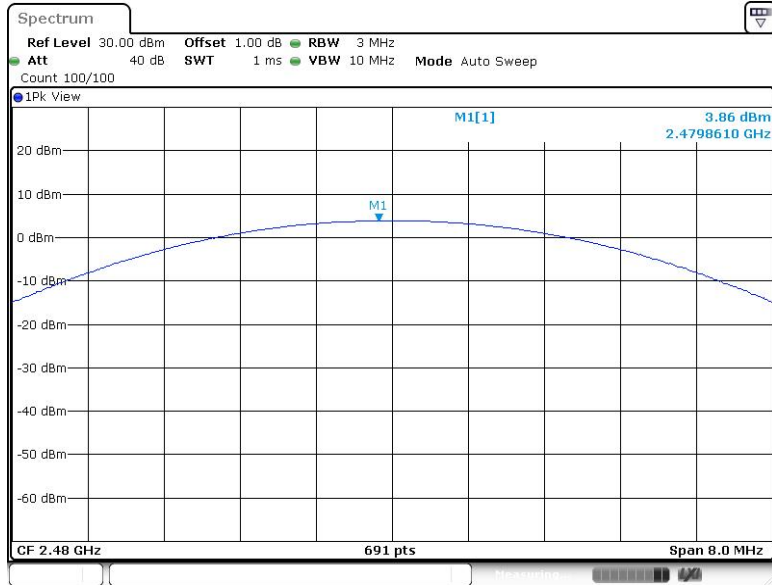

Date: 3 JAN 2020 11:12:13



Bluetooth Mode 8DPSK modulation Test Result Conducted

Frequency MHz	Peak Output Power dBm	Result
Low channel 2402MHz	4.01	Pass
Middle channel 2441MHz	3.76	Pass
High channel 2480MHz	3.49	Pass

Low channel 2402MHz

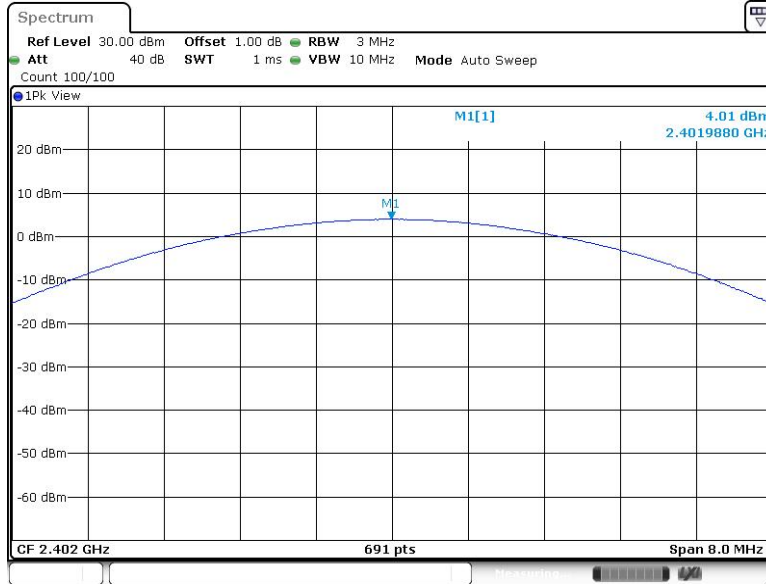

Date: 3 JAN 2020 11:12:58



Middle channel 2441MHz

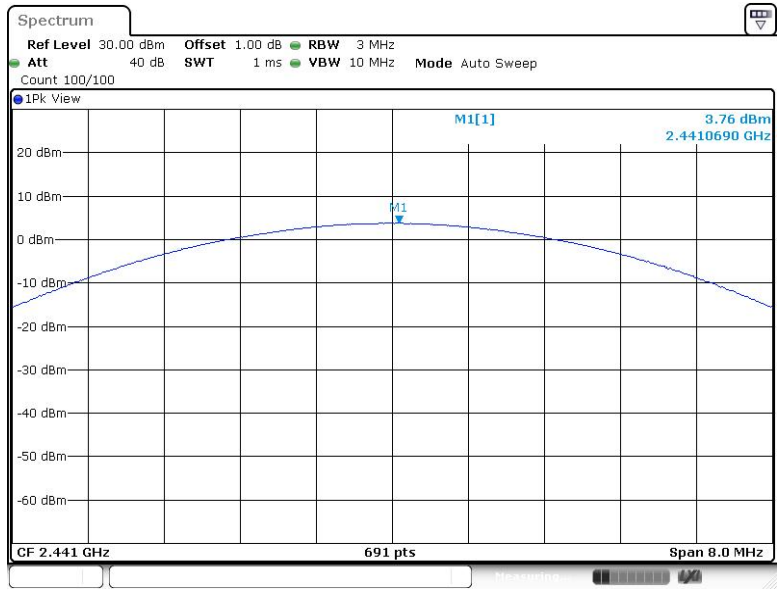

Date: 3 JAN 2020 11:13:32

High channel 2480MHz

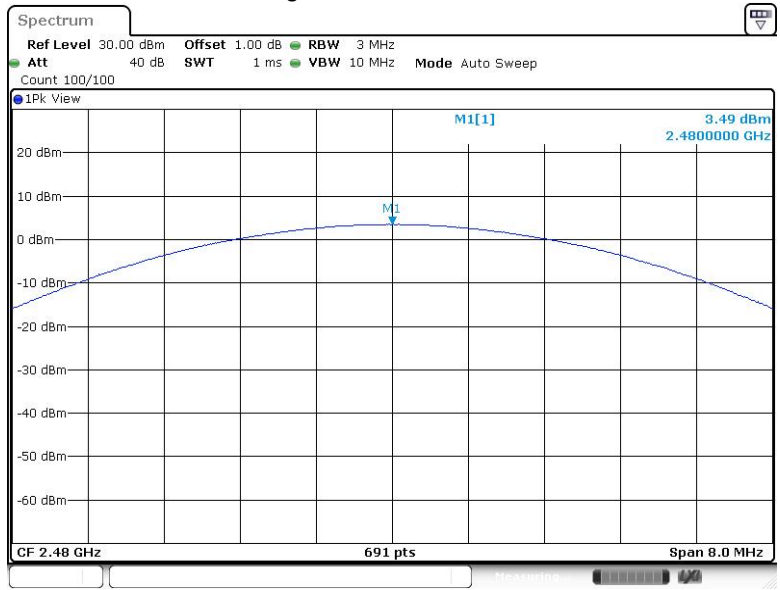

Date: 3 JAN 2020 11:14:11



9.2 20 dB bandwidth and 99% Occupied Bandwidth

Test Method

1. Check the calibration of the measuring instrument using either an internal calibrator or a known signal from an external generator.
2. Position the EUT without connection to measurement instrument. Turn on the EUT and connect it to measurement instrument. Then set it to any one convenient frequency within its operating range. Set a reference level on the measuring instrument equal to the highest peak value.
3. Measure the frequency difference of two frequencies that were attenuated 20 dB from the reference level. Record the frequency difference as the emission bandwidth.
4. Repeat above procedures until all frequencies measured were complete.

Limit

Limit [kHz]

N/A

20 dB bandwidth and 99% Occupied Bandwidth

Bluetooth Mode GFSK Modulation test result

Frequency MHz	20 dB Bandwidth kHz	99% Bandwidth kHz	Limit kHz	Result
2402	1116	869	--	Pass
2441	1119	866	--	Pass
2480	1116	866	--	Pass

Low channel 2402MHz

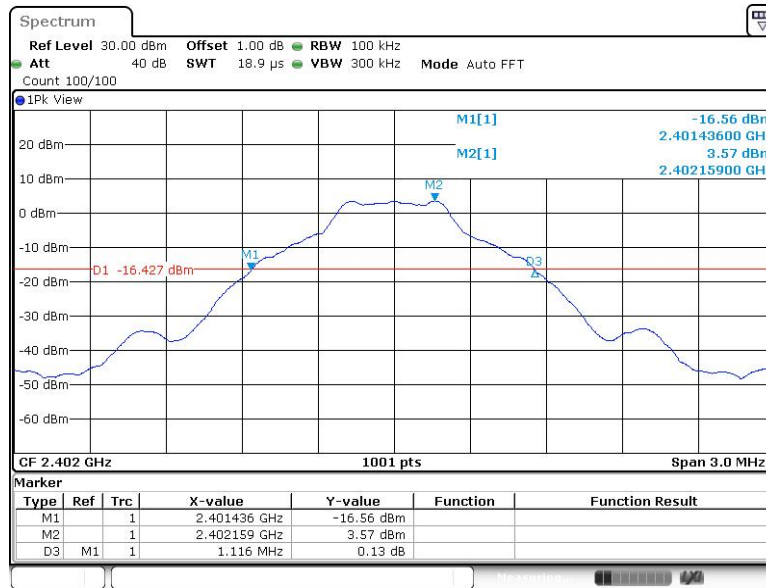

Date: 3 JAN 2020 09:27:55

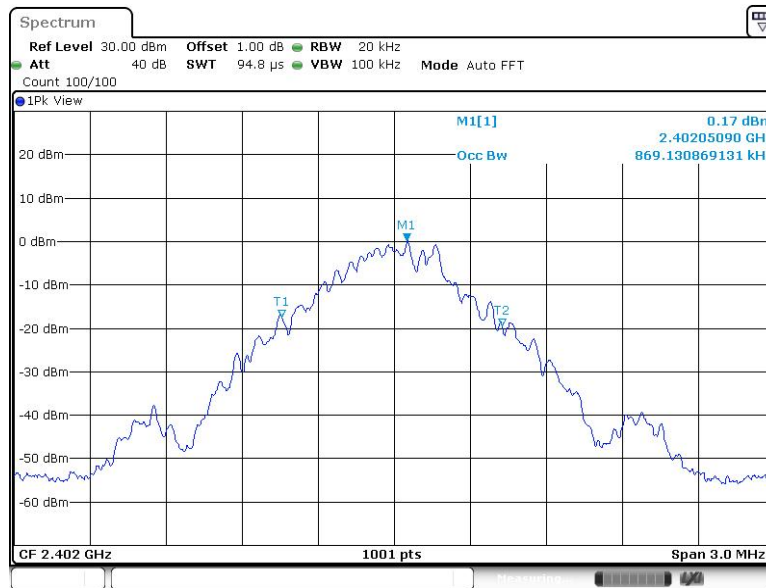

Date: 3 JAN 2020 09:28:07



Middle channel 2441MHz

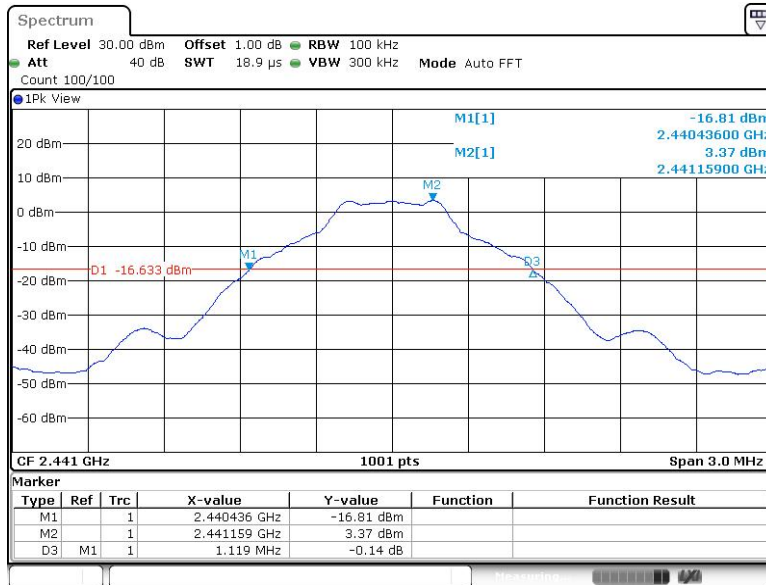

Date: 3.JAN.2020 09:29:45

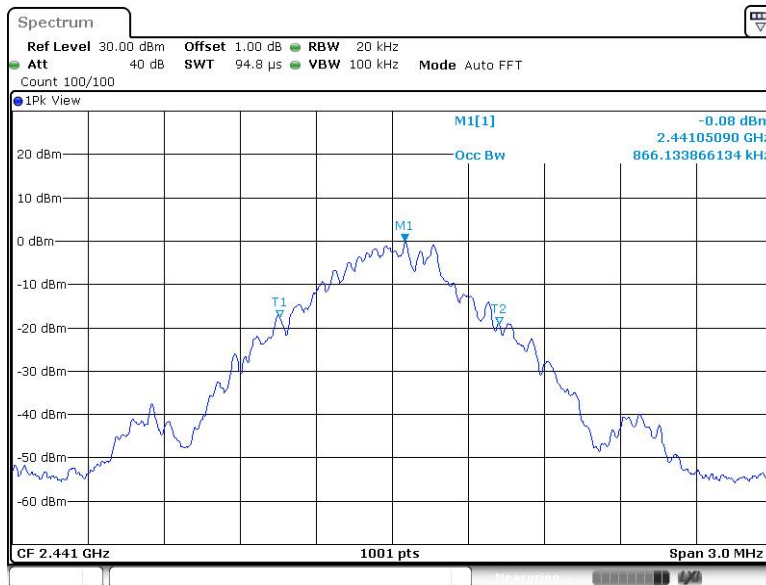

Date: 3.JAN.2020 09:29:56



High channel 2480MHz

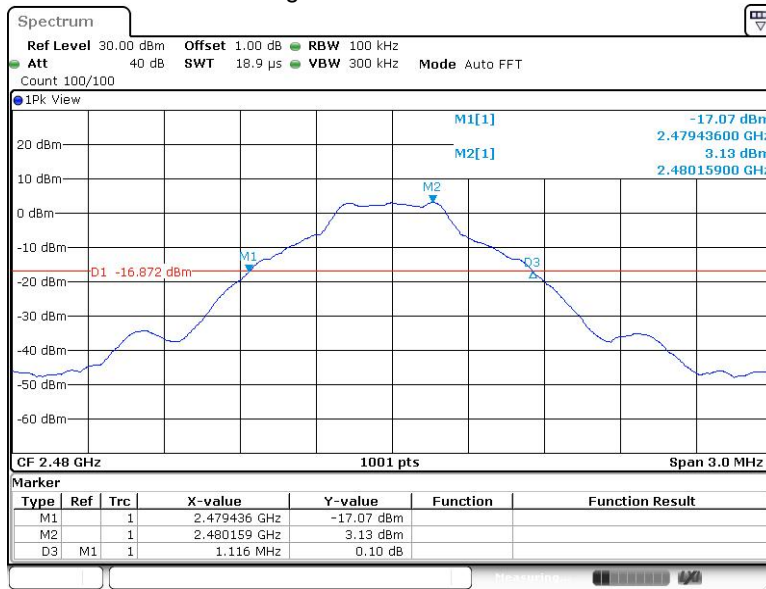

Date: 3 JAN 2020 09:32:31

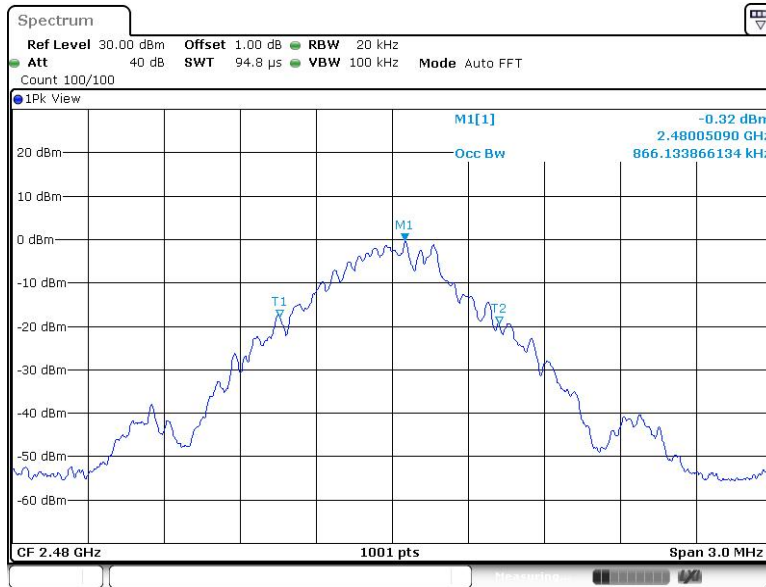

Date: 3 JAN 2020 09:32:42

20 dB bandwidth and 99% Occupied Bandwidth

Bluetooth Mode $\pi/4$ -DQPSK Modulation test result

Frequency MHz	20 dB Bandwidth kHz	99% Bandwidth kHz	Limit kHz	Result
2402	1407	1193	--	Pass
2441	1404	1193	--	Pass
2480	1407	1193	--	Pass

Low channel 2402MHz

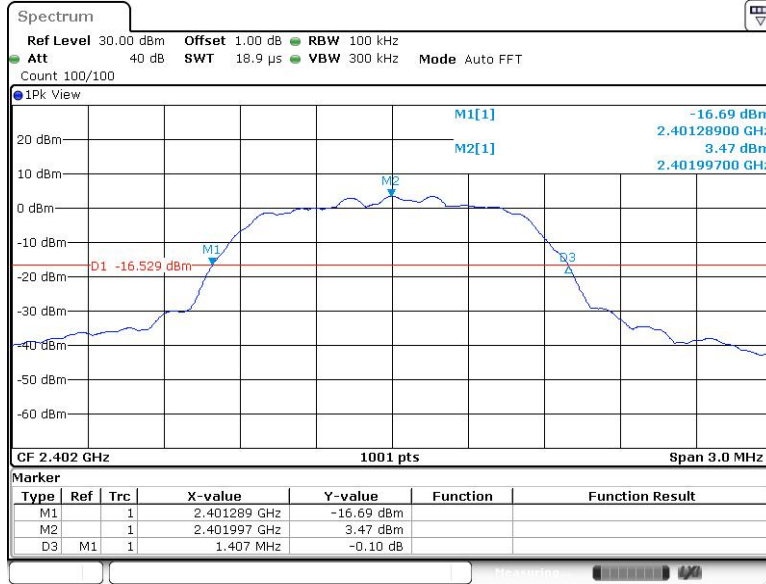

Date: 3.JAN.2020 09:36:54

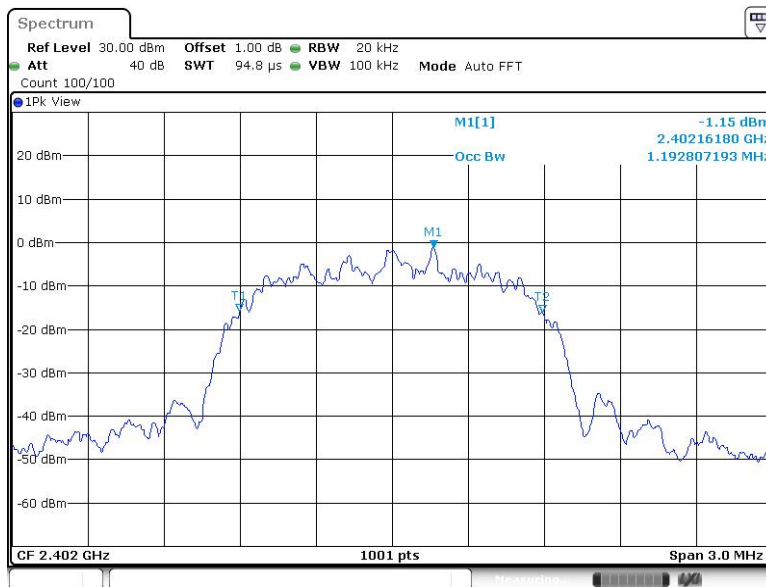

Date: 3.JAN.2020 09:37:05



Middle channel 2441MHz

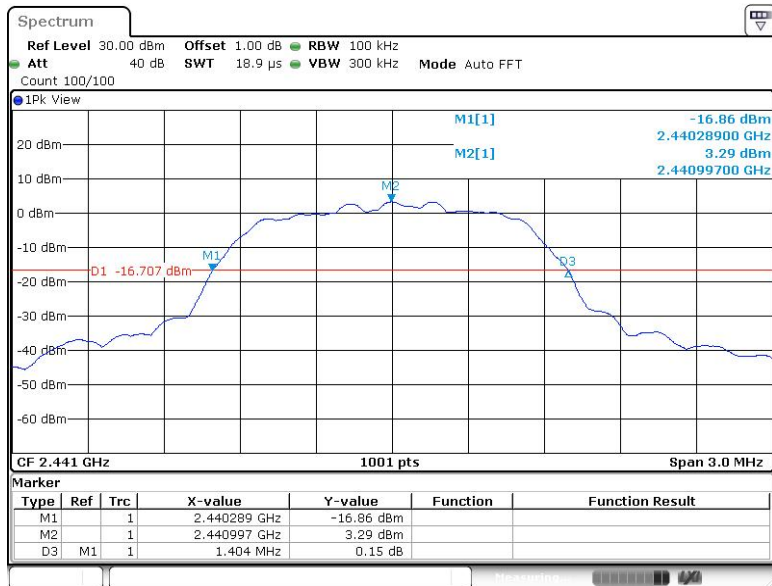

Date: 3 JAN 2020 09:39:48

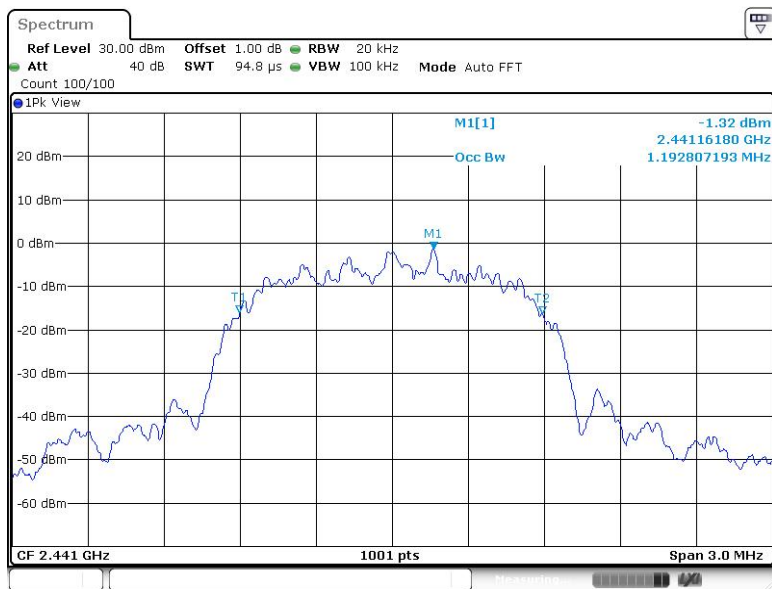

Date: 3 JAN 2020 09:39:59



High channel 2480MHz

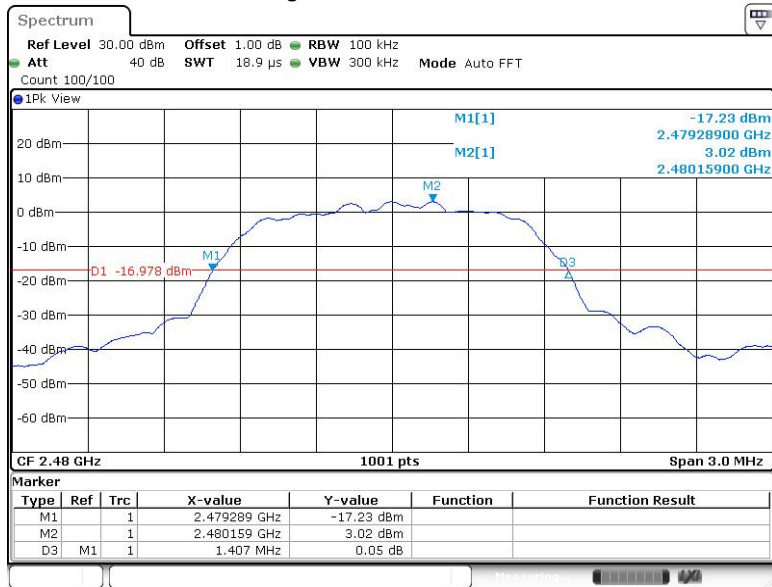

Date: 3.JAN.2020 09:42:02

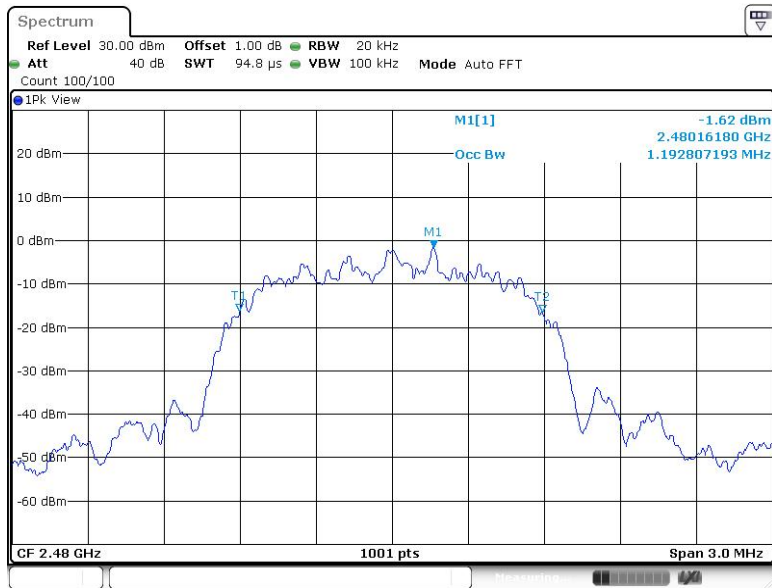

Date: 3.JAN.2020 09:42:13

20 dB bandwidth and 99% Occupied Bandwidth

Bluetooth Mode 8DPSK Modulation test result

Frequency MHz	20 dB Bandwidth kHz	99% Bandwidth kHz	Limit kHz	Result
2402	1398	1193	--	Pass
2441	1395	1193	--	Pass
2480	1395	1190	--	Pass

Low channel 2402MHz

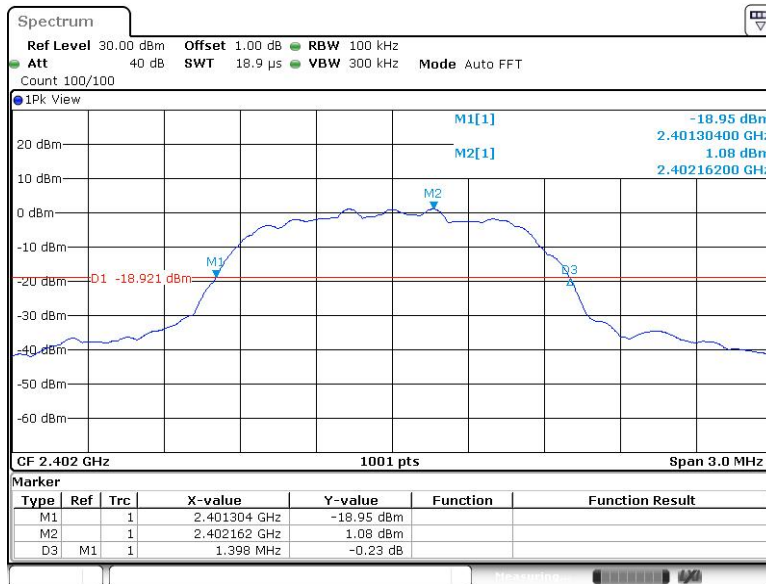

Date: 3.JAN.2020 09:48:10

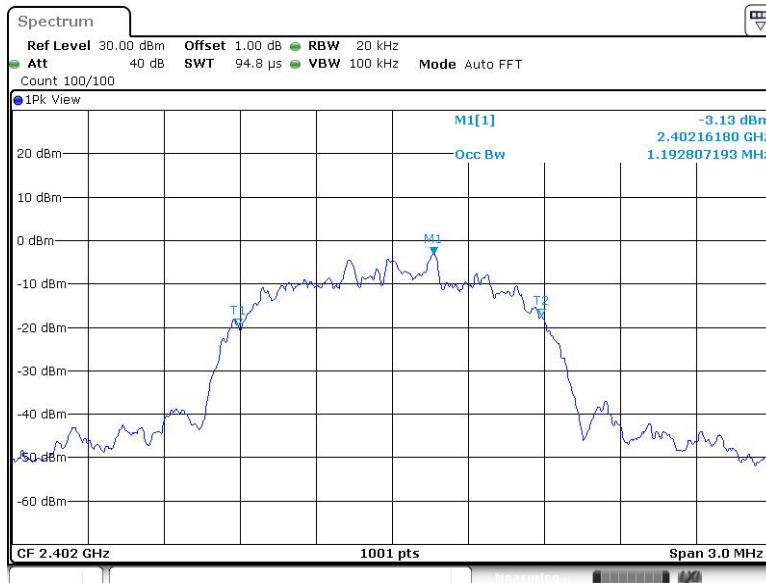

Date: 3.JAN.2020 09:48:21



Middle channel 2441MHz

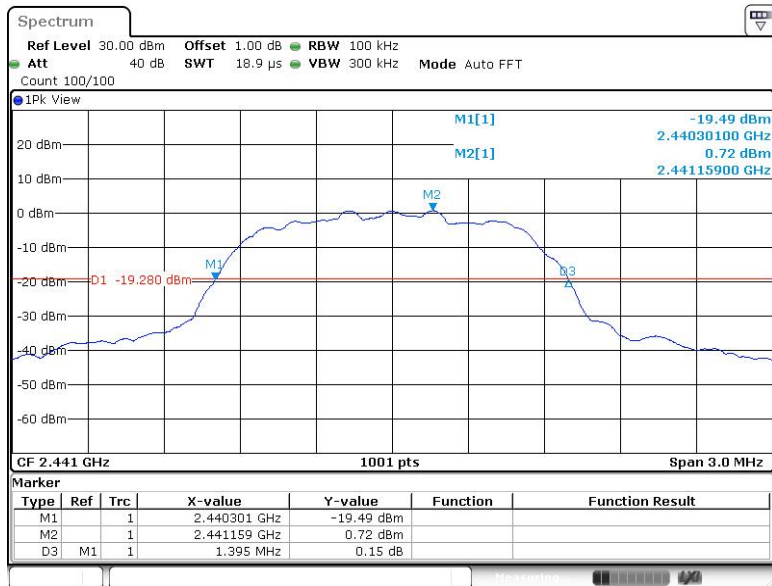

Date: 3 JAN 2020 09:50:22

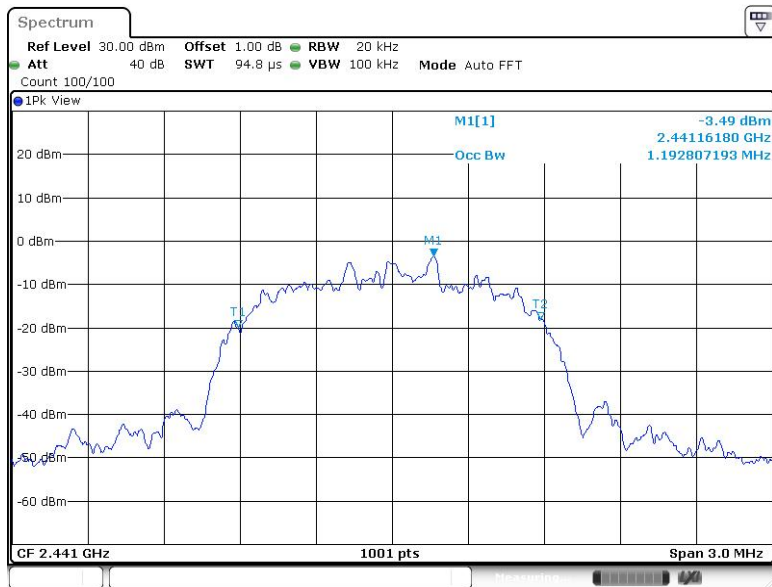

Date: 3 JAN 2020 09:50:33



High channel 2480MHz

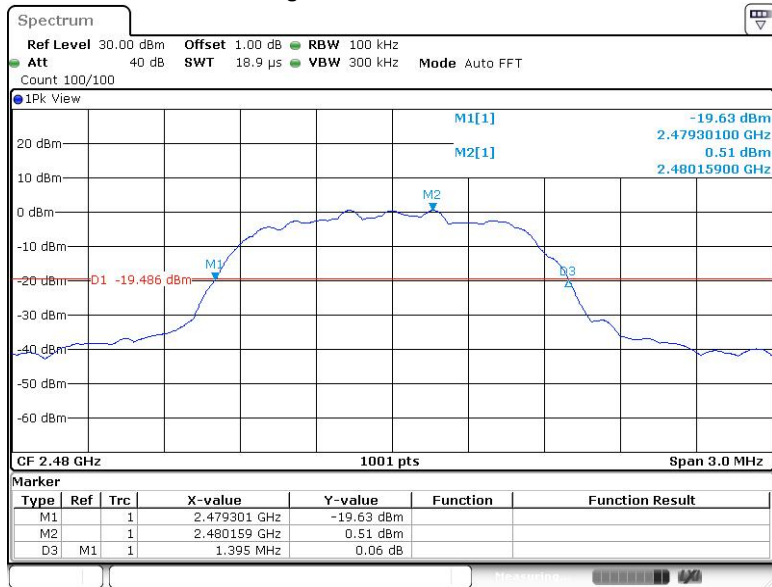

Date: 3.JAN.2020 09:52:09

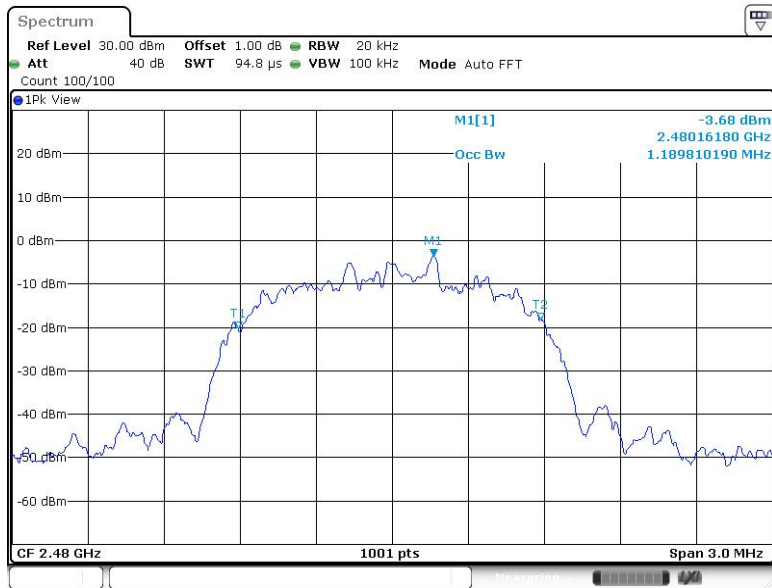

Date: 3.JAN.2020 09:52:21



9.3 Carrier Frequency Separation

Test Method

1. Use the following spectrum analyzer settings:
Span = wide enough to capture the peaks of two adjacent channels, RBW \geq 1% of the span, VBW) \geq RBW, Sweep = auto, Detector function = peak
2. By using the Max-Hold function record the separation of two adjacent channels.
3. Measure the frequency difference of these two adjacent channels by spectrum analyzer marker function.
4. Repeat above procedures until all frequencies measured were complete.

Limit

Limit
kHz

≥25KHz or 2/3 of the 20 dB bandwidth which is greater

GFSK Modulation Limit

Test Mode	2/3 of 20 dB Bandwidth kHz
DH5	746
2DH5	936
3DH5	930



Carrier Frequency Separation

Test result: The measurement was performed with the typical configuration (normal hopping status), here GFSK modulation mode was used to show compliance.

GFSK Modulation test result

Test Mode	Carrier Frequency Separation kHz	Result
DH5	1003	Pass
2DH5	1026	Pass
3DH5	1000	Pass

Low channel 2402MHz

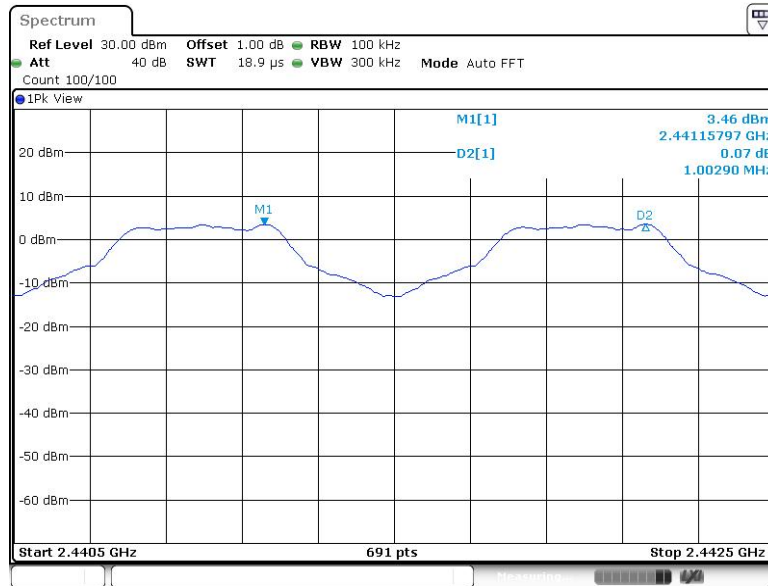

Date: 3.JAN.2020 09:58:17



Middle channel 2441MHz

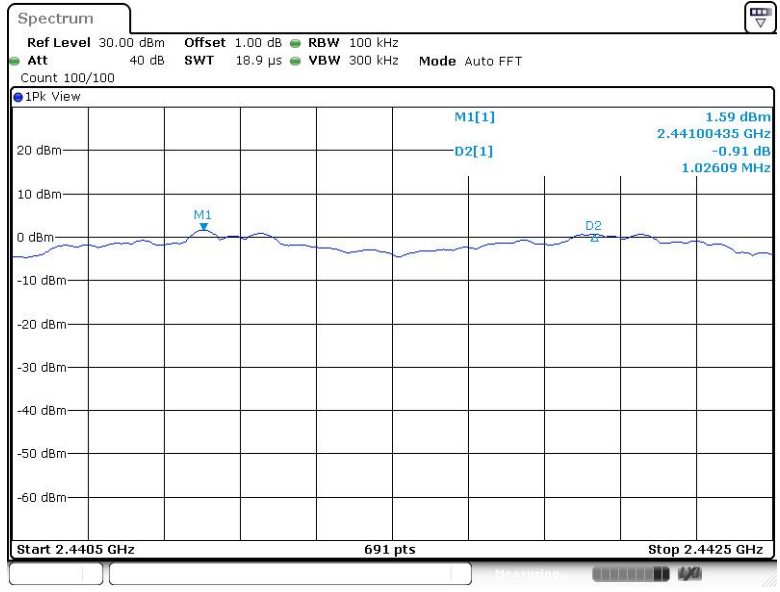

Date: 3 JAN 2020 11:17:47

High channel 2480MHz

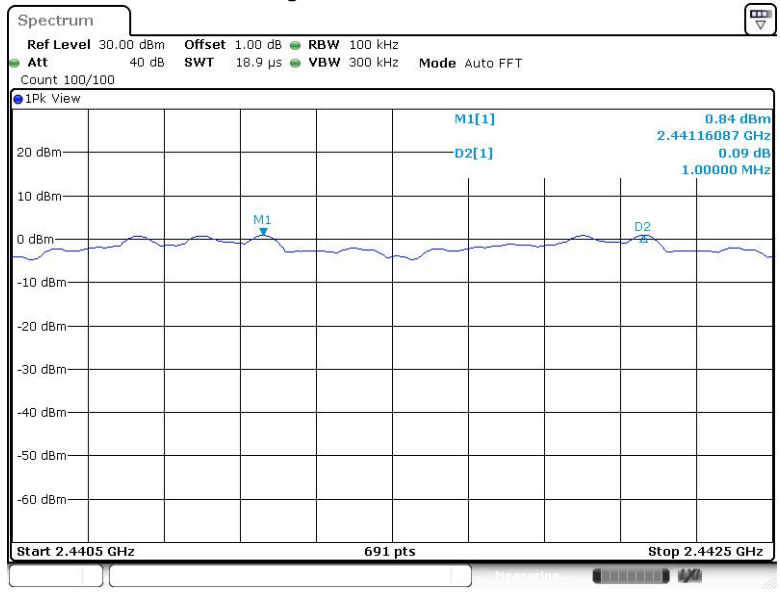

Date: 3 JAN 2020 10:59:27



9.4 Number of hopping frequencies

Test Method

1. Use the following spectrum analyzer settings:
Span = wide enough to capture the peaks of two adjacent channels, $RBW \geq 1\%$ of the span, $VBW \geq RBW$, Sweep = auto, Detector function = peak
2. Set the spectrum analyzer on Max-Hold Mode, and then keep the EUT in hopping mode.
3. Record all the signals from each channel until each one has been recorded.
4. Repeat above procedures until all frequencies measured were complete.

Limit

**Limit
number**

≥ 15



Number of hopping frequencies

Test result: The measurement was performed with the typical configuration (normal hopping status), and the total hopping channels is constant for the all modulation mode according with the Bluetooth Core Specification. Here GFSK modulation mode was used to show compliance.

Number of hopping frequencies	Result
79	Pass

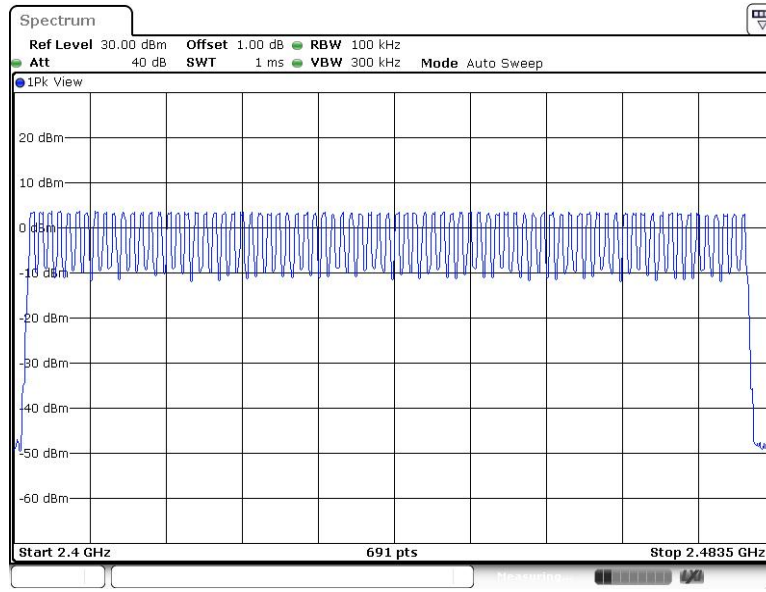

Date: 3 JAN 2020 09:59:18

9.5 Dwell Time

Test Method

1. Connect EUT antenna terminal to the spectrum analyzer with a low loss cable.
Equipment mode: Spectrum analyzer
2. RBW: 1MHz; VBW: 1MHz; SPAN: Zero Span
3. Adjust the center frequency of spectrum analyzer on any frequency be measured.
4. Measure the Dwell Time by spectrum analyzer Marker function.
5. Repeat above procedures until all frequencies measured were complete.

Limit

The average time of occupancy on any frequency shall not be greater than 0.4 seconds within a period of 0.4 seconds multiplied by the number of hopping channels employed.

Dwell Time

Dwell time

The maximum dwell time shall be 0.4 s.

According to the Bluetooth Core Specification, the worse result (DH5 mode) was reported to show compliance.

The Dwell Time = Burst Width * Total Hops. The detailed calculations are showed as follows:

The duration for dwell time calculation: 0.4 [s] * hopping number = 0.4 [s] * 79 [ch] = 31.6 [s*ch];

The burst width, which is directly measured, refers to the duration on one channel hop.

The maximum number of hopping channels in 31.6s for DH5=1600 / 6 / 79 *31.6=106.67

Test Result

Modulation	Mode	Reading (us)	Total Hops	Test Result (ms)	Limit (ms)	Result
GFSK	DH5	2872	106.67	306.36	< 400	Pass
$\pi/4$ -DQPSK	2DH5	2878	106.67	307.0	< 400	Pass
8-DPSK	3DH5	2880	307.21	< 400	Pass	

GFSK Modulation

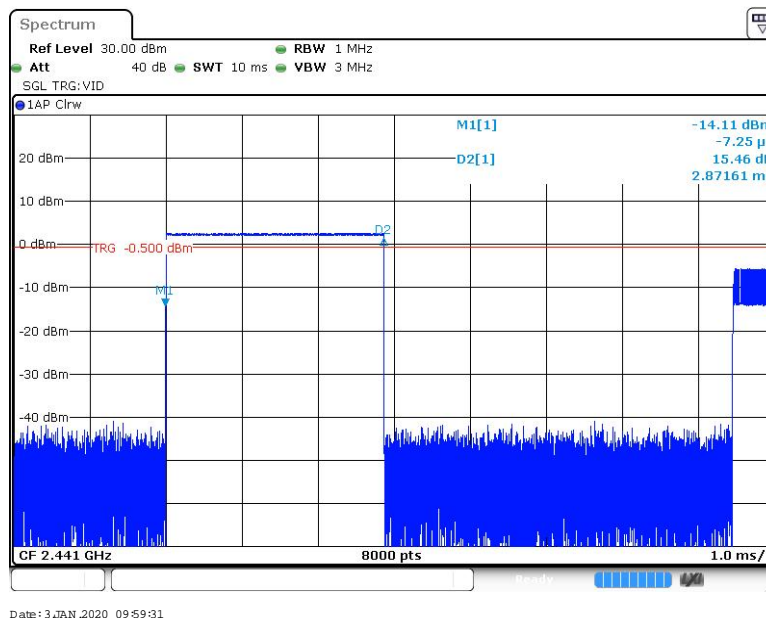

DH5

$\pi/4$ -DQPSK Modulation

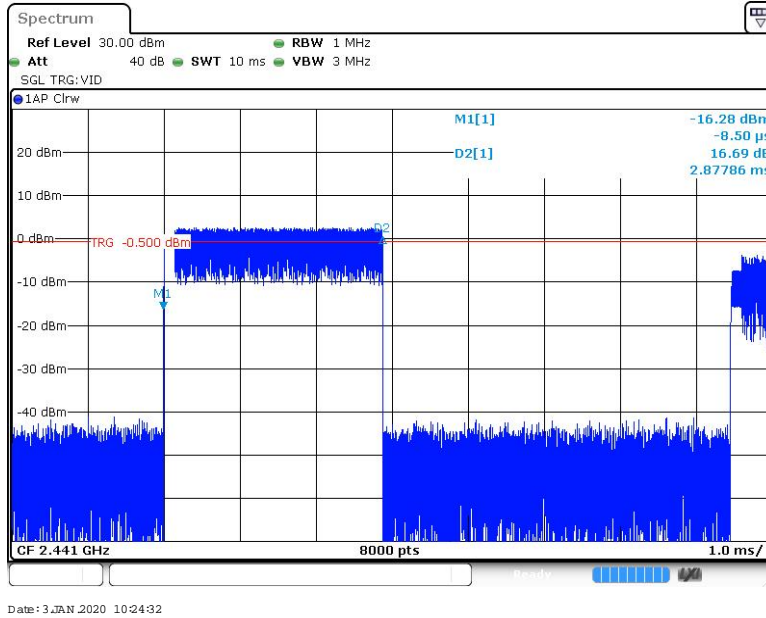

2DH5

8-DPSK Modulation

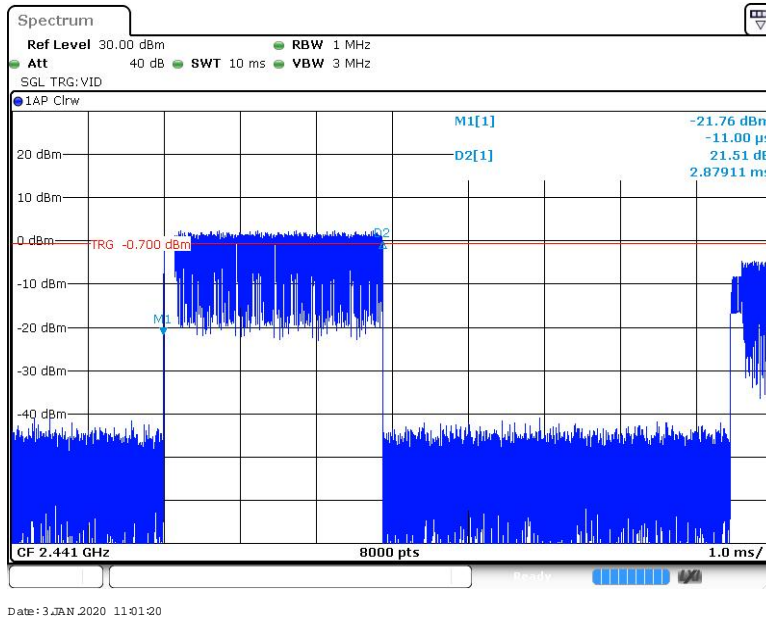

3DH5



9.6 Spurious RF conducted emissions

Test Method

1. Use the following spectrum analyzer settings:
 Span = wide enough to capture the peak level of the in-band emission and all spurious emissions (e.g., harmonics) from the lowest frequency generated in the EUT up through the 10th harmonic. Typically, several plots are required to cover this entire span.
 RBW = 100 kHz, VBW ≥ RBW, Sweep = auto, Detector function = peak, Trace = max hold
2. Allow the trace to stabilize. Set the marker on the peak of any spurious emission recorded.
3. The level displayed must comply with the limit specified in this Section. Submit these plots.
4. Repeat above procedures until all frequencies measured were complete.

Limit

Frequency Range MHz	Limit (dBc)
30-25000	-20

Spurious RF conducted emissions

Only the worse case (which is subject to the maximum EIRP, GFSK mode) test result is listed in the report.

GFSK Modulation:

Low channel 2402MHz

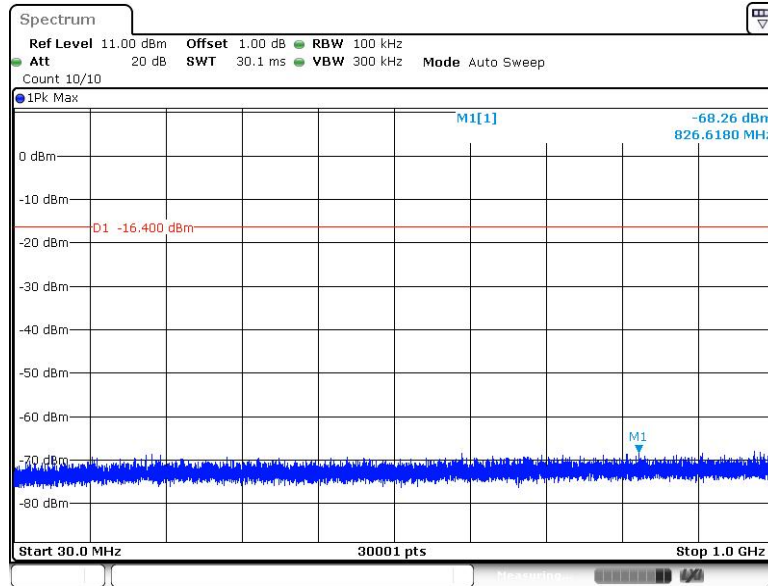

Date: 3.JAN.2020 09:28:32

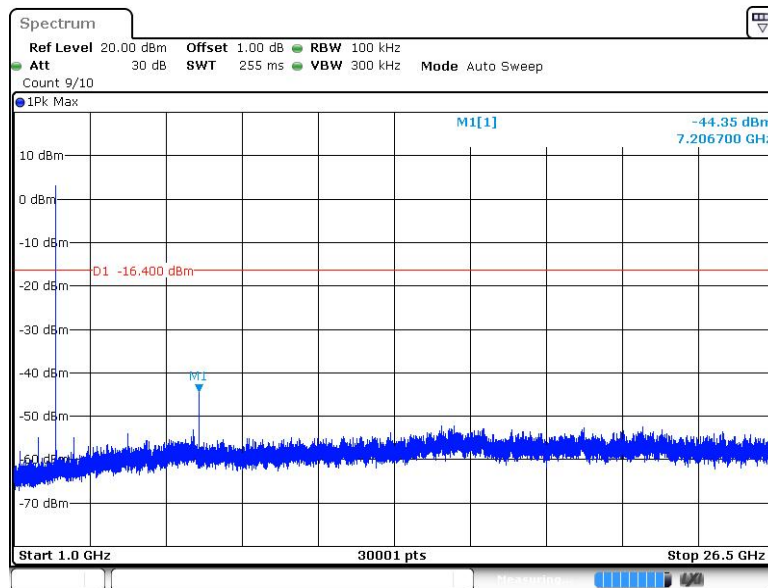

Date: 3.JAN.2020 09:28:44



Middle channel 2441MHz

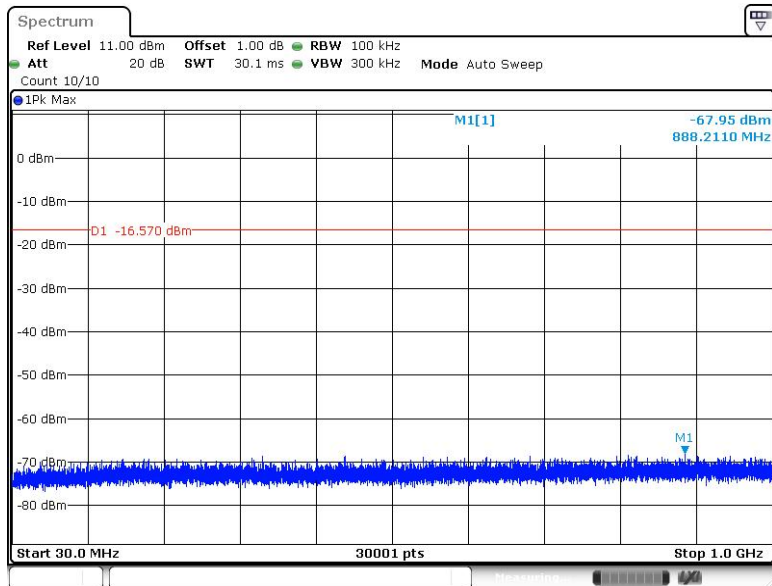

Date: 3 JAN 2020 09:30:12

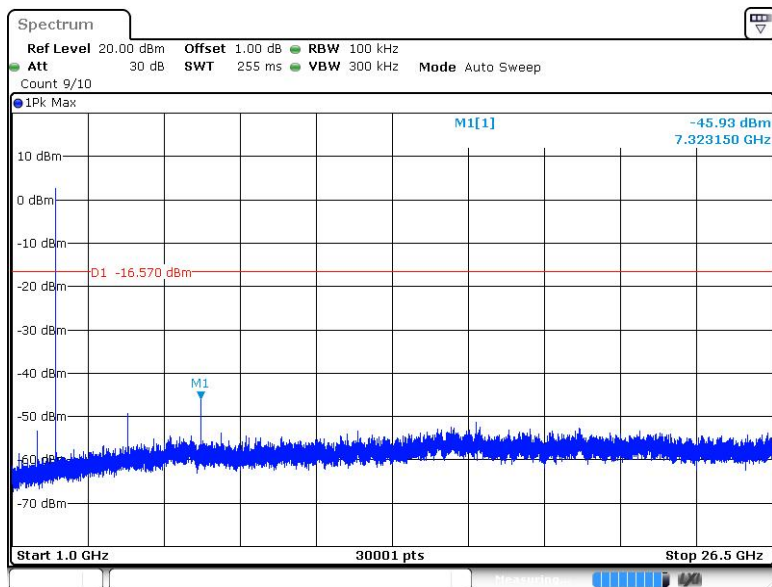

Date: 3 JAN 2020 09:30:23



High channel 2480MHz

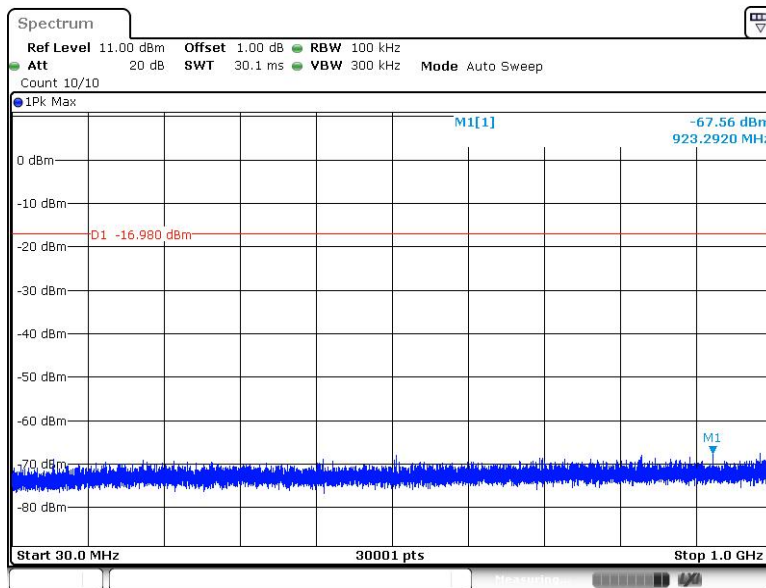

Date: 3 JAN 2020 09:33:08

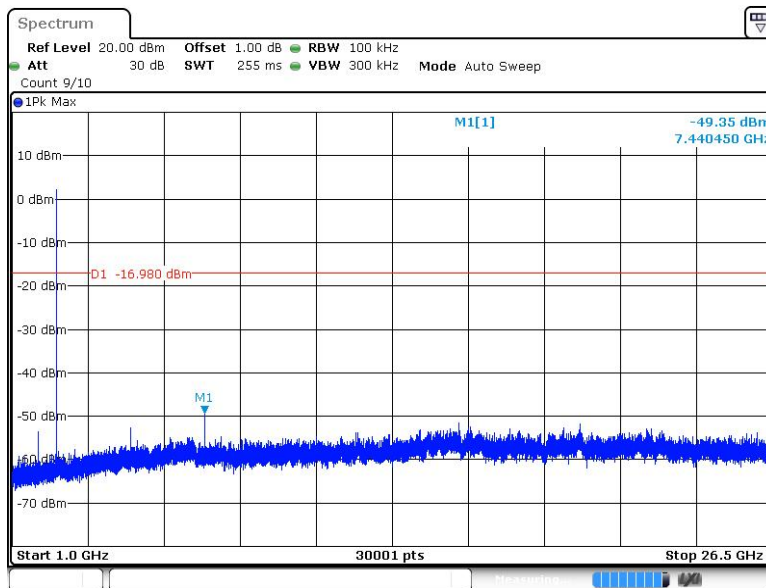

Date: 3 JAN 2020 09:33:19

9.7 Band edge testing

Test Method

- 1 Use the following spectrum analyzer settings:
Span = wide enough to capture the peak level of the in-band emission and all spurious
RBW = 100 kHz, VBW \geq RBW, Sweep = auto, Detector function = peak, Trace = max hold
- 2 Allow the trace to stabilize, use the peak and delta measurement to record the result.
- 3 The level displayed must comply with the limit specified in this Section. .
- 4 Repeat the test at the hopping off and hopping on mode, submit all the plots.

Limit:

In any 100 kHz bandwidth outside the frequency band in which the spread spectrum or digitally modulated device is operating, the RF power that is produced shall be at least 20 dB below that in the 100 kHz bandwidth within the band that contains the highest level of the desired power, based on either an RF conducted or a radiated measurement, provided that the transmitter demonstrates compliance with the peak conducted power limits.

GFSK mode: Hopping off

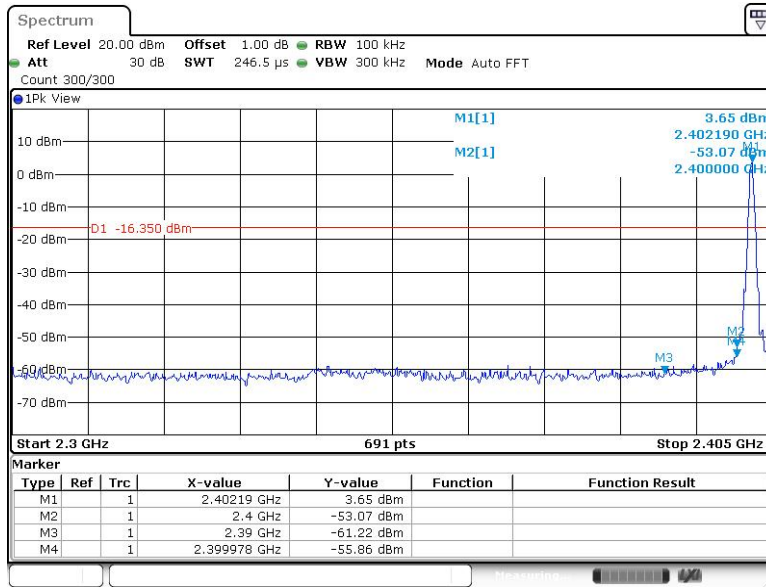

Date: 3.JAN.2020 09:28:16

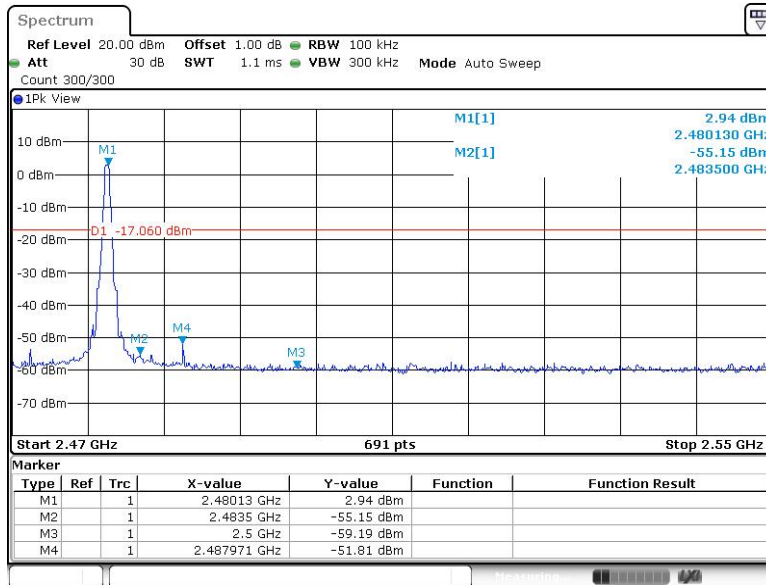

Date: 3.JAN.2020 09:32:52

GFSK mode: Hopping on

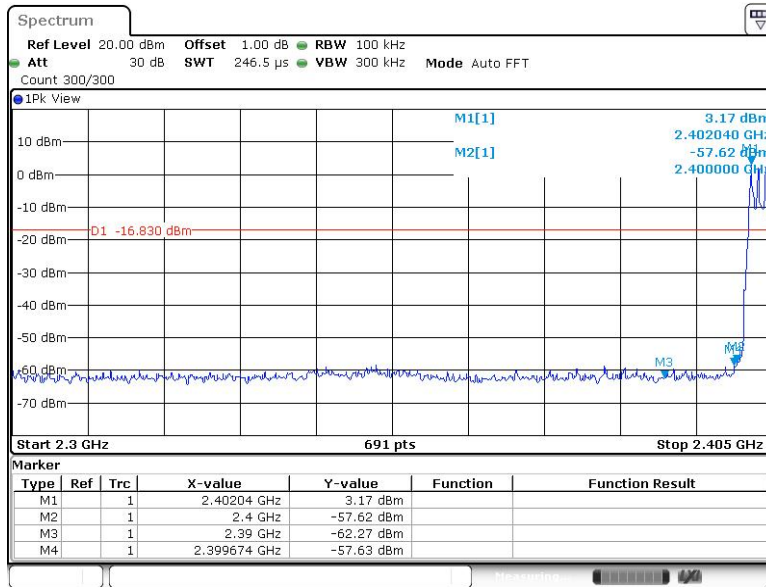

Date: 3 JAN 2020 09:55:22

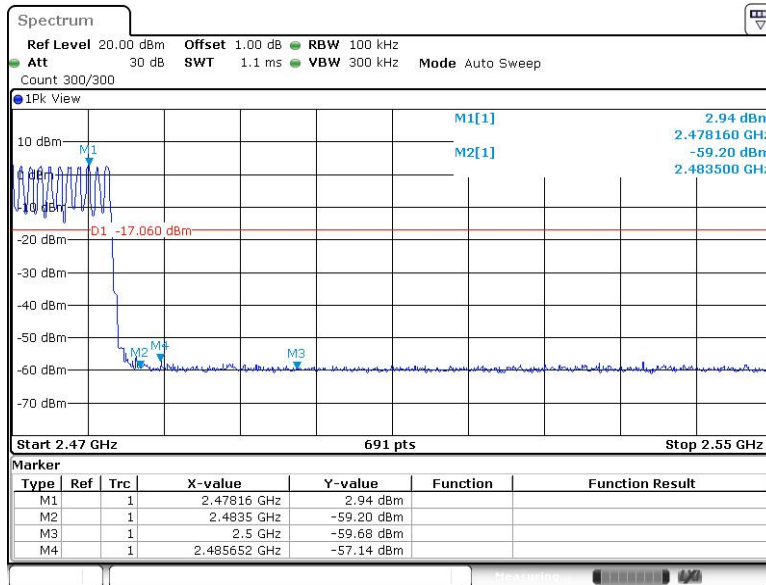

Date: 3 JAN 2020 10:13:42

8DPSK mode: Hopping off

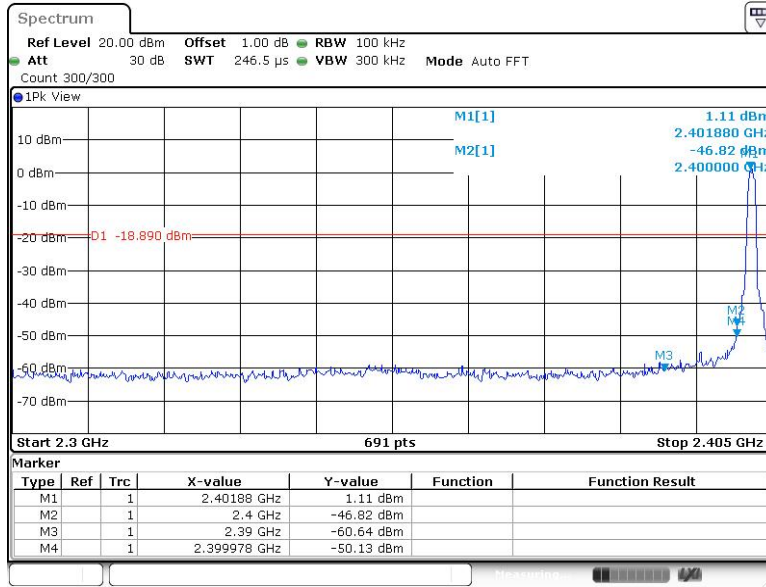

Date: 3.JAN.2020 09:48:31

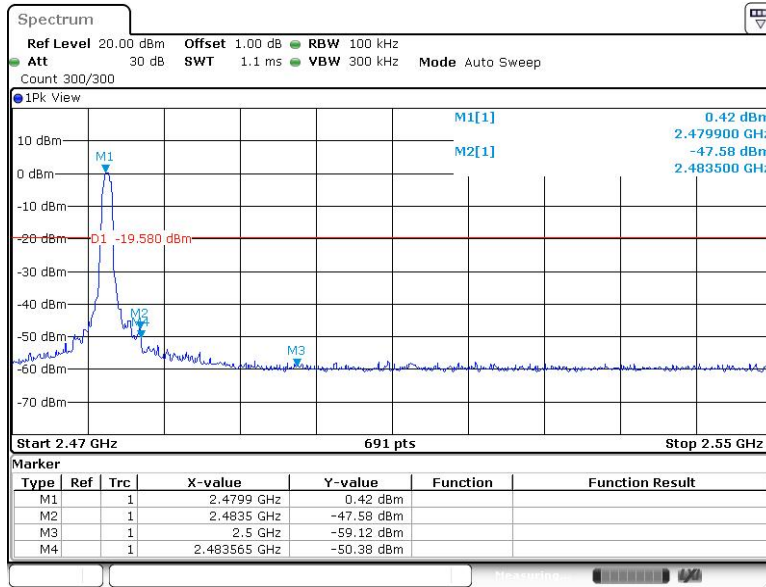

Date: 3.JAN.2020 09:52:30

8DPSK mode: Hopping on

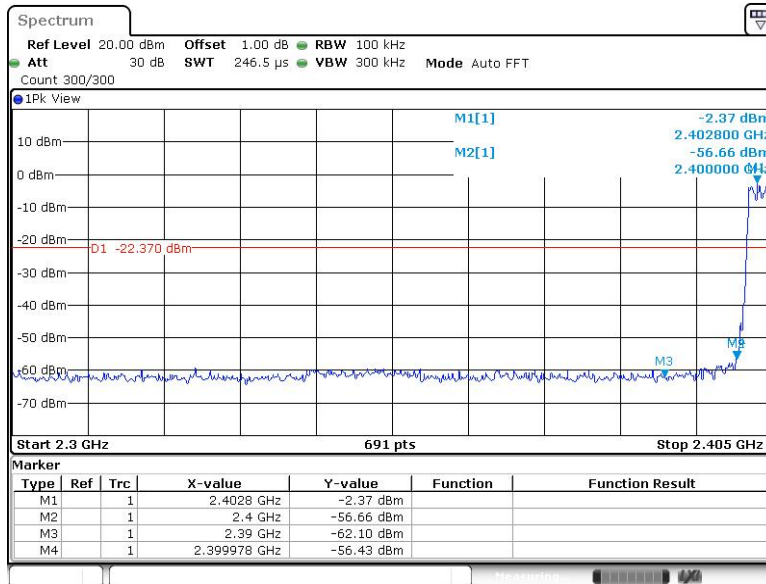

Date: 3.JAN.2020 10:27:23

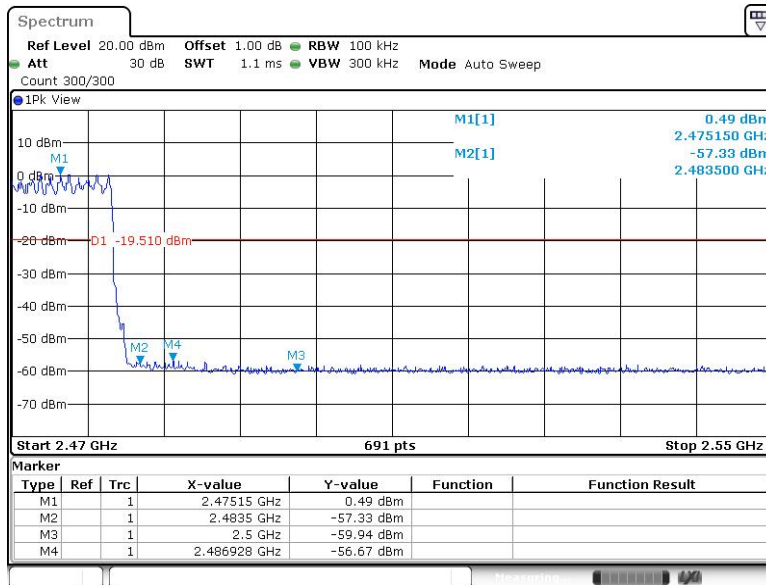

Date: 3.JAN.2020 11:08:40

9.8 Spurious radiated emissions for transmitter

Test Method

- 1: The EUT was placed on a turn table which is 1.5m above ground plane for above 1GHz and 0.8m above ground for below 1GHz at 3 meter chamber room for test. The table was rotated 360 degrees to determine the position of the highest radiation.
- 2: The EUT was set 3 meters away from the interference – receiving antenna, which was mounted on the top of a variable – height antenna tower.
- 3: The height of antenna is varied from one meter to four meters above the ground to determine the maximum value of the field strength. Both horizontal and vertical polarizations of the antenna are set to make the measurement.
- 4: For each suspected emission, the EUT was arranged to its worst case and then the antenna was tuned to heights from 1 meter to 4 meters and the rotatable table was turned from 0 degrees to 360 degrees to find the maximum reading.
- 5: Use the following spectrum analyzer settings According to C63.10:
For Below 1GHz
Use the following spectrum analyzer settings:
Span = wide enough to capture the peak level of the in-band emission and all spurious
RBW = 100 KHz to 120KHz, VBW \geq RBW for peak measurement, Sweep = auto,
Detector function = peak, Trace = max hold.
For Peak unwanted emissions Above 1GHz:
Span = wide enough to capture the peak level of the in-band emission and all spurious
RBW = 1MHz, VBW \geq RBW for peak measurement, Sweep = auto,
Detector function = peak, Trace = max hold.
Procedures for average unwanted emissions measurements above 1000 MHz:
Span = wide enough to capture the peak level of the in-band emission and all spurious
RBW = 1MHz, VBW=10Hz, Sweep = auto, Detector function = peak, Trace = max hold.
If the dwell time per channel of the hopping signal is less than 100 ms, then the reading obtained with the 10 Hz VBW may be further adjusted by a “duty cycle correction factor”, derived from $20\log(\text{dwell time}/100 \text{ ms})$, in an effort to demonstrate compliance with the 15.209 limit.
If the emission is pulsed, modify the unit for continuous operation; use the settings shown above, then correct the reading by subtracting the peak-average correction factor, derived from the appropriate duty cycle calculation.
The setting method can refer to DA00-705.

Limit

The radio emission outside the operating frequency band shall be at least 20 dB below that in the 100 kHz bandwidth within the band that contains the highest level of the desired power. Radiated emissions which fall in the restricted bands, as defined in section 15.205, must comply with the radiated emission limits specified in section 15.209.

Frequency MHz	Field Strength uV/m	Field Strength dBµV/m	Detector
30-88	100	40	QP
88-216	150	43.5	QP
216-960	200	46	QP
960-1000	500	54	QP
Above 1000	500	54	AV
Above 1000	5000	74	PK

Spurious radiated emissions for transmitter

The only worse case (which is subject to the maximum EIRP, GFSK mode) test result is listed in the report.

Transmitting spurious emission test result as below:

BT3.0 GFSK Modulation 2402MHz Test Result

Frequency Band	Frequency	Emission Level	Polarization	Limit	Detector	Margin	Correct factor (dB/m)	Result
	MHz	dBuV/m		dBuV/m		dBuV/m		
30-1000MHz	930.59	32.40	H	46	QP	13.60	24.0	Pass
	718.27	30.70	V	43.5	QP	15.30	21.60	Pass
1000-25000MHz	1902	45.06	H	74	PK	28.94	-5.6	Pass
	--	--	H	54	AV	--	--	Pass
	4804*	51.38	V	74	PK	22.62	2.5	Pass
	--	--	V	54	AV	--	--	Pass

BT3.0 GFSK Modulation 2441MHz Test Result

Frequency Band	Frequency	Emission Level	Polarization	Limit	Detector	Margin	Correct factor (dB/m)	Result
	MHz	dBuV/m		dBuV/m		dBuV/m		
30-1000MHz	--	--	H	43.5	QP	--	--	Pass
	--	--	H	46	QP	--	--	Pass
1000-25000MHz	6993	48.59	H	74	PK	25.41	7.3	Pass
	--	--	H	54	AV	--	--	Pass
	6999	49.92	V	74	PK	24.08	7.3	Pass
	--	--	V	54	AV	--	--	Pass



BT3.0 GFSK Modulation 2480MHz Test Result

Frequency Band	Frequency	Emission Level	Polarization	Limit	Detector	Margin	Correct factor (dB/m)	Result
	MHz	dBuV/m		dBμV/m		dBuV/m		
30-1000MHz	--	--	H	43.5	QP	--	--	Pass
	--	--	H	46	QP	--	--	Pass
1000-25000MHz	7440*	48.81	H	74	PK	25.19	5.9	Pass
	--	--	H	54	AV	--	--	Pass
	7440*	47.69	V	74	PK	26.31	5.9	Pass
	--	--	V	54	AV	--	--	Pass

Remark:

- (1) “*” means the emission(s) appear within the restrict bands shall follow the requirement of section 15.205.
- (2) Data of measurement within this frequency range shown “--” in the table above means the reading of emissions are the noise floor or attenuated more than 10dB below the permissible limits or the field strength is too small to be measured.
- (3) Level=Reading Level + Correction Factor
 Above 1GHz: Corrector factor = Antenna Factor + Cable Loss- Amplifier Gain
 Below 1GHz: Corrector factor = Antenna Factor + Cable Loss
 (The Reading Level is recorded by software which is not shown in the sheet)

10 Test Equipment List

List of Test Instruments

Radiated Spurious Emission Test

Description	Manufacturer	Model no.	Equipment ID	Serial no.	cal. due date
Signal Analyzer	Rohde & Schwarz	FSV40	68-4-74-14-003	101031	2020-6-28
Trilog Super Broadband Test Antenna	Schwarzbeck	VULB 9163	68-4-80-14-003	708	2020-7-5
Horn Antenna	Rohde & Schwarz	HF907	68-4-80-14-004	102295	2020-7-5
Wideband Horn Antenna	Q-PAR	QWH-SL-18-40-K-SG	68-4-80-14-008	12827	2020-7-5
Loop Antenna	Rohde & Schwarz	HFH2-Z2	68-4-80-14-006	100398	2020-7-7
Pre-amplifier	Rohde & Schwarz	SCU 18	68-4-29-14-001	102230	2020-6-28
Pre-amplifier	Rohde & Schwarz	SCU 40A	68-4-29-14-002	100432	2020-7-16
Fully Anechoic Chamber	TDK	8X4X4	68-4-90-14-002	--	2020-7-7
Test software	Rohde & Schwarz	EMC32	68-4-90-14-002-A10	Version 9.15.00	N/A

RF Conducted Test

Description	Manufacturer	Model no.	Equipment ID	Serial no.	cal. due date
Signal Analyzer	Rohde & Schwarz	FSV40	68-4-74-14-004	101030	2020-6-28

11 System Measurement Uncertainty

For a 95% confidence level, the measurement expanded uncertainties for defined systems, in accordance with the recommendations of ISO 17025 were:

System Measurement Uncertainty	
Test Items	Extended Uncertainty
Radiated Spurious Emission 25MHz-3000MHz	Horizontal: 4.81dB; Vertical: 4.89dB;
Radiated Spurious Emission 3000MHz-18000MHz	Horizontal: 4.69dB; Vertical: 4.68dB;
Radiated Spurious Emission 18000MHz-40000MHz	Horizontal: 4.89dB; Vertical: 4.87dB;
Conducted RF test with TS 8997	RF Power Conducted: 1.16dB Frequency test involved: 0.6×10 ⁻⁷ or 1%