



# TEST REPORT

No.I18N00939-SAR

For

**Spectralink Corp**

**Wifi/BT handset**

**Model Name: 9540**

With

**Hardware Version: PIO**

**Software Version: vF03**

**FCC ID: IYG95XX**

**Issued Date: 2018-08-10**

**Designation Number: CN1210**

**Note:**

The test results in this test report relate only to the devices specified in this report. This report shall not be reproduced except in full without the written approval of SAICT.

**Test Laboratory:**

Shenzhen Academy of Information and Communications Technology  
Building G, Shenzhen International Innovation Center, No.1006 Shennan Road, Futian District, Shenzhen,  
Guangdong, P. R. China 518026.

Tel: +86(0)755-33322000, Fax: +86(0)755-33322001

Email: [yewu@caict.ac.cn](mailto:yewu@caict.ac.cn), website: [www.cszit.com](http://www.cszit.com)

## **REPORT HISTORY**

<b>Report Number</b>	<b>Revision</b>	<b>Issue Date</b>	<b>Description</b>
I18N00939-SAR	Rev.0	2018-08-10	Initial creation of test report

## TABLE OF CONTENT

<b>1 TEST LABORATORY .....</b>	<b>5</b>
1.1 TESTING LOCATION .....	5
1.2 TESTING ENVIRONMENT.....	5
1.3 PROJECT DATA .....	5
1.4 SIGNATURE.....	5
<b>2 STATEMENT OF COMPLIANCE .....</b>	<b>6</b>
<b>3 CLIENT INFORMATION .....</b>	<b>7</b>
3.1 APPLICANT INFORMATION .....	7
3.2 MANUFACTURER INFORMATION .....	7
<b>4 EQUIPMENT UNDER TEST (EUT) AND ANCILLARY EQUIPMENT (AE) .....</b>	<b>8</b>
4.1 ABOUT EUT .....	8
4.2 INTERNAL IDENTIFICATION OF EUT USED DURING THE TEST .....	8
4.3 INTERNAL IDENTIFICATION OF AE USED DURING THE TEST .....	8
<b>5 TEST METHODOLOGY .....</b>	<b>9</b>
5.1 APPLICABLE LIMIT REGULATIONS .....	9
5.2 APPLICABLE MEASUREMENT STANDARDS.....	9
<b>6 SPECIFIC ABSORPTION RATE (SAR).....</b>	<b>10</b>
6.1 INTRODUCTION.....	10
6.2 SAR DEFINITION.....	10
<b>7 TISSUE SIMULATING LIQUIDS .....</b>	<b>11</b>
7.1 TARGETS FOR TISSUE SIMULATING LIQUID .....	11
7.2 DIELECTRIC PERFORMANCE .....	11
<b>8 SYSTEM VERIFICATION .....</b>	<b>14</b>
8.1 SYSTEM SETUP.....	14
8.2 SYSTEM VERIFICATION.....	15
<b>9 MEASUREMENT PROCEDURES .....</b>	<b>16</b>
9.1 TESTS TO BE PERFORMED .....	16
9.2 GENERAL MEASUREMENT PROCEDURE.....	18
9.3 BLUETOOTH & WI-FI MEASUREMENT PROCEDURES FOR SAR.....	19
9.4 POWER DRIFT.....	19
<b>10 CONDUCTED OUTPUT POWER.....</b>	<b>20</b>
<b>11 SIMULTANEOUS TX SAR CONSIDERATIONS .....</b>	<b>24</b>
11.1 INTRODUCTION.....	24
11.2 TRANSMIT ANTENNA SEPARATION DISTANCES .....	24
11.3 SAR MEASUREMENT POSITIONS .....	25

11.4 STANDALONE SAR TEST EXCLUSION CONSIDERATIONS .....	25
<b>12 EVALUATION OF SIMULTANEOUS.....</b>	<b>26</b>
<b>13 SAR TEST RESULT .....</b>	<b>27</b>
13.1 WLAN EVALUATION FOR 2.4G .....	28
13.2 WLAN EVALUATION FOR 5G .....	30
<b>14 SAR MEASUREMENT VARIABILITY.....</b>	<b>37</b>
<b>15 MEASUREMENT UNCERTAINTY .....</b>	<b>38</b>
15.1 MEASUREMENT UNCERTAINTY FOR NORMAL SAR TESTS (300MHZ~3GHZ) .....	38
15.2 MEASUREMENT UNCERTAINTY FOR FAST SAR TESTS (300MHZ~3GHZ) .....	39
15.3 MEASUREMENT UNCERTAINTY FOR NORMAL SAR TESTS (3GHZ~6GHZ).....	40
15.4 MEASUREMENT UNCERTAINTY FOR FAST SAR TESTS (3GHZ~6GHZ) .....	41
<b>16 MAIN TEST INSTRUMENTS.....</b>	<b>42</b>
<b>ANNEX A GRAPH RESULTS.....</b>	<b>43</b>
<b>ANNEX B SYSTEM VERIFICATION RESULTS .....</b>	<b>47</b>
<b>ANNEX C SAR MEASUREMENT SETUP .....</b>	<b>55</b>
C.1 MEASUREMENT SET-UP .....	55
C.2 DASY5 E-FIELD PROBE SYSTEM.....	56
C.3 E-FIELD PROBE CALIBRATION .....	56
C.4 OTHER TEST EQUIPMENT.....	57
<b>ANNEX D POSITION OF THE WIRELESS DEVICE IN RELATION TO THE PHANTOM .....</b>	<b>61</b>
D.1 GENERAL CONSIDERATIONS.....	61
D.2 BODY-WORN DEVICE .....	62
D.3 DESKTOP DEVICE.....	62
D.4 DUT SETUP PHOTOS.....	63
<b>ANNEX E EQUIVALENT MEDIA RECIPES.....</b>	<b>64</b>
<b>ANNEX F SYSTEM VALIDATION .....</b>	<b>65</b>
<b>ANNEX G DAE CALIBRATION CERTIFICATE.....</b>	<b>66</b>
<b>ANNEX H PROBE CALIBRATION CERTIFICATE.....</b>	<b>69</b>
<b>ANNEX I DIPOLE CALIBRATION CERTIFICATE.....</b>	<b>80</b>
<b>ANNEX J EXTENDED CALIBRATION SAR DIPOLE.....</b>	<b>104</b>
<b>ANNEX K SPOT CHECK TEST .....</b>	<b>106</b>
K.1 INTERNAL IDENTIFICATION OF EUT USED DURING THE SPOT CHECK TEST .....	106
K.2 MEASUREMENT RESULTS .....	106
<b>ANNEX L SYSTEM VERIFICATION RESULTS FOR SPOT CHECK TEST.....</b>	<b>112</b>

## 1 Test Laboratory

### 1.1 Testing Location

Company Name:	Shenzhen Academy of Information and Communications Technology
Address:	Building G, Shenzhen International Innovation Center, No.1006 Shennan Road, Futian District, Shenzhen, Guangdong, P. R. China
Postal Code:	518026
Telephone:	+86-755-33322000
Fax:	+86-755-33322001

### 1.2 Testing Environment

Temperature:	18°C~25 °C
Relative humidity:	30%~ 70%
Ground system resistance:	<4Ω
Ambient noise & Reflection:	< 0.012 W/kg

### 1.3 Project Data

Testing Start Date:	July 08, 2018
Testing End Date:	July 27, 2018

### 1.4 Signature

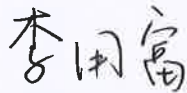

Li Yongfu

(Prepared this test report)



Zhang Yunzhuan

(Reviewed this test report)



Cao Junfei

Deputy Director of the laboratory  
(Approved this test report)

## 2 Statement of Compliance

**This EUT is a variant product and the report of original sample is No.I18N00940-SAR. According to the client request, we quote the test results of original sample. The results of spot check are presented in annex K.**

The maximum results of Specific Absorption Rate (SAR) found during testing for Spectralink Corp Wifi/BT handset 9540 are as follows:

**Table 2.1: Highest Reported SAR for Head (1g)**

Exposure Configuration	Technology Band	Highest Reported SAR 1g(W/Kg)	Equipment Class
Head (Separation Distance 0mm)	WLAN 2.4GHz	0.62	DTS
	WLAN 5GHz	<b>0.91</b>	U-NII-2A

**Table 2.2: Highest Reported SAR for Body (1g)**

Exposure Configuration	Technology Band	Highest Reported SAR 1g(W/Kg)	Equipment Class
Body (Separation Distance 10 mm)	WLAN 2.4GHz	0.27	DTS
	WLAN 5GHz	0.54	U-NII-2C

The SAR values found for the Mobile Phone are below the maximum recommended levels of 1.6 W/Kg as averaged over any 1g tissue according to the ANSI C95.1-1992.

For body worn operation, this device has been tested and meets FCC RF exposure guidelines when used with any accessory that contains no metal and which provides a minimum separation distance of 10mm between this device and the body of the user. Use of other accessories may not ensure compliance with FCC RF exposure guidelines.

The EUT battery must be fully charged and checked periodically during the test to ascertain uniform power output.

The measurement together with the test system set-up is described in annex C of this test report. A detailed description of the equipment under test can be found in chapter 4 of this test report.

The highest reported SAR value is obtained at the case of **(Table 2.1 & 2.2)**, and the values are: **0.91W/kg (1g)**.

### 3 Client Information

#### 3.1 Applicant Information

Company Name:	Spectralink Corp
Address /Post:	2560 55th Street Boulder, CO 80301 USA
Contact:	Andrew Duncan
Email:	Andrew.duncan@spectralink.com
Telephone:	+1 720-925-0480
Fax:	/

#### 3.2 Manufacturer Information

Company Name:	Spectralink Corp
Address /Post:	2560 55th Street Boulder, CO 80301 USA
Contact:	Andrew Duncan
Email:	Andrew.duncan@spectralink.com
Telephone:	+1 720-925-0480
Fax:	/

## 4 Equipment Under Test (EUT) and Ancillary Equipment (AE)

### 4.1 About EUT

Description:	Wifi/BT handset
Model Name:	9540
Operating mode(s):	BT, Wi-Fi 2.4G/5G.
Tested Tx Frequency:	2412 – 2462MHz (Wi-Fi 2.4G)
	5150 – 5825MHz (Wi-Fi 5G)
Test device Production information:	Production unit
Device type:	Portable device
Antenna type:	Integrated antenna
Hotspot mode:	Support

### 4.2 Internal Identification of EUT used during the test

EUT ID*	IMEI or mac	HW Version	SW Version
EUT1	IMEI: 359940090001508	PIO	vF03
EUT2	IMEI: 359940090001490	PIO	vF03
EUT3	mac: 00:90:7A:A7:DB:0B	PIO	vF03
EUT3	mac: 00:90:7A:A7:DA:CE	PIO	vF03

\*EUT ID: is used to identify the test sample in the lab internally.

**Note:** It is performed to test SAR with the EUT 1 & EUT 3& EUT 4, and conducted power with the EUT 2.

### 4.3 Internal Identification of AE used during the test

AE ID*	Description	Model	Manufacturer
AE1	Battery	Rechargeable Li-ion Polymer Battery	Zhuhai City Gushine Electronic Technology Co., Ltd.
AE2	Battery	Rechargeable Li-ion Polymer Battery	Smart Power Electronic (huizhou) Co., Ltd.

\*AE ID: is used to identify the test sample in the lab internally.

**Note:** The AE2 battery is for system maintenance, do not affect the EUT's working condition.



## 5 TEST METHODOLOGY

### 5.1 Applicable Limit Regulations

**ANSI C95.1–1992:** IEEE Standard for Safety Levels with Respect to Human Exposure to Radio Frequency Electromagnetic Fields, 3 kHz to 300 GHz.

It specifies the maximum exposure limit of **1.6 W/kg** as averaged over any 1 gram of tissue for portable devices being used within 20 cm of the user in the uncontrolled environment.

### 5.2 Applicable Measurement Standards

**IEEE 1528–2013:** Recommended Practice for Determining the Peak Spatial-Average Specific Absorption Rate (SAR) in the Human Head from Wireless Communications Devices: Experimental Techniques.

**KDB 447498 D01 General RF Exposure Guidance v06:** Mobile and Portable Devices RF Exposure Procedures and Equipment Authorization Policies.

**KDB648474 D04 Handset SAR v01r03:** SAR Evaluation Considerations for Wireless Handsets.

**KDB 941225 D06 Hot Spot SAR v02r01:** SAR Evaluation Procedures for Portable Devices with Wireless Router Capabilities

**KDB 248227 D01 802.11 Wi-Fi SAR v02r02:** SAR Guidance for IEEE 802.11 (Wi-Fi) Transmitters.

**KDB 865664 D01 SAR measurement 100 MHz to 6 GHz v01r04:** SAR Measurement Requirements for 100 MHz to 6 GHz.

**KDB 865664 D02 RF Exposure Reporting v01r02:** RF Exposure Compliance Reporting and Documentation Considerations

## 6 Specific Absorption Rate (SAR)

### 6.1 Introduction

SAR is related to the rate at which energy is absorbed per unit mass in an object exposed to a radio field. The SAR distribution in a biological body is complicated and is usually carried out by experimental techniques or numerical modeling. The standard recommends limits for two tiers of groups, occupational/controlled and general population/uncontrolled, based on a person's awareness and ability to exercise control over his or her exposure. In general, occupational/controlled exposure limits are higher than the limits for general population/uncontrolled.

### 6.2 SAR Definition

The SAR definition is the time derivative (rate) of the incremental energy ( $dW$ ) absorbed by (dissipated in) an incremental mass ( $dm$ ) contained in a volume element ( $dv$ ) of a given density ( $\rho$ ). The equation description is as below:

$$SAR = \frac{d}{dt} \left( \frac{dW}{dm} \right) = \frac{d}{dt} \left( \frac{dW}{\rho dv} \right)$$

SAR is expressed in units of Watts per kilogram (W/kg)

SAR measurement can be either related to the temperature elevation in tissue by

$$SAR = c \left( \frac{\delta T}{\delta t} \right)$$

Where:  $C$  is the specific heat capacity,  $\delta T$  is the temperature rise and  $\delta t$  is the exposure duration, or related to the electrical field in the tissue by

$$SAR = \frac{\sigma |E|^2}{\rho}$$

Where:  $\sigma$  is the conductivity of the tissue,  $\rho$  is the mass density of tissue and  $E$  is the RMS electrical field strength.

However for evaluating SAR of low power transmitter, electrical field measurement is typically applied.

## 7 Tissue Simulating Liquids

### 7.1 Targets for tissue simulating liquid

**Table 7.1: Targets for tissue simulating liquid**

Frequency (MHz)	Liquid Type	Conductivity ( $\sigma$ )	$\pm 5\%$ Range	Permittivity ( $\epsilon$ )	$\pm 5\%$ Range
2450	Head	1.80	1.71~1.89	39.20	37.2~41.2
2450	Body	1.95	1.85~2.05	52.70	50.1~55.3
5200	Head	4.66	4.43~4.89	35.99	34.2~37.7
5200	Body	5.30	5.04~5.56	49.00	46.6~51.4
5300	Head	4.76	4.52~5.00	35.87	34.1~37.6
5300	Body	5.42	5.15~5.69	48.90	46.5~51.3
5600	Head	5.07	4.82~5.32	35.53	33.8~37.3
5600	Body	5.77	5.48~6.06	48.50	46.1~50.9
5800	Head	5.27	5.01~5.53	35.30	33.5~37.1
5800	Body	6.00	5.70~6.30	48.20	45.8~50.6

### 7.2 Dielectric Performance

**Table 7.2: Dielectric Performance of Tissue Simulating Liquid**

Measurement Date (yyyy-mm-dd)	Type	Frequency	Conductivity $\sigma$ (S/m)	Drift (%)	Permittivity $\epsilon$	Drift (%)
2018-7-27	Head	2450	1.843	2.39	38.59	-1.56
2018-7-27	Body	2450	1.907	-2.21	53.86	2.20
2018-7-27	Head	5300	4.832	1.51	35.44	-1.20
2018-7-27	Body	5300	5.368	-0.96	50.19	2.64
2018-7-27	Head	5600	5.224	3.04	34.55	-2.76
2018-7-27	Body	5600	5.805	0.61	48.12	-0.78
2018-7-27	Head	5800	5.326	1.06	34.68	-1.76
2018-7-27	Body	5800	6.108	1.80	47.54	-1.37

Note: The liquid temperature is 22.0°C.

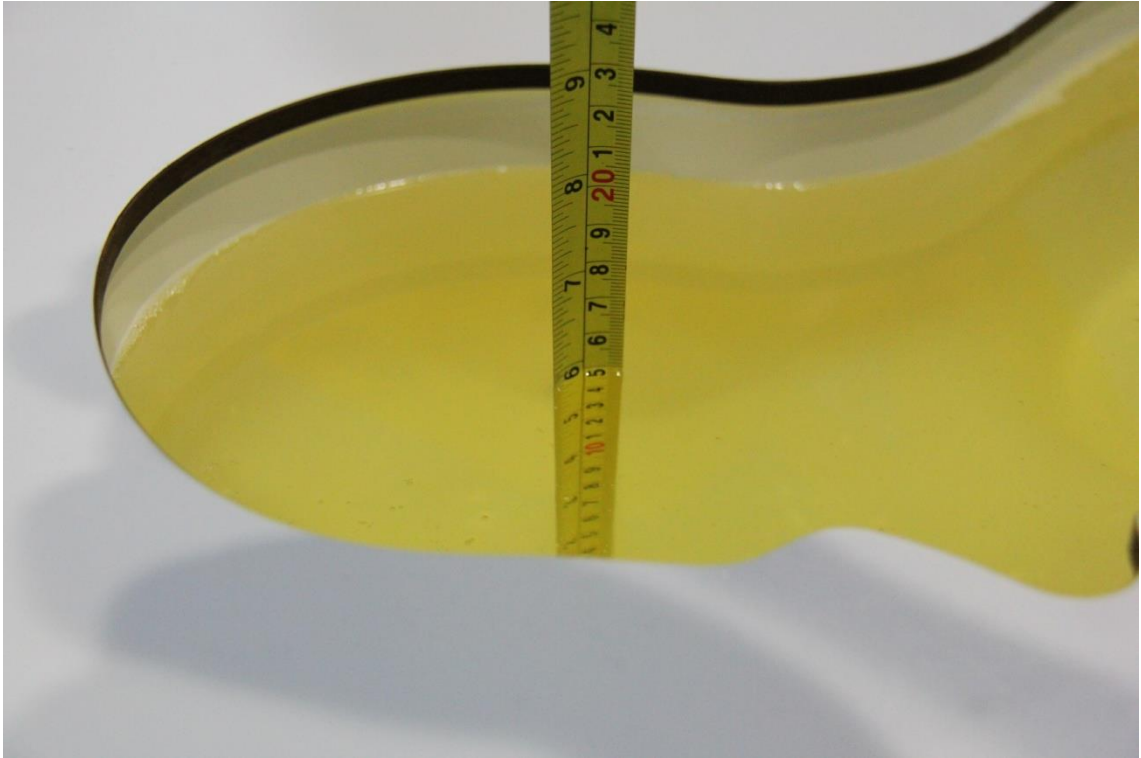

**Picture 7-1: Liquid depth in the Head Phantom(2450MHz)**



**Picture 7-2: Liquid depth in the Flat Phantom(2450MHz)**



**Picture 7-3: Liquid depth in the Head Phantom (5GHz)**



**Picture 7-4: Liquid depth in the Flat Phantom (5GHz)**

## 8 System verification

### 8.1 System Setup

In the simplified setup for system evaluation, the DUT is replaced by a calibrated dipole and the power source is replaced by a continuous wave that comes from a signal generator. The calibrated dipole must be placed beneath the flat phantom section of the SAM twin phantom with the correct distance holder. The distance holder should touch the phantom surface with a light pressure at the reference marking and be oriented parallel to the long side of the phantom. The equipment setup is shown below:

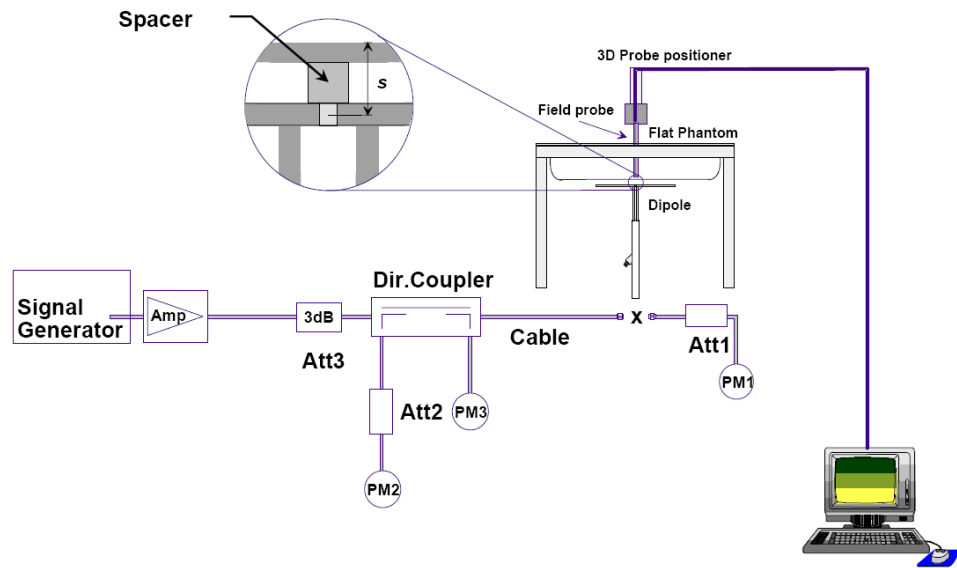

Picture 8.1 System Setup for System Evaluation

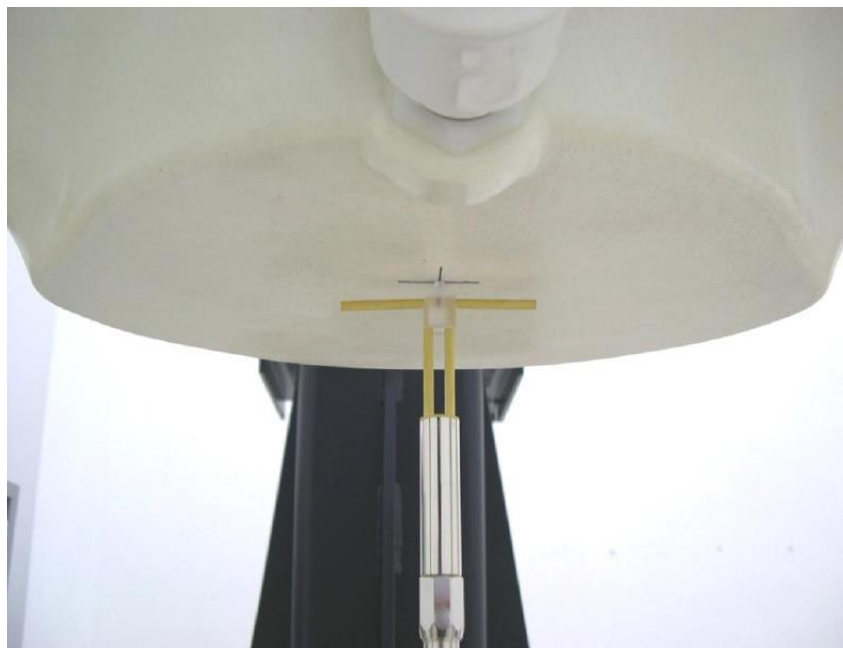

Picture 8.2 Photo of Dipole Setup

## 8.2 System Verification

SAR system verification is required to confirm measurement accuracy, according to the tissue dielectric media, probe calibration points and other system operating parameters required for measuring the SAR of a test device. The system verification must be performed for each frequency band and within the valid range of each probe calibration point required for testing the device.

The system verification results are required that the area scan estimated 1-g SAR is within 3% of the zoom scan 1-g SAR. The details are presented in annex B.

**Table 8.1: System Verification of Head**

Measurement Date (yyyy-mm-dd)	Frequency	Target value (W/kg)		Measured value (W/kg)		Deviation (%)	
		10 g Average	1 g Average	10 g Average	1 g Average	10 g Average	1 g Average
2018-7-27	2450 MHz	24.1	52.5	24.56	54.00	1.91	2.86
2018-7-27	5300 MHz	23.7	83.0	24.40	86.40	2.95	4.10
2018-7-27	5600 MHz	23.6	82.9	23.90	85.70	1.27	3.38
2018-7-27	5800 MHz	22.3	78.8	21.90	76.20	-1.79	-3.30

**Table 8.2: System Verification of Body**

Measurement Date (yyyy-mm-dd)	Frequency	Target value (W/kg)		Measured value (W/kg)		Deviation (%)	
		10 g Average	1 g Average	10 g Average	1 g Average	10 g Average	1 g Average
2018-7-27	2450 MHz	24.4	52.3	23.88	50.00	-2.13	-4.40
2018-7-27	5300 MHz	21.5	76.5	21.10	73.80	-1.86	-3.53
2018-7-27	5600 MHz	22.1	79.1	22.60	81.60	2.26	3.16
2018-7-27	5800 MHz	21.1	76.2	21.30	77.80	0.95	2.10

## 9 Measurement Procedures

### 9.1 Tests to be performed

In order to determine the highest value of the peak spatial-average SAR of a handset, all device positions, configurations and operational modes shall be tested for each frequency band according to steps 1 to 3 below. A flowchart of the test process is shown in picture 9.1.

**Step 1:** The tests described in 9.2 shall be performed at the channel that is closest to the center of the transmit frequency band ( $f_c$ ) for:

- a) all device positions (cheek and tilt, for both left and right sides of the SAM phantom, as described in annex D),
- b) all configurations for each device position in a), e.g., antenna extended and retracted, and
- c) all operational modes, e.g., analogue and digital, for each device position in a) and configuration in b) in each frequency band.

If more than three frequencies need to be tested according to 11.1 (i.e.,  $N_c > 3$ ), then all frequencies, configurations and modes shall be tested for all of the above test conditions.

**Step 2:** For the condition providing highest peak spatial-average SAR determined in Step 1, perform all tests described in 9.2 at all other test frequencies, i.e., lowest and highest frequencies. In addition, for all other conditions (device position, configuration and operational mode) where the peak spatial-average SAR value determined in Step 1 is within 3 dB of the applicable SAR limit, it is recommended that all other test frequencies shall be tested as well.

**Step 3:** Examine all data to determine the highest value of the peak spatial-average SAR found in Steps 1 to 2.



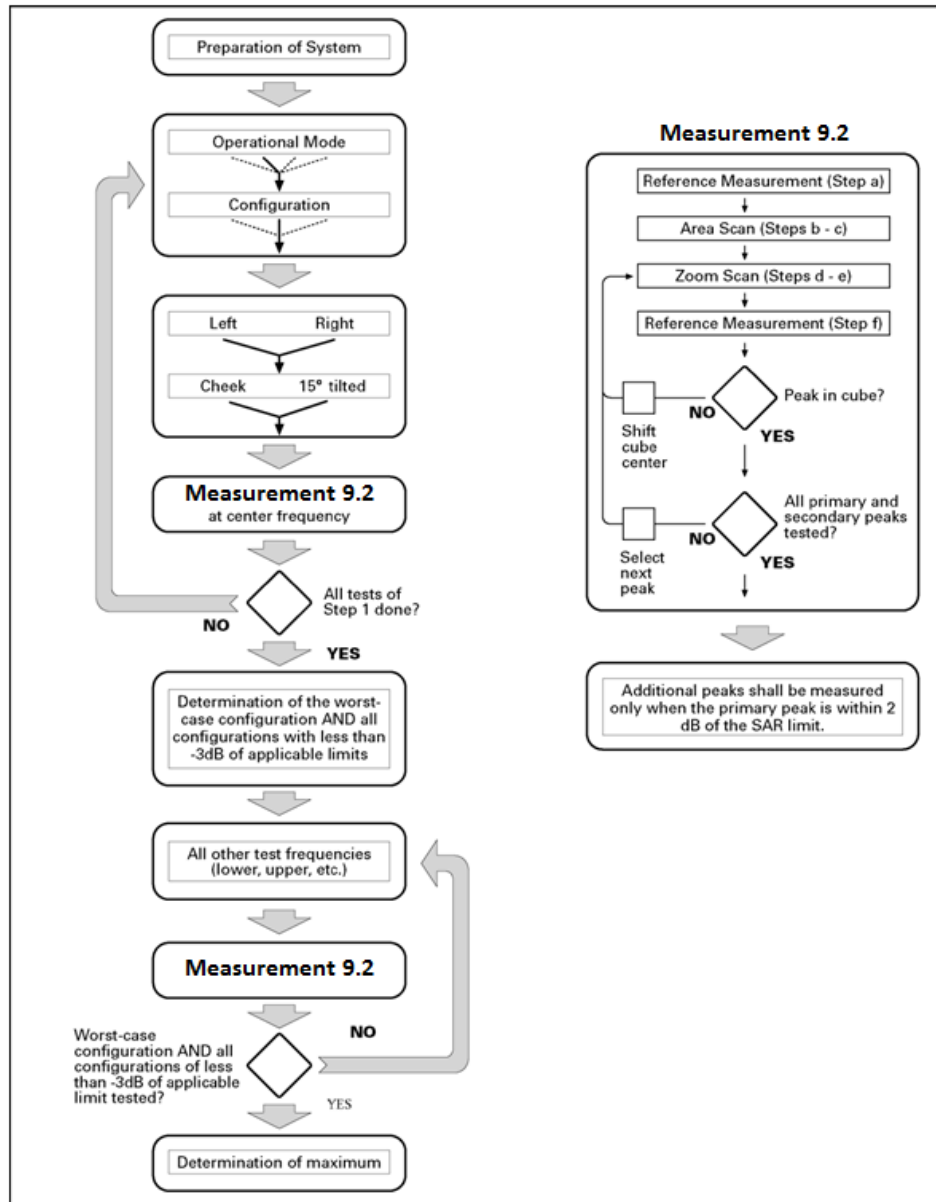

Picture 9.1 Block diagram of the tests to be performed

## 9.2 General Measurement Procedure

The area and zoom scan resolutions specified in the table below must be applied to the SAR measurements and fully documented in SAR reports to qualify for TCB approval. Probe boundary effect error compensation is required for measurements with the probe tip closer than half a probe tip diameter to the phantom surface. Both the probe tip diameter and sensor offset distance must satisfy measurement protocols; to ensure probe boundary effect errors are minimized and the higher fields closest to the phantom surface can be correctly measured and extrapolated to the phantom surface for computing 1-g SAR. Tolerances of the post-processing algorithms must be verified by the test laboratory for the scan resolutions used in the SAR measurements, according to the reference distribution functions specified in IEEE Std 1528-2013. The results should be documented as part of the system validation records and may be requested to support test results when all the measurement parameters in the following table are not satisfied.

		$\leq 3$ GHz	$> 3$ GHz	
Maximum distance from closest measurement point (geometric center of probe sensors) to phantom surface		$5 \pm 1$ mm	$\frac{1}{2} \cdot \delta \cdot \ln(2) \pm 0.5$ mm	
Maximum probe angle from probe axis to phantom surface normal at the measurement location		$30^\circ \pm 1^\circ$	$20^\circ \pm 1^\circ$	
Maximum area scan spatial resolution: $\Delta x_{Area}, \Delta y_{Area}$		$\leq 2$ GHz: $\leq 15$ mm 2 – 3 GHz: $\leq 12$ mm	3 – 4 GHz: $\leq 12$ mm 4 – 6 GHz: $\leq 10$ mm	
		When the x or y dimension of the test device, in the measurement plane orientation, is smaller than the above, the measurement resolution must be $\leq$ the corresponding x or y dimension of the test device with at least one measurement point on the test device.		
Maximum zoom scan spatial resolution: $\Delta x_{Zoom}, \Delta y_{Zoom}$		$\leq 2$ GHz: $\leq 8$ mm 2 – 3 GHz: $\leq 5$ mm*	3 – 4 GHz: $\leq 5$ mm* 4 – 6 GHz: $\leq 4$ mm*	
Maximum zoom scan spatial resolution, normal to phantom surface	uniform grid: $\Delta z_{Zoom}(n)$	$\leq 5$ mm	3 – 4 GHz: $\leq 4$ mm 4 – 5 GHz: $\leq 3$ mm 5 – 6 GHz: $\leq 2$ mm	
	graded grid	$\Delta z_{Zoom}(1)$ : between 1 <sup>st</sup> two points closest to phantom surface	$\leq 4$ mm	3 – 4 GHz: $\leq 3$ mm 4 – 5 GHz: $\leq 2.5$ mm 5 – 6 GHz: $\leq 2$ mm
		$\Delta z_{Zoom}(n>1)$ : between subsequent points	$\leq 1.5 \cdot \Delta z_{Zoom}(n-1)$	
Minimum zoom scan volume	x, y, z	$\geq 30$ mm	3 – 4 GHz: $\geq 28$ mm 4 – 5 GHz: $\geq 25$ mm 5 – 6 GHz: $\geq 22$ mm	
<p>Note: <math>\delta</math> is the penetration depth of a plane-wave at normal incidence to the tissue medium; see draft standard IEEE P1528-2011 for details.</p> <p>* When zoom scan is required and the <i>reported</i> SAR from the area scan based 1-g SAR estimation procedures of KDB 447498 is <math>\leq 1.4</math> W/kg, <math>\leq 8</math> mm, <math>\leq 7</math> mm and <math>\leq 5</math> mm zoom scan resolution may be applied, respectively, for 2 GHz to 3 GHz, 3 GHz to 4 GHz and 4 GHz to 6 GHz.</p>				

### **9.3 Bluetooth & WI-FI Measurement Procedures for SAR**

Normal network operating configurations are not suitable for measuring the SAR of 802.11 transmitters in general. Unpredictable fluctuations in network traffic and antenna diversity conditions can introduce undesirable variations in SAR results. The SAR for these devices should be measured using chipset based test mode software to ensure that the results are consistent and reliable.

Chipset based test mode software is hardware dependent and generally varies among manufacturers. The device operating parameters established in a test mode for SAR measurements must be identical to those programmed in production units, including output power levels, amplifier gain settings and other RF performance tuning parameters. The test frequencies should correspond to actual channel frequencies defined for domestic use. SAR for devices with switched diversity should be measured with only one antenna transmitting at a time during each SAR measurement, according to a fixed modulation and data rate. The same data pattern should be used for all measurements.

### **9.4 Power Drift**

To control the output power stability during the SAR test, DASY5 system calculates the power drift by measuring the E-field at the same location at the beginning and at the end of the measurement for each test position. These drift values can be found in Section 14 labeled as: (Power Drift [dB]). This ensures that the power drift during one measurement is within 5%.

## 10 Conducted Output Power

**Table 10.1: The conducted Power measurement results for BT**

BT	Tune up	Averaged Power (dBm)		
Mode		Ch.0 (2402 MHz)	Ch39 (2441 MHz)	Ch78 (2480 MHz)
GFSK	<b>9.5</b>	9.22	9.08	8.92
EDR2M-4_DQPSK	<b>9.5</b>	8.69	8.52	8.57
EDR3M-8DPSK	<b>9.5</b>	9.02	8.89	8.76
BLE	<b>Tune up</b>	Ch0 (2402MHz)	Ch19 (2440MHz)	Ch39 (2480MHz)
	<b>0.5</b>	0.14	-1.07	-0.90

**Table 10.2: The conducted Power measurement results for 2.4G WIFI**

### <Main antenna>

WiFi 2.4GHz	Tune up	Averaged Power (dBm)		
Mode		Ch.1(2412 MHz)	Ch.6(2437Mhz)	Ch.11(2462MHz)
802.11b	<b>19</b>	18.35	<b>18.39</b>	18.37
802.11g	<b>16</b>	15.13	14.97	15.02
802.11n(20MHz)	<b>15</b>	14.26	14.05	14.07
/	<b>/</b>	Ch.3(2422 MHz)	Ch.6(2437Mhz)	Ch.9(2452MHz)
802.11n(40MHz)	<b>15</b>	14.17	14.13	14.08

### <Second antenna>

WiFi 2.4GHz	Tune up	Averaged Power (dBm)		
Mode		Ch.1(2412 MHz)	Ch.6(2437Mhz)	Ch.11(2462MHz)
802.11b	<b>19</b>	17.56	18.06	<b>18.56</b>
802.11g	<b>16</b>	14.70	14.64	14.90
802.11n(20MHz)	<b>15</b>	13.57	13.68	13.84
/	<b>/</b>	Ch.3(2422 MHz)	Ch.6(2437Mhz)	Ch.9(2452MHz)
802.11n(40MHz)	<b>15</b>	13.97	13.86	13.41

### <MIMO>

WiFi 2.4GHz	Tune up	Averaged Power (dBm)		
Mode		Ch.1(2412 MHz)	Ch.6(2437Mhz)	Ch.11(2462MHz)
802.11n(20MHz)	<b>18</b>	<b>17.21</b>	16.77	16.90
/	<b>/</b>	Ch.3(2422 MHz)	Ch.6(2437Mhz)	Ch.9(2452MHz)
802.11n(40MHz)	<b>18</b>	16.96	16.79	16.80

**Table 10.3: The conducted Power for 5G WIFI**

**<Main antenna>**

Averaged Power (dBm)								
Mode	802.11a	802.11n -20MHz	802.11ac -20MHz	Mode	802.11n -40MHz	802.11ac -40MHz	Mode	802.11ac -80MHz
Channel	6Mbps	MCS0	MCS0	Channel	MCS0	MCS0	Channel	MCS0
<b>&lt;U-NII-1&gt;</b>								
<b>Tune up</b>	<b>16</b>	<b>15.5</b>	<b>15</b>	/	<b>15.5</b>	<b>15</b>	/	<b>15</b>
36(5180MHz)	14.37	14.23	14.15	38(5190MHz)	14.21	13.53	42(5210MHz)	13.75
40(5200MHz)	<b>14.57</b>	14.46	14.37	46(5230MHz)	14.32	13.63	/	/
48(5240MHz)	14.43	14.35	14.23	/	/	/	/	/
<b>&lt;U-NII-2A&gt;</b>								
<b>Tune up</b>	<b>16</b>	<b>15.5</b>	<b>15</b>	/	<b>15.5</b>	<b>15</b>	/	<b>15</b>
52(5260MHz)	<b>14.75</b>	14.41	14.42	54(5270MHz)	13.81	13.83	58(5290MHz)	13.75
56(5280MHz)	14.42	14.36	14.37	62(5310MHz)	13.74	13.74	/	/
64(5320MHz)	14.53	14.23	14.20	/	/	/	/	/
<b>&lt;U-NII-2C&gt;</b>								
<b>Tune up</b>	<b>16</b>	<b>15.5</b>	<b>15</b>	/	<b>15.5</b>	<b>15</b>	/	<b>15</b>
100(5500MHz)	14.31	14.25	14.11	102(5510MHz)	13.67	13.44	106(5530MHz)	13.35
120(5600MHz)	14.12	14.31	14.31	118(5590MHz)	13.78	13.48	122(5610MHz)	13.47
140(5700MHz)	<b>14.53</b>	14.46	14.14	134(5670MHz)	13.84	13.41	/	/
<b>&lt;U-NII-3&gt;</b>								
<b>Tune up</b>	<b>16</b>	<b>15.5</b>	<b>15</b>	/	<b>15.5</b>	<b>15</b>	/	<b>15</b>
149(5745MHz)	14.11	/	/	151(5755 MHz)	13.65	13.49	155(5775MHz)	13.31
157(5785MHz)	14.15	13.74	14.23	159(5795 MHz)	13.73	13.40	/	/
165(5825MHz)	<b>14.34</b>	13.76	14.18	/	/	/	/	/

Channel	Mode	
	802.11n-20MHz	802.11ac-20MHz
<b>Tune up</b>	<b>13.5</b>	<b>13.5</b>
149(5745MHz)	12.13	12.25

< Second antenna >

Averaged Power (dBm)								
Mode	802.11a	802.11n -20MHz	802.11ac -20MHz	Mode	802.11n -40MHz	802.11ac -40MHz	Mode	802.11ac -80MHz
Channel	6Mbps	MCS0	MCS0	Channel	MCS0	MCS0	Channel	MCS0
<b>&lt;U-NII-1&gt;</b>								
<b>Tune up</b>	<b>16.5</b>	<b>16</b>	<b>15.5</b>	/	<b>16</b>	<b>15.5</b>	/	<b>15.5</b>
36(5180MHz)	15.32	14.93	15.37	38(5190MHz)	14.35	14.83	42(5210MHz)	14.66
40(5200MHz)	15.15	14.78	15.30	46(5230MHz)	14.27	14.67	/	/
48(5240MHz)	14.83	14.65	15.42	/	/	/	/	/
<b>&lt;U-NII-2A&gt;</b>								
<b>Tune up</b>	<b>16.5</b>	<b>16</b>	<b>15.5</b>	/	<b>16</b>	<b>15.5</b>	/	<b>15.5</b>
52(5260MHz)	<b>15.15</b>	14.56	14.65	54(5270MHz)	14.13	14.19	58(5290MHz)	13.73
56(5280MHz)	15.13	14.35	14.74	62(5310MHz)	14.21	13.71	/	/
64(5320MHz)	14.78	14.78	14.05	/	/	/	/	/
<b>&lt;U-NII-2C&gt;</b>								
<b>Tune up</b>	<b>16</b>	<b>15.5</b>	<b>15</b>	/	<b>15.5</b>	<b>15</b>	/	<b>15</b>
100(5500MHz)	<b>14.75</b>	14.21	14.36	102(5510MHz)	13.88	13.92	106(5530MHz)	13.98
120(5600MHz)	14.23	14.15	14.39	118(5590MHz)	14.23	13.96	122(5610MHz)	13.41
140(5700MHz)	14.34	13.86	13.75	134(5670MHz)	13.78	13.01	/	/
<b>&lt;U-NII-3&gt;</b>								
<b>Tune up</b>	<b>16</b>	<b>15.5</b>	<b>15</b>	/	<b>15.5</b>	<b>15</b>	/	<b>15</b>
149(5745MHz)	14.23	/	/	151(5755 MHz)	13.65	13.51	155(5775MHz)	13.38
157(5785MHz)	<b>14.45</b>	13.68	13.95	159(5795 MHz)	13.57	13.63	/	/
165(5825MHz)	14.12	13.58	14.13	/	/	/	/	/

Channel	Mode	
	802.11n-20MHz	802.11ac-20MHz
<b>Tune up</b>	<b>13.5</b>	<b>13.5</b>
149(5745MHz)	11.97	12.21

<MIMO>

Averaged Power (dBm)							
Mode	802.11n -20MHz	802.11ac -20MHz	Mode	802.11n -40MHz	802.11ac -40MHz	Mode	802.11ac -80MHz
Channel	MCS0	MCS0	Channel	MCS0	MCS0	Channel	MCS0
<b>&lt;U-NII-1&gt;</b>							
<b>Tune up</b>	<b>19.5</b>	<b>19</b>	/	<b>19.5</b>	<b>19</b>	/	<b>19</b>
36(5180MHz)	18.12	18.10	38(5190MHz)	17.89	17.34	42(5210MHz)	17.37
40(5200MHz)	18.12	18.22	46(5230MHz)	17.64	17.41	/	/
48(5240MHz)	17.74	17.55	/	/	/	/	/
<b>&lt;U-NII-2A&gt;</b>							
<b>Tune up</b>	<b>19.5</b>	<b>19</b>	/	<b>19.5</b>	<b>19</b>	/	<b>19</b>
52(5260MHz)	<b>18.19</b>	18.09	54(5270MHz)	17.89	17.34	58(5290MHz)	17.34
56(5280MHz)	17.82	17.69	62(5310MHz)	17.66	17.36	/	/
64(5320MHz)	17.79	17.55	/	/	/	/	/
<b>&lt;U-NII-2C&gt;</b>							
<b>Tune up</b>	<b>19</b>	<b>18</b>	/	<b>19</b>	<b>18</b>	/	<b>18</b>
100(5500MHz)	<b>18.05</b>	17.79	102(5510MHz)	17.58	16.99	106(5530MHz)	16.99
120(5600MHz)	17.88	17.50	118(5590MHz)	17.48	16.81	122(5610MHz)	16.81
140(5700MHz)	17.37	17.23	134(5670MHz)	17.05	16.30	/	/
<b>&lt;U-NII-3&gt;</b>							
<b>Tune up</b>	<b>18.3</b>	<b>18.5</b>	/	<b>18.5</b>	<b>18.5</b>	/	<b>18.5</b>
149(5745MHz)	/	/	151(5755 MHz)	17.06	17.30	155(5775MHz)	16.82
157(5785MHz)	<b>17.78</b>	17.69	159(5795 MHz)	17.19	17.19	/	/
165(5825MHz)	17.46	17.59	/	/	/	/	/

Channel	Mode	
	802.11n-20MHz	802.11ac-20MHz
<b>Tune up</b>	<b>16.5</b>	<b>16.5</b>
149(5745MHz)	15.96	15.90

## 11 Simultaneous TX SAR Considerations

### 11.1 Introduction

The following procedures adopted from “FCC SAR Considerations for Cell Phones with Multiple Transmitters” are applicable to handsets with built-in unlicensed transmitters such as 802.11 a/b/g and Bluetooth devices which may simultaneously transmit with the licensed transmitter. For this device, the BT and Wi-Fi can transmit simultaneous with other transmitters.

### 11.2 Transmit Antenna Separation Distances

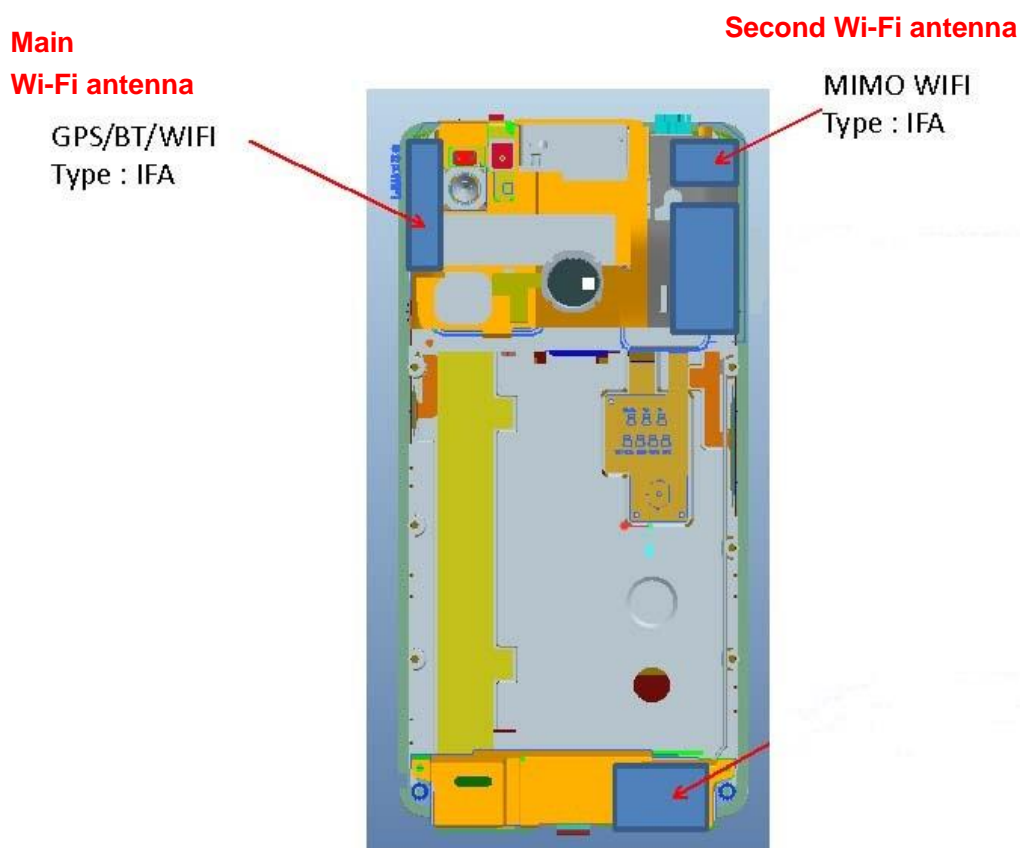

Picture 12.1 Antenna Locations (Back View)



### 11.3 SAR Measurement Positions

According to the KDB941225 D06 Hot Spot SAR, the edges with less than 2.5 cm distance to the antennas need to be tested for SAR.

SAR measurement positions						
Mode	Front	Rear	Left edge	Right edge	Top edge	Bottom edge
Main WIFI antenna	Yes	Yes	No	Yes	Yes	No
Second WIFI antenna	Yes	Yes	Yes	No	Yes	No

### 11.4 Standalone SAR Test Exclusion Considerations

Standalone 1-g head or body SAR evaluation by measurement or numerical simulation is not required when the corresponding SAR Exclusion Threshold condition, listed below, is satisfied. The 1-g SAR test exclusion threshold for 100 MHz to 6 GHz at test separation distances  $\leq 50$  mm are determined by:

$[(\text{max. power of channel, including tune-up tolerance, mW}) / (\text{min. test separation distance, mm})] \cdot [\sqrt{f(\text{GHz})}] \leq 3.0$  for 1-g SAR, where

- $f(\text{GHz})$  is the RF channel transmit frequency in GHz
- Power and distance are rounded to the nearest mW and mm before calculation
- The result is rounded to one decimal place for comparison

**Table 11.1: Standalone SAR test exclusion considerations**

Band/Mode	f(GHz)	Position	SAR test exclusion threshold (mW)	RF output power		SAR test exclusion
				dBm	mW	
Bluetooth	2.441	Head	9.60	9.5	8.91	Yes
		Body	19.20	9.5	8.91	Yes
2.4GHz WLAN	2.45	Head	9.58	19	79.43	No
		Body	19.17	19	79.43	No
5GHz WLAN	5.2	Head	6.58	19.5	89.13	No
		Body	13.16	19.5	89.13	No
	5.3	Head	6.52	19.5	89.13	No
		Body	13.03	19.5	89.13	No
	5.6	Head	6.34	19	79.43	No
		Body	12.68	19	79.43	No
	5.8	Head	6.23	18.3	67.61	No
		Body	12.46	18.3	67.61	No

## 12 Evaluation of Simultaneous

**Table 12.1: Estimated SAR for Bluetooth**

Position	f (GHz)	Distance (mm)	Upper limit of power *		Estimated <sub>1g</sub> (W/kg)
			dBm	mW	
Head	2.441	5	9.5	8.91	0.37
Body	2.441	10	9.5	8.91	0.21

\* - Maximum possible output power declared by manufacturer

When standalone SAR test exclusion applies to an antenna that transmits simultaneously with other antennas, the standalone SAR must be estimated according to following to determine simultaneous transmission SAR test exclusion:

(max. power of channel, including tune-up tolerance, mW) / (min. test separation distance, mm) · [ $\sqrt{f(\text{GHz})}/x$ ] W/kg for test separation distances  $\leq 50$  mm;

Where  $x = 7.5$  for 1-g SAR.

When the minimum test separation distance is  $< 5$  mm, a distance of 5 mm is applied to determine SAR test exclusion

### **Conclusion:**

Because WLAN and Bluetooth share the same antenna, so they are can not simultaneous transmission.

### 13 SAR Test Result

The calculated SAR is obtained by the following formula:

$$\text{Reported SAR} = \text{Measured SAR} \times 10^{(P_{\text{Target}} - P_{\text{Measured}})/10}$$

Where  $P_{\text{Target}}$  is the power of manufacturing upper limit;

$P_{\text{Measured}}$  is the measured power in chapter 10.

### 13.1 WLAN Evaluation for 2.4G

According to the KDB248227 D01, SAR is measured for 2.4GHz 802.11b DSSS using the initial test position procedure.

**Table 13.1: SAR Values (WLAN 2.4G - Head)**

Frequency		Test Mode	Test Position	Figure No.	Conducted Power (dBm)	Max. tune-up Power (dBm)	Measured SAR(1g) (W/kg)	Reported SAR(1g) (W/kg)	Power Drift(dB)
MHz	Ch.								
Ambient Temperature: 22.6°C      Liquid Temperature: 22.0°C									
<b>&lt;Main antenna&gt;</b>									
2437	6	802.11 b	Left Touch	<b>Fig.1</b>	18.39	19	<b>0.433</b>	<b>0.50</b>	-0.03
2437	6	802.11 b	Left Tilt	/	18.39	19	0.411	0.47	0.08
2437	6	802.11 b	Right Touch	/	18.39	19	0.255	0.29	-0.02
2437	6	802.11 b	Right Tilt	/	18.39	19	0.238	0.27	0.07
<b>&lt;Second antenna&gt;</b>									
2462	11	802.11 b	Left Touch	/	18.56	19	0.281	0.31	0.08
2462	11	802.11 b	Left Tilt	/	18.56	19	0.314	0.35	0.08
2462	11	802.11 b	Right Touch	/	18.56	19	<b>0.386</b>	0.43	-0.08
2462	11	802.11 b	Right Tilt	/	18.56	19	0.329	0.36	0.08
<b>&lt;MIMO&gt;</b>									
2412	1	802.11 n	Left Touch	/	17.21	18	0.190	0.23	0.03
2412	1	802.11 n	Left Tilt	/	17.21	18	<b>0.246</b>	0.30	0.08
2412	1	802.11 n	Right Touch	/	17.21	18	0.185	0.22	0.08
2412	1	802.11 n	Right Tilt	/	17.21	18	0.154	0.18	0.07

Note1:For all positions/configurations tested using the initial test position and subsequent test positions, when the reported SAR is > 0.8 W/kg, SAR is measured for these test positions/configurations on the subsequent next highest measured output power channel until the reported SAR is ≤ 1.2 W/kg or all required channels are tested.

According to the KDB248227 D01, The reported SAR must be scaled to 100% transmission duty factor to determine compliance at the maximum tune-up tolerance limit. A maximum transmission duty factor of 100% is achievable for WLAN in this project and the scaled reported SAR is presented as below.

**Table 13.2: SAR Values (WLAN - Head) – 802.11b 1Mbps (Scaled Reported SAR)**

Frequency		Test Position	Actual duty factor	maximum duty factor	Reported SAR (1g)(W/kg)	Scaled reported SAR (1g)(W/kg)
MHz	Ch.					
2437	6	Left Touch	100%	100%	0.50	<b>0.50</b>

SAR is not required for OFDM because the 802.11b adjusted SAR ≤ 1.2 W/kg.

**Table 13.3: SAR Values (WLAN 2.4G - Body)**

Ambient Temperature: 22.6°C					Liquid Temperature: 22.0°C				
Frequency		Test Mode	Test Position	Figure No.	Conducted Power (dBm)	Max. tune-up Power (dBm)	Measured SAR(1g) (W/kg)	Reported SAR(1g) (W/kg)	Power Drift(dB)
MHz	Ch.								
<b>&lt;Main antenna&gt;</b>									
2437	6	802.11 b	Front	/	18.39	19	0.130	0.15	0.04
2437	6	802.11 b	Rear	<b>Fig.2</b>	18.39	19	<b>0.235</b>	<b>0.27</b>	0.01
2437	6	802.11 b	Right	/	18.39	19	0.073	0.08	0.07
2437	6	802.11 b	Top	/	18.39	19	0.105	0.12	0.05
<b>&lt;Second antenna&gt;</b>									
2462	11	802.11 b	Front	/	18.56	19	0.103	0.11	0.04
2462	11	802.11 b	Rear	/	18.56	19	<b>0.171</b>	0.19	0.01
2462	11	802.11 b	Left	/	18.56	19	0.065	0.07	-0.06
2462	11	802.11 b	Top	/	18.56	19	0.105	0.12	0.05
<b>&lt;MIMO&gt;</b>									
2412	1	802.11 n	Front	/	17.21	18	0.035	0.04	0.09
2412	1	802.11 n	Rear	/	17.21	18	<b>0.120</b>	0.14	0.01
2412	1	802.11 n	Left	/	17.21	18	0.012	0.01	-0.05
2412	1	802.11 n	Right	/	17.21	18	0.029	0.03	-0.10
2412	1	802.11 n	Top	/	17.21	18	0.088	0.11	0.02

Note1: For all positions/configurations tested using the initial test position and subsequent test positions, when the reported SAR is > 0.8 W/kg, SAR is measured for these test positions/configurations on the subsequent next highest measured output power channel until the reported SAR is ≤ 1.2 W/kg or all required channels are tested.

According to the KDB248227 D01, The reported SAR must be scaled to 100% transmission duty factor to determine compliance at the maximum tune-up tolerance limit. A maximum transmission duty factor of 100% is achievable for WLAN in this project and the scaled reported SAR is presented as below.

**Table 13.4: SAR Values (WLAN - Body) – 802.11b 1Mbps (Scaled Reported SAR)**

Ambient Temperature: 22.6°C					Liquid Temperature: 22.0°C	
Frequency		Test Position	Actual duty factor	maximum duty factor	Reported SAR (1g)(W/kg)	Scaled reported SAR (1g)(W/kg)
MHz	Ch.					
2437	6	Rear	100%	100%	0.27	<b>0.27</b>

SAR is not required for OFDM because the 802.11b adjusted SAR ≤ 1.2 W/kg.

### 13.2 WLAN Evaluation for 5G

**Table 13.5: SAR Values (WLAN 5G - Head)**

<Main antenna>

Frequency		Test Mode	Test Position	Figure No.	Ambient Temperature: 22.5°C		Liquid Temperature: 22.0°C		
MHz	Ch.				Conducted Power (dBm)	Max. tune-up Power (dBm)	Measured SAR(1g) (W/kg)	Reported SAR(1g) (W/kg)	Power Drift(dB)
<b>U-NII-2A</b>									
5260	52	802.11 a	Left Touch	/	14.75	16	<b>0.165</b>	0.22	0.03
5260	52	802.11 a	Left Tilt	/	14.75	16	0.140	0.19	0.09
5260	52	802.11 a	Right Touch	/	14.75	16	0.162	0.22	0.04
5260	52	802.11 a	Right Tilt	/	14.75	16	0.158	0.21	0.06
<b>U-NII-2C</b>									
5700	140	802.11 a	Left Touch	/	14.53	16	0.124	0.17	0.03
5700	140	802.11 a	Left Tilt	/	14.53	16	0.217	0.30	0.07
5700	140	802.11 a	Right Touch	/	14.53	16	0.110	0.15	0.09
5700	140	802.11 a	Right Tilt	/	14.53	16	0.115	0.16	0.05
<b>U-NII-3</b>									
5825	165	802.11 a	Left Touch	/	14.34	16	<b>0.087</b>	0.13	0.00
5825	165	802.11 a	Left Tilt	/	14.34	16	0.071	0.10	0.09
5825	165	802.11 a	Right Touch	/	14.34	16	0.068	0.10	0.07
5825	165	802.11 a	Right Tilt	/	14.34	16	0.072	0.11	0.03

Note1: U-NII-1 and U-NII-2A bands have the same specified maximum output and tolerance; SAR is measured for U-NII-2A band first. Adjusted SAR of U-NII-2A band is  $\leq 1.2$ W/kg, SAR is not required for U-NII-1 band.

Note2: For all positions/configurations tested using the initial test position and subsequent test positions, when the reported SAR is  $> 0.8$  W/kg, SAR is measured for these test positions/configurations on the subsequent next highest measured output power channel until the reported SAR is  $\leq 1.2$  W/kg or all required channels are tested.

<Second antenna>

Frequency		Test Mode	Test Position	Figure No.	Conducted Power (dBm)	Max. tune-up Power (dBm)	Measured SAR(1g) (W/kg)	Reported SAR(1g) (W/kg)	Power Drift(dB)
MHz	Ch.								
Ambient Temperature: 22.5°C      Liquid Temperature: 22.0°C									
<b>U-NII-2A</b>									
5260	52	802.11 a	Left Touch	/	15.15	16.5	0.109	0.15	0.08
5260	52	802.11 a	Left Tilt	/	15.15	16.5	0.140	0.19	0.04
5260	52	802.11 a	Right Touch	/	15.15	16.5	<b>0.374</b>	0.51	0.09
5260	52	802.11 a	Right Tilt	/	15.15	16.5	0.101	0.14	0.01
<b>U-NII-2C</b>									
5500	100	802.11 a	Left Touch	/	14.75	16	0.340	0.45	0.02
5500	100	802.11 a	Left Tilt	/	14.75	16	0.385	0.51	0.06
5500	100	802.11 a	Right Touch	/	14.75	16	0.355	0.47	0.03
5500	100	802.11 a	Right Tilt	<b>Fig.3</b>	14.75	16	<b>0.548</b>	<b>0.73</b>	-0.11
<b>U-NII-3</b>									
5785	157	802.11 a	Left Touch	/	14.45	16	0.214	0.306	0.07
5785	157	802.11 a	Left Tilt	/	14.45	16	0.258	0.369	0.09
5785	157	802.11 a	Right Touch	/	14.45	16	0.327	0.467	0.09
5785	157	802.11 a	Right Tilt	/	14.45	16	<b>0.345</b>	0.493	0.02
5745	149	802.11 a	Right Touch	/	14.23	16	0.296	0.445	0.02
5745	149	802.11 a	Right Tilt	/	14.23	16	0.334	0.502	0.09

Note1: U-NII-1 and U-NII-2A bands have the same specified maximum output and tolerance; SAR is measured for U-NII-2A band first. Adjusted SAR of U-NII-2A band is  $\leq 1.2$ W/kg, SAR is not required for U-NII-1 band.

Note2: For all positions/configurations tested using the initial test position and subsequent test positions, when the reported SAR is  $> 0.8$  W/kg, SAR is measured for these test positions/configurations on the subsequent next highest measured output power channel until the reported SAR is  $\leq 1.2$  W/kg or all required channels are tested.

<MIMO>

Frequency		Test Mode	Test Position	Figure No.	Conducted Power (dBm)	Max. tune-up Power (dBm)	Measured SAR(1g) (W/kg)	Reported SAR(1g) (W/kg)	Power Drift(dB)
MHz	Ch.								
Ambient Temperature: 22.5°C      Liquid Temperature: 22.0°C									
<b>U-NII-2A</b>									
5260	52	802.11 n	Left Touch	/	18.19	19.5	0.218	0.29	0.01
5260	52	802.11 n	Left Tilt	/	18.19	19.5	0.228	0.31	0.01
5260	52	802.11 n	Right Touch	/	18.19	19.5	0.266	0.36	0.04
5260	52	802.11 n	Right Tilt	/	18.19	19.5	0.178	0.24	0.09
<b>U-NII-2C</b>									
5500	100	802.11 n	Left Touch	/	18.05	19	0.372	0.46	0.08
5500	100	802.11 n	Left Tilt	/	18.05	19	0.474	0.59	0.05
5500	100	802.11 n	Right Touch	/	18.05	19	<b>0.498</b>	0.62	0.01
5500	100	802.11 n	Right Tilt	/	18.05	19	0.244	0.30	0.05
<b>U-NII-3</b>									
5785	157	802.11 n	Left Touch	/	17.78	18.3	0.196	0.221	0.08
5785	157	802.11 n	Left Tilt	/	17.78	18.3	0.221	0.249	0.04
5785	157	802.11 n	Right Touch	/	17.78	18.3	0.243	0.274	0.02
5785	157	802.11 n	Right Tilt	/	17.78	18.3	0.257	0.290	0.06
5825	165	802.11 n	Right Tilt	/	17.46	18.3	<b>0.331</b>	0.402	0.04

Note1: U-NII-1 and U-NII-2A bands have the same specified maximum output and tolerance; SAR is measured for U-NII-2A band first. Adjusted SAR of U-NII-2A band is  $\leq 1.2$ W/kg, SAR is not required for U-NII-1 band.

Note2: For all positions/configurations tested using the initial test position and subsequent test positions, when the reported SAR is  $> 0.8$  W/kg, SAR is measured for these test positions/configurations on the subsequent next highest measured output power channel until the reported SAR is  $\leq 1.2$  W/kg or all required channels are tested.

According to the KDB248227 D01, The reported SAR must be scaled to 100% transmission duty factor to determine compliance at the maximum tune-up tolerance limit. A maximum transmission duty factor of 100% is achievable for WLAN in this project and the scaled reported SAR is presented as below.

**Table 13.6: SAR Values (WLAN 5G - Head) – (Scaled Reported SAR)**

Frequency		Test Position	Actual duty factor	maximum duty factor	Reported SAR (1g)(W/kg)	Scaled reported SAR (1g)(W/kg)
MHz	Ch.					
5825	165	Right Tilt	100%	100%	0.73	<b>0.73</b>



**Table 13.7: SAR Values (WLAN 5G - Body)**

**<Main antenna>**

Frequency		Test Mode	Test Position	Figure No.	Conducted Power (dBm)	Max. tune-up Power (dBm)	Measured SAR(1g) (W/kg)	Reported SAR(1g) (W/kg)	Power Drift(dB)
MHz	Ch.								
Ambient Temperature: 22.5°C					Liquid Temperature: 22.0°C				
<b>U-NII-2A</b>									
5260	52	802.11 a	Front	/	14.75	16	0.066	0.09	0.09
5260	52	802.11 a	Rear	/	14.75	16	<b>0.154</b>	0.21	0.09
5260	52	802.11 a	Right	/	14.75	16	0.053	0.07	0.06
5260	52	802.11 a	Top	/	14.75	16	0.011	0.01	0.06
<b>U-NII-2C</b>									
5700	140	802.11 a	Front	/	14.53	16	0.027	0.04	-0.11
5700	140	802.11 a	Rear	/	14.53	16	<b>0.061</b>	0.09	-0.13
5700	140	802.11 a	Right	/	14.53	16	0.046	0.07	0.01
5700	140	802.11 a	Top	/	14.53	16	0.040	0.06	0.05
<b>U-NII-3</b>									
5825	165	802.11 a	Front	/	14.34	16	0.052	0.08	-0.12
5825	165	802.11 a	Rear	/	14.34	16	<b>0.074</b>	0.11	0.07
5825	165	802.11 a	Right	/	14.34	16	0.066	0.10	0.04
5825	165	802.11 a	Top	/	14.34	16	0.071	0.10	0.07

Note1: U-NII-1 and U-NII-2A bands have the same specified maximum output and tolerance; SAR is measured for U-NII-2A band first. Adjusted SAR of U-NII-2A band is  $\leq 1.2$ W/kg, SAR is not required for U-NII-1 band.

Note2: For all positions/configurations tested using the initial test position and subsequent test positions, when the reported SAR is  $> 0.8$  W/kg, SAR is measured for these test positions/configurations on the subsequent next highest measured output power channel until the reported SAR is  $\leq 1.2$  W/kg or all required channels are tested.

<Second antenna>

Frequency		Test Mode	Test Position	Figure No.	Conducted Power (dBm)	Max. tune-up Power (dBm)	Measured SAR(1g) (W/kg)	Reported SAR(1g) (W/kg)	Power Drift(dB)
MHz	Ch.								
Ambient Temperature: 22.5°C      Liquid Temperature: 22.0°C									
<b>U-NII-2A</b>									
5260	52	802.11 a	Front	/	15.15	16.5	0.058	0.08	0.09
5260	52	802.11 a	Rear	/	15.15	16.5	0.024	0.03	0.05
5260	52	802.11 a	Left	/	15.15	16.5	<b>0.241</b>	0.33	0.09
5260	52	802.11 a	Top	/	15.15	16.5	0.026	0.04	-0.08
<b>U-NII-2C</b>									
5500	100	802.11 a	Front	/	14.75	16	0.105	0.14	0.04
5500	100	802.11 a	Rear	/	14.75	16	0.081	0.11	0.08
5500	100	802.11 a	Left	/	14.75	16	0.152	0.20	-0.04
5500	100	802.11 a	Top	/	14.75	16	<b>0.251</b>	0.33	-0.04
<b>U-NII-3</b>									
5785	157	802.11 a	Front	/	14.45	16	0.010	0.01	0.02
5785	157	802.11 a	Rear	/	14.45	16	0.014	0.02	0.06
5785	157	802.11 a	Left	/	14.45	16	0.068	0.10	0.07
5785	157	802.11 a	Top	/	14.45	16	<b>0.120</b>	0.17	0.07

Note1: U-NII-1 and U-NII-2A bands have the same specified maximum output and tolerance; SAR is measured for U-NII-2A band first. Adjusted SAR of U-NII-2A band is  $\leq 1.2$ W/kg, SAR is not required for U-NII-1 band.

Note2: For all positions/configurations tested using the initial test position and subsequent test positions, when the reported SAR is  $> 0.8$  W/kg, SAR is measured for these test positions/configurations on the subsequent next highest measured output power channel until the reported SAR is  $\leq 1.2$  W/kg or all required channels are tested.

<MIMO>

Frequency		Ambient Temperature: 22.5°C				Liquid Temperature: 22.0°C			
MHz	Ch.	Test Mode	Test Position	Figure No.	Conducted Power (dBm)	Max. tune-up Power (dBm)	Measured SAR(1g) (W/kg)	Reported SAR(1g) (W/kg)	Power Drift(dB)
<b>U-NII-2A</b>									
5260	52	802.11 n	Front	/	18.19	19.5	0.026	0.04	0.09
5260	52	802.11 n	Rear	/	18.19	19.5	0.088	0.12	0.09
5260	52	802.11 n	Left	/	18.19	19.5	0.124	0.17	0.01
5260	52	802.11 n	Right	/	18.19	19.5	0.011	0.02	0.09
5260	52	802.11 n	Top	<b>Fig.4</b>	18.19	19.5	<b>0.265</b>	<b>0.36</b>	0.12
<b>U-NII-2C</b>									
5500	100	802.11 n	Front	/	18.05	19	0.042	0.05	0.09
5500	100	802.11 n	Rear	/	18.05	19	0.090	0.11	0.04
5500	100	802.11 n	Left	/	18.05	19	0.011	0.01	-0.06
5500	100	802.11 n	Right	/	18.05	19	0.040	0.05	0.01
5500	100	802.11 n	Top	/	18.05	19	<b>0.279</b>	0.35	0.08
<b>U-NII-3</b>									
5785	157	802.11 n	Front	/	17.78	18.3	0.053	0.06	-0.04
5785	157	802.11 n	Rear	/	17.78	18.3	<b>0.163</b>	0.18	0.04
5785	157	802.11 n	Left	/	17.78	18.3	0.011	0.01	0.07
5785	157	802.11 n	Right	/	17.78	18.3	0.040	0.04	0.01
5785	157	802.11 n	Top	/	17.78	18.3	0.132	0.15	-0.13

Note1: U-NII-1 and U-NII-2A bands have the same specified maximum output and tolerance; SAR is measured for U-NII-2A band first. Adjusted SAR of U-NII-2A band is  $\leq 1.2$ W/kg, SAR is not required for U-NII-1 band.

Note2: For all positions/configurations tested using the initial test position and subsequent test positions, when the reported SAR is  $> 0.8$  W/kg, SAR is measured for these test positions/configurations on the subsequent next highest measured output power channel until the reported SAR is  $\leq 1.2$  W/kg or all required channels are tested.

According to the KDB248227 D01, The reported SAR must be scaled to 100% transmission duty factor to determine compliance at the maximum tune-up tolerance limit. A maximum transmission duty factor of 100% is achievable for WLAN in this project and the scaled reported SAR is presented as below.

**Table 13.8: SAR Values (WLAN 5G - Body) – (Scaled Reported SAR)**

Frequency		Test Position	Actual duty factor	maximum duty factor	Reported SAR (1g)(W/kg)	Scaled reported SAR (1g)(W/kg)
MHz	Ch.					
		Ambient Temperature: 22.5°C		Liquid Temperature: 22.0°C		
5260	52	Top	100%	100%	0.36	<b>0.36</b>

## 14 SAR Measurement Variability

SAR measurement variability must be assessed for each frequency band, which is determined by the SAR probe calibration point and tissue-equivalent medium used for the device measurements. When both head and body tissue-equivalent media are required for SAR measurements in a frequency band, the variability measurement procedures should be applied to the tissue medium with the highest measured SAR, using the highest measured SAR configuration for that tissue-equivalent medium.

The following procedures are applied to determine if repeated measurements are required.

- 1) Repeated measurement is not required when the original highest measured SAR is  $< 0.80$  W/kg; steps 2) through 4) do not apply.
- 2) When the original highest measured SAR is  $\geq 0.80$  W/kg, repeat that measurement once.
- 3) Perform a second repeated measurement only if the ratio of largest to smallest SAR for the original and first repeated measurements is  $> 1.20$  or when the original or repeated measurement is  $\geq 1.45$  W/kg (~ 10% from the 1-g SAR limit).
- 4) Perform a third repeated measurement only if the original, first or second repeated measurement is  $\geq 1.5$  W/kg and the ratio of largest to smallest SAR for the original, first and second repeated measurements is  $> 1.20$ .

## 15 Measurement Uncertainty

### 15.1 Measurement Uncertainty for Normal SAR Tests (300MHz~3GHz)

No.	Error Description	Type	Uncertainty value	Probably Distribution	Div.	(Ci) 1g	(Ci) 10g	Std. Unc. (1g)	Std. Unc. (10g)	Degree of freedom
<b>Measurement system</b>										
1	Probe calibration	B	12	N	2	1	1	6.0	6.0	∞
2	Isotropy	B	7.4	R	$\sqrt{3}$	1	1	4.3	4.3	∞
3	Boundary effect	B	1.1	R	$\sqrt{3}$	1	1	0.6	0.6	∞
4	Linearity	B	4.7	R	$\sqrt{3}$	1	1	2.7	2.7	∞
5	Detection limit	B	1.0	R	$\sqrt{3}$	1	1	0.6	0.6	∞
6	Readout electronics	B	1.0	N	1	1	1	1.0	1.0	∞
7	Response time	B	0.0	R	$\sqrt{3}$	1	1	0.0	0.0	∞
8	Integration time	B	1.7	R	$\sqrt{3}$	1	1	1.0	1.0	∞
9	RF ambient conditions-noise	B	3.0	R	$\sqrt{3}$	1	1	1.7	1.7	∞
10	RF ambient conditions-reflection	B	3.0	R	$\sqrt{3}$	1	1	1.7	1.7	∞
11	Probe positioned mech. restrictions	B	0.35	R	$\sqrt{3}$	1	1	0.2	0.2	∞
12	Probe positioning with respect to phantom shell	B	2.9	R	$\sqrt{3}$	1	1	1.7	1.7	∞
13	Post-processing	B	1.0	R	$\sqrt{3}$	1	1	0.6	0.6	∞
<b>Test sample related</b>										
14	Test sample positioning	A	3.3	N	1	1	1	3.3	3.3	5
15	Device holder uncertainty	A	3.4	N	1	1	1	3.4	3.4	5
16	Drift of output power	B	5.0	R	$\sqrt{3}$	1	1	2.9	2.9	∞
<b>Phantom and set-up</b>										
17	Phantom uncertainty	B	1.0	R	$\sqrt{3}$	1	1	0.6	0.6	∞
18	Liquid conductivity (target)	B	5.0	R	$\sqrt{3}$	0.64	0.43	1.8	1.2	∞
19	Liquid conductivity (meas.)	A	1.3	N	1	0.64	0.43	0.83	0.56	9
20	Liquid permittivity (target)	B	5.0	R	$\sqrt{3}$	0.6	0.49	1.7	1.4	∞
21	Liquid permittivity (meas.)	A	1.6	N	1	0.6	0.49	0.96	0.78	9
Combined standard uncertainty		$u_c = \sqrt{\sum_{i=1}^{21} c_i^2 u_i^2}$						10.4	10.3	95.5
Expanded uncertainty (Confidence interval of 95 %)		$u_e = 2u_c$						20.8	20.6	

### 15.2 Measurement Uncertainty for Fast SAR Tests (300MHz~3GHz)

No.	Error Description	Type	Uncertainty value	Probably Distribution	Div.	(Ci) 1g	(Ci) 10g	Std. Unc. (1g)	Std. Unc. (10g)	Degree of freedom
<b>Measurement system</b>										
1	Probe calibration	B	12	N	2	1	1	6.0	6.0	∞
2	Isotropy	B	7.4	R	$\sqrt{3}$	1	1	4.3	4.3	∞
3	Boundary effect	B	1.1	R	$\sqrt{3}$	1	1	0.6	0.6	∞
4	Linearity	B	4.7	R	$\sqrt{3}$	1	1	2.7	2.7	∞
5	Detection limit	B	1.0	R	$\sqrt{3}$	1	1	0.6	0.6	∞
6	Readout electronics	B	1.0	N	1	1	1	1.0	1.0	∞
7	Response time	B	0.0	R	$\sqrt{3}$	1	1	0.0	0.0	∞
8	Integration time	B	1.7	R	$\sqrt{3}$	1	1	1.0	1.0	∞
9	RF ambient conditions-noise	B	3.0	R	$\sqrt{3}$	1	1	1.7	1.7	∞
10	RF ambient conditions-reflection	B	3.0	R	$\sqrt{3}$	1	1	1.7	1.7	∞
11	Probe positioned mech. Restrictions	B	0.35	R	$\sqrt{3}$	1	1	0.2	0.2	∞
12	Probe positioning with respect to phantom shell	B	2.9	R	$\sqrt{3}$	1	1	1.7	1.7	∞
13	Post-processing	B	1.0	R	$\sqrt{3}$	1	1	0.6	0.6	∞
14	Fast SAR z-Approximation	B	7.0	R	$\sqrt{3}$	1	1	4.0	4.0	∞
<b>Test sample related</b>										
15	Test sample positioning	A	3.3	N	1	1	1	3.3	3.3	5
16	Device holder uncertainty	A	3.4	N	1	1	1	3.4	3.4	5
17	Drift of output power	B	5.0	R	$\sqrt{3}$	1	1	2.9	2.9	∞
<b>Phantom and set-up</b>										
18	Phantom uncertainty	B	1.0	R	$\sqrt{3}$	1	1	0.6	0.6	∞
19	Liquid conductivity (target)	B	5.0	R	$\sqrt{3}$	0.64	0.43	1.8	1.2	∞
20	Liquid conductivity (meas.)	A	1.3	N	1	0.64	0.43	0.83	0.56	43
21	Liquid permittivity (target)	B	5.0	R	$\sqrt{3}$	0.6	0.49	1.7	1.4	∞
22	Liquid permittivity (meas.)	A	1.6	N	1	0.6	0.49	0.96	0.78	521
Combined standard uncertainty		$u_c = \sqrt{\sum_{i=1}^{22} c_i^2 u_i^2}$						11.1	11.0	257
Expanded uncertainty (Confidence interval of 95 %)		$u_e = 2u_c$						22.2	22.0	

### 15.3 Measurement Uncertainty for Normal SAR Tests (3GHz~6GHz)

No.	Error Description	Type	Uncertainty value	Probably Distribution	Div.	(Ci) 1g	(Ci) 10g	Std. Unc. (1g)	Std. Unc. (10g)	Degree of freedom
<b>Measurement system</b>										
1	Probe calibration	B	13	N	2	1	1	6.5	6.5	∞
2	Isotropy	B	7.4	R	$\sqrt{3}$	1	1	4.3	4.3	∞
3	Boundary effect	B	2.3	R	$\sqrt{3}$	1	1	1.3	1.3	∞
4	Linearity	B	4.7	R	$\sqrt{3}$	1	1	2.7	2.7	∞
5	Detection limit	B	1.0	R	$\sqrt{3}$	1	1	0.6	0.6	∞
6	Readout electronics	B	1.0	N	1	1	1	1.0	1.0	∞
7	Response time	B	0.0	R	$\sqrt{3}$	1	1	0.0	0.0	∞
8	Integration time	B	1.7	R	$\sqrt{3}$	1	1	1.0	1.0	∞
9	RF ambient conditions-noise	B	3.0	R	$\sqrt{3}$	1	1	1.7	1.7	∞
10	RF ambient conditions-reflection	B	3.0	R	$\sqrt{3}$	1	1	1.7	1.7	∞
11	Probe positioned mech. restrictions	B	0.71	R	$\sqrt{3}$	1	1	0.4	0.4	∞
12	Probe positioning with respect to phantom shell	B	5.7	R	$\sqrt{3}$	1	1	3.3	3.3	∞
13	Post-processing	B	4.0	R	$\sqrt{3}$	1	1	2.3	2.3	∞
<b>Test sample related</b>										
14	Test sample positioning	A	3.3	N	1	1	1	3.3	3.3	5
15	Device holder uncertainty	A	3.4	N	1	1	1	3.4	3.4	5
16	Drift of output power	B	5.0	R	$\sqrt{3}$	1	1	2.9	2.9	∞
<b>Phantom and set-up</b>										
17	Phantom uncertainty	B	1.0	R	$\sqrt{3}$	1	1	0.6	0.6	∞
18	Liquid conductivity (target)	B	5.0	R	$\sqrt{3}$	0.64	0.43	1.8	1.2	∞
19	Liquid conductivity (meas.)	A	1.3	N	1	0.64	0.43	0.83	0.56	9
20	Liquid permittivity (target)	B	5.0	R	$\sqrt{3}$	0.6	0.49	1.7	1.4	∞
21	Liquid permittivity (meas.)	A	1.6	N	1	0.6	0.49	0.96	0.78	9
Combined standard uncertainty		$u_c = \sqrt{\sum_{i=1}^{21} c_i^2 u_i^2}$						11.3	11.2	95.5
Expanded uncertainty (Confidence interval of 95 %)		$u_e = 2u_c$						22.6	22.4	



### 15.4 Measurement Uncertainty for Fast SAR Tests (3GHz~6GHz)

No.	Error Description	Type	Uncertainty value	Probably Distribution	Div	(Ci) 1g	(Ci) 10g	Std. Unc. (1g)	Std. Unc. (10g)	Degree of freedom
<b>Measurement system</b>										
1	Probe calibration	B	13	N	2	1	1	6.5	6.5	∞
2	Isotropy	B	7.4	R	$\sqrt{3}$	1	1	4.3	4.3	∞
3	Boundary effect	B	2.3	R	$\sqrt{3}$	1	1	1.3	1.3	∞
4	Linearity	B	4.7	R	$\sqrt{3}$	1	1	2.7	2.7	∞
5	Detection limit	B	1.0	R	$\sqrt{3}$	1	1	0.6	0.6	∞
6	Readout electronics	B	1.0	N	1	1	1	1.0	1.0	∞
7	Response time	B	0.0	R	$\sqrt{3}$	1	1	0.0	0.0	∞
8	Integration time	B	1.7	R	$\sqrt{3}$	1	1	1.0	1.0	∞
9	RF ambient conditions-noise	B	3.0	R	$\sqrt{3}$	1	1	1.7	1.7	∞
10	RF ambient conditions-reflection	B	3.0	R	$\sqrt{3}$	1	1	1.7	1.7	∞
11	Probe positioned mech. Restrictions	B	0.71	R	$\sqrt{3}$	1	1	0.4	0.4	∞
12	Probe positioning with respect to phantom shell	B	5.7	R	$\sqrt{3}$	1	1	3.3	3.3	∞
13	Post-processing	B	4.0	R	$\sqrt{3}$	1	1	2.3	2.3	∞
14	Fast SAR z-Approximation	B	14.0	R	$\sqrt{3}$	1	1	8.1	8.1	∞
<b>Test sample related</b>										
15	Test sample positioning	A	3.3	N	1	1	1	3.3	3.3	5
16	Device holder uncertainty	A	3.4	N	1	1	1	3.4	3.4	5
17	Drift of output power	B	5.0	R	$\sqrt{3}$	1	1	2.9	2.9	∞
<b>Phantom and set-up</b>										
18	Phantom uncertainty	B	1.0	R	$\sqrt{3}$	1	1	0.6	0.6	∞
19	Liquid conductivity (target)	B	5.0	R	$\sqrt{3}$	0.64	0.43	1.8	1.2	∞
20	Liquid conductivity (meas.)	A	1.3	N	1	0.64	0.43	0.83	0.56	43
21	Liquid permittivity (target)	B	5.0	R	$\sqrt{3}$	0.6	0.49	1.7	1.4	∞
22	Liquid permittivity (meas.)	A	1.6	N	1	0.6	0.49	0.96	0.78	521
Combined standard uncertainty		$u_c = \sqrt{\sum_{i=1}^{22} c_i^2 u_i^2}$						13.9	13.9	257
Expanded uncertainty (Confidence interval of 95 %)		$u_e = 2u_c$						27.8	27.7	

## 16 Main Test Instruments

**Table 16.1: List of Main Instruments**

No.	Name	Type	Serial Number	Calibration Date	Valid Period
01	Network analyzer	Agilent E5071C	MY46103759	2017-11-17	One year
02	Dielectric probe	85070E	MY44300317	/	/
03	Power meter	NRP	102603	2018-01-04	One year
04	Power sensor	NRP-Z51	102211		
05	Power meter	NRP	101460	2018-02-05	One year
06	Power sensor	NRP-Z91	100553		
07	Signal Generator	E8257D	MY47461211	2018-06-05	One year
08	Amplifier	VTL5400	0404	/	/
09	E-field Probe	SPEAG EX3DV4	3633	2018-02-01	One year
10	DAE	SPEAG DAE4	786	2017-11-22	One year
11	Dipole Validation Kit	SPEAG D2450V2	873	2015-10-30	Three year
12	Dipole Validation Kit	SPEAG D5GHzV2	1238	2016-09-21	Three year

\*\*\*END OF REPORT BODY\*\*\*

## ANNEX A Graph Results

### Wi-Fi 2.4G Head

Date: 2018-7-27

Electronics: DAE4 Sn786

Medium: Head 2450 MHz

Medium parameters used (interpolated):  $f = 2437$  MHz;  $\sigma = 1.831$  S/m;  $\epsilon_r = 38.644$ ;  $\rho = 1000$  kg/m<sup>3</sup>

Ambient Temperature: 22.0°C      Liquid Temperature: 21.5°C

Communication System: UID 0, WiFi (0) Frequency: 2437 MHz Duty Cycle: 1:1

Probe: EX3DV4 - SN3633 ConvF (7.42, 7.42, 7.42)

**Left Cheek Middle/Area Scan (61x61x1):** Interpolated grid: dx=1.000 mm, dy=1.000 mm  
Maximum value of SAR (interpolated) = 0.603 W/kg

**Left Cheek Middle/Zoom Scan (5x5x7)/Cube 0:** Measurement grid: dx=5mm, dy=5mm, dz=5mm  
Reference Value = 12.77 V/m; Power Drift = -0.03 dB

Peak SAR (extrapolated) = 0.775 W/kg

**SAR(1 g) = 0.433 W/kg; SAR(10 g) = 0.193 W/kg**

Maximum value of SAR (measured) = 0.526W/kg

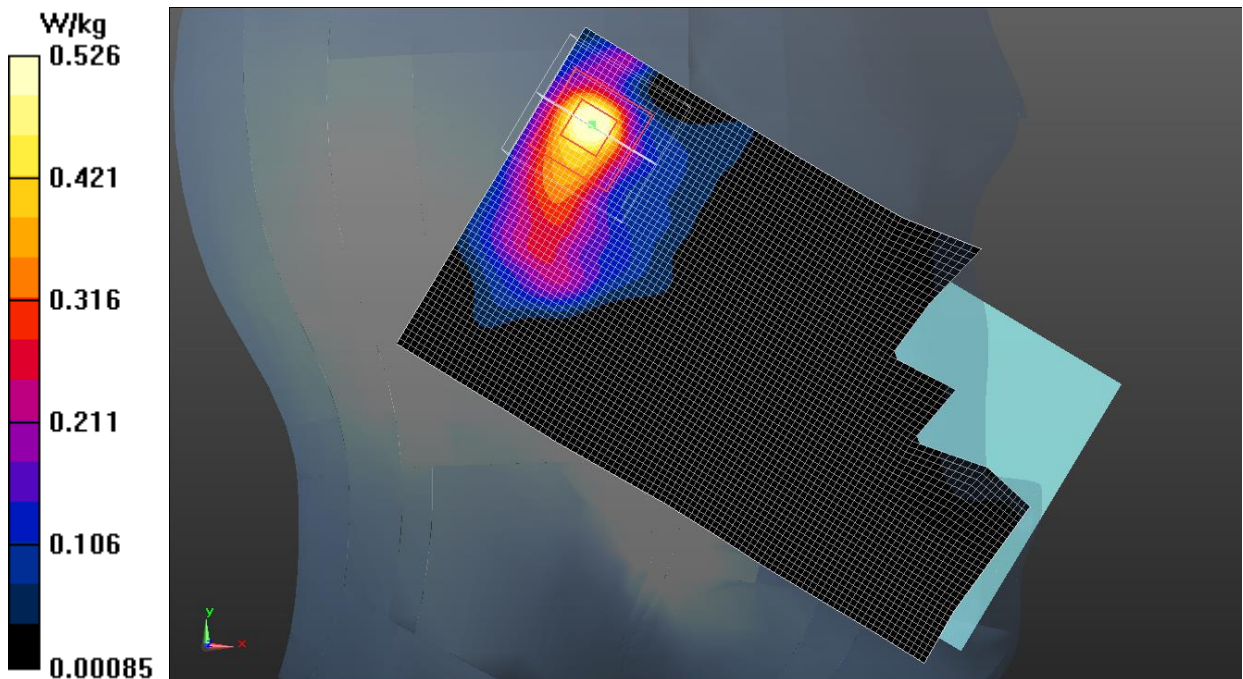

Fig.1 Wi-Fi 2.4G

**Wi-Fi 2.4G Body**

Date: 2018-7-27

Electronics: DAE4 Sn786

Medium: Body 2450 MHz

Medium parameters used (interpolated):  $f = 2437$  MHz;  $\sigma = 1.893$  S/m;  $\epsilon_r = 53.904$ ;  $\rho = 1000$  kg/m<sup>3</sup>

Ambient Temperature: 22.0°C      Liquid Temperature: 21.5°C

Communication System: UID 0, WiFi (0) Frequency: 2437 MHz Duty Cycle: 1:1

Probe: EX3DV4 - SN3633 ConvF (7.47, 7.47, 7.47)

**Rear Side Middle /Area Scan (61x101x1):** Interpolated grid: dx=1.000 mm, dy=1.000 mm

Maximum value of SAR (interpolated) = 0.267 W/kg

**Rear Side Middle/Zoom Scan (5x5x7)/Cube 0:** Measurement grid: dx=5mm, dy=5mm, dz=5mm

Reference Value = 2.857 V/m; Power Drift = 0.01 dB

Peak SAR (extrapolated) = 0.412 W/kg

**SAR(1 g) = 0.235 W/kg; SAR(10 g) = 0.125 W/kg**

Maximum value of SAR (measured) = 0.255 W/kg

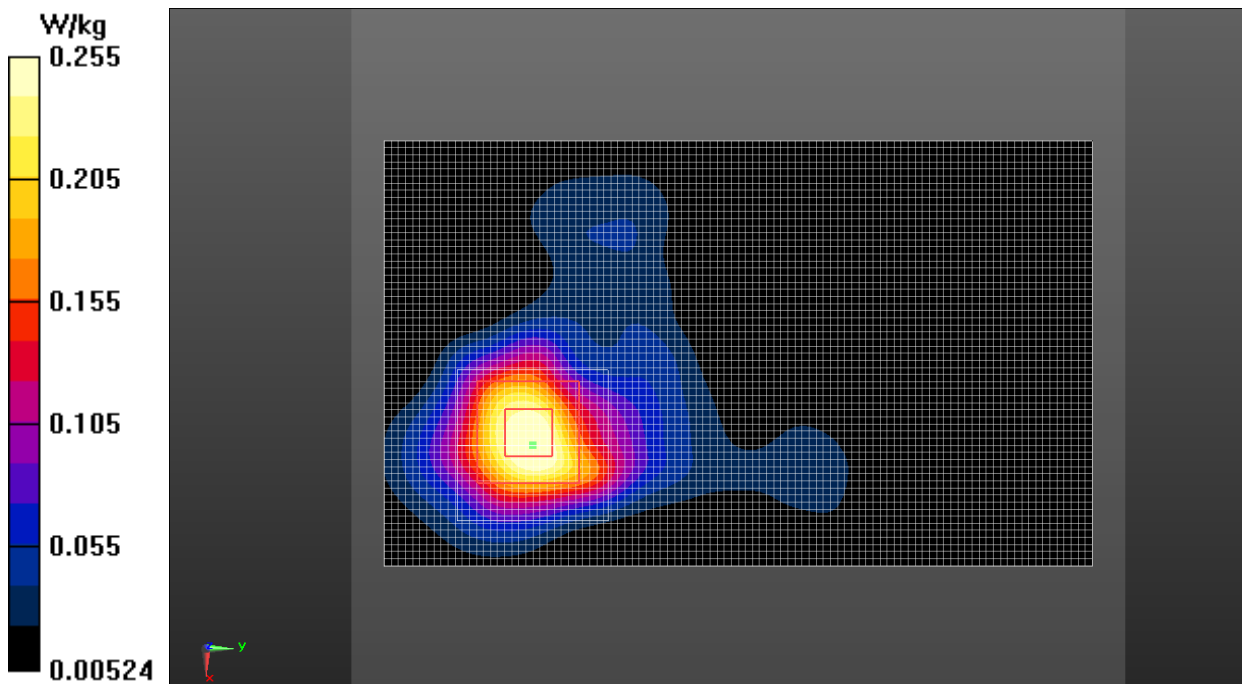

**Fig.2 Wi-Fi 2.4G**

**Wi-Fi 5G Head**

Date: 2018-7-27

Electronics: DAE4 Sn786

Medium: Head 5600 MHz

Medium parameters used:  $f = 5500$  MHz;  $\sigma = 5.079$  S/m;  $\epsilon_r = 34.768$ ;  $\rho = 1000$  kg/m<sup>3</sup>

Ambient Temperature: 22.0°C      Liquid Temperature: 21.5°C

Communication System: UID 0, WIFI 5G (0) Frequency: 5500 MHz Duty Cycle: 1:1

Probe: EX3DV4 - SN3633 ConvF (4.86, 4.86, 4.86)

**Right Tilt CH100/Area Scan (61x111x1):** Interpolated grid: dx=1.000 mm, dy=1.000 mm

Maximum value of SAR (interpolated) = 0.643 W/kg

**Right Tilt CH100/Zoom Scan (5x5x7)/Cube 0:** Measurement grid: dx=5mm, dy=5mm, dz=1.4mm

Reference Value = 3.646 V/m; Power Drift = -0.11 dB

Peak SAR (extrapolated) = 1.62 W/kg

**SAR(1 g) = 0.548 W/kg; SAR(10 g) = 0.180 W/kg**

Maximum value of SAR (measured) = 0.701 W/kg

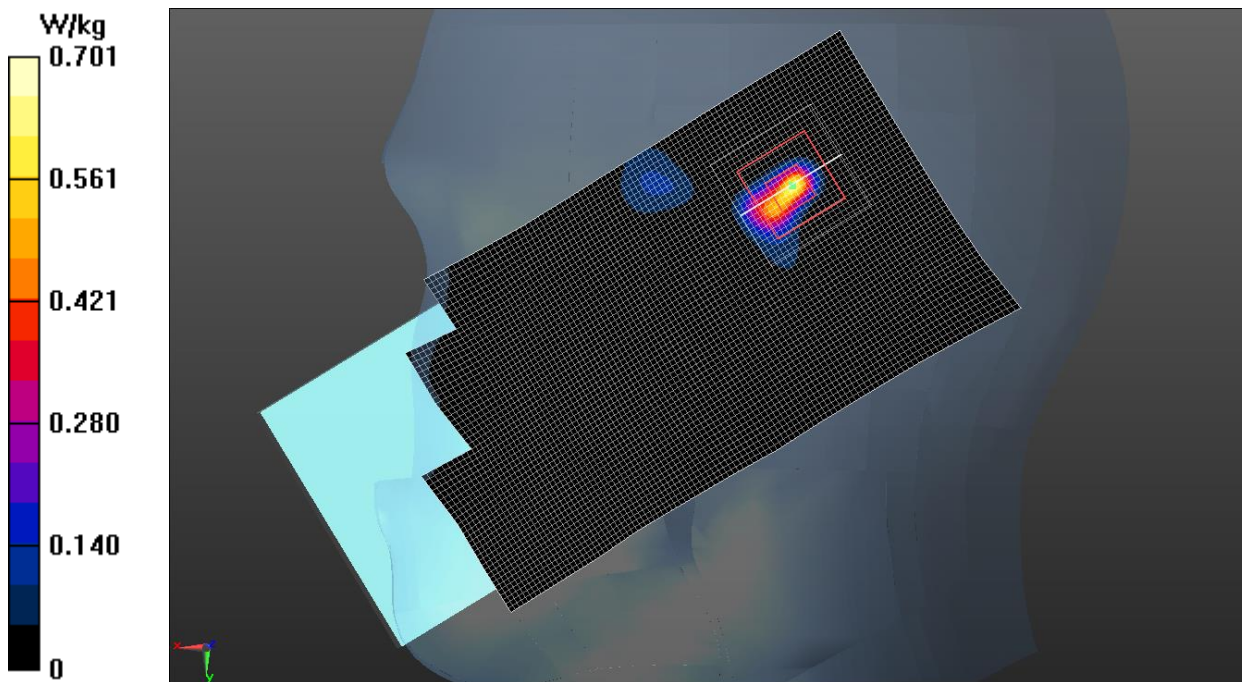

**Fig.3 Wi-Fi 5G**

**Wi-Fi 5G Body**

Date: 2018-7-27

Electronics: DAE4 Sn786

Medium: Body 5300 MHz

Medium parameters used:  $f = 5260$  MHz;  $\sigma = 5.264$  S/m;  $\epsilon_r = 50.487$ ;  $\rho = 1000$  kg/m<sup>3</sup>

Ambient Temperature: 22.0°C      Liquid Temperature: 21.5°C

Communication System: UID 0, WIFI 5G (0) Frequency: 5260 MHz Duty Cycle: 1:1

Probe: EX3DV4 - SN3633 ConvF (5.15, 5.15, 5.15);

**Top side CH52/Area Scan (51x91x1):** Interpolated grid: dx=1.000 mm, dy=1.000 mm

Maximum value of SAR (interpolated) = 0.536 W/kg

**Top side CH52/Zoom Scan (7x7x7)/Cube 0:** Measurement grid: dx=4mm, dy=4mm, dz=1.4mm

Reference Value = 2.397 V/m; Power Drift = 0.12 dB

Peak SAR (extrapolated) = 0.753 W/kg

**SAR(1 g) = 0.265 W/kg; SAR(10 g) = 0.114 W/kg**

Maximum value of SAR (measured) = 0.306 W/kg

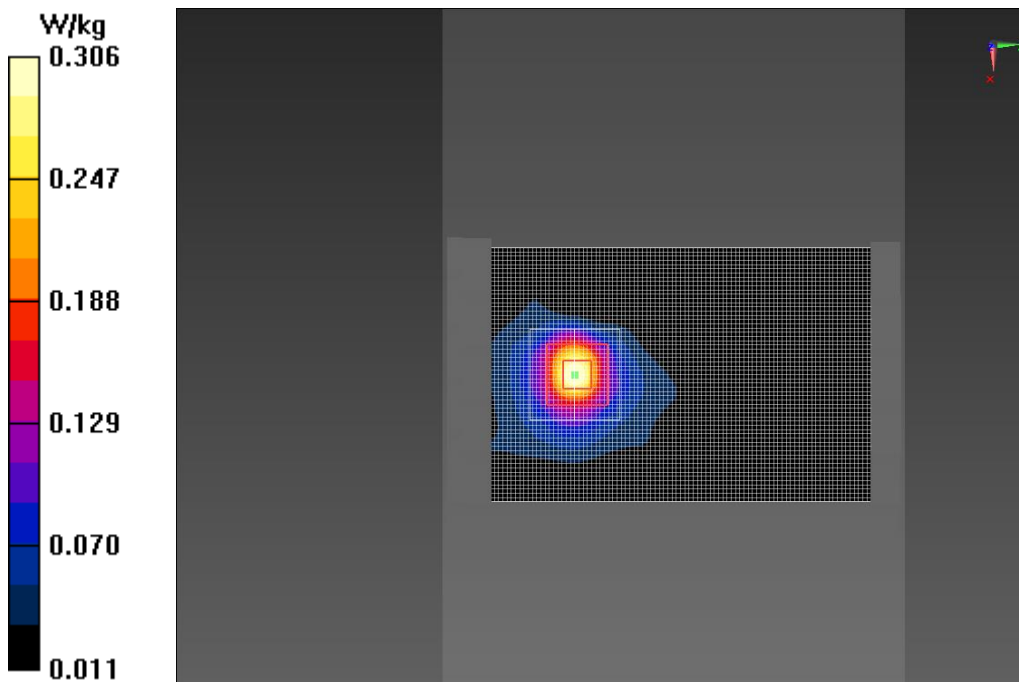

**Fig.4 Wi-Fi 5G**

## ANNEX B SystemVerification Results

### 2450MHz

Date: 2018-7-27

Electronics: DAE4 Sn786

Medium: Head 2450 MHz

Medium parameters used:  $f = 2450 \text{ MHz}$ ;  $\sigma = 1.843 \text{ S/m}$ ;  $\epsilon_r = 38.588$ ;  $\rho = 1000 \text{ kg/m}^3$

Ambient Temperature:  $22.0^\circ\text{C}$       Liquid Temperature:  $21.6^\circ\text{C}$

Communication System: CW Frequency: 2450 MHz Duty Cycle: 1:1

Probe: EX3DV4 – SN3633 ConvF (7.42, 7.42, 7.42);

**System Validation /Area Scan (61x81x1):** Interpolated grid:  $dx=1.000 \text{ mm}$ ,  $dy=1.000 \text{ mm}$

Reference Value =  $90.454 \text{ V/m}$ ; Power Drift =  $0.11 \text{ dB}$

**SAR(1 g) =  $13.3 \text{ W/kg}$ ; SAR(10 g) =  $6.11 \text{ W/kg}$**

Maximum value of SAR (interpolated) =  $15.1 \text{ W/kg}$

**System Validation /Zoom Scan (7x7x7)/Cube 0:** Measurement grid:  $dx=5\text{mm}$ ,  $dy=5\text{mm}$ ,  $dz=5\text{mm}$

Reference Value =  $90.454 \text{ V/m}$ ; Power Drift =  $0.11 \text{ dB}$

Peak SAR (extrapolated) =  $24.8 \text{ W/kg}$

**SAR(1 g) =  $13.5 \text{ W/kg}$ ; SAR(10 g) =  $6.14 \text{ W/kg}$**

Maximum value of SAR (measured) =  $15.4 \text{ W/kg}$

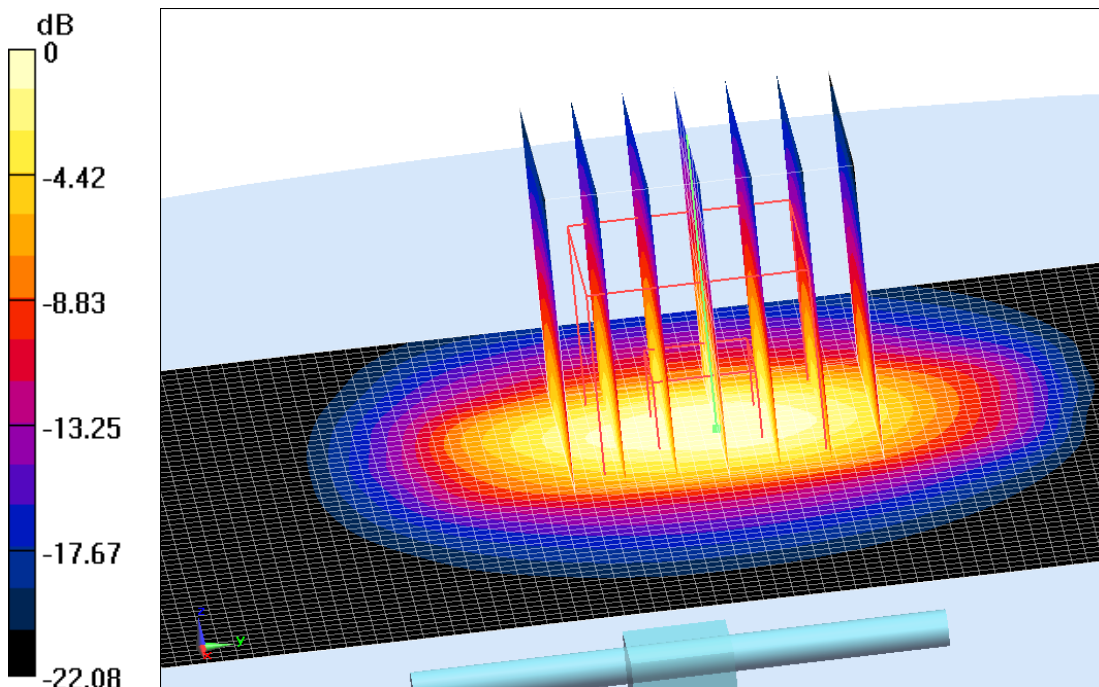

0 dB =  $15.4 \text{ W/kg}$  =  $11.88 \text{ dB W/kg}$

**Fig.B.1. Validation 2450MHz 250mW**

## 2450MHz

Date: 2018-7-27

Electronics: DAE4 Sn786

Medium: Body 2450 MHz

Medium parameters used:  $f = 2450$  MHz;  $\sigma = 1.907$  S/m;  $\epsilon_r = 53.862$ ;  $\rho = 1000$  kg/m<sup>3</sup>

Ambient Temperature: 22.0°C      Liquid Temperature: 21.6°C

Communication System: CW Frequency: 2450 MHz Duty Cycle: 1:1

Probe: EX3DV4 – SN3633 ConvF (7.47, 7.47, 7.47);

**System Validation/Area Scan (81x101x1):** Interpolated grid: dx=1.000 mm, dy=1.000 mm

Reference Value = 86.225 V/m; Power Drift = -0.07 dB

**SAR(1 g) = 12.7 W/kg; SAR(10 g) = 6.05 W/kg**

Maximum value of SAR (interpolated) = 14.0 W/kg

**System Validation/Zoom Scan (7x7x7)/Cube 0:** Measurement grid: dx=5mm, dy=5mm, dz=5mm

Reference Value = 86.225 V/m; Power Drift = -0.07 dB

Peak SAR (extrapolated) = 22.5 W/kg

**SAR(1 g) = 12.5 W/kg; SAR(10 g) = 5.97 W/kg**

Maximum value of SAR (measured) = 13.8 W/kg

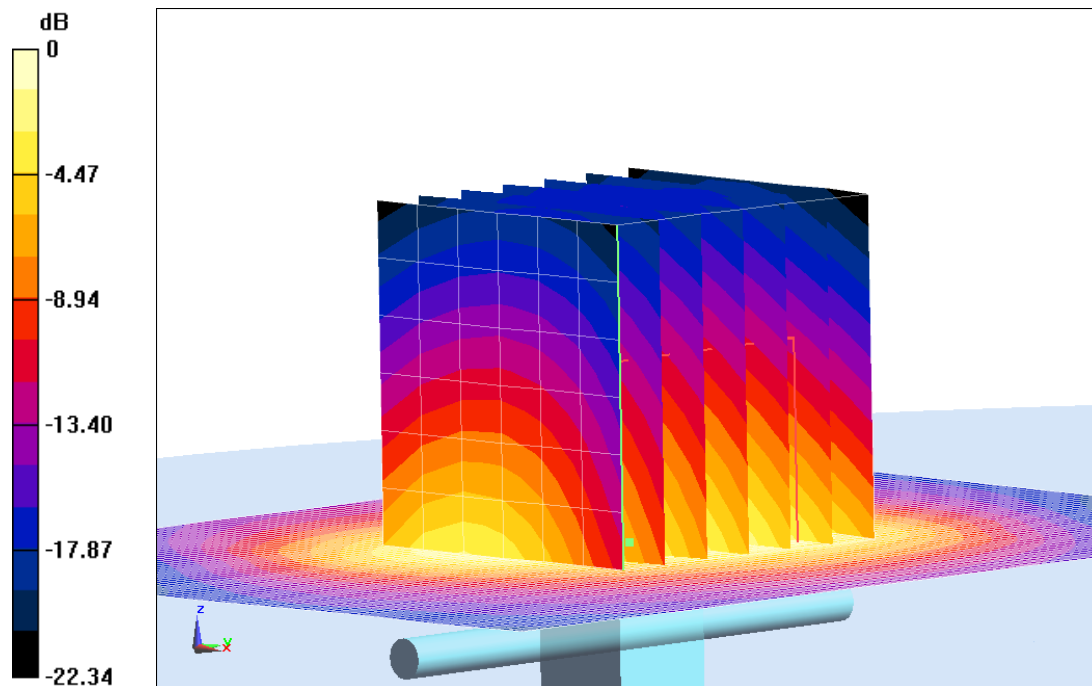

0 dB = 13.8 W/kg = 11.40 dB W/kg

**Fig.B.2. Validation 2450MHz 250mW**



## 5300MHz

Date: 2018-7-27

Electronics: DAE4 Sn786

Medium: Head 5300 MHz

Medium parameters used:  $f = 5300$  MHz;  $\sigma = 4.832$  S/m;  $\epsilon_r = 35.44$ ;  $\rho = 1000$  kg/m<sup>3</sup>

Ambient Temperature: 23.0°C      Liquid Temperature: 22.5°C

Communication System: CW Frequency: 5300 MHz Duty Cycle: 1:1

Probe: EX3DV4 - SN3633 ConvF (5.61, 5.61, 5.61);

**System Validation /Area Scan (91x91x1):** Interpolated grid: dx=1.000 mm, dy=1.000 mm

Reference Value = 58.962 V/m; Power Drift = 0.02 dB

**SAR(1 g) = 8.58 W/kg; SAR(10 g) = 2.42 W/kg**

Maximum value of SAR (interpolated) =10.5 W/kg

**System Validation/Zoom Scan (8x8x8)/Cube0:** Measurement grid: dx=4mm, dy=4mm, dz=4mm

Reference Value = 58.962 V/m; Power Drift = 0.02 dB

Peak SAR (extrapolated) = 32.3 W/kg

**SAR(1 g) = 8.64 W/kg; SAR(10 g) = 2.44 W/kg**

Maximum value of SAR (measured) =10.7 W/kg

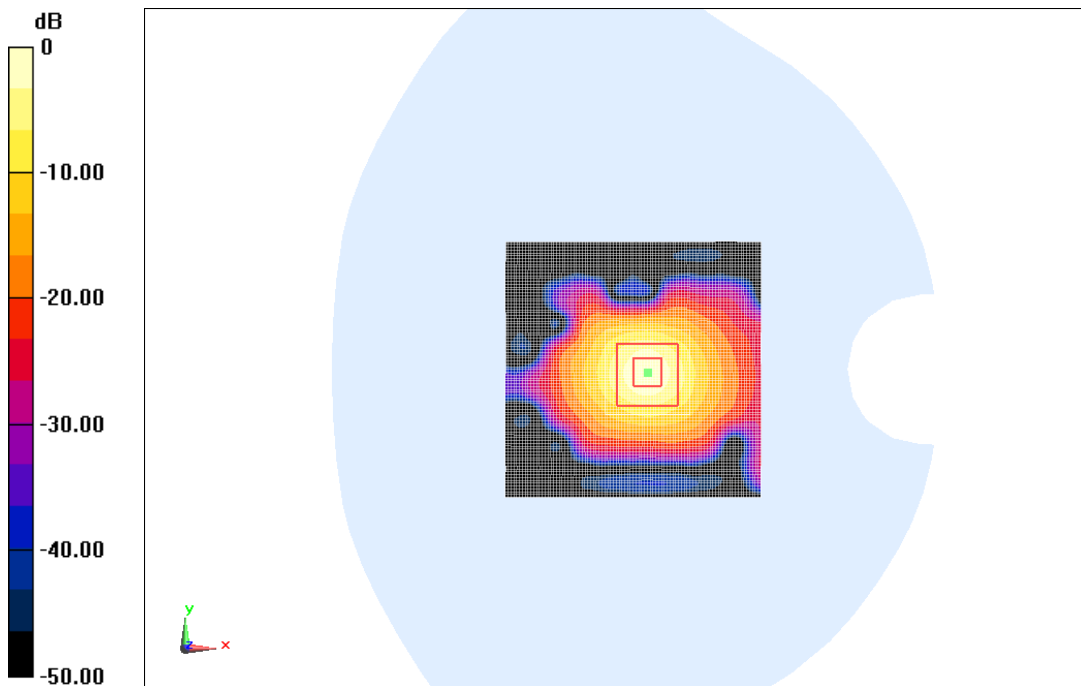

0 dB = 10.7 W/kg = 10.29 dB W/kg

**Fig.B.3. validation 5300MHz 100mW**

## 5300MHz

Date: 2018-7-27

Electronics: DAE4 Sn786

Medium: Body 5300 MHz

Medium parameters used:  $f = 5300$  MHz;  $\sigma = 5.368$  S/m;  $\epsilon_r = 50.193$ ;  $\rho = 1000$  kg/m<sup>3</sup>

Ambient Temperature: 23.0°C      Liquid Temperature: 22.5°C

Communication System: CW Frequency: 5300 MHz Duty Cycle: 1:1

Probe: EX3DV4 - SN3633 ConvF (5.15, 5.15, 5.15);

**System Validation /Area Scan (91x91x1):** Interpolated grid: dx=1.000 mm, dy=1.000 mm

Reference Value = 56.488 V/m; Power Drift = -0.03 dB

**SAR(1 g) = 7.42 W/kg; SAR(10 g) = 2.14 W/kg**

Maximum value of SAR (interpolated) = 9.79 W/kg

**System Validation/Zoom Scan (8x8x8)/Cube0:** Measurement grid: dx=4mm, dy=4mm, dz=4mm

Reference Value = 56.488 V/m; Power Drift = -0.03 dB

Peak SAR (extrapolated) = 26.9 W/kg

**SAR(1 g) = 7.38 W/kg; SAR(10 g) = 2.11 W/kg**

Maximum value of SAR (measured) = 9.74 W/kg

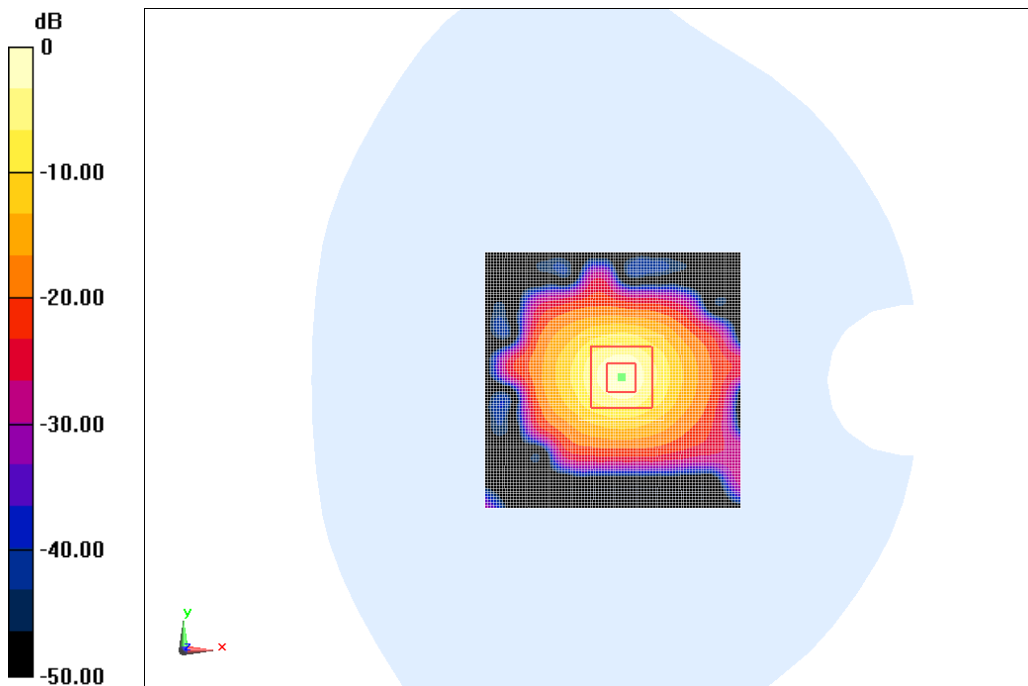

0 dB = 9.74 W/kg = 9.89 dB W/kg

**Fig.B.4. validation 5300MHz 100mW**

## 5600MHz

Date: 2018-7-27

Electronics: DAE4 Sn786

Medium: Head 5600 MHz

Medium parameters used:  $f = 5600$  MHz;  $\sigma = 5.224$  S/m;  $\epsilon_r = 34.546$ ;  $\rho = 1000$  kg/m<sup>3</sup>

Ambient Temperature: 23.0°C      Liquid Temperature: 22.5°C

Communication System: CW Frequency: 5600 MHz Duty Cycle: 1:1

Probe: EX3DV4 - SN3633 ConvF (4.86, 4.86, 4.86);

**System Validation /Area Scan (91x91x1):** Interpolated grid: dx=1.000 mm, dy=1.000 mm

Reference Value = 68.042 V/m; Power Drift = 0.08 dB

**SAR(1 g) = 8.49 W/kg; SAR(10 g) = 2.37 W/kg**

Maximum value of SAR (interpolated) = 10.0 W/kg

**System Validation/Zoom Scan (8x8x8)/Cube0:** Measurement grid: dx=4mm, dy=4mm, dz=4mm

Reference Value = 68.042 V/m; Power Drift = 0.08 dB

Peak SAR (extrapolated) = 30.2 W/kg

**SAR(1 g) = 8.57 W/kg; SAR(10 g) = 2.39 W/kg**

Maximum value of SAR (measured) = 10.1 W/kg

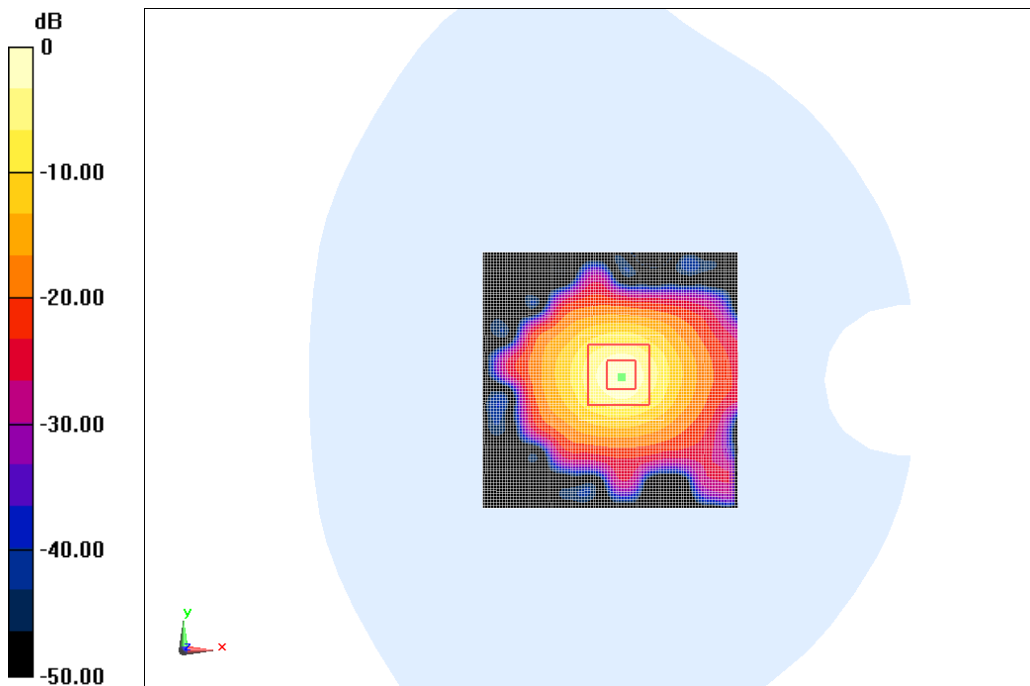

0 dB = 10.1 W/kg = 10.03 dB W/kg

**Fig.B.5. validation 5600MHz 100mW**

## 5600MHz

Date: 2018-7-27

Electronics: DAE4 Sn786

Medium: Body 5600 MHz

Medium parameters used:  $f = 5600$  MHz;  $\sigma = 5.805$  S/m;  $\epsilon_r = 48.122$ ;  $\rho = 1000$  kg/m<sup>3</sup>

Ambient Temperature: 23.0°C      Liquid Temperature: 22.5°C

Communication System: CW Frequency: 5600 MHz Duty Cycle: 1:1

Probe: EX3DV4 - SN3633 ConvF (4.33, 4.33, 4.33);

**System Validation /Area Scan (91x91x1):** Interpolated grid: dx=1.000 mm, dy=1.000 mm

Reference Value = 60.756 V/m; Power Drift = 0.01 dB

**SAR(1 g) = 8.08 W/kg; SAR(10 g) = 2.22 W/kg**

Maximum value of SAR (interpolated) = 9.88 W/kg

**System Validation/Zoom Scan (8x8x8)/Cube0:** Measurement grid: dx=4mm, dy=4mm, dz=4mm

Reference Value = 60.756 V/m; Power Drift = 0.01 dB

Peak SAR (extrapolated) = 28.2 W/kg

**SAR(1 g) = 8.16 W/kg; SAR(10 g) = 2.26 W/kg**

Maximum value of SAR (measured) = 9.92 W/kg

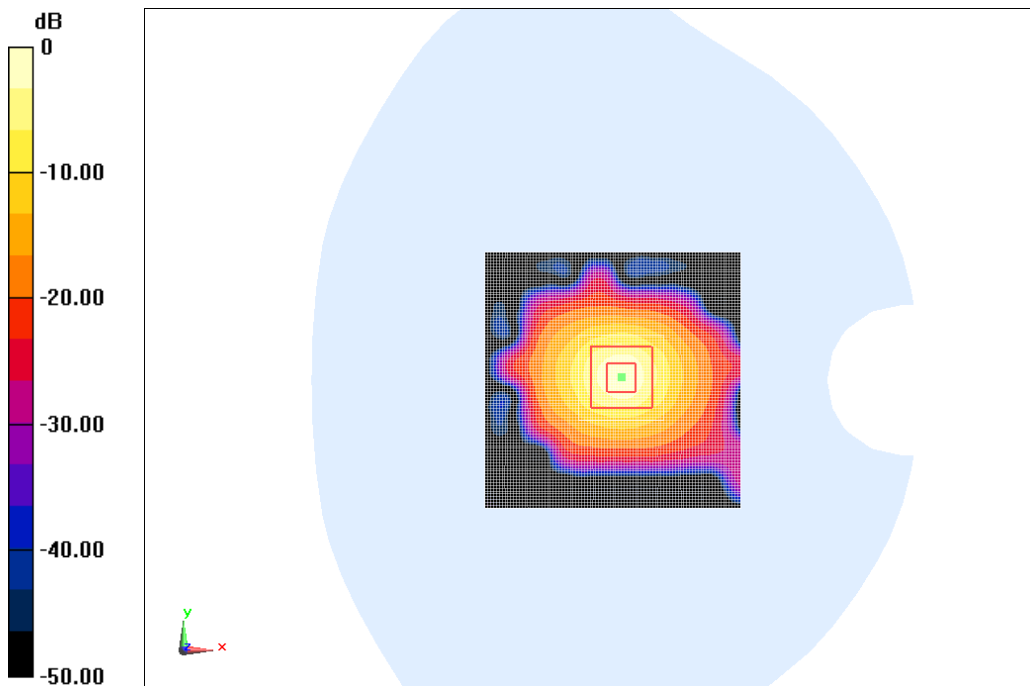

0 dB = 9.92 W/kg = 9.97 dB W/kg

**Fig.B.6. validation 5600MHz 100mW**

## 5800MHz

Date: 2018-7-27

Electronics: DAE4 Sn786

Medium: Head 5800 MHz

Medium parameters used:  $f = 5800$  MHz;  $\sigma = 5.326$  S/m;  $\epsilon_r = 34.68$ ;  $\rho = 1000$  kg/m<sup>3</sup>

Ambient Temperature: 23.0°C      Liquid Temperature: 22.5°C

Communication System: CW Frequency: 5800 MHz Duty Cycle: 1:1

Probe: EX3DV4 - SN3633 ConvF (4.81, 4.81, 4.81);

**System Validation/Area Scan (91x91x1):** Interpolated grid: dx=1.000 mm, dy=1.000 mm

Reference Value = 59.825 V/m; Power Drift = -0.09 dB

**SAR(1 g) = 7.70 W/kg; SAR(10 g) = 2.22 W/kg**

Maximum value of SAR (interpolated) = 9.73 W/kg

**System Validation/Zoom Scan (8x8x8)/Cube0:** Measurement grid: dx=4mm, dy=4mm, dz=4mm

Reference Value = 59.825 V/m; Power Drift = -0.09 dB

Peak SAR (extrapolated) = 27.7 W/kg

**SAR(1 g) = 7.62 W/kg; SAR(10 g) = 2.19 W/kg**

Maximum value of SAR (measured) = 9.66 W/kg

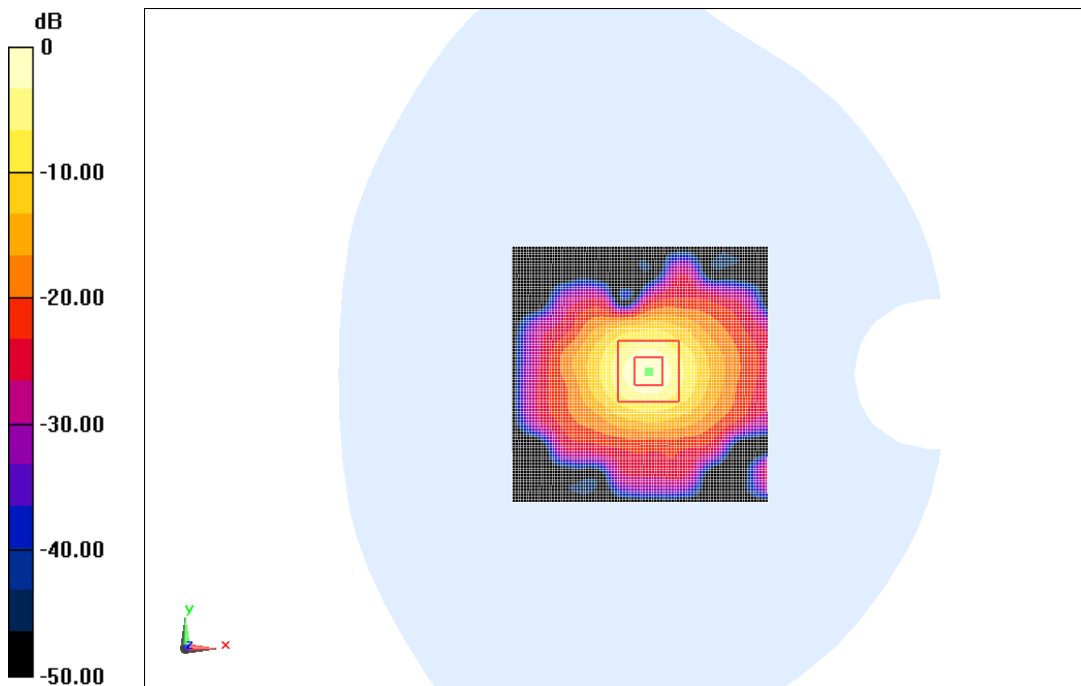

0 dB = 9.66 W/kg = 9.85 dB W/kg

**Fig.B.7. Validation 5800MHz 100mW**

## 5800MHz

Date: 2018-7-27

Electronics: DAE4 Sn786

Medium: Body 5800 MHz

Medium parameters used:  $f = 5800$  MHz;  $\sigma = 6.108$  S/m;  $\epsilon_r = 47.538$ ;  $\rho = 1000$  kg/m<sup>3</sup>

Ambient Temperature: 23.0°C      Liquid Temperature: 22.5°C

Communication System: CW Frequency: 5800 MHz Duty Cycle: 1:1

Probe: EX3DV4 - SN3633 ConvF (4.48, 4.48, 4.48);

**System Validation/Area Scan (91x91x1):** Interpolated grid: dx=1.000 mm, dy=1.000 mm

Reference Value = 60.982 V/m; Power Drift = 0.12 dB

**SAR(1 g) = 7.69 W/kg; SAR(10 g) = 2.10 W/kg**

Maximum value of SAR (interpolated) = 9.81 W/kg

**System Validation/Zoom Scan (8x8x8)/Cube0:** Measurement grid: dx=4mm, dy=4mm, dz=4mm

Reference Value = 60.982 V/m; Power Drift = 0.12 dB

Peak SAR (extrapolated) = 28.0 W/kg

**SAR(1 g) = 7.78 W/kg; SAR(10 g) = 2.13 W/kg**

Maximum value of SAR (measured) = 9.86 W/kg

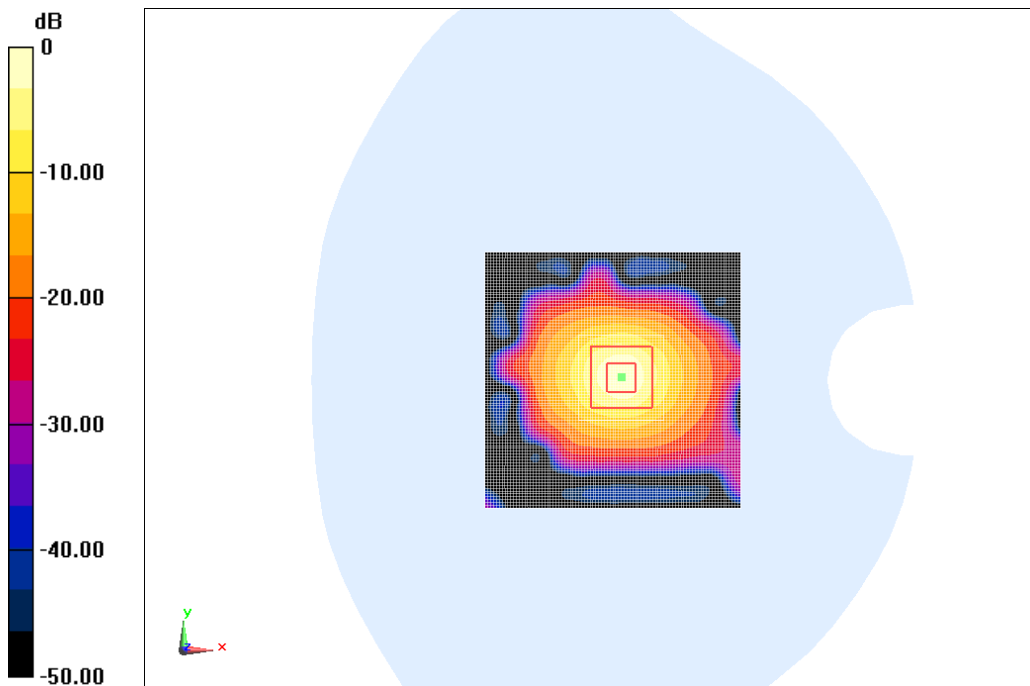

0 dB = 9.86 W/kg = 9.94 dB W/kg

**Fig.B.8. Validation 5800MHz 100mW**

## ANNEX C SAR Measurement Setup

### C.1 Measurement Set-up

DASY5 system for performing compliance tests is illustrated above graphically. This system consists of the following items:

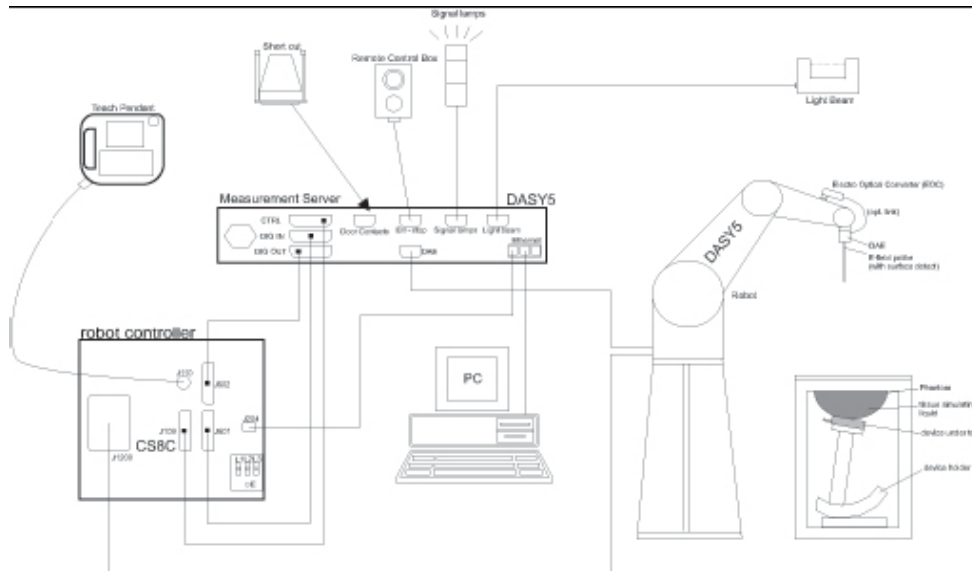

**Picture C.1 SAR Lab Test Measurement Set-up**

- A standard high precision 6-axis robot (Stäubli TX=RX family) with controller, teach pendant and software. An arm extension for accommodating the data acquisition electronics (DAE).
- An isotropic field probe optimized and calibrated for the targeted measurement.
- A data acquisition electronics (DAE) which performs the signal amplification, signal multiplexing, AD-conversion, offset measurements, mechanical surface detection, collision detection, etc. The unit is battery powered with standard or rechargeable batteries. The signal is optically transmitted to the EOC.
- The Electro-optical converter (EOC) performs the conversion from optical to electrical signals for the digital communication to the DAE. To use optical surface detection, a special version of the EOC is required. The EOC signal is transmitted to the measurement server.
- The function of the measurement server is to perform the time critical tasks such as signal filtering, control of the robot operation and fast movement interrupts.
- The Light Beam used is for probe alignment. This improves the (absolute) accuracy of the probe positioning.
- A computer running WinXP and the DASY5 software.
- Remote control and teach pendant as well as additional circuitry for robot safety such as
- warning lamps, etc.
- The phantom, the device holder and other accessories according to the targeted measurement.

## C.2 DASY5 E-field Probe System

The SAR measurements were conducted with the dosimetric probe designed in the classical triangular configuration and optimized for dosimetric evaluation. The probe is constructed using the thick film technique; with printed resistive lines on ceramic substrates. The probe is equipped with an optical multifiber line ending at the front of the probe tip. It is connected to the EOC box on the robot arm and provides an automatic detection of the phantom surface. Half of the fibers are connected to a pulsed infrared transmitter, the other half to a synchronized receiver. As the probe approaches the surface, the reflection from the surface produces a coupling from the transmitting to the receiving fibers. This reflection increases first during the approach, reaches maximum and then decreases. If the probe is flatly touching the surface, the coupling is zero. The distance of the coupling maximum to the surface is independent of the surface reflectivity and largely independent of the surface to probe angle. The DASY5 software reads the reflection during a software approach and looks for the maximum using 2<sup>nd</sup> order curve fitting. The approach is stopped at reaching the maximum.

### Probe Specifications:

<b>Model:</b>	<b>ES3DV3, EX3DV4</b>
<b>Frequency</b>	<b>10MHz — 6.0GHz(EX3DV4)</b>
<b>Range:</b>	<b>10MHz — 4GHz(ES3DV3)</b>
<b>Calibration:</b>	<b>In head and body simulating tissue at Frequencies from 835 up to 5800MHz</b>
<b>Linearity:</b>	<b>± 0.2 dB(30 MHz to 6 GHz) for EX3DV4 ± 0.2 dB(30 MHz to 4 GHz) for ES3DV3</b>
<b>Dynamic Range:</b>	<b>10 mW/kg — 100W/kg</b>
<b>Probe Length:</b>	<b>330 mm</b>
<b>Probe Tip</b>	
<b>Length:</b>	<b>20 mm</b>
<b>Body Diameter:</b>	<b>12 mm</b>
<b>Tip Diameter:</b>	<b>2.5 mm (3.9 mm for ES3DV3)</b>
<b>Tip-Center:</b>	<b>1 mm (2.0mm for ES3DV3)</b>
<b>Application:</b>	<b>SAR Dosimetry Testing Compliance tests of mobile phones Dosimetry in strong gradient fields</b>



Picture C.2 Near-field Probe



Picture C.3 E-field Probe

## C.3 E-field Probe Calibration

Each E-Probe/Probe Amplifier combination has unique calibration parameters. A TEM cell calibration procedure is conducted to determine the proper amplifier settings to enter in the probe parameters. The amplifier settings are determined for a given frequency by subjecting the probe to a known E-field density ( $1 \text{ mW/cm}^2$ ) using an RF Signal generator, TEM cell, and RF Power Meter.

The free space E-field from amplified probe outputs is determined in a test chamber. This calibration can be performed in a TEM cell if the frequency is below 1 GHz and in a waveguide or



other methodologies above 1 GHz for free space. For the free space calibration, the probe is placed in the volumetric center of the cavity and at the proper orientation with the field. The probe is then rotated 360 degrees until the three channels show the maximum reading. The power density readings equates to 1 mW/ cm<sup>2</sup> :

E-field temperature correlation calibration is performed in a flat phantom filled with the appropriate simulated brain tissue. The E-field in the medium correlates with the temperature rise in the dielectric medium. For temperature correlation calibration a RF transparent thermistor-based temperature probe is used in conjunction with the E-field probe.

$$SAR = C \frac{\Delta T}{\Delta t}$$

Where:

$\Delta t$  = Exposure time (30 seconds),

C = Heat capacity of tissue (brain or muscle),

$\Delta T$  = Temperature increase due to RF exposure.

$$SAR = \frac{|E|^2 \cdot \sigma}{\rho}$$

Where:

$\sigma$  = Simulated tissue conductivity,

$\rho$  = Tissue density (kg/m<sup>3</sup>).

## C.4 Other Test Equipment

### C.4.1 Data Acquisition Electronics (DAE)

The data acquisition electronics consist of a highly sensitive electrometer-grade preamplifier with auto-zeroing, a channel and gain-switching multiplexer, a fast 16 bit AD-converter and a command decoder with a control logic unit. Transmission to the measurement server is accomplished through an optical downlink for data and status information, as well as an optical uplink for commands and the clock.

The mechanical probe mounting device includes two different sensor systems for frontal and sideways probe contacts. They are used for mechanical surface detection and probe collision detection.

The input impedance of the DAE is 200 MOhm; the inputs are symmetrical and floating. Common mode rejection is above 80 dB.



**PictureC.4: DAE**

#### C.4.2 Robot

The SPEAG DASY system uses the high precision robots (DASY5: RX160L) type from Stäubli SA (France). For the 6-axis controller system, the robot controller version from Stäubli is used. The Stäubli robot series have many features that are important for our application:

- High precision (repeatability 0.02mm)
- High reliability (industrial design)
- Low maintenance costs (virtually maintenance free due to direct drive gears; no belt drives)
- Jerk-free straight movements (brushless synchron motors; no stepper motors)
- Low ELF interference (motor control fields shielded via the closed metallic construction shields)



Picture C.5 DASY 5

#### C.4.3 Measurement Server

The Measurement server is based on a PC/104 CPU board with CPU (DASY5: 400 MHz, Intel Celeron), chipdisk (DASY5:128MB), RAM (DASY5:128MB). The necessary circuits for communication with the DAE electronic box, as well as the 16 bit AD converter system for optical detection and digital I/O interface are contained on the DASY I/O board, which is directly connected to the PC/104 bus of the CPU board.

The measurement server performs all real-time data evaluation of field measurements and surface detection, controls robot movements and handles safety operation. The PC operating system cannot interfere with these time critical processes. All connections are supervised by a watchdog, and disconnection of any of the cables to the measurement server will automatically disarm the robot and disable all program-controlled robot movements. Furthermore, the measurement server is equipped with an expansion port which is reserved for future applications. Please note that this expansion port does not have a standardized pinout, and therefore only devices provided by SPEAG can be connected. Devices from any other supplier could seriously damage the measurement server.



Picture C.6 Server for DASY 5

#### C.4.4 Device Holder for Phantom

The SAR in the phantom is approximately inversely proportional to the square of the distance between the source and the liquid surface. For a source at 5mm distance, a positioning uncertainty of  $\pm 0.5\text{mm}$  would produce a SAR uncertainty of  $\pm 20\%$ . Accurate device positioning is therefore crucial for accurate and repeatable measurements. The positions in which the devices must be measured are defined by the standards.

The DASY device holder is designed to cope with the different positions given in the standard. It has two scales for device rotation (with respect to the body axis) and device inclination (with respect to the line between the ear reference points). The rotation centers for both scales is the ear reference point (ERP). Thus the device needs no repositioning when changing the angles.

The DASY device holder is constructed of low-loss POM material having the following dielectric

parameters: relative permittivity  $\epsilon = 3$  and loss tangent  $\delta = 0.02$ . The amount of dielectric material has been reduced in the closest vicinity of the device, since measurements have suggested that the influence of the clamp on the test results could thus be lowered.

<Laptop Extension Kit>

The extension is lightweight and made of POM, acrylic glass and foam. It fits easily on the upper part of the Mounting Device in place of the phone positioner. The extension is fully compatible with the Twin-SAM and ELI phantoms.



Picture C.7-1: Device Holder

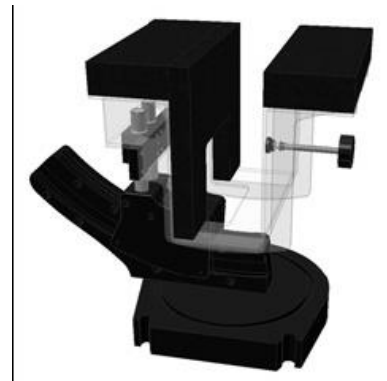

Picture C.7-2: Laptop Extension Kit

#### C.4.5 Phantom

The SAM Twin Phantom V4.0 is constructed of a fiberglass shell integrated in a table. The shape of the shell is based on data from an anatomical study designed to

Represent the 90<sup>th</sup> percentile of the population. The phantom enables the dissymmetric evaluation of SAR for both left and right handed handset usage, as well as body-worn usage using the flat phantom region. Reference markings on the Phantom allow the complete setup of all predefined phantom positions and measurement grids by manually teaching three points in the robot. The shell phantom has a 2mm shell thickness (except the ear region where shell thickness increases to 6 mm).

Shell Thickness:  $2 \pm 0.2$  mm  
Filling Volume: Approx. 25 liters  
Dimensions: 810 x 1000 x 500 mm (H x L x W)  
Available: Special



**Picture C.8: SAM Twin Phantom**

## ANNEX D Position of the wireless device in relation to the phantom

### D.1 General considerations

This standard specifies two handset test positions against the head phantom – the “cheek” position and the “tilt” position.

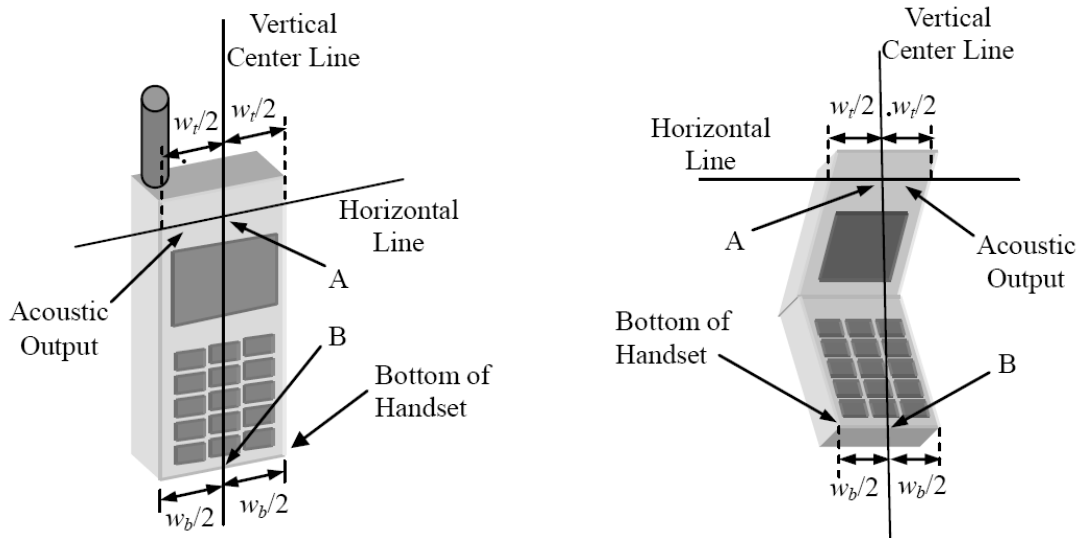

- $w_t$  Width of the handset at the level of the acoustic
- $w_b$  Width of the bottom of the handset
- A Midpoint of the width  $w_t$  of the handset at the level of the acoustic output
- B Midpoint of the width  $w_b$  of the bottom of the handset

Picture D.1-a Typical “fixed” case handset      Picture D.1-b Typical “clam-shell” case handset

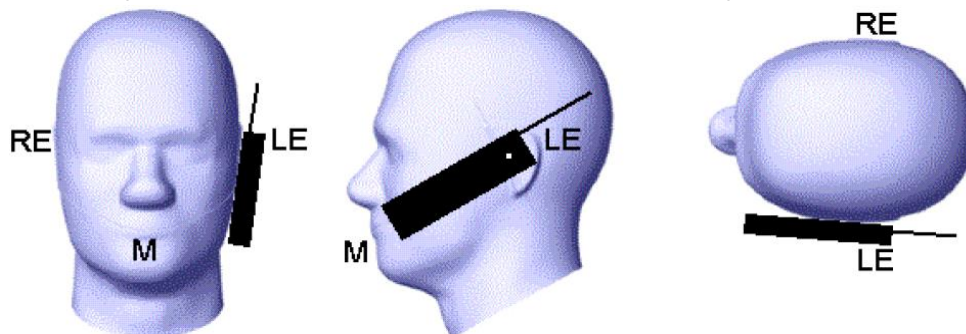

Picture D.2 Cheek position of the wireless device on the left side of SAM

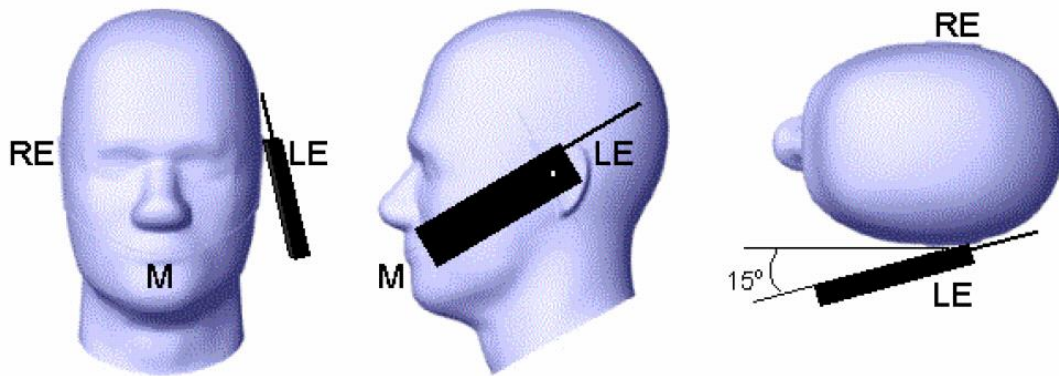

**Picture D.3 Tilt position of the wireless device on the left side of SAM**

## D.2 Body-worn device

A typical example of a body-worn device is a mobile phone, wireless enabled PDA or other battery operated wireless device with the ability to transmit while mounted on a person's body using a carry accessory approved by the wireless device manufacturer.

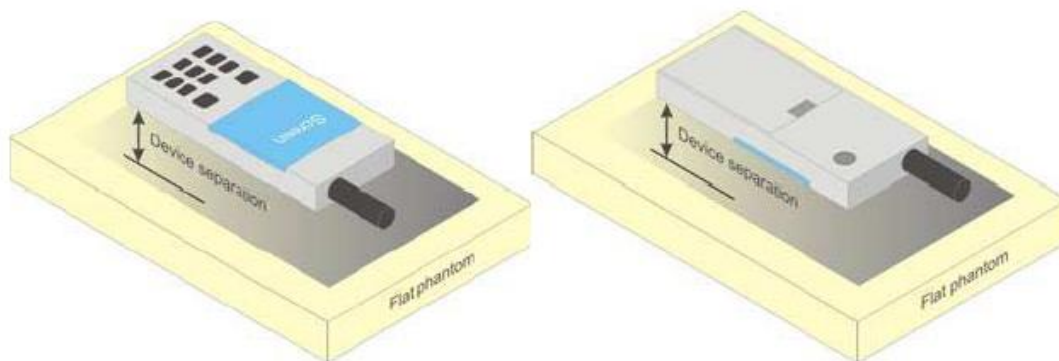

**Picture D.4 Test positions for body-worn devices**

## D.3 Desktop device

A typical example of a desktop device is a wireless enabled desktop computer placed on a table or desk when used.

The DUT shall be positioned at the distance and in the orientation to the phantom that corresponds to the intended use as specified by the manufacturer in the user instructions. For devices that employ an external antenna with variable positions, tests shall be performed for all antenna positions specified. Picture 8.5 show positions for desktop device SAR tests. If the intended use is not specified, the device shall be tested directly against the flat phantom.

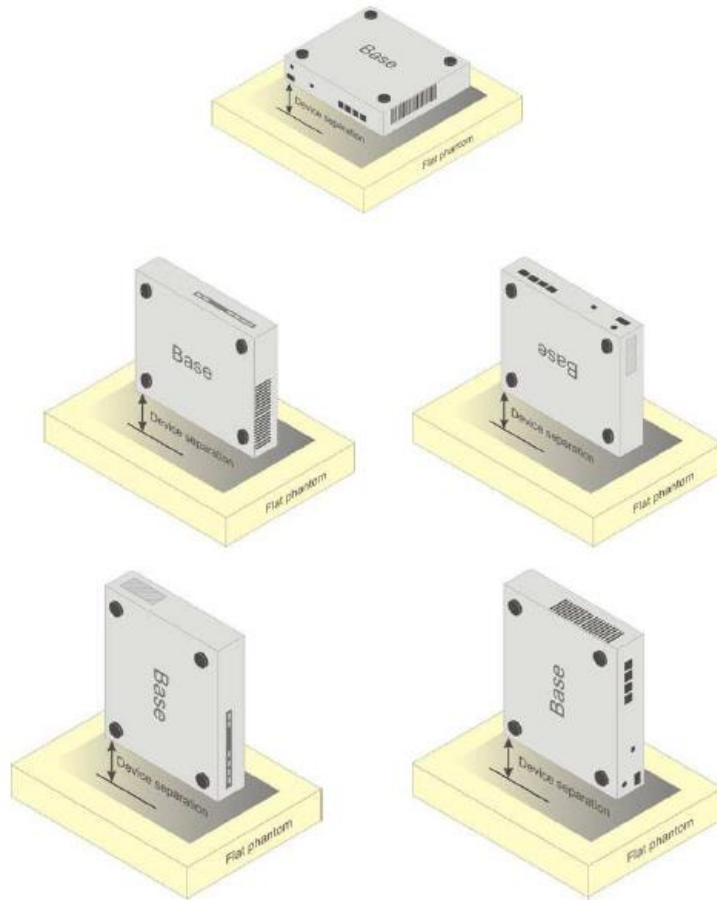

**Picture D.5 Test positions for desktop devices**

#### **D.4 DUT Setup Photos**



**Picture D.6**

## ANNEX E Equivalent Media Recipes

The liquid used for the frequency range of 700-6000 MHz consisted of water, sugar, salt, preventol, glycol monobutyl and Cellulose. The liquid has been previously proven to be suited for worst-case. The Table E.1 shows the detail solution. It's satisfying the latest tissue dielectric parameters requirements proposed by the IEEE 1528 and IEC 62209.

**Table E.1: Composition of the Tissue Equivalent Matter**

Frequency (MHz)	835 Head	835 Body	1900 Head	1900 Body	2450 Head	2450 Body	5800 Head	5800 Body
Ingredients (% by weight)								
Water	41.45	52.5	55.242	69.91	58.79	72.60	65.53	65.53
Sugar	56.0	45.0	\	\	\	\	\	\
Salt	1.45	1.4	0.306	0.13	0.06	0.18	\	\
Preventol	0.1	0.1	\	\	\	\	\	\
Cellulose	1.0	1.0	\	\	\	\	\	\
Glycol Monobutyl	\	\	44.452	29.96	41.15	27.22	\	\
Diethylenglycol monohexylether	\	\	\	\	\	\	17.24	17.24
Triton X-100	\	\	\	\	\	\	17.24	17.24
Dielectric Parameters Target Value	$\epsilon=41.5$ $\sigma=0.90$	$\epsilon=55.2$ $\sigma=0.97$	$\epsilon=40.0$ $\sigma=1.40$	$\epsilon=53.3$ $\sigma=1.52$	$\epsilon=39.2$ $\sigma=1.80$	$\epsilon=52.7$ $\sigma=1.95$	$\epsilon=35.3$ $\sigma=5.27$	$\epsilon=48.2$ $\sigma=6.00$

**Note: There is a little adjustment respectively for 750, 1800, 2600, 5200, 5300, and 5600, based on the recipe of closest frequency in table E.1**



## ANNEX F System Validation

The SAR system must be validated against its performance specifications before it is deployed. When SAR probes, system components or software are changed, upgraded or recalibrated, these must be validated with the SAR system(s) that operates with such components.

**Table F.1: System Validation**

Probe SN.	Liquid name	Validation date	Frequency point	Status (OK or Not)
3633	Head 750MHz	2018-02-06	750 MHz	OK
3633	Head 835MHz	2018-02-06	835 MHz	OK
3633	Head 1800MHz	2018-02-06	1800 MHz	OK
3633	Head 1900MHz	2018-02-08	1900 MHz	OK
3633	Head 2450MHz	2018-02-08	2450 MHz	OK
3633	Head 2550MHz	2018-02-08	2550 MHz	OK
3633	Head 5200MHz	2018-02-07	5200 MHz	OK
3633	Head 5300MHz	2018-02-07	5300 MHz	OK
3633	Head 5600MHz	2018-02-07	5600 MHz	OK
3633	Head 5800MHz	2018-02-07	5800 MHz	OK
3633	Body 750MHz	2018-02-06	750 MHz	OK
3633	Body 835MHz	2018-02-06	835 MHz	OK
3633	Body 1800MHz	2018-02-06	1800 MHz	OK
3633	Body 1900MHz	2018-02-08	1900 MHz	OK
3633	Body 2450MHz	2018-02-08	2450 MHz	OK
3633	Body 2550MHz	2018-02-08	5200 MHz	OK
3633	Body 5200MHz	2018-02-07	5200 MHz	OK
3633	Body 5300MHz	2018-02-07	5300 MHz	OK
3633	Body 5600MHz	2018-02-07	5600 MHz	OK
3633	Body 5800MHz	2018-02-07	5800 MHz	OK

## ANNEX G DAE Calibration Certificate

### DAE4 SN: 786 Calibration Certificate



Client : **CTTL(South Branch)**

Certificate No: **Z17-97239**

#### CALIBRATION CERTIFICATE

Object: **DAE4 - SN: 786**

Calibration Procedure(s): **FF-Z11-002-01  
Calibration Procedure for the Data Acquisition Electronics (DAEx)**

Calibration date: **November 22, 2017**

This calibration Certificate documents the traceability to national standards, which realize the physical units of measurements(SI). The measurements and the uncertainties with confidence probability are given on the following pages and are part of the certificate.

All calibrations have been conducted in the closed laboratory facility: environment temperature(22±3)°C and humidity<70%.

Calibration Equipment used (M&TE critical for calibration)

Primary Standards	ID #	Cal Date(Calibrated by, Certificate No.)	Scheduled Calibration
Process Calibrator 753	1971018	27-Jun-17 (CTTL, No.J17X05859)	June-18

	Name	Function	Signature
Calibrated by:	Yu Zongying	SAR Test Engineer	
Reviewed by:	Lin Hao	SAR Test Engineer	
Approved by:	Qi Dianyuan	SAR Project Leader	

Issued: November 25, 2017

This calibration certificate shall not be reproduced except in full without written approval of the laboratory.



Add: No.51 Xueyuan Road, Haidian District, Beijing, 100191, China  
Tel: +86-10-62304633-2218 Fax: +86-10-62304633-2209  
E-mail: cttl@chinattl.com Http://www.chinattl.cn

**Glossary:**

DAE data acquisition electronics  
Connector angle information used in DASYS system to align probe sensor X to the robot coordinate system.

**Methods Applied and Interpretation of Parameters:**

- *DC Voltage Measurement:* Calibration Factor assessed for use in DASYS system by comparison with a calibrated instrument traceable to national standards. The figure given corresponds to the full scale range of the voltmeter in the respective range.
- *Connector angle:* The angle of the connector is assessed measuring the angle mechanically by a tool inserted. Uncertainty is not required.
- The report provide only calibration results for DAE, it does not contain other performance test results.

