



BNetzA-CAB-02/21-102

TEST REPORT

Test report no.: 1-6098_23-02-04-A



Testing laboratory

cetecom advanced GmbH
Untertuerkheimer Strasse 6 – 10
66117 Saarbruecken / Germany
Phone: + 49 681 5 98 - 0
Fax: + 49 681 5 98 - 9075
Internet: <https://www.cetecomadvanced.com>
e-mail: mail@cetecomadvanced.com

Accredited Testing Laboratory:

The testing laboratory (area of testing) is accredited according to DIN EN ISO/IEC 17025 (2018-03) by the Deutsche Akkreditierungsstelle GmbH (DAkkS).

The accreditation is valid for the scope of testing procedures as stated in the accreditation certificate with the registration number: D-PL-12047-01-00.

ISED Testing Laboratory Recognized Listing Number: DE0001
FCC designation number: DE0002

Applicant

Pepperl+Fuchs SE
Lilienthalstraße 200
68307 Mannheim / GERMANY
Phone: +49 621 776-0
Contact: Volker Zeuner
e-mail: vzeuner@de.pepperl-fuchs.com

Manufacturer

Pepperl+Fuchs SE
Lilienthalstraße 200
68307 Mannheim / GERMANY

Test standard/s

FCC - Title 47 CFR Part 15 FCC - Title 47 of the Code of Federal Regulations; Chapter I; Part 15 - Radio frequency devices

For further applied test standards please refer to section 3 of this test report.

Test Item

Kind of test item: 122 GHz Radar Sensor
Model name: MWL2A
FCC ID: IRE-MWL2A
IC: 7037A-MWL2A
Frequency band: 116 – 123 GHz
Antenna: Integrated antenna
Power supply: 9.0 V to 32.0 V DC by external power supply
Temperature range: -40°C to +70°C

This test report is electronically signed and valid without handwritten signature. For verification of the electronic signatures, the public keys can be requested at the testing laboratory.

Test report authorized:

Frank Heussner
Lab Manager
Radio Labs

Test performed:

Stephan Thiel
Testing Manager
Radio Labs

1 Table of contents

1	Table of contents.....	2
2	General information.....	3
2.1	Notes and disclaimer.....	3
2.2	Application details.....	3
2.3	Test laboratories sub-contracted.....	3
3	Test standard/s, references and accreditations.....	4
4	Reporting statements of conformity – decision rule.....	5
5	Test environment.....	5
6	Test item.....	6
6.1	General description.....	6
6.2	Additional information.....	7
7	Description of the test setup.....	7
7.1	Shielded semi anechoic chamber.....	8
7.2	Shielded fully anechoic chamber.....	10
7.3	Radiated measurements > 18 GHz.....	12
7.4	Radiated measurements > 50 GHz.....	12
7.5	Radiated power measurements using RF detector according to ANSI C63.10-2013.....	14
7.6	AC conducted.....	15
8	Sequence of testing.....	16
8.1	Sequence of testing radiated spurious 9 kHz to 30 MHz.....	16
8.2	Sequence of testing radiated spurious 30 MHz to 1 GHz.....	17
8.3	Sequence of testing radiated spurious 1 GHz to 18 GHz.....	18
8.4	Sequence of testing radiated spurious above 18 GHz.....	19
8.5	Sequence of testing radiated spurious above 50 GHz with external mixers.....	20
9	Measurement uncertainty.....	21
10	Summary of measurement results.....	22
11	Additional comments.....	23
12	Measurement results.....	24
12.1	Occupied bandwidth (6 dB Bandwidth).....	24
12.2	Maximum E.I.R.P.....	26
12.3	Spurious emissions radiated.....	30
12.3.1	Stop mode spurious emissions radiated.....	33
12.3.2	Normal mode spurious emissions radiated.....	70
12.4	Frequency Stability.....	80
12.5	Conducted emissions < 30 MHz (AC power line).....	82
13	Glossary.....	85
14	Document history.....	86

2 General information

2.1 Notes and disclaimer

The test results of this test report relate exclusively to the test item specified in this test report. cetecom advanced GmbH does not assume responsibility for any conclusions and generalizations drawn from the test results with regard to other specimens or samples of the type of the equipment represented by the test item.

The test report may only be reproduced or published in full. Reproduction or publication of extracts from the report requires the prior written approval of cetecom advanced GmbH.

The testing service provided by cetecom advanced GmbH has been rendered under the current "General Terms and Conditions for cetecom advanced GmbH".

cetecom advanced GmbH will not be liable for any loss or damage resulting from false, inaccurate, inappropriate or incomplete product information provided by the customer.

Under no circumstances does the cetecom advanced GmbH test report include any endorsement or warranty regarding the functionality, quality or performance of any other product or service provided.

Under no circumstances does the cetecom advanced GmbH test report include or imply any product or service warranties from cetecom advanced GmbH, including, without limitation, any implied warranties of merchantability, fitness for purpose, or non-infringement, all of which are expressly disclaimed by cetecom advanced GmbH.

All rights and remedies regarding vendor's products and services for which cetecom advanced GmbH has prepared this test report shall be provided by the party offering such products or services and not by cetecom advanced GmbH.

In no case this test report can be considered as a Letter of Approval.

This test report is electronically signed and valid without handwritten signature. For verification of the electronic signatures, the public keys can be requested at the testing laboratory.

This test report replaces the test report with the number 1-6098/23-02-04 and dated 2023-11-09.

2.2 Application details

Date of receipt of order:	2023-05-11
Date of receipt of test item:	2022-12-05
Start of test:*	2023-08-28
End of test:*	2023-10-27
Person(s) present during the test:	Volker Zeuner (2023-10-25)

*Date of each measurement, if not shown in the plot, can be requested. Dates are stored in the measurement software.

2.3 Test laboratories sub-contracted

None

3 Test standard/s, references and accreditations

Test standard	Date	Description
FCC - Title 47 CFR Part 15		FCC - Title 47 of the Code of Federal Regulations; Chapter I; Part 15 - Radio frequency devices
RSS - 210 Issue 10*	12-2019	Spectrum Management and Telecommunications Radio Standards Specification - Licence-Exempt Radio Apparatus: Category I Equipment
RSS - Gen Issue 5 incl. Amendment 1 & 2*	02-2021	Spectrum Management and Telecommunications Radio Standards Specification - General Requirements for Compliance of Radio Apparatus

* For information only. Frequency band of operation is not subject to RSS-210 Issue 10.

Guidance	Version	Description
ANSI C63.4-2014	-/-	American National Standard for Methods of Measurement of Radio-Noise Emissions from Low-Voltage Electrical and Electronic Equipment in the Range of 9 kHz to 40 GHz
ANSI C63.10-2013	-/-	American National Standard of Procedures for Compliance Testing of Unlicensed Wireless Devices

4 Reporting statements of conformity – decision rule

Only the measured values related to their corresponding limits will be used to decide whether the equipment under test meets the requirements of the test standards listed in chapter 3. The measurement uncertainty is mentioned in this test report, see chapter 9, but is not taken into account - neither to the limits nor to the measurement results. Measurement results with a smaller margin to the corresponding limits than the measurement uncertainty have a potential risk of more than 5% that the decision might be wrong.

measured value, measurement uncertainty, verdict

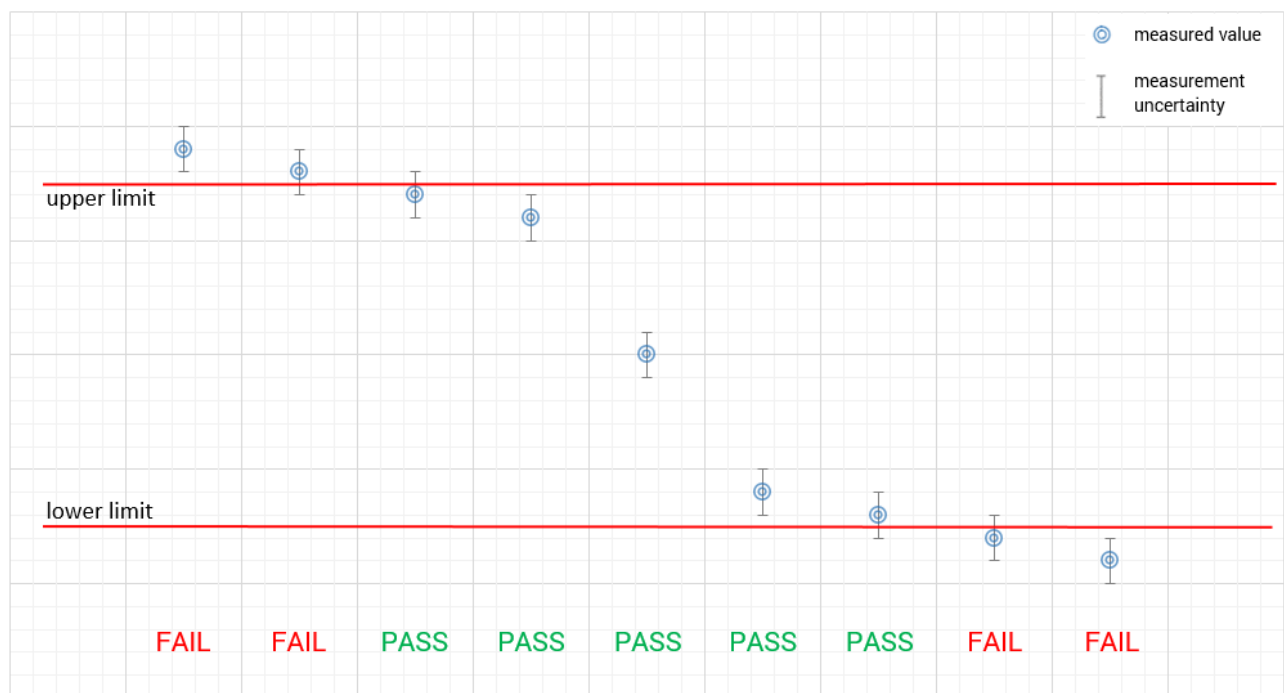

5 Test environment

Temperature	: T_{nom} T_{max} T_{min}	+22 °C during room temperature tests +50°C during high temperature tests -20°C during low temperature tests
Relative humidity content	:	49 %
Barometric pressure	:	990 hPa to 1010 hPa
Power supply	: V_{nom} V_{max} V_{min}	24.0-V DC by external power supply 32.0 V DC 9.0 V DC

6 Test item

6.1 General description

Kind of test item	:	122 GHz Radar Sensor
Model name	:	MWL2A
HMN	:	-/-
PMN	:	MWL2A
HVIN	:	MWL2A
FVIN	:	-/-
S/N serial number	:	<ul style="list-style-type: none"> • EUT1: Engineering sample, "CTC#4" (normal mode), 4 000 000 9 638 939 • EUT2: Engineering sample, "CTC#10" (normal mode & stop modes 100%), 4 000 014 3 854 773 • EUT3: Engineering sample, "Test-Sample CW #1" (stop modes 20%), 4 000 014 3 855 702
Hardware status	:	05-8132F
Software status	:	n/a
Firmware status	:	<ul style="list-style-type: none"> • EUT1 & EUT2: 18-34347E • EUT3: 18-34347F (Note 1)
Frequency band	:	116 – 123 GHz
Type of modulation	:	FMCW
Antenna	:	Integrated antenna
Power supply	:	9.0 V to 32.0 V DC by external power supply
Temperature range	:	-40°C to +70°C

Note 1: with extension of CAN object 0x4303:11, send CW only; for realization of stop modes

Details of the product designation of the DUT:

- Part number: 70134318-100000
- Type code: MWC25M-L2M-B16-V15
- Interface type: CANopen
- Connector type: M12, 5 pins
- Pigtail/cable type: no cable/pigtail

General type code of all type variants:

- MWC25M-L2M-B*

6.2 Additional information

The content of the following annexes is defined in the QA. It may be that not all of the listed annexes are necessary for this report, thus some values in between may be missing.

Test setup and EUT photos are included in test report:	1-6098/23-02-01_AnnexA 1-6098/23-02-01_AnnexB 1-6098/23-02-01_AnnexD
Measurement results:	1-6098_23-02-04_Annex_MR1

7 Description of the test setup

Typically, the calibrations of the test apparatus are commissioned to and performed by an accredited calibration laboratory. The calibration intervals are determined in accordance with the DIN EN ISO/IEC 17025. In addition to the external calibrations, the laboratory executes comparison measurements with other calibrated test systems or effective verifications. Weekly chamber inspections and range calibrations are performed. Where possible, RF generating and signaling equipment as well as measuring receivers and analyzers are connected to an external high-precision 10 MHz reference (GPS-based or rubidium frequency standard).

In order to simplify the identification of the equipment used at some special tests, some items of test equipment and ancillaries can be provided with an identifier or number in the equipment list below (Lab/Item).

Agenda: Kind of Calibration

k	calibration / calibrated	EK	limited calibration
ne	not required (k, ev, izw, zw not required)	zw	cyclical maintenance (external cyclical maintenance)
ev	periodic self verification	izw	internal cyclical maintenance
Ve	long-term stability recognized	g	blocked for accredited testing
vlk!	Attention: extended calibration interval	*	next calibration ordered / currently in progress
NK!	Attention: not calibrated		

7.1 Shielded semi anechoic chamber

The radiated measurements are performed in vertical and horizontal plane in the frequency range from 30 MHz to 1 GHz in semi-anechoic chambers. The EUT is positioned on a non-conductive support with a height of 0.80 m above a conductive ground plane that covers the whole chamber. The receiving antennas are conform to specifications ANSI C63. These antennas can be moved over the height range between 1.0 m and 4.0 m in order to search for maximum field strength emitted from EUT. The measurement distances between EUT and receiving antennas are indicated in the test setups for the various frequency ranges. For each measurement, the EUT is rotated in all three axes until the maximum field strength is received. The wanted and unwanted emissions are received by spectrum analyzers where the detector modes and resolution bandwidths over various frequency ranges are set according to requirement ANSI C63.

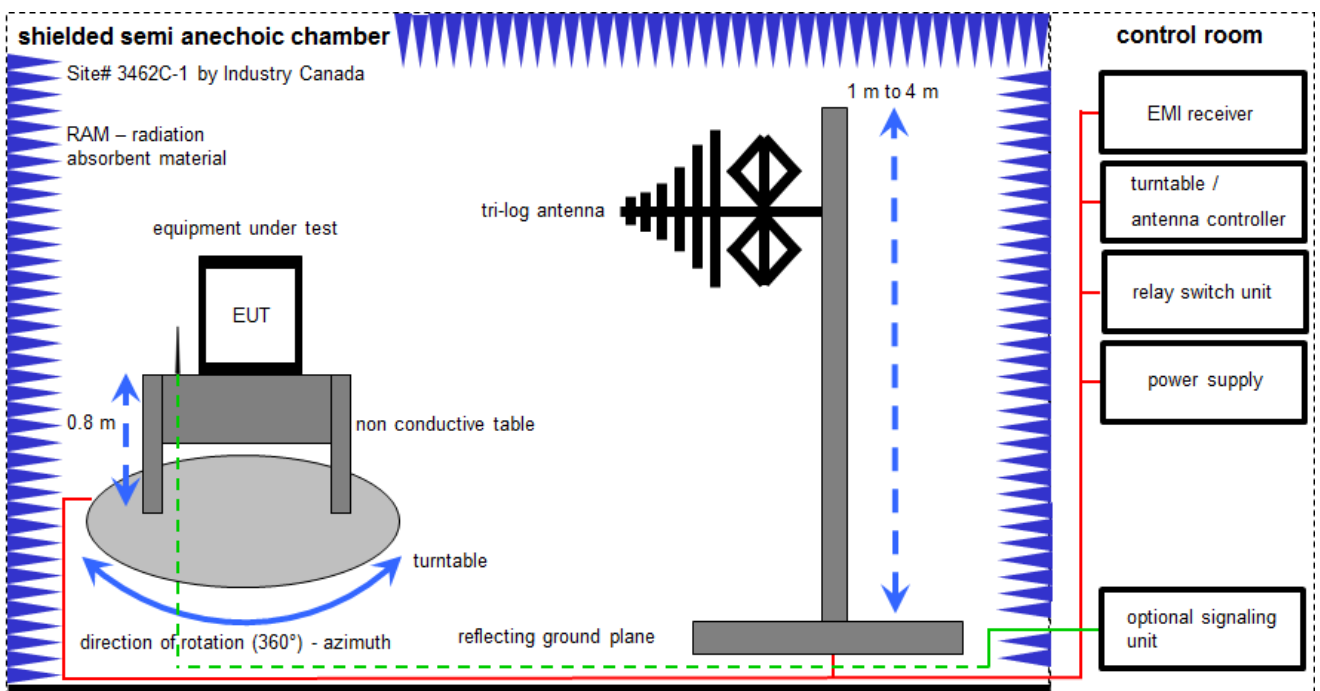

Measurement distance: tri-log antenna 10 meter

$$FS = UR + CL + AF$$

(FS-field strength; UR-voltage at the receiver; CL-loss of the cable; AF-antenna factor)

Example calculation:

$$FS [dB\mu V/m] = 12.35 [dB\mu V/m] + 1.90 [dB] + 16.80 [dB/m] = 31.05 [dB\mu V/m] (35.69 \mu V/m)$$

Equipment table:

No.	Lab / Item	Equipment	Type	Manufacturer	Serial No.	INV. No.	Kind of Calibration	Last Calibration	Next Calibration
1	n. a.	Switch-Unit	3488A	HP	2719A14505	300000368	ev	-/-	-/-
2	n. a.	DC power supply, 60Vdc, 50A, 1200 W	6032A	HP	2920A04466	300000580	ne	-/-	-/-
3	n. a.	Semi anechoic chamber	300023	MWB AG	-/-	300000551	ne	-/-	-/-
4	n. a.	Antenna Tower	Model 2175	ETS-Lindgren	64762	300003745	izw	-/-	-/-
5	n. a.	Positioning Controller	Model 2090	ETS-Lindgren	64672	300003746	izw	-/-	-/-
6	n. a.	Turntable Interface-Box	Model 105637	ETS-Lindgren	44583	300003747	izw	-/-	-/-
7	n. a.	Spectrum-Analyzer	FSU26	R&S	200809	300003874	k	09.12.2022	31.12.2023
8	n. a.	EMI Test Receiver	ESR3	Rohde & Schwarz	102587	300005771	k	09.12.2022	31.12.2023
9	n. a.	PC	TecLine	F+W	-/-	300003303	ne	-/-	-/-
10	n. a.	TRILOG Broadband Test-Antenna 30 MHz - 3 GHz	VULB9163	Schwarzbeck Mess - Elektronik	295	300003787	vIKI!	12.04.2021 23.05.2023	31.05.2025

7.2 Shielded fully anechoic chamber

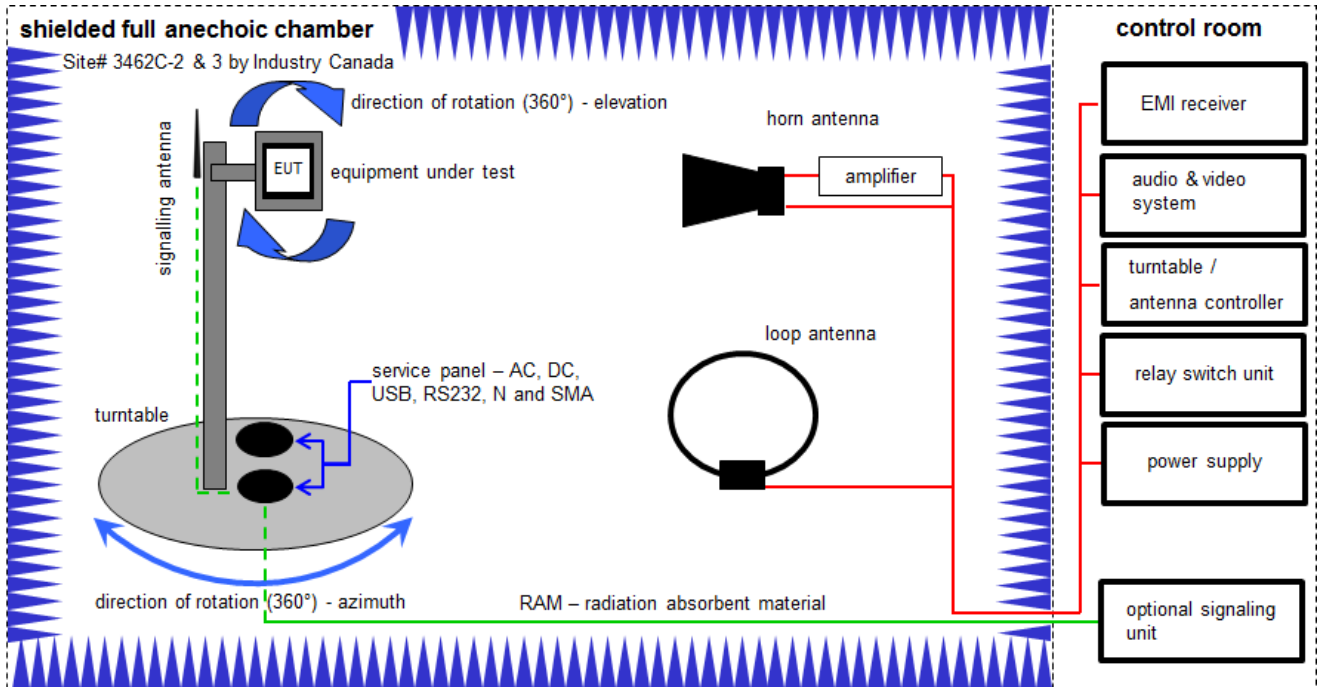

Measurement distance: horn antenna 3 meter; loop antenna 3 meter

$$FS = UR + CA + AF$$

(FS-field strength; UR-voltage at the receiver; CA-loss of the signal path; AF-antenna factor)

Example calculation:

$$FS [dB\mu V/m] = 40.0 [dB\mu V/m] + (-35.8) [dB] + 32.9 [dB/m] = 37.1 [dB\mu V/m] (71.61 \mu V/m)$$

$$OP = AV + D - G + CA$$

(OP-radiated output power; AV-analyzer value; D-free field attenuation of measurement distance; G-antenna gain+amplifier gain; CA-loss signal path)

Example calculation:

$$OP [dBm] = -65.0 [dBm] + 50 [dB] - 20 [dBi] + 5 [dB] = -30 [dBm] (1 \mu W)$$

Equipment table:

No.	Lab / Item	Equipment	Type	Manufacturer	Serial No.	INV. No.	Kind of Calibration	Last Calibration	Next Calibration
1	n. a.	DC power supply, 60Vdc, 50A, 1200 W	6032A	HP	2818A03450	300001040	vIKI!	09.12.2020	08.12.2023
2	n. a.	Anechoic chamber	FAC 3/5m	MWB / TDK	87400/02	300000996	ev	-/-	-/-
3	n. a.	Switch / Control Unit	3488A	HP	*	300000199	ne	-/-	-/-
4	n. a.	Double-Ridged Waveguide Horn Antenna 1-18.0GHz	3115	EMCO	8812-3089	300000307	vIKI!	11.02.2022	29.02.2024
5	n. a.	Variable isolating transformer	MPL IEC625 Bus Variable isolating transformer	Erfi	91350	300001155	ne	-/-	-/-
6	n. a.	EMI Test Receiver 20Hz- 26,5GHz	ESU26	R&S	100037	300003555	k	07.12.2022	31.12.2023
7	n. a.	Broadband Amplifier 0.5-18 GHz	CBLU5184540	CERNEX	22049	300004481	ev	-/-	-/-
8	n. a.	4U RF Switch Platform	L4491A	Agilent Technologies	MY50000037	300004509	ne	-/-	-/-
9	n. a.	NEXIO EMV-Software	BAT EMC V2022.0.22.0	Nexio		300004682	ne	-/-	-/-
10	n. a.	Highpass Filter	WHKX7.0/18G-8SS	Wainwright	19	300003790	ne	-/-	-/-
11	n. a.	MXG Microwave Analog Signal Generator	N5183A	Agilent Technologies	MY47420220	300003813	vIKI!	07.12.2022	31.12.2025
12	n. a.	RF-Amplifier	AMF-6F06001800-30-10P-R	NARDA-MITEQ Inc	2011572	300005241	ev	-/-	-/-
13	n. a.	PC	ExOne	F+W	-/-	300004703	ne	-/-	-/-
14	n. a.	Active Loop Antenna 9 kHz to 30 MHz	6502	EMCO/2	8905-2342	300000256	vIKI!	17.06.2021 19.07.2023	31.07.2025

7.3 Radiated measurements > 18 GHz

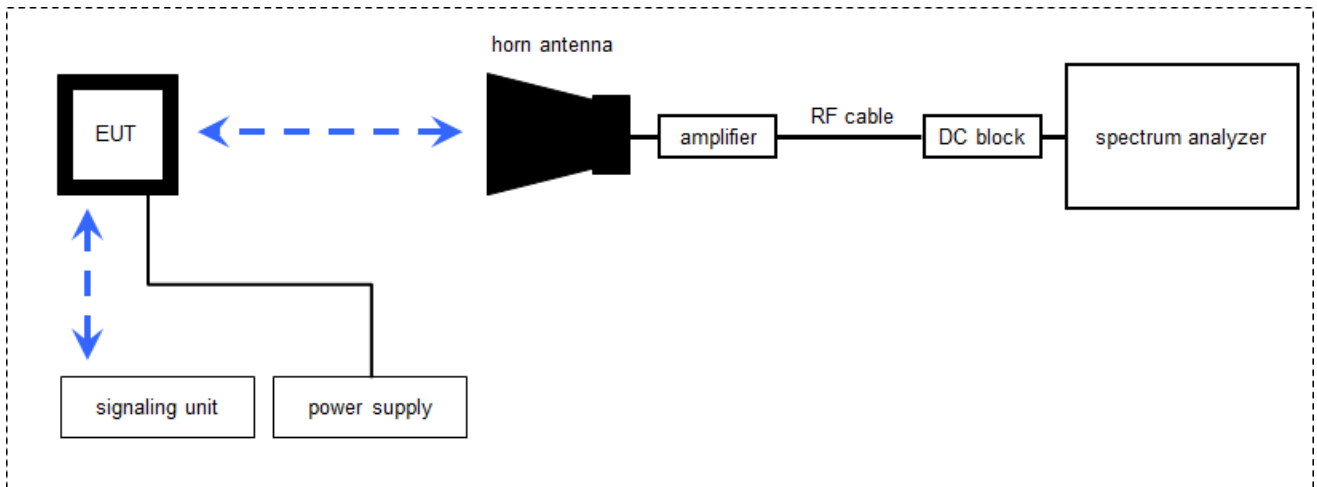

7.4 Radiated measurements > 50 GHz

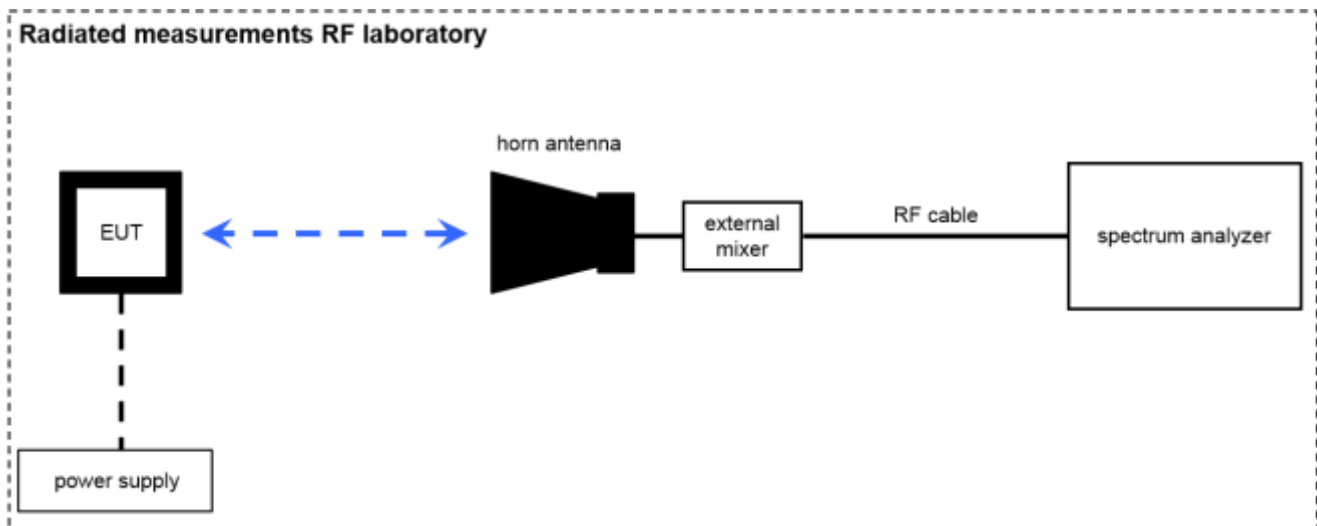

$$FS = UR + CA + AF$$

(FS-field strength; UR-voltage at the receiver; CA-loss signal path & distance correction; AF-antenna factor)

Example calculation:

$$FS [dB\mu V/m] = 40.0 [dB\mu V/m] + (-60.1) [dB] + 36.74 [dB/m] = 16.64 [dB\mu V/m] (6.79 \mu V/m)$$

$$OP = AV + D - G + CA$$

(OP-radiated output power; AV-analyzer value; D-free field attenuation of measurement distance; G-antenna gain+amplifier gain; CA-loss signal path)

Example calculation:

$$OP [dBm] = -59.0 [dBm] + 44.0 [dB] - 20.0 [dBi] + 5.0 [dB] = -30 [dBm] (1 \mu W)$$

Note: conversion loss of mixer is already included in analyzer value.

Equipment table:

No.	Lab / Item	Equipment	Type	Manufacturer	Serial No.	INV. No.	Kind of Calibration	Last Calibration	Next Calibration
10	17a	Horn Antenna 18,0-40,0 GHz	LHAF180	Microw.Devel	39180-103-021	300001747	vKI!	17.01.2022	31.01.2024
12	A027	Std. Gain Horn Antenna 18.0-26.5 GHz	638	Narda	01096	300000486	vKI!	17.01.2022	31.01.2024
14	A031	Std. Gain Horn Antenna 26.5-40.0 GHz	V637	Narda	82-16	300000510	vKI!	17.01.2022	31.01.2024
15	n. a.	Std. Gain Horn Antenna 33.0-50.1 GHz	2324-20	Flann	57	400000683	ne	-/-	-/-
16	n. a.	Broadband LNA 18-50 GHz	CBL18503070PN	CERNEX	25240	300004948	ev	09.03.2022	08.03.2024
17	A032	Std. Gain Horn Antenna 114-173 GHz	2924-20	Flann	*	300001999	ne	-/-	-/-
24	A025	Std. Gain Horn Antenna 49.9-75.8 GHz	2524-20	Flann	*	300001983	ne	-/-	-/-
25	A027	Std. Gain Horn Antenna 73.8-112 GHz	2724-20	Flann	*	300001988	ne	-/-	-/-
26	A029	Std. Gain Horn Antenna 92.3-140 GHz	2824-20	Flann	*	300001993	ne	-/-	-/-
40	A033	Std. Gain Horn Antenna 145-220 GHz	3024-20	Flann	*	300002000	ne	-/-	-/-
41	A036	Std. Gain Horn Antenna 60-90 GHz	COR 60_90	Thomson CSF		300000814	ev	-/-	-/-
42	n. a.	Harmonic Mixer 3-Port, 110-170 GHz	FS-Z170	Radiometer Physics GmbH	100014	300004156	k	21.07.2023	31.07.2024
43	n. a.	Harmonic Mixer 3-Port, 140-220 GHz	SAM-220	Radiometer Physics GmbH	200001	300004157	k	02.08.2023	31.08.2024
44	n. a.	Harmonic Mixer 3-Port, 220-325 GHz	SAM-325	Radiometer Physics GmbH	100002	300004158	k	02.08.2023	31.08.2024
45	n. a.	Harmonic Mixer 3-Port, 60-90 GHz	FS-Z90	R&S	101555	300004691	k	25.08.2023	31.08.2024
46	n. a.	Std. Gain Horn Antenna 217-330 GHz	32240-20	Flann	233278	300004960	ne	-/-	-/-
47	n. a.	Harmonic Mixer 3-Port, 75-110 GHz	FS-Z110	Rohde & Schwarz	101411	300004959	k	21.07.2023	31.07.2024
48	n. a.	Harmonic Mixer 3-port, 90-140 GHz	FS-Z140	Rohde & Schwarz	101119	300005581	k	03.08.2023	31.08.2024
49	n. a.	Harmonic Mixer 3-Port, 50-75 GHz	FS-Z75	Rohde & Schwarz	101578	300005788	k	19.07.2023	31.07.2024
50	n. a.	Harmonic Mixer 3-Port, 325-500GHz	FS-Z500	Rohde & Schwarz	101016	300006096	k	11.08.2023	31.08.2024
51	n. a.	Standard Gain Horn 325-500 GHz	570240-20 1785-2a	Flann Microwave	273569	300006097	ev	-/-	-/-
52	n. a.	Power supply	N5767A	Agilent Technologies	US14J1569P	300004851	vKI!	08.12.2020	31.12.2023
53	n. a.	Temperature Test Chamber	T-40/50	CTS GmbH	064023	300003540	ev	09.05.2022	31.05.2024
54	n. a.	Signal- and Spectrum Analyzer 2 Hz - 50 GHz	FSW50	Rohde&Schwarz	101332	300005935	k	23.03.2023	31.03.2024
55	n. a.	Signal- and Spectrum Analyzer 2 Hz - 50 GHz	FSW50	Rohde&Schwarz	101560	300006179	k	04.04.2023	30.04.2024

7.5 Radiated power measurements using RF detector according to ANSI C63.10-2013

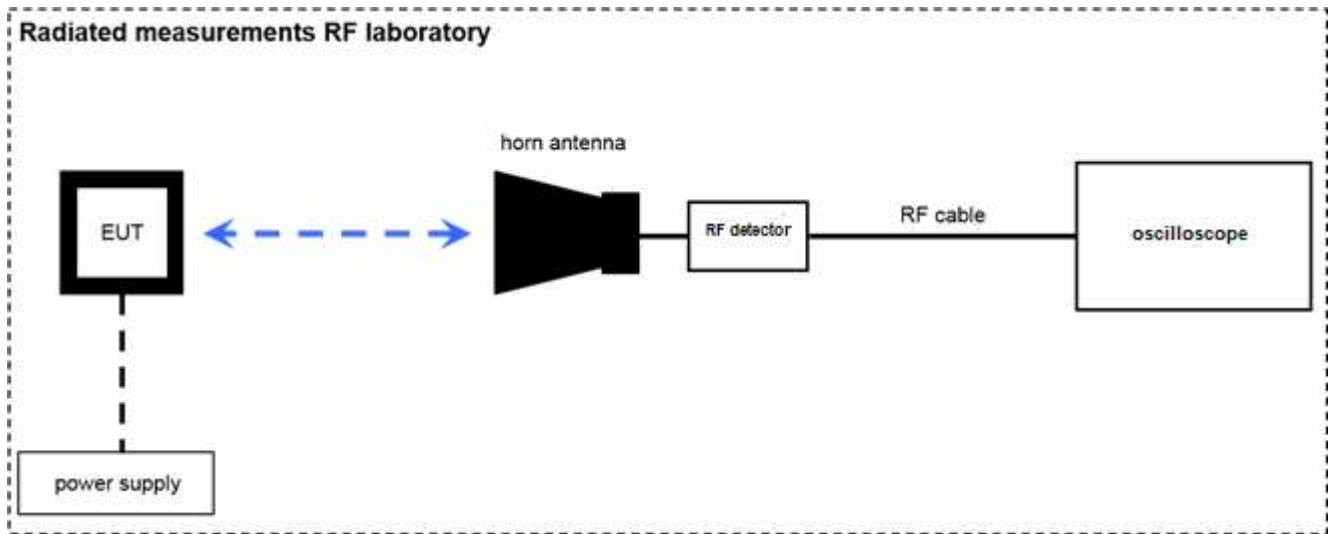

Note: EUT is replaced by reference source for substitution measurement

Equipment table:

No.	Lab / Item	Equipment	Type	Manufacturer	Serial No.	INV. No.	Kind of Calibration	Last Calibration	Next Calibration
1	A032	Std. Gain Horn Antenna 114-173 GHz	2924-20	Flann	*	300001999	ne	-/-	-/-
2	A038	Std. Gain Horn Antenna 90-140 GHz	COR 90_140	Thomson CSF		300000799	ev	-/-	-/-
3	n. a.	Oscilloscope	DPO5054	Tektronix	C010174	300004169	k	07.12.2021	31.12.2023
4	n. a.	SG Extension Module 110 - 170 GHz	E8257DV06	VDI	US53250018	300005540	ev	-/-	-/-
5	n. a.	F-Band Positive Amplitude Detector	SFD-903144-08SF-P1	Sage Millimeter Inc.	07354-1	300006119	ev	-/-	-/-
6	n. a.	Waveguide Amplifier 90-140 GHz	VDI-WR8.0AMP	VDI	1-13	300006234	ev	-/-	-/-
7	n. a.	Signal Generator 100 kHz - 40 GHz	SMB100A	Rohde & Schwarz	183320	300006330	k	21.06.2022	20.06.2025

7.6 AC conducted

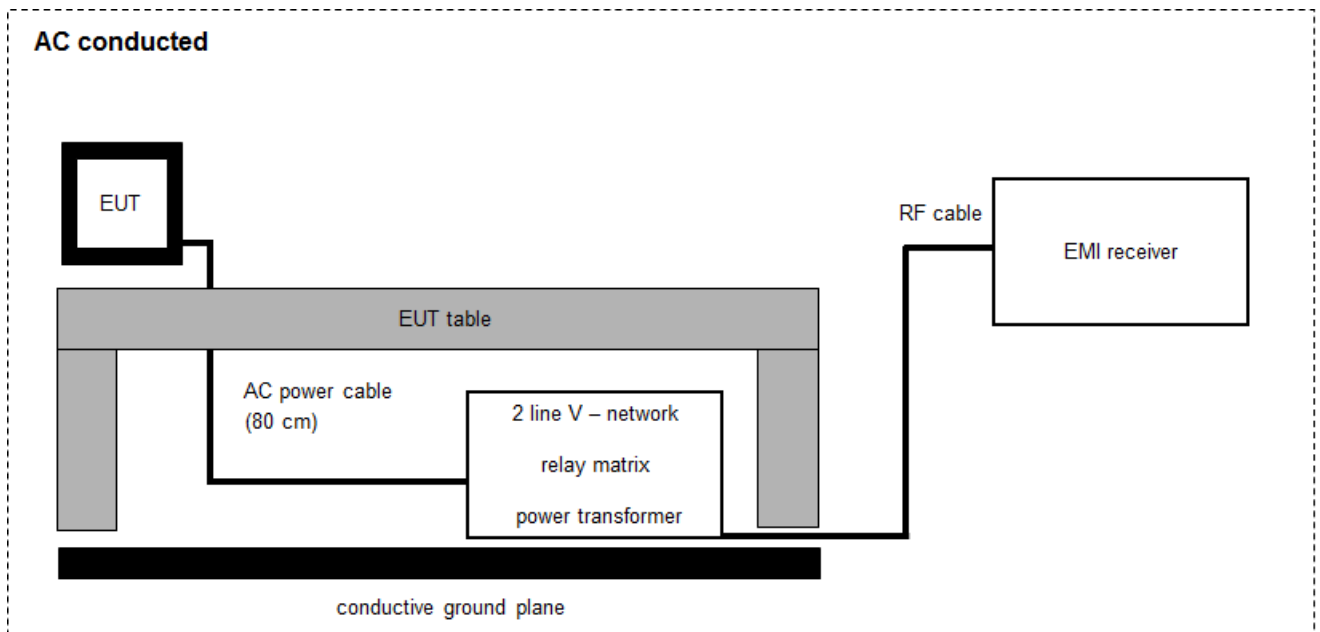

$$FS = UR + CF + VC$$

(FS-field strength; UR-voltage at the receiver; CR-loss of the cable and filter; VC-correction factor of the ISN)

Example calculation:

$$FS [dB\mu V/m] = 37.62 [dB\mu V/m] + 9.90 [dB] + 0.23 [dB] = 47.75 [dB\mu V/m] (244.06 \mu V/m)$$

Equipment table:

No.	Lab / Item	Equipment	Type	Manufacturer	Serial No.	INV. No.	Kind of Calibration	Last Calibration	Next Calibration
1	n. a.	Two-line V-Network (LISN) 9 kHz to 30 MHz	ESH3-Z5	R&S	892475/017	300002209	vIKI!	14.12.2021	31.12.2023
2	n. a.	Analyzer-Reference-System (Harmonics and Flicker)	ARS 16/1	SPS	A3509 07/0 0205	300003314	vIKI!	29.12.2021	31.12.2023
3	n. a.	Hochpass 150 kHz	EZ-25	R&S	100010	300003798	ev	-/-	-/-
4	n. a.	PC	TecLine	F+W	-/-	300003532	ne	-/-	-/-
5	n. a.	EMI Test Receiver 3.6 GHz	ESR3	Rohde & Schwarz	102981	300006318	k	09.12.2022	31.12.2023

8 Sequence of testing

8.1 Sequence of testing radiated spurious 9 kHz to 30 MHz

Setup

- The equipment is set up to simulate normal operation mode as described in the user manual or defined by the manufacturer.
- If the EUT is a tabletop system, it is placed on a table with 0.8 m height.
- If the EUT is a floor standing device, it is placed directly on the turn table.
- Auxiliary equipment and cables are positioned to simulate normal operation conditions as described in ANSI C 63.4.
- The AC power port of the EUT (if available) is connected to a power outlet below the turntable.
- Measurement distance is 3 m (see ANSI C 63.4) – see test details.
- EUT is set into operation.

Premeasurement*

- The turntable rotates from 0° to 315° using 45° steps.
- The antenna height is 1 m.
- At each turntable position the analyzer sweeps with positive-peak detector to find the maximum of all emissions.

Final measurement

- Identified emissions during the pre-measurement are maximized by the software by rotating the turntable from 0° to 360°.
- Loop antenna is rotated about its vertical axis for maximum response at each azimuth about the EUT. (For certain applications, the loop antenna plane may also need to be positioned horizontally at the specified distance from the EUT)
- The final measurement is done in the position (turntable and elevation) causing the highest emissions with quasi-peak (as described in ANSI C 63.4).
- Final levels, frequency, measuring time, bandwidth, turntable position, correction factor, margin to the limit and limit will be recorded. A plot with the graph of the premeasurement and the limit is stored.

*Note: The sequence will be repeated three times with different EUT orientations.

8.2 Sequence of testing radiated spurious 30 MHz to 1 GHz

Setup

- The equipment is set up to simulate normal operation mode as described in the user manual or defined by the manufacturer.
- If the EUT is a tabletop system, a table with 0.8 m height is used, which is placed on the ground plane.
- If the EUT is a floor standing device, it is placed on the ground plane with insulation between both.
- Auxiliary equipment and cables are positioned to simulate normal operation conditions as described in ANSI C 63.4.
- The AC power port of the EUT (if available) is connected to a power outlet below the turntable.
- Measurement distance is 10 m or 3 m (see ANSI C 63.4) – see test details.
- EUT is set into operation.

Premeasurement

- The turntable rotates from 0° to 315° using 45° steps.
- The antenna is polarized vertical and horizontal.
- The antenna height changes from 1 m to 3 m.
- At each turntable position, antenna polarization and height the analyzer sweeps three times in peak to find the maximum of all emissions.

Final measurement

- The final measurement is performed for at least six highest peaks according to the requirements of the ANSI C63.4.
- Based on antenna and turntable positions at which the peak values are measured the software maximize the peaks by changing turntable position $\pm 45^\circ$ and antenna height between 1 and 4 m.
- The final measurement is done with quasi-peak detector (as described in ANSI C 63.4).
- Final levels, frequency, measuring time, bandwidth, antenna height, antenna polarization, turntable angle, correction factor, margin to the limit and limit are recorded. A plot with the graph of the premeasurement with marked maximum final results and the limit is stored.

8.3 Sequence of testing radiated spurious 1 GHz to 18 GHz

Setup

- The equipment is set up to simulate normal operation mode as described in the user manual or defined by the manufacturer.
- If the EUT is a tabletop system, a 2-axis positioner with 1.5 m height is used.
- If the EUT is a floor standing device, it is placed directly on the turn table.
- Auxiliary equipment and cables are positioned to simulate normal operation conditions as described in ANSI C 63.4.
- The AC power port of the EUT (if available) is connected to a power outlet below the turntable.
- Measurement distance is 3 m (see ANSI C 63.4) – see test details.
- EUT is set into operation.

Premeasurement

- The turntable rotates from 0° to 315° using 45° steps.
- The antenna is polarized vertical and horizontal.
- The antenna height is 1.5 m.
- At each turntable position and antenna polarization the analyzer sweeps with positive peak detector to find the maximum of all emissions.

Final measurement

- The final measurement is performed for at least six highest peaks according to the requirements of the ANSI C63.4.
- Based on antenna and turntable positions at which the peak values are measured the software maximizes the peaks by rotating the turntable from 0° to 360°. This measurement is repeated for different EUT-table positions (0° to 150° in 30°-steps) and for both antenna polarizations.
- The final measurement is done in the position (turntable, EUT-table and antenna polarization) causing the highest emissions with Peak and RMS detector (as described in ANSI C 63.4).
- Final levels, frequency, measuring time, bandwidth, turntable position, EUT-table position, antenna polarization, correction factor, margin to the limit and limit are recorded. A plot with the graph of the premeasurement with marked maximum final results and the limit is stored.

8.4 Sequence of testing radiated spurious above 18 GHz

Setup

- The equipment is set up to simulate normal operation mode as described in the user manual or defined by the manufacturer.
- Auxiliary equipment and cables are positioned to simulate normal operation conditions as described in ANSI C 63.4.
- The AC power port of the EUT (if available) is connected to a power outlet.
- The measurement distance is as appropriate (e.g. 0.5 m).
- The EUT is set into operation.

Premeasurement

- The test antenna is handheld and moved carefully over the EUT to cover the EUT's whole sphere and different polarizations of the antenna.

Final measurement

- The final measurement is performed at the position and antenna orientation causing the highest emissions with Peak and RMS detector (as described in ANSI C 63.4).
- Final levels, frequency, measuring time, bandwidth, correction factor, margin to the limit and limit are recorded. A plot with the graph of the premeasurement and the limit is stored.

8.5 Sequence of testing radiated spurious above 50 GHz with external mixers

Setup

- The equipment is set up to simulate normal operation mode as described in the user manual or defined by the manufacturer.
- Auxiliary equipment and cables are positioned to simulate normal operation conditions as described in ANSI C 63.4.
- The AC power port of the EUT (if available) is connected to a power outlet.
- The measurement distance is as appropriate for far field (e.g. 0.25 m).
- The EUT is set into operation.

Premeasurement

- The test antenna with external mixer is handheld and moved carefully over the EUT to cover the EUT's whole sphere and different polarizations of the antenna.
- Caution is taken to reduce the possible overloading of the external mixer.

Final measurement

- The final measurement is performed at the position and antenna orientation causing the highest emissions with Peak and RMS detector (as described in ANSI C 63.4).
- As external mixers may generate false images care is taken to ensure that any emission measured by the spectrum analyzer does indeed originate in the EUT. Signal identification feature of spectrum analyzer is used to eliminate false mixer images (i.e., it is not the fundamental emission or a harmonic falling precisely at the measured frequency).
- Final levels, frequency, measuring time, bandwidth, correction factor, margin to the limit and limit are recorded. A plot with the graph of the premeasurement and the limit is stored.

9 Measurement uncertainty

Test case	Uncertainty
Equivalent isotropically radiated power (e.i.r.p.)	Conducted value ± 1 dB Radiated value ± 3 dB
Permitted range of operating frequencies	± 100 kHz
Conducted unwanted emissions in the spurious domain (up to 18 GHz)	± 1 dB
Radiated unwanted emissions in the spurious domain (up to 18 GHz)	± 3 dB
Conducted unwanted emissions in the spurious domain (18 to 40 GHz)	± 4 dB
Radiated unwanted emissions in the spurious domain (18 to 40 GHz)	± 4 dB
Conducted unwanted emissions in the spurious domain (40 to 50 GHz)	± 4.5 dB
Radiated unwanted emissions in the spurious domain (40 to 50 GHz)	± 4.5 dB
Conducted unwanted emissions in the spurious domain (above 50 GHz)	± 5 dB
Radiated unwanted emissions in the spurious domain (above 50 GHz)	± 5 dB
DC and low frequency voltages	± 3 %
Temperature	± 1 °C
Humidity	± 3 %

10 Summary of measurement results

<input checked="" type="checkbox"/>	No deviations from the technical specifications were ascertained
<input type="checkbox"/>	There were deviations from the technical specifications ascertained
<input type="checkbox"/>	This test report is only a partial test report. The content and verdict of the performed test cases are listed below.

TC identifier	Description	verdict	date	Remark
RF-Testing	FCC 47 CFR Part 15 IC RSS-210 Issue 10* IC RSS-Gen Issue 5*	see below	2023-11-10	-/-

Test specification clause	Test case	Temperature conditions	Power supply	Pass	Fail	NA	NP	Remark
§15.258 (d)	Occupied bandwidth	Nominal	Nominal	<input checked="" type="checkbox"/>	<input type="checkbox"/>	<input type="checkbox"/>	<input type="checkbox"/>	complies
§15.258 (b)	Maximum E.I.R.P.	Nominal	Nominal	<input checked="" type="checkbox"/>	<input type="checkbox"/>	<input type="checkbox"/>	<input type="checkbox"/>	complies
See Note	Duty cycle	Nominal	Nominal	<input checked="" type="checkbox"/>	<input type="checkbox"/>	<input type="checkbox"/>	<input type="checkbox"/>	complies
§15.258 (c)	Spurious Emissions	Nominal	Nominal	<input checked="" type="checkbox"/>	<input type="checkbox"/>	<input type="checkbox"/>	<input type="checkbox"/>	complies
§15.258 (d)	Frequency stability	Extreme Nominal	Extreme Nominal	<input checked="" type="checkbox"/>	<input type="checkbox"/>	<input type="checkbox"/>	<input type="checkbox"/>	complies
§15.207	Conducted emissions < 30 MHz (AC power line)	Nominal	Nominal	<input checked="" type="checkbox"/>	<input type="checkbox"/>	<input type="checkbox"/>	<input type="checkbox"/>	complies

*For information only. Frequency band of operation is not subject to RSS-210 Issue 10.

Note: NA = Not applicable; NP = Not performed

According to the document "DRS Authorization Letter - Pepperl + Fuchs MWC25M-L2M-B - August 2023.pdf", ISED is allowing a special authorization for the MWC25M-L2M-B radar family according to RSS-Gen Issue 5 and RSS-210 Issue 10 requirements.

11 Additional comments

Reference documents:

- None

Special test descriptions:

- None

Configuration descriptions:

- None

Special Authorization letter:

- DRS Authorization Letter - Pepperl + Fuchs MWC25M-L2M-B - August 2023.pdf

Test devices (EUT):

- EUT1:
 - The normal operation mode (intended use) is used with a **sampling rate of 200Hz**.
 - A software (PACTware) provided by the manufacturer is used to set the defined sampling rate.
- EUT2:
 - The normal operation mode (intended use) is used with a **sampling rate of 200Hz**.
 - The below described Stop-Modes with a duty cycle of 100% (as worst-case scenario) are used.
 - A software (setup-emotas-cde-2_15_0.exe, radar_sensor_can_rndprod_2023_05_09.eds) and provided by the manufacturer is used to change the modes.
- EUT3:
 - The below described Stop-Modes with a duty cycle of 20% (as in normal mode) are used.
 - A software (setup-emotas-cde-2_15_0.exe, radar_sensor_can_E1_rndprod.eds) provided by the manufacturer is used to change the modes.

- Additional test modes:**
- No test modes available
 - Special test modes/special software (see description below)
 - Stop-Modes (see description below)

Stop-Modes:

In addition to the normal operation mode, Stop-Modes are used in accordance with CFR 47 Part §15.31 (c) & (m), in which the frequency sweep is stopped at the following positions in the range of operation:

- Stop mode, low frequency: 122.3 GHz
- Stop mode, middle frequency: 122.625 GHz
- Stop mode, high frequency: 122.95 GHz

12 Measurement results

12.1 Occupied bandwidth (6 dB Bandwidth)

Description:

Measurement of the bandwidth of the wanted signal.

Limits:

FCC
CFR Part 15.258
The occupied bandwidth from intentional radiators operated within the specified frequency band shall comply with the following:
Frequency range
116 GHz – 123 GHz

§15.258 (d)

Fundamental emissions must be contained within the frequency bands specified in this section during all conditions of operation. Equipment is presumed to operate over the temperature range -20 to + 50 degrees Celsius with an input voltage variation of 85% to 115% of rated input voltage, unless justification is presented to demonstrate otherwise

Note: please also see chapter 12.4.

Measurement:

Measurement parameter	
Detector:	Pos-Peak
Resolution bandwidth:	100 kHz
Video bandwidth:	300 kHz
Trace-Mode:	Max Hold

Measurement results:

6 dB bandwidth:

EUT	Mode	Test condition	f _L [GHz]	f _H [GHz]	Bandwidth [GHz]
EUT 1	Normal Mode	T _{nom} / V _{nom}	122.229	122.969	0.67

Verdict: Complies

Plot 1: Normal Mode, 6 dB bandwidth (RBW = 100 kHz)

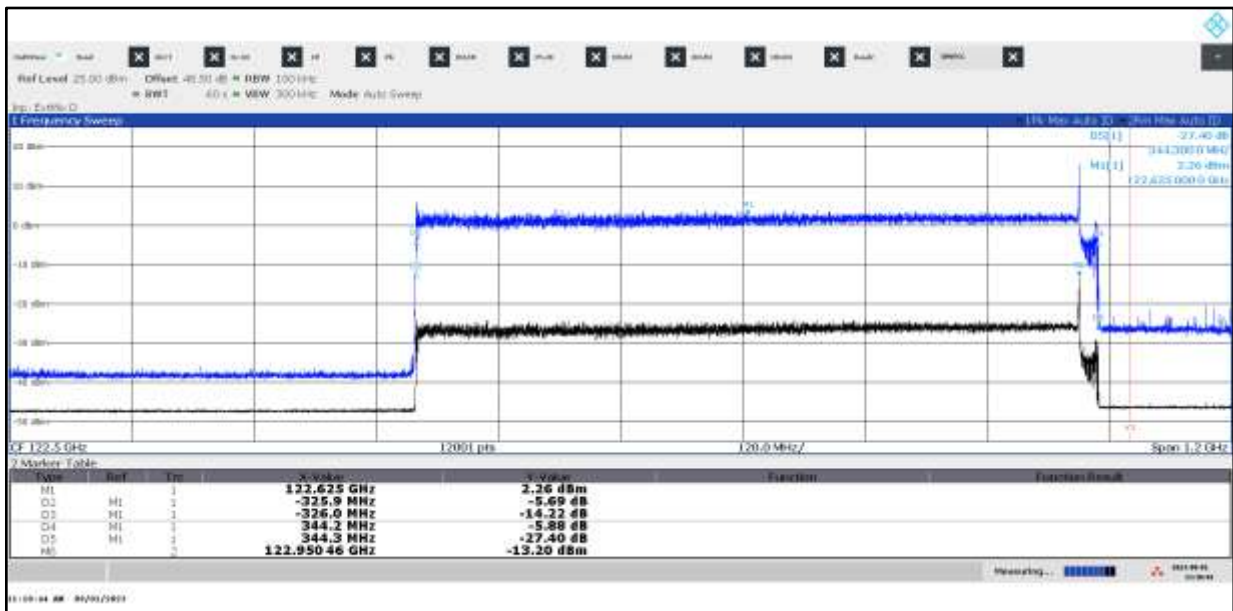

12.2 Maximum E.I.R.P.

Description:

Measurement of the maximum radiated e.i.r.p. of the wanted signal.

Limits:

§15.258 (b)

Emission levels within the 116-123 GHz, 174.8-182 GHz, 185-190 GHz and 244-246 GHz bands shall not exceed the following equivalent isotropically radiated power (EIRP) limits as measured during the transmit interval:

- (1) The average power of any emission shall not exceed 40 dBm and the peak power of any emission shall not exceed 43 dBm; or
- (2) For fixed point-to-point transmitters located outdoors, the average power of any emission shall not exceed 82 dBm and shall be reduced by 2 dB for every dB that the antenna gain is less than 51 dBi. The peak power of any emission shall not exceed 85 dBm and shall be reduced by 2 dB for every dB that the antenna gain is less than 51 dBi. The provisions in this paragraph (b)(2) for reducing transmit power based on antenna gain shall not require that the power levels be reduced below the limits specified in paragraph (b)(1) of this section.
- (3) The peak power shall be measured with a detection bandwidth that encompasses the entire occupied bandwidth within the intended band of operation, e.g., 116-123 GHz, 174.8-182 GHz, 185-190 GHz or 244-246 GHz. The average emission levels shall be measured over the actual time period during which transmission occurs.
- (4) Transmitters with an emission bandwidth of less than 100 MHz must limit their peak radiated power to the product of the maximum permissible radiated power (in milliwatts) times their emission bandwidth divided by 100 MHz. For the purposes of this paragraph (b)(4), emission bandwidth is defined as the instantaneous frequency range occupied by a steady state radiated signal with modulation, outside which the radiated power spectral density never exceeds 6 dB below the maximum radiated power spectral density in the band, as measured with a 100 kHz resolution bandwidth spectrum analyzer. The center frequency must be stationary during the measurement interval, even if not stationary during normal operation (e.g., for frequency hopping devices).

DRS Authorization Letter - Pepperl + Fuchs MWC25M-L2M-B - August 2023:

The peak e.i.r.p of the device shall not exceed 20 dBm.

Measurement:

Measurement parameter	
Detector:	Pos-Peak (RF-Detector)
Video bandwidth:	10 MHz
Trace-Mode:	Max Hold

Measurement results:

EUT	Mode	Test condition	Peak E.I.R.P.	Limit Peak E.I.R.P	Average E.I.R.P.*	Limit Average E.I.R.P
EUT 1	Normal Mode	T_{nom} / V_{nom}	19.3 dBm	43 dBm	19.0 dBm	40 dBm

*measured over the actual time period during which transmission occurs

EUT	Mode	Test condition	Duty cycle
EUT 1	Normal Mode	T_{nom} / V_{nom}	20.66 %

Description of the E.I.R.P. measurement by substitution method:

- 1) EUT emission measured with RF-detector:
 - Measurement distance: d_{EUT}
 - Maximum readout value on oscilloscope: V_{max}
 - Average readout value on oscilloscope: $V_{average}$ (measured over the actual time period during which transmission occurs)
 - Duty cycle: D_{EUT}
- 2) Substitution of EUT by a cw reference source with a frequency of f_{REF} and a fixed output power of P_{REF}
 - Readout value on oscilloscope adjusted to V_{max} and $V_{average}$ by far field attenuation
- 3) Calculation of the Max E.I.R.P. of the EUT:
 - Free space loss: $FSL(d) = 20 \times \log(4 \times \pi \times d \times f / c)$, c: speed of light
 - Max E.I.R.P. = $P_{REF} - FSL(d_{REF,max}) + FSL(d_{EUT})$
 - Average E.I.R.P. = $P_{REF} - FSL(d_{REF,average}) + FSL(d_{EUT})$

Measurement step	Measurement parameter	EUT
		1
1)	Measurement distance d_{EUT}	0.495 m
	Maximum readout value V_{max}	10.16 mV
	Average readout value $V_{average}$	9.5 mV
	Duty cycle D_{EUT}	20.66 %
2)	Output power P_{REF}	28.4 dBm
	Frequency f_{REF}	122.625 GHz
	Measurement distance $d_{REF,max}$	1.42 m
	Measurement distance $d_{REF,average}$	1.455 m
3)	Max E.I.R.P.	19.3 dBm
	Average E.I.R.P.	19.0 dBm

Setup of the substitution:



Note:

- Top of picture: SG Extension Module 110 - 170 GHz & Std. Gain Horn Antenna 114-173 GHz
- Bottom of picture: F-Band Positive Amplitude Detector & Waveguide Amplifier & Std. Gain Horn Antenna 90-140 GHz

Plot 2: EUT emission, normal mode, sampling rate 200 Hz, duty cycle

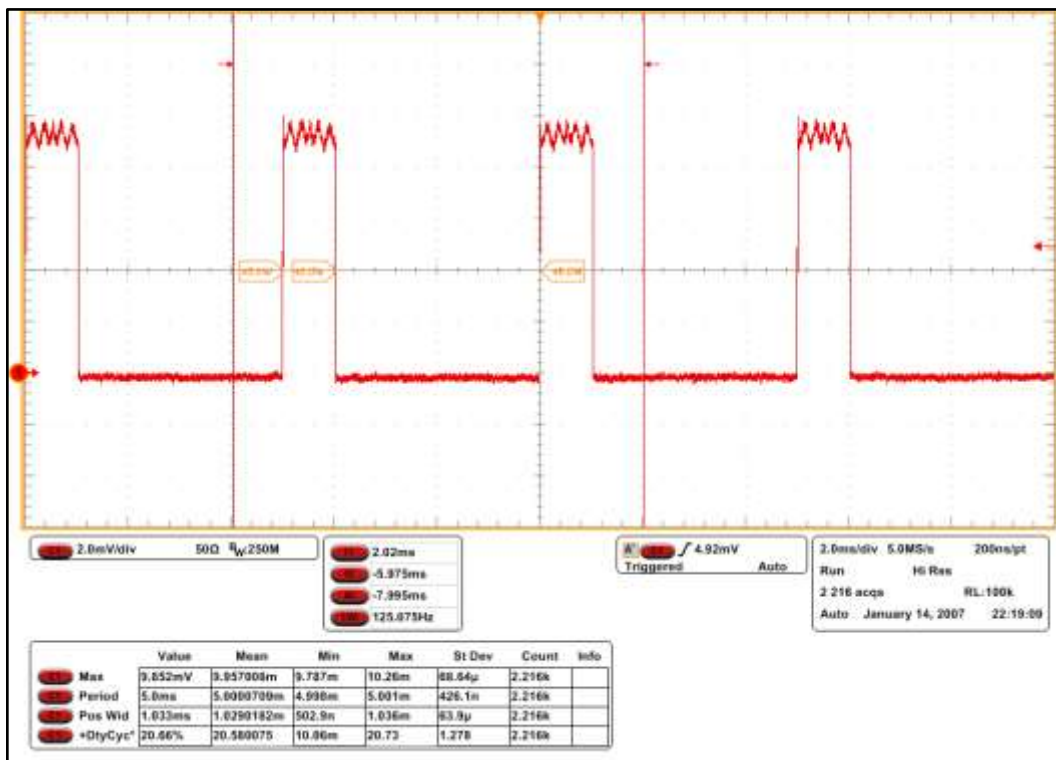

Plot 3: EUT emission, normal mode, sampling rate 200 Hz, V_max & V_average

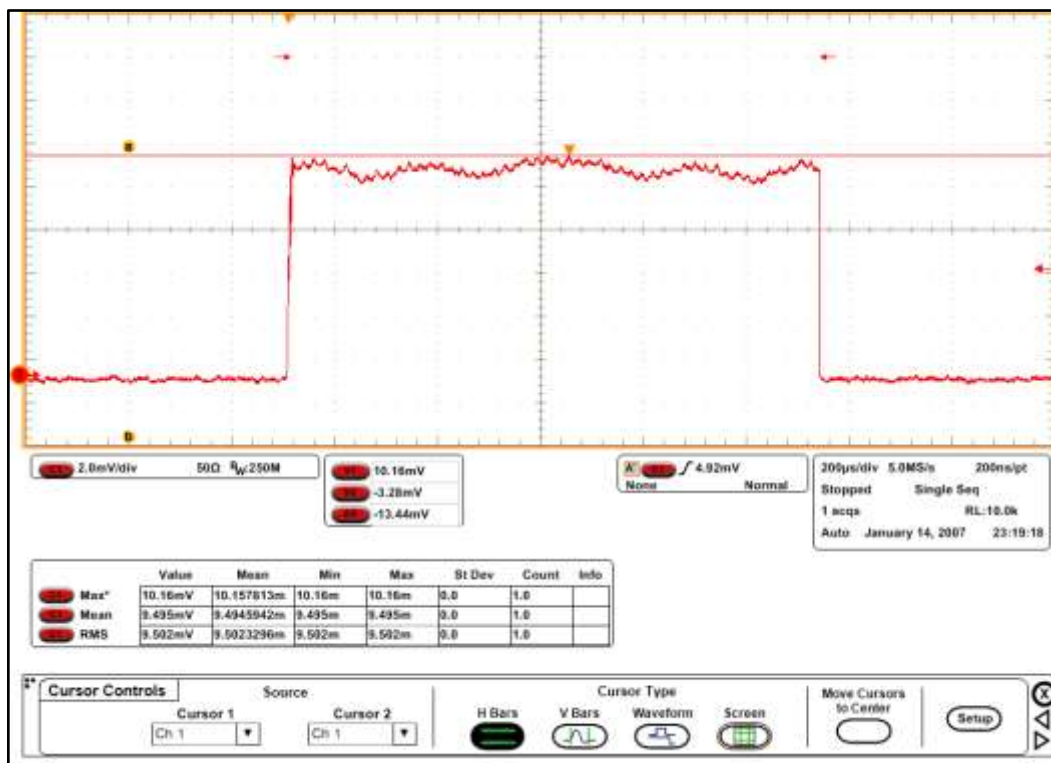

12.3 Spurious emissions radiated

Description:

Measurement of the radiated spurious emissions.

Limits:

FCC Part 15.258 (c)

Spurious emissions shall be limited as follows:

- (1) The power density of any emissions outside the band of operation, e.g., 116-123 GHz, 174.8-182 GHz, 185-190 GHz or 244-246 GHz, shall consist solely of spurious emissions.
- (2) Radiated emissions below 40 GHz shall not exceed the general limits in §15.209.
- (3) Between 40 GHz and the highest frequency specified in § 15.33, the level of these emissions shall not exceed 90 pW/cm² at a distance of 3 meters.
- (4) The levels of the spurious emissions shall not exceed the level of the fundamental emission.

FCC / IC		
CFR Part 15.209(a) / RSS-Gen 8.9		
Radiated emission limits		
Frequency (MHz)	Field strength (microvolts/meter)	Measurement distance (meters)
0.009 – 0.490	2400/F(kHz)	300
0.490 – 1.705	24000/F(kHz)	30
1.705 – 30.0	30	30
30 – 88	100	3
88 – 216	150	3
216 – 960	200	3
Above 960	500	3

FCC Part 15.33 (a)

For an intentional radiator, the spectrum shall be investigated from the lowest radio frequency signal generated in the device, without going below 9 kHz, up to at least the frequency shown in this paragraph:

(4) If the intentional radiator operates at or above 95 GHz: To the third harmonic of the highest fundamental frequency or to 750 GHz, whichever is lower, unless specified otherwise elsewhere in the rules.

Limit conversion (ANSI C63.10-2013 9.6):

$$\text{EIRP[dBm]} = 10 \times \log(4 \times \pi \times d^2 \times \text{PD}[\text{W/m}^2])$$

- Power density at the distance specified by the limit: PD [W/m²]
- Equivalent isotropically radiated power: EIRP [dBm]
- Distance at which the power density limit is specified: d [m]

According to this formula, an emission limit of PD = 90 pW/cm² at a distance of d = 3 m corresponds to an equivalent isotropically radiated power of EIRP = -10 dBm.

Measurement:

Measurement parameter	
Detector:	Quasi Peak / Pos-Peak / RMS
Resolution bandwidth:	F < 1 GHz: 100 kHz F > 1 GHz: 1 MHz
Video bandwidth:	F < 1 GHz: 300 kHz F > 1 GHz: 3 MHz
Frequency range:	30 MHz to 380 GHz
Trace-Mode:	Max Hold

Measurement results:

Note:

- Measurements were performed in normal operation mode (frequency sweep) and in stop mode (frequency sweep stopped at three positions within the range of operation: near top, near middle, near bottom) in accordance with §15.31(c), (m).

Normal operation mode:

Frequency [GHz]	Detector	Bandwidth [MHz]	Level	Limit	Margin [dB]
-/-	-/-	-/-	-/-	-/-	-/-
Please refer to the following plots for more information on the level of spurious emissions					

Stop mode, low frequency:

Frequency [GHz]	Detector	Bandwidth [MHz]	Level	Limit	Margin [dB]
-/-	-/-	-/-	-/-	-/-	-/-
Please refer to the following plots for more information on the level of spurious emissions					

Stop mode, middle frequency:

Frequency [GHz]	Detector	Bandwidth [MHz]	Level	Limit	Margin [dB]
-/-	-/-	-/-	-/-	-/-	-/-
Please refer to the following plots for more information on the level of spurious emissions					

Stop mode, high frequency:

Frequency [GHz]	Detector	Bandwidth [MHz]	Level	Limit	Margin [dB]
-/-	-/-	-/-	-/-	-/-	-/-
Please refer to the following plots for more information on the level of spurious emissions					

Verdict: Complies

12.3.1 Stop mode spurious emissions radiated

Plot 4: 9 kHz – 30 MHz, stop mode, low frequency, EUT2

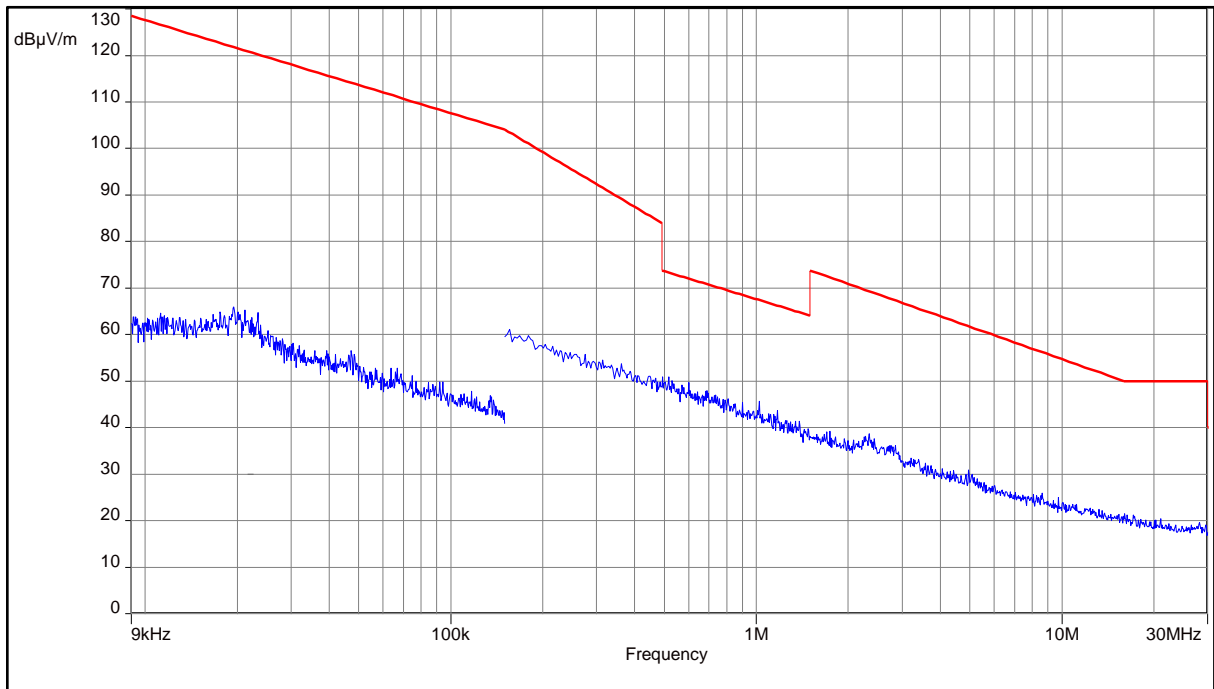

Plot 5: 9 kHz – 30 MHz, stop mode, middle frequency, EUT2

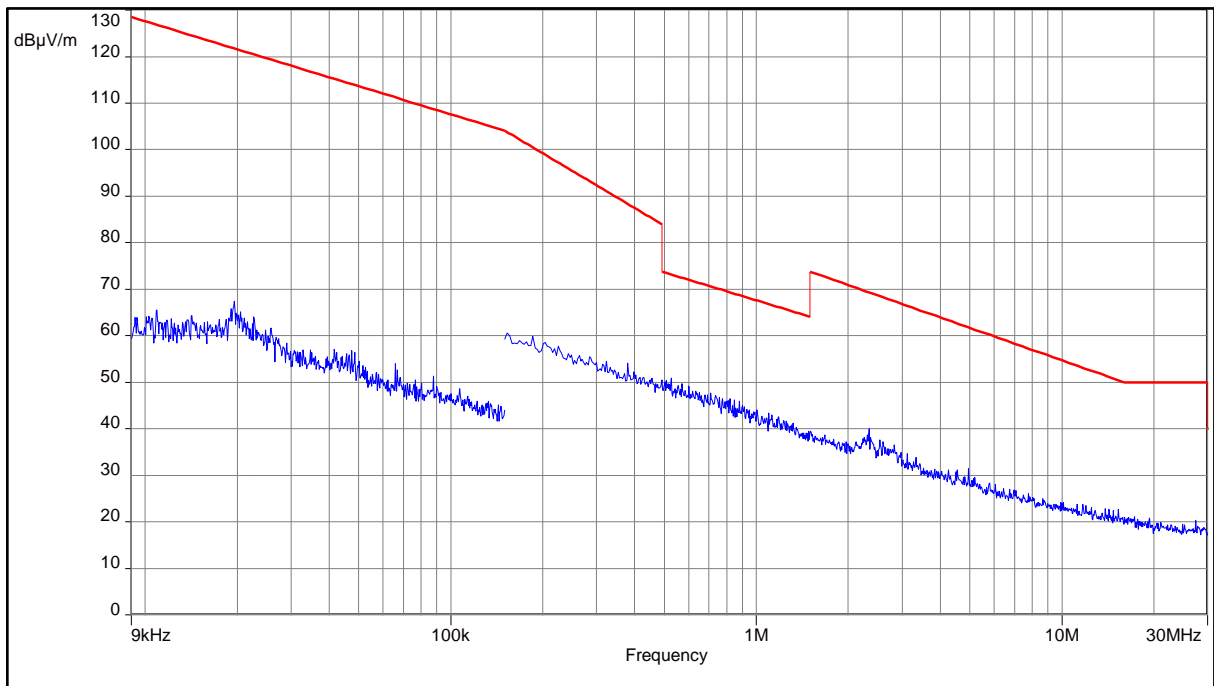

Plot 6: 9 kHz – 30 MHz, stop mode, high frequency, EUT2

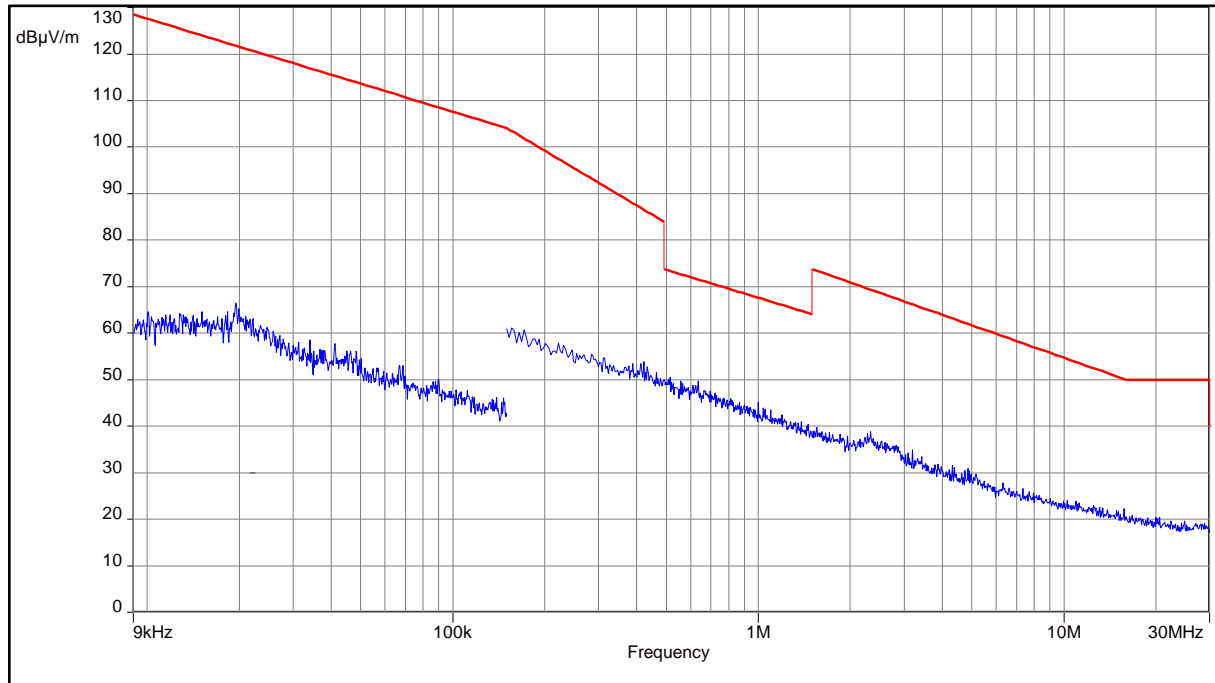

Plot 7: 30 MHz – 1GHz, stop mode, low frequency, EUT2

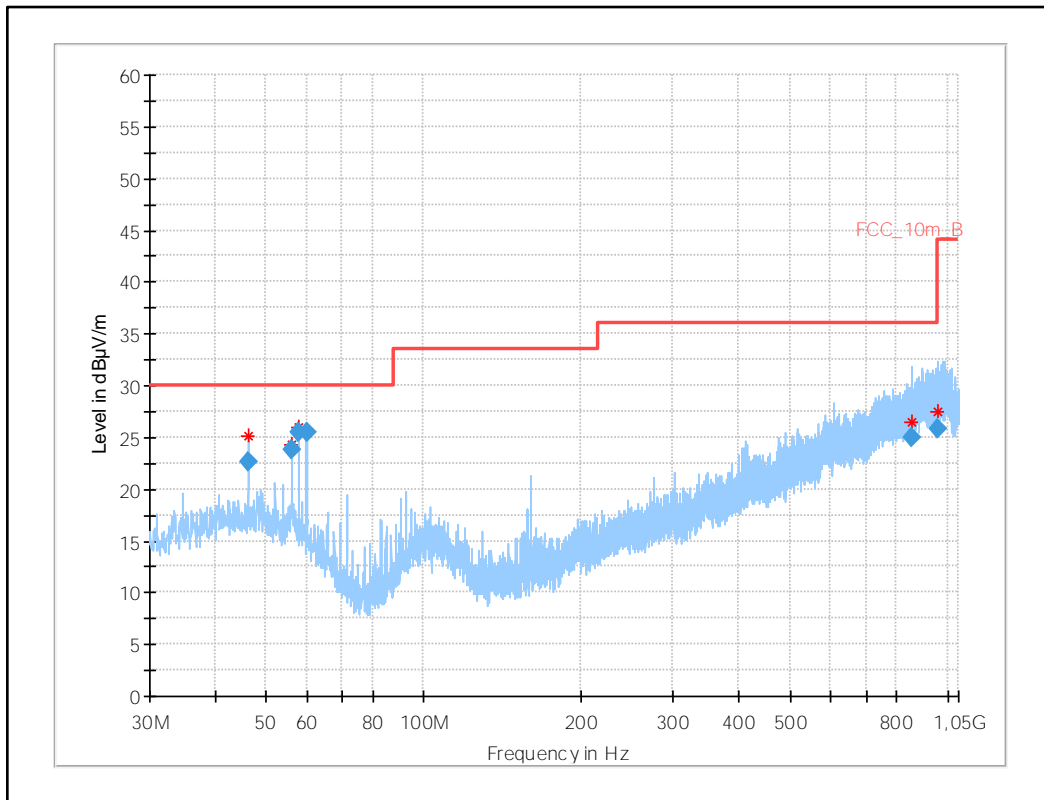

Frequency (MHz)	QuasiPeak (dBµV/m)	Limit (dBµV/m)	Margin (dB)	Meas. Time (ms)	Bandwidth (kHz)	Height (cm)	Pol	Azimuth (deg)	Corr. (dB/m)
46.280	22.64	30.0	7.4	1000	120.0	121.0	V	245	16
55.934	23.83	30.0	6.2	1000	120.0	195.0	V	232	16
57.844	25.52	30.0	4.5	1000	120.0	195.0	V	52	15
59.771	25.40	30.0	4.6	1000	120.0	195.0	V	232	14
852.231	25.03	36.0	11.0	1000	120.0	195.0	V	-25	25
955.295	25.75	36.0	10.3	1000	120.0	195.0	V	267	25

Plot 8: 30 MHz – 1GHz, stop mode, middle frequency, EUT2

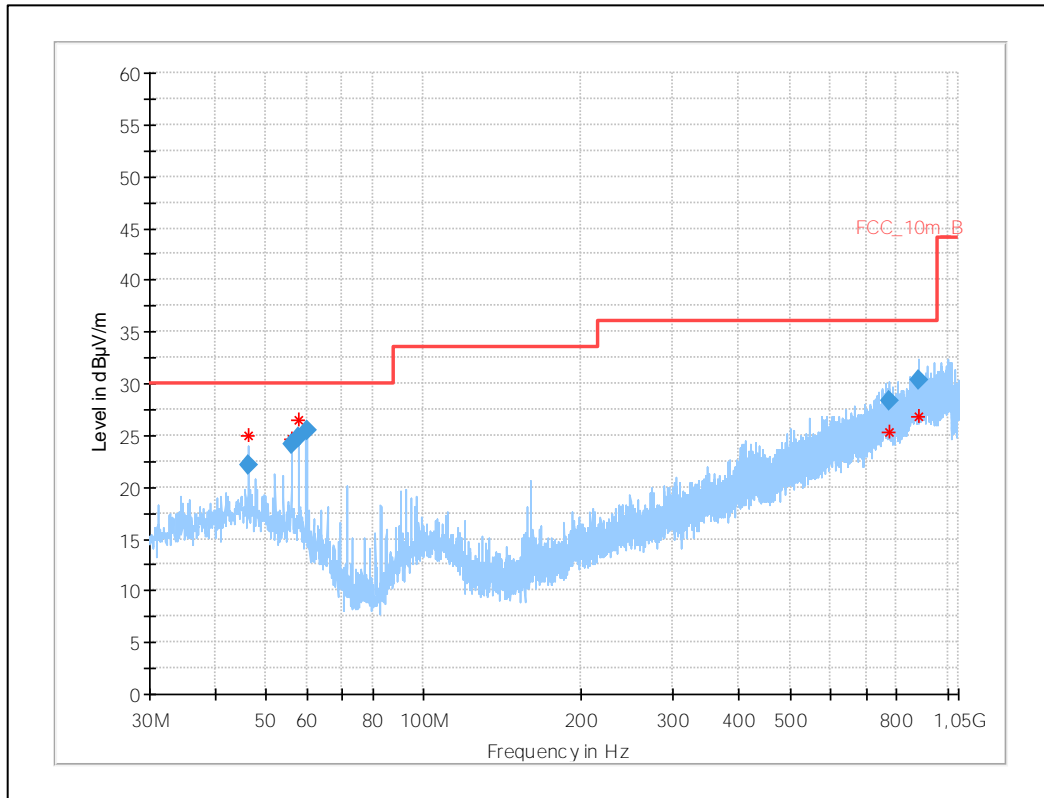

Frequency (MHz)	QuasiPeak (dBµV/m)	Limit (dBµV/m)	Margin (dB)	Meas. Time (ms)	Bandwidth (kHz)	Height (cm)	Pol	Azimuth (deg)	Corr. (dB/m)
46.282	22.14	30.0	7.9	1000	120.0	195.0	V	110	16
55.926	24.17	30.0	5.8	1000	120.0	195.0	V	142	16
57.849	24.75	30.0	5.3	1000	120.0	195.0	V	154	15
59.783	25.42	30.0	4.6	1000	120.0	195.0	V	52	14
777.126	28.36	36.0	7.6	1000	120.0	159.0	V	142	24
878.509	30.36	36.0	5.6	1000	120.0	195.0	V	52	25

Plot 9: 30 MHz – 1GHz, stop mode, high frequency, EUT2

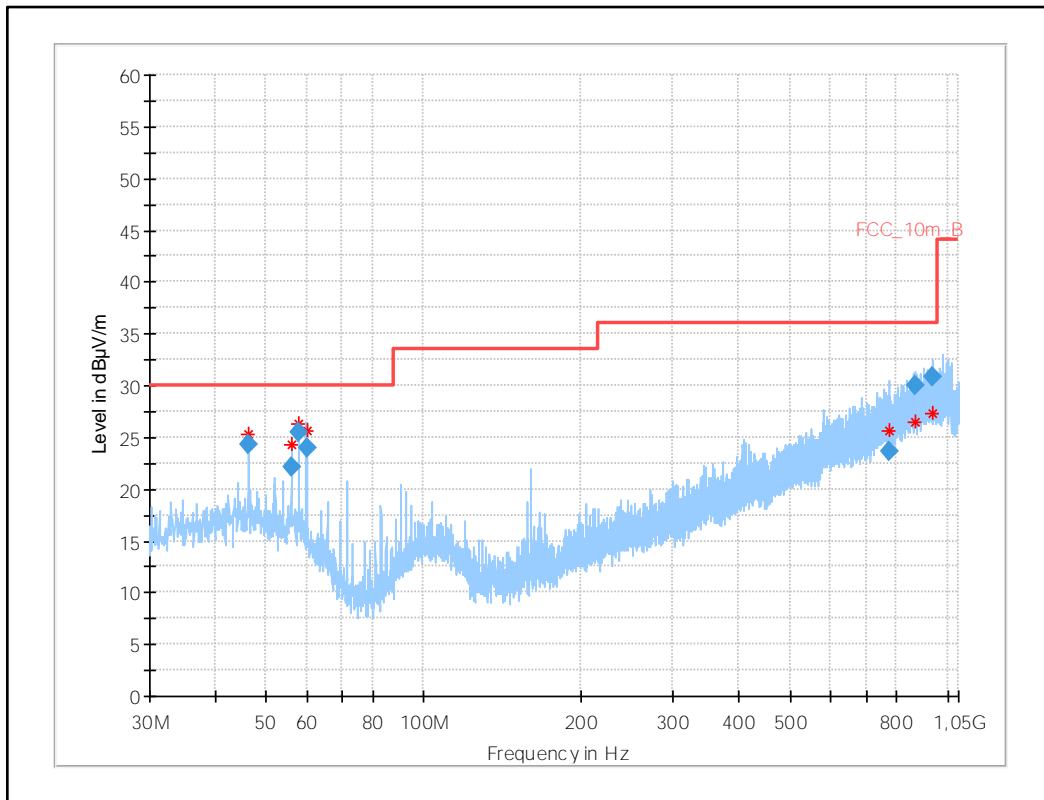

Frequency (MHz)	QuasiPeak (dBµV/m)	Limit (dBµV/m)	Margin (dB)	Meas. Time (ms)	Bandwidth (kHz)	Height (cm)	Pol	Azimuth (deg)	Corr. (dB/m)
46.283	24.23	30.0	5.8	1000	120.0	190.0	V	6	16
55.915	22.18	30.0	7.8	1000	120.0	195.0	V	195	16
57.874	25.51	30.0	4.5	1000	120.0	195.0	V	232	15
59.769	23.99	30.0	6.0	1000	120.0	140.0	V	142	14
775.011	23.63	36.0	12.4	1000	120.0	105.0	H	-20	24
866.276	30.03	36.0	6.0	1000	120.0	195.0	H	232	25
939.484	30.87	36.0	5.1	1000	120.0	184.0	H	146	26

Plot 10: 1GHz – 18 GHz, stop mode, low frequency, EUT2

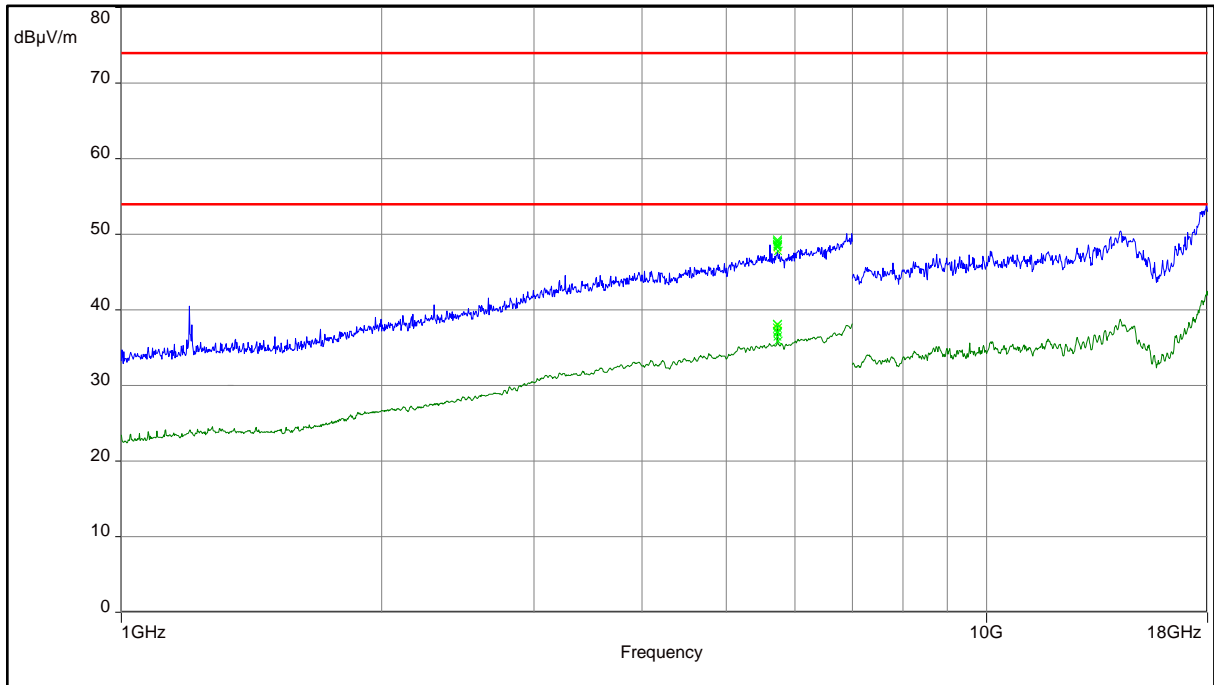

Plot 11: 1GHz – 18 GHz, stop mode, middle frequency, EUT2

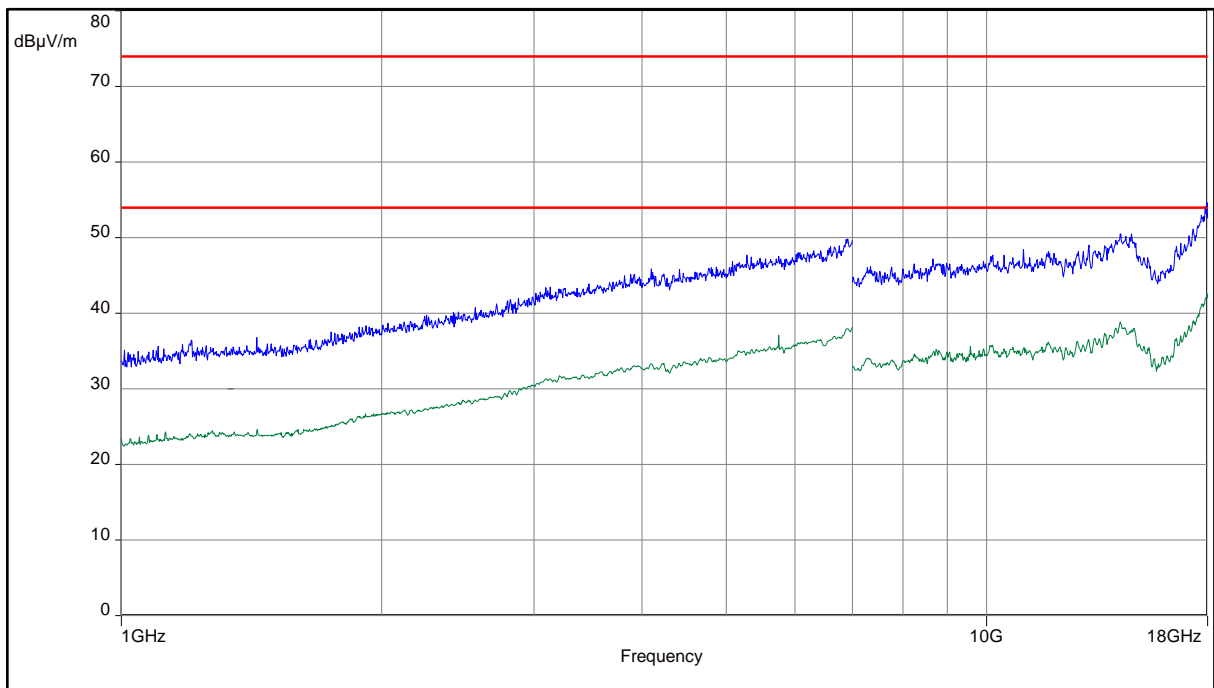

Plot 12: 1GHz – 18 GHz, stop mode, high frequency, EUT2

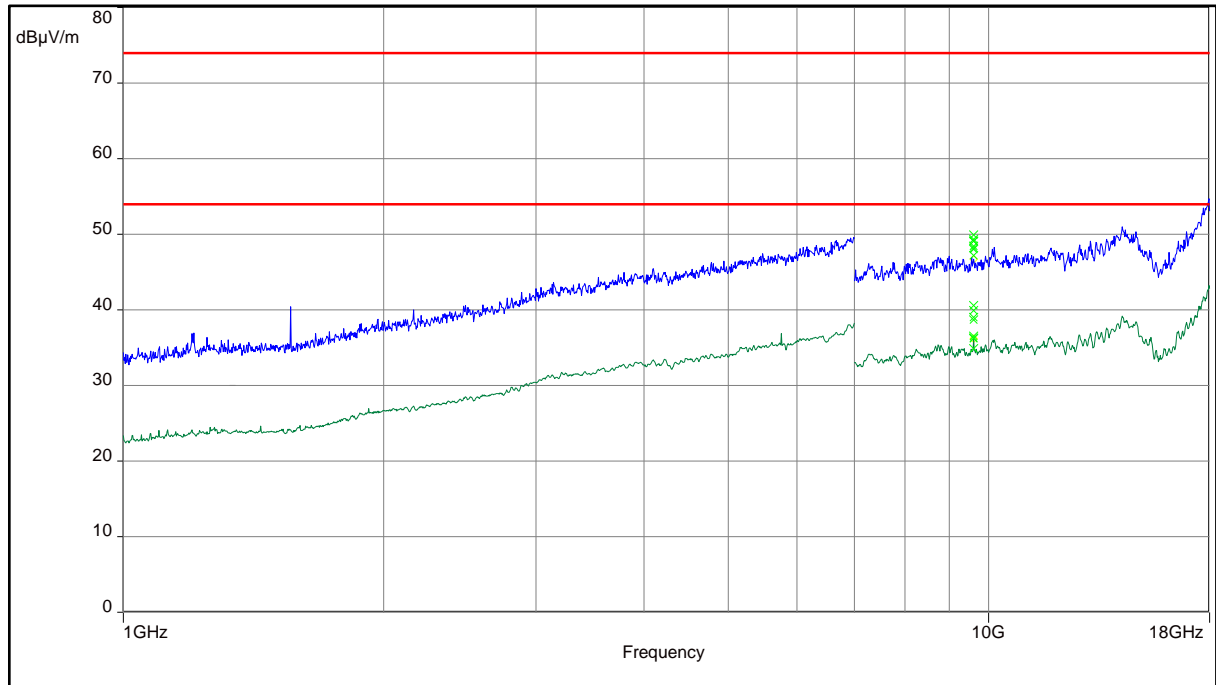

Plot 13: 18 GHz – 26.5 GHz, stop mode, low frequency, EUT2

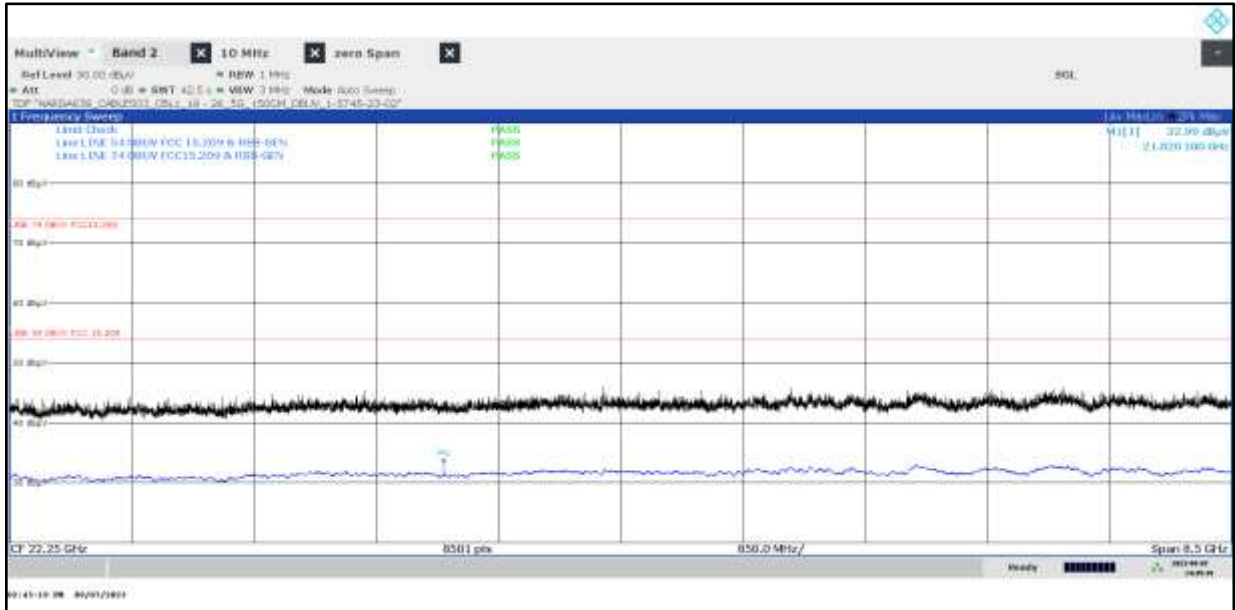

Plot 14: 18 GHz – 26.5 GHz, stop mode, middle frequency, EUT2

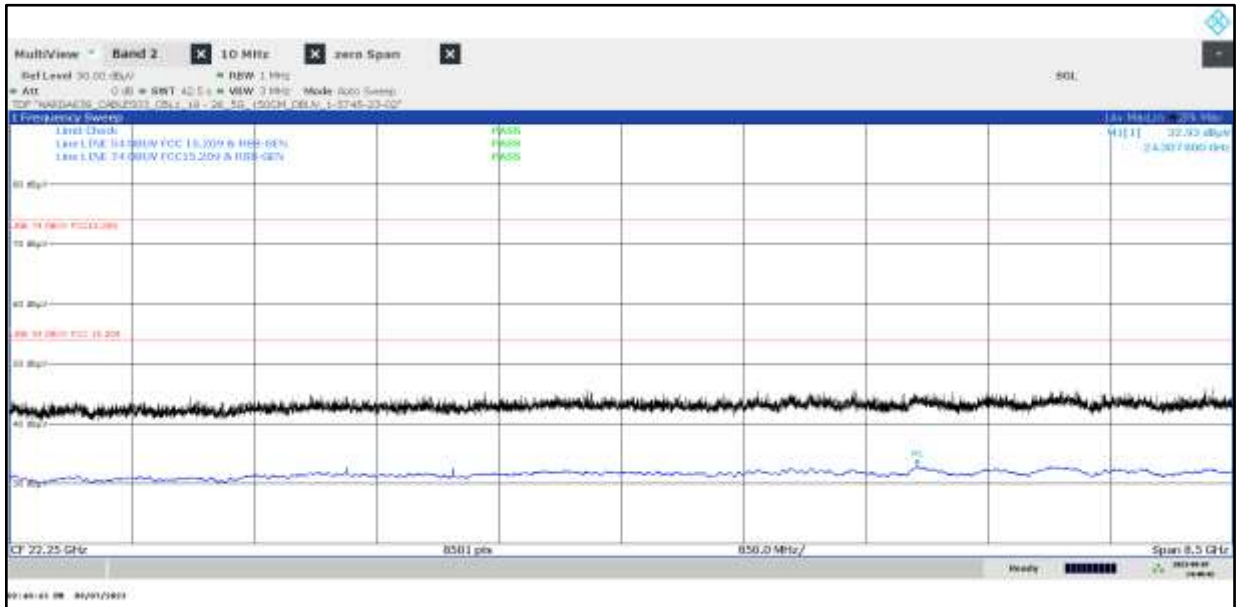

Plot 15: 18 GHz – 26.5 GHz, stop mode, high frequency, EUT2

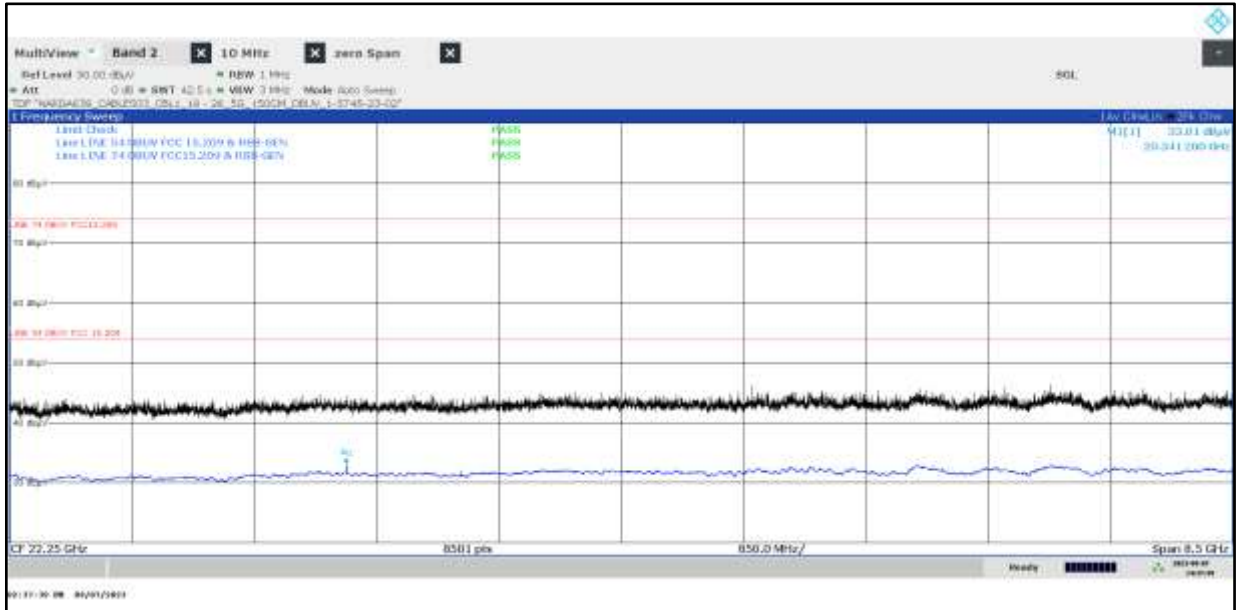

Plot 16: 26.5 GHz – 40 GHz, stop mode, low frequency, EUT2

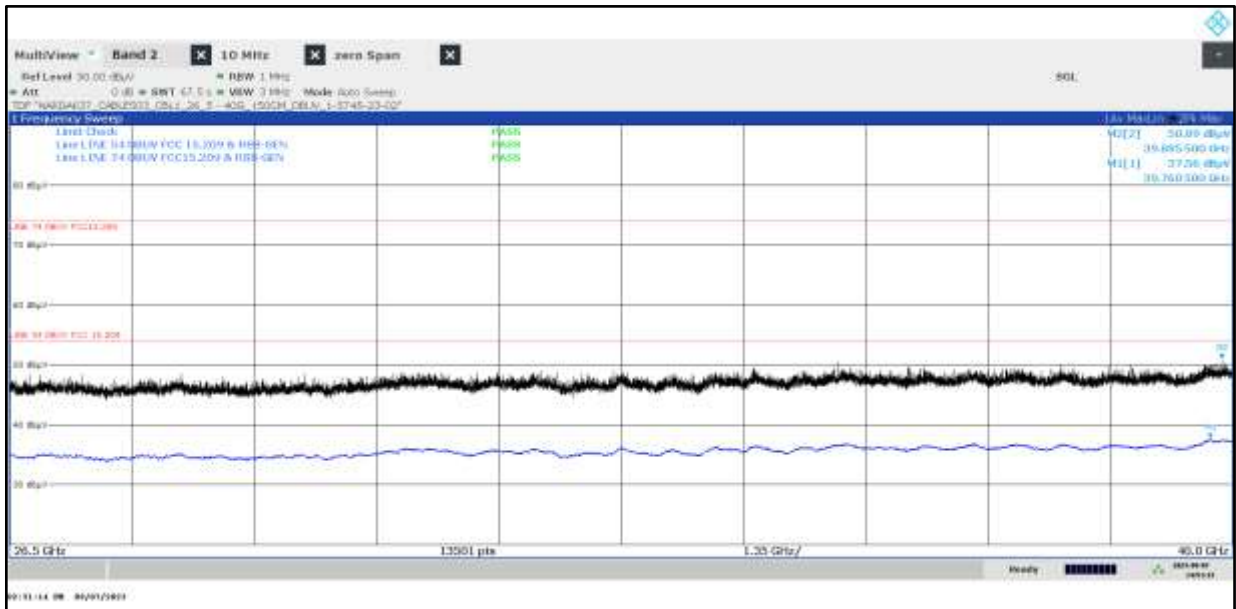

Plot 17: 26.5 GHz – 40 GHz, stop mode, middle frequency, EUT2

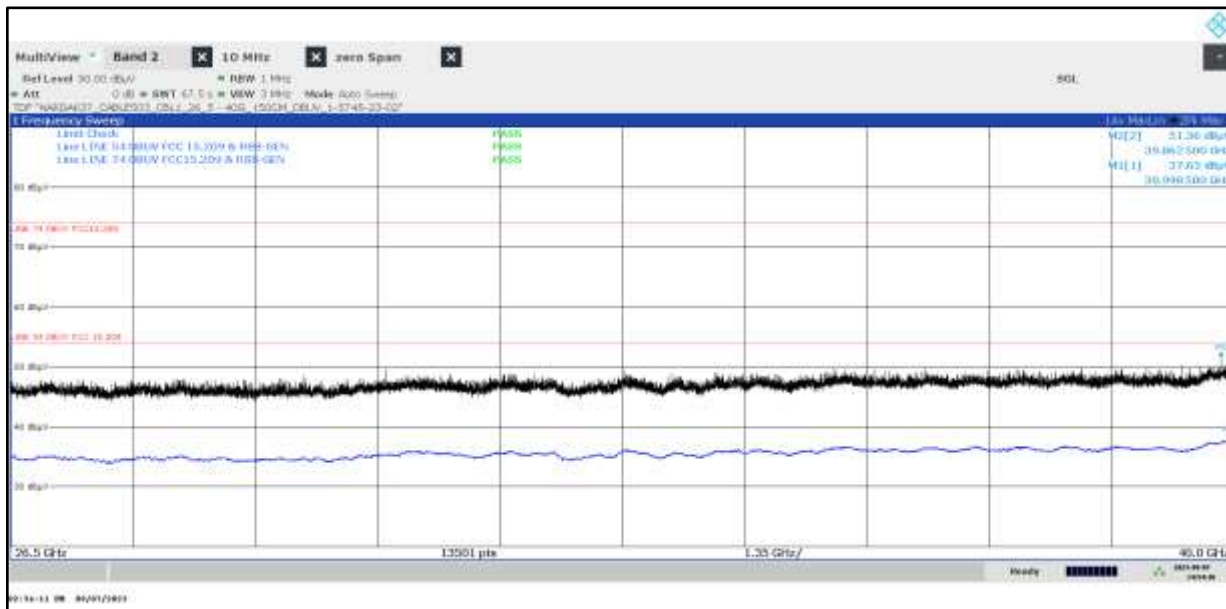

Plot 18: 26.5 GHz – 40 GHz, stop mode, high frequency, EUT2

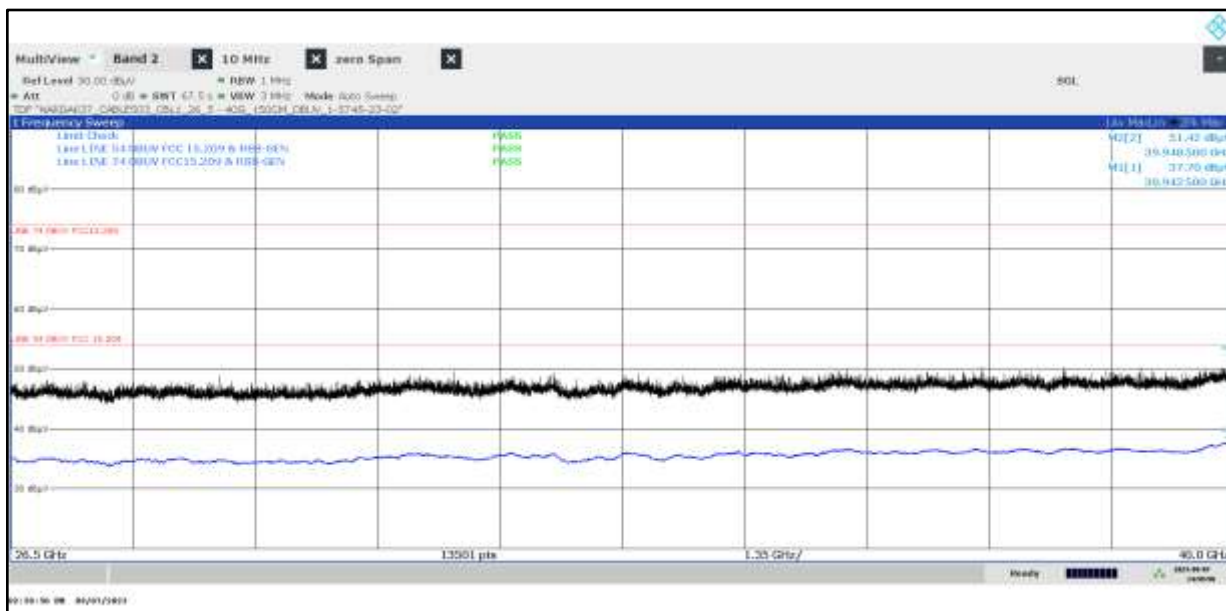

Plot 19: 40 GHz – 50 GHz, stop mode, low frequency, EUT2

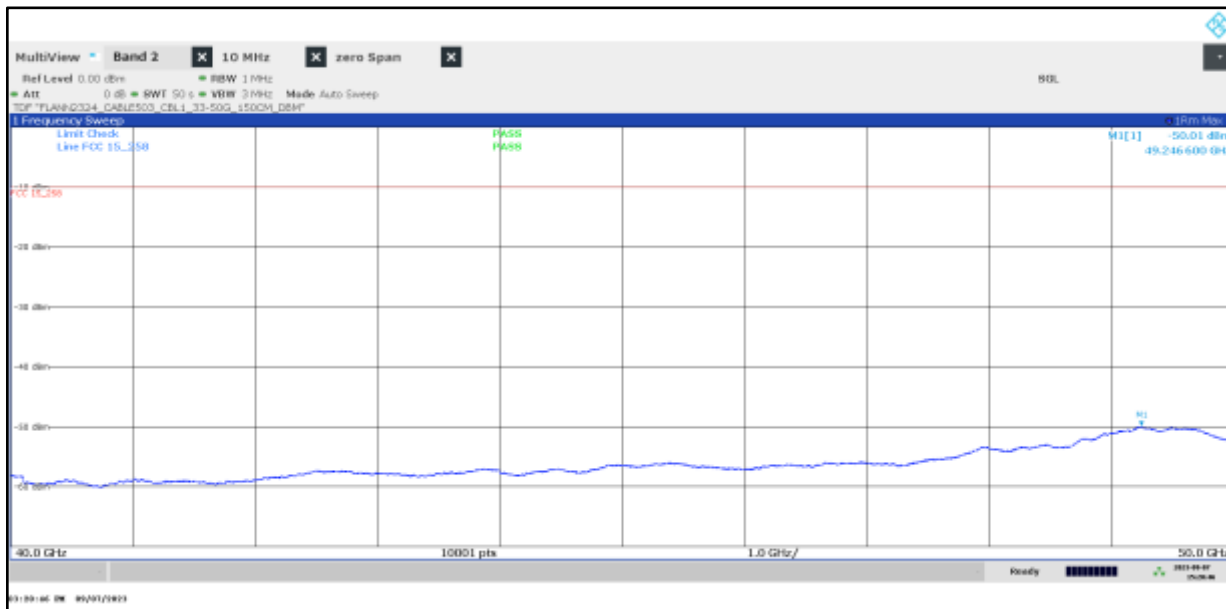

Plot 20: 40 GHz – 50 GHz, stop mode, middle frequency, EUT2

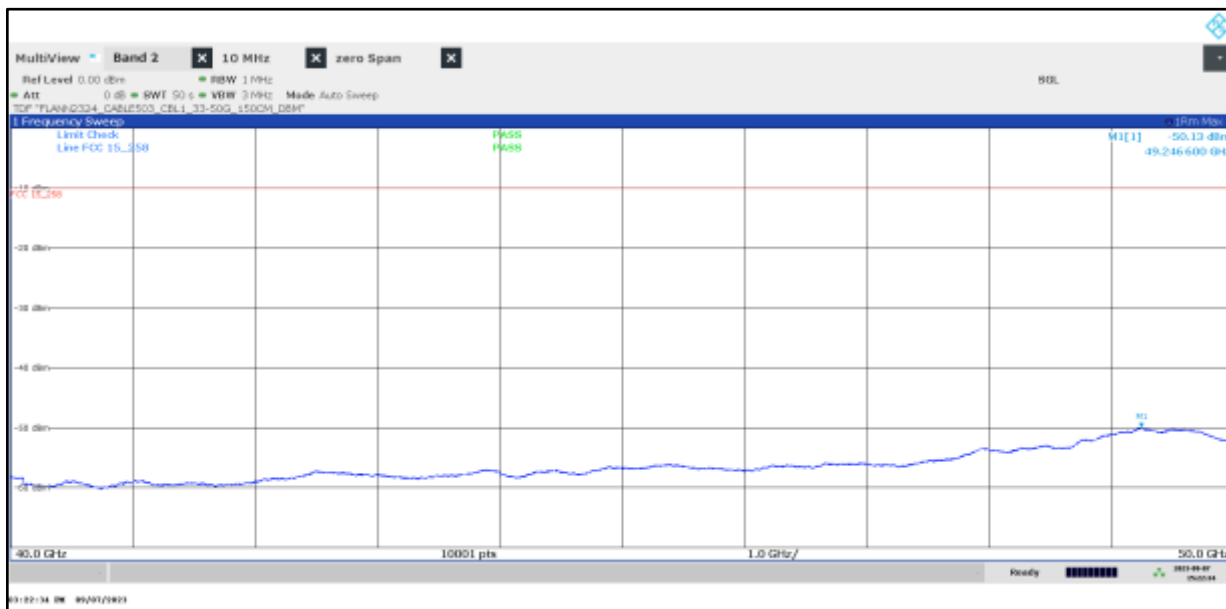

Plot 21: 40 GHz – 50 GHz, stop mode, high frequency, EUT2

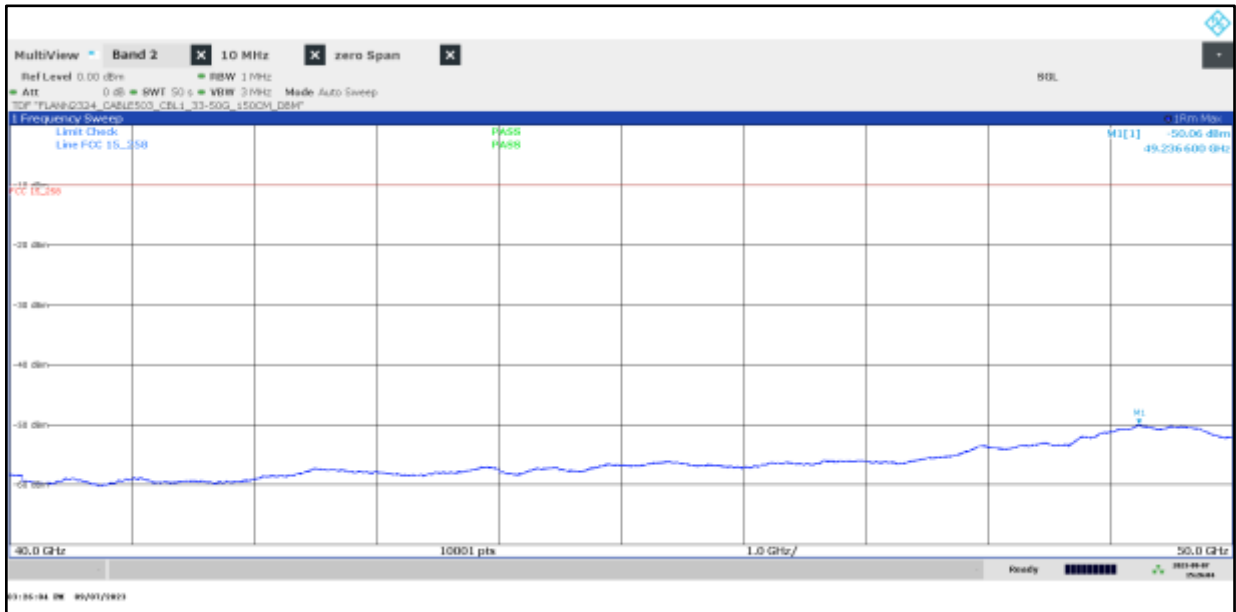

Plot 22: 50 GHz – 75 GHz, stop mode, low frequency, EUT3

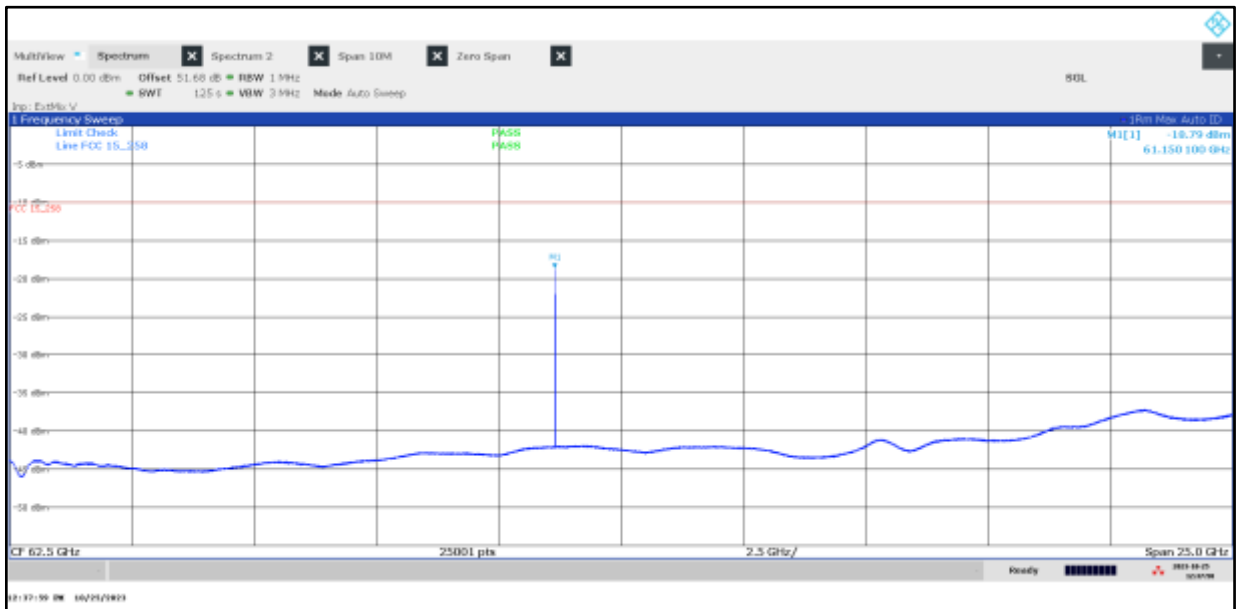

Plot 23: 61.15 GHz, stop mode, low frequency, spurious emissions, EUT3

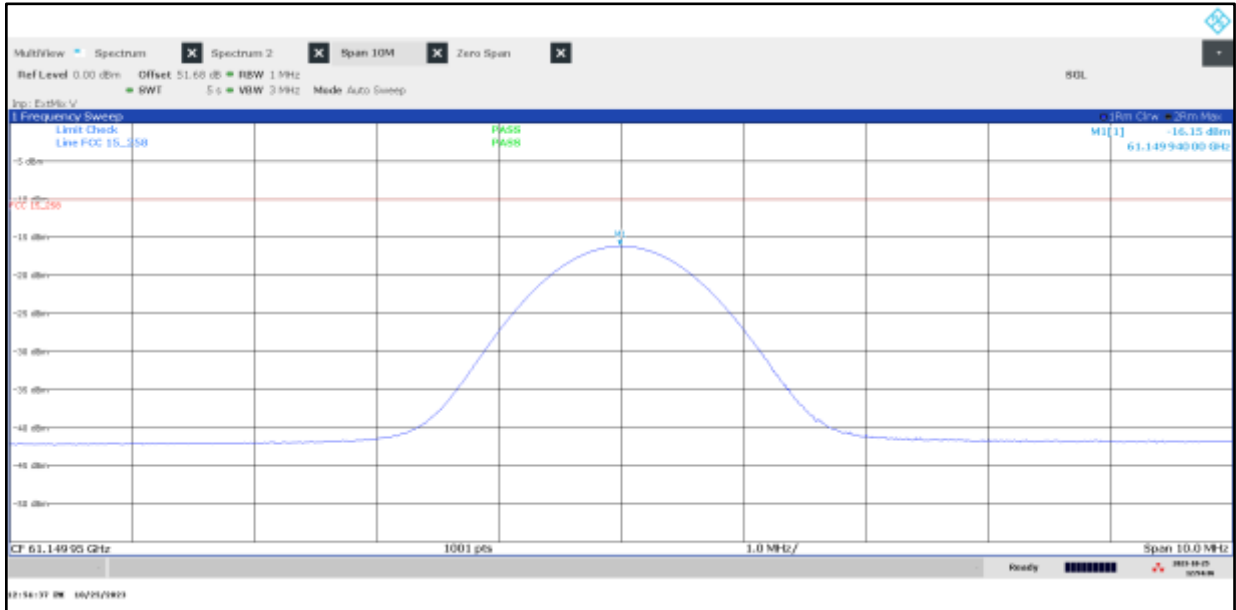

Plot 24: 61.15 GHz, stop mode, low frequency, spurious emissions, EUT3

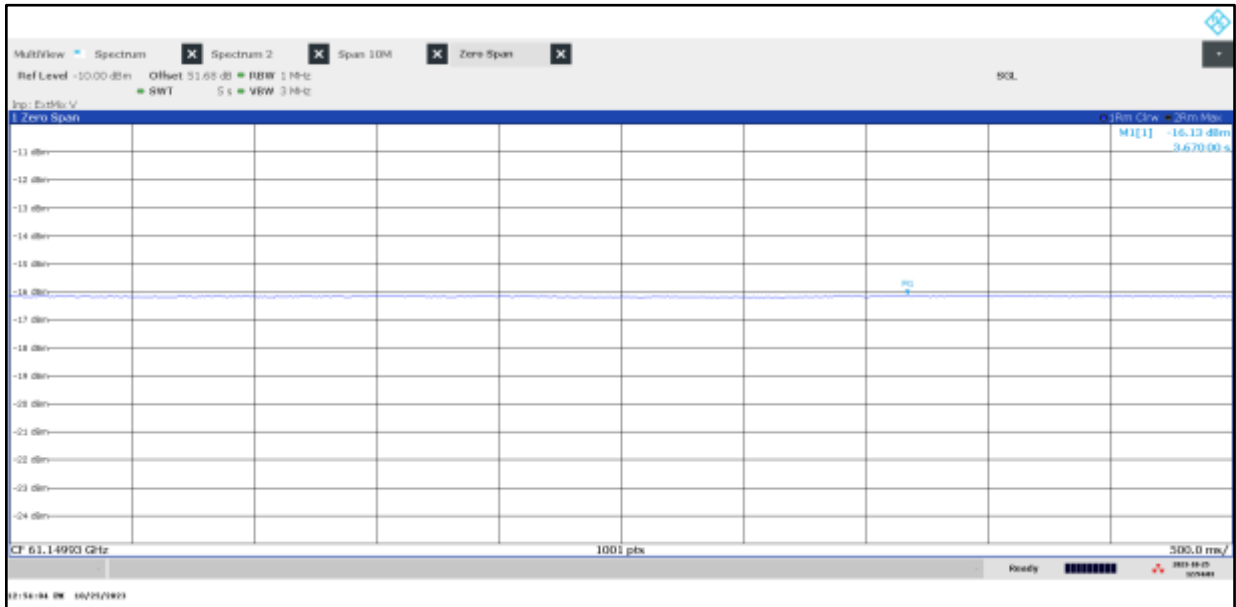

Plot 25: 50 GHz – 75 GHz, stop mode, middle frequency, EUT3

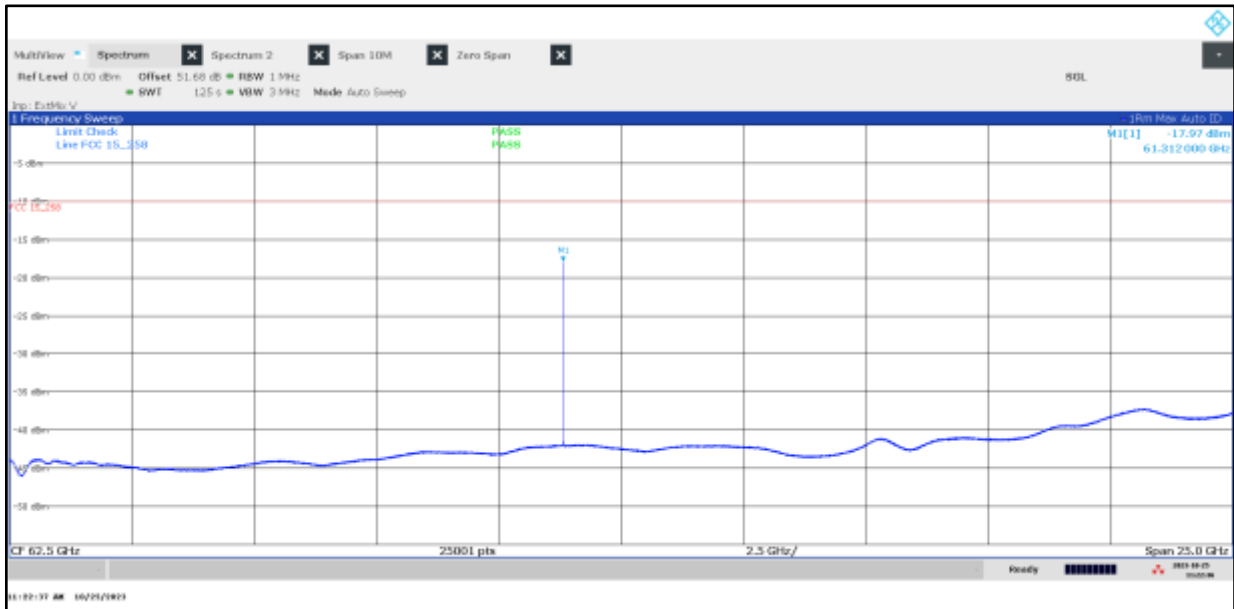

Plot 26: 61.31 GHz, stop mode, middle frequency, spurious emissions, EUT3

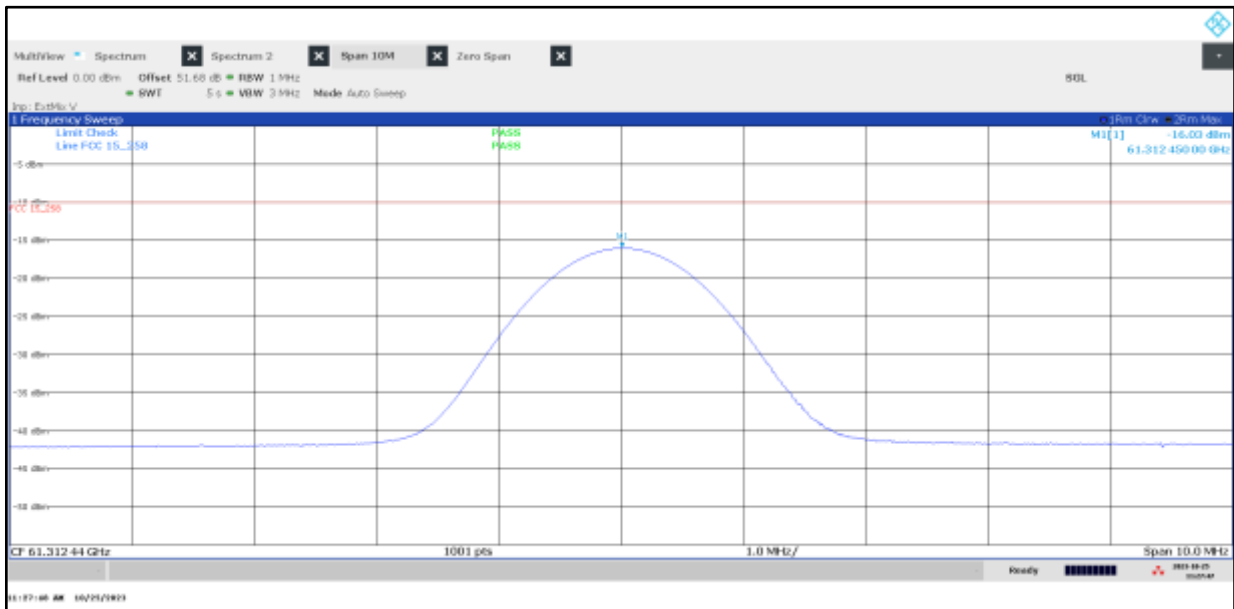

Plot 27: 61.31 GHz, stop mode, middle frequency, spurious emissions, EUT3

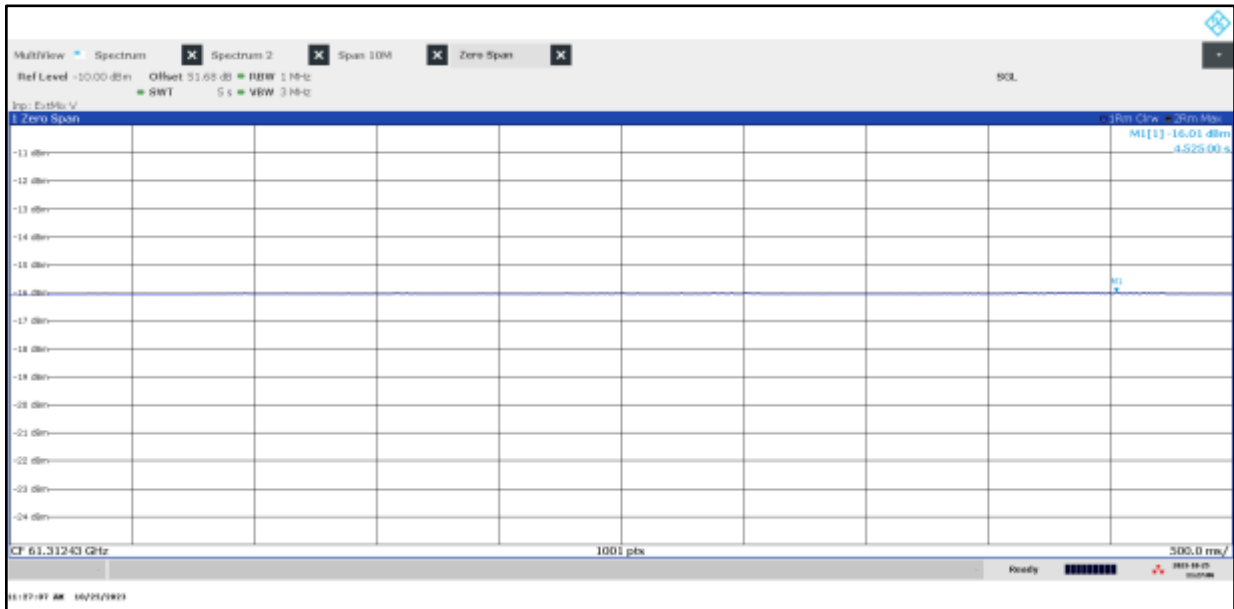

Plot 28: 50 GHz – 75 GHz, stop mode, high frequency, EUT3

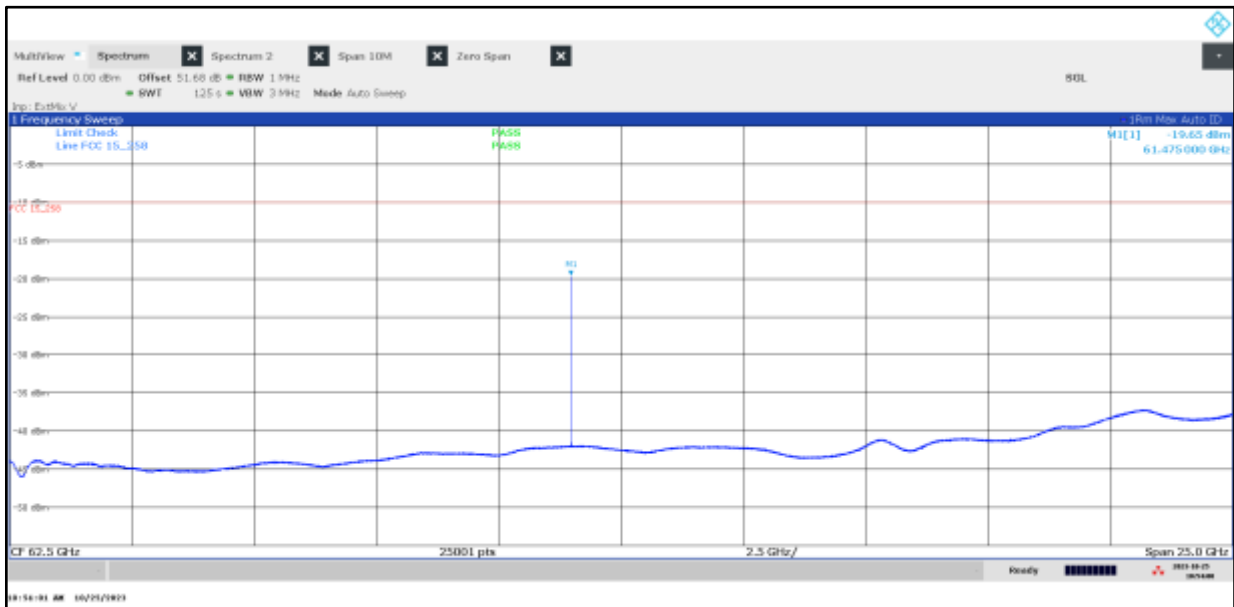

Plot 29: 61.47 GHz, stop mode, high frequency, spurious emissions, EUT3

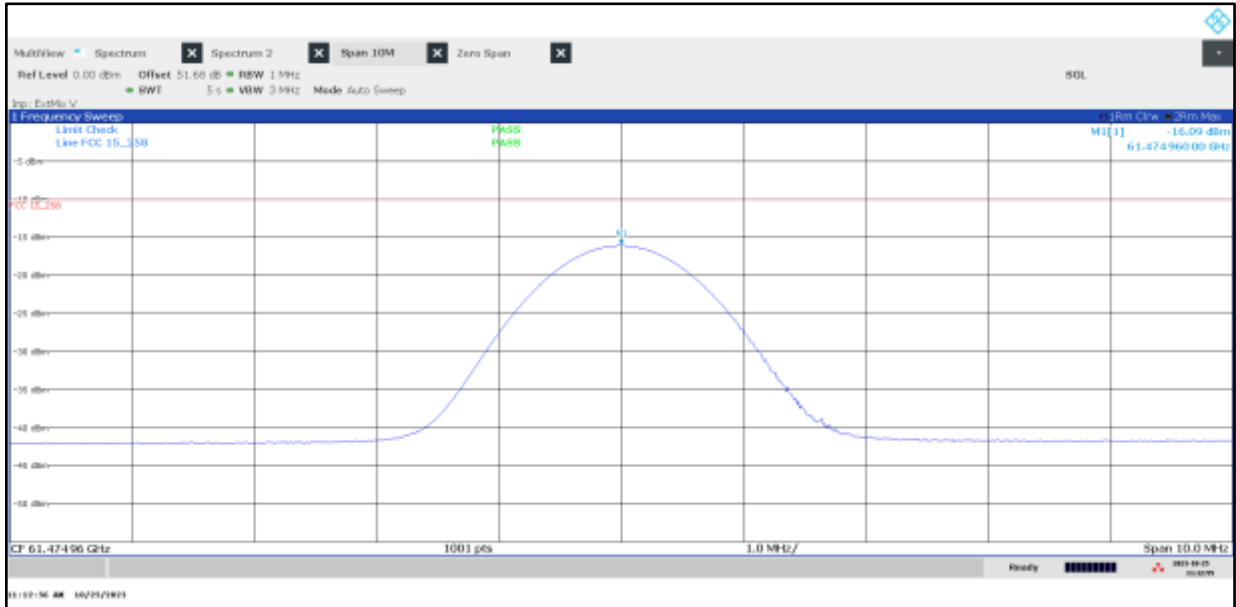

Plot 30: 61.47 GHz, stop mode, high frequency, spurious emissions, EUT3

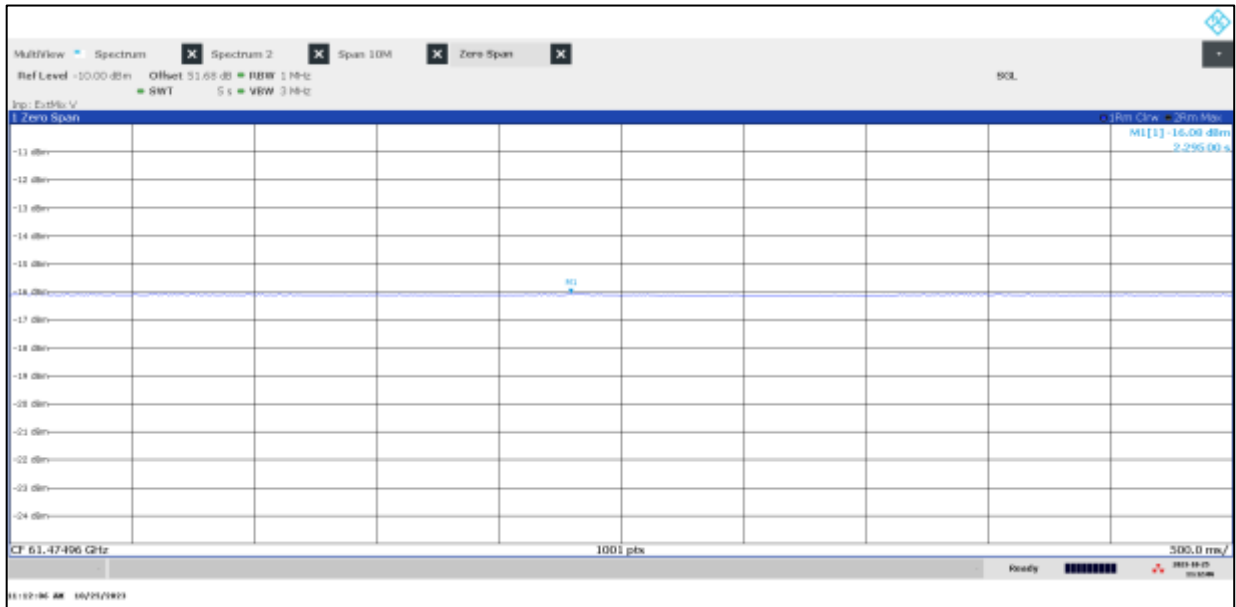

Plot 31: 75 GHz – 90 GHz, stop mode, low frequency, EUT 2

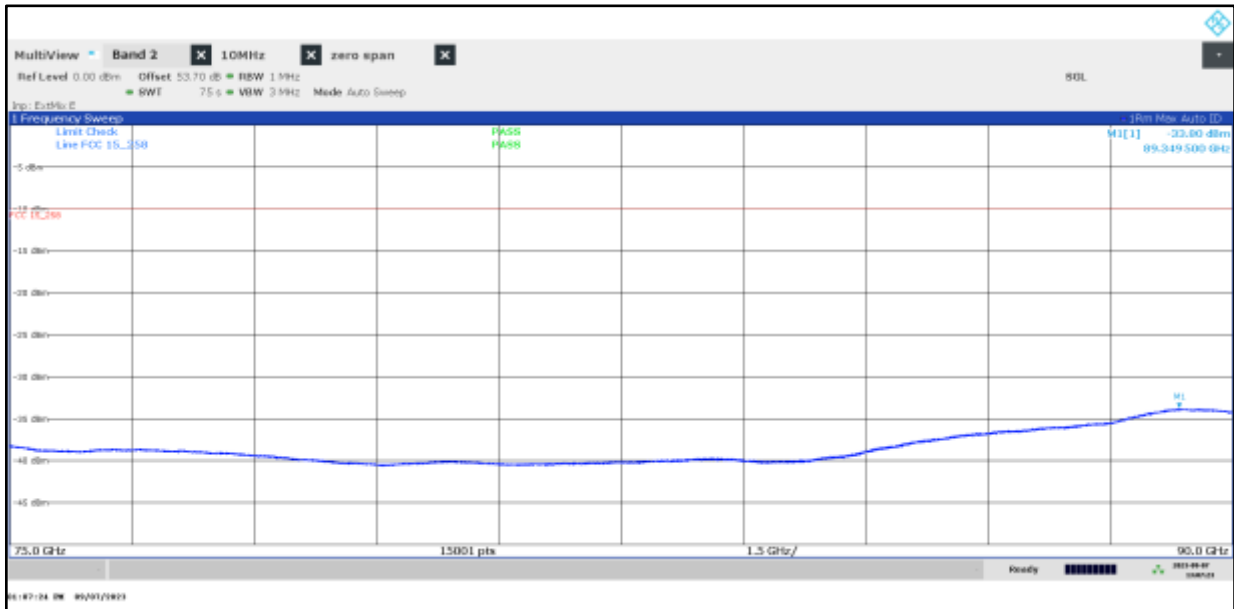

Plot 32: 75 GHz – 90 GHz, stop mode, middle frequency, EUT 2

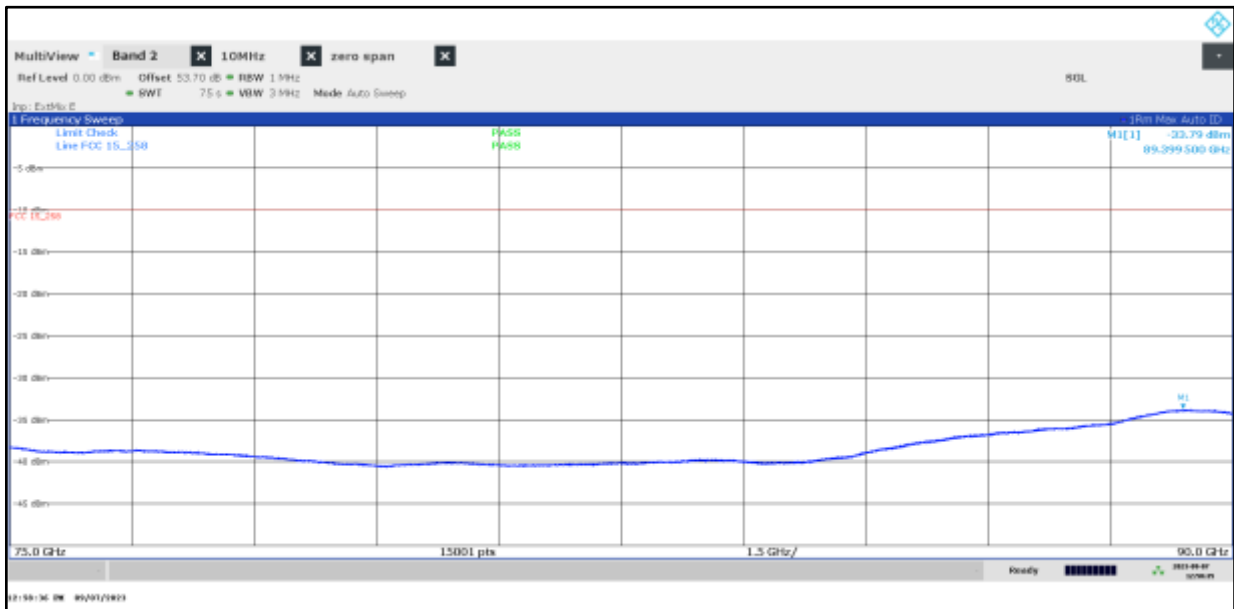

Plot 33: 75 GHz – 90 GHz, stop mode, high frequency, EUT 2

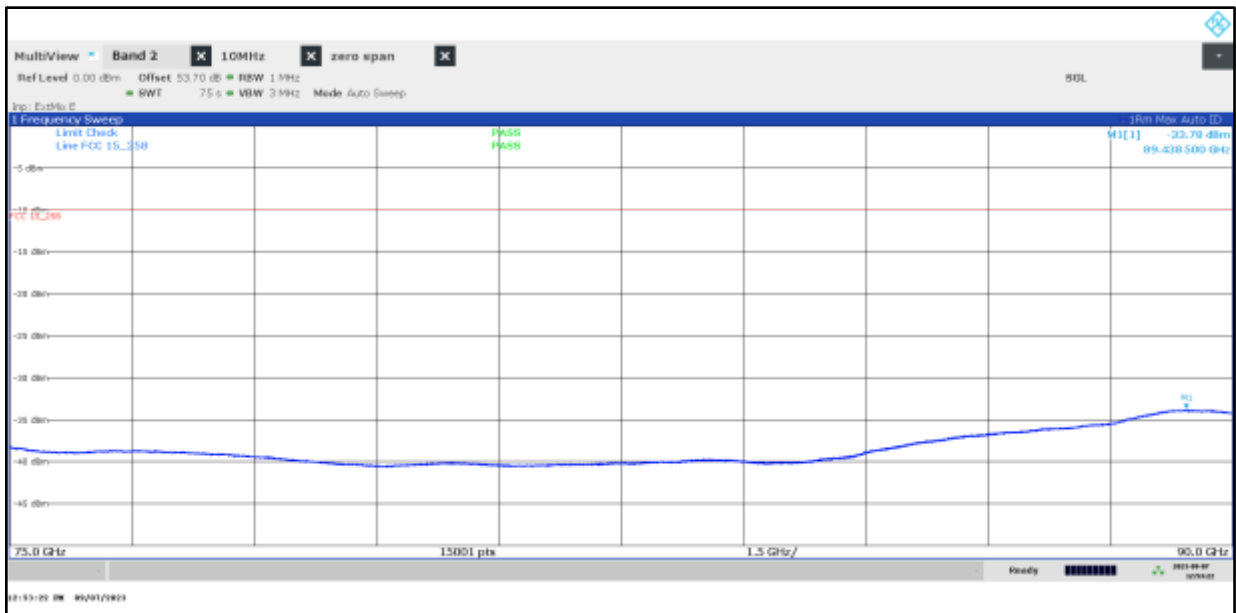

Plot 34: 90 GHz – 110 GHz, stop mode, low frequency, EUT 2

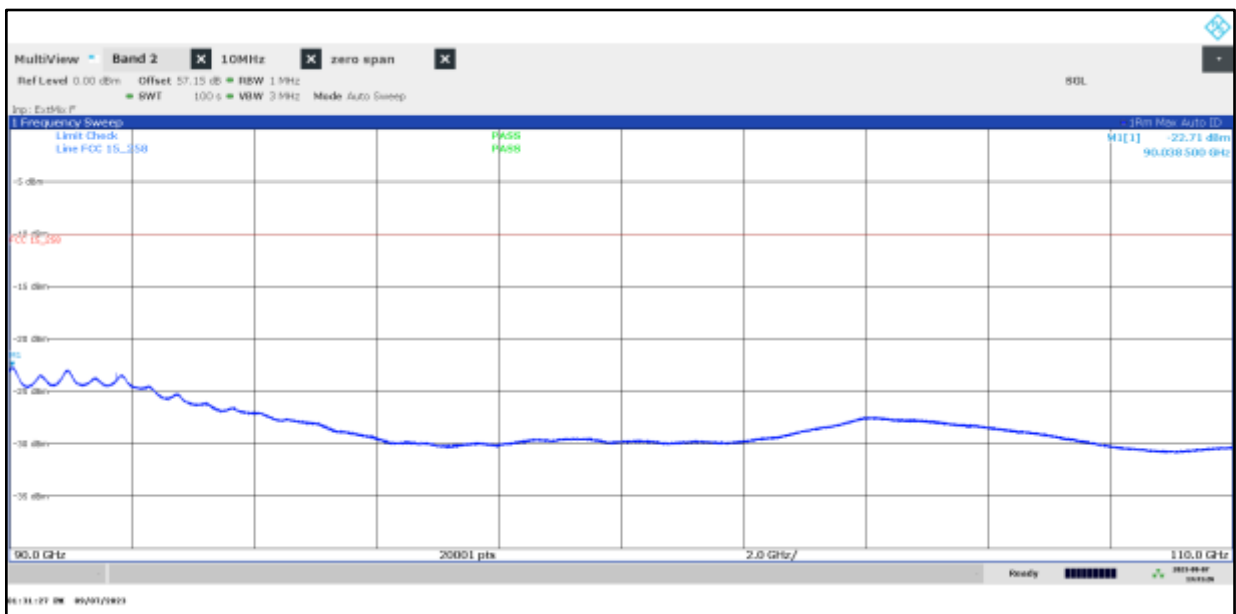

Plot 35: 90 GHz – 110 GHz, stop mode, middle frequency, EUT 2

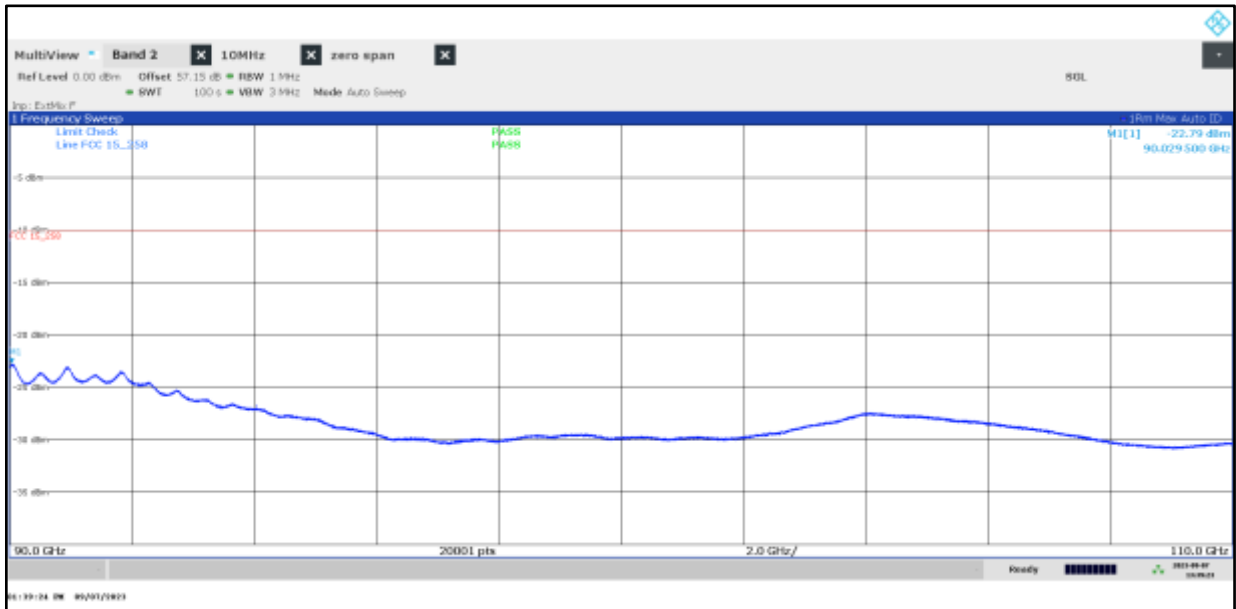

Plot 36: 90 GHz – 110 GHz, stop mode, high frequency, EUT 2

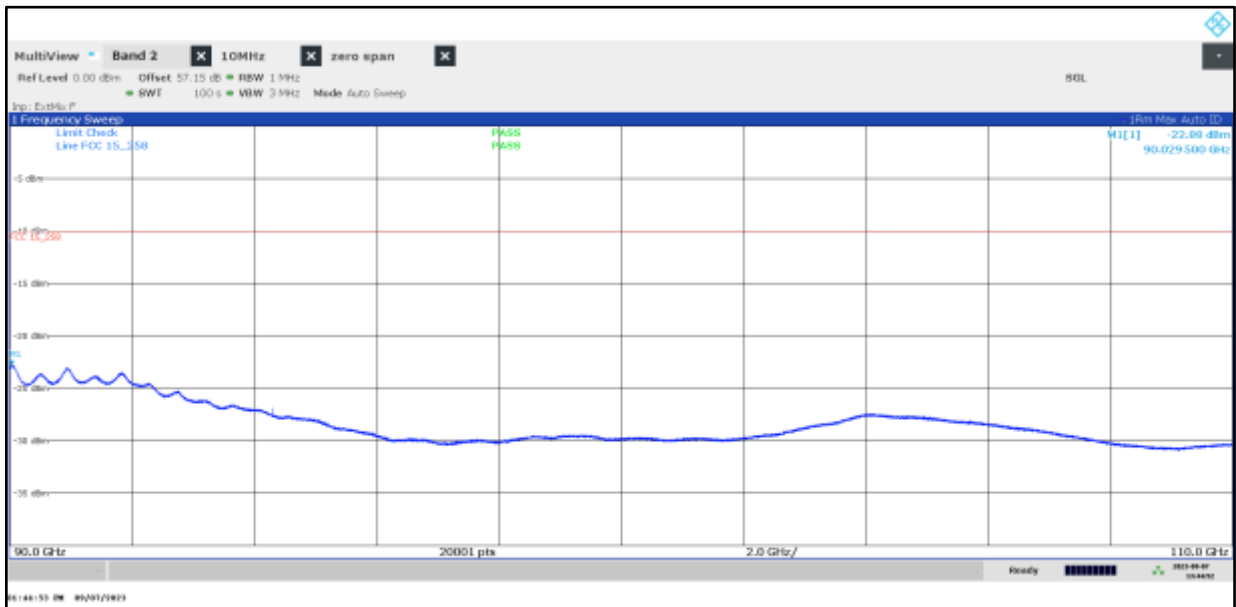

Plot 37: 110 GHz – 115 GHz, stop mode, low frequency, EUT 2

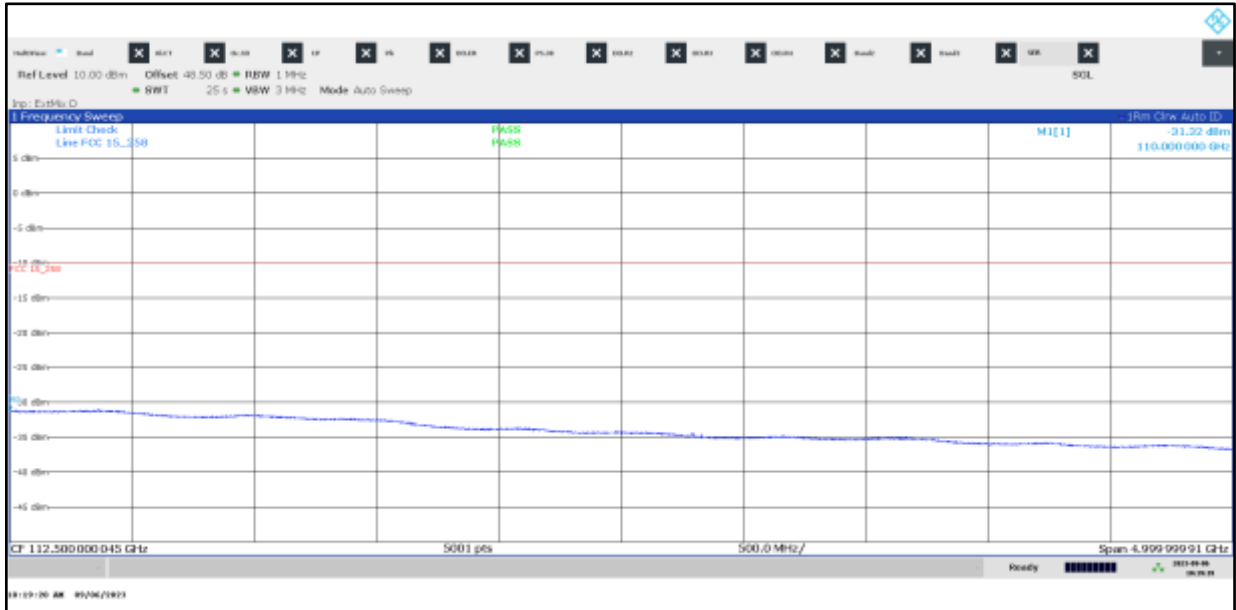

Plot 38: 110 GHz – 115 GHz, stop mode, middle frequency, EUT 2

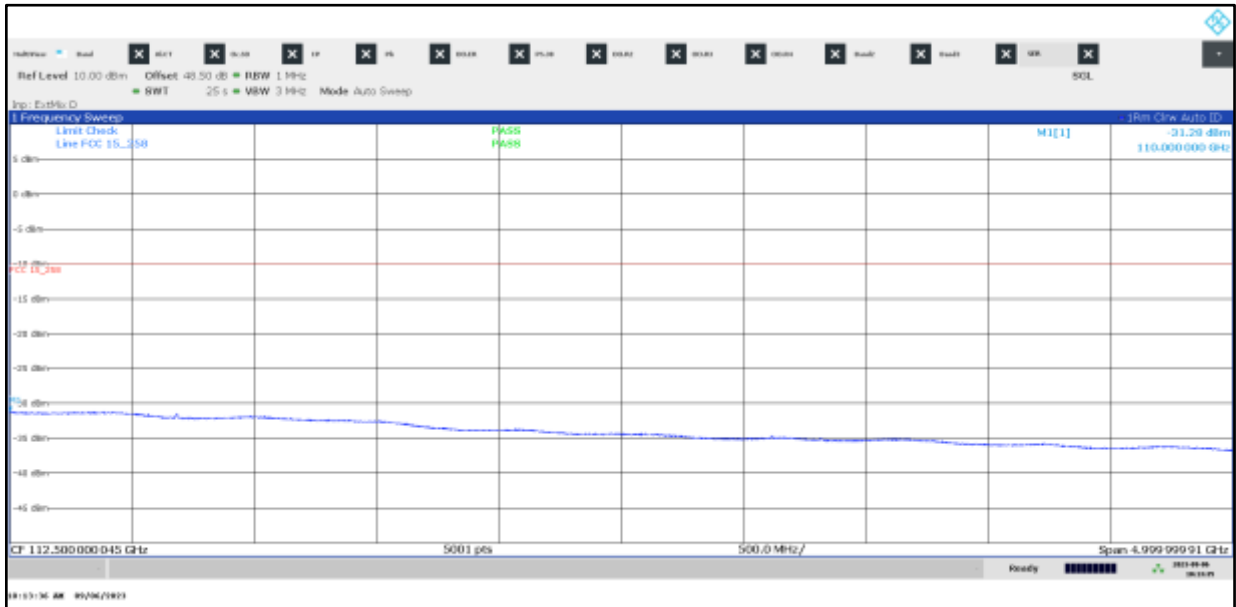

Plot 39: 110 GHz – 115 GHz, stop mode, high frequency, EUT 2

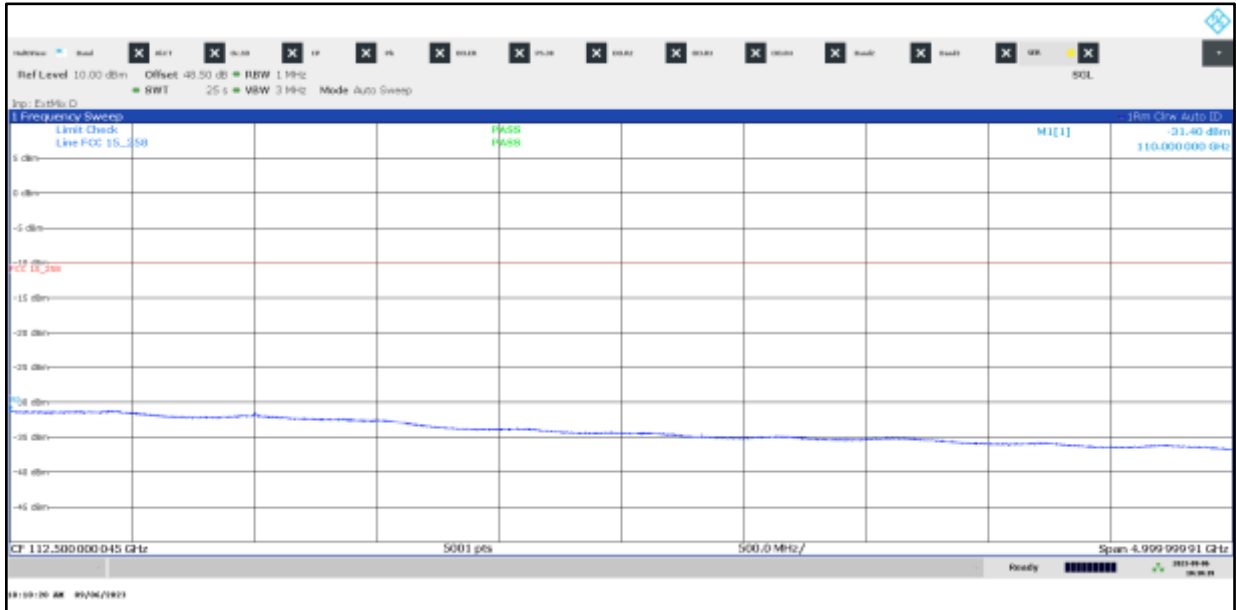

Plot 40: 115 GHz – 145 GHz, stop mode, low frequency, EUT 2

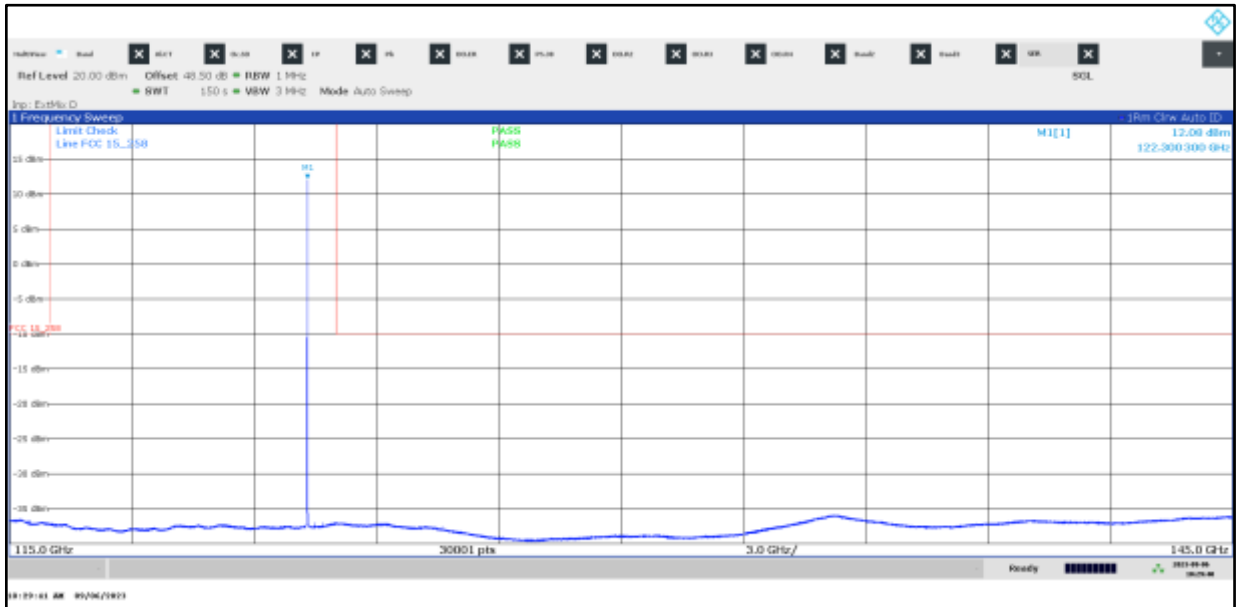

Plot 41: 115 GHz – 145 GHz , stop mode, middle frequency, EUT 2

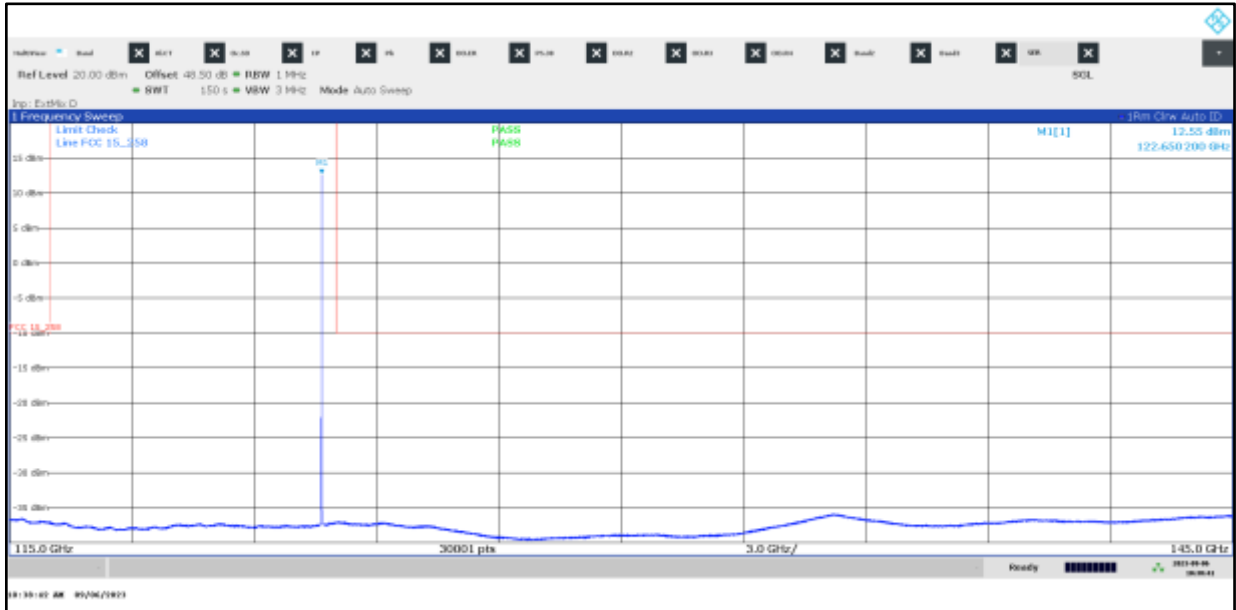

Plot 42: 115 GHz – 145 GHz, stop mode, high frequency, EUT 2



Plot 43: 145 GHz – 150 GHz, stop mode, low frequency, EUT 2

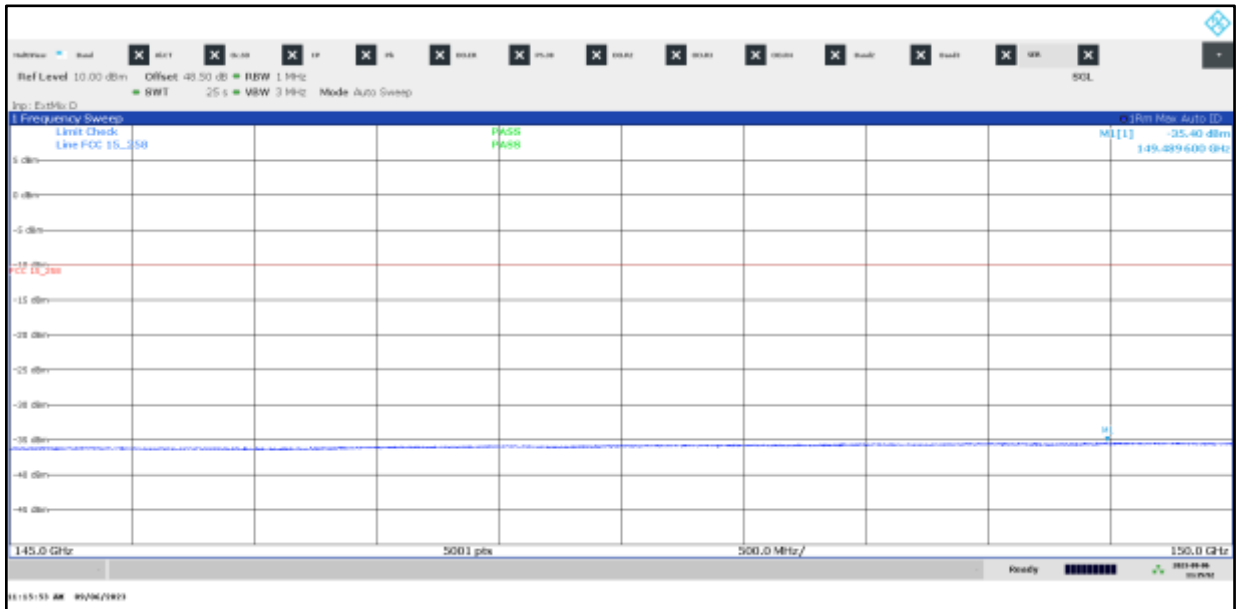

Plot 44: 145 GHz – 150 GHz, stop mode, middle frequency, EUT 2

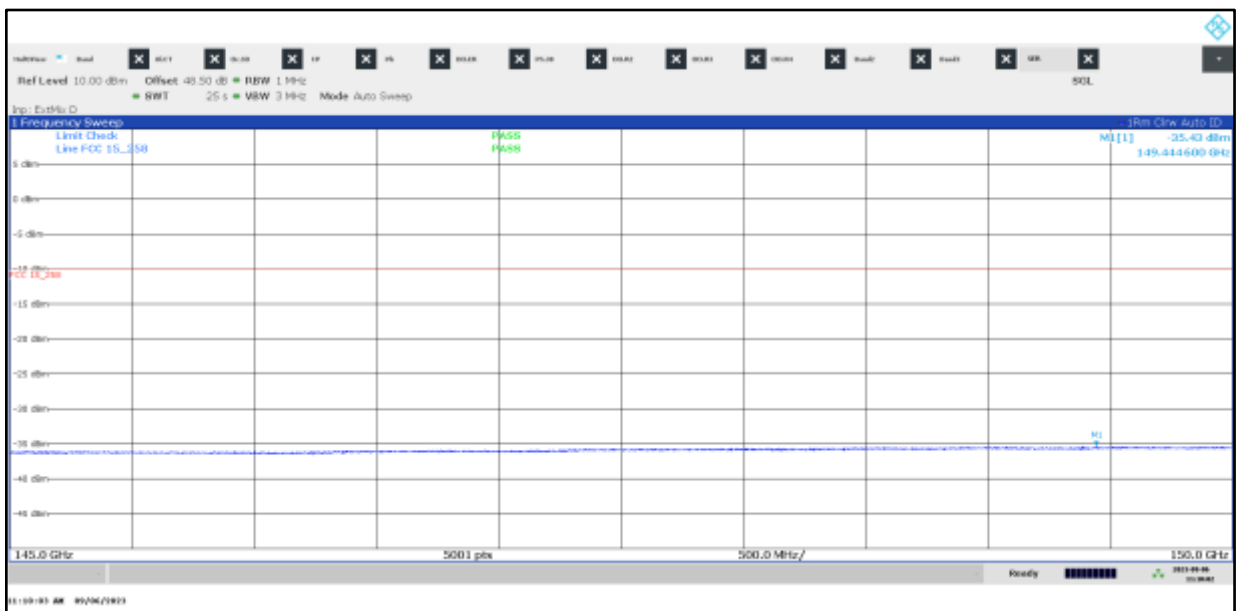

Plot 45: 145 GHz – 150 GHz, stop mode, high frequency, EUT 2

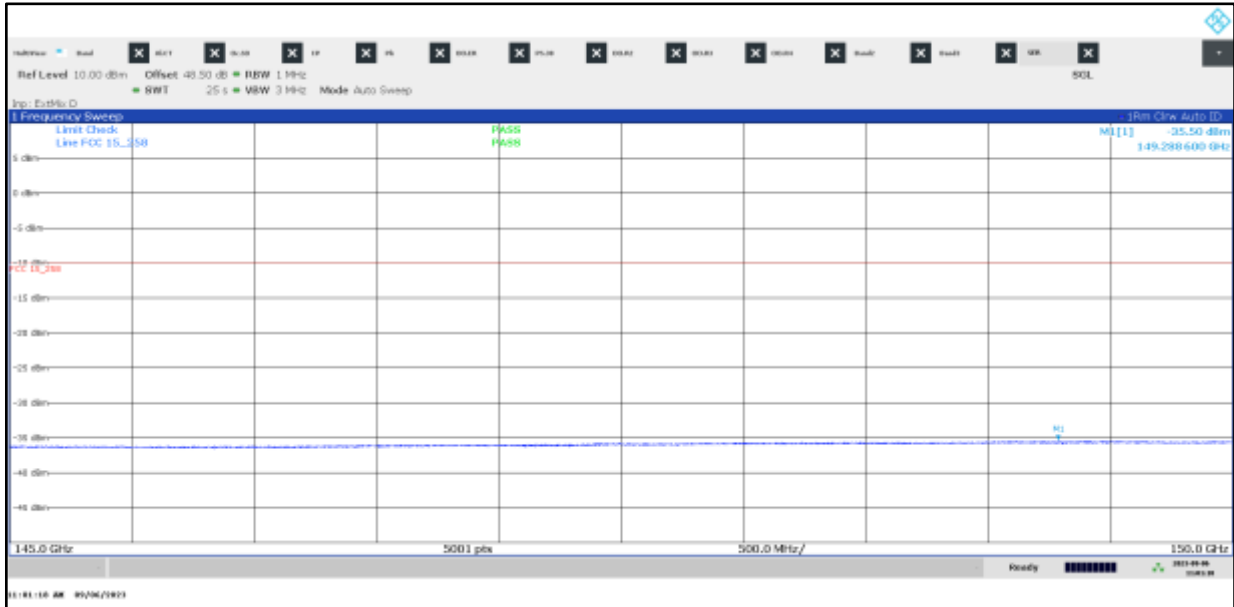

Plot 46: 150 GHz – 170 GHz, stop mode, low frequency, EUT 2

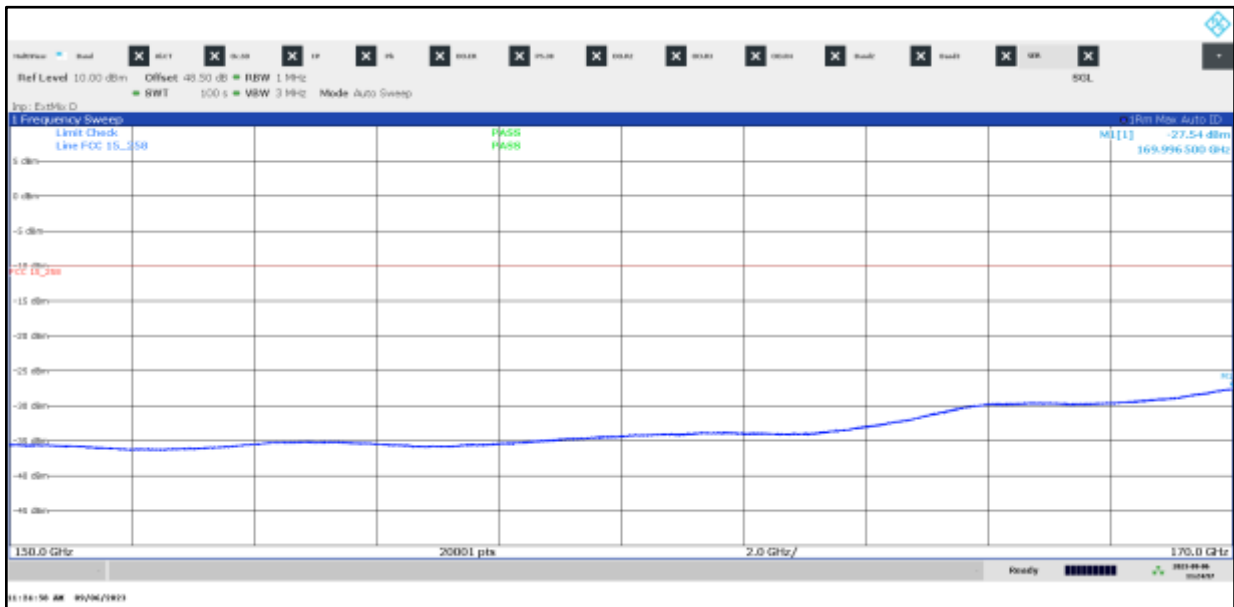

Plot 47: 150 GHz – 170 GHz, stop mode, middle frequency, EUT 2

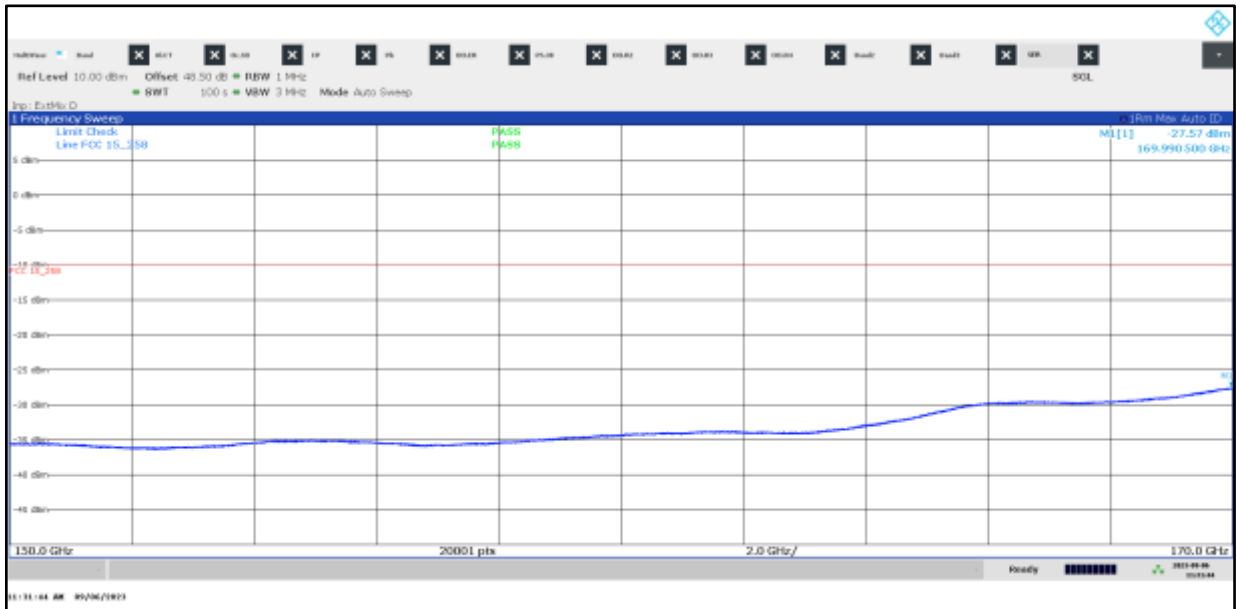

Plot 48: 150 GHz – 170 GHz, stop mode, high frequency, EUT 2

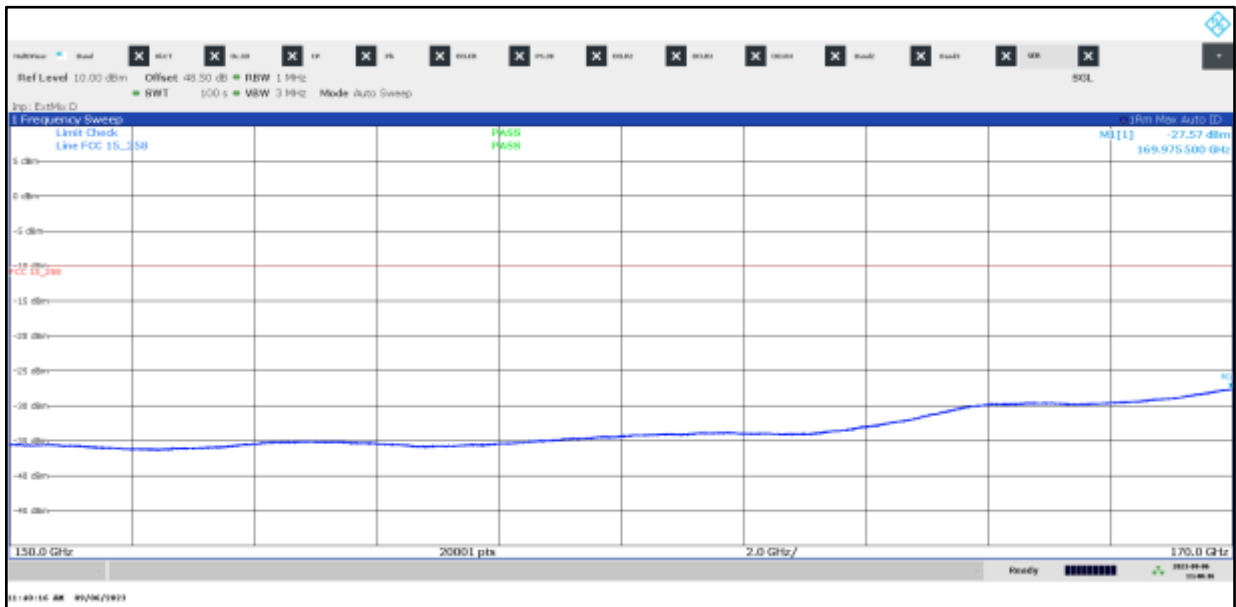

Plot 49: 170 GHz – 220 GHz, stop mode, low frequency, EUT 2



Plot 50: 183.45 GHz, stop mode, low frequency, spurious emission, EUT 2

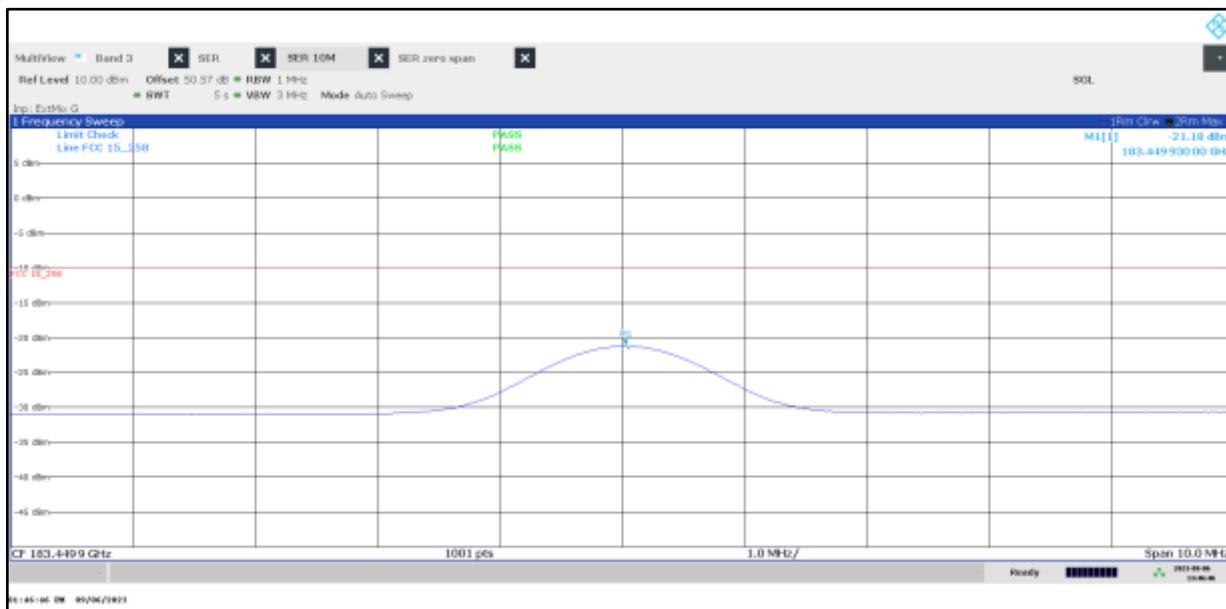

Plot 51: 183.45 GHz, stop mode, low frequency, spurious emission, EUT 2

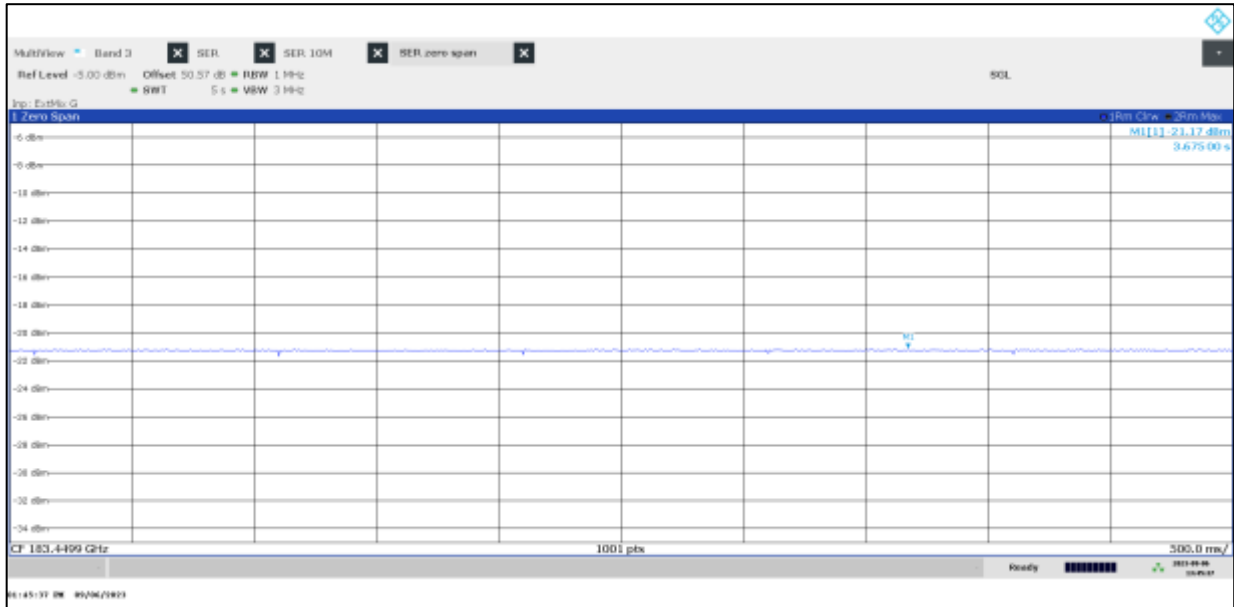

Plot 52: 170 GHz – 220 GHz, stop mode, middle frequency, EUT 2

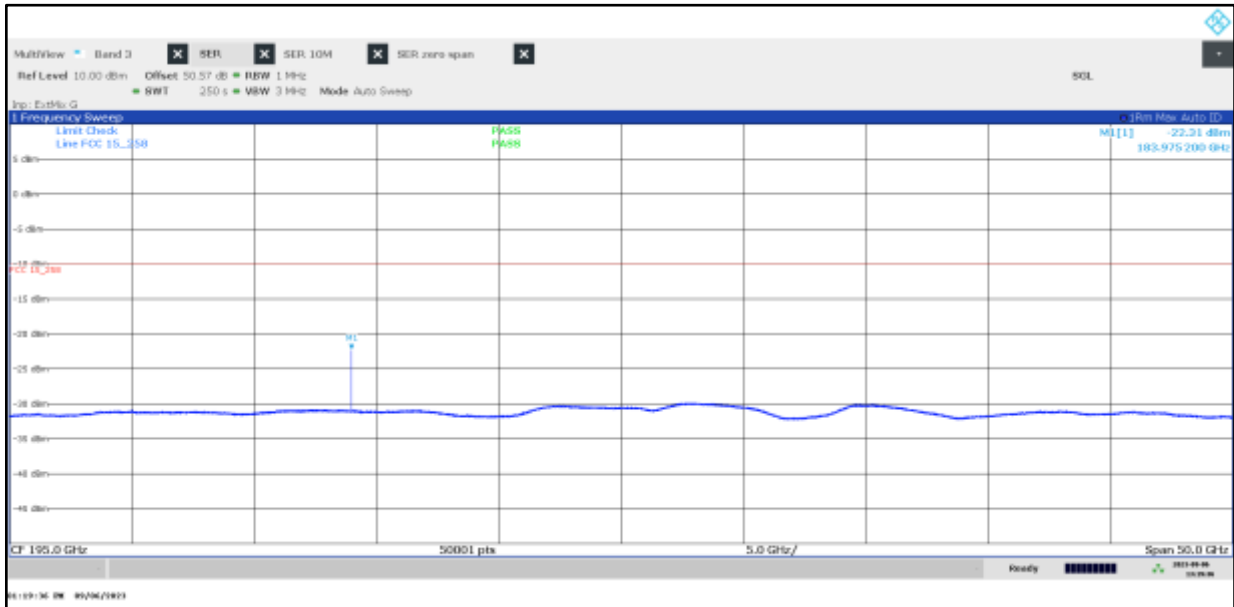

Plot 53: 183.97 GHz, stop mode, middle frequency, spurious emission, EUT 2

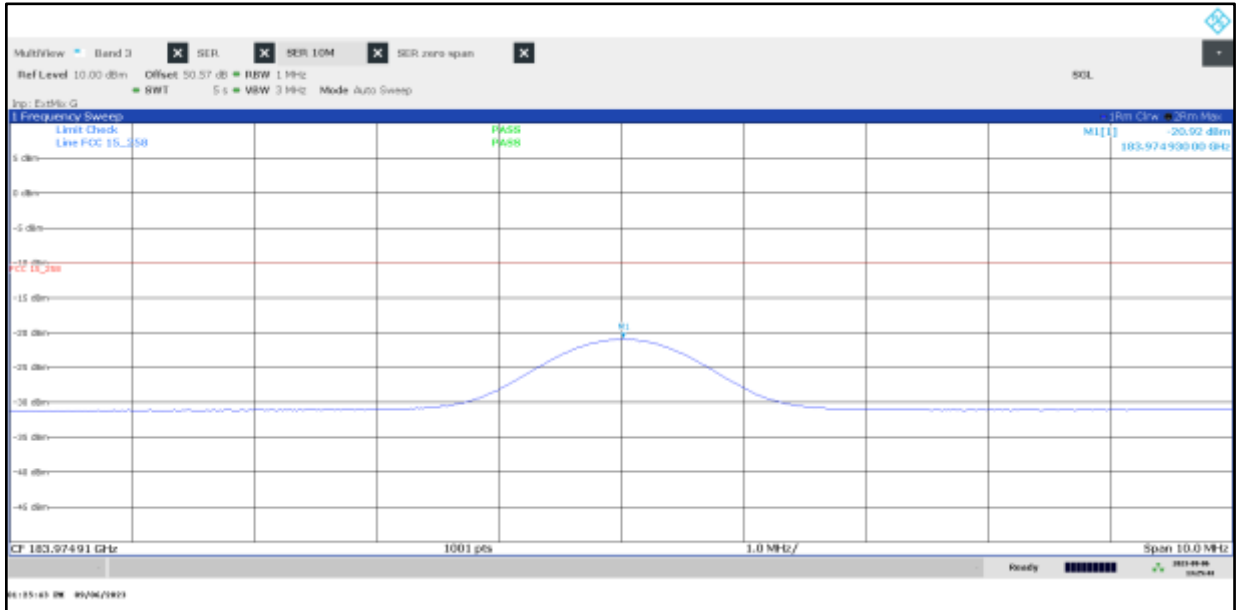

Plot 54: 183.97 GHz, stop mode, middle frequency, spurious emission, EUT 2

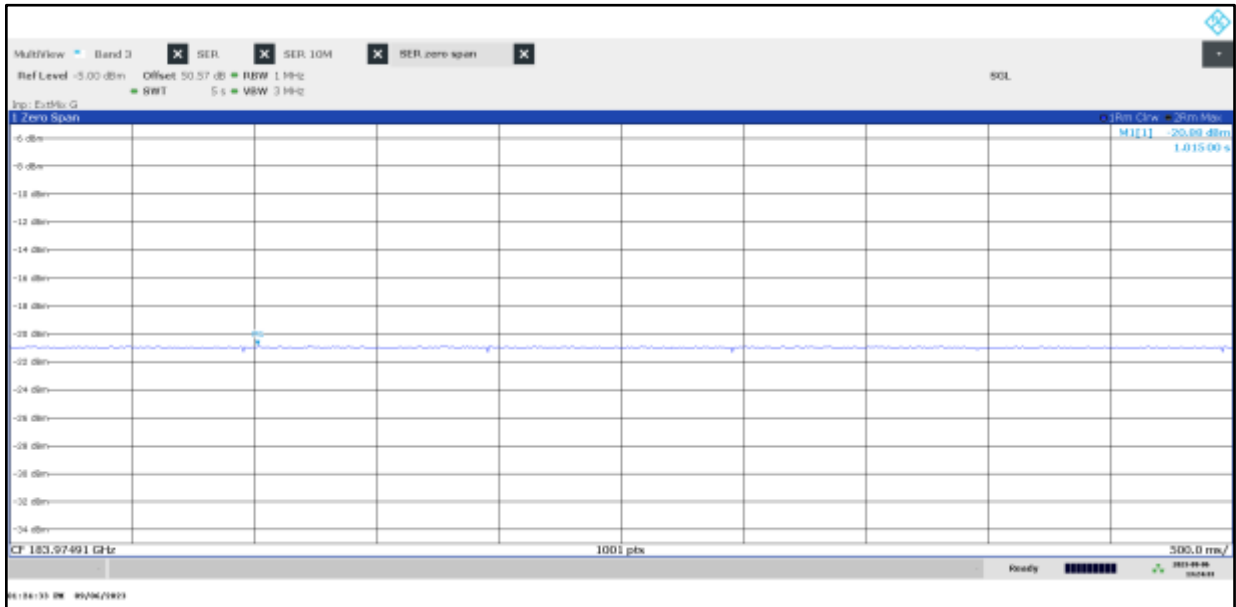

Plot 55: 170 GHz – 220 GHz, stop mode, high frequency, EUT 2

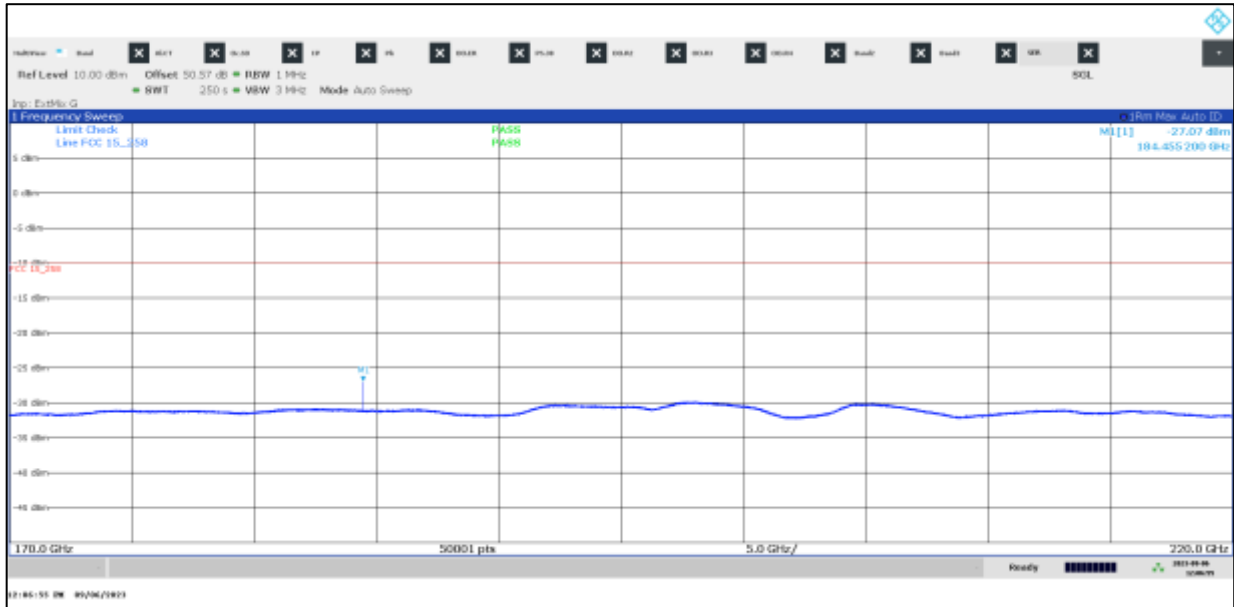

Plot 56: 184.4 GHz, stop mode, high frequency, spurious emission, EUT 2

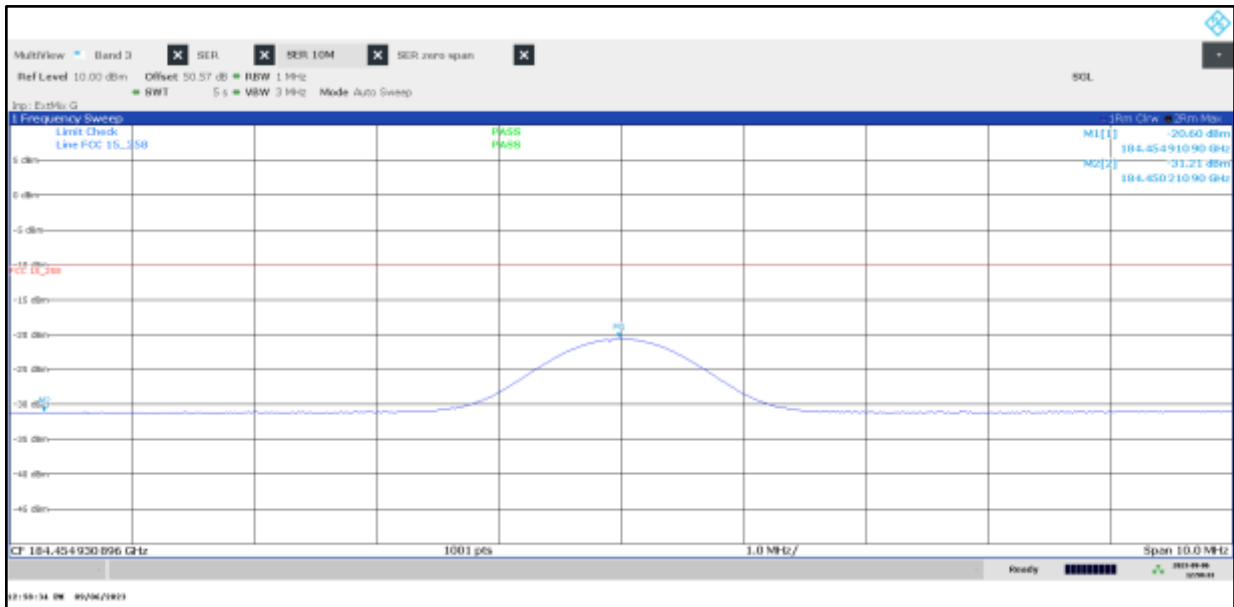

Plot 57: 184.4 GHz, stop mode, high frequency, spurious emission, EUT 2

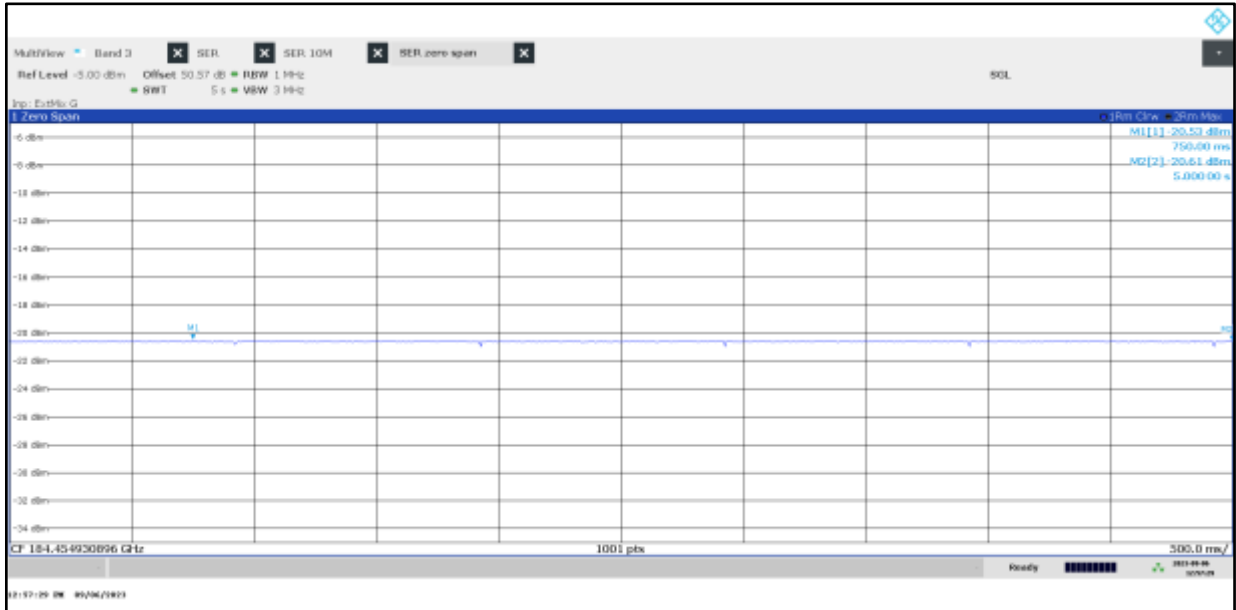

Plot 58: 220 GHz – 300 GHz, stop mode, low frequency, EUT 2

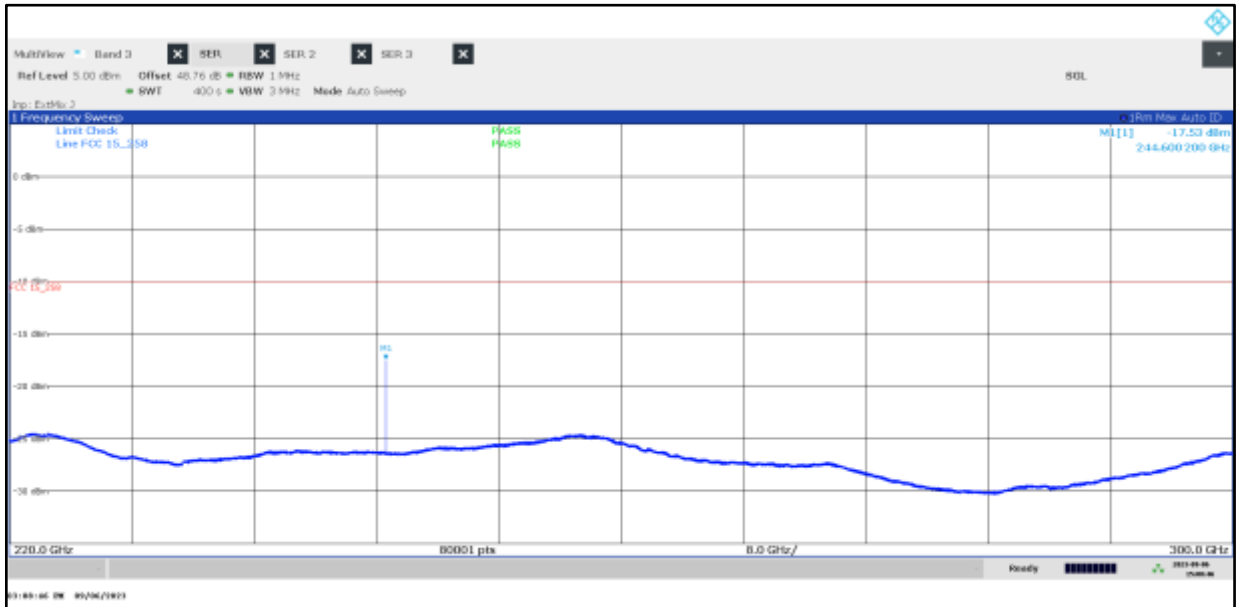

Plot 59: 244.6 GHz, stop mode, low frequency, spurious emission, EUT 2

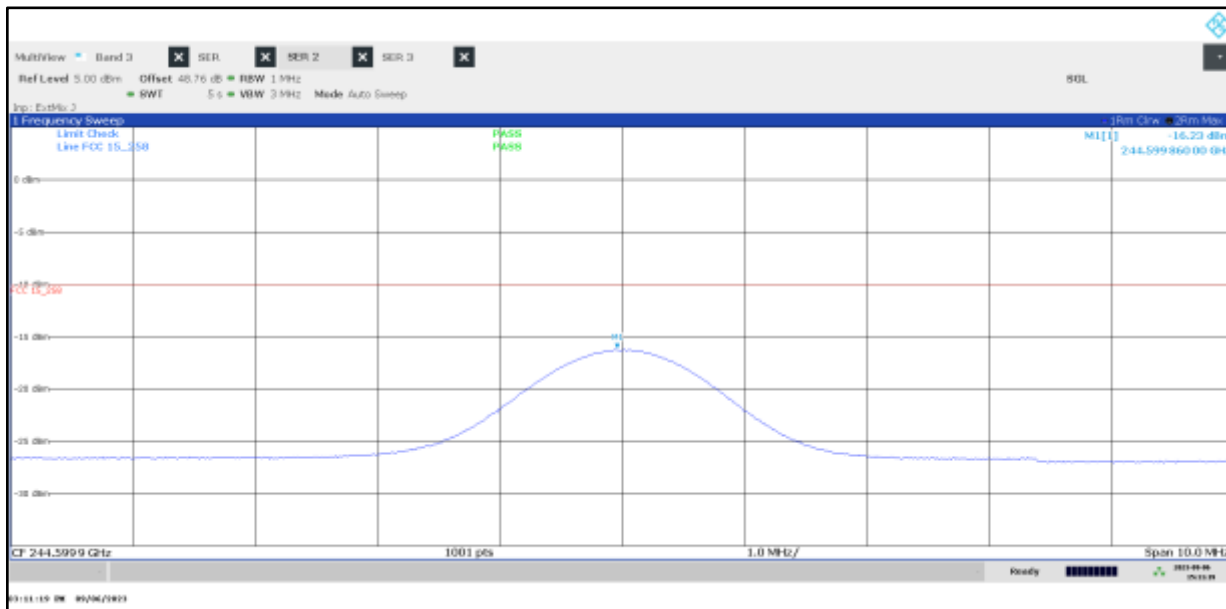

Plot 60: 244.6 GHz, stop mode, low frequency, spurious emission, EUT 2

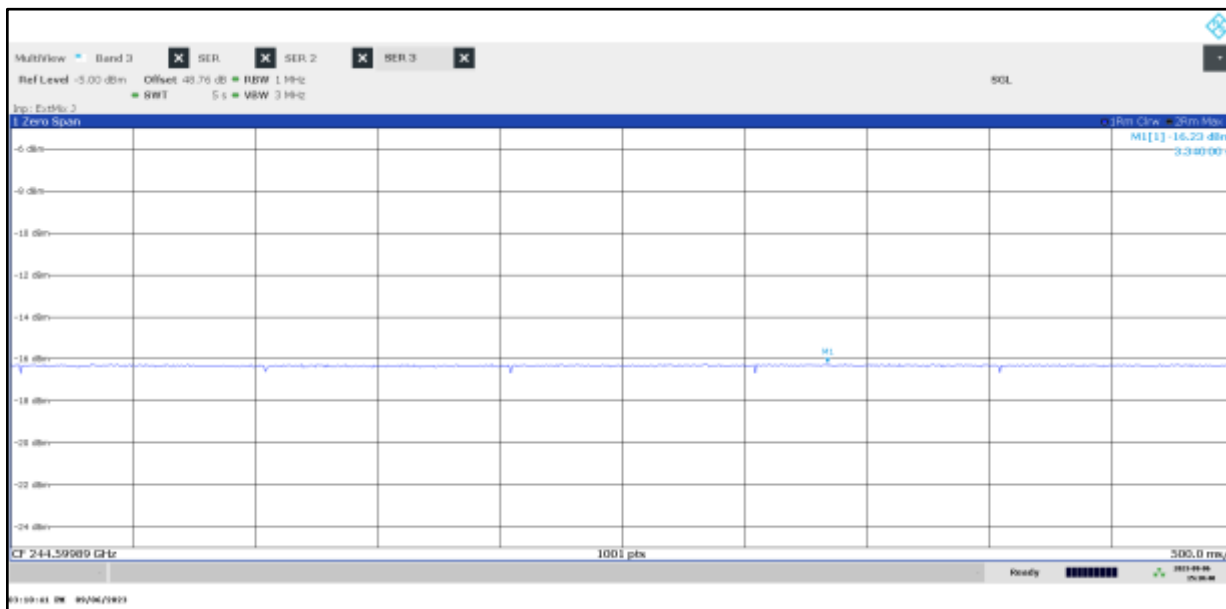

Plot 61: 220 GHz – 300 GHz, stop mode, middle frequency, EUT 2

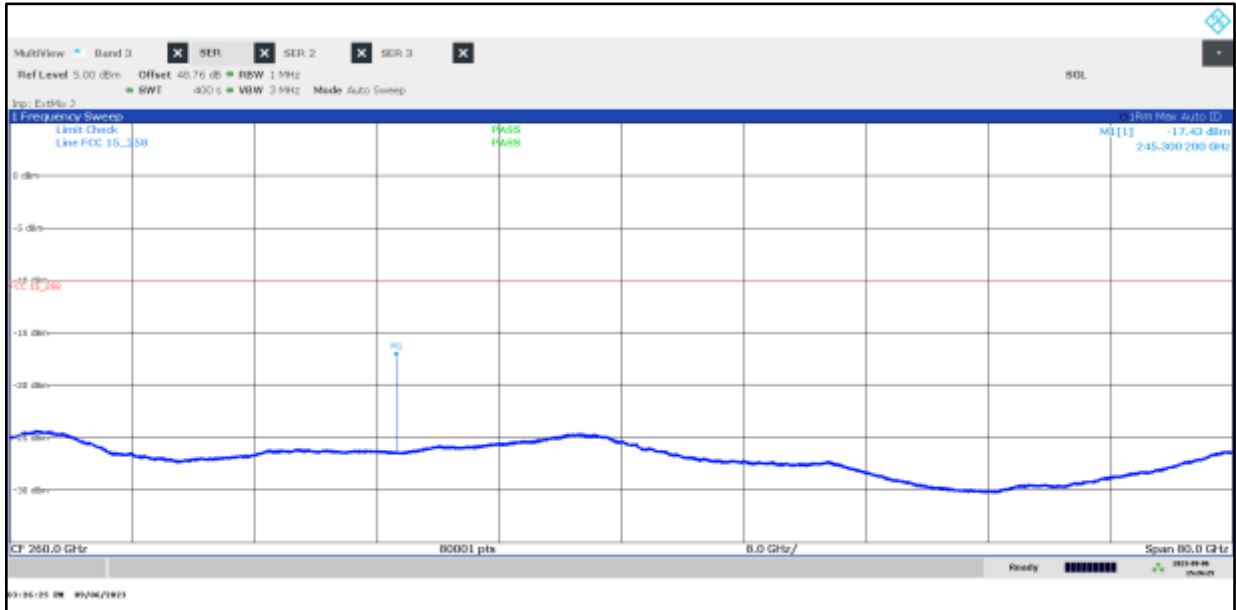

Plot 62: 245.3 GHz, stop mode, middle frequency, spurious emission, EUT 2

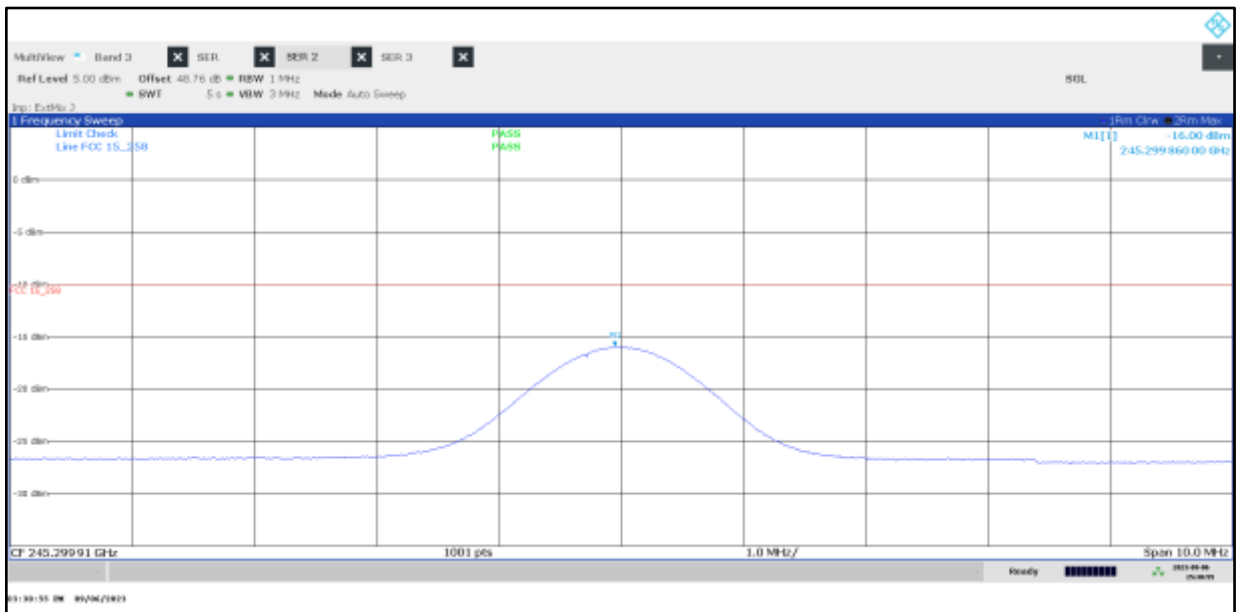

Plot 63: 245.3 GHz, stop mode, middle frequency, spurious emission, EUT 2

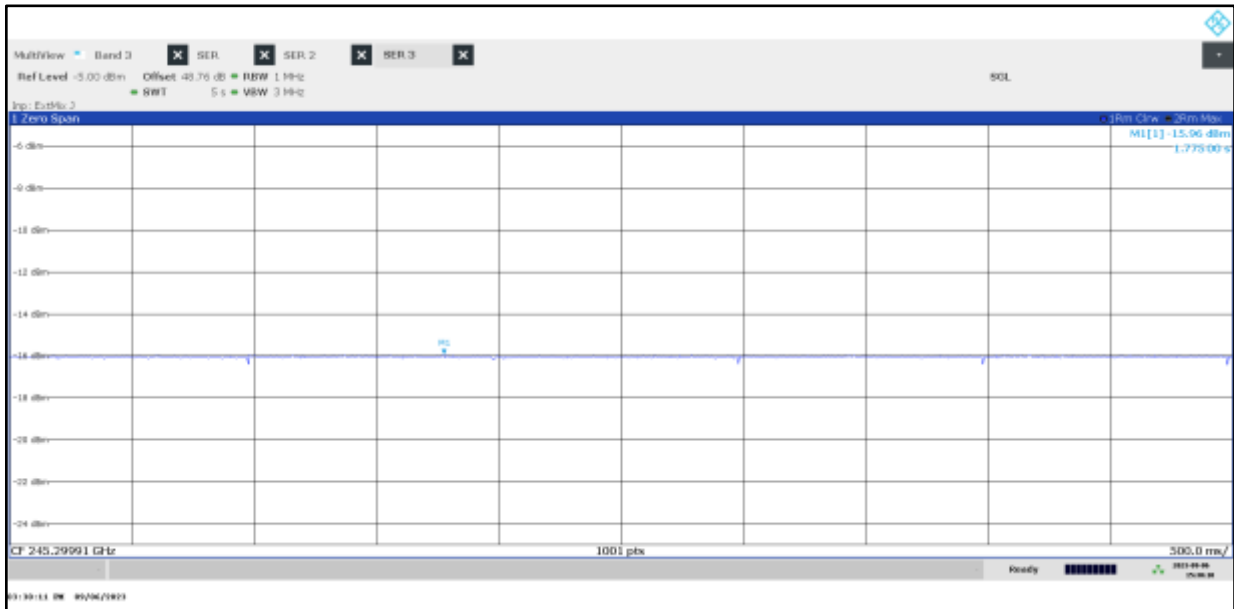

Plot 64: 220 GHz – 300 GHz, stop mode, high frequency, EUT 2

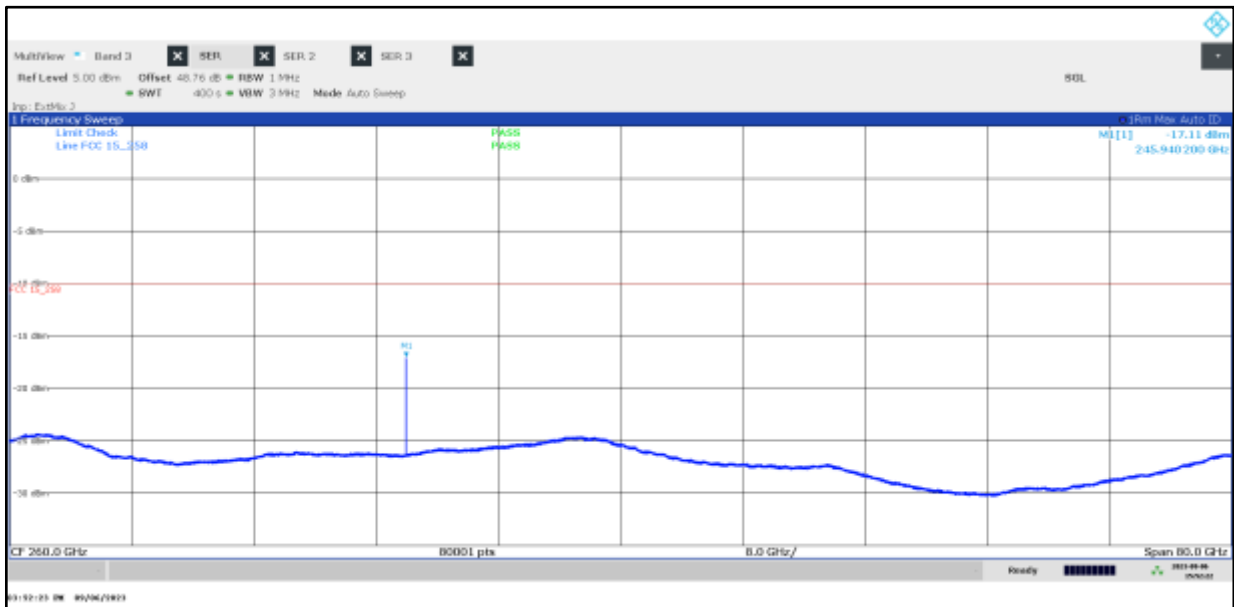

Plot 65: 245.9 GHz, stop mode, high frequency, spurious emission, EUT 2

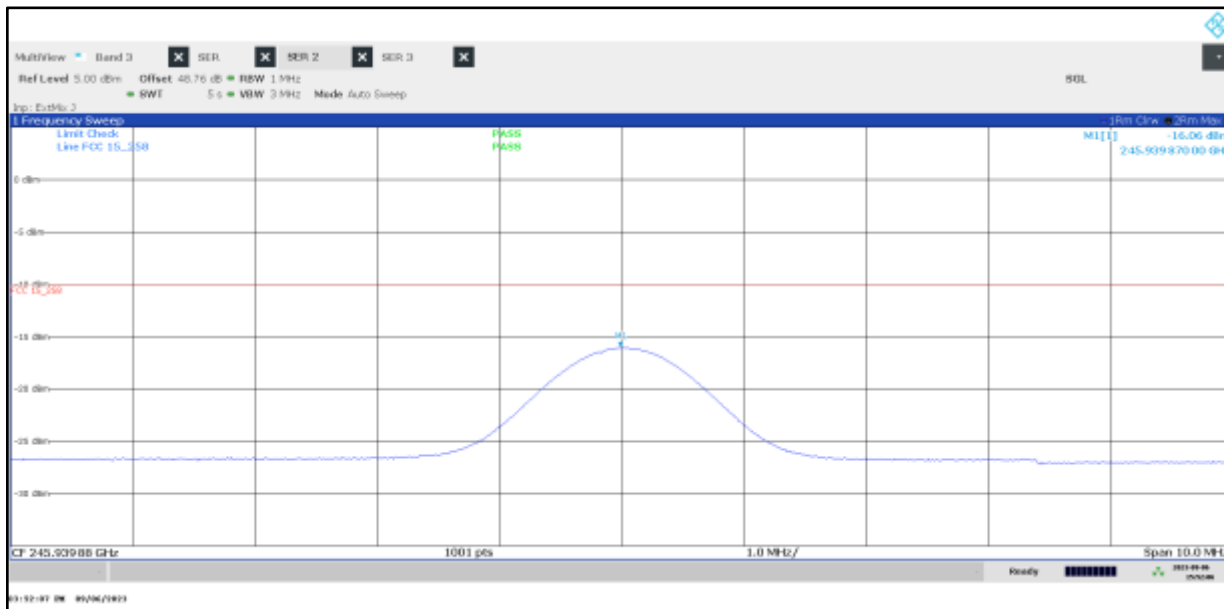

Plot 66: 245.9 GHz, stop mode, high frequency, spurious emission, EUT 2

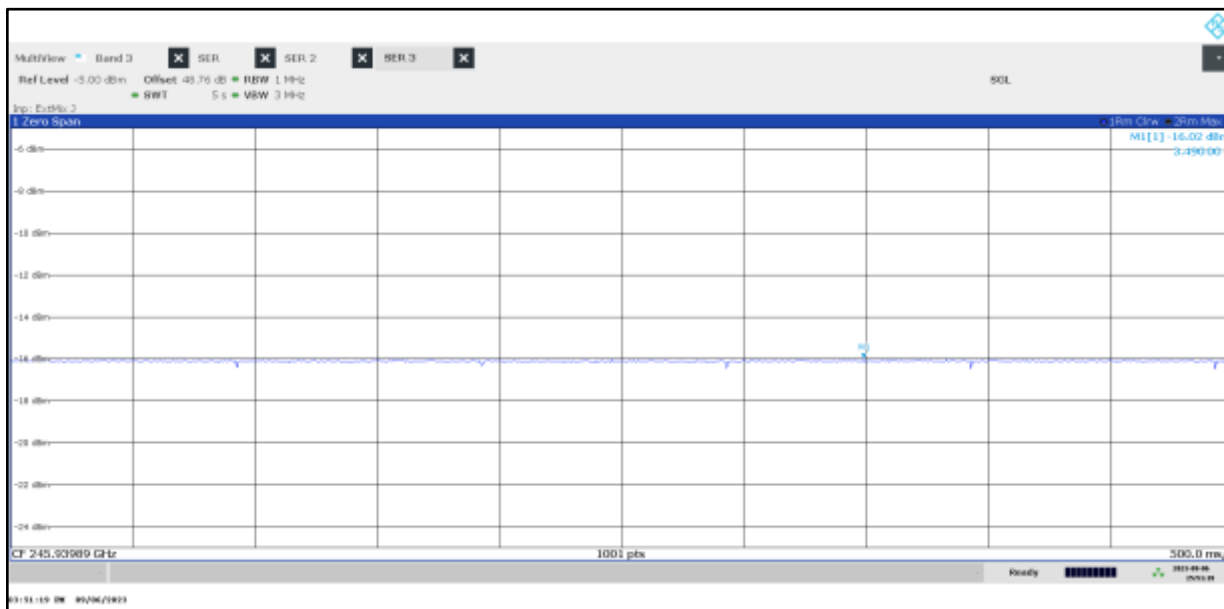

Plot 67: 300 GHz – 325 GHz, stop mode, low frequency, EUT 2

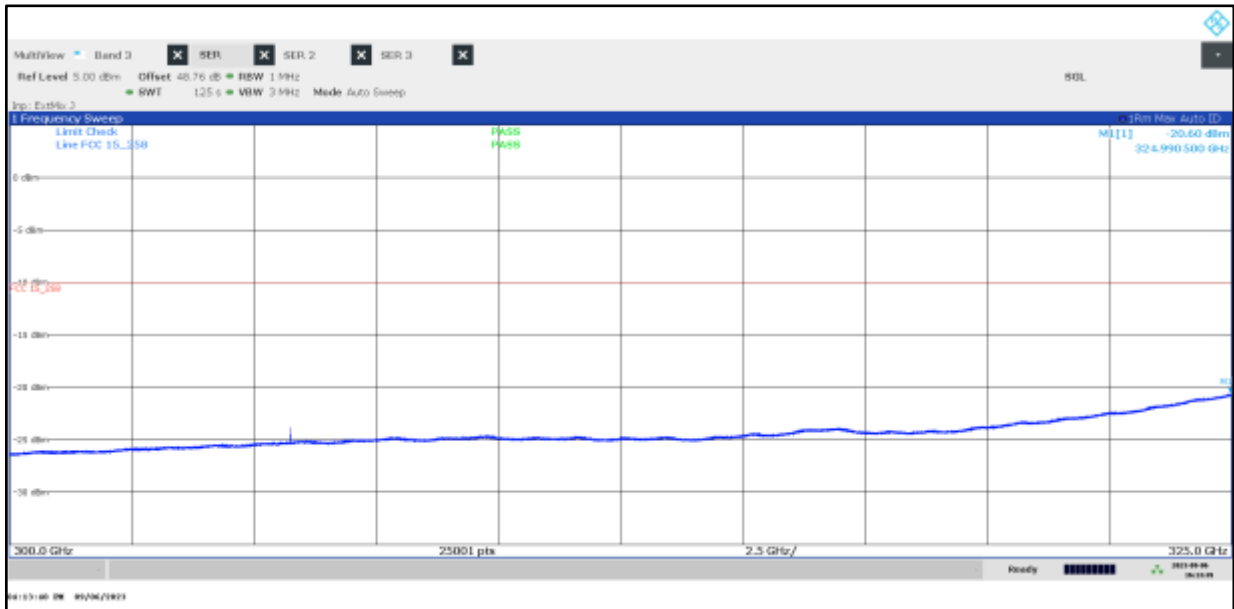

Plot 68: 300 GHz – 325 GHz, stop mode, middle frequency, EUT 2

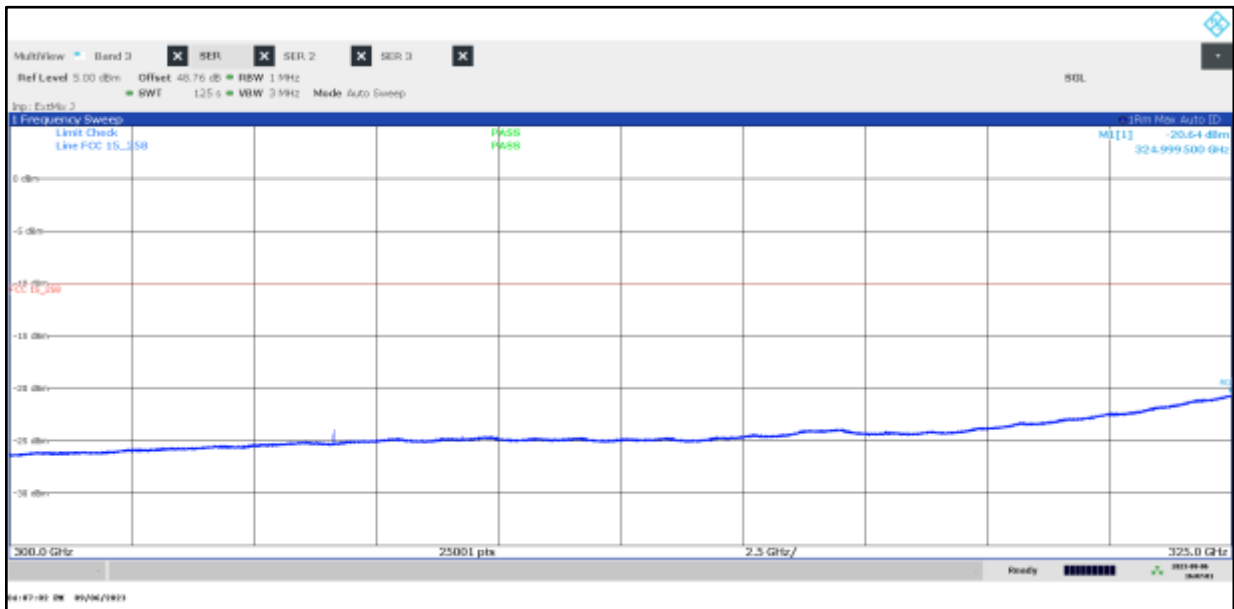

Plot 69: 300 GHz – 325 GHz, stop mode, high frequency, EUT 2

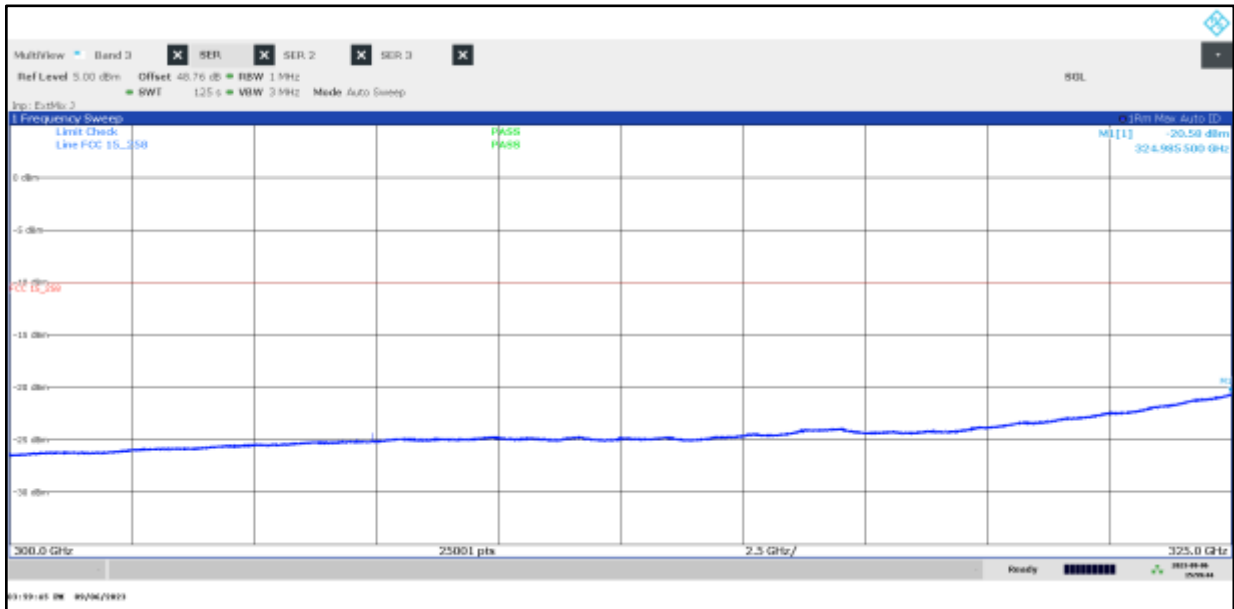

Plot 70: 325 GHz – 380 GHz, stop mode, low frequency, EUT 2

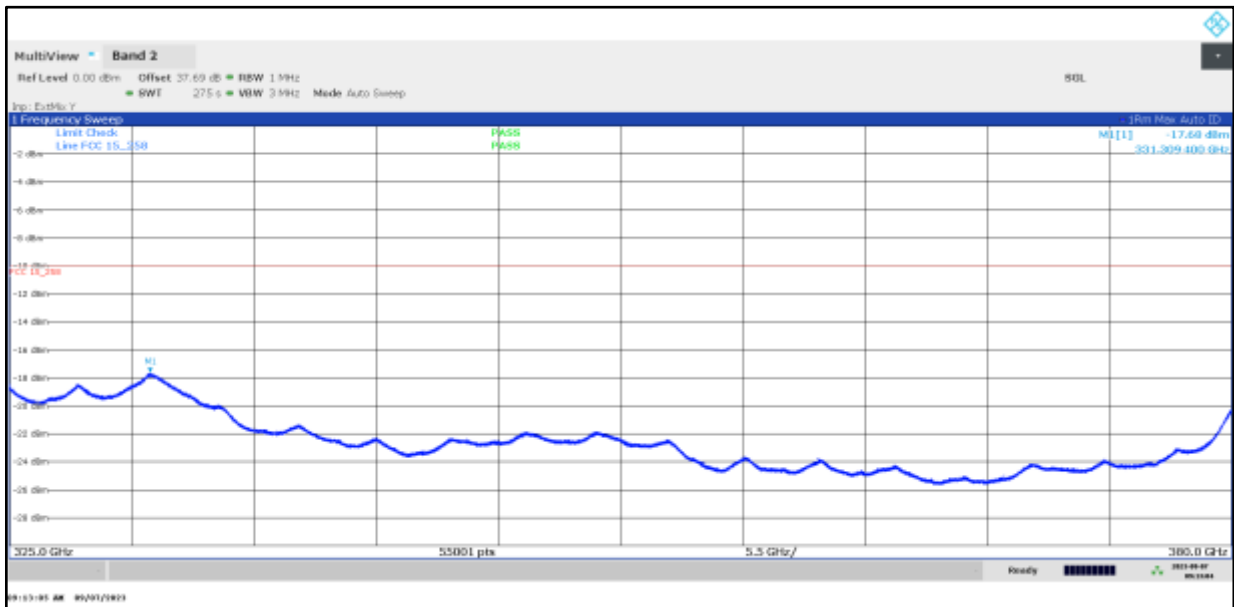

Plot 71: 325 GHz – 380 GHz, stop mode, middle frequency, EUT 2

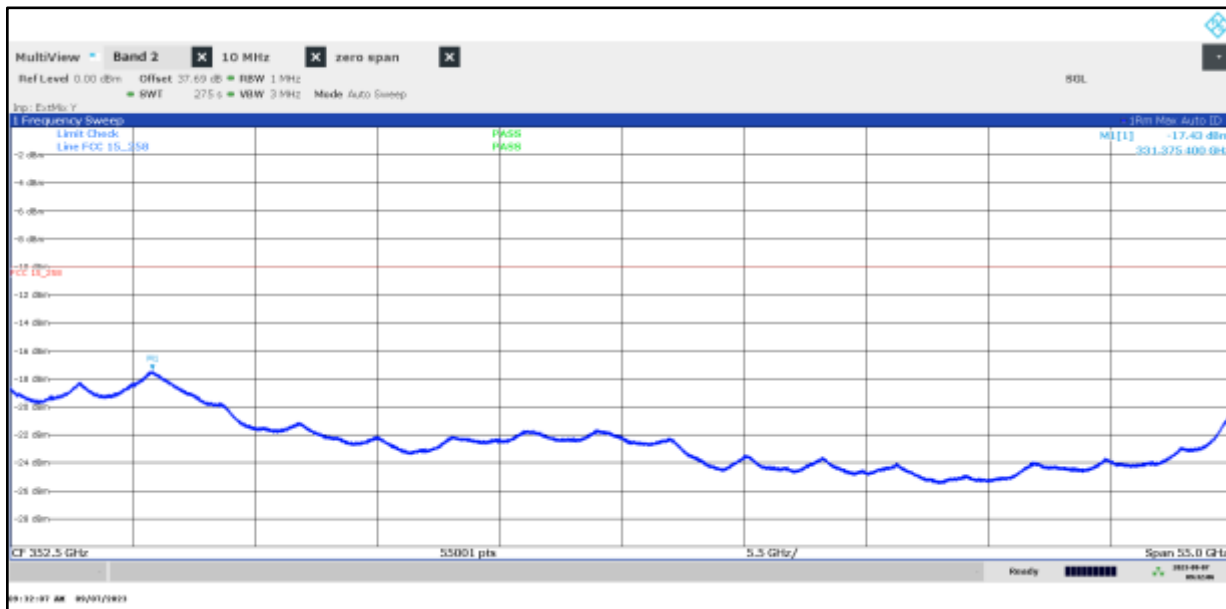

Plot 72: 325 GHz – 380 GHz, stop mode, high frequency, EUT 2

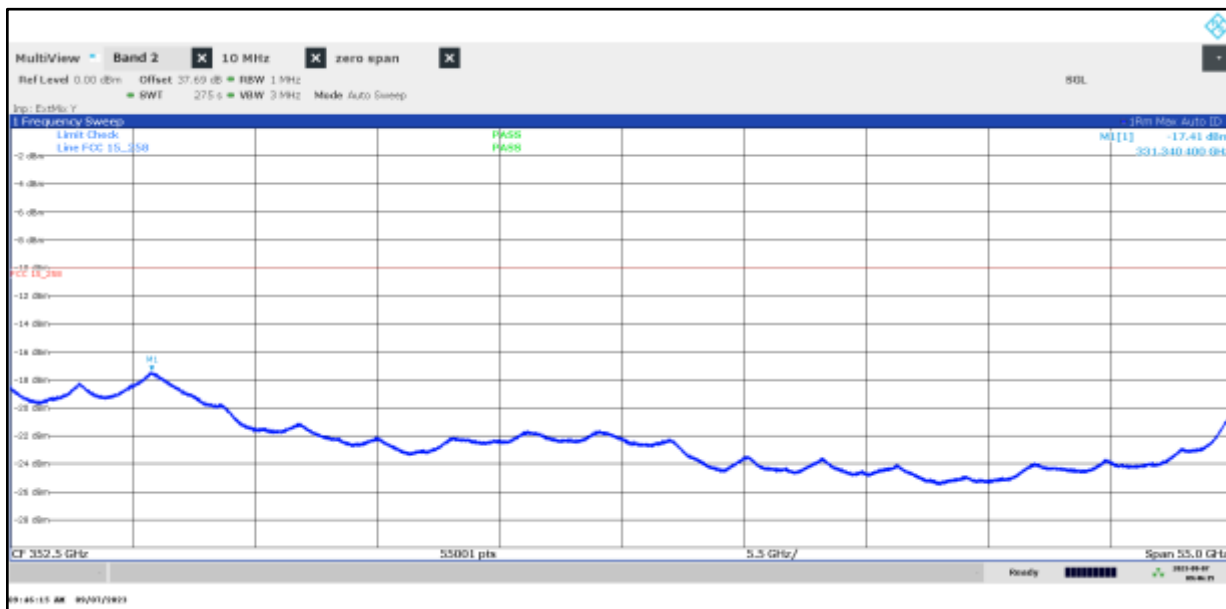

12.3.2 Normal mode spurious emissions radiated

Plot 73: 9 kHz – 30 MHz, normal operation mode, EUT 2

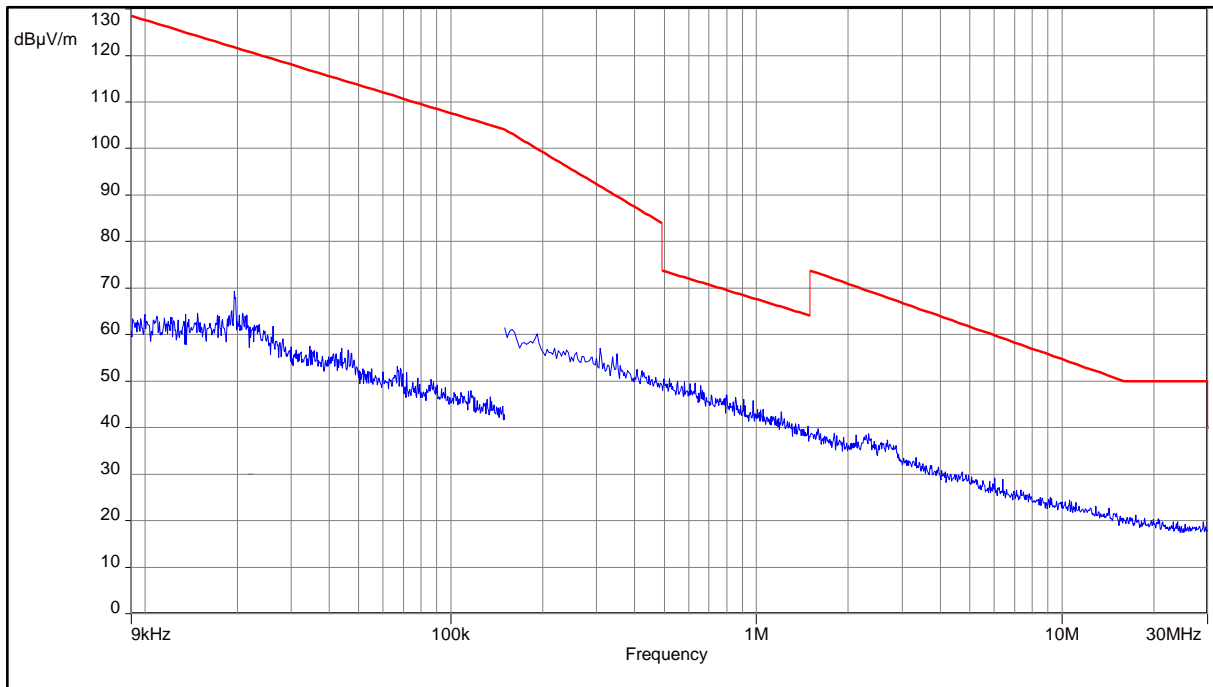

Plot 74: 30 MHz – 1GHz, normal operation mode, EUT 2

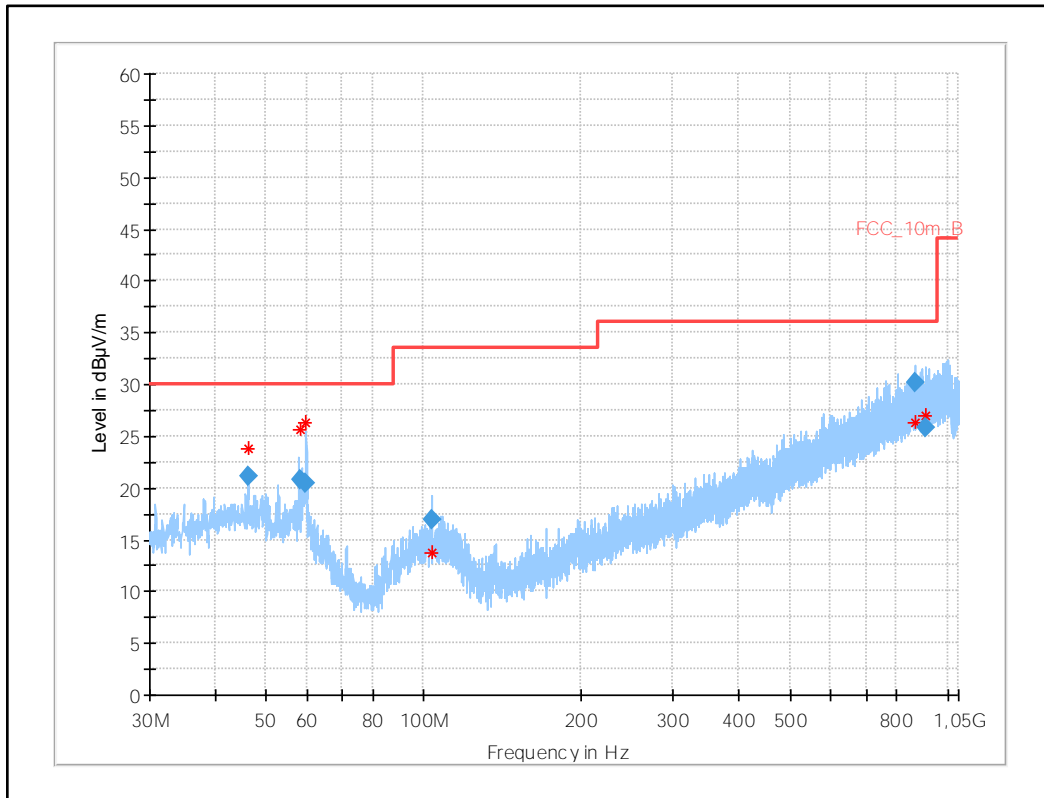

Frequency (MHz)	QuasiPeak (dBµV/m)	Limit (dBµV/m)	Margin (dB)	Meas. Time (ms)	Bandwidth (kHz)	Height (cm)	Pol	Azimuth (deg)	Corr. (dB/m)
46.279	21.20	30.0	8.8	1000	120.0	105.0	V	100	16
58.000	20.72	30.0	9.3	1000	120.0	164.0	V	232	15
59.469	20.37	30.0	9.6	1000	120.0	107.0	V	277	15
103.863	17.01	33.5	16.5	1000	120.0	191.0	V	232	14
869.253	30.17	36.0	5.8	1000	120.0	145.0	V	238	25
911.394	25.76	36.0	10.2	1000	120.0	195.0	V	142	26

Plot 75: 1GHz – 18 GHz, normal operation mode, EUT 2

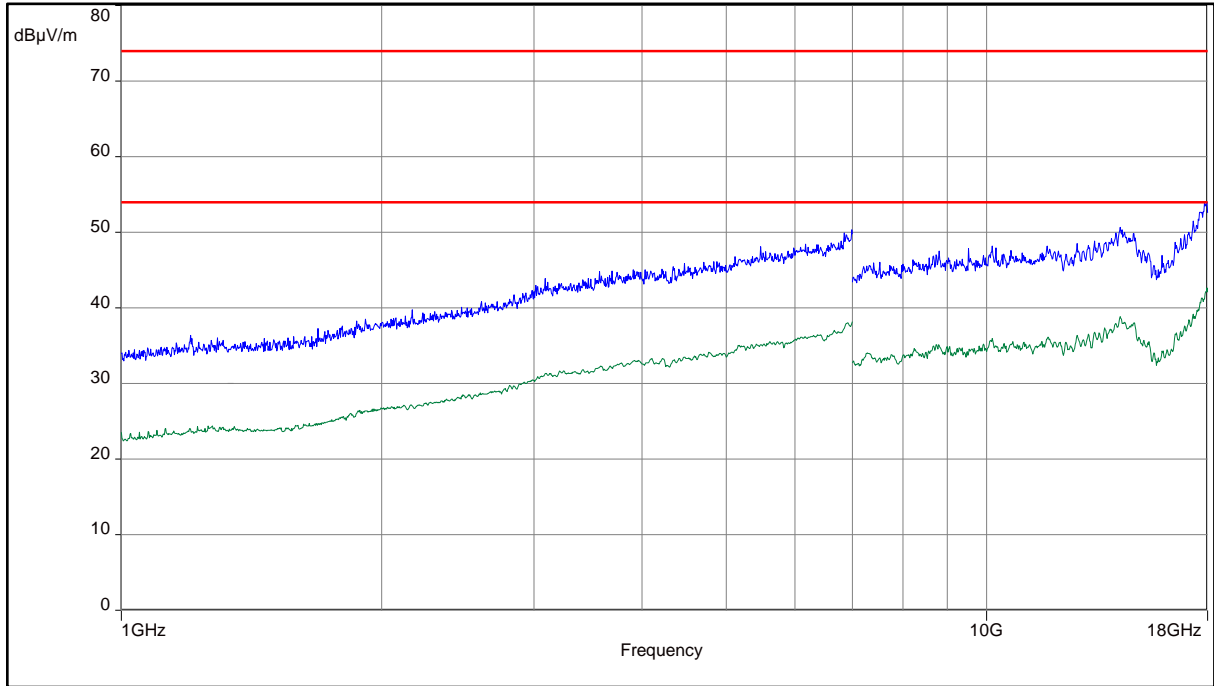

Plot 76: 18 GHz – 26.5 GHz, normal operation mode, EUT 1

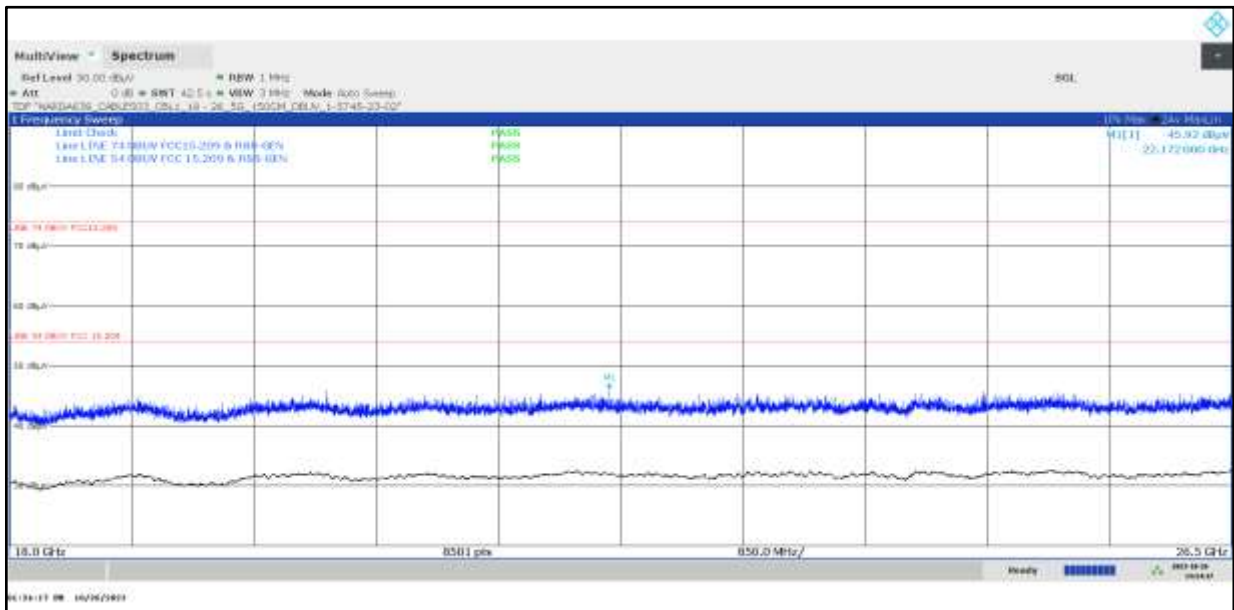

Plot 77: 26.5 GHz – 40 GHz, normal operation mode, EUT 1

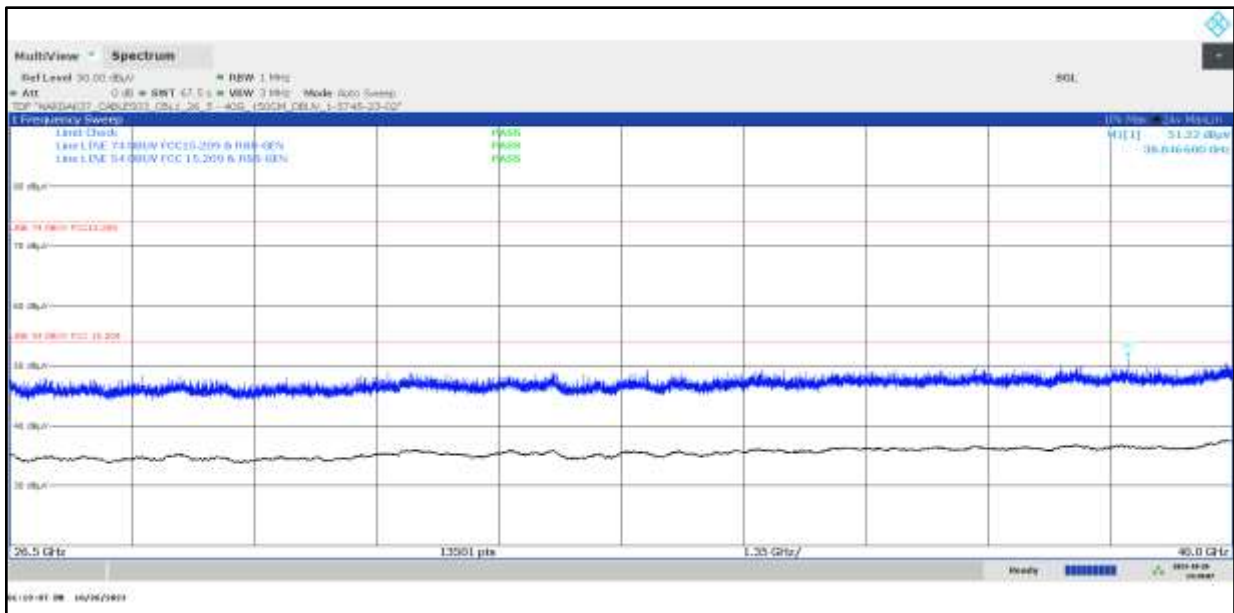

Plot 78: 40 GHz – 50 GHz, normal operation mode, EUT 1

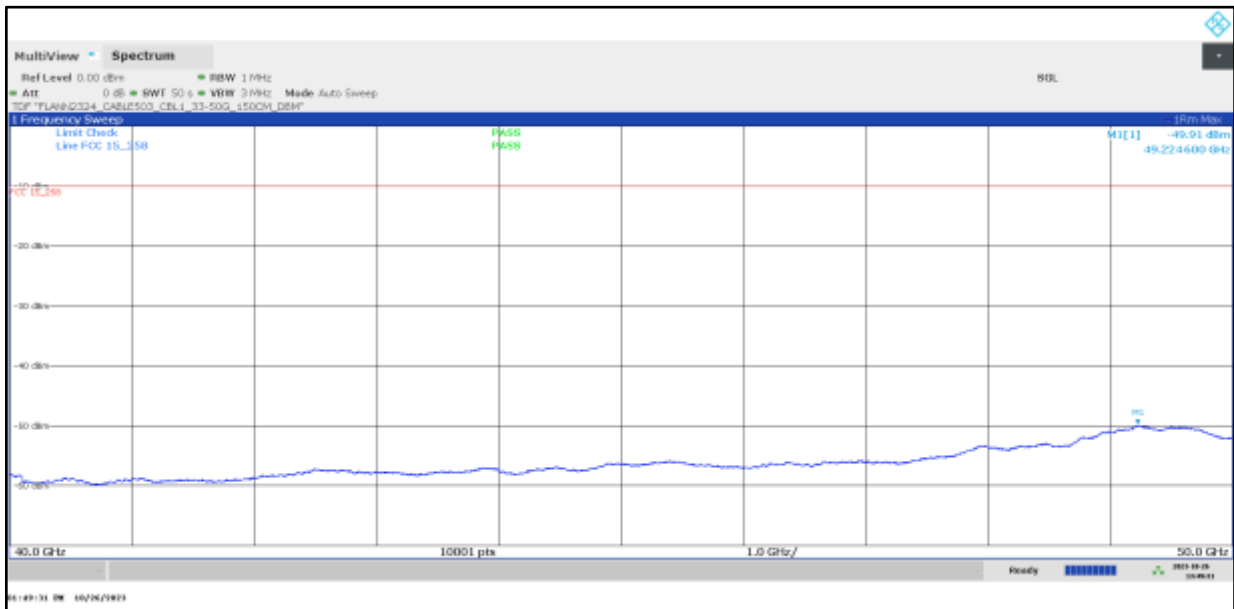

Plot 79: 50 GHz – 75 GHz, normal operation mode, EUT 1

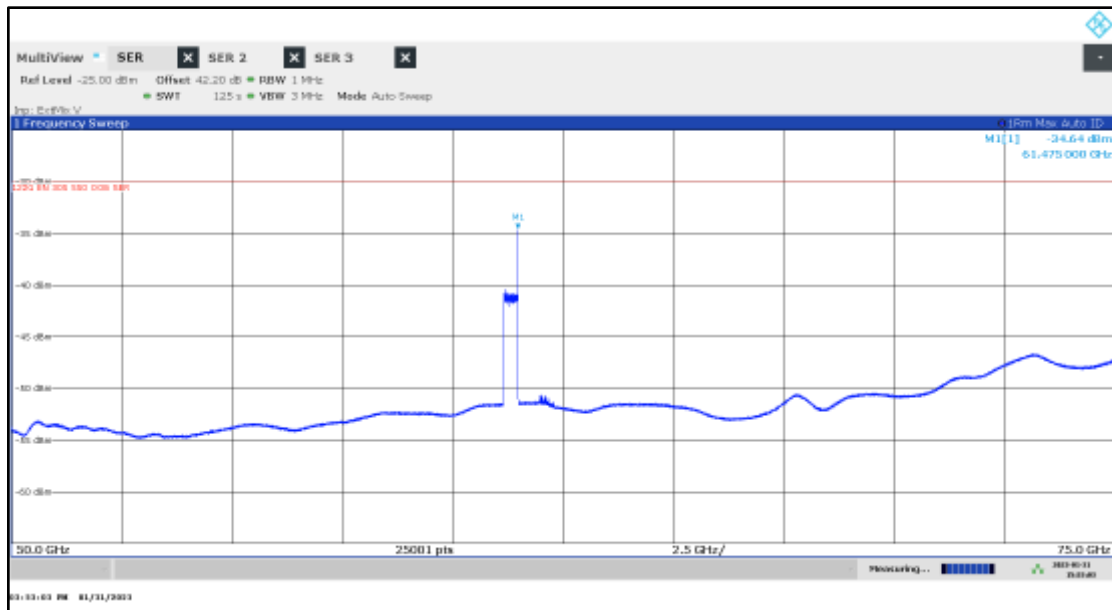

Note:

- Limit according to §15.258 and RSS 210 J.3: -10 dBm (see chapter 12.3)

Plot 80: 75 GHz – 90 GHz, normal operation mode, EUT 1

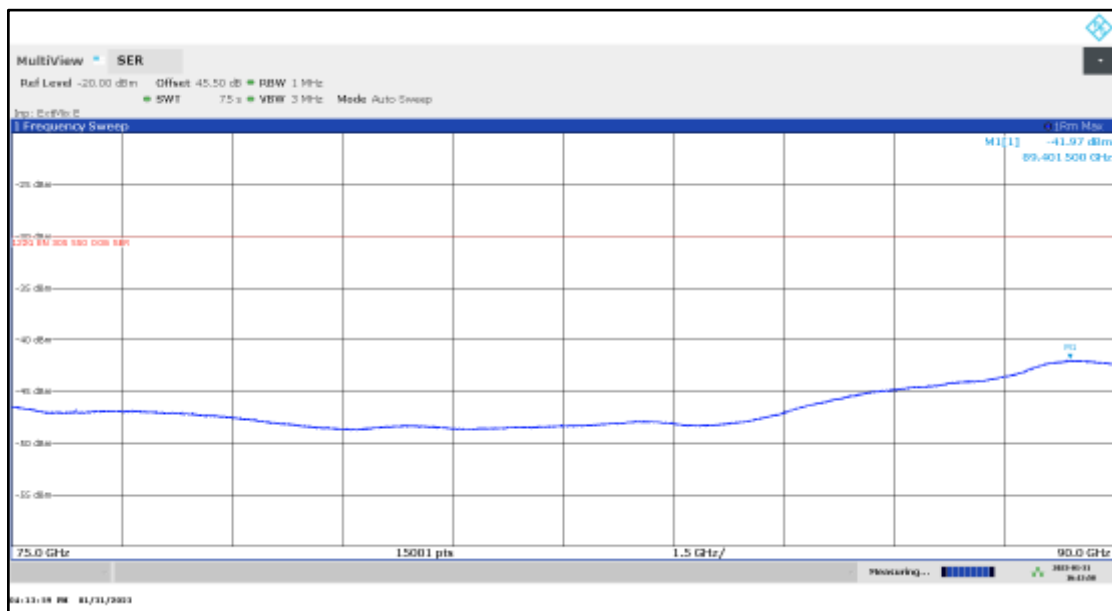

Note:

- Limit according to §15.258 and RSS 210 J.3: -10 dBm (see chapter 12.3)

Plot 81: 90 GHz – 100 GHz, normal operation mode, EUT 1



Note:

- Limit according to §15.258 and RSS 210 J.3: -10 dBm (see chapter 12.3)

Plot 82: 100 GHz – 105 GHz, normal operation mode, EUT 1

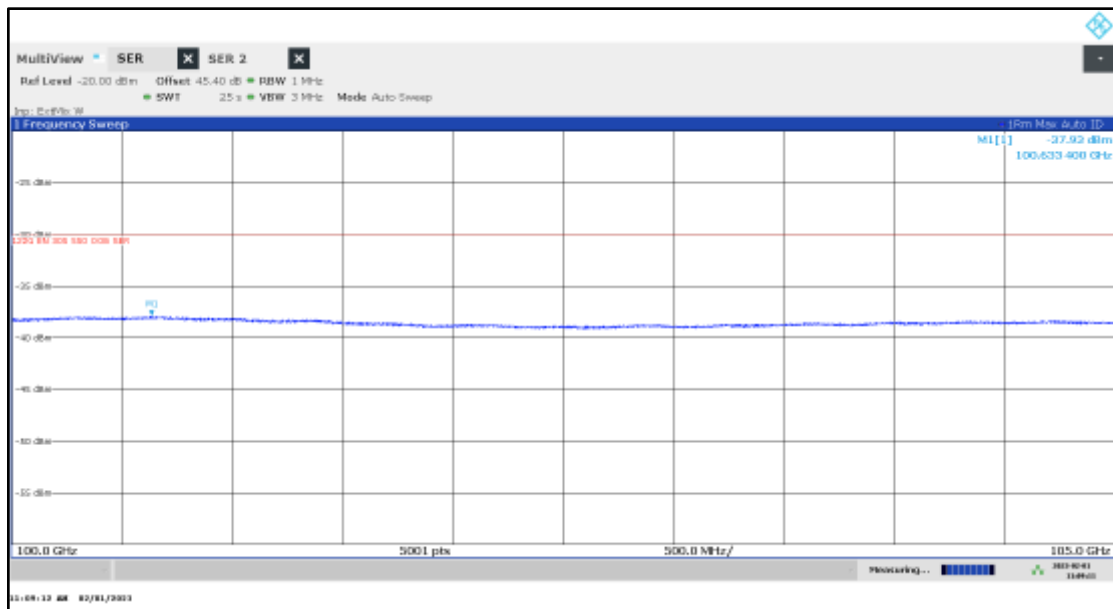

Note:

- Limit according to §15.258 and RSS 210 J.3: -10 dBm (see chapter 12.3)

Plot 83: 105 GHz – 120 GHz, normal operation mode, EUT 1

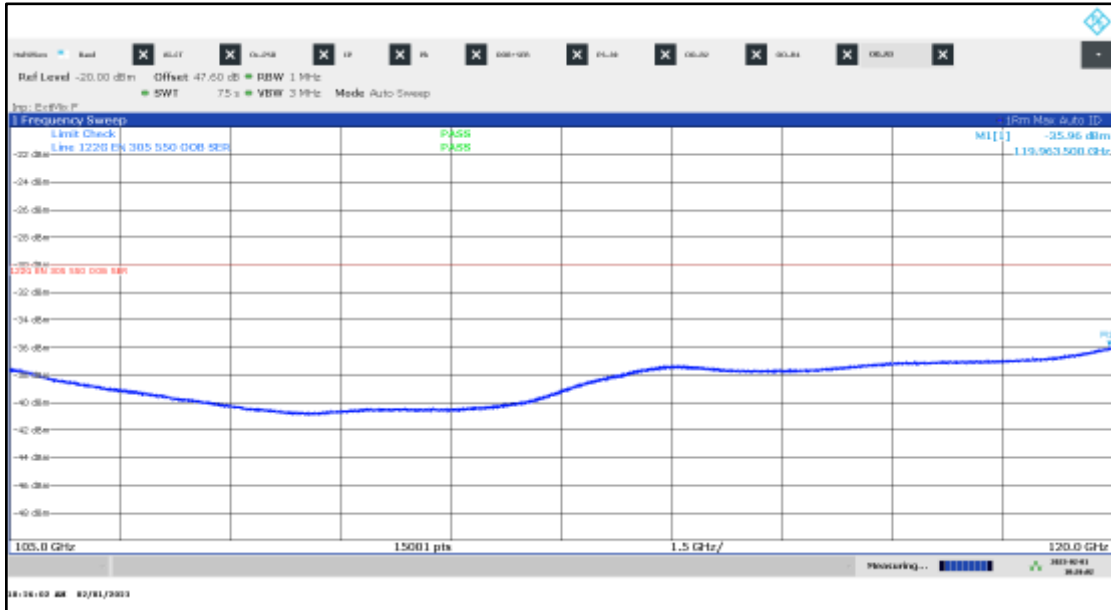

Note:

- Limit according to §15.258 and RSS 210 J.3: -10 dBm (see chapter 12.3)

Plot 84: 115 GHz – 145 GHz, normal operation mode, EUT 1

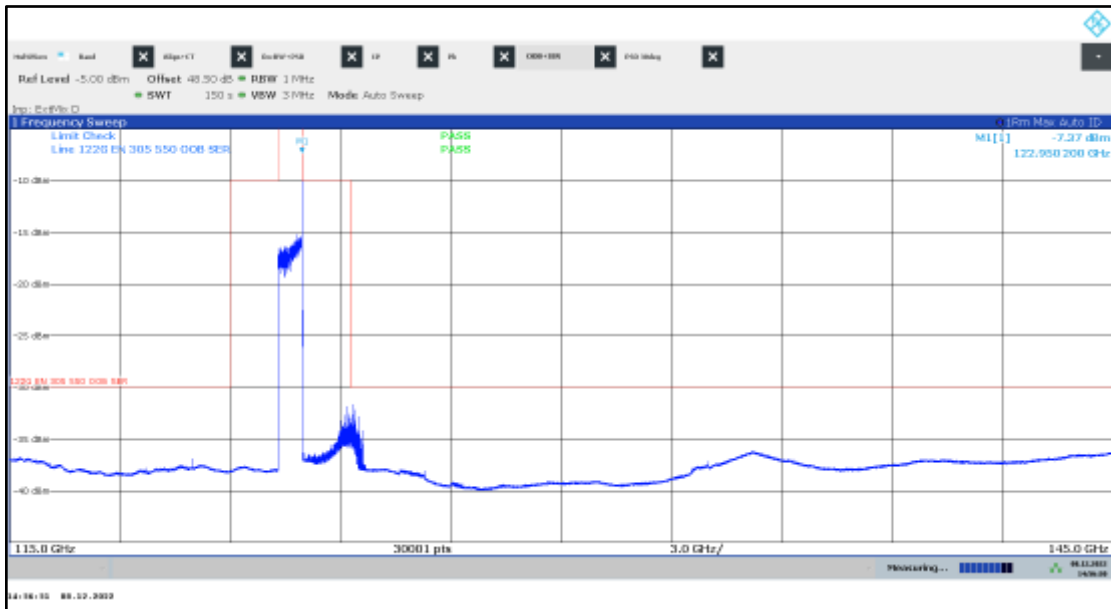

Note:

- Limit in spurious emission region according to §15.258 and RSS 210 J.3: -10 dBm (see chapter 12.3)

Plot 85: 140 GHz – 220 GHz, normal operation mode, EUT 1

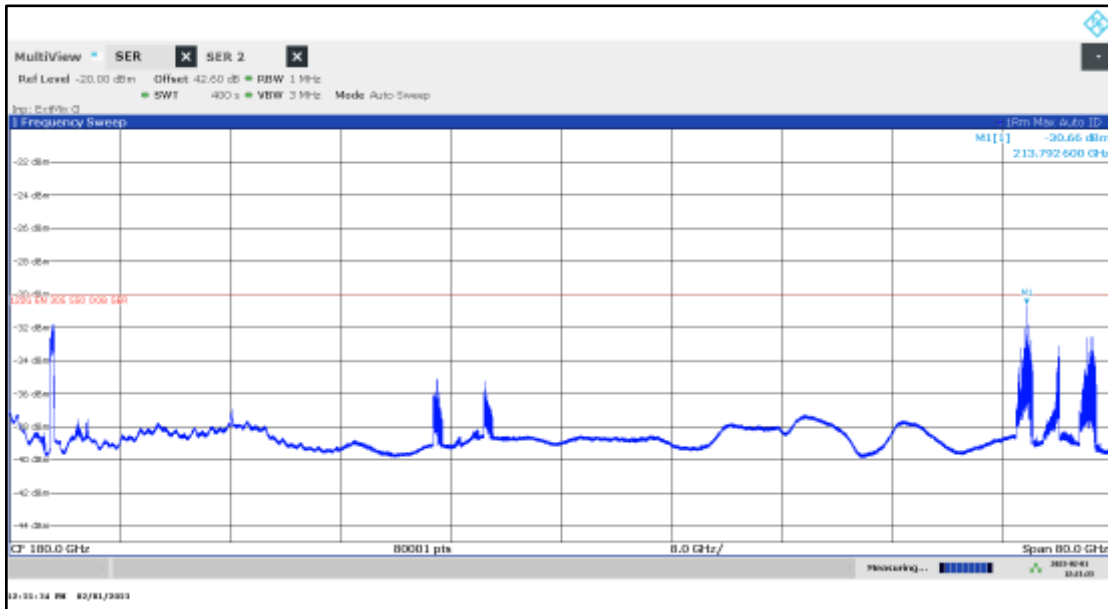

Note:

- Limit according to §15.258 and RSS 210 J.3: -10 dBm (see chapter 12.3)

Plot 86: 140 GHz – 220 GHz, normal operation mode with Signal-ID-Function, EUT 1

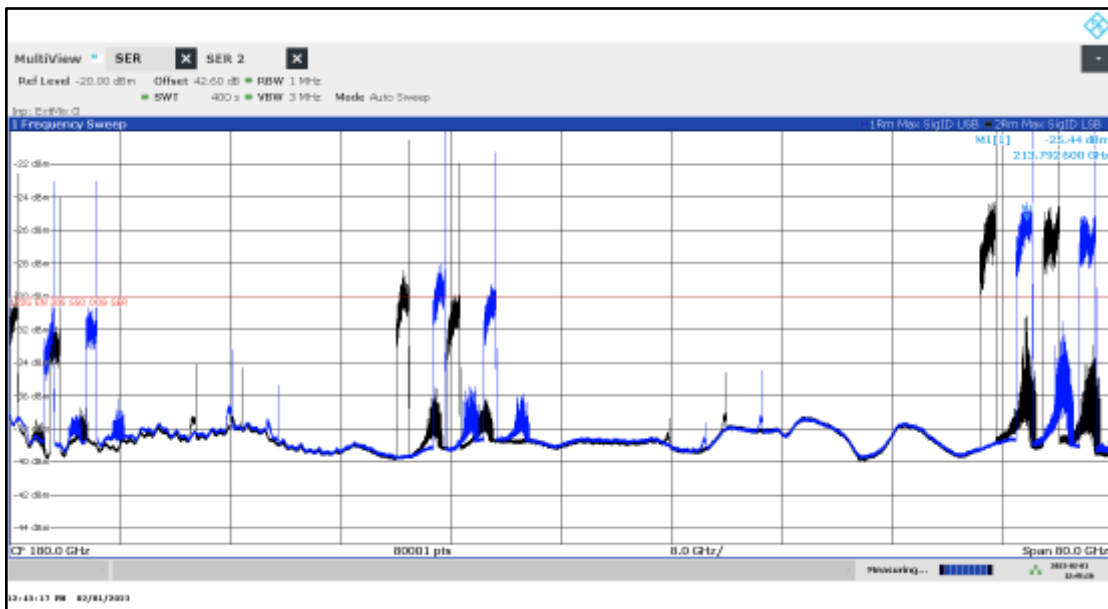

Note:

- Analyzer function 'Signal-ID' is used to reveal the occurrence of mixing products of the external harmonic mixers. Mixer products caused by undesired harmonics are displayed at different frequency positions in both traces. Hence, the shown signals are most likely caused by mixer products.
Blue line: RMS detector, SigID USB
Black Line: RMS detector, SigID LSB
- Limit according to §15.258 and RSS 210 J.3: -10 dBm (see chapter 12.3)

Plot 87: 220 GHz – 300 GHz, normal operation mode, EUT 1

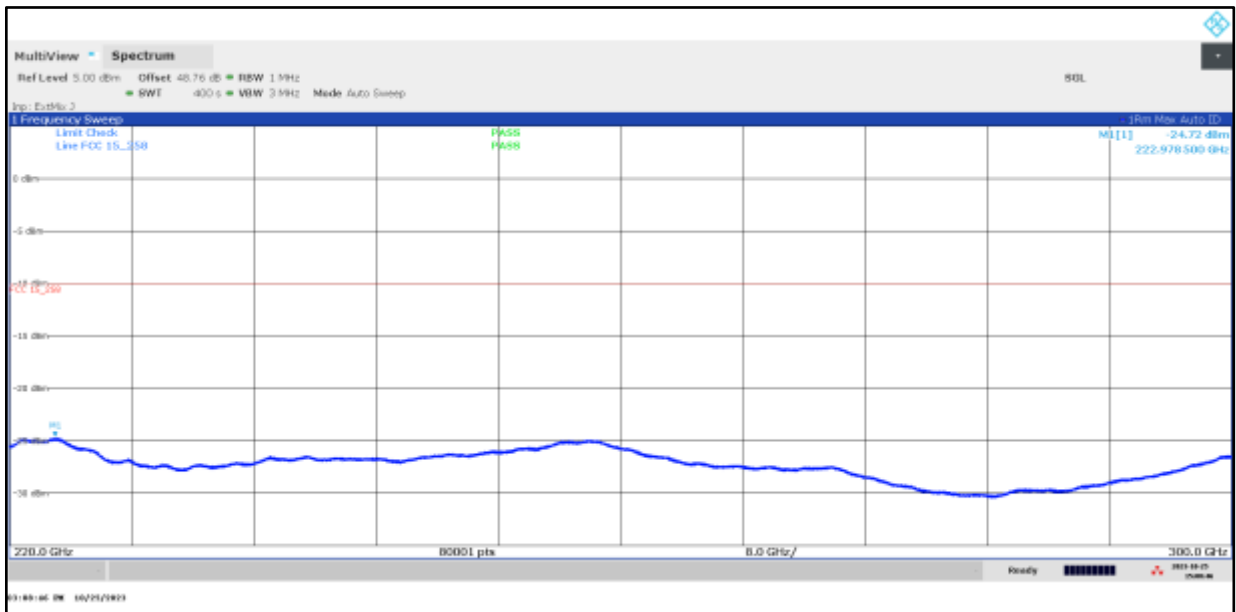

Plot 88: 300 GHz – 325 GHz, normal operation mode, EUT 1

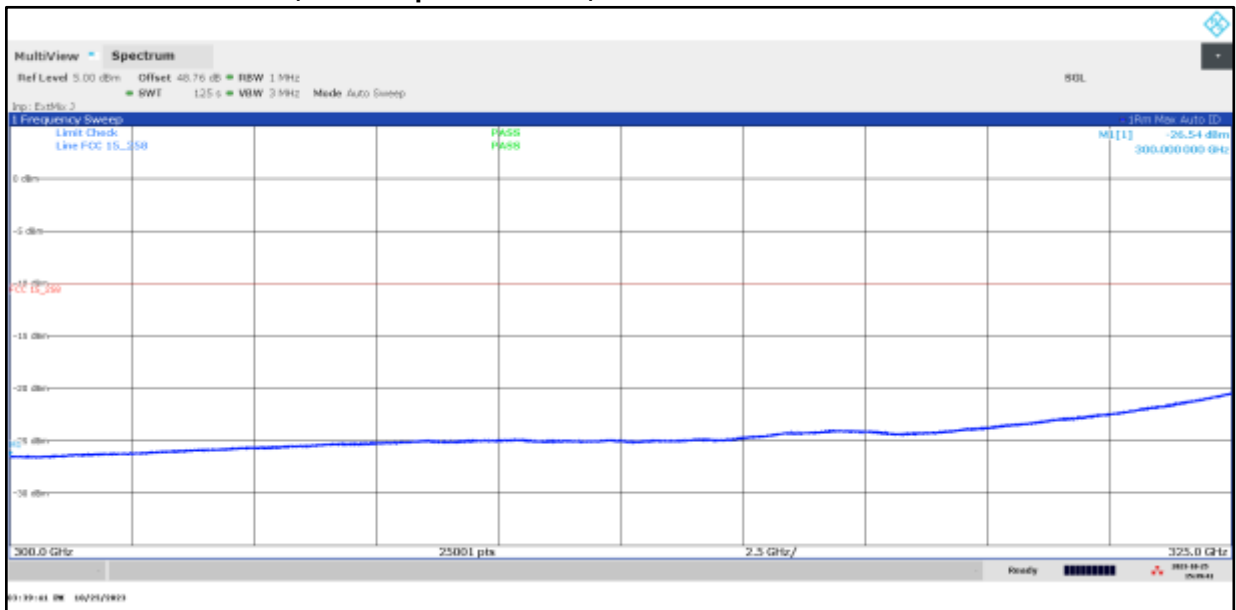

Plot 89: 325 GHz – 380 GHz, normal operation mode, EUT 1

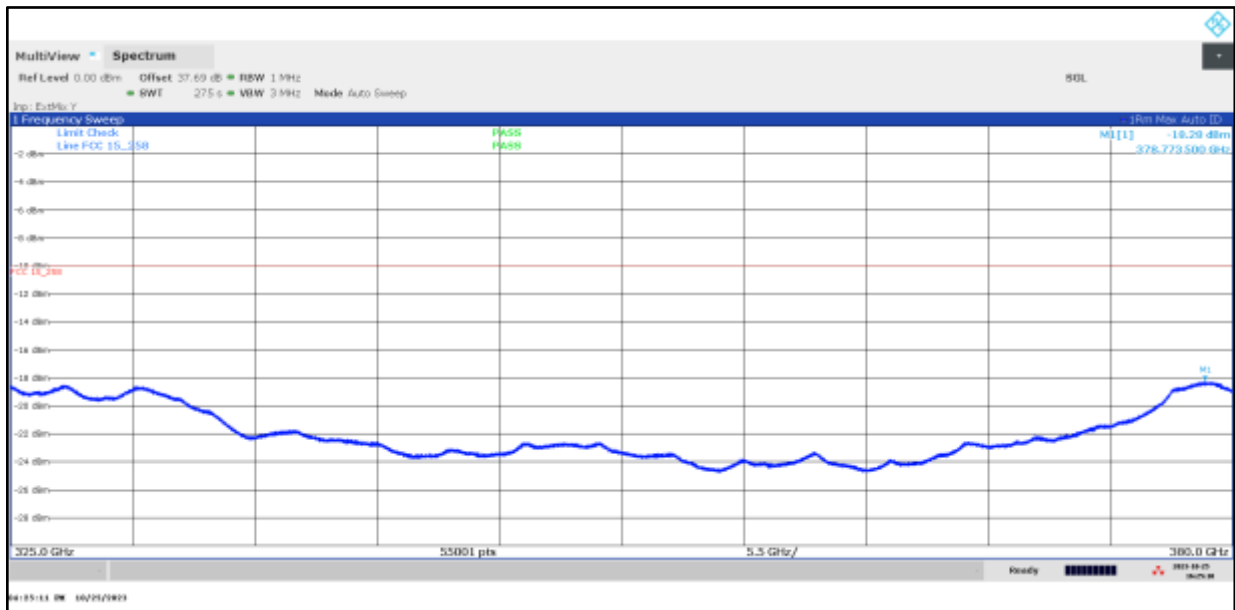

12.4 Frequency Stability

Description:

§15.215(c)

Intentional radiators operating under the alternative provisions to the general emission limits, as contained in §§ 15.217 through 15.257 and in subpart E of this part, must be designed to ensure that the 20 dB bandwidth of the emission, or whatever bandwidth may otherwise be specified in the specific rule section under which the equipment operates, is contained within the frequency band designated in the rule section under which the equipment is operated. In the case of intentional radiators operating under the provisions of subpart E, the emission bandwidth may span across multiple contiguous frequency bands identified in that subpart. The requirement to contain the designated bandwidth of the emission within the specified frequency band includes the effects from frequency sweeping, frequency hopping and other modulation techniques that may be employed as well as the frequency stability of the transmitter over expected variations in temperature and supply voltage. If a frequency stability is not specified in the regulations, it is recommended that the fundamental emission be kept within at least the central 80% of the permitted band in order to minimize the possibility of out-of-band operation.

§15.258 (d)

Fundamental emissions must be contained within the frequency bands specified in this section during all conditions of operation. Equipment is presumed to operate over the temperature range -20 to + 50 degrees Celsius with an input voltage variation of 85% to 115% of rated input voltage, unless justification is presented to demonstrate otherwise.

Limits:

FCC
CFR Part 15.258
The occupied bandwidth from intentional radiators operated within the specified frequency band shall comply with the following:
Frequency range
116 GHz – 123 GHz

Measurement:

Measurement parameter	
Detector:	Pos-Peak
Resolution bandwidth:	100 kHz
Video bandwidth:	300 kHz
Trace-Mode:	Max Hold

Measurement results:

Test condition	Frequency f_L [GHz]	Frequency f_H [GHz]	Bandwidth [MHz]
-20 °C / V_{nom}	122.2991	122.9692	670.10
-10 °C / V_{nom}	122.2995	122.9773	677.80
0 °C / V_{nom}	122.2993	122.9727	673.40
10 °C / V_{nom}	122.2995	122.9668	667.30
20 °C / V_{nom}	122.2992	122.9695	670.30
20 °C / V_{min}	122.2990	122.9687	669.70
20 °C / V_{max}	122.2991	122.9692	670.10
30 °C / V_{nom}	122.2989	122.9669	668.00
40 °C / V_{nom}	122.2993	122.9688	669.50
50 °C / V_{nom}	122.2992	122.9708	671.60

Note: For detailed measurement results, please see 1-6098_23-02-04_Annex_MR1

12.5 Conducted emissions < 30 MHz (AC power line)

Description:

Measurement of the conducted spurious emissions in transmit mode below 30 MHz. Both power lines, phase and neutral line, are measured. Found peaks are re-measured with average and quasi peak detection to show compliance to the limits.

Limits and provisions:

§15.207(a):

Except as shown in paragraphs (b) and (c) of this section, for an intentional radiator that is designed to be connected to the public utility (AC) power line, the radio frequency voltage that is conducted back onto the AC power line on any frequency or frequencies, within the band 150 kHz to 30 MHz, shall not exceed the limits in the following table, as measured using a 50 μ H/50 ohms line impedance stabilization network (LISN). Compliance with the provisions of this paragraph shall be based on the measurement of the radio frequency voltage between each power line and ground at the power terminal. The lower limit applies at the boundary between the frequency ranges.

Frequency of emission (MHz)	Conducted limit (dB μ V)	
	Quasi-peak	Average
0.15 – 0.5	66 to 56*	56 to 46*
0.5 – 5	56	46
5 – 30	60	50

* Decreases with the logarithm of the frequency

§15.207(c):

Measurements to demonstrate compliance with the conducted limits are not required for devices which only employ battery power for operation and which do not operate from the AC power lines or contain provisions for operation while connected to the AC power lines. Devices that include, or make provisions for, the use of battery chargers which permit operating while charging, AC adapters or battery eliminators or that connect to the AC power lines indirectly, obtaining their power through another device which is connected to the AC power lines, shall be tested to demonstrate compliance with the conducted limits.

Measurement:

Parameter	
Detector:	Peak - Quasi Peak / Average
Sweep time:	Auto
Video bandwidth:	F < 150 kHz: 200 Hz F > 150 kHz: 9 kHz
Resolution bandwidth:	F < 150 kHz: 1 kHz F > 150 kHz: 100 kHz
Span:	9 kHz to 30 MHz
Trace-Mode:	Max Hold

Measurement results:

Plot 90: Phase line

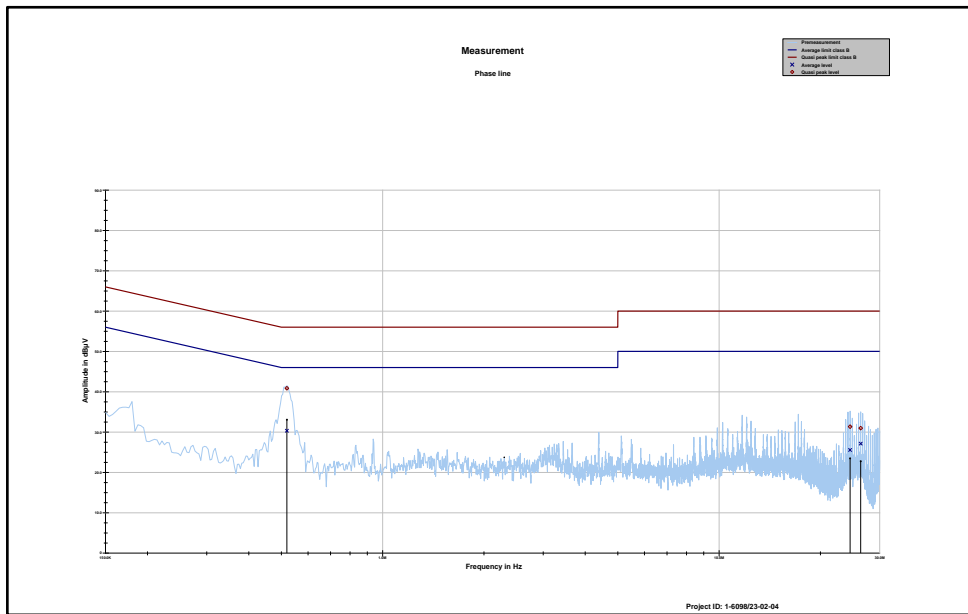

Frequency	Quasi peak level	Margin quasi peak	Limit QP	Average level	Margin average	Limit AV
MHz	dBµV	dB	dBµV	dBµV	dB	dBµV
0.519394	40.85	15.15	56.000	30.31	15.69	46.000
24.511331	31.33	28.67	60.000	25.57	24.43	50.000
26.347106	30.97	29.03	60.000	27.12	22.88	50.000

Plot 91: Neutral line

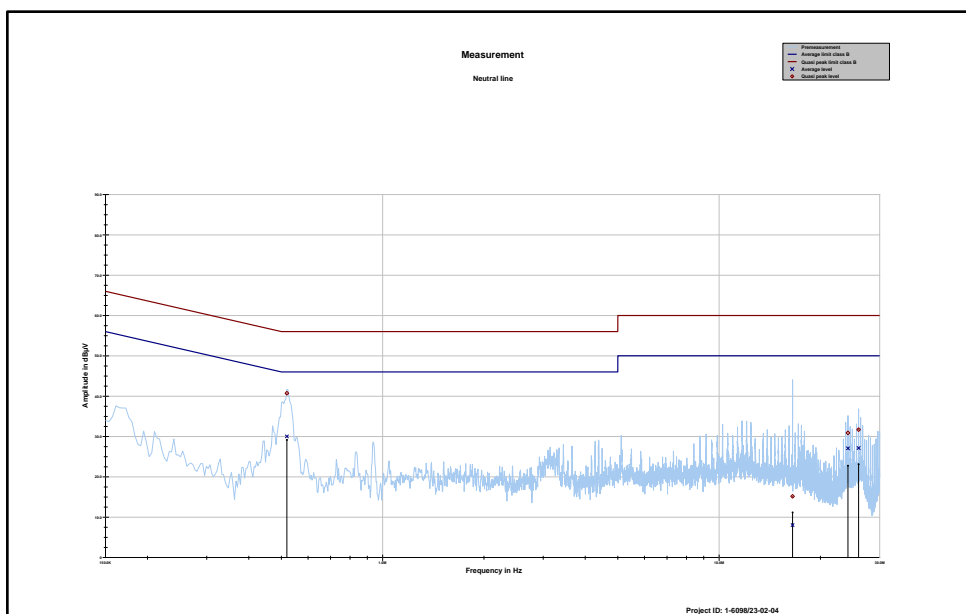

Frequency	Quasi peak level	Margin quasi peak	Limit QP	Average level	Margin Average	Limit AV
MHz	dBµV	dB	dBµV	dBµV	dB	dBµV
0.519394	40.71	15.29	56.000	30.01	15.99	46.000
16.530188	15.15	44.85	60.000	8.03	41.97	50.000
24.149400	30.87	29.13	60.000	27.05	22.95	50.000
25.973981	31.69	28.31	60.000	27.14	22.86	50.000

Verdict: Compliant

13 Glossary

EUT	Equipment under test
DUT	Device under test
UUT	Unit under test
GUE	GNSS User Equipment
ETSI	European Telecommunications Standards Institute
EN	European Standard
FCC	Federal Communications Commission
FCC ID	Company Identifier at FCC
IC	Industry Canada
PMN	Product marketing name
HMN	Host marketing name
HVIN	Hardware version identification number
FVIN	Firmware version identification number
EMC	Electromagnetic Compatibility
HW	Hardware
SW	Software
Inv. No.	Inventory number
S/N or SN	Serial number
C	Compliant
NC	Not compliant
NA	Not applicable
NP	Not performed
PP	Positive peak
QP	Quasi peak
AVG	Average
OC	Operating channel
OCW	Operating channel bandwidth
OBW	Occupied bandwidth
OOB	Out of band
DFS	Dynamic frequency selection
CAC	Channel availability check
OP	Occupancy period
NOP	Non occupancy period
DC	Duty cycle
PER	Packet error rate
CW	Clean wave
MC	Modulated carrier
WLAN	Wireless local area network
RLAN	Radio local area network
DSSS	Dynamic sequence spread spectrum
OFDM	Orthogonal frequency division multiplexing
FHSS	Frequency hopping spread spectrum
GNSS	Global Navigation Satellite System
C/N₀	Carrier to noise-density ratio, expressed in dB-Hz

14 Document history

Version	Applied changes	Date of release
-/-	Initial release	2023-11-09
-A	Measurement results chapter 12.4 moved to Annex_MR1	2023-11-10

END OF TEST REPORT