





Bluetooth Control

- Touching  on the left of the connected device ( ) disconnects this device.





-  : Device used normally.
-  : Device used for JVC Streaming DJ.

3 Touch (White/dark blue background) on the left of the name of the device to be played.

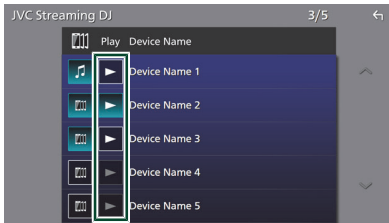
The background changes from dark to light blue and starts playback.



-  (Gray) : Not connected.
-  (White/dark blue background) : Connected.
-  (White/light blue background) : During playback.

4 Touch .

NOTE

- If a connected Bluetooth audio device is operated to play music, connections are switched.
- When a Bluetooth source is switched to another one, its settings are deleted and the connection is restored to the connection before source switching.
- You cannot select an Android smartphone connected as an Android Auto device.

File search

1 Touch .

2 Touch the desired file or folder.

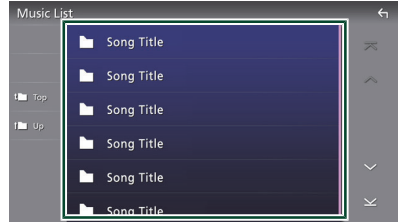

When you touch a folder its contents are displayed.

3 Touch the desired item in the content list. Playback starts.

NOTE

- For operations in the list screen, see **List screen (P.22)**.

Using the Hands-Free Unit

You can use the telephone function by connecting the Bluetooth telephone to this unit.

NOTE

- If you use the Hands-Free function frequently, move the TEL short-cut key (icon) to the Home screen. (P.19)
- While using the Bluetooth Hands-Free function, Apple CarPlay or Android Auto is not available.
- While Apple CarPlay or Android Auto is connected, the Bluetooth Hands-Free function and two Bluetooth devices connections cannot be used. Only the Apple CarPlay or Android Auto Hands-Free function can be used.

Make a call

1 KW-Z1001W/KW-Z1000AW

Press the   button.

KW-Z800AW

Touch  at the top of the screen.

Touch  HOME on the popup menu.

HOME screen appears.

2 Touch .

3 Touch [Phone].

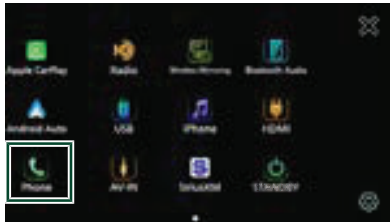





Hands-Free screen appears.

NOTE

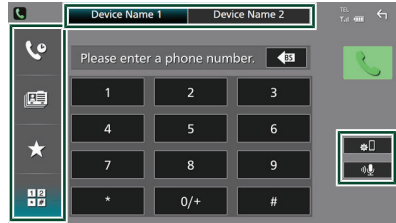
- If your smartphone/cell-phone supports PBAP, you can display the phonebook and call lists onto the touch panel screen when the smartphone/cell-phone is connected.
 - Phonebook: up to 1000 entries
 - Up to 50 entries including dialed calls, received calls, and missed calls

4 Select a dialing method.



-  : Call using call records
-  : Call using the phonebook
-  : Call using the preset number
-  : Call by entering a phone number

Select the smartphone/cell-phone to use

When you connect two smartphones/cell-phones

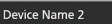
- 1 Touch   to select the phone you want to use.

Bluetooth Setup

- 1 Touch .

Connection & AV setting menu appears. (P.74)

Voice Recognition

- 1 Touch . (P.79)

NOTE

- Status icons such as battery and antenna icons may differ from those displayed on the smartphone/cell-phone.
- Setting the smartphone/cell-phone in the private mode can disable the Hands-Free function.

Call using call records

- 1 Touch .

Bluetooth Control

2 Select the phone number from the list.

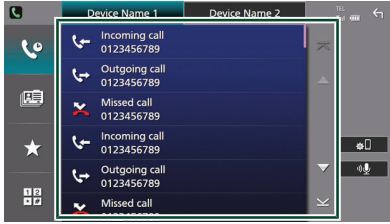

5 Select the phone number from the list.

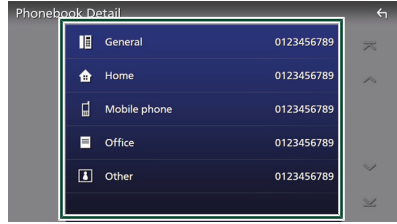

Call using the phonebook

1 Touch .

2 Touch .

3 Select the initial.



- Characters with no corresponding name will not appear.
- A first character with an accent character such as “ü” can be searched for with a non-accent character “u”. A character with an accent character in a sentence cannot be searched for.

4 Select the person you want to call from the list.



NOTE

- You can sort the phone numbers in the list by last name or first name. For details, see **Hands-Free Setup (P.82)**.
- When Russian is selected in “Language Select” (P.95), you can switch between English keyboard and Russian keyboard.
- When Hebrew is selected in “Language Select” (P.95), you can switch between English keyboard and Hebrew keyboard.
- You can search with 3 initial letters on the English keyboard and 1 initial letter on the Russian / Hebrew keyboard.

Call using the preset number

1 Touch .

2 Touch the name or phone number.

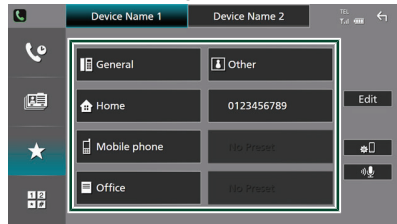

Call by entering a phone number

1 Touch .

2 Enter a phone number with number keys.



3 Touch .

Voice Recognition

You can access the voice recognition function of the smartphone/cell-phone connected to this unit. You can search the smartphone/cell-phone phonebook by voice. (The functionality depends on the smartphone/cell-phone.)

KW-Z1001W/KW-Z1000AW

1 Press the button.

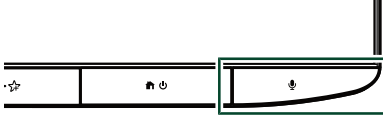

Voice Recognition screen appears.

2 Start speaking.

KW-Z800AW

1 Touch at the top of the screen.



2 Touch [VOICE] on the popup menu.



3 Start speaking.

NOTE

- You can use the voice recognition function by touching  on the Hands-Free screen.
- You can use the voice recognition function for the connected smartphone/cell-phone if you selected [TEL (HFP) 1] or [TEL (HFP) 2] for HFP when registered.

Receive a call

1 Touch to answer a phone call or to reject an incoming call.

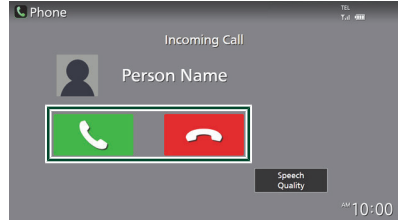

NOTE

- When shifting the gear to the reverse (R) position and monitoring the picture from the rear view camera, this screen does not appear even if a call comes in.
- The portrait registered in the phonebook is displayed while making/receiving calls and during a call.
- If you edit the phonebook on the connected device side after downloading the phonebook, the portrait may not be displayed depending on the edited content. It is recommended that you download the phonebook whenever you edit it.
- The image quality of a displayed portrait may depend on a connected device.

To end call

1 While talking, touch .

Operations during a call

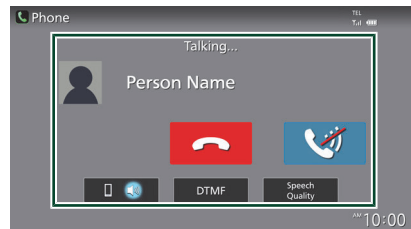

● Adjust call sound quality.

1 Touch [Speech Quality].

Bluetooth Control

2 Touch ◀ or ▶ to adjust each parameter.

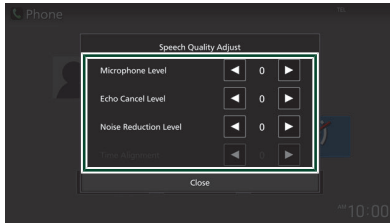

■ [Microphone Level]

Adjust the level of microphone gain. Default is "0".

■ [Echo Cancel Level]

Adjust the level of echo cancellation. Default is "0".

■ [Noise Reduction Level]

Reduce the noise generated in the surrounding environment without changing the microphone volume. Use this function when the voice of caller is not clear. Default is "0".

● Adjust the receiver volume

KW-Z1001W/KW-Z1000AW

1 Press the [-] or [+] button.

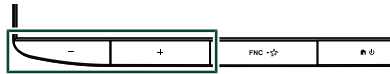

KW-Z800AW

1 Touch at the top of the screen.



2 Touch [-] or [+] on the popup menu.





● Mute your voice

Touch  to mute or not to mute your voice.

● Output the dial tone

Touch [DTMF] to display the tone input screen. You can send tones by touching desired keys on the screen.

● Switching between speaking voice output destinations

Touching  /  each time switches speaking voice output destinations between the smartphone/cell-phone and the speaker.

● Call-waiting

When you receive a new call while talking on the phone, you can answer the newly received call by touching . The current call is put on hold.

Each time you touch , the caller will change to the other one.

When you touch , the current call will end to be switched to the call waiting on hold.

☑ Phone number preset

You can register frequently used phone numbers in this unit.

1 Touch .

2 Touch [Edit].



3 Select where to preset.

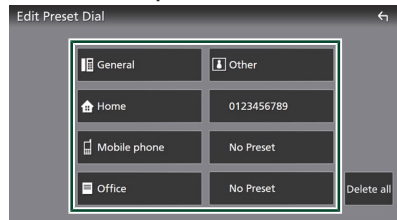

■ [Delete all]

To delete all preset numbers, touch [Delete all] and then touch [Yes] on the confirmation screen.

4 Select how to preset.

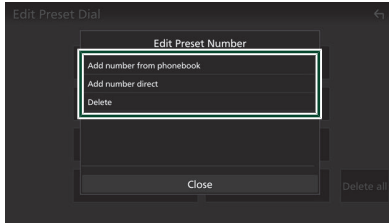

■ [Add number from phonebook]

Select the number to preset from the phonebook.

■ [Add number direct]

Enter the telephone number directly and touch [SET].

■ [Delete]

To delete a preset number, touch [Delete] and then touch [OK] on the confirmation screen.

Phonebook transfer

You can transfer phonebook data from your Bluetooth smartphone using PBAP.

1 Touch .

2 Touch .



Phonebook data transfer starts.

NOTE

- If the Phonebook contains more than 1000 entries, only 1000 entries are transferred. The 1001st and later entries are not transferred.
- If no Phonebook has been downloaded, touching [Download Phonebook Now] will start downloading the Phonebook.
- The portrait registered in the phonebook is displayed while making/receiving calls and during a call.
If you edit the phonebook on the connected device side after downloading the phonebook, the portrait may not be displayed depending on the edited content. It is recommended that you download the phonebook whenever you edit it.

Phonebook deletion

1 Touch .

2 Touch the name to check.



■ [All]

Checks all boxes.

■ [All]

Clears all check marks.

3 Touch [Delete].

Confirmation message appears.

4 Touch [Yes].

Hands-Free Setup

You can make various settings for the Hands-Free function.

1 KW-Z1001W/KW-Z1000AW

Press the  button.

KW-Z800AW

Touch  at the top of the screen.

Touch  HOME on the popup menu.
HOME screen appears.

2 Touch .

3 Touch [SETUP].

SETUP Menu screen appears.

4 Touch [Connection & AV].

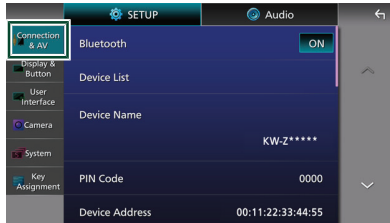

Connection & AV setting menu appears.

5 Touch [TEL SETUP].

TEL SETUP screen appears.

6 Set each function as follows.



■ [Bluetooth HF/Audio]

Select the speakers to output the sound from the smartphone/cell-phone (such as phone call voice and ringing tone) and Bluetooth audio player.

- [Front]: Outputs sound from the front speakers.
- [All] (Default): Outputs sound from all speakers.

■ [Auto Response]*

Set the automatic response time to pick-up an incoming call.

- [OFF] (Default): Turns off the Automatic response function.
- [1]/[5]/[10]/[15]/[20]/[25]/[30]: Sets the ringing time (second).

* Either the auto response time set on this unit or the time set on the smartphone/cell-phone, whichever is shorter takes effect.

■ [Auto Pairing]

When set to "ON", the Apple Auto Pairing function is turned on to automatically register the iPhone connected to this unit.

- [ON] (Default): Turns on the Apple Auto Pairing function.
- [OFF]: Turns off the Apple Auto Pairing function.

■ [Sort Order]

Set how to sort the data in the smartphone/cell-phone phonebook.

- [First] (Default): Sorts data by the first name.
- [Last]: Sorts data by the last name.

7 Touch [OK].

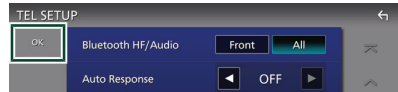

Other External Components

View Camera

NOTE

- To connect a camera, see **Connecting the camera (P.130)**.
- To use a rear view camera, a REVERSE lead connection is required. **(P.127)**
- If [Rear Camera Interruption] is active the camera screen is displayed when you shift the gear to the reverse (R) position.
- The camera whose view was displayed last is kept and the same camera view will be displayed the next time. If its assignment setting is changed, the rear camera view is displayed.
- Rear/front camera interruption screen is not kept as the camera screen which will be displayed the next time.

Display the camera screen

You can display the camera screen manually if "Camera" is registered to a popup menu function key. **(P.97)**

1 KW-Z1001W/KW-Z1000AW

Press the **FNC** button.

Touch  at the top of the screen.
Popup menu appears.

2 Touch [Camera].

KW-Z1001W/KW-Z1000AW

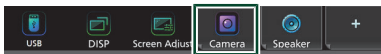

KW-Z800AW

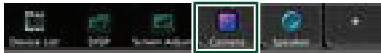

View camera screen appears.

3 Adjust each item as follows.

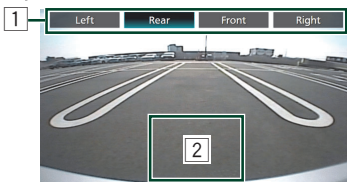

1 Camera Switching Keys *1

Touch to switch the view camera. It is necessary to set "Camera Assignment Settings" beforehand except "Rear". See **To set up the camera assignment settings (P.84)**.

2 Camera off

Touch to exit the camera screen.

*1 When two or more cameras of rear, front, left, and right are connected with this unit.

Camera Setup

1 KW-Z1001W/KW-Z1000AW

Press the   button.

KW-Z800AW

Touch  at the top of the screen.

Touch  HOME on the popup menu.
HOME screen appears.

2 Touch .

3 Touch [SETUP].

SETUP Menu screen appears.

4 Touch [Camera].

Camera setting menu appears.

5 Set each item as follows.



■ [Camera Assignment Settings]

Set up the camera assignment. See **To set up the camera assignment settings (P.84)**.

■ [Rear Camera Interruption]

- [ON] (Default): Displays the picture from the rear view camera when you shift the gear to the reverse (R) position.
- [OFF]: Select this when no camera is connected.

Other External Components

■ [Rear Camera Message] *1

- [Always display] (Default): Always displays the caution message on the rear camera interruption screen.
- [Clear after 5 seconds]: Displays the caution message for about 5 seconds on the rear camera interruption screen.

■ [Parking Guidelines]

You can display parking guidelines to enable easier parking when you shift the gear to the reverse (R) position. Default is "ON".

■ [Guidelines SETUP]

If you select [ON] for [Parking Guidelines], you can adjust the parking guidelines. See **To adjust the parking guidelines (P.84)**.

■ [Front Camera Interruption] *2

- [10 sec]/[15 sec] (Default)/[20 sec]: The front camera screen is displayed when return the gear from the reverse (R) position.
- [OFF]: Cancel.

*1 To use the function, it is necessary to set [Rear Camera Interruption] to [ON].

*2 To use the function, it is necessary to set [Rear Camera Interruption] to [ON], and to assign front position to the view camera. **(P.84)**

■ To set up the camera assignment settings

1 Touch [Camera Assignment Settings] in the Camera setting menu. **(P.83)**

2 Select the item to set up.

■ [REAR VIEW CAMERA]

The rear camera is always connected to the rear view camera input terminals. This setting cannot be changed.

■ [FRONT VIEW CAMERA]

Set the camera assignment from view camera connected to Front view camera input terminal.

■ [3rd VIEW CAMERA]

Set the camera assignment from view camera connected to 3rd view camera input terminal.

■ [VIDEO IN]

Set the camera assignment from view camera connected to Video input terminal.

3 Select the view camera to set up.



4 Touch [Enter].

1 Picture from view camera

Displays the picture from the view camera connected to the input terminal to be set. **(P.130)**

2 Camera Position

Assign each position to the view camera connected to the selected input terminal. Front/Left/Right/[None]

3 Mirroring setting *1

Switch the mirroring setting. [ON]/[OFF] (Default)

*1 The [FRONT VIEW CAMERA] and [3rd VIEW CAMERA] setting screens only.

NOTE

- The screen shot above is for the [FRONT VIEW CAMERA] setting screen. It may be different from the ones for [3rd VIEW CAMERA] and [VIDEO IN].

■ To adjust the parking guidelines

NOTE

- Install the rear view camera in the appropriate position according to the instruction manual supplied with the rear view camera.
- When adjusting the parking guidelines, make sure to apply the parking brake to prevent the car from moving.

1 Touch [Parking Guidelines] in the Camera setting menu and set to [ON]. **(P.83)**

- 2 Touch [Guidelines SETUP] in the Camera setting menu.
- 3 Adjust the parking guidelines by selecting the  mark.

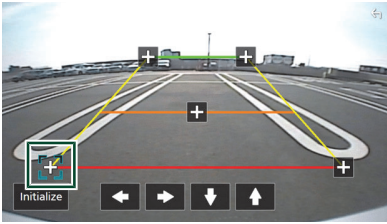

- 4 Adjusting the position of the selected mark.

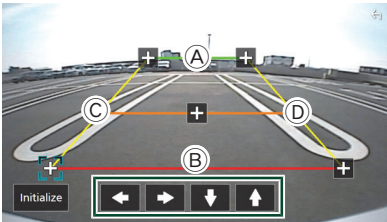

Make sure that lines (A) and (B) are horizontally parallel, and that lines (C) and (D) are of the same length.

NOTE

- Touch [Initialize] and then touch [Yes] to set all the  marks to their initial default position.

External audio/video players (AV-IN)

- 1 Connect an external component to the AV Audio input and the Video input terminal. (P.128)
- 2 Select [AV-IN] as the source. (P.19)
- 3 Turn on the connected component and start playing the source.

NOTE





- To select the AV-IN source, it is necessary to set "VIDEO IN" to "None" in Camera Assignment Settings. (P.84)

HDMI source







- 1 **Connect your smartphone to the HDMI input terminal. (P.128)**
Use HDMI cable KS-U70 (optional accessory).
- 2 **Select [HDMI] as the source. (P.19)**
- 3 **Start an application or playback on your smartphone.**

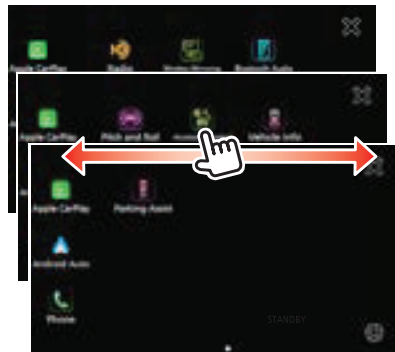

Maestro Features Operation

By connecting this unit to the bus system of the vehicle using an iDataLink Maestro (commercially available), this unit can access OEM audio sources, vehicle settings, and show vehicle information on this unit.

- 1 **KW-Z1001W/KW-Z1000AW**
Press the   button.
KW-Z800AW
Touch  at the top of the screen.
Touch  **HOME** on the popup menu.
HOME screen appears.
- 2 Touch  on the HOME screen.
- 3 Touch icon.



	• Displays the control screen of the Bluetooth Hands-Free function provided for the vehicle.
	• Displays the control screen of the accessories in the vehicle.
	• Displays vehicle information such as tire pressure, battery voltage, check engine codes. *
	• Display and control the OEM satellite radio.
	• Display and control the OEM media player.
	• Displays the control screen of the Bluetooth streaming source provided for the vehicle.
	• Display and controls the radar detector. *

 <p>Gauges</p>	<ul style="list-style-type: none"> • Displays information from the vehicle data lines, such as speedometer and fuel economy.
 <p>Climate</p>	<ul style="list-style-type: none"> • Displays information about the status of the climate control system in the vehicle. *
 <p>Parking Assist</p>	<ul style="list-style-type: none"> • Displays information from the vehicle's parking sensors.

* These iDatalink Maestro features are displayed as the widget on the Home screen. **(P.25)**
You can display the relevant screens by touching the widget.

NOTE

- Displayable screens, key names, and screen names vary depending on the type of the connected iDatalink Maestro and the model of the vehicle. For more details, access the following URL:
<https://www.idatalink.com/>

Vehicle Status

Pitch and Roll

Displays the vehicle's angle of pitch, angle of roll, elevation, latitude and longitude, and bearing (compass).

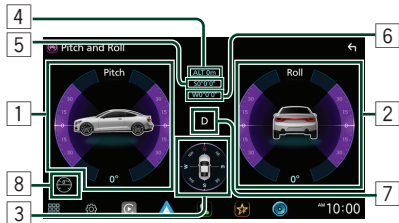

1 Pitch display

Displays the numerical value*1 and an image of the angle of pitch.

2 Roll display

Displays the numerical value*1 and an image of the angle of roll.

3 Compass display

Displays the direction the vehicle is facing.*2

4 Elevation display

Displays the vehicle's elevation.*2

5 Latitude display

Displays the vehicle's latitude.*2

6 Longitude display

Displays the vehicle's longitude.*2

7 Gear position display

Displays the current gear (P, R, N, D, 3, 2, 1)*1 *3

8 Pitch and Roll Reset button

Resets the pitch and roll angle to 0.*4

*1 Displays the value obtained from iDatalink Maestro (commercially available).

*2 Displays the value obtained from the GPS.

*3 This feature is only available when the iDatalink Maestro (commercially available) is connected to a vehicle with automatic transmissions.

*4 This is not displayed while Pitch/Roll data from iDatalink Maestro is being notified.

Switching vehicle image

You can change the image displayed for the vehicle.

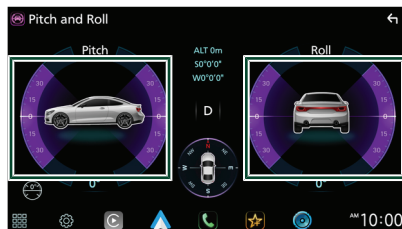

Tap the image of the vehicle on the screen to change the image.

- There are 6 vehicle images. (sports car / station wagon / truck / sedan / box car / SUV)

Setup

1 KW-Z1001W/KW-Z1000AW

Press the  button.

KW-Z800AW

Touch  at the top of the screen.

Touch  HOME on the popup menu.

HOME screen appears.

2 Touch .

3 Touch [SETUP].



See the following section for each setting.

- Set up connection and AV (**P.90**)
- Set up display and button (**P.92**)
- Set up the user interface (**P.94**)
- Set up camera (**P.83**)
- Set up systems (**P.95**)
- Set up key assignment (**P.96**)

Monitor Screen Setup

You can adjust the image quality of video, menu screen, etc.

1 KW-Z1001W/KW-Z1000AW

Press the **FNC**  button.

KW-Z800AW

Touch  at the top of the screen.

Popup menu appears.

2 Touch [Screen Adjust].

KW-Z1001W/KW-Z1000AW

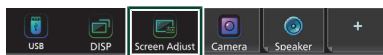

KW-Z800AW

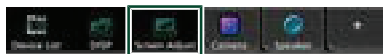

Screen Adjustment screen appears.

3 Adjust each setting as follows.

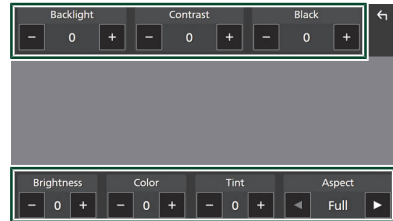

■ [Backlight] / [Contrast] / [Black] / [Brightness] / [Color] / [Tint]

Adjust each setting.

■ [Aspect]

Select a screen mode.



- **"Full"**: Changes the aspect ratio of video and displays video fully on the screen.
- **"Normal"**: Displays video at the ratio of 4:3.
- **"Auto"**: USB device: Displays video fully (vertically or horizontally) with no ratio change.

NOTE

- Settings to adjust vary depending on the current source.

Connection & AV Setup

You can set connection and AV parameters.

- 1 **KW-Z1001W/KW-Z1000AW**
 Press the  button.
KW-Z800AW
 Touch  at the top of the screen.
 Touch  HOME on the popup menu.
 HOME screen appears.
- 2 Touch .
- 3 Touch [SETUP].
 SETUP Menu screen appears.
- 4 Touch [Connection & AV].
 Connection & AV setting menu appears.
- 5 Set each parameter as follows.



- **[Bluetooth]**
 Turns the Bluetooth function on or off.
- **[Device List]**
 Select the connected device to be used.
 (P.72)
- **[Device Name]**
 If you select [ON] for [Bluetooth], you can change the Bluetooth device name. See **Change the device name (P.74)**.
- **[PIN Code]**
 If you select [ON] for [Bluetooth], you can change the PIN code.
 See **Change the PIN Code (P.74)**.
- **[Device address]**
 Display the Bluetooth device address.
- **[TEL SETUP]**
 You can make various settings for the Hands-Free function.
 See **Hands-Free Setup (P.82)**.

- **[Wi-Fi] ****
 Register the Wi-Fi access point to be used for the Internet connection with SiriusXM sources. (P.50)

- **[360L IP Connection] ****
 Make the settings for connecting to the Internet with SiriusXM sources. (P.50)
 "ON"/"OFF" (Default)

- When set to "ON", Apple CarPlay, Android Auto and wireless mirroring sources cannot be used.

- **[Wireless Mirroring SSID]**
 You can change the SSID. See **Change the device name or Wireless Mirroring SSID (P.91)**.

- **[Android Auto Auto Launch]**
 Select whether to display the Android Auto screen automatically. Default is "ON".

- **[Guidance/Voice Recognition Volume]**
 Adjust the volume of the guidance and voice recognition in Apple CarPlay or Android Auto mode. Default is "19".

- **[Incoming Call Volume (Ring)]**
 Adjust the ring tone volume in Apple CarPlay or Android Auto mode. Default is "15".

- **[In Call Volume (Talking)]**
 Adjust the dial tone volume and the volume during a call in Apple CarPlay or Android Auto mode. Default is "15".

- **[Speech Quality Adjust]**
 Adjust the speech quality.

- **[Microphone Level]** : Adjust the level of microphone gain. Default is "0".
- **[Echo Cancel Level]** : Adjust the level of echo cancellation. Default is "0".
- **[Noise Reduction Level]** : Reduce the noise generated in the surrounding environment without changing the microphone volume. Use this function when the voice of caller is not clear. Default is "0".
- **[Time Alignment]** : Not used.

- **[iPhone Bluetooth Connection]**
 See **Select the method of making connections for outputting sound from the iPhone source (P.39)**.

■ [Reverse with ATT]

Select whether to decrease the audio volume automatically when the gear is shifted to the reverse (R) position. Default is "ON".

■ [Reset Android Auto Wireless Connection]

Regenerate a Pre-shared Key (PSK) to connect wirelessly with Android Auto. A confirmation dialog will appear because the system needs to restart to regenerate a PSK.

■ [Built-In Amplifier]

Select whether to use the built-in power amplifier.

Turning off the built-in amplifier improves the quality of the sound from Preout.
"ON" (Default) / "OFF"

*1 This can be set when the SXV300 tuner (G2) (sold separately) is connected.

📄 Change the device name or Wireless Mirroring SSID

1 KW-Z1001W/KW-Z1000AW

Press the   button.

KW-Z800AW

Touch  at the top of the screen.

Touch  HOME on the popup menu.
HOME screen appears.

2 Touch .

3 Touch [SETUP].

SETUP Menu screen appears.

4 Touch [Device Name] / [Wireless Mirroring SSID].

Change Device Name screen or Change Wireless Mirroring SSID appears.

5 Input the device name or SSID.

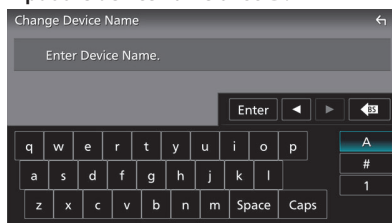

6 Touch [Enter].

Display & Button Setup

1 KW-Z1001W/KW-Z1000AW

Press the   button.

KW-Z800AW

Touch  at the top of the screen.

Touch  HOME on the popup menu.

HOME screen appears.

2 Touch .

3 Touch [SETUP].

SETUP Menu screen appears.

4 Touch [Display & Button].

Display & Button setting menu appears.

5 Set each parameter as follows.

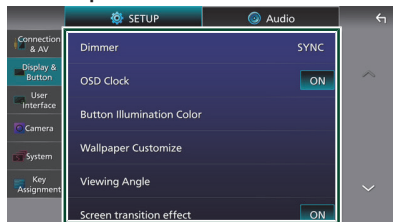

■ [Dimmer]

Select the dimmer mode.

- **[OFF]:** Does not dim the display and buttons.
- **[ON]:** Dims the display and buttons.
- **[SYNC]** (Default): Turns the dimmer function on or off when the vehicle light control switch is turned on or off.

■ [OSD Clock]

Select if you want to display the clock while the screen is off, or while watching video files on USB, etc.

"ON" (Default)/"OFF"

■ [Button Illumination Color] (KW-Z1001W/KW-Z1000AW only)

You can set the button illumination color. (P.93)

■ [Wallpaper Customize]

You can change the wallpaper image or color. (P.92)

■ [Viewing Angle]

If it is hard to see the image on the screen evenly, adjust the viewing angle. The smaller the (negative) value, the more whitish the image on the screen looks. "0" (Default)/"-1"/"-2"/"-3"

■ [Screen transition effect]

Select whether to use the screen transition effect when the source control screen is switched to the Home screen.

"ON" (Default)/"OFF"

Change the wallpaper image

1 Touch [Wallpaper Customize] in the Display & Button setting menu.

2 Select an image from live or static wallpapers.

Live wallpaper

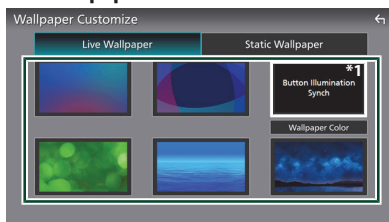

Static wallpaper

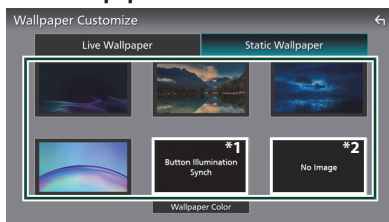

*1 Select a wallpaper and button illumination color in advance.

*2 Select an original image in advance.

To select wallpaper color

1 Touch [Wallpaper Color] on the Wallpaper Customize screen.

2 Select a wallpaper color. KW-Z1001W/KW-Z1000AW Live wallpaper

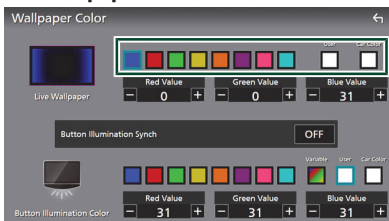

Static wallpaper

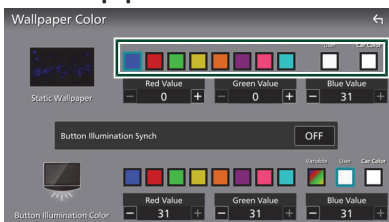

KW-Z800AW Live wallpaper

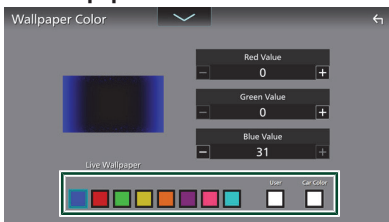

Static wallpaper

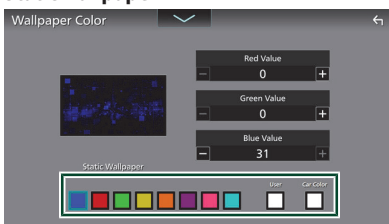

■ [User]

You can set the color created with the RGB color mixer. For how to create an original color, see **To register an original image (P.93)**.

■ [Car Color]

This can be selected when the iDataLink Maestro (commercially available) is connected.

■ [Button Illumination Synch] (KW-Z1001W/KW-Z1000AW only)

The color you have selected at [Button Illumination Color] can be set. If you adjust the color value with the following RGB color mixer, the adjusted color will be applied to the wallpaper and the button illumination.

For how to set the button illumination color and create an original color, see **Customizing the button color (P.93)**.

“ON”/“OFF”(default)

- When [Button Illumination Color] is “Variable” on the static wallpaper color screen, this option is fixed to OFF.

3 Touch .

To register an original image

With “JVC Portal APP” application installed on your iPhone or Android smartphone, you can upload image files to this unit and set an image as the wallpaper image. See **Importing Image Files (P.26)**.

■ Customizing the button color (KW-Z1001W/KW-Z1000AW only)

You can set the button illumination color.

1 Touch [Button Illumination Color] in the Display & Button setting menu.

2 Touch the desired color.

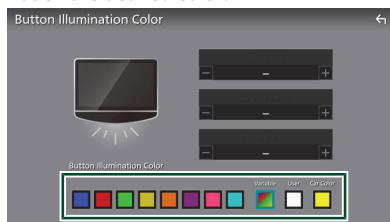

■ [Variable]

You can set the button color to continuously scan through the color spectrum.

■ [User]

You can set the color created with the RGB color mixer.

Setup

■ [Car Color]

This can be selected when the iDatalink Maestro (commercially available) is connected.

3 Touch .

To register an original color

You can register your original color.

1 Touch [User] on the Button Illumination Color screen.

2 Use [-] and [+] to adjust each color value.

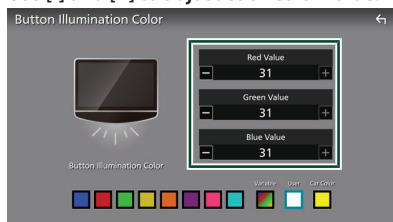

3 Touch .

NOTE

- You can create a color based on a preset color. Touch the preset color instead of [User], and adjust the color value.

User Interface Setup

You can setup user interface parameters.

1 **KW-Z1001W/KW-Z1000AW**

Press the   button.

KW-Z800AW

Touch  at the top of the screen.

Touch  HOME on the popup menu. HOME screen appears.

2 Touch .

3 Touch [SETUP].

SETUP Menu screen appears.

4 Touch [User Interface].

User Interface setting menu appears.

5 Set each parameter as follows.

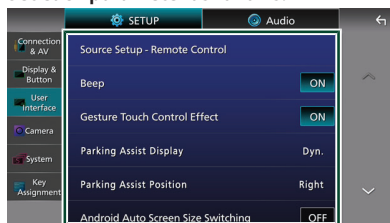

■ [Source Setup - Remote Control]

Select the sources to be switched with the remote controller. For how to operate the remote controller, see Remote control. (P.111) (P.115)

■ [Beep] *1

Turn the key touch tone on or off. Default is "ON".

■ [Gesture Touch Control Effect]

Determine whether to show the trace of finger under gesture touch control. (P.11) "ON" (Default)/"OFF"

■ [MENU Button Display] (KW-Z800AW only)

This sets whether or not the  button is displayed.

When this is set to OFF, operations are carried out with the included remote control.

"ON" (Default)/"OFF"

■ [Parking Assist Display] *2

When the iDatalink Maestro (commercially available) is connected, you can display information about obstacles around the car.

- **[ON]:** Always displays information.
- **[Dyn.]** (Default): Displays information when the sensor detects obstacles.
- **[OFF]:** Cancels this function.

■ [Parking Assist Position] *2

Select where to display information about obstacles on the screen (left or right).
“Left”/“Right” (Default)

■ [Android Auto Screen Size Switching]

Turn the Android Auto Split selection feature on or off.

“ON”/“OFF” (Default)





■ [Driving Position]

Select the driving position (left or right).
“Left” (Default)/“Right”

- *1 To use the function, it is necessary to set [Fiber Optic Output] to [OFF], and to set [X'over Network] to [2way].
- *2 This can be set when the iDatalink Maestro (commercially available) is connected.

System Setup

You can setup system parameters.

- 1 **KW-Z1001W/KW-Z1000AW**
Press the   button.
KW-Z800AW
Touch  at the top of the screen.
Touch  HOME on the popup menu.
HOME screen appears.
- 2 Touch .
- 3 Touch [SETUP].
SETUP Menu screen appears.
- 4 Touch [System].
System setting menu appears.
- 5 Set each parameter as follows.



■ [DEMO]

Select the demonstration mode. Default is “ON”.

■ [Operation Guide Display]

Determine whether to show the touch screen operation guide screen every time before HOME screen is displayed.
Default is “ON”.

■ [System Information]

Confirm the system information of this unit. (P.96)

■ [Open Source Licenses]

Display the open source licenses.

■ [Initialize]

Touch [Initialize] and then touch [Yes] to set all the settings to the initial default settings.

- Audio SETUP Memory is not initialized.

■ [Maestro SETUP]

Confirm the information about or change the settings for using the iDatalink Maestro (commercially available).

Setup

■ [Vehicle Features]

This function requires a commercial adaptor.

Consult your JVC dealer for details.

■ [Language Select]

Select a language.

■ [Time Format]

■ [Time Zone]

You can set the time. See **Select the time zone and time format (P.15)**.

■ System Information

You can confirm the software version of this unit.

1 Touch [System Information] in the System setting menu.

2 Verify the software version and model name.

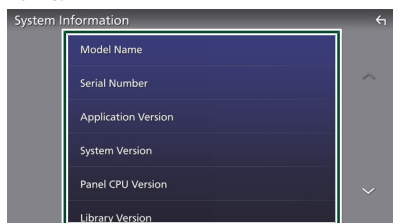

NOTE

- For how to update the software, see the relevant update procedure manual which comes with the software.

Key Assignment Setup

You can set key assignment parameters.

1 **KW-Z1001W/KW-Z1000AW**

Press the   button.

KW-Z800AW

Touch  at the top of the screen.

Touch  HOME on the popup menu. HOME screen appears.

2 Touch .

3 Touch [SETUP].

SETUP Menu screen appears.

4 Touch [Key Assignment].

Key Assignment setting menu appears.

5 Set each parameter as follows.

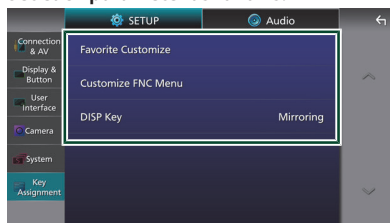

■ [Favorite Customize]

Select the function which you wish to set for [Favorite] icon. **(P.96)**

■ [Customize FNC Menu]

Select the function which you wish to set for the function key1 to 3. **(P.97)**

■ [DISP Key]

Select the source screen displayed when  in the popup menu screen is touched.

- **[OFF]**: Displays the control screen of the current source.
- **[Mirroring]** (Default): Switches to the App screen from the connected iPhone or Android smartphone or to the Apple CarPlay screen from the connected iPhone when the key is touched. **(P.27)**

■ Customize Favorite key

You can jump to your favorite function easily from HOME screen.

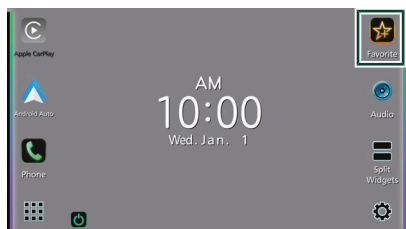
**NOTE**

- You can also jump to your favorite function when you press and hold **FNC**  button. (KW-Z1001W/ KW-Z1000AW only)
- Favorite key may be disabled on some screens depending on the registered function. When this key is invalid, start the desired function by normal procedure.

To register a favorite function

- 1 Touch [Favorite Customize] on the Key Assignment Setup screen.
Customize Favorite Key screen appears.

- 2 Select a favorite function.

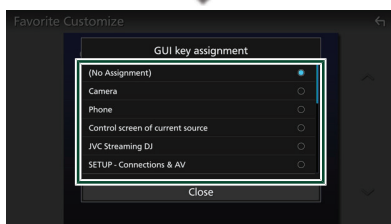
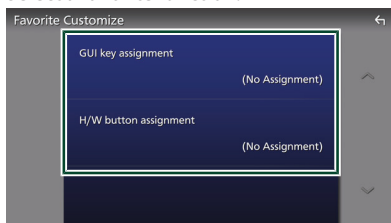

- 3 Touch [Close].

NOTE

- You can also change the assignment when you touch and hold [Favorite] icon on the HOME screen.
- If it is your first time to touch [Favorite] icon after installation, the function list dialog will appear.

Customize popup menu functions

You can register a function for each of the function key1 to 3.

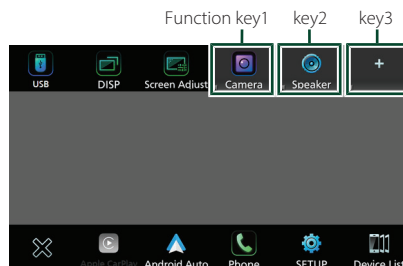
**To register a function**

- 1 Touch [Customize FNC Menu] on the User Interface screen.
Customize FNC Menu screen appears.

- 2 Select the function key you want to customize.

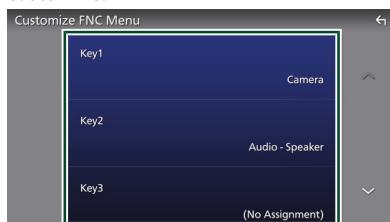

The function list screen appears.

- 3 Select a function.

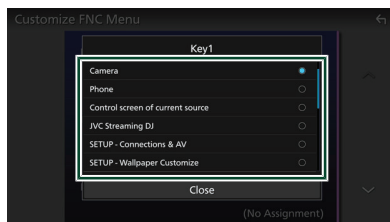

Setup

4 Touch [Close].

NOTE

- You can change the assignment when you touch and hold the desired function key.

Controlling Audio

The [System Configuration] settings must match the configuration of the connected amplifiers and speakers. (P.15)

- **Select the appropriate crossover network mode for the speaker system used (2-way or 3-way speaker system)**

⚠ CAUTION

Connecting 3-way speakers with the 2-way mode selected can break the speakers.

Set [X'over Network] to either 2-way or 3-way. (P.15)

For the connection method, see 3-way speaker system setup. (P.128)

NOTE

- When the 3-way speaker system is selected, the following functions are disabled.
 - Front focus of Listening Position / DTA
 - Fader for Controlling General Audio
 - Selection of the speakers to output sound from the smartphone/cell-phone of Bluetooth HF/Audio
 - Beep for User Interface Setup

- **Select whether to use the built-in amplifier**

Set the [Built-In Amplifier] to either ON or OFF. (P.15) (P.90)

Turning off the built-in amplifier improves the quality of the sound from Preout.

Audio Setup

You can adjust various settings such as audio balance or subwoofer level.

1 KW-Z1001W/KW-Z1000AW

Press the   button.

KW-Z800AW

Touch  at the top of the screen.

Touch  HOME on the popup menu.

HOME screen appears.

2 Touch .

3 Touch [Audio].



See the following section for each setting.

- Set up Speaker / X'over (P.100)
- Controlling EQ / SW Level (P.101)
- Set Position / DTA (P.102)
- Controlling Fader / Balance (P.104)
- Set Volume Offset (P.105)
- Set Sound Effect (P.105)
- Use Audio Memory (P.110)

NOTE

- When the iDataLink Maestro (commercially available) is connected, the best audio settings are set automatically. Each parameter as follows are set.
 - Speaker / X'over
 - EQ / SW Level
 - Position / DTA
 - Fader / Balance
 - Sound Effect
- To recall the settings automatically adjusted by the iDataLink Maestro connection when the settings are changed manually, touch [Audio SETUP Clear] in the Audio Memory setting menu. (P.110)

Speaker / X'over setup

1 KW-Z1001W/KW-Z1000AW

Press the button.

KW-Z800AW

Touch at the top of the screen.

Touch HOME on the popup menu.
HOME screen appears.

2 Touch .

3 Touch [Audio].

Audio screen appears.

4 Touch [Speaker / X'over].

5 Select a car type.

You can select the car type and speaker network, etc.

When you select your car type, the Delay Time Alignment is activated automatically (for timing adjustment of sound output for each channel) to have the highest surround effects.



6 Touch the speaker (1) you wish to adjust and set each parameter (2) as follows.



■ [Speaker]

You can select a speaker type and its size to get the best sound effects.

If no rear speakers or subwoofer are connected, select "None" for each.

When the speaker type and size are selected, the speaker crossover network is set automatically.

■ [Location] (Only for Front, Rear)

Select the speaker position you have installed.

■ [Tweeter] (Only for Front)

You can set up the tweeter when you are selecting front speakers.

None, Small, Medium, Large

■ [HPF FREQ] (Only for Front, Rear)

High Pass Filter adjustment.

■ [LPF FREQ] (Only for Subwoofer)

Low Pass Filter adjustment.

■ [Slope]

Set a crossover slope.

■ [Gain]

Adjust the gain of the front speaker, rear speaker, or subwoofer.

■ [TW Gain] (Only for Front)

Adjust the tweeter level.

■ [Phase Inversion] (Only for Subwoofer)

Set the phase of subwoofer output.

Check [Phase Inversion] to shift the phase 180 degrees.

When Speaker network is set to 3-way:

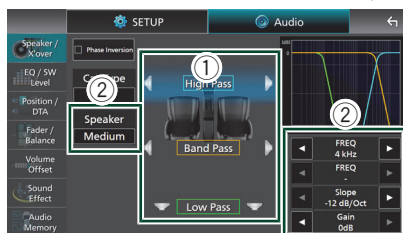

■ [Speaker]

You can select a speaker type and its size to get the best sound effects.

When the speaker type and size are selected, the speaker crossover network is set automatically.

■ [FREQ] (High Pass)

High Pass Filter adjustment. (Only for High Pass)

■ [FREQ] (Low Pass)

Low Pass Filter adjustment. (Only for Low Pass)

■ [HPF FREQ], [LPF FREQ] (Only for Band Pass)

Band Pass Filter adjustment.

■ [Slope]^{*1 *2}

Set a crossover slope.

■ [Gain]

Set the gain of each speaker.

■ [Phase Inversion]

Set the phase of tweeter, mid range, and woofer output.

Check [Phase Inversion] to shift the phase 180 degrees.

- *1 Only when "LPF FREQ"/"HPF FREQ" (Band Pass) is set to a mode other than "Through".
- *2 Only when "FREQ" (Low Pass) is set to a mode other than "Through".

NOTE

- For how to switch to the 3-way speaker system, see [X'over Network] in the System Configuration settings. (P.15)

Equalizer Control

You can adjust equalizer by selecting the optimized setting for each category.

1 KW-Z1001W/KW-Z1000AW

Press the  button.

KW-Z800AW

Touch  at the top of the screen.

Touch  HOME on the popup menu.

HOME screen appears.

2 Touch .

3 Touch [Audio].

Audio screen appears.

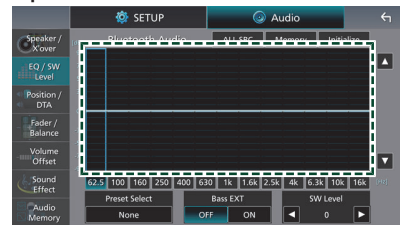

4 Touch [EQ / SW Level].

5 Touch the screen and set the Graphic Equalizer as desired.



■ Gain level (area in dotted frame)

Adjust the gain level by touching each frequency bar.

You can select a frequency bar and adjust its level by [, ].

■ [ALL SRC]

Apply the adjusted equalizer curve to all sources. Touch [ALL SRC] and then touch [OK] on the confirmation screen.

■ [Memory]

Saves the adjusted equalizer curve as "User1" to "User4". (P.102)

■ [Initialize]

Initialize (flatten) the current EQ curve.

■ [Preset Select]

Display the screen for selecting the preset equalizer curve. (P.102)

■ [Bass EXT] (Bass Extend Settings)

When turned on, the frequencies lower than 62.5 Hz is set to the same gain level (62.5 Hz).

Controlling Audio

■ [SW Level]

Adjust the subwoofer volume. This setting is not available when Subwoofer is set to "None". See **Speaker / X'over setup (P.100)**.

■ Recall the EQ curve

- 1 Touch [Preset Select].
- 2 Select an EQ curve.

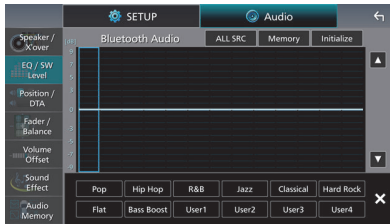

■ Save the EQ curve

- 1 Adjust the EQ curve.
- 2 Touch [Memory].
- 3 Select where to save.

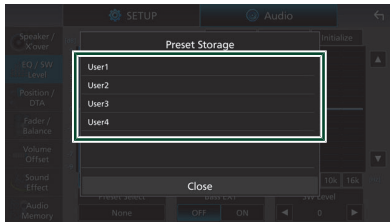

Listening Position / DTA

Listening Position / DTA allows you to improve the sound field depending on the position of the seat you sit.

Listening Position / DTA allows you to set "Listening Position" and "Front Focus". You cannot set both at the same time.

1 KW-Z1001W/KW-Z1000AW

Press the button.

KW-Z800AW

Touch at the top of the screen.

Touch HOME on the popup menu. HOME screen appears.

2 Touch .

3 Touch [Audio].

Audio screen appears.

4 Touch [Position / DTA].



- Set up Listening Position (**P.102**)
- Set up Front Focus (**P.103**)

■ Listening Position

Adjust the sound delay time so that the sounds from different speakers arrive at the listener sitting on the selected seat at the same time.

- 1 Touch [Listening Position] on the Position / DTA screen.

- 2 Select a listening position from [Front R] (Right front), [Front L] (Left front), [Front All] (All front), and [All].

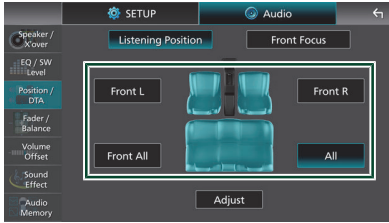

Position DTA control

You can fine-adjust your listening position.

- 1 Touch [Adjust].
- 2 Touch [Delay].
- 3 Touch [◀] or [▶] to adjust the delay time of the selected speaker.



- 4 Touch [Level].
- 5 Touch [◀] or [▶] to adjust the sound level of the selected speaker.



NOTE

- To initialize the Delay and Level settings, touch [Initialize] and [YES] on the confirmation screen.

Front Focus

You can focus the imaginary sound image on the front of the selected seat.

- 1 Touch [Front Focus] in the Position / DTA screen.
- 2 Select a front focus position. For [Front All] and [All], select Priority L or R depending on which side you want to put the imaginary sound image.

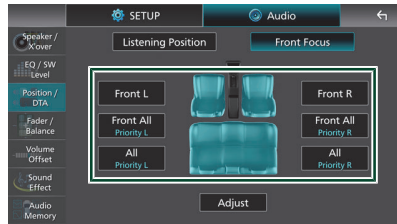

NOTE

- When the 3-way speaker system is selected, front focus feature is disabled.

Front Focus fine adjustment

- 1 Touch [Adjust].
- 2 Touch [Delay].
- 3 Set each parameter as follows.

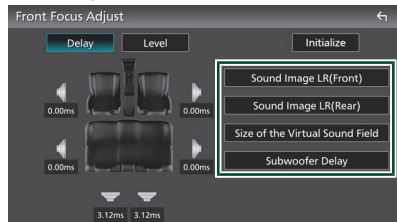

■ [Sound Image LR (Front)]

Focus the sound image on the front of front seats.

■ [Sound Image LR (Rear)]

Focus the sound image on the front of rear seats.

Controlling Audio

■ [Size of the Virtual Sound Field]

Adjust the size of sound image to meet your taste. If the sound image is shifted from the front, move it back by [Sound Image LR (Front)] or [Sound Image LR (Rear)].

■ [Subwoofer Delay]

Adjust the delay time of subwoofer sound.

4 Touch [Level].

5 Touch [◀] or [▶] to adjust the sound level of the selected speaker.



NOTE

- To initialize the Delay and Level settings, touch [Initialize] and [YES] on the confirmation screen.

Fader / Balance

You can adjust the volume balance among the speakers.

1 **KW-Z1001W/KW-Z1000AW**

Press the button.

KW-Z800AW

Touch at the top of the screen.

Touch HOME on the popup menu.

HOME screen appears.

2 Touch .

3 Touch [Audio].

Audio screen appears.

4 Touch [Fader / Balance].

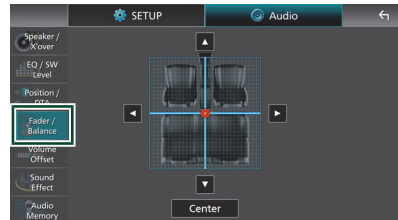

5 Touch [◀], [▶], [▲], and [▼] to adjust the volume balance.

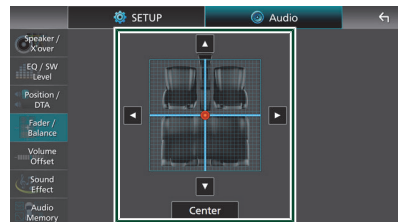

[◀] and [▶] adjust the left and right volume balance.

[▲] and [▼] adjust the front and rear volume balance.

■ [Center]

Clear the adjustment.

NOTE

- When the 3-way speaker system is selected, "Fader" adjustment is disabled.

Volume Offset

Finely adjust the volume of the current source to minimize the difference in volume between different sources.

1 KW-Z1001W/KW-Z1000AW

Press the   button.
KW-Z800AW

Touch  at the top of the screen.

Touch  HOME on the popup menu.
HOME screen appears.

2 Touch .

3 Touch [Audio].

Audio screen appears.

4 Touch [Volume Offset].

5 Touch [+] or [-] to adjust the level.

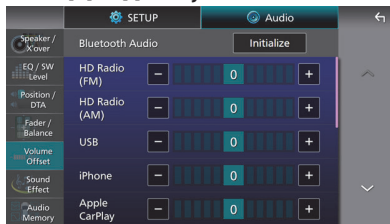

[Initialize]

Returns to the initial settings.

Touch [Initialize] and then touch [YES] on the confirmation screen.

NOTE

- If you have increased the volume first, then reduce the volume using "Volume Offset". Switching the current source to another source suddenly may output extremely loud sound.

Sound Effect

You can set sound effects.

1 KW-Z1001W/KW-Z1000AW

Press the   button.
KW-Z800AW

Touch  at the top of the screen.

Touch  HOME on the popup menu.
HOME screen appears.

2 Touch .

3 Touch [Audio].

Audio screen appears.

4 Touch [Sound Effect].

5 Set each parameter as follows.

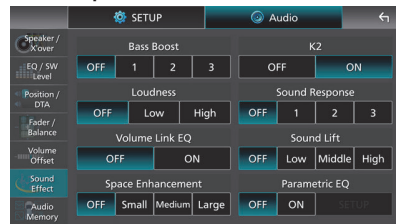

[Bass Boost]

Set the amount of bass boost

"OFF"/"1"/"2"/"3".

[Loudness]

Set the amount of boost of low and high tones.

"OFF", "Low", "High"

[Volume Link EQ]

Reduce the driving noise by boosting specific frequencies in the audio signal.

"OFF", "ON"

[Space Enhancement]

Select the feeling of sound space enhancement.

"OFF"/"Small"/"Medium"/"Large".

This setting is not available for the HD Radio tuner source.

[K2]

Turn ON/OFF the K2 function.

Technology to extrapolate and supplement with proprietary algorithm, the high-frequency range that is cut off when encoding.

Controlling Audio

■ [Sound Response]

Virtually make the sound more realistic using the Digital Signal Processor (DSP) system.

Select the level from "OFF"/"1"/"2"/"3".

■ [Sound Lift]

You can adjust the height of speakers virtually to suit your listening position. "OFF"/"Low"/"Middle"/"High".

■ [Parametric EQ]

When set to "ON", you can use the parametric equalizer. For details, see **Parametric Equalizer (P.106)**.

Parametric Equalizer

In addition to the conventional Graphic Equalizer, this unit has a parametric equalizer, which allows you more precise adjustments. By using each equalizer properly, you can calibrate the unit more thoroughly.

Adjustment using this function requires expertise.

When to Use Each Function

- **Parametric Equalizer**
Use this to finely correct or improve the frequency characteristics of the acoustics of the car in order to establish a basis for adjustments.
Practiced ears or a measuring equipment may be required to apprehend the problems of the sound field inside the car.
- **Graphic Equalizer**
Use this to actively create an attractive sound as conventionally.
Everybody can easily get the result through trial and error of intuitive operations.
Even more effective adjustments are possible when the basis is established by using the Parametric Equalizer.

■ About the Parametric Equalizer

This system allows you to freely control the filter, frequency, Q factor (acuteness) and slope gain at 14 points consisting of 9 points common for front/rear/subwoofer, 2 points for front only, 2 points for rear only, and one point for subwoofer only.

NOTE

- Configure the Parametric Equalizer to establish the basis for adjustments before making adjustments using the Graphic Equalizer.
- The changes made using the Parametric Equalizer are not shown on the Graphic Equalizer screen.
- You can check the effects using the Parametric Equalizer ON/OFF key.

About Adjustments

If there are unpleasant peaks, you can slide the peaking filter to the left or right and search the frequencies by ear. Studio engineers use this method to make adjustments quickly and efficiently.

However, in order to identify peaks and dips of a car audio system, you have to capture the pink noise outputted from the speaker using a microphone and analyze it using a real time analyzer (RTA). From the analysis result, identify the peaks and/or dips that need to be corrected and configure the filters to cancel them.

About the Filters of Parametric Equalizer

Filters allow you to remove or extract specific sound through signal processing.

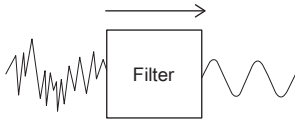

NOTE

- Cutoff frequency is the boundary between the passband and the stopband. The definition of cutoff frequency is a frequency for which the output is -3 dB of the nominal passband value.

● High-Pass Filter

Passes signals with frequencies higher than a certain frequency (f_c : cutoff frequency) and attenuates signals with frequencies lower than the cutoff frequency. Use this to pass only high-frequency signals. Use this in the following cases for example:

- For extracting the frequency band for separate tweeters. By extracting the specific frequency band, level adjustment can be made to the frequency band individually.

- The sound may be muddy when you play back low frequency sound. This occurs when frequencies below the speaker capacity is inputted. To cancel this, use the high-pass filter to cut off the frequencies below the speaker capacity.

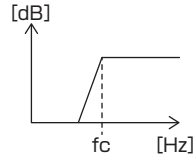

● High-Shelving Filter/Low-Shelving Filter

These filters reduce or increase signals above or below a certain frequency (f_c : cutoff frequency), which create shelves in the frequency spectrums. A high-shelving filter reduces or increases the frequencies above the target frequency and a low-shelving filter reduces or increases the frequencies below the target frequency. The low shelf controls the lower frequencies and the high shelf controls the high frequencies. Use these in the following cases for example:

- When you want to change the volume of the tweeters, for example when they are close to your ears and are sounding too loud.
- When you want to change the subwoofer volume at hand.

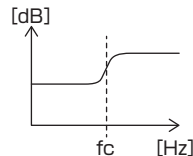

● Peaking Filter

The frequencies in the vicinity of a certain frequency (f_0 : center frequency) are boosted or attenuated. Use this in the following cases for example:

- When you want to control a narrow range of frequencies to correct the frequency abnormality in the car.
- To diminish a chattering noise from the speaker by attenuating the frequency range of the noise.

Controlling Audio

- To adjust of the sound balance of the whole range between the low end and the high end.

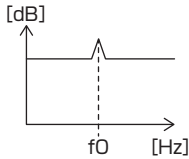

● Low-Pass Filter

Passes signals with frequencies lower than a certain frequency (f_c : cutoff frequency) and attenuates signals with frequencies higher than the cutoff frequency. Use this to pass only low-frequency signals. Use this in the following cases for example:

- For extracting the low frequencies band for a subwoofer.
- For extracting middle/low frequencies when you are using speakers with separate tweeters and you want to output the high frequencies to the tweeters and output the middle/low frequencies to the woofers.
- To cut the high frequencies when they are too loud.

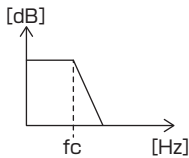

■ Adjust the Parametric Equalizer

Preparation

- Correct the value in "Listening Position" and "Front Focus" before adjusting the parametric equalizer. See [Listening Position / DTA \(P.102\)](#).

1 KW-Z1001W/KW-Z1000AW

Press the button.
KW-Z800AW

Touch at the top of the screen.

Touch HOME on the popup menu.
HOME screen appears.

2 Touch .

3 Touch [Audio].

4 Touch [Sound Effect].

5 Set the Parametric EQ to [ON] and touch [Yes].

6 Touch [SETUP].

Parametric EQ screen appears.

7 While auditioning music, move the peaking filter to the left and right to search for unpleasant peaks and suppress them.

8 Use pink noise and an analyzer to identify dips, as dips are difficult to find.

Correct steep (10 dB or greater) peaks and dips as these are generally regarded as obstructions to sound quality.

9 Set each parameter as follows.

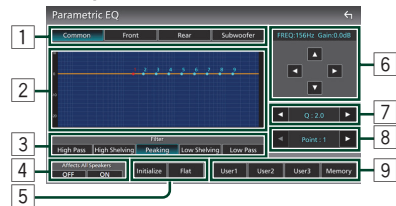

10 When you have finished adjustments, save the results as a preset, and check the effects by switching presets or turning the Parametric EQ [ON] and [OFF].

11 Use the Graphic Equalizer to make final adjustments. (P.105)

1 Speaker

Select the speaker.

- **When Speaker network is set to 2-way:** "Common" / "Front" / "Rear" / "Subwoofer"
- **When Speaker network is set to 3-way:** "Common" / "Tweeter" / "Middle" / "Woofer"

2 EQ points/curve

Displays the EQ point and the curve. Adjust the EQ points by touching.

- **EQ point (red):** The EQ point currently being adjusted.
- **EQ point (blue/yellow):** EQ points that are not currently being adjusted.
- **Curve (orange):** EQ curve of the speaker currently being adjusted.

- **Curve (blue):** Overall EQ curve.

3 Filter

Select the filter.

“High Pass” / “High Shelving” / “Peaking” / “Low Shelving” / “Low Pass”

4 Affects All Speakers^{*1}

- **[ON]:** Outputs sound from all speakers.
- **[OFF]:** Outputs sound from the currently selected speaker only.

5 [Initialize] / [Flat]

- **[Initialize]:** Initialize (flatten) the adjustment of all the speakers.
- **[Flat]:** Initialize (flatten) the adjustment of the current speaker.

6 Frequency / Gain

Set the frequency and gain.

[◀] and [▶] adjust the frequency.

[▲] and [▼] adjust the gain.

NOTE

- Touch the EQ point to roughly determine the frequency and gain, then use this key to make fine adjustments.

7 Q / Slope^{*2}

Set the Q factor and slope.

8 Point

Select the EQ point to adjust.

9 Preset

- **[User1] / [User2] / [User3]:** Recalls the preset EQ.
- **[Memory]:** Stores the current EQ settings.

*1 Only when the speaker other than “Common” is selected.

*2 When “Peaking” filter is selected, you can adjust the Q factor. When “High Pass” or “Low Pass” filter is selected, you can adjust the slope.

NOTE

- You can adjust the EQ points and curve based on a preset EQ. Recall the preset EQ and touch the preset key again to unselect it before adjustment.

Audio Setup memory

Audio Control settings can be memorized. The memorized settings can be recalled at any time.

1 **KW-Z1001W/KW-Z1000AW**

Press the   button.

KW-Z800AW

Touch  at the top of the screen.

Touch  HOME on the popup menu.

HOME screen appears.

2 Touch .

3 Touch [Audio].

Audio screen appears.

4 Touch [Audio Memory].

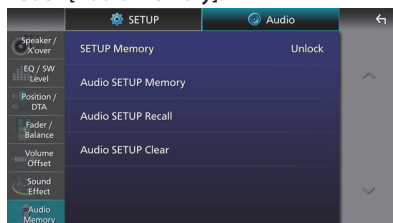

■ [SETUP Memory]

Lock or unlock the Audio SETUP Memory/ Recall/Clear.

■ [Audio SETUP Memory]

Memorize the current audio settings. Fader / Balance, Speaker / X'over, Equalizer (User Preset, SW Level), Position / DTA, Sound Effect (**P.99**)

■ [Audio SETUP Recall]

Recall the memorized audio setting.

■ [Audio SETUP Clear]

Clear the Audio SETUP Memory and the currently memorized audio settings. If the iDataLink Maestro (commercially available) is connected, the audio settings revert to the values set by the iDataLink Maestro.

Remote control (accessory)

KW-Z800AW

This unit can be operated using the remote control. (RM-RK260).

▲ WARNING

- Do not ingest the battery, Chemical Burn Hazard
The remote control supplied with this product contains a coin/button cell battery. If the coin/button cell battery is swallowed, it can cause severe internal burns in just 2 hours and can lead to death.
- Keep new and used batteries away from children. If the battery compartment does not close securely, stop using the product and keep it away from children.
- If you think batteries might have been swallowed or placed inside any part of the body, seek immediate medical attention.

▲ CAUTION

- Risk of fire or explosion if the battery is replaced by an incorrect type. Ensure to replace only with the same type.
- Risk of fire, explosion or the leakage of flammable liquid or gas if the battery is left in an extremely high temperature surrounding environment and/or subjected extremely low air pressure. The battery pack or batteries shall not be exposed to excessive heat such as sunshine, fire or the like.
- Risk of fire, explosion or the leakage of flammable liquid or gas if the battery is disposed into fire or a hot oven, recharged, shorted, mechanically crushed or cut of the battery.
- If spilled fluid comes in contact with your eyes or on clothing, immediately rinse with water and consult a physician.

Battery Installation

Preparing the remote control unit

Pull the battery sheet out from the remote control unit to the direction of the arrow.

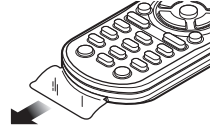

Changing the battery of the remote control unit

Keep on slide



- Use a commercially available button battery (CR2025).
- Insert the battery with the + and – poles aligned properly.
 - If the effectiveness of the remote controller decreases, replace the battery.

Functions of the Remote control Buttons

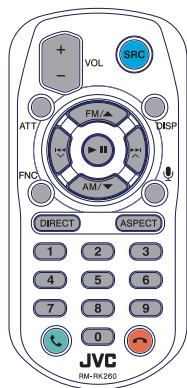

Key Name	Function
SRC	Switches to the source to be played. In Hands-Free mode, hangs up the phone.
VOL + -	Adjusts the volume.
ATT	Lowers the volume when pressed once. Restores the previous volume when pressed twice.
DISP	Switches the screen between the current source and the App screen from the connected iPhone or Android.
FM/▲ AM/▼	Selects the folder to be played. For the HD Radio source, selects FM/AM band to be received. Not used for the SiriusXM source.
⏪ ◂ ▸ ⏩	Selects the track or file to be played. For the HD Radio and SiriusXM sources, switches to broadcast stations received by the unit.
⏸/	Pauses the track or file, and resumes playing by pressing twice. For the HD Radio sources, switches the seek mode. Not used for the SiriusXM source.
FNC	Displays the popup menu screen.
📞	<ul style="list-style-type: none"> Switches the voice recognition function on. (P.29) (P.32) (P.79) When neither Apple CarPlay, Android Auto, nor a Bluetooth Hands-Free phone is connected, pressing and holding displays Bluetooth pairing waiting dialog. (P.71)

Key Name	Function
DIRECT	Switches to the direct search mode. For details on the direct search mode, see Direct search mode (P.112) .
ASPECT	Changes the aspect ratio. To confirm the current aspect ratio setting, operate on the touch panel. (P.89)
Numeric Keypad	<ul style="list-style-type: none"> Allows you to enter the number to search in the direct search mode. For details on the direct search mode, see Direct search mode (P.112). For the HD Radio and SiriusXM sources, allows you to enter the preset number. <ul style="list-style-type: none"> If the preset number is single digit, press the number. If the preset number is double digits, press continuously the numbers within 3 seconds. Pressing [◀▶] or [▶▶] within 3 seconds allows you to determine the preset number of single digit.
📞	When a call comes in, answers the call.
📞	When a call comes in, refuses the call. During a call, hangs up.

Direct search mode

Using the remote control, you can jump directly to the desired frequency value of the Radio source by entering the number corresponding to the content.

NOTE

- This operation cannot be performed for the USB device and iPhone.

- Press the [DIRECT] button several times until the desired content appears. The available contents are different depending on the source type.

■ HD Radio tuner

Frequency value/Channel number

■ SiriusXM



Channel number

- Enter the number of the content you want to play using the numeric keypad.

3 Press the |◀◀ or ▶▶| button.

The content corresponding to the number you entered is played.

Caution for button or coin batteries:

	This symbol on the product means there are important operating and maintenance instructions in this manual. Be sure to carefully read instructions in this manual.
	This symbol means that a button cell or coin battery is contained.

⚠ WARNING

- **INGESTION HAZARD:** This product contains a button cell or coin battery.
- **DEATH** or serious injury can occur if ingested.
- A swallowed button cell or coin battery can cause **Internal Chemical Burns** in as little as **2 hours**.
- **KEEP** new and used batteries **OUT OF REACH of CHILDREN**
- **Seek immediate medical attention** if a battery is suspected to be swallowed or inserted inside any part of the body.



- Remove and immediately recycle or dispose of used batteries according to local regulations and keep away from children. Do NOT dispose of batteries in household trash or incinerate.
- Even used batteries may cause severe injury or death.
- Call a local poison control center for treatment information.
- Battery type: CR2025
- Nominal voltage: DC3V
- Non-rechargeable batteries are not to be recharged.
- Do not force discharge, recharge, disassemble, heat above 212°F (100°C) or incinerate. Doing so may result in injury due to venting, leakage or explosion resulting in chemical burns.
- Ensure the batteries are installed correctly according to polarity (+ and -).
- Do not mix old and new batteries, different brands or types of batteries, such as alkaline, carbon-zinc, or rechargeable batteries.
- Remove and immediately recycle or dispose of batteries from equipment not used for an extended period of time according to local regulations.
- Always completely secure the battery compartment. If the battery compartment does not close securely, stop using the product, remove the batteries, and keep them away from children.

Remote control (optional)

KW-Z1001W/KW-Z1000AW

This unit can be operated using the remote control RM-RK259K (optional accessory).

▲ WARNING

- Do not ingest the battery, Chemical Burn Hazard
The remote control supplied with this product contains a coin/button cell battery. If the coin/button cell battery is swallowed, it can cause severe internal burns in just 2 hours and can lead to death.
- Keep new and used batteries away from children. If the battery compartment does not close securely, stop using the product and keep it away from children.
- If you think batteries might have been swallowed or placed inside any part of the body, seek immediate medical attention.

▲ CAUTION

- Risk of fire or explosion if the battery is replaced by an incorrect type. Ensure to replace only with the same type.
- Risk of fire, explosion or the leakage of flammable liquid or gas if the battery is left in an extremely high temperature surrounding environment and/or subjected extremely low air pressure. The battery pack or batteries shall not be exposed to excessive heat such as sunshine, fire or the like.
- Risk of fire, explosion or the leakage of flammable liquid or gas if the battery is disposed into fire or a hot oven, recharged, shorted, mechanically crushed or cut of the battery.
- If spilled fluid comes in contact with your eyes or on clothing, immediately rinse with water and consult a physician.

Battery Installation

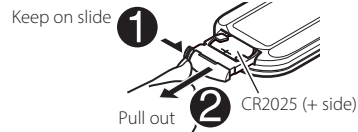

- Use a commercially available button battery (CR2025).
- Insert the battery with the + and – poles aligned properly.
 - If the effectiveness of the remote controller decreases, replace the battery.

Functions of the Remote control Buttons

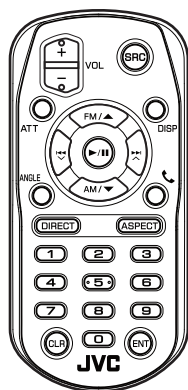

Key Name	Function
SRC	Switches to the source to be played. In Hands-Free mode, hangs up the phone.
VOL + -	Adjusts the volume.
ATT	Lowers the volume when pressed once. Restores the previous volume when pressed twice.
DISP	Switches the screen between the current source and the App screen from the connected iPhone or Android.
FM/▲ AM/▼	Selects the folder to be played. For the HD Radio source, selects FM/AM band to be received. Not used for the SiriusXM source.
◀◀ ◻ ▶▶ ◻	Selects the track or file to be played. For the HD Radio and SiriusXM sources, switches to broadcast stations received by the unit.
▶/	Pauses the track or file, and resumes playing by pressing twice. For the HD Radio sources, switches the seek mode. Not used for the SiriusXM source.
ANGLE	Not used.
☎	When a call comes in, answers the call.
DIRECT	Switches to the direct search mode. For details on the direct search mode, see Direct search mode (P.116) .

Key Name	Function
ASPECT	Changes the aspect ratio. To confirm the current aspect ratio setting, operate on the touch panel. (P.89)
Numeric Keypad	<ul style="list-style-type: none"> Allows you to enter the number to search in the direct search mode. For details on the direct search mode, see Direct search mode (P.116). For the HD Radio and SiriusXM sources, allows you to enter the preset number. <ul style="list-style-type: none"> If the preset number is single digit, press the number. If the preset number is double digits, press continuously the numbers within 3 seconds. Pressing [◀◀] or [▶▶] within 3 seconds allows you to determine the preset number of single digit.
CLR	Not used.
ENT	Not used.

Direct search mode

Using the remote control, you can jump directly to the desired frequency value of the Radio source by entering the number corresponding to the content.

NOTE

- This operation cannot be performed for the USB device and iPhone.

1 Press the [DIRECT] button several times until the desired content appears.

The available contents are different depending on the source type.

■ HD Radio tuner

Frequency value/Channel number

■ SiriusXM



Channel number

2 Enter the number of the content you want to play using the numeric keypad.

3 Press the ◀◀ or ▶▶ button.

The content corresponding to the number you entered is played.

Caution for button or coin batteries:

	<p>This symbol on the product means there are important operating and maintenance instructions in this manual. Be sure to carefully read instructions in this manual.</p>
	<p>This symbol means that a button cell or coin battery is contained.</p>

⚠ WARNING

- **INGESTION HAZARD:** This product contains a button cell or coin battery.
- **DEATH** or serious injury can occur if ingested.
- A swallowed button cell or coin battery can cause **Internal Chemical Burns** in as little as **2 hours**.
- **KEEP** new and used batteries **OUT OF REACH of CHILDREN**
- **Seek immediate medical attention** if a battery is suspected to be swallowed or inserted inside any part of the body.



- Remove and immediately recycle or dispose of used batteries according to local regulations and keep away from children. Do NOT dispose of batteries in household trash or incinerate.
- Even used batteries may cause severe injury or death.
- Call a local poison control center for treatment information.
- Battery type: CR2025
- Nominal voltage: DC3V
- Non-rechargeable batteries are not to be recharged.
- Do not force discharge, recharge, disassemble, heat above 212°F (100°C) or incinerate. Doing so may result in injury due to venting, leakage or explosion resulting in chemical burns.
- Ensure the batteries are installed correctly according to polarity (+ and -).
- Do not mix old and new batteries, different brands or types of batteries, such as alkaline, carbon-zinc, or rechargeable batteries.
- Remove and immediately recycle or dispose of batteries from equipment not used for an extended period of time according to local regulations.
- Always completely secure the battery compartment. If the battery compartment does not close securely, stop using the product, remove the batteries, and keep them away from children.

Connection/Installation

This section is for the professional installer. For safety's sake, leave wiring and mounting to professionals. Consult the car audio dealer.

Before Installation

Before installation of this unit, please note the following precautions.

▲ WARNINGS

- If you connect the ignition wire (red) and the battery wire (yellow) to the car chassis (ground), you may cause a short circuit, that in turn may start a fire. Always connect those wires to the power source running through the fuse box.
- Do not cut out the fuse from the ignition wire (red) and the battery wire (yellow). The power supply must be connected to the wires via the fuse.

▲ CAUTION

- Install this unit in the console of your vehicle.
- Do not touch the metal part of this unit during and shortly after the use of the unit. Metal part such as the heat sink and enclosure become hot.

NOTE

- Mounting and wiring this product requires skills and experience. For best safety, leave the mounting and wiring work to professionals.
- Do not install the unit if it becomes an obstacle to driver performance.
- Adjust the panel position not to become an obstacle to driver performance.
- Make sure to ground the unit to a negative 12V DC power supply.
- Do not install the unit in a spot exposed to direct sunlight or excessive heat or humidity. Also avoid places with too much dust or the possibility of water splashing.
- Do not use your own screws. Use only the screws provided. If you use the wrong screws, you could damage the unit.

- If the power is not turned ON ("There is an error in the speaker wiring. Please check the connections." is displayed), the speaker wire may have a short-circuit or touched the chassis of the vehicle and the protection function may have been activated. Therefore, the speaker wire should be checked.
- If your car's ignition does not have an ACC position, connect the ignition wires to a power source that can be turned on and off with the ignition key. If you connect the ignition wire to a power source with a constant voltage supply, such as with battery wires, the battery may be drained.
- If the console has a lid, the lid will not be closed even when the unit is installed correctly.
- If the fuse blows, first make sure the wires are not touching to cause a short circuit, then replace the old fuse with one with the same rating.
- Insulate unconnected wires with vinyl tape or other similar material. To prevent a short circuit, do not remove the caps on the ends of the unconnected wires or the terminals.
- Connect the speaker wires correctly to the terminals to which they correspond. The unit may be damaged or fail to work if you share the ⊖ wires or ground them to any metal part in the car.
- When only two speakers are being connected to the system, connect the connectors either to both the front output terminals or to both the rear output terminals (do not mix front and rear). For example, if you connect the ⊕ connector of the left speaker to a front output terminal, do not connect the ⊖ connector to a rear output terminal.
- After the unit is installed, check whether the brake lamps, blinkers, wipers, etc. on the car are working properly.
- This unit has the cooling fan to decrease the internal temperature. Do not mount the unit in a place where the cooling fan of the unit is blocked. Blocking these openings will inhibit the cooling of the internal temperature and result in malfunction.

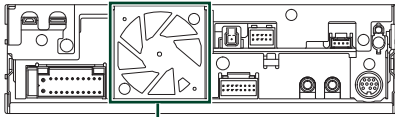

Cooling fan

- Do not press hard on the panel surface when installing the unit to the vehicle. Otherwise scars, damage, or failure may result.
 - Reception may drop if there are metal objects near the Bluetooth/Wi-Fi antenna.
- KW-Z1001W**

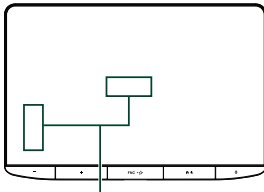

Bluetooth/Wi-Fi antenna unit

KW-Z1000AW/KW-Z800AW

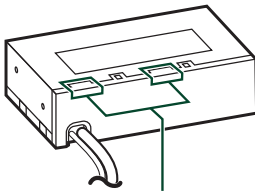

Bluetooth/Wi-Fi antenna unit

● Forward and Lateral Fields of Vision

- To determine driver's forward and lateral fields of vision under normal conditions, place a pole (directly visible from the front or visible through the car rear-view mirror) as shown.

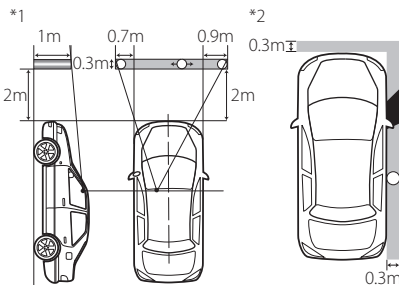









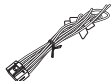
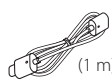

- ○ : Pole (height: 1m, diameter: 0.3m)
- ■ : Field of vision from steering position



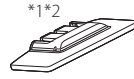

- ■ : Exempted area (pole size is subject to regulation)
- For right hand drive vehicles, standards are reversed.

- *1 The pole must be visible from the driver's position as direct forward field of vision.
- *2 The pole must be directly visible or indirectly visible through the mirror, etc. from the driver's position.

■ Supplied accessories for installation

①	 *1	×1
②	 (1 m)	×1
③	 (3 m)	×1
④	 (M5 x 8 mm) *1	×4
⑤	 (M5 x 8 mm) *1	×4
⑥	 (3.5 m)	×1
⑦		×1
⑧	 *1*2  *3	×1
⑨	 (M4 x 12 mm) *1*2	×4
⑩	 (Ø3 x 6 mm) (Black)	×3 *1*2 ×1 *3

Connection/Installation

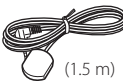
⑪	 (M4 x 8 mm) (Black) *1	x5
⑫	 *1 *2	x1
⑬		x1
⑭		x1
⑮		x1
⑯	 (1.5 m) *3	x1

See **Initial SETUP (P.14)**.

*1 KW-Z1001W only

*2 KW-Z1000AW only

*3 KW-Z800AW only

■ Installation procedure

1. To prevent a short circuit, remove the key from the ignition and disconnect the ⊖ terminal of the battery.
2. Remove the vehicle parts for installing the unit and connecting wires to terminal.
3. Make the proper input and output wire connections for each unit.
4. Connect the speaker wires of the wiring harness.
5. Connect the wiring harness wires in the following order; ground, battery, ignition.
6. Determine the height of the display unit and position of the slider. See **Distance between the display unit and the main unit (P.122)**.
7. Connect the wiring harness connector to the unit.
8. Install the main unit to the vehicle.
9. Reinstall the vehicle parts.
10. Install the display unit.
11. Reconnect the ⊖ terminal of the battery.
12. Perform the Initial Setup.

Installing the accessories

GPS antenna

GPS antenna is installed inside of the car. It should be installed as horizontally as possible to allow easy reception of the GPS satellite signals. To mount the GPS antenna inside your vehicle:

1. Clean your dashboard or other surface.
2. Remove the separator of the metal plate (accessory ⑦).
3. Press the metal plate (accessory ⑦) down firmly on your dashboard or other mounting surface. You can bend the metal plate (accessory ⑦) to conform to a curved surface, if necessary.
4. Remove the separator of the GPS antenna (accessory ⑥), and stick the antenna to the metal plate (accessory ⑦).

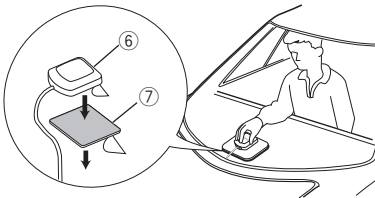

NOTE

- Use the supplied GPS antenna. Using the GPS antenna other than the supplied one may cause a drop in positioning accuracy.
- Depending on the type of car, reception of the GPS satellite signals might not be possible with an inside installation.
- Please install this GPS antenna in an area away from any antennas that are used with CB radios or satellite televisions.
- The GPS antenna should be installed at a position that is spaced at least 12 inch (30 cm) from smartphone/cell-phone or other transmitting antennas. Signals from the GPS satellite may be interfered with by these types of communication.
- Painting the GPS antenna with (metallic) paint may cause a drop in performance.

Microphone unit

1. Check the installation position of the microphone (accessory ③).
2. Clean the installation surface.
3. Remove the separator of the microphone (accessory ③), and stick the microphone to the place shown below.
4. Wire the microphone cable up to the unit with it secured at several positions using tape or other desired method.
5. Adjust the direction of the microphone (accessory ③) to the driver.

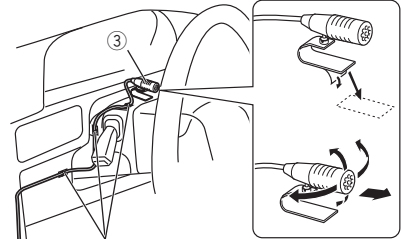

Fix a cable with a commercial item of tape.

Installing the Big Screen model

KW-Z1001W/KW-Z1000AW

Confirm the installing position of the display unit

● Vehicles cannot be installed

It may be possible to install if it can avoid the following by adjustment for slider position and display height.

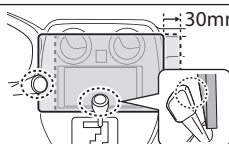
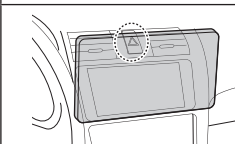
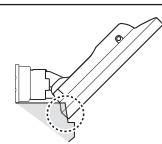
Lever operations are interfered such as shift lever, wiper lever, winker lever when install the unit.	A hazard switch is hidden from a driver seat.	The display unit hits a panel on the vehicle.
		

*1 The Display unit can move 30 mm to the left or right. It can be installed if it doesn't interfere with lever operation when moving.

● Distance between the display unit and the main unit

Adjust slider position and display height so that it does not interfere with display movement.

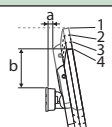
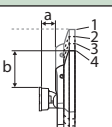
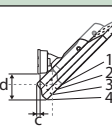
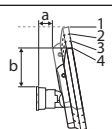
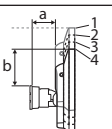
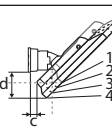
Slider position	Display angle														
	-10°				0°				45°						
Back position		a		b			a		b			c		d	
		1	10.8	126.5	1		30.0	123.6	1	25.6		20.9			
		2	13.4	111.8	2			108.6	2	15.0		31.8			
		3	16.0	97.2	3			93.6	3	4.4		42.1			
4	18.6	82.4	4		78.6	4	-6.2	52.7							
Forward position		a		b			a		b			c		d	
		1	29.8	126.5	1		49.0	123.6	1	44.6		20.9			
		2	32.4	111.8	2			108.6	2	34.0		31.8			
		3	35.0	97.2	3			93.6	3	23.4		42.1			
4	37.6	82.4	4		78.6	4	12.8	52.7							

Unit: mm

● Main unit allowable installation angles

Installed horizontally

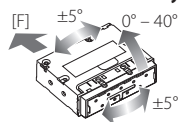

- [F] : Front side of the vehicle
- Pitch : 0° - 40° (horizontally), ±20° (vertically)
- Roll/Yaw : ±5°

Installed vertically

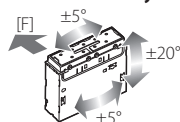

To install with the main unit separated from the display unit

- Depending on how the main unit is oriented, [Installation Orientation] may require configuring. **(P.15)**
- The KS-UA50 extension cable (150 cm / 4.9 ft, sold separately) is required to connect the display unit (accessory ⑧).

Positioning the slider in forward (KW-Z1001W only)

- 1 Remove the two screws from the top of the main unit.

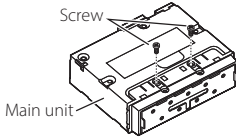

- 2 Remove the four screws from the bottom of the main unit.

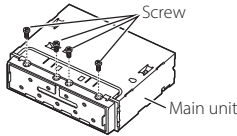

- 3 Pull the slider block forward and reinstall the four screws to the bottom of the main unit.

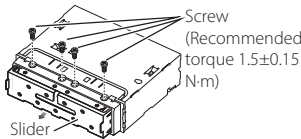

- 4 Reinstall the two screws from the top of the main unit.

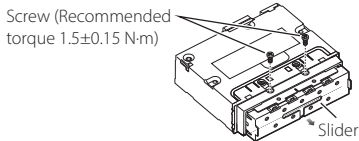

Installing the main unit (KW-Z1001W only)

NOTE

- Determine the slider position before installing the main unit. (P.123) The slider position cannot be changed after installing to the vehicle.
- Make sure that the unit is installed securely in place. If the unit is unstable, it may malfunction.

- 1 Remove parts that interfere with installing such as a panel on the vehicle.

- 2 Install the car bracket to the main unit.

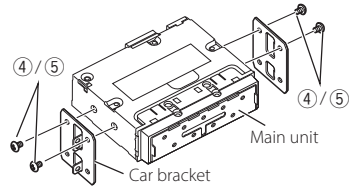

- 3 Connect the wiring harness wires and peripheral equipment.

- 4 Install the main unit to the vehicle.

- 5 Reinstall the removed parts such as a panel on the vehicle.

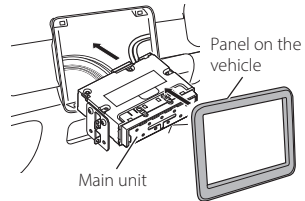

Installing the arm bracket for the display unit

(KW-Z1001W only)

- 1 Match the arm bracket (accessory ⑫) installation position to align with the length of the display cable.

Power cable for Display : about 170 mm (6-11/16")

Video cable for Display : about 160 mm (6-5/16")

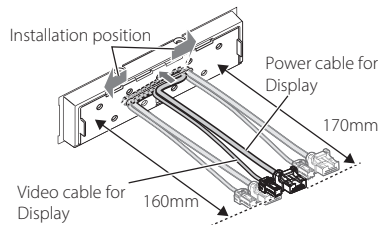

Connection/Installation

2 Positioning the arm bracket (accessory 12).

When installing the arm bracket in the left or right position, move the display cable so that it aligns with the groove in the arm bracket.

Center position

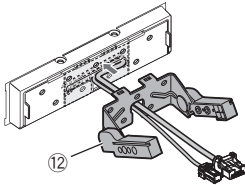

Left position

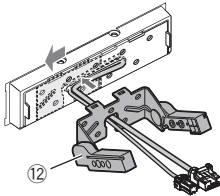

Right position

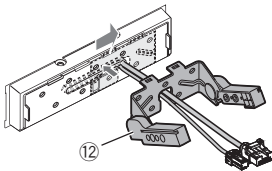

3 Fix the arm bracket (accessory 12) to the main unit with the five binding head screws (accessory 11).

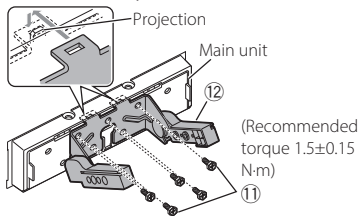

Installing the display unit and adjusting the height

1 Remove the rear cover from the display unit (accessory 8).

Slide the rear cover on the display unit (accessory 8) over and lift it up.

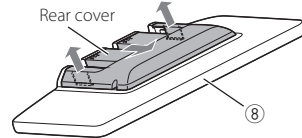

2 Connect the Video cable for Display (1) and Power cable for Display (2).

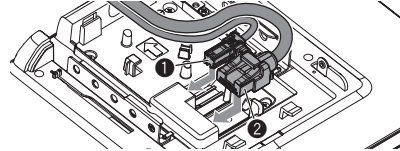

3 Run the display cables.

Use the guides to secure the Video cable for Display (1) in place.

Run the display cables along the interior guide path (between the posts). Install it so that the display unit has room to move. Tuck the remaining display cables inside the main unit.

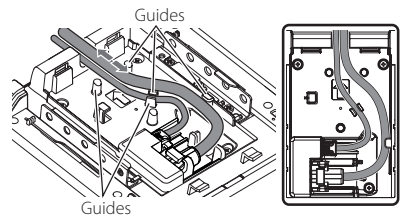

4 Install the display unit (accessory 8) to the main unit.

Install the unit so that the hooks on the display unit (accessory 8) are inserted into the groove on the arm bracket.

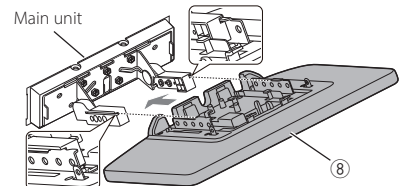

- 5 Adjust the display height according to the screw hole position.**

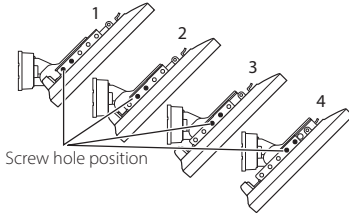

- 6 Fix the display unit with four hexagon head screws (accessory ⑨).**

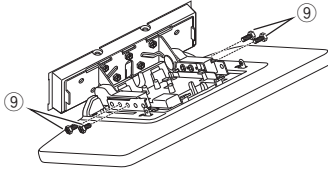

NOTE

- Fix with hexagon head screws correctly. After installing the display unit (accessory ⑧) to the main unit, tilt the display forward until it stops and confirm that the display unit (accessory ⑧) does not hit vehicle parts. If the display unit hits vehicle parts, adjust the display height again.

- 7 Adjust the length of the display cable to align with the height of the display unit.**
Install it so that the display unit has room to move. Tuck the remaining display cable inside the main unit.

- 8 Attach the rear cover of the display unit.**
Insert the hooks on the rear cover into the grooves on the display unit. Slide it along the main unit until you hear a click.

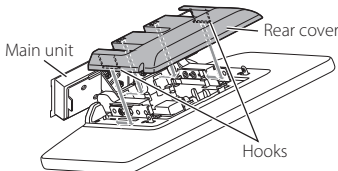

- 9 Fix the display unit cover with two binding head screws (accessory ⑩).**

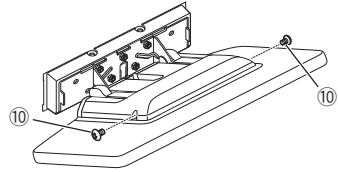

- 10 Raise the display manually.**

Removing the display cable

CAUTION

- To prevent injuries to your hands and damage to the display cable, cover the metal parts with protective tape before working.
- Do not disconnect cables while the unit's power is on. Doing so could cause damage.

- 1 Apply protective tape so that it covers the metal parts in the shaded area in the image.**

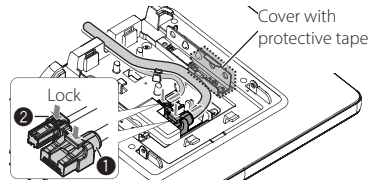

- 2 Press and hold the display cable lock and then remove the cable.**

Disconnect the Power cable for Display (1) and Video cable for Display (2).

Installing the Separate model

KW-Z1000AW/KW-Z800AW

Preparation

- You may need the ADS installation kit to align with the installation vehicle.
Link: <https://www.idatalinkmaestro.com>
- See the instruction manual included with the installation kit for how to install.

NOTE

- Be sure to install using the ADS installation kit. The unit may not operate properly if the installation kit is not used.

Installation overview

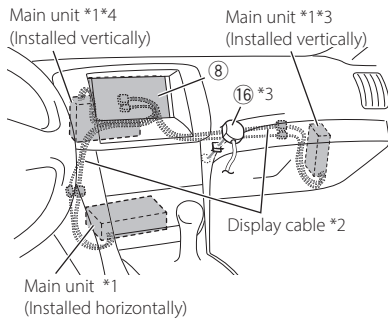

- *1 Depending on how the main unit is oriented, [Installation Orientation] may require configuring. **(P.15)**
- *2 Connect the main unit display cable (65 cm / 2.1 ft.) to the display unit (accessory ⑧). If the display cable does not reach, you will need the extension cable KS-UA50 (150 cm / 4.9 ft, sold separately).
- *3 KW-Z800AW only.
- *4 KW-Z1000AW only.

Installing the remote control sensor (KW-Z800AW only)

- Confirm the installation location for the remote control sensor (accessory ⑩).
- Clean the surface of the installation location.
- Remove the separator on the remote control sensor (accessory ⑩) and attach the light receptor.

- Use tape to secure the remote control sensor cable at several locations and run it to the display unit (accessory ⑧).

NOTE

- Take note of the following precautions when installing the remote control sensor (accessory ⑩).
 - Install in a location that can easily receive the infrared signals from the remote control.
 - Select a location where double-sided tape can be used to secure the sensor.

Main unit allowable installation angles

Installed horizontally

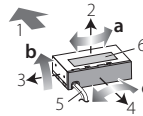

Installed vertically

KW-Z1000AW

KW-Z800AW

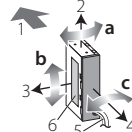
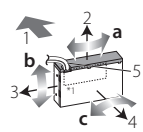

		Installed horizontally	Installed vertically
a	Yaw	±5°	±5°
b	Pitch	0° – 40°	±20°
c	Roll	±5°	±5°
1		Front side of the vehicle	
2		Top side	
3		Left side	
4		Cluster panel side (inside the vehicle interior)	
5		Display cable	
6		Model name plate	

- *1 When installing the KW-Z1000AW, orient the face with the model number towards the front of the vehicle.

Connecting the unit

Connecting wires to terminals

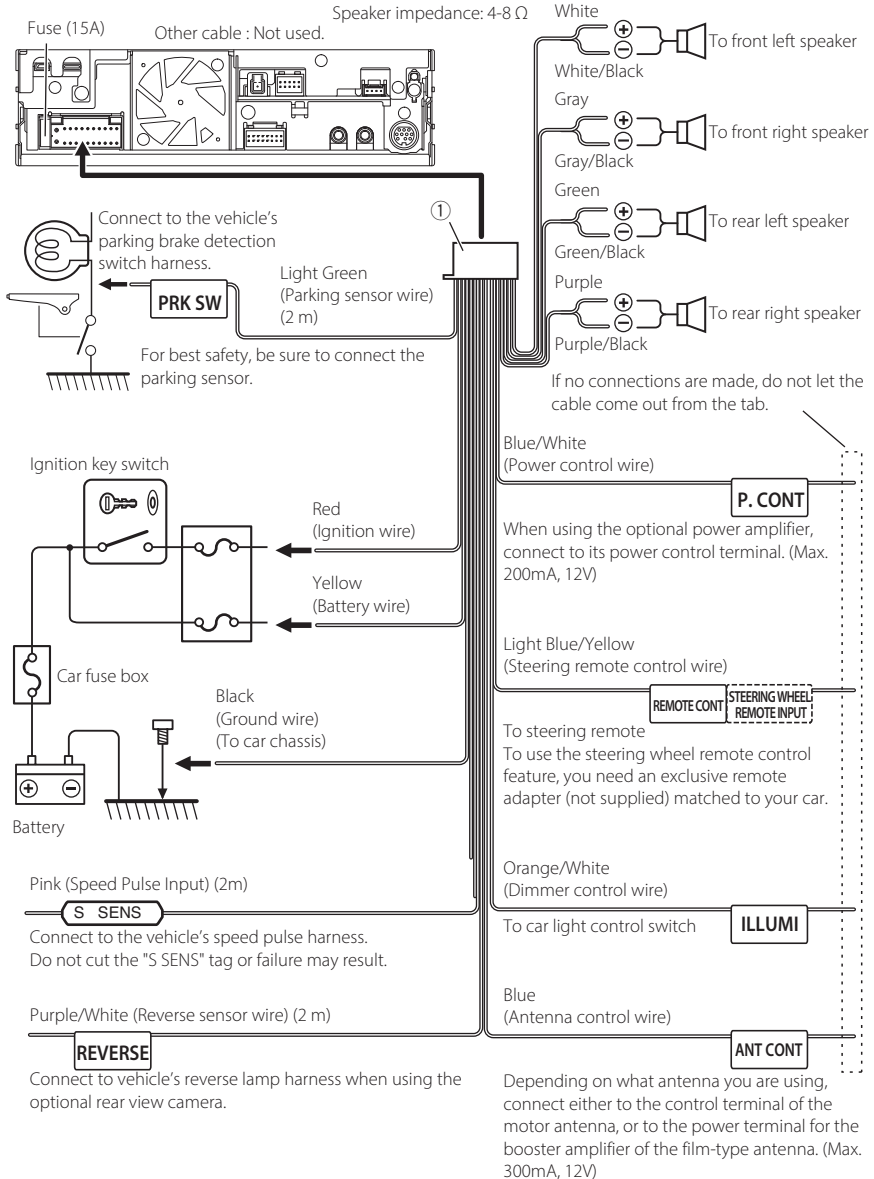

3-way speaker system setup

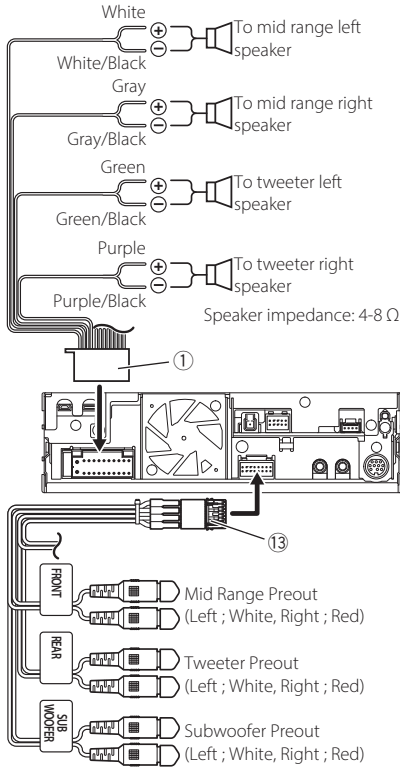

NOTE

- When connecting to an external amplifier, connect its ground wire to the car's chassis to avoid damaging the unit.
- For how to switch to the 3-way speaker system, see [X'over Network] in the System Configuration settings. (P.15)
- For speaker setup and crossover setup, see **Speaker / X'over setup (P.100)**.
- For how to connect speaker wires to terminals other than speaker terminals and Preout terminals, see **Connecting the external amplifiers and external AV device (P.128)** and **Connecting wires to terminals (P.127)**.
- When not using the Preout (RCA terminals), keep the terminal caps on.

Connecting the external amplifiers and external AV device

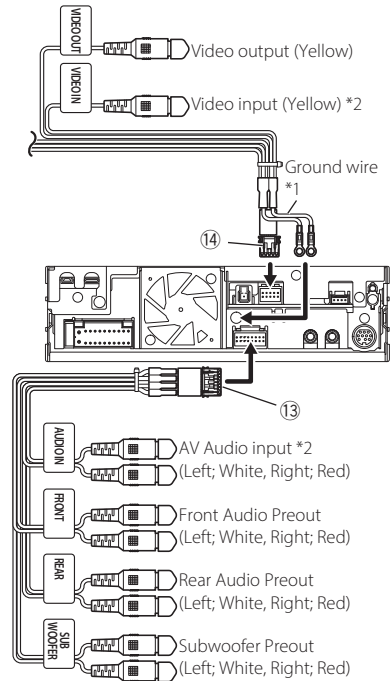

- *1 Secure the two ground wires together to the chassis of the main unit.
- *2 Set "VIDEO IN" to "None" in Camera Assignment Settings. (P.84)

NOTE

- When connecting to an external amplifier, connect its ground wire to the car's chassis to avoid damaging the unit.
- When not using the Preout (RCA terminals), keep the terminal caps on.

Connecting the system and external components

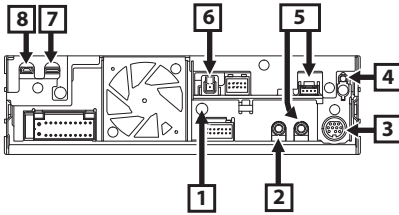

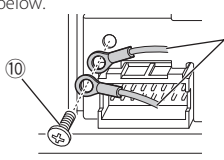
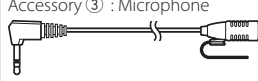
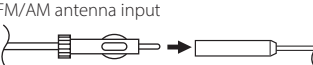
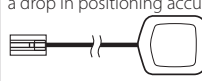
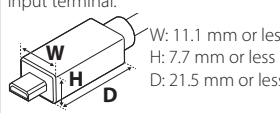
1	Secure both ground wires from accessory 14 together to the chassis as show in the diagram below. 
2	Accessory 3 : Microphone 
3	SiriusXM Connect Vehicle Tuner connector For more information on how to install the SiriusXM Connect Vehicle tuner, consult the installation guide included with the tuner.
4	FM/AM antenna input 
5	iDataLink Maestro connector
6	Accessory 6 : GPS Antenna Use the supplied GPS antenna. Using the GPS antenna other than the supplied one may cause a drop in positioning accuracy. 
7	USB terminal (USB Type-C*)
8	HDMI input (Type-D) Connect a KS-U70 (optional accessory) to HDMI input terminal. 

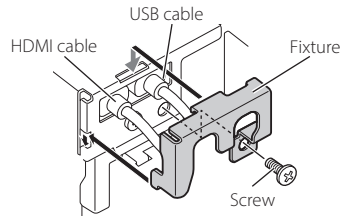

Connecting an iPhone

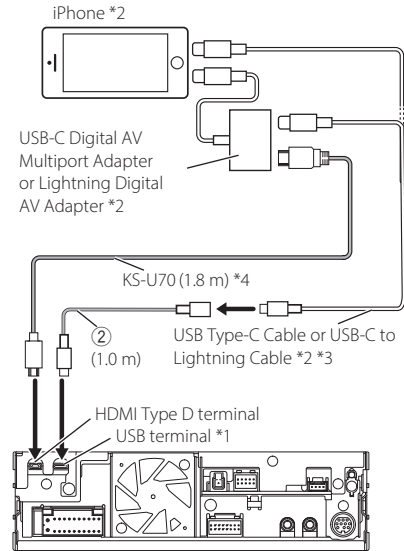

*1 USB maximum power supply current : DC 5 V
= 3.0 A

*2 Sold separately.

*3 Depending on the iPhone connector, use a genuine Apple Lightning-USB cable or a USB-IF certified USB-C® cable.
If you use non-certified cable, it may not work properly.

*4 Optional accessory

Installation/removal of fixing bracket

When you connect the cable to HDMI terminal and USB terminal, remove the fixture. After connecting the cable, put the fixture again.

Connecting an Android™ smartphone

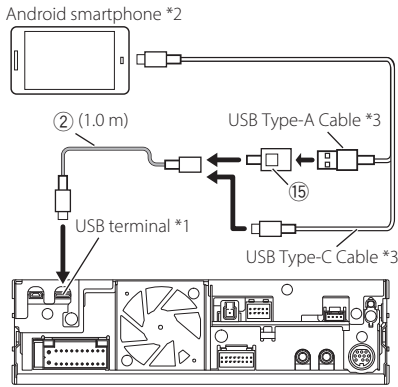

- *1 USB maximum power supply current : DC 5 V
= 3.0 A
- *2 Sold separately.
- *3 Use USB-IF certified USB cable.

Connecting a USB device

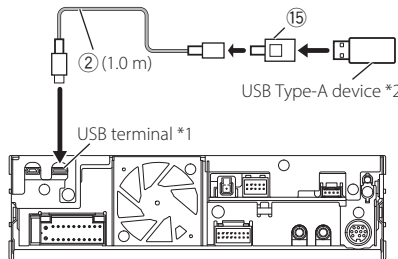

- *1 USB maximum power supply current : DC 5 V
= 3.0 A
- *2 Sold separately.

Connecting the camera

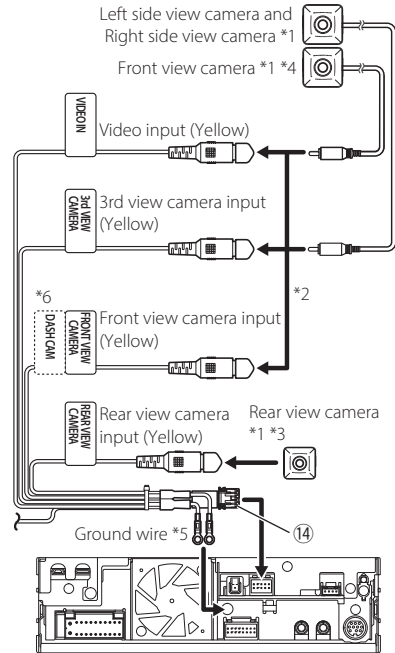

- *1 Sold separately.
- *2 Up to 3 cameras of Front view camera, Left side view camera and Right side view camera can be connected. For more information, see **To set up the camera assignment settings (P.84)**.
- *3 For HD video, connect an HD camera to Rear view camera input terminal.
- *4 For HD video, connect an HD camera to Front view camera input terminal.
- *5 Secure both ground wires to the same terminal.
- *6 Dashboard camera connection is not supported.

Troubleshooting

Problems and Solutions

If any trouble occurs, first check the following table for possible problems.

NOTE

- Some functions of this unit may be disabled by some settings made on this unit.
- What might seem to be a malfunction in your unit may just be the result of slight misoperation or miswiring.

About settings

- **Cannot set up the subwoofer.**
- **Cannot set up subwoofer phase.**
- **No output from the subwoofer.**
- **Cannot set up the low pass filter.**
- **Cannot set up the high pass filter.**

Subwoofer is not set to on.

Set the subwoofer to on. See *Speaker / X'over setup (P.100)*.

About audio operations

Radio reception is poor.

The car antenna is not extended.

Pull out the antenna all the way.

The antenna control wire is not connected.

Connect the wire correctly. See *Connecting the system and external components (P.129)*.

Cannot select a folder.

The random play function is enabled.

Turn off the random function.

The unit does not respond when you try to perform a operation during USB mirroring.

A connector is not properly connected.

Unplug the smartphone from the USB terminal, then reattach the smartphone again.

Others

The Touch Sensor Tone doesn't sound.

The preout jack is being used.

The Touch Sensor Tone cannot be output from the preout jack.

Error Messages

When you fail to operate the unit correctly, the cause of the failure appears as the message on the screen.

There is an error in the speaker wiring. Please check the connections.

Protective circuit has been activated because a speaker cord has shorted or it has come in contact with the car chassis.

Wire or insulate the speaker cord as appropriate and turn the power off and on again.

No Device (USB device)

The USB device is selected as a source although no USB device is connected.

Change the source to any source other than USB/iPhone. Connect a USB device, and change the source to USB again.

Disconnected (iPhone, Bluetooth audio player)

The iPhone/Bluetooth audio player is selected as a source although no iPhone/Bluetooth audio player is connected.

Change the source to any source other than iPhone/Bluetooth. Connect an iPhone/Bluetooth audio player, and change the source to iPhone/Bluetooth again.

No Media file

The connected USB device contains no playable audio file. Media was played that does not have data recorded that the unit can play.

See *Playable Media and Files (P.133)* and try another USB device.

USB device over current status detected.

The connected USB device is rated a current capacity higher than the allowable limit.

Check the USB device. Some trouble may have occurred to the connected USB device.

Change the source to any source other than USB. Remove the USB device.

The speed sense wire is not connected. Please check the connection.

The speed pulse disconnection is detected. By default, it is treated as connected.

To improve precision of a vehicle position recognition, check the connection of the speed pulse.

Troubleshooting

Starting tuner failed.

The tuner unit is not operating correctly due to some reason or other.

Turn the power off and on again. If the “Starting tuner failed.” message does not disappear, contact your nearest JVC dealer.

Audio output has stopped due to an error. please restart the system.

if the problem cannot be resolved, please contact the customer support center.

An error causes audio output to stop.

Reset the system. If resetting the system does not resolve the issue, please contact the customer support center.

SiriusXM

SAT Antenna Error

No antenna is connected to the SXV300 Vehicle Tuner.

Check that an antenna is connected to the SXV300 Vehicle Tuner. Check antenna for damages.

SAT Hardware Error

Either the SXV300 Vehicle Tuner is not connected or has an error.

Verify that the SiriusXM Connect Vehicle Tuner cable is securely connected to the radio.

When the internal temperature of the SXV300 Vehicle Tuner rises too high, the protection circuit is activated and you may not be able to operate the unit.

Use the unit again after reducing the temperature of the SXV300 Vehicle Tuner.

Something went wrong

The Audio signal was not read.

Try another channel.

Channel Not Available

The currently selected channel is unavailable.

Visit www.siriusxm.com for more information about the SiriusXM channel lineup.

No Satellite Signal

No satellite signal was received at startup.

Verify that your vehicle is outdoors with a clear view of the sky.

No Internet Signal

The device did not connect to the internet at startup.

Check whether it is connected to a Wi-Fi network.
(P.50)

Slow Network Connection

The internet connection is slow.

Check the network settings.

Episode Not Available

That episode of the podcast cannot be played.

Visit www.siriusxm.com for more information about the SiriusXM contents lineup.

Station Not Available

That Pandora station is not available.

Visit www.siriusxm.com for more information about the SiriusXM contents lineup.

Apple CarPlay

The GPS antenna must be connected to use Apple CarPlay wirelessly. Please verify the proper connections or plug in by USB to use Apple CarPlay.

The GPS antenna is not connected when the Apple CarPlay is started by connecting wirelessly or when the iPhone compatible with wireless Apple CarPlay is registered in [Device List].

Check the connection of the GPS antenna or plug in over USB to use Apple CarPlay.

Appendix

Playable Media and Files

You can play various kinds of media and files on this unit.

About files

The following audio and video files are supported.

Playable Audio files

	Format	Bit rate	Sampling frequency	Bit count
AAC-LC (.m4a)	MPEG-2/MPEG-4 AAC LC HE-AAC(V1,V2)	8 – 320kbps, VBR	16 – 48 kHz	16 bit
MP3 (.mp3)	MPEG-1/MPEG-2 Audio Layer 3	8 – 320kbps, VBR	16 – 48 kHz	16 bit
WMA (.wma)	Windows Media Audio Standard L3 profile (Version 7,8,9)	8 – 320kbps	16 – 48 kHz	16 bit
Linear PCM (WAVE) (.wav)	RIFF waveform Audio Format	–	16 – 192 kHz	16 bit/24 bit
FLAC (.flac)	flac	–	16 – 192 kHz	16 bit/24 bit
Vorbis (.ogg)	vorbis	–	16 – 48 kHz	16 bit

- WMA and AAC files with DRM cannot be played.
- Although the audio files complies with the standards listed above, they may not be played depending on the types or conditions of media or device.
- This unit supports playback of High-Resolution Audio files.
It is recommended that a car audio system should be configured with all High-Resolution Audio compatible products from player to speaker to enjoy its high quality sound.

Acceptable Video files

	Profile	Max. Picture size	Max. bit rate	Audio format
MPEG-1 (.mpg, .mpeg)	–	352 × 240, 352 × 288	1.5 Mbps	MPEG Audio Layer 2
MPEG-2 (.mpg, .mpeg)	MP@ML	720 × 480, 720 × 576	8 Mbps	MPEG Audio Layer 2
H.264/MPEG-4 AVC (.mp4, .m4v, .avi, .flv, .f4v)	Baseline Profile, Main Profile	1920 × 1080 (30 fps)	8 Mbps	MP3, AAC
MPEG-4 (.mp4, .avi)	Advanced Simple Profile	1920 × 1080 (30 fps)	8 Mbps	MP3, AAC
WMV (.wmv)	Main Profile	1920 × 1080 (30 fps)	8 Mbps	WMA
MKV (.mkv)	Video format follows H.264/MPEG-4 AVC, MPEG-4, WMV			MP3, AAC, WMA, Vorbis, FLAC

Limitation on structure of file and folder

	USB device
Maximum number of folder layers	8
Maximum number of files (per folder)	9999

Appendix

	USB device
Maximum number of folders (per folder)	9999
Maximum number of folders (per device)	Unlimited

- You can enter a folder name and file name with 255 or fewer single-byte characters.
- Files in the folder whose folder name begins with a dot (.) cannot be played.

Specifications

■ Monitor section

Picture Size

KW-Z1001W/KW-Z1000AW
 : 10.1 inches (diagonal) wide
 : 223.7 mm (W) × 125.8 mm (H)
 8-13/16 × 4-15/16 inch
KW-Z800AW
 : 8.0 inches (diagonal) wide
 : 176.64 mm (W) × 99.36 mm (H)
 6-15/16 × 3-15/16 (inch)

Display System

: LCD panel

Drive System

: TFT active matrix system

Number of Pixels

: 2,764,800 (1280H × 720V × RGB)

Effective Pixels

: 99.99 %

Pixel Arrangement

: RGB striped arrangement

Back Lighting

: LED

■ USB interface section

Connector type

: Type-C

USB Standard

: USB 2.0 High Speed

File System

: FAT16, FAT32, exFAT, NTFS

Maximum Power Supply Current

: DC 5 V $\overline{\text{DC}}$ 3.0 A

D/A Converter

: 24 bit / 32 bit

Audio Decoder

: MP3 / WMA / AAC / WAV / FLAC / Vorbis

Video Decoder

: MPEG-1 / MPEG-2 / MPEG-4 / WMV / H.264 / MKV

Frequency Response

• 192 kHz : 20 – 88,000 Hz

- 96 kHz : 20 – 44,000 Hz
- 48 kHz : 20 – 22,000 Hz
- 44.1 kHz : 20 – 20,000 Hz

Total Harmonic Distortion

: 0.01 % (1 kHz)

S/N Ratio (dB)

: 98.5 dB

Dynamic Range

: 89 dB

■ Wireless Mirroring section

Mode

: Sink

Copyright protection

: HDCP2.2

Touch Control

: UIBC

■ Wi-Fi section

IEEE Standard

: 802.11 a/b/g/n/ac

Frequency Range

: Dual Band (2.4GHz/5GHz)

Channels

: Auto (1-11ch) / Auto (149,153,157,161ch)

Transfer rates (MAX)

: 11a: 54 Mbps / 11b: 11 Mbps / 11g: 54 Mbps /
 11n: 300 Mbps / 11ac: 867 Mbps

■ Bluetooth section

Technology

: Bluetooth Ver.5.2

Frequency

: 2.402 – 2.480 GHz

Maximum Communication range

: Line of sight approx. 10m (32.8 ft)

Audio Codec

: SBC/AAC

Profile (Multi Profile support)

- HFP (V1.7) (Hands Free Profile)
- SPP (Serial Port Profile)
- A2DP (Advanced Audio Distribution Profile)
- AVRCP (V1.6) (Audio/Video Remote Control Profile)

Appendix

- PBAP (Phonebook Access Profile)

■ HDMI section

HDMI

: Type-D

Input Resolution

- VGA (640x480p @59.94Hz/60Hz)
- 480p (720x480p @59.94Hz/60Hz)
- 720p (1280x720p @59.94Hz/60Hz)

Input Audio Type

: 32k/44.1k/48k/88.2k/96k/176.2k/192k Hz
16 bit/20 bit/24 bit Linear PCM

■ DSP section

Graphics equalizer

- Band: 13 Band
- Frequency (BAND1 – 13)
: 62.5/100/160/250/400/630/1k/1.6k/2.5k/4k/
6.3k/10k/16k Hz

Gain

: -9/-8/-7/-6/-5/-4/-3/-2/-1/0/1/2/3/4/5/6/7/8/9
dB

2-way X'Over

- High pass filter
 - Frequency: Through,
30/40/50/60/70/80/90/100/120/150/180/2
20/250 Hz
 - Slope: -6/-12/-18/-24 dB/Oct.
- Low pass filter
 - Frequency:
30/40/50/60/70/80/90/100/120/150/180/2
20/250 Hz, Through
 - Slope: -6/-12/-18/-24 dB/Oct.

3-way X'Over

- High pass filter
 - Frequency: 250/300/1k/1.6k/2.5k/4k/5k/
6.3k/8k/10k/12.5k Hz
 - Slope: -12/-18/-24 dB/Oct.
- Band pass filter
 - Frequency:
Through,
50/60/70/80/90/100/120/150/180/220/250
/300 Hz
 - 250/300/1k/1.6k/2.5k/4k/5k/6.3k/8k Hz,
Through
 - Slope: -12/-18/-24 dB/Oct.
- Low pass filter

- Frequency:
30/40/50/60/70/80/90/100/120/150 Hz,
Through
- Slope: -12/-18/-24 dB/Oct.

Position

- Front / Rear /Subwoofer Delay
: 0 – 20.01 ft (0.03 or 0.04 ft Step)
- Gain
: -8 – 0 dB

Subwoofer level

: -50 – +10 dB

■ Digital FM tuner section

Frequency Range (step)

: 87.9 MHz – 107.9 MHz (200 kHz)

Frequency Response (± 3.0 dB)

: 20 Hz – 20 kHz

S/N Ratio

: 80 dB (STEREO)

■ Digital AM tuner section

Frequency Range (step)

: 530 kHz – 1700 kHz (10 kHz)

Frequency Response (± 3.0 dB)

: 40 Hz – 15 kHz

S/N Ratio (dB)

: 80 dB (STEREO)

■ FM tuner section

Frequency Range (step)

: 87.9 MHz - 107.9 MHz (200 kHz)

Usable Sensitivity (S/N : 30 dB)

: 7.3 dBf (0.7 μV/75 Ω)

Frequency Response

: 30 Hz – 15 kHz

S/N Ratio (dB)

: 70 dB (MONO)

Selectivity (± 400 kHz)

: 80 dB

Stereo Separation

: 45 dB (1 kHz)

■ AM tuner section

Frequency Range (step)

: 530 kHz - 1700 kHz (10 kHz)

Usable Sensitivity: 30dB μ **■ Video section****Color System of External Video Input**

: NTSC/PAL

External video input level (RCA jacks): 1 V_{p-p}/75 k Ω **Video Input Level (RCA jacks)**: 1 V_{p-p}/75 Ω **Video Output Level (RCA jacks)**: 1 V_{p-p}/75 Ω **■ Audio section****Maximum Power (Front & Rear)**: 50 W \times 4**Typical Power Output (Front & Rear)**: 29 W \times 4 (4 Ω , 1 kHz, 10% THD)**Output frequency band**

: 20 – 88,000 Hz

Preout Level (V): 4 V / 10 k Ω **Preout Impedance**: \leq 300 Ω **Speaker Impedance**: 4 – 8 Ω **External Audio Max Input Level (RCA jacks)**: 2 V / 22 k Ω **■ General****Operating Voltage**

: 12 V DC car battery

Dimensions (W \times H \times D)

- Chassis
KW-Z1001W
 : 178 \times 50 \times 158 mm
 7 \times 2 \times 6-1/4 inch
KW-Z1000AW/KW-Z800AW
 : 178 \times 50 \times 105 mm
 7 \times 2 \times 4-1/8 inch
- Monitor
KW-Z1001W/KW-Z1000AW
 : 262 \times 181 \times 52 mm
 10-5/16 \times 7-1/8 \times 2-1/16 inch
KW-Z800AW
 : 190 \times 120 \times 28 mm

7-1/2 \times 4-3/4 \times 1-1/8 inch**Weight***KW-Z1001W*

: 2.5 kg (5.6 lbs)

KW-Z1000AW

: 2.1 kg (4.5 lbs)

KW-Z800AW

: 1.4 kg (3.1 lbs)

- Chassis
KW-Z1001W
 : 1.3 kg (2.9 lbs)
KW-Z1000AW/KW-Z800AW
 : 0.8 kg (1.8 lbs)
- Monitor
KW-Z1001W/KW-Z1000AW
 : 1.1 kg (2.4 lbs)
KW-Z800AW
 : 0.6 kg (1.3 lbs)

NOTE

- Although the effective pixels for the liquid crystal panel is given as 99.99% or more, 0.01% of pixels may not light or may light incorrectly.

Specifications are subject to change without prior notice.

About this Unit

Trademarks and licenses

- The Bluetooth® word mark and logos are registered trademarks owned by Bluetooth SIG, Inc. and any use of such marks by JVCKENWOOD Corporation is under license. Other trademarks and trade names are those of their respective owners.
- Windows Media is a registered trademark or trademark of Microsoft Corporation in the United States and/or other countries. This product is protected by certain intellectual property rights of Microsoft. Use or distribution of such technology outside of this product is prohibited without a license from Microsoft.
- This software is based in part on the work of the independent JPEG Group.
- Use of the Made for Apple badge means that an accessory has been designed to connect specifically to the Apple product(s) identified in the badge, and has been certified by the developer to meet Apple performance standards. Apple is not responsible for the operation of this device or its compliance with safety and regulatory standards. Please note that the use of this accessory with an Apple product may affect wireless performance.
- Apple, Apple CarPlay, Apple Music, iPhone, Lightning, and Siri are trademarks of Apple Inc., registered in the U.S. and other countries and regions.
- Use of the Apple CarPlay logo means that a vehicle user interface meets Apple performance standards. Apple is not responsible for the operation of this vehicle or its compliance with safety and regulatory standards. Please note that the use of this product with iPhone, iPod, or iPad may affect wireless performance.
- App Store is a service mark of Apple Inc., registered in the U.S. and other countries.
- IOS is a trademark or registered trademark of Cisco in the U.S. and other countries and is used under license.
- SiriusXM and all related marks and logos are trademarks of Sirius XM Radio, Inc. All rights reserved.
- HD Radio Technology manufactured under license from iBiquity Digital Corporation. U.S. and Foreign Patents. For patents see <https://dts.com/patents>. HD Radio and the HD, HD Radio, and "ARC" logos are registered trademarks or trademarks of iBiquity Digital Corporation in the United States and/or other countries.
- Google, Android, Android Auto, Google Play and other marks are trademarks of Google LLC. Wireless use of Android Auto requires a compatible Android 11.0+ phone and compatible active data plan. Check g.co/androidauto/requirements for compatibility.
- Wi-Fi® is a registered trademark of Wi-Fi Alliance®.
- The Wi-Fi CERTIFIED™ Logo is a certification mark of Wi-Fi Alliance®.
- USB Type-C® and USB-C® are registered trademarks of USB Implementers Forum.
- The terms HDMI and HDMI High-Definition Multimedia Interface, and the HDMI Logo are trademarks or registered trademarks of HDMI Licensing Administrator, Inc. in the United States and other countries.
- This product includes FontAvenue® fonts licenced by NEC Corporation. FontAvenue is a registered trademark of NEC Corporation.
 
- This product includes "Ubiquitous QuickBoot™" technology developed by Ubiquitous AI Corporation. Ubiquitous QuickBoot™ is a trademark of Ubiquitous AI Corporation. Copyright© 2025 Ubiquitous AI Corporation All rights reserved.
 
- THIS PRODUCT IS LICENSED UNDER THE AVC PATENT PORTFOLIO LICENSE FOR THE PERSONAL USE OF A CONSUMER OR OTHER USES IN WHICH IT DOES NOT RECEIVE REMUNERATION TO (i) ENCODE VIDEO IN COMPLIANCE WITH THE AVC STANDARD ("AVC VIDEO") AND/OR (ii) DECODE AVC VIDEO THAT WAS ENCODED BY A

CONSUMER ENGAGED IN A PERSONAL ACTIVITY AND/OR WAS OBTAINED FROM A VIDEO PROVIDER LICENSED TO PROVIDE AVC VIDEO. NO LICENSE IS GRANTED OR SHALL BE IMPLIED FOR ANY OTHER USE. ADDITIONAL INFORMATION MAY BE OBTAINED FROM MPEG LA, L.L.C. SEE HTTP://WWW.MPEGLA.COM

- THIS PRODUCT IS LICENSED UNDER THE VC-1 PATENT PORTFOLIO LICENSE FOR THE PERSONAL AND NON-COMMERCIAL USE OF A CONSUMER TO (i) ENCODE VIDEO IN COMPLIANCE WITH THE VC-1 STANDARD ("VC-1 VIDEO") AND/OR (ii) DECODE VC-1 VIDEO THAT WAS ENCODED BY A CONSUMER ENGAGED IN A PERSONAL AND NON-COMMERCIAL ACTIVITY AND/OR WAS OBTAINED FROM A VIDEO PROVIDER LICENSED TO PROVIDE VC-1 VIDEO. NO LICENSE IS GRANTED OR SHALL BE IMPLIED FOR ANY OTHER USE. ADDITIONAL INFORMATION MAY BE OBTAINED FROM MPEG LA, L.L.C. SEE HTTP://WWW.MPEGLA.COM

- libFLAC

Copyright (C) 2000-2009 Josh Coalson
Copyright (C) 2011-2013 Xiph.Org Foundation

Redistribution and use in source and binary forms, with or without modification, are permitted provided that the following conditions are met:

- Redistributions of source code must retain the above copyright notice, this list of conditions and the following disclaimer.
- Redistributions in binary form must reproduce the above copyright notice, this list of conditions and the following disclaimer in the documentation and/or other materials provided with the distribution.
- Neither the name of the Xiph.org Foundation nor the names of its contributors may be used to endorse or promote products derived from this software without specific prior written permission.

THIS SOFTWARE IS PROVIDED BY THE COPYRIGHT HOLDERS AND CONTRIBUTORS "AS IS" AND ANY EXPRESS OR IMPLIED WARRANTIES, INCLUDING, BUT NOT LIMITED TO, THE IMPLIED WARRANTIES OF MERCHANTABILITY AND FITNESS FOR A PARTICULAR PURPOSE ARE DISCLAIMED. IN NO EVENT SHALL THE FOUNDATION OR CONTRIBUTORS BE LIABLE FOR ANY DIRECT, INDIRECT, INCIDENTAL, SPECIAL, EXEMPLARY, OR CONSEQUENTIAL DAMAGES (INCLUDING, BUT NOT LIMITED TO, PROCUREMENT OF SUBSTITUTE GOODS OR SERVICES; LOSS OF USE, DATA, OR PROFITS; OR BUSINESS INTERRUPTION) HOWEVER CAUSED AND ON ANY THEORY OF LIABILITY, WHETHER IN CONTRACT, STRICT LIABILITY, OR TORT (INCLUDING NEGLIGENCE OR OTHERWISE) ARISING IN ANY WAY OUT OF THE USE OF THIS SOFTWARE, EVEN IF ADVISED OF THE POSSIBILITY OF SUCH DAMAGE.

- libvorbis

Copyright (c) 2002-2008 Xiph.org Foundation
Redistribution and use in source and binary forms, with or without modification, are permitted provided that the following conditions are met:

- Redistributions of source code must retain the above copyright notice, this list of conditions and the following disclaimer.
- Redistributions in binary form must reproduce the above copyright notice, this list of conditions and the following disclaimer in the documentation and/or other materials provided with the distribution.
- Neither the name of the Xiph.org Foundation nor the names of its contributors may be used to endorse or promote products derived from this software without specific prior written permission.

THIS SOFTWARE IS PROVIDED BY THE COPYRIGHT HOLDERS AND CONTRIBUTORS "AS IS" AND ANY EXPRESS OR IMPLIED WARRANTIES, INCLUDING, BUT NOT LIMITED TO, THE IMPLIED WARRANTIES OF MERCHANTABILITY AND FITNESS FOR A PARTICULAR PURPOSE ARE DISCLAIMED. IN NO EVENT SHALL THE FOUNDATION OR CONTRIBUTORS BE LIABLE FOR ANY DIRECT, INDIRECT, INCIDENTAL, SPECIAL,

Appendix

EXEMPLARY, OR CONSEQUENTIAL DAMAGES (INCLUDING, BUT NOT LIMITED TO, PROCUREMENT OF SUBSTITUTE GOODS OR SERVICES; LOSS OF USE, DATA, OR PROFITS; OR BUSINESS INTERRUPTION) HOWEVER CAUSED AND ON ANY THEORY OF LIABILITY, WHETHER IN CONTRACT, STRICT LIABILITY, OR TORT (INCLUDING NEGLIGENCE OR OTHERWISE) ARISING IN ANY WAY OUT OF THE USE OF THIS SOFTWARE, EVEN IF ADVISED OF THE POSSIBILITY OF SUCH DAMAGE.

- libogg

Copyright (c) 2002, Xiph.org Foundation
Redistribution and use in source and binary forms, with or without modification, are permitted provided that the following conditions are met:

- Redistributions of source code must retain the above copyright notice, this list of conditions and the following disclaimer.
- Redistributions in binary form must reproduce the above copyright notice, this list of conditions and the following disclaimer in the documentation and/or other materials provided with the distribution.
- Neither the name of the Xiph.org Foundation nor the names of its contributors may be used to endorse or promote products derived from this software without specific prior written permission.

THIS SOFTWARE IS PROVIDED BY THE COPYRIGHT HOLDERS AND CONTRIBUTORS ``AS IS'' AND ANY EXPRESS OR IMPLIED WARRANTIES, INCLUDING, BUT NOT LIMITED TO, THE IMPLIED WARRANTIES OF MERCHANTABILITY AND FITNESS FOR A PARTICULAR PURPOSE ARE DISCLAIMED. IN NO EVENT SHALL THE FOUNDATION OR CONTRIBUTORS BE LIABLE FOR ANY DIRECT, INDIRECT, INCIDENTAL, SPECIAL, EXEMPLARY, OR CONSEQUENTIAL DAMAGES (INCLUDING, BUT NOT LIMITED TO, PROCUREMENT OF SUBSTITUTE GOODS OR SERVICES; LOSS OF USE, DATA, OR PROFITS;

OR BUSINESS INTERRUPTION) HOWEVER CAUSED AND ON ANY THEORY OF LIABILITY, WHETHER IN CONTRACT, STRICT LIABILITY, OR TORT (INCLUDING NEGLIGENCE OR OTHERWISE) ARISING IN ANY WAY OUT OF THE USE OF THIS SOFTWARE, EVEN IF ADVISED OF THE POSSIBILITY OF SUCH DAMAGE.

Safety Information

■ FCC CAUTION

Changes or modifications not expressly approved by the party responsible for compliance could void the user's authority to operate the equipment.

NOTE

- This equipment has been tested and found to comply with the limits for a Class B digital device, pursuant to part 15 of the FCC Rules. These limits are designed to provide reasonable protection against harmful interference in a residential installation.
- This equipment generates, uses and can radiate radio frequency energy and, if not installed and used in accordance with the instructions, may cause harmful interference to radio communications. However, there is no guarantee that interference will not occur in a particular installation. If this equipment does cause harmful interference to radio or television reception, which can be determined by turning the equipment off and on, the user is encouraged to try to correct the interference by one or more of the following measures:
 - Reorient or relocate the receiving antenna.
 - Increase the separation between the equipment and receiver.
 - Connect the equipment into an outlet on a circuit different from that to which the receiver is connected.
 - Consult the dealer or an experienced radio/TV technician for help.

This transmitter must not be co-located or operated in conjunction with any other antenna or transmitter.

■ ISED CAUTION

This device contains licence-exempt transmitter(s)/receiver(s) that comply with Innovation, Science and Economic Development Canada's licence-exempt RSS(s). Operation is subject to the following two conditions:

1. This device may not cause interference.
2. This device must accept any interference, including interference that may cause undesired operation of the device.

CAUTION

This equipment complies with FCC/ISED radiation exposure limits set forth for an uncontrolled environment and meets the FCC radio frequency (RF) Exposure Guidelines and RSS-102 of the ISED radio frequency (RF) Exposure rules. This equipment should be installed and operated keeping the radiator at least 20cm or more away from person's body.

Supplier's Declaration of Conformity

Trade Name: JVC
 Products: MONITOR WITH RECEIVER
 Model Name: KW-Z1001W/KW-Z1000AW/KW-Z800AW
 Responsible Party: JVCKENWOOD USA CORPORATION
 4001 Worsham Avenue, Long Beach, CA 90808, U.S.A.
 PHONE : 1-800-252-5722

THIS DEVICE COMPLIES WITH PART 15 OF THE FCC RULES. OPERATION IS SUBJECT TO THE FOLLOWING TWO CONDITIONS:

1. THIS DEVICE MAY NOT CAUSE HARMFUL INTERFERENCE, AND
2. THIS DEVICE MUST ACCEPT ANY INTERFERENCE RECEIVED, INCLUDING INTERFERENCE THAT MAY CAUSE UNDESIRE OPERATION.

■ CALIFORNIA, USA

This product contains a CR Coin Cell Lithium Battery which contains Perchlorate Material – special handling may apply.
 See www.dtsc.ca.gov/hazardouswaste/perchlorate.

- Información acerca de la eliminación de equipos eléctricos y electrónicos al final de la vida útil (aplicable a los países que hayan adoptado sistemas independientes de recogida de residuos)



Los productos con el símbolo de un contenedor con ruedas tachado no podrán ser desechados como residuos domésticos.

Appendix

Los equipos eléctricos y electrónicos al final de la vida útil, deberán ser reciclados en instalaciones que puedan dar el tratamiento adecuado a estos productos y a sus subproductos residuales correspondientes. Póngase en contacto con su administración local para obtener información sobre el punto de recogida más cercano. Un tratamiento correcto del reciclaje y la eliminación de residuos ayuda a conservar los recursos y evita al mismo tiempo efectos perjudiciales en la salud y el medio ambiente.

■ Informação sobre a eliminação de pilhas

Este produto não deve ser eliminado como lixo doméstico geral. Devolva a pilha usada ao revendedor ou entidade autorizada para que a mesma seja devolvida ao fabricante ou importador.

A reciclagem e a eliminação de lixo de maneira apropriada ajudarão a conservar os recursos naturais ao mesmo tempo que prevenirão os efeitos prejudiciais à nossa saúde e ao meio ambiente.

■ Para cumplimiento de la IFT:

La operación de este equipo esta sujeta a las siguientes dos condiciones:

- (1) es posible que este equipo o dispositivo no cause interferencia perjudicial y
- (2) este equipo o dispositivo debe aceptar cualquier interferencia, incluyendo la que pueda causar su operación no deseada.

JVC