

ZEBRA TECHNOLOGIES CORP

WIFI MODULE

MODEL: ZCOMAX XG-182Z 802.11 B/G RADIO

Jun 13 2011

Report No.: SL11050402-ZBR-029

(This report supersedes: None)

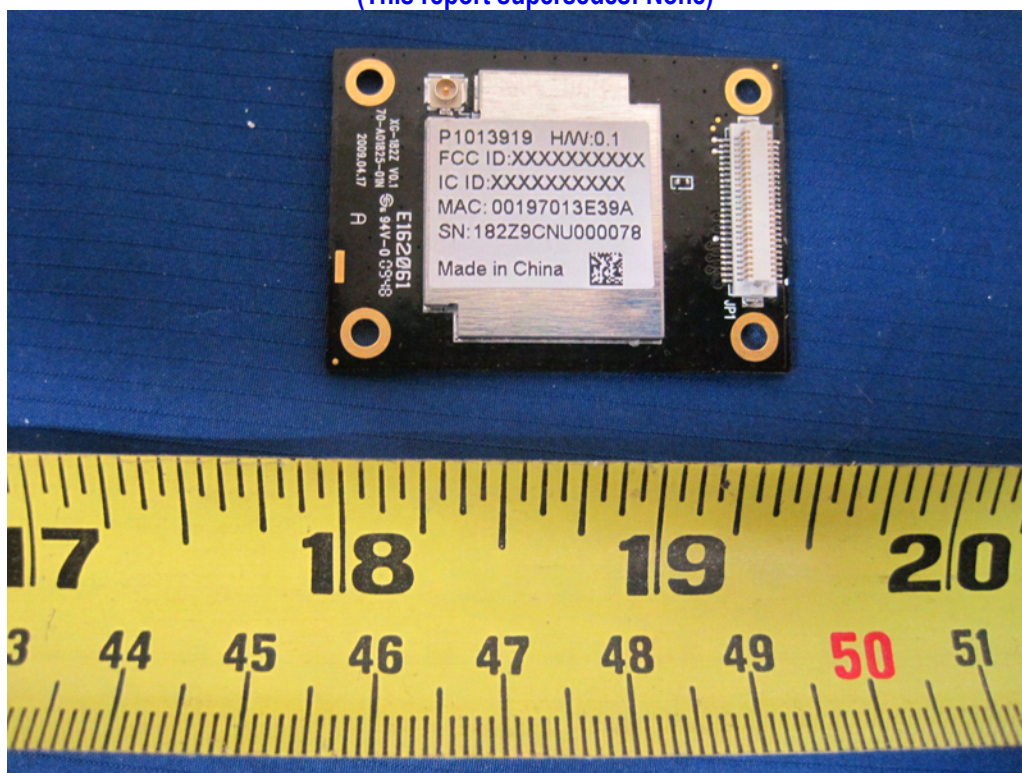

RF Test Report

To: PCII FCC Part 15.247: 2010 & RSS 210 Issue 8: 2010

SIEMIC, INC.
Accessing global markets



Modifications made to the product : None

This Test Report is Issued Under the Authority of:

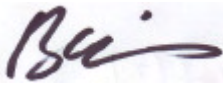
	
Choon Sian Ooi Compliance Engineer	Leslie Bai Director of Certification

This test report may be reproduced in full only.
All Test Data Presented in this report is only applicable to presented Test sample.

Laboratory Introduction

SIEMIC, headquartered in the heart of Silicon Valley, with superior facilities in US and Asia, is one of the leading independent testing and certification facilities providing customers with one-stop shop services for Compliance Testing and Global Certifications.



In addition to [testing](#) and [certification](#), SIEMIC provides initial design reviews and [compliance management](#) through out a project. Our extensive experience with [China](#), [Asia Pacific](#), [North America](#), [European](#), and [international](#) compliance requirements, assures the fastest, most cost effective way to attain regulatory compliance for the [global markets](#).

Accreditations for Conformity Assessment

Country/Region	Accreditation Body	Scope
USA	FCC, A2LA	EMC , RF/Wireless , Telecom
Canada	IC, A2LA, NIST	EMC, RF/Wireless , Telecom
Taiwan	BSMI , NCC , NIST	EMC, RF, Telecom , Safety
Hong Kong	OFTA , NIST	RF/Wireless , Telecom
Australia	NATA, NIST	EMC, RF, Telecom , Safety
Korea	KCC/RRA, NIST	EMI, EMS, RF , Telecom, Safety
Japan	VCCI, JATE, TELEC, RFT	EMI, RF/Wireless, Telecom
Mexico	NOM, COFETEL, Caniety	Safety, EMC , RF/Wireless, Telecom
Europe	A2LA, NIST	EMC, RF, Telecom , Safety

Accreditations for Product Certifications

Country	Accreditation Body	Scope
USA	FCC TCB, NIST	EMC , RF , Telecom
Canada	IC FCB , NIST	EMC , RF , Telecom
Singapore	iDA, NIST	EMC , RF , Telecom
EU	NB, NIST	EMC,RF,Safety,Telecom



SIEMIC, INC.

Accessing global markets

Title: RF Test Report of Zebra Technologies Corp
Model : ZComax XG-182Z 802.11 b/g radio
To FCC 15.247:2010 & RSS-210 Issue8 : 2010

Serial# SL11050402-ZBR-029
Issue Date Jun 13 2011
Page 3 of 61
www.siemic.com

This page has been left blank intentionally.



SIEMIC, Inc.

Accessing global markets

Title: RF Test Report of Zebra Technologies Corp
Model : ZComax XG-182Z 802.11 b/g radio
To FCC 15.247:2010 & RSS-210 Issue8 : 2010

Serial# SL11050402-ZBR-029
Issue Date Jun 13 2011
Page 4 of 61
www.siemic.com

CONTENTS

1	EXECUTIVE SUMMARY & EUT INFORMATION.....	6
2	TECHNICAL DETAILS	7
3	MODIFICATION	8
4	TEST SUMMARY	9
5	MEASUREMENTS, EXAMINATION AND DERIVED RESULTS	10
	ANNEX A. TEST INSTRUMENT & METHOD	29
	ANNEX B EUT AND TEST SETUP PHOTOGRAPHS.....	33
	ANNEX C. TEST SETUP AND SUPPORTING EQUIPMENT	33
	ANNEX D USER MANUAL, BLOCK DIAGRAM, CIRCUIT DIAGRAM.....	37
	ANNEX E SIEMIC ACCREDITATION	38



SIEMIC, INC.

Accessing global markets

Title: RF Test Report of Zebra Technologies Corp
Model : ZComax XG-182Z 802.11 b/g radio
To FCC 15.247:2010 & RSS-210 Issue8 : 2010

Serial# SL11050402-ZBR-029
Issue Date Jun 13 2011
Page 5 of 61
www.siemic.com

This page has been left blank intentionally.

1 Executive Summary & EUT information

The purpose of this test programmed was to demonstrate compliance of the Zebra Technologies Corp , Zebra WLAN radio , Model: ZComax XG-182Z 802.11 b/g radio with host (GX430t, GX420t and GX420d) (with cost reduction printer head and cutter, Updated board to support radio SDIO interface) against the current Stipulated Standards. The WIFI Module have demonstrated compliance with the PCII FCC 15.247:2010 & RSS-210 Issue8 : 2010.

EUT Information

- EUT Description** : Zebra Technologies will only use the ZComax XG-182Z 802.11 b/g radio radio within Zebra Host Printer, primarily Printer (GX420t, GX430t and GX420d). Both the radio and the antenna will be mounted inside the product and will not be user accessible. 802.11b/g radios are designed to operate in the international ISM Band from 2.412 to 2.462 GHz.
- Model No** : ZComax XG-182Z 802.11 b/g radio
- Serial No** : Host : 31J111000266, 32J111000532, 30J111200002
- Input Power** : 3.3VDC, 470mA
- Classification Per Stipulated Test Standard** : Spread Spectrum System / Device



2 TECHNICAL DETAILS

Purpose	Compliance testing of WIFI Module model ZComax XG-182Z 802.11 b/g radio with stipulated standard
Applicant / Client	Zebra Technologies Corp
Manufacturer	Zebra Technologies Corp 333 Corporate Woods Parkway. Vernon Hills, IL 60061
Laboratory performing the tests	SIEMIC Laboratories
Test report reference number	SL11050402-ZBR-029
Date EUT received	May 15th 2011
Standard applied	See Page 9
Dates of test (from – to)	26 May 2011 ~ Jun 8 2011
No of Units:	3
Equipment Category:	DTS
Trade Name:	Zebra Technologies Corp
Model Name:	ZComax XG-182Z 802.11 b/g radio
RF Operating Frequency (ies)	802.11b/g:2412MHz – 2462MHz;
Number of Channels:	802.11b/g : 11Ch;
Modulation:	802.11b/g DSSS; OFDM
FCC ID:	I28MD-CXLAN11G
IC ID:	3798B-CXLAN11G



SIEMIC, Inc.

Accessing global markets

Title: RF Test Report of Zebra Technologies Corp
Model : ZComax XG-182Z 802.11 b/g radio
To FCC 15.247:2010 & RSS-210 Issue8 : 2010

Serial# SL11050402-ZBR-029
Issue Date Jun 13 2011
Page 8 of 61
www.siemic.com

3 MODIFICATION

NONE

4 TEST SUMMARY

The product was tested in accordance with the following specifications. All testing has been performed according to below product classification:

Spread Spectrum System / Device

Test Results Summary

Test Standard		Description	Pass / Fail
CFR 47 Part 15.247: 2010	RSS 210 Issue 8: 2010		
15.203		Antenna Requirement	Pass
15.205	RSS210(A8.5)	Restricted Band of Operation	Pass
15.247(a)(1)	RSS210(A8.1)	Channel Separation	N/A
15.247(a)(1)	RSS210(A8.1)	Occupied Bandwidth	Pass (Original)
15.247(a)(2)	RSS210 (A8.2)	6 dB Bandwidth	Pass (Original)
15.247(a)(1)	RSS210(A8.1)	Number of Hopping Channels	N/A
15.247(a)(1)	RSS210(A8.1)	Time of Occupancy	N/A
15.247(b)	RSS210(A8.4)	Output Power	Pass (Original)
15.247(c)	RSS210(A8.4)	Antenna Gain > 6 dBi	N/A
15.247(d)	RSS210(A8.5)	Conducted Spurious Emissions	Pass (Original)
15.209; 15.247(d)	RSS210(A8.5)	Radiated Spurious Emissions	Pass
15.247(e)	RSS210(A8.3)	Power Spectral Density	Pass (Original)
15.247(f)	RSS210(A8.3)	Hybrid System Requirement	N/A
15.247(g)	RSS210(A8.1)	Hopping Capability	N/A
15.247(h)	RSS210(A8.1)	Hopping Coordination Requirement	N/A
15.247(i)	RSSGen(5.5)	RF Exposure requirement	Pass
ANSI C63.4: 2003/ RSS-Gen Issue 3: 2010			
PS: All measurement uncertainties are not taken into consideration for all presented test result.			

Note: EUT supports different data rates and multiple channels, only the worse case test result with maximum data rates at Low, Mid, High channels are presented in this report. The data rates during testing are : 11Mbps (802.11b), 54Mbps (802.11g).

5 MEASUREMENTS, EXAMINATION AND DERIVED RESULTS

5.1 Antenna Requirement

Requirement(s): 47 CFR §15.203

An intentional radiator shall be designed to ensure that no antenna other than that furnished by the responsible party shall be used with the device.

Antenna requirement must meet at least one of the following:

- a) Antenna must be permanently attached to the device.
- b) Antenna must use a unique type of connector to attach to the device.

Device must be professionally installed. Installer shall be responsible for ensuring that the correct antenna is employed with the device.

The antenna connector is SMT type. Antenna maximum gain is 0 dBi for 2.400–2.500 GHz band.

Results: PASS

5.2 Conducted Emissions Voltage

Requirement:

Frequency of emission (MHz)	Conducted limit (dB μ V)	
	Quasi-peak	Average
0.15–0.5	66 to 56*	56 to 46*
0.5–5	56	46
5–30	60	50

*Decreases with the logarithm of the frequency.

Procedures:

- All possible modes of operation were investigated. Only the 6 worst case emissions measured, using the correct CISPR and Average detectors, are reported. All other emissions were relatively insignificant.
- A "-ve" margin indicates a PASS as it refers to the margin present below the limit line at the particular frequency.
- Conducted Emissions Measurement Uncertainty
All test measurements carried out are traceable to national standards. The uncertainty of the measurement at a confidence level of approximately 95% (in the case where distributions are normal), with a coverage factor of 2, in the range 9kHz – 30MHz (Average & Quasi-peak) is ± 3.86 dB.
- Environmental Conditions

Temperature	24°C
Relative Humidity	52%
Atmospheric Pressure	1019mbar

Test Date : May 26-Jun 08 2011
Tested By :Choon Sian Ooi

Results: Pass

EUT: GX420d

Results: Note –

Average Limit

Quasi-Peak Limit

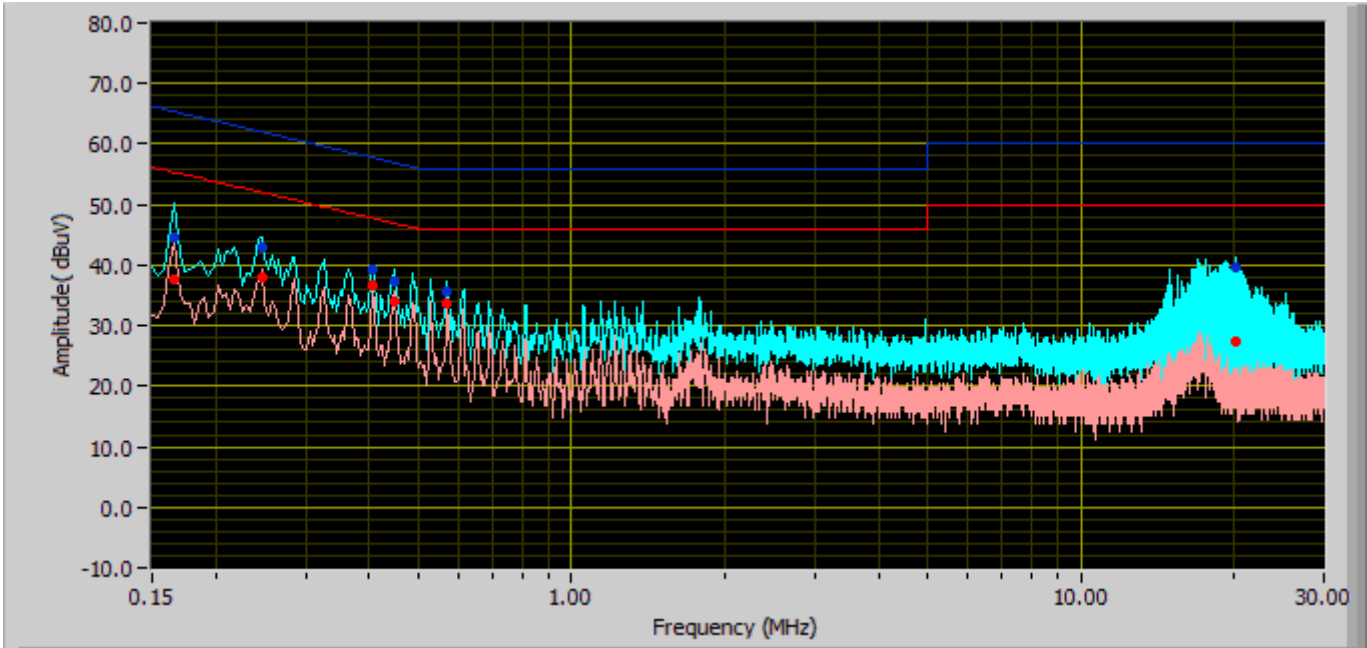

Phase Line Plot at 120Vac, 60Hz

Line Under Test	Freq. (MHz)	Corrected Amplitude (dBuV)	Limit (dBuV) QP	Margin (dB) QP	Corrected Amplitude (dBuV)	Limit (dBuV) AVG	Margin (dB) AVG
Neutral	0.17	44.74	65.33	-20.59	37.69	55.33	-17.64
Neutral	0.25	42.82	62.00	-19.18	38.00	52.00	-14.00
Neutral	0.45	37.36	56.89	-19.53	34.15	46.89	-12.74
Neutral	0.41	39.18	57.76	-18.58	36.60	47.76	-11.16
Neutral	0.57	35.81	56.00	-20.19	33.53	46.00	-12.47
Neutral	20.13	39.54	60.00	-20.46	27.50	50.00	-22.50

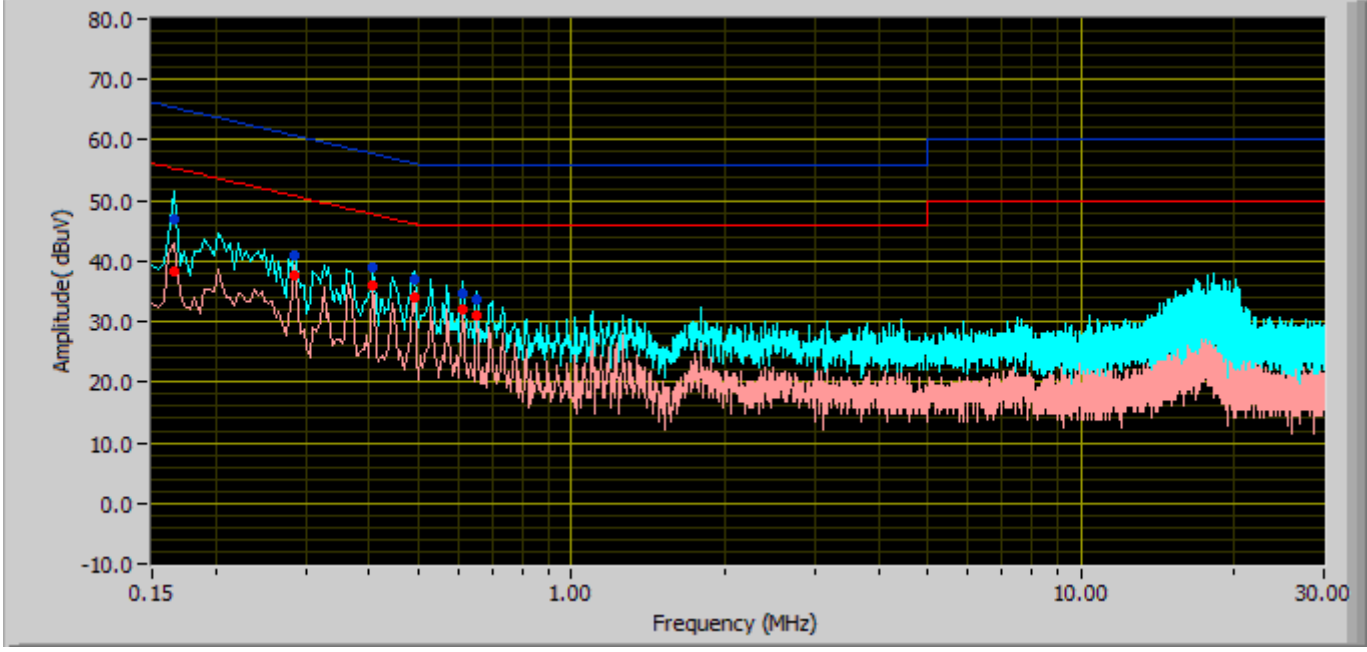

Neutral Line Plot at 120Vac, 60Hz

Line Under Test	Freq. (MHz)	Corrected Amplitude (dBuV) QP	Limit (dBuV) QP	Margin (dB) QP	Corrected Amplitude (dBuV) AVG	Limit (dBuV) AVG	Margin (dB) AVG
Line	0.17	47.04	65.33	-18.29	38.26	55.33	-17.07
Line	0.49	36.85	56.17	-19.32	33.89	46.17	-12.27
Line	0.29	41.11	60.73	-19.62	37.51	50.73	-13.22
Line	0.61	34.63	56.00	-21.37	32.09	46.00	-13.91
Line	0.41	38.90	57.76	-18.86	36.04	47.76	-11.72
Line	0.65	33.63	56.00	-22.37	31.05	46.00	-14.95

EUT: GX420t

Results: Note –

Average Limit

Quasi-Peak Limit

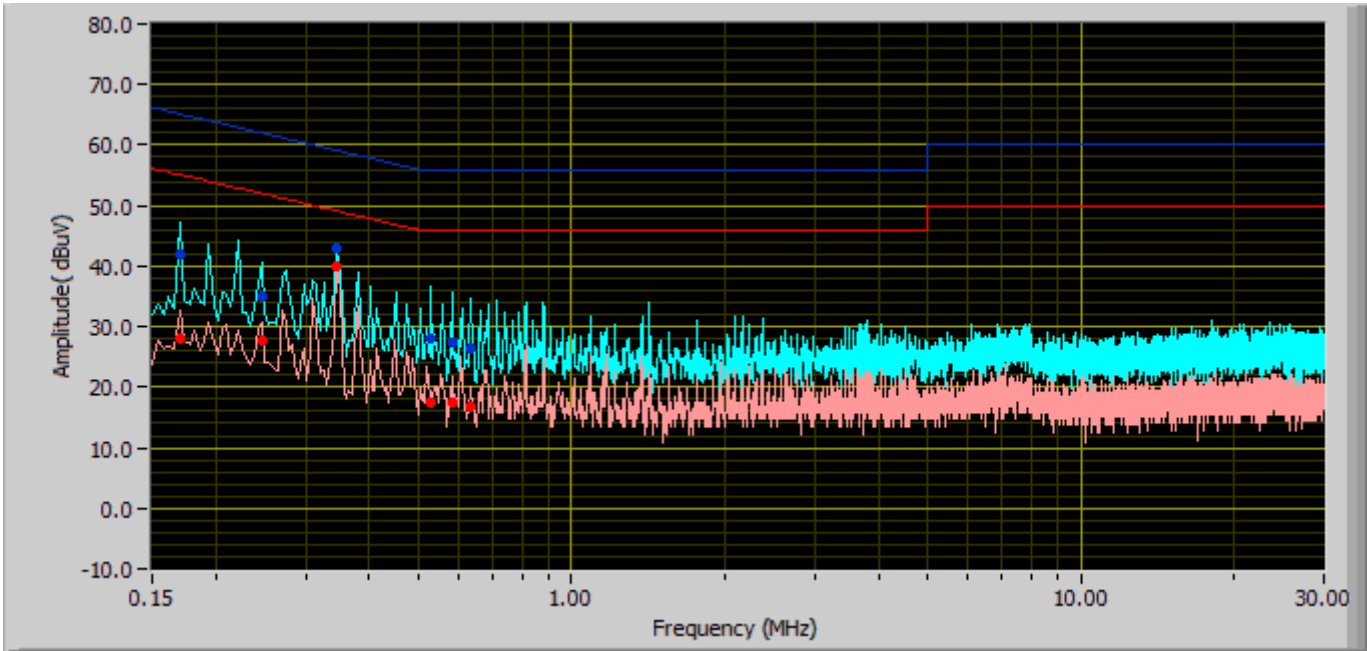

Phase Line Plot at 120Vac, 60Hz

Line Under Test	Freq. (MHz)	Corrected Amplitude (dBuV)	Limit (dBuV) QP	Margin (dB) QP	Corrected Amplitude (dBuV)	Limit (dBuV) AVG	Margin (dB) AVG
Neutral	0.35	42.91	59.11	-16.20	40.05	49.11	-9.07
Neutral	0.17	41.85	65.13	-23.28	28.05	55.13	-27.08
Neutral	0.53	27.92	56.00	-28.08	17.38	46.00	-28.62
Neutral	0.58	27.26	56.00	-28.74	17.46	46.00	-28.54
Neutral	0.25	35.02	62.00	-26.98	27.56	52.00	-24.44
Neutral	0.63	26.54	56.00	-29.46	16.71	46.00	-29.29

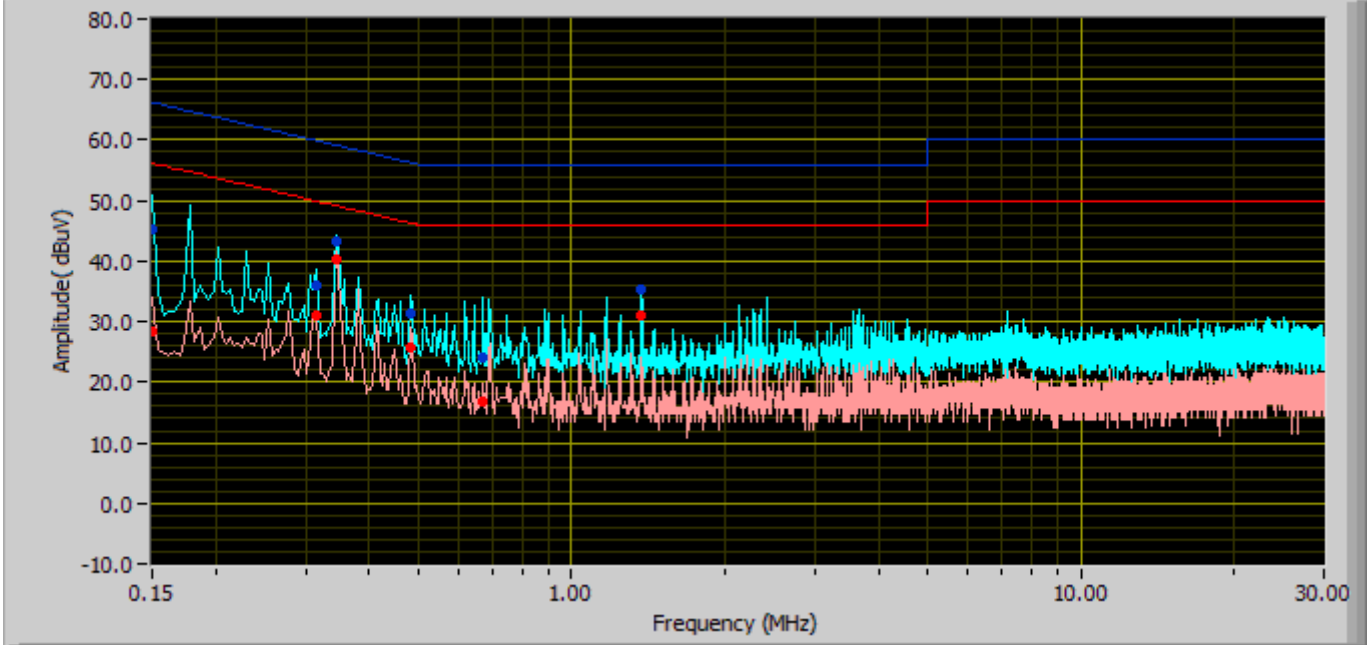

Neutral Line Plot at 120Vac, 60Hz

Line Under Test	Freq. (MHz)	Corrected Amplitude (dBuV) QP	Limit (dBuV) QP	Margin (dB) QP	Corrected Amplitude (dBuV) AVG	Limit (dBuV) AVG	Margin (dB) AVG
Line	0.35	43.43	59.11	-15.68	40.33	49.11	-8.78
Line	0.15	45.10	66.19	-21.08	28.52	56.19	-27.67
Line	0.31	36.10	59.94	-23.83	30.94	49.94	-18.99
Line	1.37	35.20	56.00	-20.80	30.86	46.00	-15.14
Line	0.48	31.31	56.31	-24.99	25.76	46.31	-20.55
Line	0.67	24.00	56.00	-32.00	16.76	46.00	-29.24

EUT: GX430t

Results: Note –

Average Limit

Quasi-Peak Limit

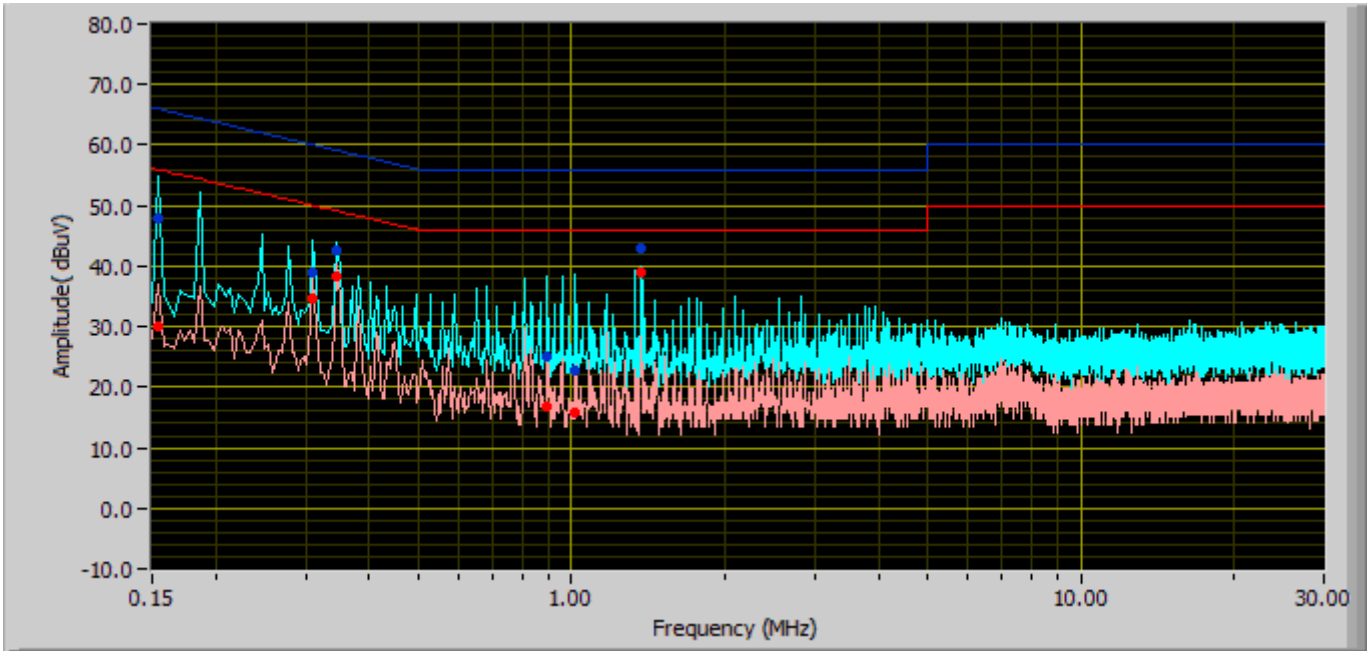

Phase Line Plot at 120Vac, 60Hz

Line Under Test	Freq. (MHz)	Corrected Amplitude (dBuV)	Limit (dBuV) QP	Margin (dB) QP	Corrected Amplitude (dBuV)	Limit (dBuV) AVG	Margin (dB) AVG
Neutral	0.15	47.81	65.97	-18.15	29.92	55.97	-26.05
Neutral	0.35	42.53	59.11	-16.58	38.26	49.11	-10.85
Neutral	0.31	39.13	60.04	-20.92	34.52	50.04	-15.53
Neutral	1.37	42.99	56.00	-13.01	38.86	46.00	-7.14
Neutral	1.02	22.71	56.00	-33.29	15.78	46.00	-30.22
Neutral	0.89	25.03	56.00	-30.97	16.73	46.00	-29.27

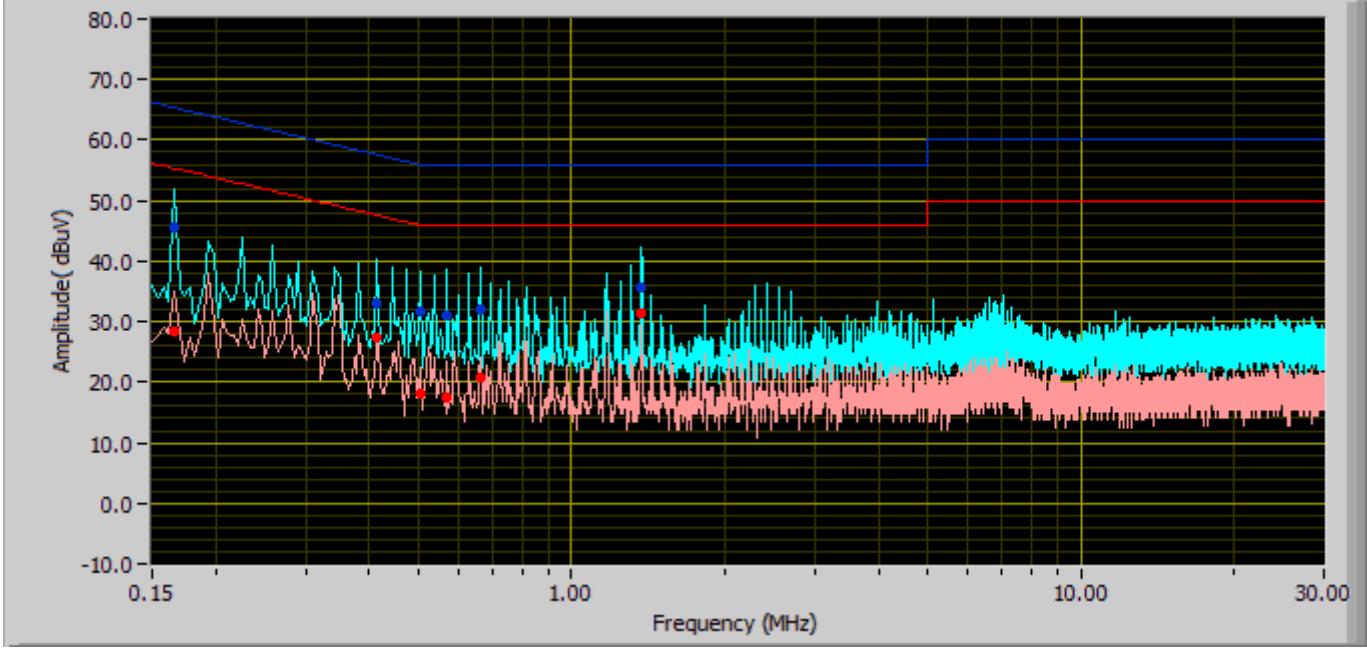

Neutral Line Plot at 120Vac, 60Hz

Line Under Test	Freq. (MHz)	Corrected Amplitude (dBuV) QP	Limit (dBuV) QP	Margin (dB) QP	Corrected Amplitude (dBuV) AVG	Limit (dBuV) AVG	Margin (dB) AVG
Line	0.17	45.71	65.33	-19.62	28.50	55.33	-26.83
Line	1.37	35.50	56.00	-20.50	31.36	46.00	-14.64
Line	0.66	32.17	56.00	-23.83	20.83	46.00	-25.17
Line	0.41	33.01	57.59	-24.59	27.37	47.59	-20.23
Line	0.57	30.94	56.00	-25.06	17.44	46.00	-28.56
Line	0.51	31.64	56.00	-24.36	18.10	46.00	-27.90

5.3 Radiated Spurious Emission < 1GHz

1. All possible modes of operation were investigated. Only the 6 worst case emissions measured, using the correct CISPR detectors, are reported. All other emissions were relatively insignificant.
2. A "-ve" margin indicates a PASS as it refers to the margin present below the limit line at the particular frequency.
3. Radiated Emissions Measurement Uncertainty
All test measurements carried out are traceable to national standards. The uncertainty of the measurement at a confidence level of approximately 95% (in the case where distributions are normal), with a coverage factor of 2, in the range 30MHz – 1GHz (QP only @ 3m & 10m) is +6.0dB (for EUTs < 0.5m X 0.5m X 0.5m).
4. Environmental Conditions

Temperature	23°C
Relative Humidity	50%
Atmospheric Pressure	1019mbar

Test Date : May 26-Jun 08 2011
Tested By :Choon Sian Ooi

Standard Requirement: 47 CFR §15.247(d)

Procedures: Radiated emissions were measured according to ANSI C63.4. The EUT was set to transmit at the highest output power. The EUT was set to transmit at mid channel. Note that setting the channel other than middle, the spurious emissions are the same.

The limit is converted from microvolts/meter to decibel microvolts/meter.

Sample Calculation: Corrected Amplitude = Raw Amplitude (dBμV/m) + ACF (dB) + Cable Loss (dB)

Test Result: Pass

TX-Radiated Emissions-GX420d

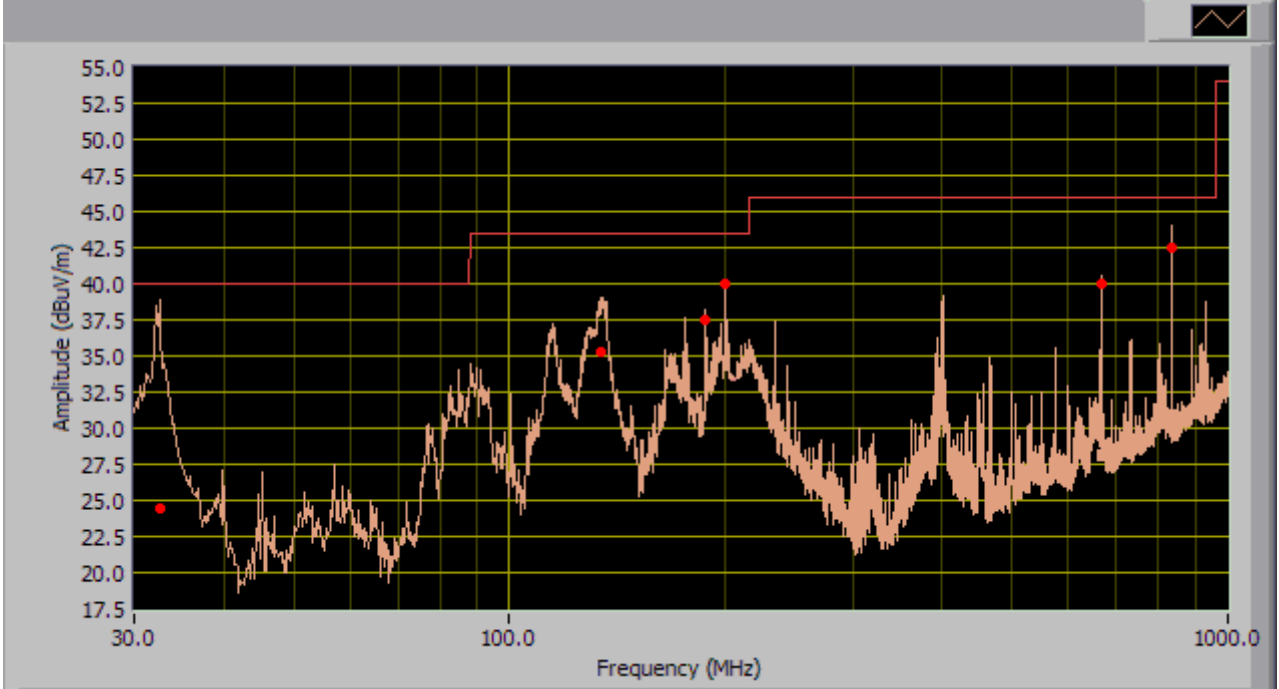

Limit

30MHz ~1000MHz Result @ 3m

Frequency (MHz)	Corrected Quasi-Peak (dBµV/m) @ 3m	Turntable position (deg)	Polarity	Antenna height (cm)	Limit (dBµV/m)	Margin (dB)
834.80	30.80	294.00	V	218.00	46.00	-15.20
32.44	24.43	309.00	V	189.00	40.00	-15.57
200.02	37.52	230.00	H	103.00	43.50	-5.98
133.83	35.25	190.00	V	100.00	43.50	-8.25
187.40	35.16	265.00	H	246.00	43.50	-8.34
667.60	28.12	316.00	H	399.00	46.00	-17.88

TX-Radiated Emissions – GX430t

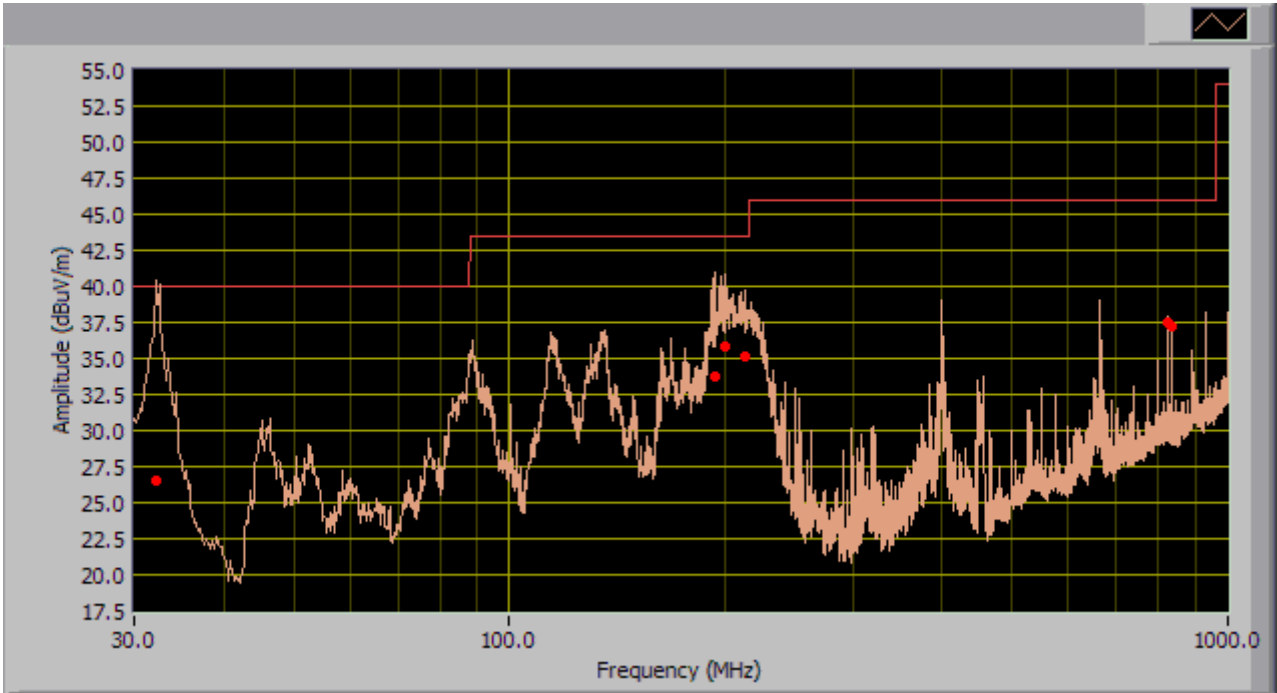

Limit

30MHz ~1000MHz Result @ 3m

Frequency (MHz)	Corrected Quasi-Peak (dB μ V/m) @ 3m	Turntable position (deg)	Polarity	Antenna height (cm)	Limit (dB μ V/m)	Margin (dB)
834.68	37.33	278.00	H	155.00	46.00	-8.67
824.34	37.59	69.00	H	144.00	46.00	-8.41
32.21	26.50	257.00	V	100.00	40.00	-13.50
192.46	33.76	267.00	H	143.00	43.50	-9.74
199.98	35.80	255.00	H	134.00	43.50	-7.70
212.19	35.09	251.00	H	142.00	43.50	-8.41

RX-Radiated Emissions- GX420t

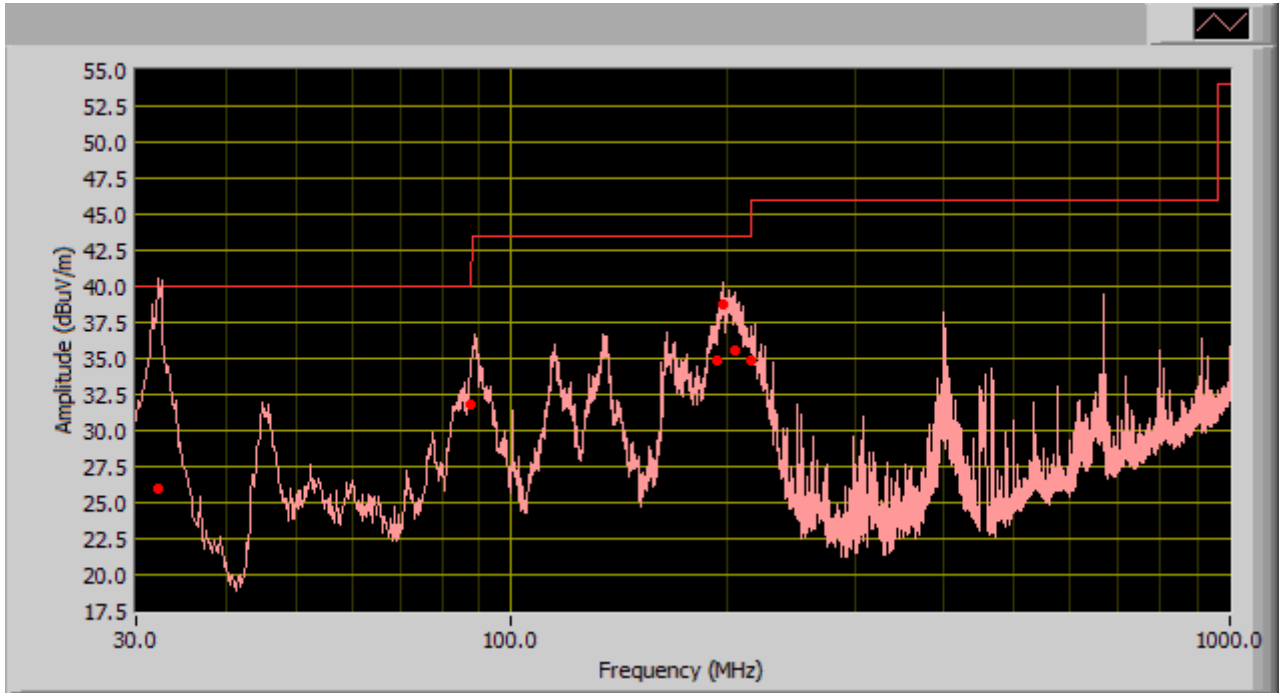

Limit

30MHz ~1000MHz Result @ 3m

Frequency (MHz)	Corrected Quasi-Peak (dBμV/m) @ 3m	Turntable position (deg)	Polarity	Antenna height (cm)	Limit (dBμV/m)	Margin (dB)
32.14	25.99	19.00	V	101.00	40.00	-14.01
196.55	38.73	248.00	H	155.00	43.50	-4.77
205.22	35.59	260.00	H	102.00	43.50	-7.91
87.77	31.85	5.00	V	130.00	40.00	-8.15
192.98	34.84	261.00	H	149.00	43.50	-8.66
215.73	34.82	255.00	H	149.00	43.50	-8.68

5.4 Radiated Spurious Emissions > 1GHz & Band Edge

1. All possible modes of operation were investigated. Only the 6 worst case emissions measured, using the correct CISPR detectors, are reported. All other emissions were relatively insignificant.
2. A "-ve" margin indicates a PASS as it refers to the margin present below the limit line at the particular frequency.
3. Radiated Emissions Measurement Uncertainty
All test measurements carried out are traceable to national standards. The uncertainty of the measurement at a confidence level of approximately 95% (in the case where distributions are normal), with a coverage factor of 2, in the range 1GHz – 40GH is +6.0dB (for EUTs < 0.5m X 0.5m X 0.5m).
4. Environmental Conditions

Temperature	23°C
Relative Humidity	50%
Atmospheric Pressure	1019mbar

Test Date : May 26-Jun 08 2011
Tested By :Choon Sian Ooi

Standard Requirement: 47 CFR §15.247(d)

Procedures: Equipment was setup in a semi-anechoic chamber. For measurements above 1 GHz an average measurement was taken with a 10Hz video bandwidth. The EUT was tested at low, mid and high with the highest output power. An emission was scan up to 10th harmonic of the operating frequency.

Sample Calculation:

EUT Field Strength = Raw Amplitude (dBμV/m) – Amplifier Gain (dB) + Antenna Factor (dB) + Cable Loss (dB) + Filter Attenuation (dB, if used)

Test Result: Pass

Host GX420d -Configuration: 802.11g

Low Channel @ 2412MHz @ 3 Meter

Frequency (GHz)	Reading (dBuV/m)	Direction (degree)	Height (m)	Polarity (H/V)	Antenna Loss (dB)	Cable Loss (dB)	Amplifier (dB)	Corrected Reading (dBuV/m)	15.247/15.209 Limit @ 3m (dBuV/m)	Margin (dBuV/m)	Detector (pk/avg)
4.824	40.41	125.00	1.50	v	32.20	4.13	32.49	44.25	74.00	-29.76	Peak
4.824	40.43	128.00	1.40	h	32.20	4.13	32.49	44.27	74.00	-29.74	Peak
4.824	26.28	125.00	1.50	v	32.20	4.13	32.49	30.12	54.00	-23.89	Ave
4.824	26.26	128.00	1.40	h	32.20	4.13	32.49	30.10	54.00	-23.91	Ave
2.400	61.26	145.00	2.10	v	27.50	2.50	32.04	59.22	74.00	-14.78	Peak
2.400	66.47	176.00	2.70	h	27.50	2.50	32.04	64.43	74.00	-9.57	Peak
2.400	38.91	145.00	2.10	v	27.50	2.50	32.04	36.87	54.00	-17.13	Ave
2.400	41.37	176.00	2.70	h	27.50	2.50	32.04	39.33	54.00	-14.67	Ave

Note: Emission was scanned up to 25GHz; no emissions were detected above the noise floor which was at least 20dB below the specification limit

Mid Channel @ 2437MHz @ 3 Meter

Frequency (GHz)	Reading (dBuV/m)	Direction (degree)	Height (m)	Polarity (H/V)	Antenna Loss (dB)	Cable Loss (dB)	Amplifier (dB)	Corrected Reading (dBuV/m)	15.247/15.209 Limit @ 3m (dBuV/m)	Margin (dBuV/m)	Detector (pk/avg)
4.87	46.24	125.00	1.50	v	32.20	4.13	32.49	50.08	70.00	-19.93	Peak
4.87	46.16	235.00	1.30	h	32.20	4.13	32.49	50.00	70.00	-20.01	Peak
4.87	32.55	125.00	1.50	v	32.20	4.13	32.49	36.39	50.00	-13.62	Ave
4.87	32.59	235.00	1.30	h	32.20	4.13	32.49	36.43	50.00	-13.58	Ave

Note: Emission was scanned up to 25 GHz; no emissions were detected above the noise floor which was at least 20dB below the specification limit

High Channel @ 2462MHz @ 3 Meter

Frequency (GHz)	Reading (dBuV/m)	Direction (degree)	Height (m)	Polarity (H/V)	Antenna Loss (dB)	Cable Loss (dB)	Amplifier (dB)	Corrected Reading (dBuV/m)	15.247/15.209 Limit @ 3m (dBuV/m)	Margin (dBuV/m)	Detector (pk/avg)
4.924	40.35	136.00	1.50	v	32.20	4.13	32.49	44.19	74.00	-29.82	Peak
4.924	40.89	128.00	1.40	h	32.20	4.13	32.49	44.73	74.00	-29.28	Peak
4.924	26.42	136.00	1.50	v	32.20	4.13	32.49	30.26	54.00	-23.75	Ave
4.924	26.31	128.00	1.40	h	32.20	4.13	32.49	30.15	54.00	-23.86	Ave
2.484	43.80	158.00	1.60	v	27.50	2.50	32.04	41.76	74.00	-32.24	Peak
2.484	42.56	136.00	1.50	h	27.50	2.50	32.04	40.52	74.00	-33.48	Peak
2.484	27.70	158.00	1.60	v	27.50	2.50	32.04	25.66	54.00	-28.34	Ave
2.484	26.68	136.00	1.50	h	27.50	2.50	32.04	24.64	54.00	-29.36	Ave

Note: Emission was scanned up to 25GHz; no emissions were detected above the noise floor which was at least 20dB below the specification limit

Host GX420d -Configuration: 802.11b

Low Channel @ 2412MHz @ 3 Meter

Frequency (GHz)	Reading (dBuV/m)	Direction (degree)	Height (m)	Polarity (H/V)	Antenna Loss (dB)	Cable Loss (dB)	Amplifier (dB)	Corrected Reading (dBuV/m)	15.247/15.209 Limit @ 3m (dBuV/m)	Margin (dBuV/m)	Detector (pk/avg)
4.824	40.51	125.00	1.50	v	32.20	4.13	32.49	44.35	74.00	-29.66	Peak
4.824	44.38	128.00	1.40	h	32.20	4.13	32.49	48.22	74.00	-25.79	Peak
4.824	27.62	125.00	1.50	v	32.20	4.13	32.49	31.46	54.00	-22.55	Ave
4.824	30.31	128.00	1.40	h	32.20	4.13	32.49	34.15	54.00	-19.86	Ave
2.400	48.79	165.00	2.80	v	27.50	2.50	32.04	46.75	74.00	-27.25	Peak
2.400	51.04	148.00	2.40	h	27.50	2.50	32.04	49.00	74.00	-25.00	Peak
2.400	36.86	165.00	2.80	v	27.50	2.50	32.04	34.82	54.00	-19.18	Ave
2.400	39.22	148.00	2.40	h	27.50	2.50	32.04	37.18	54.00	-16.82	Ave

Note: Emission was scanned up to 25GHz; no emissions were detected above the noise floor which was at least 20dB below the specification limit

Mid Channel @ 2437MHz @ 3 Meter

Frequency (GHz)	Reading (dBuV/m)	Direction (degree)	Height (m)	Polarity (H/V)	Antenna Loss (dB)	Cable Loss (dB)	Amplifier (dB)	Corrected Reading (dBuV/m)	15.247/15.209 Limit @ 3m (dBuV/m)	Margin (dBuV/m)	Detector (pk/avg)
4.87	42.03	125.00	1.50	v	32.20	4.13	32.49	45.87	70.00	-24.14	Peak
4.87	46.16	235.00	1.30	h	32.20	4.13	32.49	50.00	70.00	-20.01	Peak
4.87	28.08	125.00	1.50	v	32.20	4.13	32.49	31.92	50.00	-18.09	Ave
4.87	26.98	235.00	1.30	h	32.20	4.13	32.49	30.82	50.00	-19.19	Ave

Note: Emission was scanned up to 25 GHz; no emissions were detected above the noise floor which was at least 20dB below the specification limit

High Channel @ 2462MHz @ 3 Meter

Frequency (GHz)	Reading (dBuV/m)	Direction (degree)	Height (m)	Polarity (H/V)	Antenna Loss (dB)	Cable Loss (dB)	Amplifier (dB)	Corrected Reading (dBuV/m)	15.247/15.209 Limit @ 3m (dBuV/m)	Margin (dBuV/m)	Detector (pk/avg)
4.924	39.68	136.00	1.50	v	32.20	4.13	32.49	43.52	74.00	-30.49	Peak
4.924	46.39	128.00	1.40	h	32.20	4.13	32.49	50.23	74.00	-23.78	Peak
4.924	25.54	136.00	1.50	v	32.20	4.13	32.49	29.38	54.00	-24.63	Ave
4.924	33.26	128.00	1.40	h	32.20	4.13	32.49	37.10	54.00	-16.91	Ave
2.484	43.55	159.00	2.50	v	27.50	2.50	32.04	41.51	74.00	-32.49	Peak
2.484	42.30	126.00	2.10	h	27.50	2.50	32.04	40.26	74.00	-33.74	Peak
2.484	25.22	159.00	2.50	v	27.50	2.50	32.04	23.18	54.00	-30.82	Ave
2.484	27.65	126.00	2.10	h	27.50	2.50	32.04	25.61	54.00	-28.39	Ave

Note: Emission was scanned up to 25GHz; no emissions were detected above the noise floor which was at least 20dB below the specification limit

Host GX430t -Configuration: 802.11g

Low Channel @ 2412MHz @ 3 Meter

Frequency (GHz)	Reading (dBuV/m)	Direction (degree)	Height (m)	Polarity (H/V)	Antenna Loss (dB)	Cable Loss (dB)	Amplifier (dB)	Corrected Reading (dBuV/m)	15.247/15.209 Limit @ 3m (dBuV/m)	Margin (dBuV/m)	Detector (pk/avg)
4.824	42.23	156.00	1.90	v	32.20	4.13	32.49	46.07	74.00	-27.94	Peak
4.824	43.14	148.00	1.60	h	32.20	4.13	32.49	46.98	74.00	-27.03	Peak
4.824	24.24	156.00	1.90	v	32.20	4.13	32.49	28.08	54.00	-25.93	Ave
4.824	24.96	148.00	1.60	h	32.20	4.13	32.49	28.80	54.00	-25.21	Ave
2.400	59.24	137.00	2.60	v	27.50	2.50	32.04	57.20	74.00	-16.80	Peak
2.400	68.12	146.00	2.10	h	27.50	2.50	32.04	66.08	74.00	-7.92	Peak
2.400	37.24	137.00	2.60	v	27.50	2.50	32.04	35.20	54.00	-18.80	Ave
2.400	45.44	146.00	2.10	h	27.50	2.50	32.04	43.40	54.00	-10.60	Ave

Note: Emission was scanned up to 25GHz; no emissions were detected above the noise floor which was at least 20dB below the specification limit

Mid Channel @ 2437MHz @ 3 Meter

Frequency (GHz)	Reading (dBuV/m)	Direction (degree)	Height (m)	Polarity (H/V)	Antenna Loss (dB)	Cable Loss (dB)	Amplifier (dB)	Corrected Reading (dBuV/m)	15.247/15.209 Limit @ 3m (dBuV/m)	Margin (dBuV/m)	Detector (pk/avg)
4.87	48.68	178.00	1.90	v	32.20	4.13	32.49	52.52	70.00	-17.49	Peak
4.87	49.39	147.00	1.40	h	32.20	4.13	32.49	53.23	70.00	-16.78	Peak
4.87	34.35	178.00	1.90	v	32.20	4.13	32.49	38.19	50.00	-11.82	Ave
4.87	36.46	147.00	1.40	h	32.20	4.13	32.49	40.30	50.00	-9.71	Ave

Note: Emission was scanned up to 25 GHz; no emissions were detected above the noise floor which was at least 20dB below the specification limit

High Channel @ 2462MHz @ 3 Meter

Frequency (GHz)	Reading (dBuV/m)	Direction (degree)	Height (m)	Polarity (H/V)	Antenna Loss (dB)	Cable Loss (dB)	Amplifier (dB)	Corrected Reading (dBuV/m)	15.247/15.209 Limit @ 3m (dBuV/m)	Margin (dBuV/m)	Detector (pk/avg)
4.924	42.57	186.00	1.50	v	32.20	4.13	32.49	46.41	74.00	-27.60	Peak
4.924	45.84	175.00	1.40	h	32.20	4.13	32.49	49.68	74.00	-24.33	Peak
4.924	29.47	186.00	1.50	v	32.20	4.13	32.49	33.31	54.00	-20.70	Ave
4.924	30.75	175.00	1.40	h	32.20	4.13	32.49	34.59	54.00	-19.42	Ave
2.484	41.15	148.00	1.60	v	27.50	2.50	32.04	39.11	74.00	-34.89	Peak
2.484	46.21	126.00	1.50	h	27.50	2.50	32.04	44.17	74.00	-29.83	Peak
2.484	28.57	148.00	1.60	v	27.50	2.50	32.04	26.53	54.00	-27.47	Ave
2.484	33.22	126.00	1.50	h	27.50	2.50	32.04	31.18	54.00	-22.82	Ave

Note: Emission was scanned up to 25GHz; no emissions were detected above the noise floor which was at least 20dB below the specification limit

Host GX430t -Configuration: 802.11b

Low Channel @ 2412MHz @ 3 Meter

Frequency (GHz)	Reading (dBuV/m)	Direction (degree)	Height (m)	Polarity (H/V)	Antenna Loss (dB)	Cable Loss (dB)	Amplifier (dB)	Corrected Reading (dBuV/m)	15.247/15.209 Limit @ 3m (dBuV/m)	Margin (dBuV/m)	Detector (pk/avg)
4.824	41.37	186.00	1.80	v	32.20	4.13	32.49	45.21	74.00	-28.80	Peak
4.824	43.75	146.00	1.70	h	32.20	4.13	32.49	47.59	74.00	-26.42	Peak
4.824	28.86	186.00	1.80	v	32.20	4.13	32.49	32.70	54.00	-21.31	Ave
4.824	31.38	146.00	1.70	h	32.20	4.13	32.49	35.22	54.00	-18.79	Ave
2.400	46.30	186.00	1.55	v	27.50	2.50	32.04	44.26	74.00	-29.74	Peak
2.400	51.36	136.00	1.48	h	27.50	2.50	32.04	49.32	74.00	-24.68	Peak
2.400	32.29	186.00	1.55	v	27.50	2.50	32.04	30.25	54.00	-23.75	Ave
2.400	38.36	136.00	1.48	h	27.50	2.50	32.04	36.32	54.00	-17.68	Ave

Note: Emission was scanned up to 25GHz; no emissions were detected above the noise floor which was at least 20dB below the specification limit

Mid Channel @ 2437MHz @ 3 Meter

Frequency (GHz)	Reading (dBuV/m)	Direction (degree)	Height (m)	Polarity (H/V)	Antenna Loss (dB)	Cable Loss (dB)	Amplifier (dB)	Corrected Reading (dBuV/m)	15.247/15.209 Limit @ 3m (dBuV/m)	Margin (dBuV/m)	Detector (pk/avg)
4.87	43.86	158.00	1.50	v	32.20	4.13	32.49	47.70	70.00	-22.31	Peak
4.87	45.63	139.00	1.30	h	32.20	4.13	32.49	49.47	70.00	-20.54	Peak
4.87	29.26	158.00	1.50	v	32.20	4.13	32.49	33.10	50.00	-16.91	Ave
4.87	30.47	139.00	1.30	h	32.20	4.13	32.49	34.31	50.00	-15.70	Ave

Note: Emission was scanned up to 25 GHz; no emissions were detected above the noise floor which was at least 20dB below the specification limit

High Channel @ 2462MHz @ 3 Meter

Frequency (GHz)	Reading (dBuV/m)	Direction (degree)	Height (m)	Polarity (H/V)	Antenna Loss (dB)	Cable Loss (dB)	Amplifier (dB)	Corrected Reading (dBuV/m)	15.247/15.209 Limit @ 3m (dBuV/m)	Margin (dBuV/m)	Detector (pk/avg)
4.924	40.47	185.00	1.80	v	32.20	4.13	32.49	44.31	74.00	-29.70	Peak
4.924	44.85	168.00	1.40	h	32.20	4.13	32.49	48.69	74.00	-25.32	Peak
4.924	27.34	185.00	1.80	v	32.20	4.13	32.49	31.18	54.00	-22.83	Ave
4.924	32.46	168.00	1.40	h	32.20	4.13	32.49	36.30	54.00	-17.71	Ave
2.484	42.66	138.00	1.50	v	27.50	2.50	32.04	40.62	74.00	-33.38	Peak
2.484	47.25	197.00	1.90	h	27.50	2.50	32.04	45.21	74.00	-28.79	Peak
2.484	28.14	138.00	1.50	v	27.50	2.50	32.04	26.10	54.00	-27.90	Ave
2.484	33.78	197.00	1.90	h	27.50	2.50	32.04	31.74	54.00	-22.26	Ave

Note: Emission was scanned up to 25GHz; no emissions were detected above the noise floor which was at least 20dB below the specification limit

Host GX420t -Configuration: 802.11g

Low Channel @ 2412MHz @ 3 Meter

Frequency (GHz)	Reading (dBuV/m)	Direction (degree)	Height (m)	Polarity (H/V)	Antenna Loss (dB)	Cable Loss (dB)	Amplifier (dB)	Corrected Reading (dBuV/m)	15.247/15.209 Limit @ 3m (dBuV/m)	Margin (dBuV/m)	Detector (pk/avg)
4.824	41.57	197.00	1.90	v	32.20	4.13	32.49	45.41	74.00	-28.60	Peak
4.824	43.96	148.00	1.60	h	32.20	4.13	32.49	47.80	74.00	-26.21	Peak
4.824	23.16	197.00	1.90	v	32.20	4.13	32.49	27.00	54.00	-27.01	Ave
4.824	25.36	148.00	1.60	h	32.20	4.13	32.49	29.20	54.00	-24.81	Ave
2.400	58.18	137.00	1.70	v	27.50	2.50	32.04	56.14	74.00	-17.86	Peak
2.400	65.13	185.00	1.20	h	27.50	2.50	32.04	63.09	74.00	-10.91	Peak
2.400	36.16	137.00	1.70	v	27.50	2.50	32.04	34.12	54.00	-19.88	Ave
2.400	43.33	185.00	1.20	h	27.50	2.50	32.04	41.29	54.00	-12.71	Ave

Note: Emission was scanned up to 25GHz; no emissions were detected above the noise floor which was at least 20dB below the specification limit

Mid Channel @ 2437MHz @ 3 Meter

Frequency (GHz)	Reading (dBuV/m)	Direction (degree)	Height (m)	Polarity (H/V)	Antenna Loss (dB)	Cable Loss (dB)	Amplifier (dB)	Corrected Reading (dBuV/m)	15.247/15.209 Limit @ 3m (dBuV/m)	Margin (dBuV/m)	Detector (pk/avg)
4.87	45.46	196.00	1.80	v	32.20	4.13	32.49	49.30	70.00	-20.71	Peak
4.87	47.35	168.00	1.60	h	32.20	4.13	32.49	51.19	70.00	-18.82	Peak
4.87	35.64	196.00	1.80	v	32.20	4.13	32.49	39.48	50.00	-10.53	Ave
4.87	37.52	168.00	1.60	h	32.20	4.13	32.49	41.36	50.00	-8.65	Ave

Note: Emission was scanned up to 25 GHz; no emissions were detected above the noise floor which was at least 20dB below the specification limit

High Channel @ 2462MHz @ 3 Meter

Frequency (GHz)	Reading (dBuV/m)	Direction (degree)	Height (m)	Polarity (H/V)	Antenna Loss (dB)	Cable Loss (dB)	Amplifier (dB)	Corrected Reading (dBuV/m)	15.247/15.209 Limit @ 3m (dBuV/m)	Margin (dBuV/m)	Detector (pk/avg)
4.924	41.68	168.00	1.40	v	32.20	4.13	32.49	45.52	74.00	-28.49	Peak
4.924	43.57	147.00	1.30	h	32.20	4.13	32.49	47.41	74.00	-26.60	Peak
4.924	31.68	168.00	1.40	v	32.20	4.13	32.49	35.52	54.00	-18.49	Ave
4.924	33.64	147.00	1.30	h	32.20	4.13	32.49	37.48	54.00	-16.53	Ave
2.484	44.23	167.00	1.90	v	27.50	2.50	32.04	42.19	74.00	-31.81	Peak
2.484	46.05	136.00	1.40	h	27.50	2.50	32.04	44.01	74.00	-29.99	Peak
2.484	29.86	167.00	1.90	v	27.50	2.50	32.04	27.82	54.00	-26.18	Ave
2.484	32.61	136.00	1.40	h	27.50	2.50	32.04	30.57	54.00	-23.43	Ave

Note: Emission was scanned up to 25GHz; no emissions were detected above the noise floor which was at least 20dB below the specification limit

Host GX420t -Configuration: 802.11b

Low Channel @ 2412MHz @ 3 Meter

Frequency (GHz)	Reading (dBuV/m)	Direction (degree)	Height (m)	Polarity (H/V)	Antenna Loss (dB)	Cable Loss (dB)	Amplifier (dB)	Corrected Reading (dBuV/m)	15.247/15.209 Limit @ 3m (dBuV/m)	Margin (dBuV/m)	Detector (pk/avg)
4.824	42.57	219.00	1.50	v	32.20	4.13	32.49	46.41	74.00	-27.60	Peak
4.824	44.57	168.00	1.90	h	32.20	4.13	32.49	48.41	74.00	-25.60	Peak
4.824	29.78	219.00	1.50	v	32.20	4.13	32.49	33.62	54.00	-20.39	Ave
4.824	32.75	168.00	1.90	h	32.20	4.13	32.49	36.59	54.00	-17.42	Ave
2.400	44.79	176.00	1.50	v	27.50	2.50	32.04	42.75	74.00	-31.25	Peak
2.400	50.79	148.00	1.10	h	27.50	2.50	32.04	48.75	74.00	-25.25	Peak
2.400	30.75	176.00	1.50	v	27.50	2.50	32.04	28.71	54.00	-25.29	Ave
2.400	38.17	148.00	1.10	h	27.50	2.50	32.04	36.13	54.00	-17.87	Ave

Note: Emission was scanned up to 25GHz; no emissions were detected above the noise floor which was at least 20dB below the specification limit

Mid Channel @ 2437MHz @ 3 Meter

Frequency (GHz)	Reading (dBuV/m)	Direction (degree)	Height (m)	Polarity (H/V)	Antenna Loss (dB)	Cable Loss (dB)	Amplifier (dB)	Corrected Reading (dBuV/m)	15.247/15.209 Limit @ 3m (dBuV/m)	Margin (dBuV/m)	Detector (pk/avg)
4.87	43.86	158.00	1.50	v	32.20	4.13	32.49	47.70	70.00	-22.31	Peak
4.87	45.63	139.00	1.30	h	32.20	4.13	32.49	49.47	70.00	-20.54	Peak
4.87	29.26	158.00	1.50	v	32.20	4.13	32.49	33.10	50.00	-16.91	Ave
4.87	30.47	139.00	1.30	h	32.20	4.13	32.49	34.31	50.00	-15.70	Ave

Note: Emission was scanned up to 25 GHz; no emissions were detected above the noise floor which was at least 20dB below the specification limit

High Channel @ 2462MHz @ 3 Meter

Frequency (GHz)	Reading (dBuV/m)	Direction (degree)	Height (m)	Polarity (H/V)	Antenna Loss (dB)	Cable Loss (dB)	Amplifier (dB)	Corrected Reading (dBuV/m)	15.247/15.209 Limit @ 3m (dBuV/m)	Margin (dBuV/m)	Detector (pk/avg)
4.87	44.64	185.00	1.70	v	32.20	4.13	32.49	48.48	70.00	-21.53	Peak
4.87	46.14	174.00	1.40	h	32.20	4.13	32.49	49.98	70.00	-20.03	Peak
4.87	31.35	185.00	1.70	v	32.20	4.13	32.49	35.19	50.00	-14.82	Ave
4.87	32.25	174.00	1.40	h	32.20	4.13	32.49	36.09	50.00	-13.92	Ave
2.484	44.84	187.00	2.40	v	27.50	2.50	32.04	42.80	74.00	-31.20	Peak
2.484	44.46	137.00	1.50	h	27.50	2.50	32.04	42.42	74.00	-31.58	Peak
2.484	29.06	187.00	2.40	v	27.50	2.50	32.04	27.02	54.00	-26.98	Ave
2.484	29.76	137.00	1.50	h	27.50	2.50	32.04	27.72	54.00	-26.28	Ave

Note: Emission was scanned up to 25GHz; no emissions were detected above the noise floor which was at least 20dB below the specification limit

Annex A. TEST INSTRUMENT & METHOD

Annex A.i. TEST INSTRUMENTATION & GENERAL PROCEDURES

Instrument	Model	
AC Conducted Emissions		
R&S EMI Test Receiver	ESIB40	05/19/2012
R&S LISN	ESH2-Z5	05/18/2012
CHASE LISN	MN2050B	05/18/2012
Universal Radio Communication Tester	CMU200	02/22/2012
Radiated Emissions		
Spectrum Analyzer	8564E	05/19/2012
EMI Receiver	ESIB 40	05/18/2012
R&S LISN	ESH2-Z5	05/18/2012
CHASE LISN	MN2050B	05/19/2012
Antenna(1 ~18GHz)	3115	6/2/2012
Antenna (30MHz~2GHz)	JB1	6/1/2012
Chamber	3m	12/4/2012
Pre-Amplifier(1 ~ 26GHz)	8449	5/17/2012
Horn Antenna (18~40GHz)	AH-840	7/23/2012
Microwave Pre-Amp (18~40GHz)	PA-840	Every 2000 Hours
Environmental Monitoring		
Sekonic Hygro Hermograph	HE01-000092	06/04/2012

Note: Functional Verification

Annex A.ii. CONDUCTED EMISSIONS TEST DESCRIPTION

Test Set-up

1. The EUT and supporting equipment were set up in accordance with the requirements of the standard on top of a 1.5m x 1m x 0.8m high, non-metallic table, as shown in Annex B.
2. The power supply for the EUT was fed through a 50Ω/50μH EUT LISN, connected to filtered mains.
3. The RF OUT of the EUT LISN was connected to the EMI test receiver via a low-loss coaxial cable.
4. All other supporting equipments were powered separately from another main supply.

Test Method

1. The EUT was switched on and allowed to warm up to its normal operating condition.
2. A scan was made on the NEUTRAL line (for AC mains) or Earth line (for DC power) over the required frequency range using an EMI test receiver.
3. High peaks, relative to the limit line, were then selected.
4. The EMI test receiver was then tuned to the selected frequencies and the necessary measurements made with a receiver bandwidth setting of 10 KHz. For FCC tests, only Quasi-peak measurements were made; while for CISPR/EN tests, both Quasi-peak and Average measurements were made.
5. Steps 2 to 4 were then repeated for the LIVE line (for AC mains) or DC line (for DC power).

Sample Calculation Example

At 20 MHz	limit = 250 μV = 47.96 dBμV
Transducer factor of LISN, pulse limiter & cable loss at 20 MHz = 11.20 dB	
Q-P reading obtained directly from EMI Receiver = 40.00 dBμV	
	(Calibrated for system losses)
Therefore, Q-P margin = 47.96 – 40.00 = 7.96	i.e. 7.96 dB below limit

Annex A. iii RADIATED EMISSIONS TEST DESCRIPTION

EUT Characterisation

EUT characterisation, over the frequency range from 30MHz to 1GHz (for FCC tests, until the 5th harmonic for operating frequencies \geq 108MHz), was done in order to minimise radiated emissions testing time while still maintaining high confidence in the test results.

The EUT was placed in the chamber, at a height of about 0.8m on a turntable. Its radiated emissions frequency profile was observed, using a spectrum analyzer /receiver with the appropriate broadband antenna placed 3m away from the EUT. Radiated emissions from the EUT were maximised by rotating the turntable manually, changing the antenna polarisation and manipulating the EUT cables while observing the frequency profile on the spectrum analyzer / receiver. Frequency points at which maximum emissions occurred, clock frequencies and operating frequencies were then noted for the formal radiated emissions test at the Open Area Test Site (OATS).

Test Set-up

1. The EUT and supporting equipment were set up in accordance with the requirements of the standard on top of a 1.5m X 1.0m X 0.8m high, non-metallic table as shown in Annex B.
2. The filtered power supply for the EUT and supporting equipment were tapped from the appropriate power sockets located on the turntable.
3. The relevant broadband antenna was set at the required test distance away from the EUT and supporting equipment boundary.

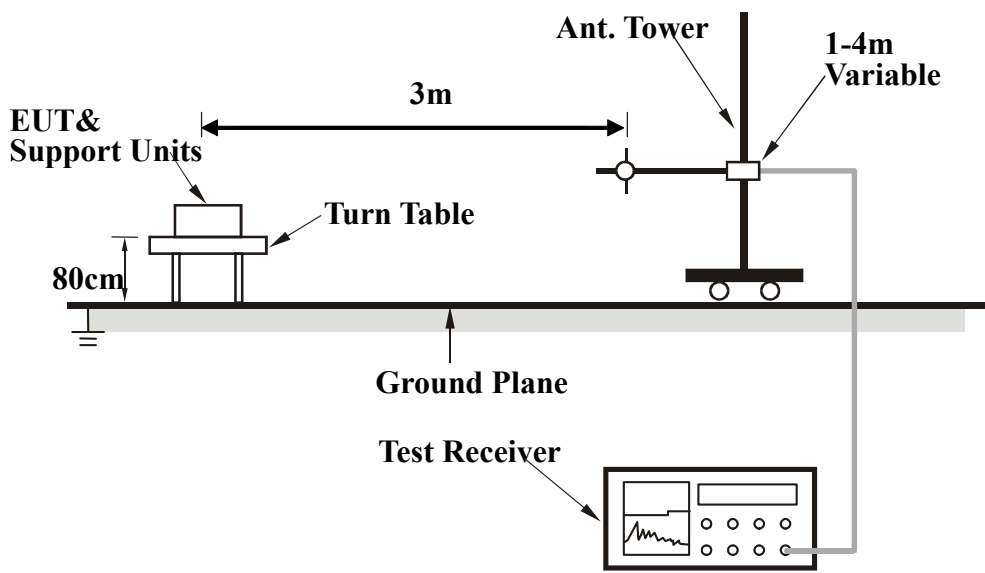

Test Method

The following procedure was performed to determine the maximum emission axis of EUT:

1. With the receiving antenna is H polarization, rotate the EUT in turns with three orthogonal axes to determine the axis of maximum emission.
2. With the receiving antenna is V polarization, rotate the EUT in turns with three orthogonal axes to determine the axis of maximum emission.
3. Compare the results derived from above two steps. So, the axis of maximum emission from EUT was determined and the configuration was used to perform the final measurement.

Final Radiated Emission Measurement

1. Setup the configuration according to figure 1. Turn on EUT and make sure that it is in normal function.
2. For emission frequencies measured below 1 GHz, a pre-scan is performed in a shielded chamber to determine the accurate frequencies of higher emissions will be checked on a open test site. As the same purpose, for emission frequencies measured above 1 GHz, a pre-scan also be performed with a 1 meter measuring distance before final test.
3. For emission frequencies measured below and above 1 GHz, set the spectrum analyzer on a 100 kHz and 1 MHz resolution bandwidth respectively for each frequency measured in step 2.
4. The search antenna is to be raised and lowered over a range from 1 to 4 meters in horizontally polarized orientation. Position the highness when the highest value is indicated on spectrum analyzer, then change the orientation of EUT on test table over a range from 0 ° to 360 ° with a speed as slow as possible, and keep the azimuth that highest emission is indicated on the spectrum analyzer. Vary the antenna position again and record the highest value as a final reading.
5. Repeat step 4 until all frequencies need to be measured were complete.
6. Repeat step 5 with search antenna in vertical polarized orientations.

During the radiated emission test, the Spectrum Analyzer was set with the following configurations:

Frequency Band (MHz)	Function	Resolution bandwidth	Video Bandwidth
30 to 1000	Peak	100 kHz	100 kHz
Above 1000	Peak	1 MHz	1 MHz
	Average	1 MHz	10 Hz

Sample Calculation Example

The field strength is calculated by adding the Antenna Factor and Cable Factor, and subtracting the Amplifier Gain (if any) from the measured reading. For the limit is employed average value, therefore the peak value can be transferred to average value by subtracting the duty factor. The basic equation with a sample calculation is as follows:

$$\text{Peak} = \text{Reading} + \text{Corrected Factor}$$

Where:

$$\text{Corr. Factor} = \text{Antenna Factor} + \text{Cable Factor} - \text{Amplifier Gain (if any)}$$

And the average value is

$$\text{Average} = \text{Peak Value} + \text{Duty Factor or}$$

$$\text{Set RBW} = 1\text{MHz, VBW} = 10\text{Hz.}$$

Note:

If the measured frequencies are fall in the restricted frequency band, the limit employed must be quasi peak value when frequencies are below or equal to 1 GHz. And the measuring instrument is set to quasi peak detector function.

Annex B EUT AND TEST SETUP PHOTOGRAPHS

Please see the attachment

Annex C. TEST SETUP AND SUPPORTING EQUIPMENT

EUT TEST CONDITIONS

Annex C. i. SUPPORTING EQUIPMENT DESCRIPTION

The following is a description of supporting equipment and details of cables used with the EUT.

Equipment Description (Including Brand Name)	Model & Serial Number	Cable Description (List Length, Type & Purpose)
PC Laptop / DELL	Latitude D600	USB Cable & Serial Cable < 1 meter (From PC to EUT)

Block Configuration Diagram for Radiated Emission

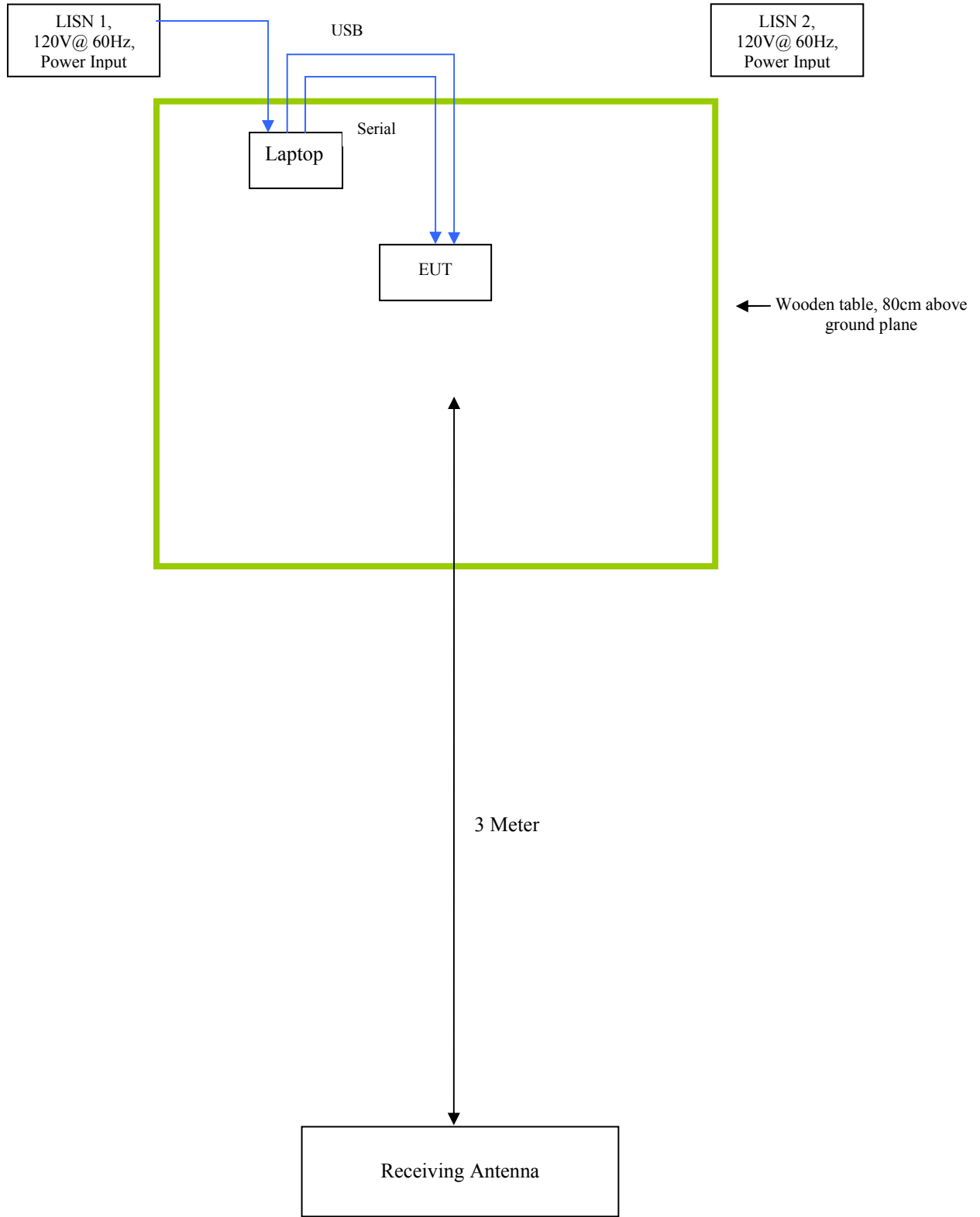

Block Configuration Diagram for Conducted Emission

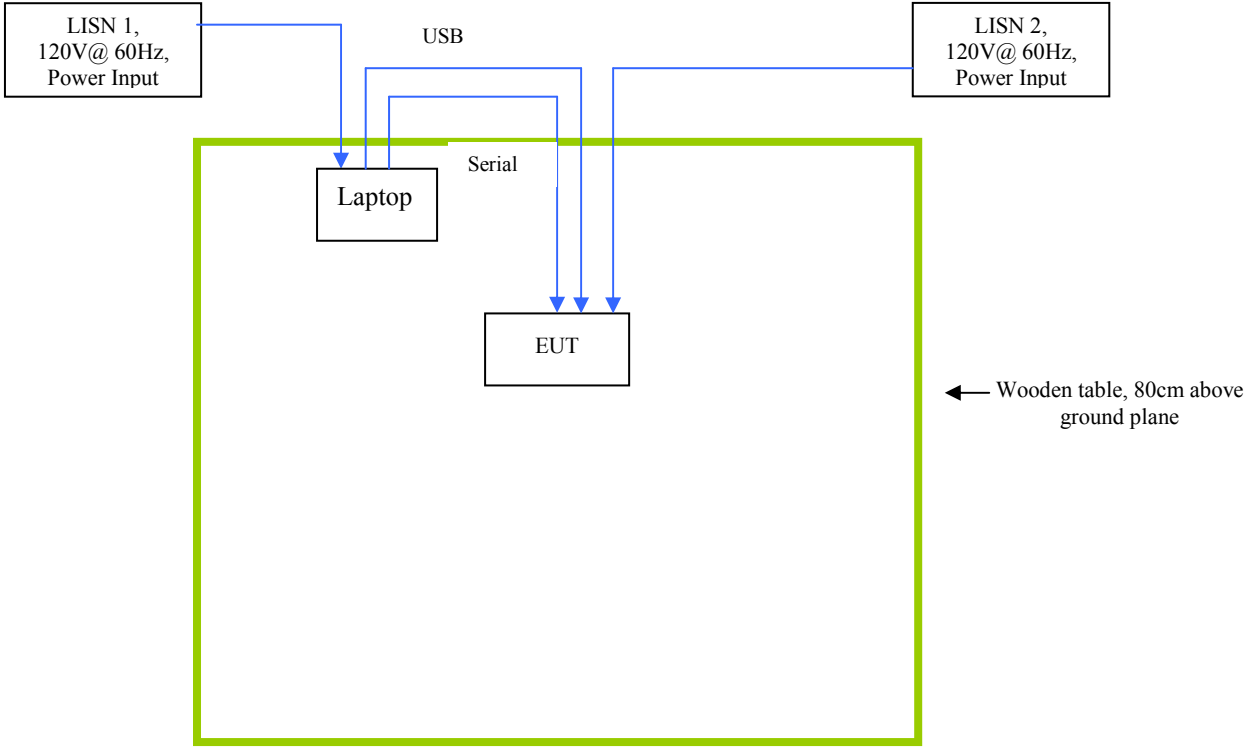

Annex C.ii. EUT OPERATING CONDITIONS

The following is the description of how the EUT is exercised during testing.

Test	Description Of Operation
Emissions Testing	The EUT was continuously transmitting controlled via usb connection to PC Laptop using test program.
Others Testing	The EUT was continuously transmitting controlled via usb connection to PC Laptop using test program.

Annex D User Manual, Block Diagram, Circuit Diagram

Please see attachment

Annex E SIEMIC ACCREDITATION

SIEMIC ACREDITATION DETAILS: A2LA 17025 & ISO Guide 65 : 2742.01 , 2742.2



The American Association for Laboratory Accreditation
World Class Accreditation

Accredited Laboratory

A2LA has accredited

SIEMIC LABORATORIES
San Jose, CA
for technical competence in the field of
Electrical Testing

This laboratory is accredited in accordance with the recognized International Standard ISO/IEC 17025:2005 *General Requirements for the Competence of Testing and Calibration Laboratories*. This accreditation demonstrates technical competence for a defined scope and the operation of a laboratory quality management system (refer to joint ISO-ILAC-LAF Communiqué dated 8 January 2009).

Presented this 23rd day of November 2010.



Peter Noyes
President & CEO
For the Accreditation Council
Certificate Number 2742.01
Valid to September 30, 2012

For the tests or types of tests to which this accreditation applies, please refer to the laboratory's Electrical Scope of Accreditation.



The American Association for Laboratory Accreditation

SCOPE OF ACCREDITATION TO ISO/IEC 17025:2005

SIEMIC LABORATORIES¹
2206 Ringwood Ave.
San Jose, CA 95131
Mr. Leslie Bai Phone: 408 526 1188 Email: leslie.bai@siemic.com
Mr. Snell Leong Phone: 408 526 1188 Email: snell.leong@siemic.com
www.siemic.com

ELECTRICAL

Valid to: September 30, 2012

Certificate Number: 2742.01

In recognition of the successful completion of the A2LA evaluation process, accreditation is granted to this laboratory to perform the following EMC, Product Safety, Radio and Telecommunication tests:

Test Description:	Test Method:
EN & IEC – Emissions & Immunity	IEC/CISPR 11; IEC/CISPR 12; EN 55011; IEC/CISPR 22; EN 55022; IEC/CISPR 20; EN 55020; EN 61000-6-1; EN 61000-6-2; EN 61000-6-3; EN 61000-6-4; EN 61204-3; EN 61326, EN 61326-1; EN 61000-3-2; EN 61000-3-3; EN 50081-1, EN 50081-2; EN 50082-1; IEC 61000-4-2; EN 61000-4-2; IEC 61000-4-3 (limited up to 2.7 GHz and 3V/m); EN 61000-4-3; (limited up to 2.7 GHz and 3V/m); IEC 61000-4-4; EN 61000-4-4; IEC 61000-4-5; EN 61000-4-5; IEC 61000-4-6; EN 61000-4-6; IEC 61000-4-8; EN 61000-4-8; IEC 61000-4-11; EN 61000-4-11; IEC/CISPR 24; EN 55024; EN 50412-2-1; EN 50083-2; EN 50090-2-2; EN 50091-2; EN 50130-4; EN 50130-4 +A12; IEC 60601-1-2; EN 12184; EN 55015; EN 61547; CISPR 16-1-4
Korea – Emissions & Immunity	KCC Notice 2009-27, Nov. 5, 2009; RRA Announce 2009-9, Dec. 21, 2009; KN 22:2007-12; KCC Notice 2009-27, Nov. 5, 2009; RRA Notice 2009-10, Dec. 21, 2009; KN 24:2008-5; KN 61000-4-2:2008-5; KN 61000-4-3:2008-5; KN 61000-4-4:2008-5; KN 61000-4-5:2008-5; KN 61000-4-6:2008-5; KN 61000-4-8:2008-5; KN 61000-4-11:2008-5; RRL Notice 2008-3; RRL Notice 2008-4; RRL Notice 2005-131; RRL Notice 2007-99; RRL Notice 2007-101; RRL Notice 2008-4; RRA Notice No 2008-11(2008.12.16); RRA Notice No 2008-12(2008.12.16); KN 60601-1-2; KCC Notice 2009-27; KN 301 489-1(2008-05); KN 301 489-7(2008-05); KN 301 489-17(2008-05); KN 301 489-24(2008-05); KN 16-1-1(2008-05); KN 16-1-2(2008-05); KN 16-1-3(2008-05); KN 16-1-4(2008-05); KN 16-1-5(2008-05); KN 16-2-1(2008-05); KN 16-2-2(2008-05); KN 16-2-3(2008-05); KN 16-2-4(2008-05)

(A2LA Certificate No. 2742.01) 11/23/2010

Page 1 of 7



FCC – Emissions	ANSI C63.17:2006; ANSI C63.4(2003) with FCC Method 47 CFR Part 11; ANSI C63.4(2003) with FCC Method 47 CFR Part 15, Subpart E; ANSI C63.4(2003) with FCC Method 47 CFR Part 15, Subpart C; ANSI C63.4(2003) and DA 02-2138; ANSI C63.4(2003) with FCC Method 47 CFR Part 15, Subpart B; ANSI C63.4(2009); ANSI C63.10(2009); FCC Method 47 CFR Part 18, FCC OST/MP-5(1986); FCC Report and Order ET Docket 98-153 (FCC 02-48); FCC Method 47 CFR Part 15, Subpart G, using FCC Order 04-425; FCC Method 47 CFR Parts 11 (Emergency Alert System (EAS)), 15 (Radio Frequency Devices) and 18 (Industrial, Scientific, and Medical Equipment); SAE J1113-11, SAE J1113-12; SAE J1113-41; SAE J1113-4; SAE J1113-13
Canada – Emissions	ICES-001; ICES-002; ICES-003 Issue 4; ICES-003 Issue 4 (2004); ICES-006 Issue 1
Vietnam – Emission & Immunity	TCN 68-193:2003; TCN 68-196:2001; TCVN 7189:2002
Australia / New Zealand – Emissions and Immunity	AS/NZS 1044; AS/NZS 4251.1; AS/NZS 4251.2; AS/NZS CISPR 22; AS/NZS 3548; AS/NZS 2279.3; AS/NZS 61000-3-3; AS/NZS CISPR 11; AS/NZS CISPR 24; AS/NZS 61000.6.3; AS/NZS 61000.6.4; AS/NZS CISPR 14.1; AS/NZS 61000.3.2
Japan – Emissions	JEITA IT-3001; VCCI-V-3:2010.4 (up to 6 GHz)
China – Emissions	GB9254; GB17625.1
Taiwan – Emissions	CNS 13438 (up to 6 GHz); CNS 13783-1; CNS 13803; CNS 13439
Singapore – Emissions & Immunity	IDA TS EMC; CISPR 22; IEC 61000-4-2; IEC 61000-4-3; IEC 61000-4-4; IEC 61000-4-5; IEC 61000-4-6
FCC – Radio TIA/EIA 603-C with 47 CFR Part 2	Maritime and Aviation Radio Services in 47 CFR Parts 80 and 87; Personal Mobile Radio Services in 47 CFR Parts 22 (cellular), 24, 25, 26, and 27; Personal Mobile Radio Services in 47 CFR Part 22 (cellular) and Part 24 – [limited to TX conducted and radiated power and RX - TX radiated spurious emissions]; General Mobile Radio Services in 47 CFR Parts 22 (non-cellular), 74, 90, 95, and 97; General Mobile Radio Services in 47 CFR Part 90; Microwave Radio Services in 47 CFR Parts 21, 27, 74, and 101
Canada – Radio	RSS 102; RSS 111; RSS 112; RSS 117; RSS 118; RSS 119; RSS 123; RSS 125; RSS 127; RSS 128; RSS 129; RSS 131; RSS 132; RSS 133; RSS 134; RSS 135; RSS 136; RSS 137; RSS 138; RSS 139; RSS 141; RSS 142; RSS 170; RSS 181; RSS 182; RSS 188; RSS 191; RSS 192; RSS 193; RSS 194; RSS 195; RSS 196; RSS 197; RSS 198; RSS 199; RSS 210; RSS 220; RSS 213; RSS 215; RSS 243; RSS 287; RSS 310; RSS Gen



SIEMIC, Inc.

Accessing global markets

Title: RF Test Report of Zebra Technologies Corp
Model : ZComax XG-182Z 802.11 b/g radio
To FCC 15.247:2010 & RSS-210 Issue8 : 2010

Serial# SL11050402-ZBR-029
Issue Date Jun 13 2011
Page 41 of 61
www.siemic.com

CE – Radio	<p>EN 301 502; EN 301 511; EN 301 526; EN 301 681; EN 301 721; EN 301 751; EN 301 753; EN 301 783-2; EN 301 796; EN 301 797; EN 301 840-2; EN 301 843-1; EN 301 843-4; EN 301 843-5; EN 301 893; EN 301 908-01; EN 301 908-02; EN 301 908-03; EN 301 908-04; EN 301 908-05; EN 301 908-06; EN 301 908-07; EN 301 908-08; EN 301 908-09; EN 301 908-10; EN 301 908-11; EN 301 929-2; EN 301 997-2; EN 302 018-2; EN 302 054-2; EN 302 064-2; EN 302 066-2; EN 302 077-2; EN 302 186; EN 302 195-2; EN 302 217-3; EN 302 245-2; EN 302 288-2; EN 302 291-2; EN 302 296; EN 302 297; EN 302 326-2; EN 302 326-3; EN 302 340; EN 302 372-2; EN 302 426; EN 302 454-2; EN 302 502; EN 302 510-2; EN 302 217-4-2; EN 300 224-1; EN 300 279; EN 300 339; EN 300 385; EN 301 839-2; EN 301 843-6; EN 302 017-2; EN 302 208-2; EN 302 217-2-2; ETS 300 329; ETS 300 445; ETS 300 446; ETS 300 683; ETS 300 826; ETS EN 300 328; ETSI EN 300 086-2; EN 302217-1; EN 302217-2-1; EN 302217-4-1; EN 302288-1; EN 302908-12; EN 302326-1; EN 301929-1; EN 301997-1; EN 300224-2; EN 301839-1; EN 301843-1; EN 301843-2; EN 301843-3; EN 301843-4; EN 301843-5; EN 302017-1; EN 302208-1; EN 300086-1; EN 300113-1; EN 300224-1; EN 300341-1; EN 302291-1; EN 302500-1; EN 302500-2; ETSI EN 300 113-2; ETSI EN 300 197; ETSI EN 300 198; ETSI EN 300 219-1; ETSI EN 300 219-2; ETSI EN 300 220-1; ETSI EN 300 220-2; ETSI EN 300 220-3; ETSI EN 300 224-2; ETSI EN 300 296-1; ETSI EN 300 296-2; ETSI EN 300 328-1; ETSI EN 300 328-2; ETSI EN 300 330; ETSI EN 300 330-1; ETSI EN 300 330-2; ETSI EN 300 341-2; ETSI EN 300 373-1; ETSI EN 300 373-2; ETSI EN 300 373-3; ETSI EN 300 390-1; ETSI EN 300 390-2; ETSI EN 300 422-1; ETSI EN 300 422-2; ETSI EN 300 431; ETSI EN 300 440-1; ETSI EN 300 440-2; ETSI EN 300 454-1; ETSI EN 300 454-2; ETSI EN 300 718-2; ETSI EN 301 021; ETSI EN 301 166-1; ETSI EN 301 166-2; ETSI EN 301 178-2; ETSI EN 301 213-1; ETSI EN 301 213-2; ETSI EN 301 213-3; ETSI EN 301 213-4; ETSI EN 301 213-5; ETSI EN 301 357-1; ETSI EN 301 357-2; ETSI EN 301 390; ETSI EN 301 459; ETSI EN 301 489-01(excluding section 9.6); ETSI EN 301 489-02; ETSI EN 301 489-03; ETSI EN 301 489-04; ETSI EN 301 489-05; ETSI EN 301 489-06; ETSI EN 301 489-07; ETSI EN 301 489-08; ETSI EN 301 489-09; ETSI EN 301 489-10; ETSI EN 301 489-11; ETSI EN 301 489-12; ETSI EN 301 489-13; ETSI EN 301 489-14; ETSI EN 301 489-15; ETSI EN 301 489-16; ETSI EN 301 489-17; ETSI EN 301 489-18; ETSI EN 301 489-19; ETSI EN 301 489-20; ETSI EN 301 489-22; ETSI EN 301 489-23; ETSI EN 301 489-24; ETSI EN 301 489-25; ETSI EN 301 489-26; ETSI EN 301 489-27; ETSI EN 301 489-28; ETSI EN 301 489-31; ETSI EN 301 489-32; IEC 60945</p>
IDA – Radio	<p>IDA TS 3G-BS; IDA TS 3G-MT; IDA TS AR; IDA TS CT-CTS; IDA TS GMPCS; IDA TS GSM-BS; IDA TS GSM-MT; IDA TS LMR; IDA TS RPG; IDA TS SRD; IDA TS UWB; IDA TS WBA</p>
Vietnam – Radio	<p>TCN 68-242:2006; TCN 68-243:2006; TCN 68-246:2006</p>



Korea – Radio	KCC Notice 2009-13; KCC Notice 2008-26; RRL Notice 2008-2; RRL Notice 2005-105; RRL Notice 2008-17; RRL Notice 2005-127; RRL Notice 2005-24; RRL Notice 2005-25; RRL Notice 2005-179; RRL Notice 2008-10; RRL Notice 2007-49; RRL Notice 2007-20; RRL Notice 2007-11; RRL Notice 2007-80; RRL Notice 2004-68; KCC Notice 2009-36, Dec. 8, 2009; RRL Notice 2009-6, October 15, 2009; KCC Notice 2010-1; KCC Notice 2010-12; KCC Notice 2010-13
Taiwan – Radio	LP0002; PLMN07; PLMN01; PLMN08
Australia - New Zealand – Radio	AS 2772.2; AS/NZS 4281; AS/NZS 4268; AS/NZS 4280.1; AS/NZS 4583; AS/NZS 4280.2; AS/NZS 4281; AS/NZS 4295; AS/NZS 4582; AS/NZS 4769.1; AS/NZS 4769.2; AS/NZS 4770; AS/NZS 4771
Hong Kong – Radio	HKTA 1002; HKTA 1007; HKTA 1008; HKTA 1010; HKTA 1015; HKTA 1016; HKTA 1020; HKTA 1022; HKTA 1026; HKTA 1027; HKTA 1029; HKTA 1030; HKTA 1031; HKTA 1032; HKTA 1033; HKTA 1034; HKTA 1035; HKTA 1036; HKTA 1037; HKTA 1039; HKTA 1041; HKTA 1042; HKTA 1043; HKTA 1044; HKTA 1046; HKTA 1047; HKTA 1048; HKTA 1049; HKTA 1051; HKTA1052; HKTA1053; HKTA 1054; HKTA 1055
USA – Telecom	ANSI/TIA-968-A:03; ANSI/TIA-968-A-1:03; ANSI/TIA-968-A-2:04; ANSI/TIA-968-A-3:05; ANSI/TIA-968-A-4:07; ANSI/TIA-968-A-5:07; TIA-968-B; FCC Rule Part 68; 47 CFR Part 68.316; 47 CFR Part 68.317; ANSI/TIA/EIA-464-C; TIA-810-B; T1.TRQ6 (2002); TCB-31-B (1998); TIA-470.110-C; TIA-810-B; TIA-920
Canada – Telecom	CS-03 Part V Issue 9:2009 Amendment 1; CS-03 Part VIII Issue 9:2009 Amendment 4; CS-03 Part I Issue 9:2006 Amendment 3; CS-03 Part II Issue 9:2004; CS-03 Part III Issue 9:2004; CS-03 Part V Issue 9:2004 ; CS-03 Part VI Issue 9:2004; CS-03 Part VII Issue 9:2006 Amendment 3; CS-03 Part VIII Issue 9:2007 Amendment 3; CS-03 Issue 9:04 + A2(06) + A3(06)
Europe – Telecom	TBR 2: 01-1997; TBR 004 Ed.1.95 + A1 (97); TBR 1; TBR 3; TBR 12:A1 01-1996; TBR 013 ed.1; TBR 024 ed.1; TBR 25; TBR 38 ed.1; ETSI ES 203 021-05 ; ETSI ES 203 021-2 ; ETSI ES 021-3; TBR 021; ETSI EG 201 121; ETSI EN 301 437; ETSI TS 101 270-1; ITU-T Recommendation Q.920; ITU-T Recommendation Q.920 – Amendment 1; ITU-T Recommendation Q.921; ITU-T Recommendation Q.921 – Amendment 1; ITU-T Recommendation Q.931; ITU-T Recommendation Q.931 – Amendment 1; Erratum 1 (02/2003) ITU-T Recommendation Q.931 (05/1998); ISDN User Network Interface Layer 3 Specification for Basic Call Control; ITU-T Recommendation P.300
Australia – Telecom	AS/CA S003.1:2010; AS/CA S003.2:2010; AS/CA S003.3:2010; AS/CA S004:2010; AS/ACIF S006:2008; AS/ACIF S041.1:2009



Australia – Telecom	AS/ACIF S041.2:2009; AS/ACIF S041.3:2009; AS/ACIF S042.1:2008; AS/ACIF S043.2:2008; AS/ACIF S043.3:2008; AS/ACIF S002:05; AS/ACIF S003:06; AS/ACIF S004:06; AS/ACIF S006:01; AS/ACIF S016:01; AS/ACIF S031:01; AS/ACIF S038:01; AS/ACIF S040:01; AS/ACIF S041:05; AS/ACIF S043.2:06; AS ACIF S042.1
New Zealand – Telecom	PTC200:2006; PTC200 Issue No.2:97 + A1(980); PTC220; PTC273:2007; TNA 115; TNA 117
Singapore – Telecom	IDA TS ADSL, Issue 1, Rev. 1 (April 2006); IDA TS DLCN, Issue 1 (July 2005); IDA TS ISDN BA, Issue 1 (July 2005); IDA TS ISDN PRA, Issue 1 (July 2005); IDA TS ISDN 3 (Oct. 2000); IDA TS-PSTN, Issue 1 (March 2007); IDA TS ACLIP 07
Hong Kong – Telecom	HKTA 2011; HKTA 2012; HKTA 2013; HKTA 2014; HKTA 2017; HKTA 2018; HKTA 2022; HKTA 2024; HKTA 2026; HKTA 2027; HKTA 2028; HKTA 2029; HKTA 2030; HKTA 2031; HKTA 2032; HKTA 2033
Vietnam – Telecom	TCN 68-188:2000; TCN 68-193:2003; TCN 68-196:2001; TCN 68-143:2003; TCN 68-192:2003; TCN 68-189:2000; TCN 68-221:2004; TCN 68-222:2004; TCN 68-245:2004; TCN 68-223:2004
Korea – Telecom	RRA Notice 2009-38, Sep. 11, 2009; RRA Notice 2009-7 (including attachments 1, 3, 5, 6); Presidential Decree 21098, RRL Notice 2007-30; RRL Notice 2008-10 (attachments 1, 3, 5, 6); RRL Notice 2009-25; RRL Notice 2008-59
China – Telecom	YD/T 514-1:98; YD/T 1277.1-2003; GB/T 17904.1-1999; GB/T 17904.2-1999; GB/T 17154.1-1997; GB/T 17154.2-1997; YD/T1091-2000; YD/T1006-1999; GB/T 17789-1999
Taiwan – Telecom	PSTN01:03; ADSL01:08; ID0002; IS6100: 93
Japan – Telecom	JATE Blue Book, Green Book; Ministerial Ordinance of the Ministry of Posts and Telecommunications No. 31 of April 1, 1985 (last amended on March 22 2004); Ordinance Concerning Technical Conditions Compliance Approval etc. of Terminal Equipment
South Africa – Telecom	DPT-TE-001; TE-002; TE-003; TE-004; TE-005; TE-006; TE-007; TE-008; TE-009; TE-010; TE-012 (telephone interface); TE-013 (telephone interface); TE-014; TE-015; TE-018; SWS-001; SWS-002; SWS-003; SWS-004; SWS-005; SWS-006; SWS-007; SWS-008; SWS-009; SWS-010
Israel – Telecom	Israel MoC Spe. 23/96



Mexico – Telecom	NOM-151-SCT1-1999; NOM-152-SCT1-1999
Argentina – Telecom	CNC-ST2-44-01
Brazil – Telecom	Resolution 392-2005
International Telecom Union	ITU-T-G.703-01; ITU-T-G.823-93; ITU-T G.824; ITU-T G.825; ITU-T-G.991.2; ITU-T-G.992.1; ITU-T-G.992.3; ITU-T-G.992.5; ITU-T-G.993.1
Product Safety	IEC 60950-1; EN 60950-1; UL 60950-1; IEC 60601-1-1; CAN/CSA 22.2 NO. 60950-1-03; SS-EN 60950-1; AS/NZ 60950-1; (voltage surge testing up to 6kV, excluding Annex A and H); CNS 14336, CNS 14408; GB4943; President Notice 20664; RRL Notice 2008-10 (attachment 4); RRA Notice 2009-7 (attachment 4); TCN 68-190:2003; SABS IEC 60950; IEC/EN 61558; IEC/EN 61558-2-7; EN 62115; IEC 60215; EN 60958; EN 60598; IEC 215 (1987) + A1 (1992) + A2 (1994)
Japan - Radio	ARIB STD-T81; ARIB STD-T66; RCR STD-1; RCR STD-29; ARIB STD-T94 Fascicle 1; ARIB STD-T90; ARIB STD-T89; RCR STD-33
SAR & HAC	IEEE P1528:2003 + Ad1; IEEE 1528A:2005; FCC OET Bulletin 65 Supplement C; FCC OET Bulletin 65; ANSI C95; ANSI C63.19; FCC 47 CFR 20.19; H46-2/99-273E; EN 50360; EN 50361; IEC62209-1; IEC 62209-2; EN 50371; EN 50383; EN 50357; EN 50364; RRL 2008-18; RRL 2008-16; KCC 2009-27; RRL 2004-67; CNS 14959; NZS 2772.1; NZS 6609.2; Resolution N 533
Japan – Notification No. 88 of MIC 2004	
Table No 13	CB Radio
Table No 21	Cordless Telephone
Table Nos 22-1 thru 22-17	Low Power Radio Equipment
Table No 36	Low Power Security System
Table No 43	Low Power Data Communication in the 2.4 GHz Band
Table No 44	Low Power Data Communication in the 2.4 GHz Band
Table No 45	Low Power Data Communication in the 5.2, 5.3, 5.6 GHz Bands
Table No 46	Low Power Data Communication in the 25 and 27 GHz Bands
Table No 47	Base Station for 5 GHz Band Wireless Access System
Table No 47	Base Station for 5 GHz Band Wireless Access System (low spurious type)
Table No 47	Land Mobile Relay for 5 GHz Band Wireless Access System (limited for use in special zones)



Table No 47	Land Mobile Relay for 5 GHz Band Wireless Access System (limited for use in special zones, low spurious type)
Table No 47	Land Mobile Relay for 5 GHz Band Wireless Access System
Table No 47	Land Mobile Relay for 5 GHz Band Wireless Access System (low spurious type)
Table No 47	Land Mobile Relay for 5 GHz Band Wireless Access System (low power type)
Table No 50	Digital Cordless Telephone
Table No 50	PHS Base Station
Table No 50	PHS Land Mobile Station
Table No 50	PHS Relay Station
Table No 50	PHS Test Station
Table No 64	Mobile Station for Dedicated Short Range Communication Systems
Table No 64	Base Station for Dedicated Short Range Communication Systems
Table No 64	Test Station for Dedicated Short Range Communication Systems
Table No 70	UWB (Ultra Wide Band) Radio System

¹Note: This accreditation covers testing performed at the laboratory listed above and the OATS located at 44366 South Grimmer Blvd., Fremont CA 94538. At this site "Radiated Emissions" are tested at a measurement distance of 10m.

*Limitations for listed standards are indicated by italics and Scope excludes protocol sections of applicable standards.



The American Association for Laboratory Accreditation

World Class Accreditation

Accredited Product Certification Body

A2LA has accredited

SIEMIC LABORATORIES

San Jose, CA

for technical competence as a

Product Certification Body

This product certification body is accredited in accordance with the recognized International Standard ISO/IEC Guide 65:1996 *General requirements for bodies operating product certification systems*. This accreditation demonstrates technical competence for a defined scope and the operation of a quality management system for a Telecommunications Certification Body (TCB) meeting FCC (U.S.), IDA (Singapore), IC (Canada) and OFTA Hong Kong requirements.



Presented this 23rd day of November 2010.

President & CEO
For the Accreditation Council
Certificate Number 2742.01
Valid to September 30, 2012

For the product certification schemes to which this accreditation applies, please refer to the organization's Product Certification Scope of Accreditation.



SIEMIC, Inc.

Accessing global markets

Title: RF Test Report of Zebra Technologies Corp
Model : ZComax XG-182Z 802.11 b/g radio
To: FCC 15.247:2010 & RSS-210 Issue8 : 2010

Serial# SL11050402-ZBR-029
Issue Date Jun 13 2011
Page 47 of 61
www.siemic.com



The American Association for Laboratory Accreditation

SCOPE OF ACCREDITATION TO ISO/IEC GUIDE 65:1996

SIEMIC INC.
2206 Ringwood Ave.
San Jose, CA 95131

Mr. Snell Leong (Authorized Representative) Phone: 408 526 1188
www.siemic.com

PRODUCT CERTIFICATION CONFORMITY ASSESSMENT BODY (CAB)

Valid to: September 30, 2012

Certificate Number: 2742.02

In recognition of the successful completion of the A2LA Certification Body Accreditation Program evaluation, including the US Federal Communications Commission (FCC), Industry Canada (IC), Singapore (IDA) and Hong Kong (OFTA) requirements for the indicated types of product certifications, accreditation is granted to this organization to perform the following product certification schemes:

Economy Scope

Federal Communication Commission - (FCC)

Unlicensed Radio Frequency Devices	A1, A2, A3, A4
Licensed Radio Frequency Devices	B1, B2, B3, B4
Telephone Terminal Equipment	C

**Please refer to FCC TCB Program Roles and Responsibilities, released July 22, 2010 detailing scopes, roles and responsibilities. <http://fallfoss.fcc.gov/oetcf/kdb/forms/FTSSearchResultPage.cfm?id=44683&switch=P>*

Industry Canada - (IC)

Radio	Scope 1-Licence-Exempt Radio Frequency Devices; Scope 2-Licensed Personal Mobile Radio Services; Scope 3-Licensed General Mobile & Fixed Radio Services; Scope 4-Licensed Maritime & Aviation Radio Services; Scope 5-Licensed Fixed Microwave Radio Services;
-------	--

**Please refer to Industry Canada (IC) website at: <http://www.ic.gc.ca/etc/site/smt-gst.nsf/eng/sf09888.html>*

IDA – Singapore

Line Terminal Equipment	All Technical Specifications for Line Terminal Equipment – Table 1 of IDA MRA Recognition Scheme: 2009, Annex 2
Radio-Communication Equipment	All Technical Specifications for Radio-Communication Equipment – Table 2 of IDA MRA Recognition Scheme: 2009, Annex 2

**Please refer to Info-Communication Development Authority (IDA) Singapore website at: http://www.ida.gov.sg/doc/Policies%20and%20Regulation/Policies_and_Regulation_Level2:20060609145118/MRARecScheme.pdf*

(A2LA Cert. No. 2742.02) 11/23/2010

Peter Whyte Page 1 of 2



OFTA – Hong Kong

Radio Equipment

HKTA 1001, 1002, 1003, 1004, 1005, 1006, 1007, 1008,
1009, 1010, 1015, 1016, 1019, 1020, 1022, 1026, 1027,
1029, 1030, 1031, 1032, 1033, 1034, 1035, 1036, 1037,
1038, 1039, 1041, 1042, 1043, 1044, 1045, 1046, 1047,
1048, 1049, 1050, 1051, 1052, 1053, 1054, 1055

**Please refer to the Office of the Telecommunications Authority's website at:
<http://www.ofta.gov.hk/en/standards/HKTASpec/hkta-10xx.html>*

Fixed Network Equipment

HKTA 2001, 2005, 2011, 2012, 2013, 2014, 2015, 2016,
2017, 2018, 2019, 2020, 2021, 2022, 2023, 2024, 2025,
2026, 2027, 2028, 2029, 2030, 2031, 2032, 2033, 2034,
2035, 2036, 2037, 2040, 2041, 2102, 2103,
2104, 2108, 2201, 2202, 2203, 2204

**Please refer to the Office of the Telecommunications Authority's website at:
<http://www.ofta.gov.hk/en/standards/HKTASpec/hkta-2xxx.html>*



SIEMIC, Inc.

Accessing global markets

Title: RF Test Report of Zebra Technologies Corp
Model : ZComax XG-182Z 802.11 b/g radio
To FCC 15.247:2010 & RSS-210 Issue8 : 2010

Serial# SL11050402-ZBR-029
Issue Date Jun 13 2011
Page 49 of 61
www.siemic.com

SIEMIC ACREDITATION DETAILS: FCC Test Site Registration No. 783147

FEDERAL COMMUNICATIONS COMMISSION

**Laboratory Division
7435 Oakland Mills Road
Columbia, MD 21046**

June 08, 2011

Registration Number: 783147

SIEMIC Laboratories
2206 Ringwood Avenue,
San Jose, CA 95131

Attention: Leslie Bai, Director of Certification

Re: Measurement facility located at San Jose
Anechoic chamber (3 meters)
Date of Renewal: June 08, 2011

Dear Sir or Madam:

Your request for renewal of the registration of the subject measurement facility has been received. The information submitted has been placed in your file and the registration has been renewed. The name of your organization will remain on the list of facilities whose measurement data will be accepted in conjunction with applications for Certification under Parts 15 or 18 of the Commission's Rules. Please note that the file must be updated for any changes made to the facility and the registration must be renewed at least every three years.

Measurement facilities that have indicated that they are available to the public to perform measurement services on a fee basis may be found on the FCC website www.fcc.gov under E-Filing, OET Equipment Authorization Electronic Filing, Test Firms.

Sincerely,

Phyllis Parrish
Industry Analyst

SIEMIC ACREDITATION DETAILS: Industry of Canada CAB ID : US0160



UNITED STATES DEPARTMENT OF COMMERCE
National Institute of Standards and Technology
Gaithersburg, Maryland 20899

March 4, 2009

Mr. Leslie Bai
SIEMIC, Inc.
2206 Ringwood Avenue
San Jose, CA 95131

Dear Mr. Bai:

NIST is pleased to inform you that your laboratory has been recognized by Industry Canada (IC), under the Asia Pacific Economic Cooperation for Telecommunications Equipment Mutual Recognition Arrangement (APEC Tel MRA). Your laboratory is now designated to act as a Conformity Assessment Body (CAB) under Appendix B, **Phase I** Procedures, of the APEC Tel MRA. The pertinent information about your laboratory's designation is as follows:

CAB Name: SIEMIC, Inc.
Physical Location: 2206 Ringwood Avenue, San Jose, CA 95131 USA
Identification No.: US0160
Recognized Scope: CS-03 Part I, II, V, VI, VII and VIII

You may submit test data to IC to verify that the equipment to be imported into Canada satisfies the applicable requirements. The designation of your organization will remain in force as long as its accreditation for the designated scope remains valid and comply with the designation requirements.

Recognized CABs are listed on the NIST website at <http://ts.nist.gov/mra>. Please contact Ms. Ramona Saar at (301) 975-5521 or ramona.saar@nist.gov if you have any questions.

Sincerely,

David F. Alderman
Group Leader, Standards Coordination and Conformity Group
Standards Services Division

Enclosure

cc: CAB Program Manager



SIEMIC, Inc.

Accessing global markets

Title: RF Test Report of Zebra Technologies Corp
Model : ZComax XG-182Z 802.11 b/g radio
To FCC 15.247:2010 & RSS-210 Issue8 : 2010

Serial# SL11050402-ZBR-029
Issue Date Jun 13 2011
Page 51 of 61
www.sieminc.com

SIEMIC ACREDITATION DETAILS: Industry of Canada Test Site Registration No. 4842-1



May 27, 2010

OUR FILE: 46405-4842
Submission No: 140856

Siemic Inc.
2206 Ringwood Ave
San Jose, CA, 95131
USA

Attention: Snell Leong

Dear Sir/Madame:

The Bureau has received your application for the renewal of a 3m alternative test site. Be advised that the information received was satisfactory to Industry Canada. The following number(s) is now associated to the site(s) for which registration / renewal was sought (**4842A-1**). Please reference the appropriate site number in the body of test reports containing measurements performed on the site. In addition, please keep for your records the following information;

- Your primary code is: **4842**
- The company number associated to the site(s) located at the above address is: **4842A**

Furthermore, to obtain or renew a unique site number, the applicant shall demonstrate that the site has been accredited to ANSI C63.4-2003 or later. A scope of accreditation indicating the accreditation by a recognized accreditation body to ANSI C63.4-2003 or later shall be accepted. Please indicate in a letter the previous assigned site number if applicable and the type of site (example: 3 metre OATS or 3 metre chamber). If the test facility is not accredited to ANSI C63.4-2003 or later, the test facility shall submit test data demonstrating full compliance with the ANSI standard. The Bureau will evaluate the filing to determine if recognition shall be granted.

The frequency for re-validation of the test site and the information that is required to be filed or retained by the testing party shall comply with the requirements established by the accrediting organization. However, in all cases, test site re-validation shall occur on an interval not to exceed two years. There is no fee or form associated with an OATS filing. OATS submissions are encouraged to be submitted electronically to the Bureau using the following URL;
http://strategis.ic.gc.ca/epic/internet/inceb-bhst.nsf/en/h_tt00052e.html.

If you have any questions, you may contact the Bureau by e-mail at certification.bureau@ic.gc.ca Please reference our file and submission number above for all correspondence.

Yours sincerely,

Dalwinder Gill
For: Wireless Laboratory Manager
Certification and Engineering Bureau
3701 Carling Ave., Building 94
P.O. Box 11490, Station "H"
Ottawa, Ontario K2H 8S2
Email: dalwinder.gill@ic.gc.ca
Tel. No. (613) 998-8363
Fax. No. (613) 990-4752



SIEMIC, Inc.

Accessing global markets

Title: RF Test Report of Zebra Technologies Corp
Model : ZComax XG-182Z 802.11 b/g radio
To FCC 15.247:2010 & RSS-210 Issue8 : 2010

Serial# SL11050402-ZBR-029
Issue Date Jun 13 2011
Page 52 of 61
www.siemec.com

SIEMIC ACREDITATION DETAILS: FCC DOC CAB Recognition : US1109

FEDERAL COMMUNICATIONS COMMISSION

**Laboratory Division
7435 Oakland Mills Road
Columbia, MD 21046**

August 28, 2008

Siemic Laboratories
2206 Ringwood Ave.,
San Jose, CA 95131

Attention: Leslie Bai

Re: Accreditation of Siemic Laboratories
Designation Number: US1109
Test Firm Registration #: 540430

Dear Sir or Madam:

We have been notified by American Association for Laboratory Accreditation that Siemic Laboratories has been accredited as a Conformity Assessment Body (CAB).

At this time Siemic Laboratories is hereby designated to perform compliance testing on equipment subject to Declaration Of Conformity (DOC) and Certification under Parts 15 and 18 of the Commission's Rules.

This designation will expire upon expiration of the accreditation or notification of withdrawal of designation.

Sincerely,

George Tannahill
Electronics Engineer

SIEMIC ACREDITATION DETAILS: Australia CAB ID : US0160



UNITED STATES DEPARTMENT OF COMMERCE
National Institute of Standards and Technology
Gaithersburg, Maryland 20899-

November 20, 2008

Mr. Leslie Bai
SIEMIC, Inc.
2206 Ringwood Avenue
San Jose, CA 95131

Dear Mr. Bai:

NIST is pleased to inform you that your laboratory has been recognized by the Australian Communications and Media Authority (ACMA) under the Asia Pacific Economic Cooperation for Telecommunications Equipment Mutual Recognition Arrangement (APEC Tel MRA). Your laboratory is now designated to act as a Conformity Assessment Body (CAB) under Appendix B, **Phase I** Procedures, of the APEC Tel MRA. The pertinent information about your laboratory's designation is as follows:

CAB Name: Siemic, Inc.
Physical Location: 2206 Ringwood Avenue, San Jose, CA 95131
Identification No.: US0160
Recognized Scope: EMC: AS/NZS 4251.1 (until 5/31/2009), AS/NZS 4251.2 (until 5/31/2009), AS/NZS CISPR 11, AS/NZS CISPR 14.1, AS/NZS CISPR 22, AS/NZS 61000.6.3, AS/NZS 61000.6.4
Radiocommunications: AS/NZS 4281, AS/NZS 4268, AS/NZS 4280.1, AS/NZS 4280.2, AS/NZS 4295, AS/NZS 4582, AS/NZS 4583, AS/NZS 4769.1, AS/NZS 4769.2, AS/NZS 4770, AS/NZS 4771
Telecommunications: AS/ACIF S002:05, AS/ACIF S003:06, AS/ACIF S004:06, AS/ACIF S006:01, AS/ACIF S016:01, AS/ACIF S031:01, AS/ACIF S038:01, AS/ACIF S040:01, AS/ACIF S041:05, AS/ACIF S043.2:06, AS/NZS 60950.1

You may submit test data to ACMA to verify that the equipment to be imported into Australia satisfies the applicable requirements. The designation of your organization will remain in force as long as its accreditation for the designated scope remains valid and comply with the designation requirements. Recognized CABs are listed on the NIST website at <http://ts.nist.gov/mra>. Please contact Ms. Ramona Saar, at (301) 975-5521 or ramona.saar@nist.gov if you have questions.

Sincerely,

David F. Alderman
Group Leader, Standards Coordination and Conformity Group
Standards Services Division

Enclosure

cc: Snell Leong, Siemic, Inc.; Ramona Saar, NIST



SIEMIC ACREDITATION DETAILS: Korea CAB ID: US0160



UNITED STATES DEPARTMENT OF COMMERCE
National Institute of Standards and Technology
Gaithersburg, Maryland 20899

October 1, 2008

Mr. Leslie Bai
SIEMIC, Inc.
2206 Ringwood Avenue
San Jose, CA 95131

Dear Mr. Bai:

NIST is pleased to inform you that your laboratory has been recognized by the Radio Research Agency (RRA) Korea Communications Commission (KCC) under the Asia Pacific Economic Cooperation for Telecommunications Equipment Mutual Recognition Arrangement (APEC Tel MRA). Your laboratory is now designated to act as a Conformity Assessment Body (CAB) under Appendix B, **Phase I** Procedures, of the APEC Tel MRA. The pertinent information about your laboratory's designation is as follows:

- CAB Name: SIEMIC, Inc.
- Physical Location: 2206 Ringwood Avenue, San Jose, CA 95131
- Identification No.: US0160
- Recognized Scope: **EMI:** KCC Notice 2008-39, RRL Notice 2008-3: CA Procedures for EMI KN22: Test Method for EMI
EMS: KCC Notice 2008-38, RRL Notice 2008-4: CA Procedures for EMS KN24, KN-61000-4-2, -4-3, -4-4, -4-5, -4-6, -4-8, -4-11: Test Method for EMS
Wireless: RRL Notice 2008-26, RRL Notice 2008-2, RRL Notice 2008-10, RRL Notice 2007-49, RRL Notice 2007-20, RRL Notice 2007-21, RRL Notice 2007-80, RRL Notice 2004-68
Wired: President Notice 20664, RRL Notice 2007-30, RRL Notice 2008-7 with attachments 1, 3, 5, 6
President Notice 20664, RRL Notice 2008-7 with attachment 4

You may submit test data to RRA/KCC to verify that the equipment to be imported into Korea satisfies the applicable requirements. The designation of your organization will remain in force as long as its accreditation for the designated scope remains valid and comply with the designation requirements.

Recognized CABs are listed on the NIST website at <http://ts.nist.gov/mra>. If you have any questions please contact Ramona Saar at (301) 975-5521 or ramona.saar@nist.gov.

Sincerely,

David F. Alderman
Group Leader, Standards Coordination and Conformity Group
Standards Services Division

Enclosure

cc: Ramona Saar





SIEMIC, Inc.

Accessing global markets

Title: RF Test Report of Zebra Technologies Corp
Model : ZComax XG-182Z 802.11 b/g radio
To FCC 15.247:2010 & RSS-210 Issue8 : 2010

Serial# SL11050402-ZBR-029
Issue Date Jun 13 2011
Page 55 of 61
www.siemic.com

SIEMIC ACREDITATION DETAILS: Taiwan BSMI Accreditation No. SL2-IN-E-1130R



UNITED STATES DEPARTMENT OF COMMERCE
National Institute of Standards and Technology
Gaithersburg, Maryland 20899

May 3, 2006

Mr. Leslie Bai
SIEMIC Laboratories
2206 Ringwood Avenue
San Jose, CA 95131

Dear Mr. Bai:

I am pleased to inform you that your laboratory has been recognized by the Chinese Taipei's Bureau of Standards, Metrology, and Inspection (BSMI) under the Asia Pacific Economic Cooperation (APEC) Mutual Recognition Arrangement (MRA). Your laboratory is now designated to act as a Conformity Assessment Body (CAB) under Appendix B, **Phase I** Procedures, of the APEC Tel MRA. You may submit test data to BSMI to verify that the equipment to be imported into Chinese Taipei satisfies the applicable requirements. The designation of your organization will remain in force as long as its accreditation for the designated scope remains valid and comply with the designation requirements. The pertinent designation information is as follows:

- BSMI number: **SL2-IN-E-1130R** (Must be applied to the test reports)
- U.S Identification No: **US0160**
- Scope of Designation: **CNS 13438**
- Authorized signatory: **Mr. Leslie Bai**

The names of all recognized CABs will be posted on the NIST website at <http://ts.nist.gov/mra>. If you have any questions, please contact Mr. Dhillon at 301-975-5521. We appreciate your continued interest in our international conformity assessment activities.

Sincerely,

David F. Alderman
Group Leader, Standards Coordination and Conformity Group

cc: Jogindar Dhillon

NIST

SIEMIC ACREDITATION DETAILS: Taiwan NCC CAB ID: US0160



UNITED STATES DEPARTMENT OF COMMERCE
National Institute of Standards and Technology
Gaithersburg, Maryland 20899

November 25, 2008

Mr. Leslie Bai
SIEMIC, Inc.
2206 Ringwood Avenue
San Jose, CA 95131

Dear Mr. Bai:

NIST is pleased to inform you that your laboratory has been recognized by the National Communications Commission (NCC) for the requested scope expansion under the Asia Pacific Economic Cooperation for Telecommunications Equipment Mutual Recognition Arrangement (APEC Tel MRA). Your laboratory is designated to act as a Conformity Assessment Body (CAB) under Appendix B, **Phase I** Procedures, of the APEC Tel MRA. The pertinent information about your laboratory's designation is as follows:

CAB Name: SIEMIC, Inc.
Physical Location: 2206 Ringwood Avenue, San Jose, CA 95131
Identification No.: US0160
Current Scope: LP0002
Additional Scope: PSTN01, ADSL01, ID0002, IS6100 and CNS 14336

You may submit test data to NCC to verify that the equipment to be imported into China satisfies the applicable requirements. The designation of your organization will remain in force as long as its accreditation for the designated scope remains valid and comply with the designation requirements.

Recognized CABs are listed on the NIST website at <http://ts.nist.gov/mra>. If you have any questions please contact Ramona Saar at (301) 975-5521 or ramona.saar@nist.gov.

Sincerely,

David F. Alderman
Group Leader, Standards Coordination and Conformity Group
Standards Services Division

Enclosure

cc: Ramona Saar

NIST

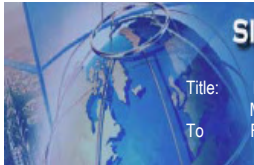

SIEMIC, Inc.

Accessing global markets

Title: RF Test Report of Zebra Technologies Corp
Model : ZComax XG-182Z 802.11 b/g radio
To: FCC 15.247:2010 & RSS-210 Issue8 : 2010

Serial# SL11050402-ZBR-029
Issue Date Jun 13 2011
Page 57 of 61
www.siemic.com

SIEMIC ACREDITATION DETAILS: Mexico NOM Recognition



CAMARA NACIONAL
DE LA INDUSTRIA
ELECTRONICA, DE
TELECOMUNICACIONES
E INFORMATICA

Laboratorio Valentín V. Rivero

México D.F. a 16 de octubre de 2006.

**LESLIE BAI
DIRECTOR OF CERTIFICATION
SIEMIC LABORATORIES, INC.
ACCESSING GLOBAL MARKETS
P R E S E N T E**

En contestación a su escrito de fecha 5 de septiembre del año en curso, le comento que estamos muy interesados en su intención de firmar un Acuerdo de Reconocimiento Mutuo, para lo cual adjunto a este escrito encontrara el Acuerdo en idioma ingles y español preferido de los cuales le pido sea revisado y en su caso corregido, para que si este de acuerdo poder firmarlo para mandarlo con las autoridades Mexicanas para su visto bueno y así poder ejercer dicho acuerdo.

Aprovecho este escrito para mencionarle que nuestro intermediario gestor será la empresa Isabel de México, S. A. de C. V., empresa que ha colaborado durante mucho tiempo con nosotros en lo relacionado a la evaluación de la conformidad y que cuenta con amplia experiencia en la gestión de la certificación de cumplimiento con Normas Oficiales Mexicanas de producto en México.

Me despido de usted enviándole un cordial saludo y esperando sus comentarios al Acuerdo que nos ocupa.

Atentamente:

**Ing. Faustino Sotelo González
Gerente Técnico del Laboratorio de
CANIETI.**

Callejón 71
Hidráulica Condasa
06100 México, D.F.
Tel: 5264-0808 con 12 líneas
Fax: 5264-0496
www.canietit.org

SIEMIC ACREDITATION DETAILS: Hong Kong OFTA CAB ID : US0160



UNITED STATES DEPARTMENT OF COMMERCE
National Institute of Standards and Technology
Gaithersburg, Maryland 20899-

December 8, 2008

Mr. Leslie Bai
SIEMIC, Inc.
2206 Ringwood Avenue
San Jose, CA 95131

Dear Mr. Bai:

NIST is pleased to inform you that your laboratory has been recognized by the Office of the Telecommunications Authority (OFTA) under the Asia Pacific Economic Cooperation for Telecommunications Equipment Mutual Recognition Arrangement (APEC Tel MRA). Your laboratory is now designated to act as a Conformity Assessment Body (CAB) under Appendix B, **Phase I** Procedures, of the APEC Tel MRA. The pertinent information about your laboratory's designation is as follows:

CAB Name: SIEMIC, Inc.
Physical Location: 2206 Ringwood Avenue, San Jose, California 95131 USA
Identification No.: US0160
Recognized Scope: **Radio:** HKTA 1002, 1007, 1008, 1010, 1015, 1016, 1020, 1022, 1026, 1027, 1029, 1030, 1031, 1032, 1033, 1034, 1035, 1036, 1037, 1039, 1041, 1042, 1043, 1044, 1046, 1047, 1048, 1049, 1051
Telecom: HKTA 2011, 2012, 2013, 2014, 2017, 2018, 2022, 2024, 2026, 2027, 2028, 2029, 2030, 2031, 2032, 2033

You may submit test data to OFTA to verify that the equipment to be imported into Hong Kong satisfies the applicable requirements. The designation of your organization will remain in force as long as its accreditation for the designated scope remains valid and comply with the designation requirements.

Recognized CABs are listed on the NIST website at <http://ts.nist.gov/mra>. If you have any questions please contact Ramona Saar at (301) 975-5521 or ramona.saar@nist.gov.

Sincerely,

David F. Alderman
Group Leader, Standards Coordination and Conformity Group
Standards Services Division

Enclosure

cc: Ramona Saar





SIEMIC, INC.

Accessing global markets

Title: RF Test Report of Zebra Technologies Corp
Model : ZComax XG-182Z 802.11 b/g radio
To FCC 15.247:2010 & RSS-210 Issue8 : 2010

Serial# SL11050402-ZBR-029
Issue Date Jun 13 2011
Page 59 of 61
www.siemic.com

SIEMIC ACREDITATION DETAILS: VCCI Radiated Test Site Registration No. T-1597



VCCI Council

CERTIFICATE

Company: SIEMIC Laboratories

<Member No. 3081 >

Facility: SIEMIC Laboratories

(Telecommunication Ports Conducted Disturbance Measurement)

Location of Facility:

2206 Ringwood Ave San Jose, CA 95131, USA

*This is to certify that the following measuring facility
has been registered in accordance with the Rules
for Voluntary Control Measures*

Registration No.: T-1597

Date of Registration: October 01 , 2010

This Certificate is valid until September 30 , 2012

VCCI Council





SIEMIC, INC.

Accessing global markets

Title: RF Test Report of Zebra Technologies Corp
Model : ZComax XG-182Z 802.11 b/g radio
To FCC 15.247:2010 & RSS-210 Issue8 : 2010

Serial# SL11050402-ZBR-029
Issue Date Jun 13 2011
Page 60 of 61
www.siemic.com

SIEMIC ACREDITATION DETAILS: VCCI Conducted (Main Port) Test Site Registration No. R-3083



VCCI Council

CERTIFICATE

Company: SIEMIC Laboratories
<Member No. 3081 >

Facility: SIEMIC Laboratories
(Radiation 3 meter site)

Location of Facility:
2206 Ringwood Ave , San Jose, CA 95131, USA

*This is to certify that the following measuring facility
has been registered in accordance with the Rules
for Voluntary Control Measures*

Registration No.: R-3083

Date of Registration: October 01 , 2010

This Certificate is valid until September 30 , 2012

VCCI Council





SIEMIC, INC.

Accessing global markets

Title: RF Test Report of Zebra Technologies Corp
Model : ZComax XG-182Z 802.11 b/g radio
To FCC 15.247:2010 & RSS-210 Issue8 : 2010

Serial# SL11050402-ZBR-029
Issue Date Jun 13 2011
Page 61 of 61
www.sieminc.com

SIEMIC ACREDITATION DETAILS: VCCI Conducted (Telecom Port) Test Site Registration No. C-3421



VCCI Council

CERTIFICATE

Company: SIEMIC Laboratories

<Member No. 3081 >

Facility: SIEMIC Laboratories

(Main Ports Conducted Interference Measurement)

Location of Facility:

2206 Ringwood Ave San Jose, CA 95131, USA

*This is to certify that the following measuring facility
has been registered in accordance with the Rules
for Voluntary Control Measures*

Registration No.: C-3421

Date of Registration: October 01 , 2010

This Certificate is valid until September 30 , 2012

VCCI Council

