

# FCC Radio Test Report

**FCC ID: HFSQTA-TP00126A**



**Report No.** : BTL-FCCP-2-2006T132  
**Equipment** : Notebook Computer  
**Model Name** : TP00126A, Lenovo ThinkPad C13 Yoga Gen 1 Chromebook\*\*\*\*\*  
(x=0~9, A~z, "-" or blank)  
**Brand Name** : Lenovo  
**Applicant** : Quanta Computer Inc.  
**Address** : No. 188, Wenhua 2nd Rd., Guishan Dist., Taoyuan City 33377, Taiwan

**Radio Function** : Bluetooth Low Energy

**FCC Rule Part(s)** : FCC Part15, Subpart C (15.247)  
**Measurement Procedure(s)** : ANSI C63.10-2013

**Date of Receipt** : 2020/6/24  
**Date of Test** : 2020/6/24 ~ 2020/7/30  
**Issued Date** : 2020/9/26

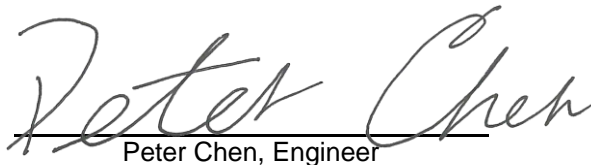
The above equipment has been tested and found in compliance with the requirement of the above standards by BTL Inc.

**Prepared by** :  
Peter Chen, Engineer**Approved by** :  
Scott Hsu, Manager**BTL Inc.**

No.18, Ln. 171, Sec. 2, Jiuzong Rd., Neihu Dist., Taipei City 114, Taiwan

Tel: +886-2-2657-3299

Fax: +886-2-2657-3331

Web: www.newbtl.com

**Declaration**

**BTL** represents to the client that testing is done in accordance with standard procedures as applicable and that test instruments used has been calibrated with standards traceable to international standard(s) and/or national standard(s).

**BTL's** reports apply only to the specific samples tested under conditions. It is manufacture's responsibility to ensure that additional production units of this model are manufactured with the identical electrical and mechanical components. **BTL** shall have no liability for any declarations, inferences or generalizations drawn by the client or others from **BTL** issued reports.

The report must not be used by the client to claim product certification, approval, or endorsement by NIST, A2LA, or any agency of the U.S. Government.

This report is the confidential property of the client. As a mutual protection to the clients, the public and ourselves, the test report shall not be reproduced, except in full, without our written approval.

**BTL's** laboratory quality assurance procedures are in compliance with the **ISO/IEC 17025** requirements, and accredited by the conformity assessment authorities listed in this test report.

**BTL** is not responsible for the sampling stage, so the results only apply to the sample as received.

The information, data and test plan are provided by manufacturer which may affect the validity of results, so it is manufacturer's responsibility to ensure that the apparatus meets the essential requirements of applied standards and in all the possible configurations as representative of its intended use.

**Limitation**

For the use of the authority's logo is limited unless the Test Standard(s)/Scope(s)/Item(s) mentioned in this test report is (are) included in the conformity assessment authorities acceptance respective.

Please note that the measurement uncertainty is provided for informational purpose only and are not use in determining the Pass/Fail results.

**CONTENTS**

REPORT ISSUED HISTORY	5
1 SUMMARY OF TEST RESULTS	6
1.1 TEST FACILITY	7
1.2 MEASUREMENT UNCERTAINTY	7
1.3 TEST ENVIRONMENT CONDITIONS	8
1.4 TABLE OF PARAMETERS OF TEXT SOFTWARE SETTING	8
1.5 DUTY CYCLE	8
2 GENERAL INFORMATION	9
2.1 DESCRIPTION OF EUT	9
2.2 TEST MODES	11
2.3 BLOCK DIAGRAM SHOWING THE CONFIGURATION OF SYSTEM TESTED	12
2.4 SUPPORT UNITS	12
3 AC POWER LINE CONDUCTED EMISSIONS TEST	13
3.1 LIMIT	13
3.2 TEST PROCEDURE	13
3.3 DEVIATION FROM TEST STANDARD	13
3.4 TEST SETUP	14
3.5 TEST RESULT	14
4 RADIATED EMISSIONS TEST	15
4.1 LIMIT	15
4.2 TEST PROCEDURE	16
4.3 DEVIATION FROM TEST STANDARD	16
4.4 TEST SETUP	17
4.5 EUT OPERATING CONDITIONS	18
4.6 TEST RESULT – 30 MHZ TO 1 GHZ	18
4.7 TEST RESULT – ABOVE 1 GHZ	18
5 BANDWIDTH TEST	19
5.1 APPLIED PROCEDURES / LIMIT	19
5.2 TEST PROCEDURE	19
5.3 DEVIATION FROM STANDARD	19
5.4 TEST SETUP	19
5.5 EUT OPERATION CONDITIONS	19
5.6 TEST RESULTS	19
6 OUTPUT POWER TEST	20
6.1 APPLIED PROCEDURES / LIMIT	20
6.2 TEST PROCEDURE	20
6.3 DEVIATION FROM STANDARD	20
6.4 TEST SETUP	20
6.5 EUT OPERATION CONDITIONS	20
6.6 TEST RESULTS	20
7 POWER SPECTRAL DENSITY TEST	21
7.1 APPLIED PROCEDURES / LIMIT	21
7.2 TEST PROCEDURE	21
7.3 DEVIATION FROM STANDARD	21
7.4 TEST SETUP	21
7.5 EUT OPERATION CONDITIONS	21
7.6 TEST RESULTS	21

8	ANTENNA CONDUCTED SPURIOUS EMISSION	22
8.1	APPLIED PROCEDURES / LIMIT	22
8.2	TEST PROCEDURE	22
8.3	DEVIATION FROM STANDARD	22
8.4	TEST SETUP	22
8.5	EUT OPERATION CONDITIONS	22
8.6	TEST RESULTS	22
9	LIST OF MEASURING EQUIPMENTS	23
10	EUT TEST PHOTO	25
11	EUT PHOTOS	25
APPENDIX A	AC POWER LINE CONDUCTED EMISSIONS	26
APPENDIX B	RADIATED EMISSIONS - 30 MHZ TO 1 GHZ	31
APPENDIX C	RADIATED EMISSIONS - ABOVE 1 GHZ	34
APPENDIX D	BANDWIDTH	51
APPENDIX E	OUTPUT POWER	54
APPENDIX F	POWER SPECTRAL DENSITY TEST	56
APPENDIX G	ANTENNA CONDUCTED SPURIOUS EMISSION	59

**REPORT ISSUED HISTORY**

Report Version	Description	Issued Date
R00	Original Issue.	2020/8/11
R01	Revised report to address TCB's comments.	2020/9/14
R02	Revised report to address TCB's comments.	2020/9/26

# 1 SUMMARY OF TEST RESULTS

Test procedures according to the technical standards.

FCC Part 15, Subpart C (15.247)				
Standard(s) Section	Description	Test Result	Judgement	Remark
15.207	AC Power Line Conducted Emissions	APPENDIX A	Pass	-----
15.205 15.209 15.247(d)	Radiated Emissions	APPENDIX B APPENDIX C	Pass	-----
15.247(a)(2)	Bandwidth	APPENDIX D	Pass	-----
15.247(b)(3)	Output Power	APPENDIX E	Pass	-----
15.247(e)	Power Spectral Density	APPENDIX F	Pass	-----
15.247(d)	Antenna conducted Spurious Emission	APPENDIX G	Pass	-----
15.203	Antenna Requirement	-----	Pass	-----

**NOTE:**

- (1) "N/A" denotes test is not applicable in this Test Report.
- (2) The report format version is TP.1.1.1.

### 1.1 TEST FACILITY

The test facilities used to collect the test data in this report:

No. 68-1, Ln. 169, Sec. 2, Datong Rd., Xizhi Dist., New Taipei City 221, Taiwan

The test sites and facilities are covered under FCC RN: 674415 and DN: TW0659.

- C05       CB08       CB11       CB15       CB16  
 SR06

### 1.2 MEASUREMENT UNCERTAINTY

The reported uncertainty of measurement  $y \pm U$ , where expanded uncertainty  $U$  is based on a standard uncertainty multiplied by a coverage factor of  $k = 2$ , providing a level of confidence of approximately **95 %**. The measurement instrumentation uncertainty considerations contained in CISPR 16-4-2. The BTL measurement uncertainty is less than the CISPR 16-4-2  $U_{cispr}$  requirement.

#### A. AC power line conducted emissions test:

Test Site	Method	Measurement Frequency Range	U (dB)
C05	CISPR	150 kHz ~ 30MHz	3.44

#### B. Radiated emissions test :

Test Site	Measurement Frequency Range	U,(dB)
CB15	0.03 GHz ~ 0.2 GHz	4.17
	0.2 GHz ~ 1 GHz	4.72
	1 GHz ~ 6 GHz	5.21
	6 GHz ~ 18 GHz	5.51
	18 GHz ~ 26 GHz	3.69
	26 GHz ~ 40 GHz	4.23

#### C. Conducted test :

Test Item	U,(dB)
Bandwidth	1.13
Output power	1.06
Power Spectral Density	1.20
Conducted Spurious emissions	1.14
Conducted Band edges	1.13

#### NOTE:

Unless specifically mentioned, the uncertainty of measurement has not been taken into account to declare the compliance or non-compliance to the specification.

### 1.3 TEST ENVIRONMENT CONDITIONS

Test Item	Environment Condition	Test Voltage	Tested by
AC Power Line Conducted Emissions	24 °C, 57 %	AC 120V	William Wei
Radiated emissions below 1 GHz	22 °C, 61 %	AC 120V	John Chuang
Radiated emissions above 1 GHz	22 °C, 61 %	AC 120V	John Chuang
Bandwidth	22.5 °C, 51 %	AC 120V	Tim Lee
Output Power	22.5 °C, 51 %	AC 120V	Tim Lee
Power Spectral Density	22.5 °C, 51 %	AC 120V	Tim Lee
Antenna conducted Spurious Emission	22.5 °C, 51 %	AC 120V	Tim Lee

### 1.4 TABLE OF PARAMETERS OF TEXT SOFTWARE SETTING

Test Software	DRTU V12.1947.0-10428			
Modulation Mode	2402 MHz	2440 MHz	2480 MHz	Data Rate
BLE 4.0	16	16	16	1 Mbps
BLE 5.0	16	16	16	2 Mbps

### 1.5 DUTY CYCLE

If duty cycle is  $\geq 98\%$ , duty factor is not required.  
 If duty cycle is  $< 98\%$ , duty factor shall be considered.

Remark	Delta 1			Delta 2		On Time/Period	10 log(1/Duty Cycle)
Mode	ON (ms)	Numbers (ON)	On Time (B) (ms)	Period (ON+OFF) (ms)	Duty Cycle (%)	Duty Factor (dB)	
BLE 4.0	0.390	1	0.390	0.630	61.90%	2.08	
BLE 5.0	0.205	1	0.205	0.630	32.54%	4.88	

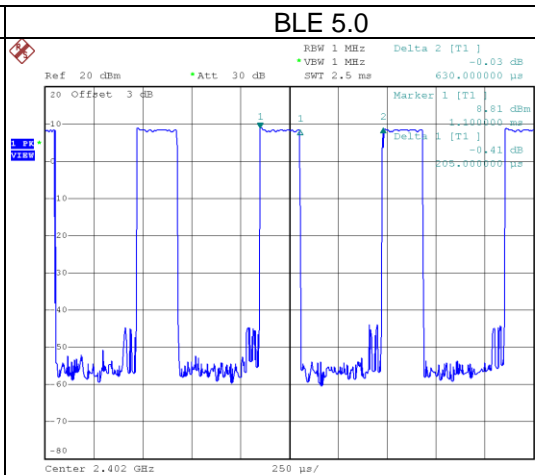
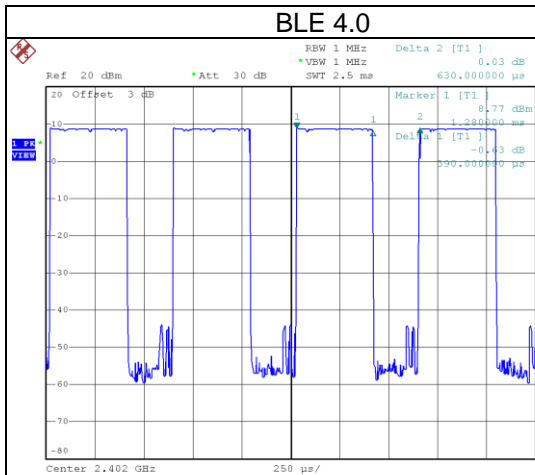

Date: 30.JUL.2020 17:54:25

Date: 30.JUL.2020 17:55:48



## 2 GENERAL INFORMATION

### 2.1 DESCRIPTION OF EUT

Equipment	Notebook Computer
Model Name	TP00126A, Lenovo ThinkPad C13 Yoga Gen 1 Chromebook***** (x=0~9, A~z, "-" or blank)
Brand Name	Lenovo
Model Difference	Differ in Market proposal.
Power Source	DC voltage supplied from AC/DC Adapter.
Power Rating	20Vdc 3.25A/20Vdc 2.25A / 15Vdc 3.0A / 9Vdc 2.0A / 5Vdc 2.0A
Power Adapter Power Rating	1. I/P: 100-240V~1.3A 50-60Hz O/P: 20Vdc 2.25A / 15Vdc 3A / 9Vdc 2A / 5Vdc 2A 2. I/O: 100-240V~1.8A 50-60Hz O/P: 20Vdc 3.25A 65.0W / 15Vdc 3.0A / 9Vdc 2.0A / 5Vdc 2.0A 10.0W
Power Adapter	1. Chicony / ADLX45YCC3F 2. Liteon / ADLX65YLC3D
Frequency Range	2400 MHz ~ 2483.5 MHz
Operation Frequency	2402 MHz ~ 2480 MHz
Modulation Technology	GFSK
Transfer Rate	BLE 4.0: 1 Mbps BLE 5.0: 2 Mbps
Output Power Max.	BLE 4.0: 8.81 dBm (0.0076 W) BLE 5.0: 8.92 dBm (0.0078 W)
Test Model	TP00126A
Sample Status	Engineering Sample
EUT Modification(s)	N/A

**NOTE:**

- (1) For a more detailed features description, please refer to the manufacturer's specifications or the user's manual.
- (2) Channel List:

Channel	Frequency (MHz)	Channel	Frequency (MHz)
00	2402	20	2442
01	2404	21	2444
02	2406	22	2446
03	2408	23	2448
04	2410	24	2450
05	2412	25	2452
06	2414	26	2454
07	2416	27	2456
08	2418	28	2458
09	2420	29	2460
10	2422	30	2462
11	2424	31	2464
12	2426	32	2466
13	2428	33	2468
14	2430	34	2470
15	2432	35	2472
16	2434	36	2474
17	2436	37	2476
18	2438	38	2478
19	2440	39	2480

(3) Table for Filed Antenna:  
**Tablet Mode**

Ant.	Brand	Model	Type	Frequency Range (MHz)	Gain (dBi)
Main	ICT	SA30Z18922	PIFA Antenna	2400-2500	-2.6
				5150-5350	-0.9
				5740-5725	-2.5
				5725-5875	-2.5
Aux	ICT	SA30Z18923	PIFA Antenna	2400-2500	-1.1
				5150-5350	-2.6
				5740-5725	-3.6
				5725-5875	-5.7

Ant.	Brand	Model	Type	Frequency Range (MHz)	Gain (dBi)
Main	AWAN	SA30Z18927	PIFA Antenna	2400-2500	-0.39
				5150-5350	0.21
				5740-5725	-1.28
				5725-5875	-0.64
Aux	AWAN	SA30Z18928	PIFA Antenna	2400-2500	-1.48
				5150-5350	-0.25
				5740-5725	-1.22
				5725-5875	-1.22

**NB Mode**

Ant.	Brand	Model	Type	Frequency Range (MHz)	Gain (dBi)
Main	ICT	SA30Z18922	PIFA Antenna	2400-2500	-2.3
				5150-5350	1.6
				5740-5725	1.9
				5725-5875	1.9
Aux	ICT	SA30Z18923	PIFA Antenna	2400-2500	-2.3
				5150-5350	1.1
				5740-5725	1.2
				5725-5875	2.0

Ant.	Brand	Model	Type	Frequency Range (MHz)	Gain (dBi)
Main	AWAN	SA30Z18927	PIFA Antenna	2400-2500	-2.11
				5150-5350	1.94
				5740-5725	1.61
				5725-5875	1.47
Aux	AWAN	SA30Z18928	PIFA Antenna	2400-2500	-1.73
				5150-5350	1.78
				5740-5725	0.71
				5725-5875	0.52

## 2.2 TEST MODES

Test Items	Test mode	Channel	Note
AC power line conducted emissions	Normal/Idle	-	-
Transmitter Radiated Emissions (below 1GHz)	BLE 5.0	39	-
Transmitter Radiated Emissions (above 1GHz)	BLE 4.0/ BLE 5.0	00/39	Bandedge
	BLE 4.0/ BLE 5.0	00/19/39	Harmonic
Bandwidth	BLE 4.0/ BLE 5.0	00/19/39	-
Output Power	BLE 4.0/ BLE 5.0	00/19/39	-
Power Spectral Density	BLE 4.0/ BLE 5.0	00/19/39	-
Antenna conducted Spurious Emission	BLE 4.0/ BLE 5.0	00/19/39	-

**NOTE:**

- (1) The Radiated emissions test was verified based on the worst conducted power and Bandwidth test results reported in the original report.
- (2) For radiated emission band edge test, both Vertical and Horizontal are evaluated, but only the worst case (Horizontal) is recorded.
- (3) All X, Y and Z axes are evaluated, but only the worst case (X axis) is recorded.
- (4) There were no emissions found below 30 MHz within 20 dB of the limit.
- (5) All adapter are evaluated, the ADLX65YLC3D is the worst and recorded as below test data.

### 2.3 BLOCK DIAGRAM SHOWING THE CONFIGURATION OF SYSTEM TESTED

Equipment letters and Cable numbers refer to item numbers described in the tables of clause 2.4.

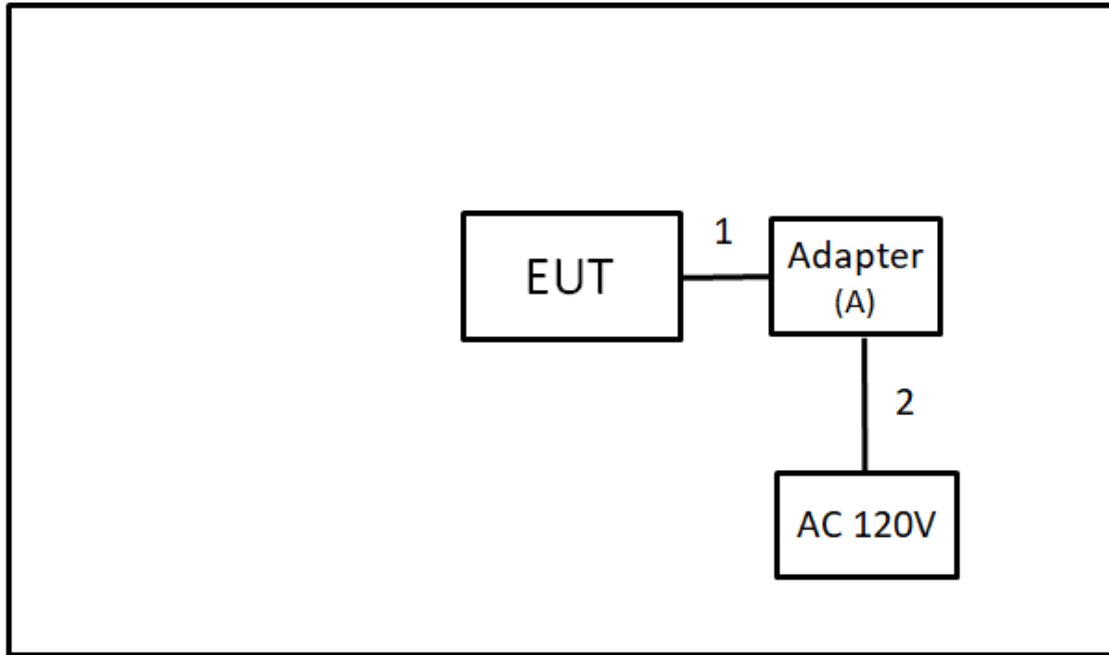

### 2.4 SUPPORT UNITS

Item	Equipment	Brand	Model No.	Series No.	Remarks
A	Adapter	Lenove	ADLX65YLC3D	N/A	Supplied by test requester

Item	Shielded	Ferrite Core	Length	Cable Type	Remarks
1	N/A	N/A	1.6m	Adapter Cable	Supplied by test requester
2	N/A	N/A	0.9m	power core	Supplied by test requester

### 3 AC POWER LINE CONDUCTED EMISSIONS TEST

#### 3.1 LIMIT

Frequency (MHz)	Limit (dB $\mu$ V)	
	Quasi-peak	Average
0.15 - 0.5	66 - 56 *	56 - 46 *
0.50 - 5.0	56	46
5.0 - 30.0	60	50

**NOTE:**

- (1) The tighter limit applies at the band edges.
- (2) The limit of " \* " marked band means the limitation decreases linearly with the logarithm of the frequency in the range.
- (3) The test result calculated as following:  
 Measurement Value = Reading Level + Correct Factor  
 Correct Factor = Insertion Loss + Cable Loss + Attenuator Factor (if use)  
 Margin Level = Measurement Value – Limit Value  
 Calculation example:

Reading Level		Correct Factor		Measurement Value
38.22	+	3.45	=	41.67

Measurement Value		Limit Value		Margin Level
41.67	-	60	=	-18.33

The following table is the setting of the receiver.

Receiver Parameter	Setting
Attenuation	10 dB
Start Frequency	0.15 MHz
Stop Frequency	30 MHz
IF Bandwidth	9 KHz

#### 3.2 TEST PROCEDURE

- a. The EUT was placed 0.8 m above the horizontal ground plane with the EUT being connected to the power mains through a line impedance stabilization network (LISN).  
 All other support equipment were powered from an additional LISN(s).  
 The LISN provides 50 Ohm/50uH of impedance for the measuring instrument.
- b. Interconnecting cables that hang closer than 40 cm to the ground plane shall be folded back and forth in the center forming a bundle to keep the cable above 40 cm.
- c. Excess I/O cables that are not connected to a peripheral shall be bundled in the center.  
 The end of the cable will be terminated, using the correct terminating impedance.  
 The overall length shall not exceed 1 m.
- d. The LISN is spaced at least 80 cm from the nearest part of the EUT chassis.
- e. For the actual test configuration, please refer to the related Item – EUT TEST PHOTO.

**NOTE:**

- (1) In the results, each reading is marked as Peak, QP or AVG per the detector used.  
 BW=9 kHz (6 dB Bandwidth)
- (2) All readings are Peak unless otherwise stated QP or AVG in column of Note. Both the QP and the AVG readings must be less than the limit for compliance.

#### 3.3 DEVIATION FROM TEST STANDARD

No deviation.

### 3.4 TEST SETUP

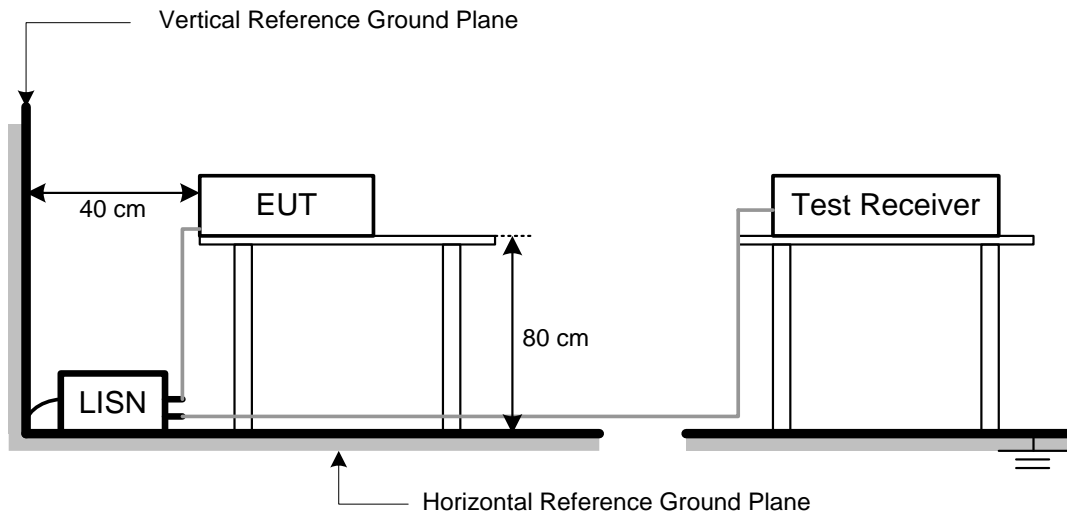

### 3.5 TEST RESULT

Please refer to the **APPENDIX A**.

## 4 RADIATED EMISSIONS TEST

### 4.1 LIMIT

In case the emission fall within the restricted band specified on 15.205, then the 15.209 limit in the table below has to be followed.

#### LIMITS OF RADIATED EMISSIONS MEASUREMENT (9 kHz to 1000 MHz)

Frequency (MHz)	Field Strength (microvolts/meter)	Measurement Distance (meters)
0.009~0.490	2400/F(KHz)	300
0.490~1.705	24000/F(KHz)	30
1.705~30.0	30	30
30~88	100	3
88~216	150	3
216~960	200	3
960~1000	500	3

#### LIMITS OF RADIATED EMISSIONS MEASUREMENT (Above 1000 MHz)

Frequency (MHz)	Radiated Emissions (dBuV/m)		Measurement Distance (meters)
	Peak	Average	
Above 1000	74	54	3

#### NOTE:

- (1) The limit for radiated test was performed according to FCC Part 15, Subpart C.
- (2) The tighter limit applies at the band edges.
- (3) Emission level (dBuV/m)=20log Emission level (uV/m).
- (4) The test result calculated as following:  
 Measurement Value = Reading Level + Correct Factor  
 Correct Factor = Antenna Factor + Cable Loss - Amplifier Gain(if use)  
 Margin Level = Measurement Value - Limit Value  
 Calculation example:

Reading Level		Correct Factor		Measurement Value
41.91	+	-8.36	=	33.55

Measurement Value		Limit Value		Margin Level
33.55	-	43.50	=	-9.95

Spectrum Parameter	Setting
Attenuation	Auto
Start Frequency	1000 MHz
Stop Frequency	10th carrier harmonic
RBW / VBW (Emission in restricted band)	1MHz / 3MHz for Peak, 1MHz / 1/T for Average

Spectrum Parameter	Setting
Attenuation	Auto
Start ~ Stop Frequency	9KHz~90KHz for PK/AVG detector
Start ~ Stop Frequency	90KHz~110KHz for QP detector
Start ~ Stop Frequency	110KHz~490KHz for PK/AVG detector
Start ~ Stop Frequency	490KHz~30MHz for QP detector
Start ~ Stop Frequency	30MHz~1000MHz for QP detector

#### 4.2 TEST PROCEDURE

- a. The measuring distance of 3 m shall be used for measurements. The EUT was placed on the top of a rotating table 0.8 meter above the ground at a 3 meter semi-anechoic chamber. The table was rotated 360 degrees to determine the position of the highest radiation.(below 1GHz)
- b. The measuring distance of 3 m shall be used for measurements. The EUT was placed on the top of a rotating table 1.5 meter above the ground at a 3 meter semi-anechoic chamber. The table was rotated 360 degrees to determine the position of the highest radiation.(above 1GHz)
- c. The height of the equipment or of the substitution antenna shall be 0.8 m or 1.5 m, the height of the test antenna shall vary between 1 m to 4 m. Both horizontal and vertical polarizations of the antenna are set to make the measurement.
- d. For each suspected emission, the EUT was arranged to its worst case and then the antenna was tuned to heights find the maximum reading (used Bore sight function).
- e. The receiver system was set to peak and average detect function and specified bandwidth with maximum hold mode when the test frequency is above 1GHz.
- f. The initial step in collecting radiated emission data is a receiver peak detector mode pre-scanning the measurement frequency range. Significant peaks are then marked and then Quasi Peak detector mode re-measured.
- g. All readings are Peak unless otherwise stated QP in column of Note. Peak denotes that the Peak reading compliance with the QP Limits and then QP Mode measurement didn't perform. (below 1GHz)
- h. All readings are Peak Mode value unless otherwise stated AVG in column of Note. If the Peak Mode Measured value compliance with the Peak Limits and lower than AVG Limits, the EUT shall be deemed to meet both Peak & AVG Limits and then only Peak Mode was measured, but AVG Mode didn't perform. (above 1GHz)
- i. For the actual test configuration, please refer to the related Item – EUT TEST PHOTO.

#### 4.3 DEVIATION FROM TEST STANDARD

No deviation.



## 4.4 TEST SETUP

### 30 MHz to 1 GHz

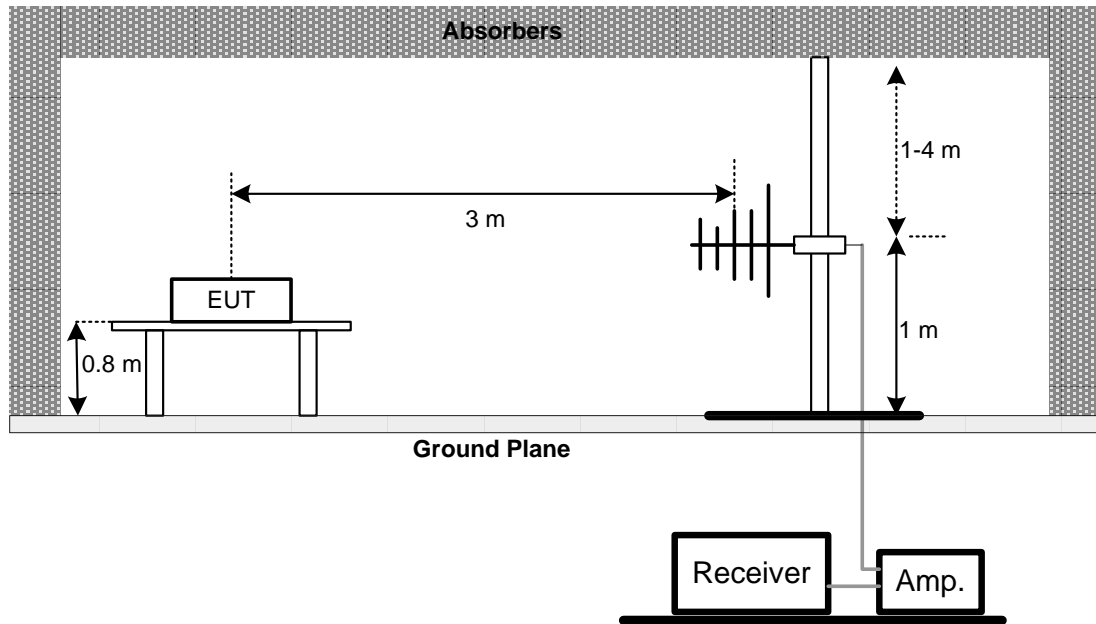

### Above 1 GHz

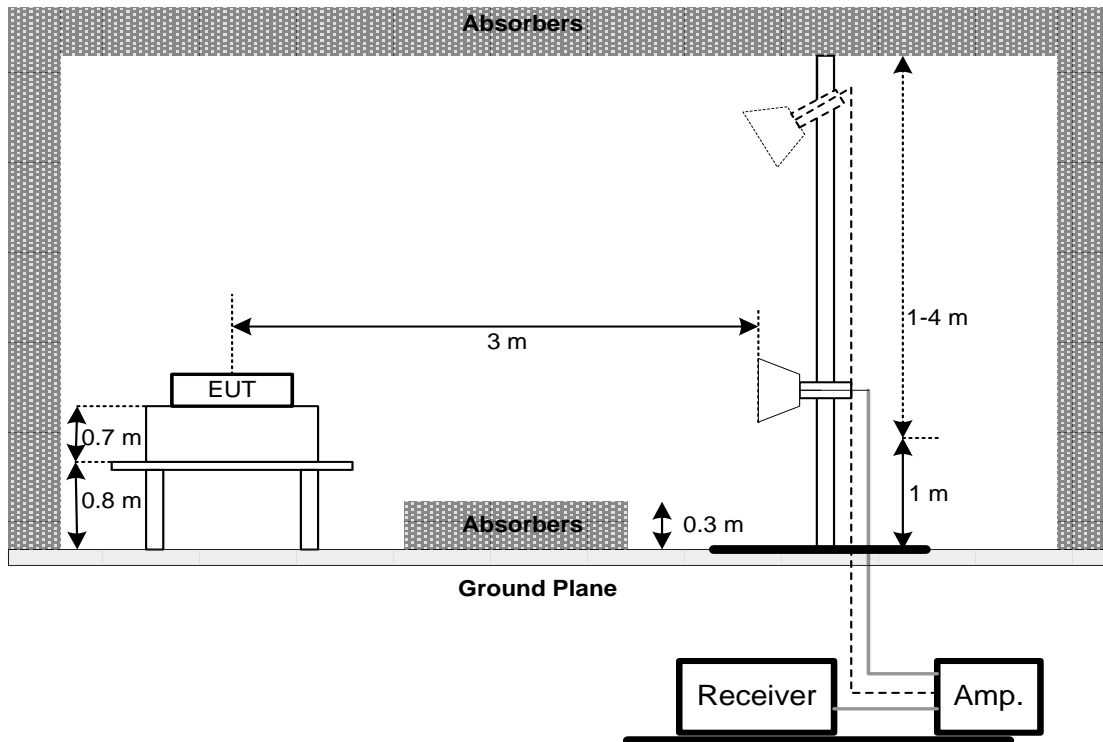

**4.5 EUT OPERATING CONDITIONS**

The EUT was programmed to be in continuously transmitting mode.

**4.6 TEST RESULT – 30 MHZ TO 1 GHZ**

Please refer to the APPENDIX B.

**4.7 TEST RESULT – ABOVE 1 GHZ**

Please refer to the APPENDIX C.

**NOTE:**

- (1) No limit: This is fundamental signal, the judgment is not applicable.  
For fundamental signal judgment was referred to Peak output test.

**5 BANDWIDTH TEST****5.1 APPLIED PROCEDURES / LIMIT**

FCC Part15 (15.247) , Subpart C				
Section	Test Item	Limit	Frequency Range (MHz)	Result
15.247(a)(2)	Bandwidth	$\geq 500\text{KHz}$ (6dB bandwidth)	2400-2483.5	PASS

**5.2 TEST PROCEDURE**

- a. The EUT was directly connected to the spectrum analyzer and antenna output port as show in the block diagram below,
- b. Spectrum Setting : RBW= 100KHz, VBW=300KHz, Sweep time = 2.5 ms.

**5.3 DEVIATION FROM STANDARD**

No deviation.

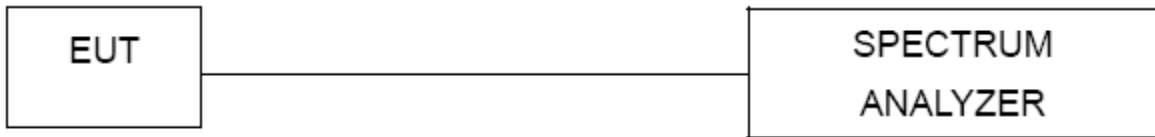
**5.4 TEST SETUP****5.5 EUT OPERATION CONDITIONS**

The EUT tested system was configured as the statements of 3.5 unless otherwise a special operating condition is specified in the follows during the testing.

**5.6 TEST RESULTS**

Please refer to the APPENDIX D.

**6 OUTPUT POWER TEST****6.1 APPLIED PROCEDURES / LIMIT**

FCC Part15 (15.247) , Subpart C				
Section	Test Item	Limit	Frequency Range (MHz)	Result
15.247(b)(3)	Maximum Output Power	1 watt or 30dBm	2400-2483.5	PASS

**6.2 TEST PROCEDURE**

- a. The EUT was directly connected to the power meter and antenna output port as show in the block diagram below,
- b. The maximum peak conducted output power was performed in accordance with FCC KDB 558074 D01 15.247 Meas Guidance.

**6.3 DEVIATION FROM STANDARD**

No deviation.

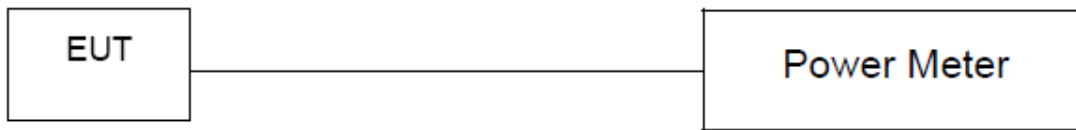
**6.4 TEST SETUP****6.5 EUT OPERATION CONDITIONS**

The EUT tested system was configured as the statements of 3.5 unless otherwise a special operating condition is specified in the follows during the testing.

**6.6 TEST RESULTS**

Please refer to the APPENDIX E.

**7 POWER SPECTRAL DENSITY TEST****7.1 APPLIED PROCEDURES / LIMIT**

FCC Part15 (15.247) , Subpart C				
Section	Test Item	Limit	Frequency Range (MHz)	Result
15.247(e)	Power Spectral Density	8 dBm (in any 3KHz)	2400-2483.5	PASS

**7.2 TEST PROCEDURE**

- a. The EUT was directly connected to the spectrum analyzer and antenna output port as show in the block diagram below,
- b. Spectrum Setting: RBW=3KHz, VBW=10 KHz, Sweep time = auto.

**7.3 DEVIATION FROM STANDARD**

No deviation.

**7.4 TEST SETUP****7.5 EUT OPERATION CONDITIONS**

The EUT tested system was configured as the statements of 3.5 unless otherwise a special operating condition is specified in the follows during the testing.

**7.6 TEST RESULTS**

Please refer to the APPENDIX F.

## 8 ANTENNA CONDUCTED SPURIOUS EMISSION

### 8.1 APPLIED PROCEDURES / LIMIT

In any 100 kHz bandwidth outside the frequency band in which the spread spectrum or digitally modulated device is operating, the RF power that is produced shall be at least 20 dB below that in the 100 kHz bandwidth within the band that contains the highest level of the desired power, based on either an RF conducted or a radiated measurement, provided that the transmitter demonstrates compliance with the peak conducted power limits.

### 8.2 TEST PROCEDURE

- a. The EUT was directly connected to the spectrum analyzer and antenna output port as show in the block diagram below,
- b. Spectrum Setting : RBW= 100KHz, VBW=300KHz, Sweep time = 10 ms.

### 8.3 DEVIATION FROM STANDARD

No deviation.

### 8.4 TEST SETUP

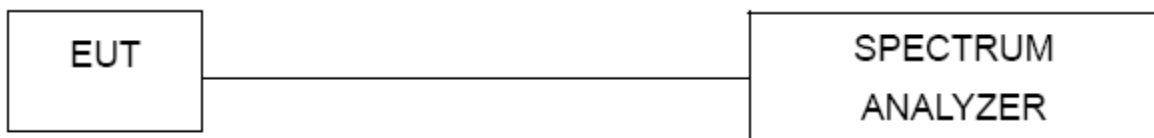

### 8.5 EUT OPERATION CONDITIONS

The EUT tested system was configured as the statements of 3.5 unless otherwise a special operating condition is specified in the follows during the testing.

### 8.6 TEST RESULTS

Please refer to the APPENDIX G.

## 9 LIST OF MEASURING EQUIPMENTS

AC Power Line Conducted Emissions						
Item	Kind of Equipment	Manufacturer	Type No.	Serial No.	Calibrated Date	Calibrated Until
1	TWO-LINE V-NETWORK	R&S	ENV216	101050	2020/6/11	2021/6/11
2	Test Cable	EMCI	EMC400-BM-BM-5000	170501	2019/8/15	2020/8/14
3	EMI Test Receiver	R&S	ESR7	101433	2019/12/13	2020/12/11
4	Measurement Software	EZ	EZ_EMCI (Version NB-03A1-01)	N/A	N/A	N/A

Radiated Emissions						
Item	Kind of Equipment	Manufacturer	Type No.	Serial No.	Calibrated Date	Calibrated Until
1	Preamplifier	EMCI	EMC001340	980555	2020/4/10	2021/4/9
2	Preamplifier	EMCI	EMC02325B	980217	2020/4/10	2021/4/9
3	Preamplifier	EMCI	EMC012645B	980267	2020/4/10	2021/4/9
4	Preamplifier	EMCI	EMC2654045	980030	2020/1/31	2021/1/30
5	Test Cable	EMCI	EMC104-SM-SM-800	150207	2020/4/10	2021/4/9
6	Test Cable	EMCI	EMC104-SM-SM-3000	151205	2020/4/10	2021/4/9
7	Test Cable	EMCI	EMC-SM-SM-7000	180408	2020/4/10	2021/4/9
8	MXE EMI Receiver	Agilent	N9038A	MY554200087	2020/6/10	2021/6/9
9	Signal Analyzer	Agilent	N9010A	MY56480554	2020/6/4	2021/6/3
10	Loop Ant	EMCO	6502	274	2020/6/16	2021/6/15
11	Horn Ant	SCHWARZBECK	BBHA 9120D	9120D-1342	2020/6/12	2021/6/11
12	Horn Ant	Schwarzbeck	BBHA 9170	187	2019/12/21	2020/12/20
13	Trilog-Broadband Antenna	Schwarzbeck	VULB 9168	0992	2020/7/10	2021/7/9
14	5dB Attenuator	EMCI	EMCI-N-6-05	AT-N0508	2020/7/10	2021/7/9

Bandwidth						
Item	Kind of Equipment	Manufacturer	Type No.	Serial No.	Calibrated Date	Calibrated Until
1	Spectrum Analyzer	R&S	FSP 40	100129	2020/6/15	2021/6/14

Output Power						
Item	Kind of Equipment	Manufacturer	Type No.	Serial No.	Calibrated Date	Calibrated Until
1	Power Meter	Keysight	8990B	MY51000517	2020/4/6	2021/4/5
2	Power Sensor	Keysight	N1923A	MY58310005	2020/4/6	2021/4/5

Power Spectral Density						
Item	Kind of Equipment	Manufacturer	Type No.	Serial No.	Calibrated Date	Calibrated Until
1	Spectrum Analyzer	R&S	FSP 40	100129	2020/6/15	2021/6/14

**Antenna conducted Spurious Emission**

Item	Kind of Equipment	Manufacturer	Type No.	Serial No.	Calibrated Date	Calibrated Until
1	Spectrum Analyzer	R&S	FSP 40	100129	2020/6/15	2021/6/14

Remark: "N/A" denotes no model name, no serial no. or no calibration specified.  
All calibration period of equipment list is one year.



**10 EUT TEST PHOTO**

Please refer to document Appendix No.: TP-2006T132-FCCP-1 (APPENDIX-TEST PHOTOS).

**11 EUT PHOTOS**

Please refer to document Appendix No.: EP-2006T132-1 (APPENDIX-EUT PHOTOS).

## **APPENDIX A AC POWER LINE CONDUCTED EMISSIONS**

Test Mode	Normal	Tested Date	2020/7/30
Test Frequency	-	Phase	Line

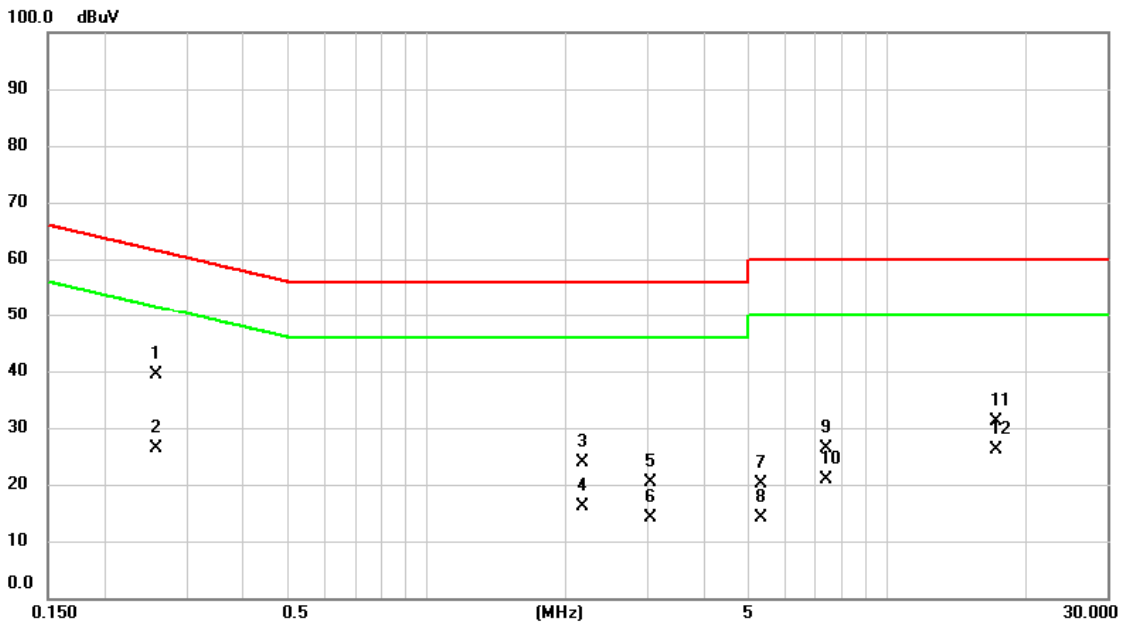

No.	Mk.	Freq. MHz	Reading Level dBuV	Correct Factor dB	Measure- ment dBuV	Limit dBuV	Over dB	Detector	Comment
1	*	0.2580	29.58	9.68	39.26	61.50	-22.24	QP	
2		0.2580	16.72	9.68	26.40	51.50	-25.10	AVG	
3		2.1750	14.19	9.74	23.93	56.00	-32.07	QP	
4		2.1750	6.46	9.74	16.20	46.00	-29.80	AVG	
5		3.0570	10.73	9.76	20.49	56.00	-35.51	QP	
6		3.0570	4.32	9.76	14.08	46.00	-31.92	AVG	
7		5.3272	10.18	9.83	20.01	60.00	-39.99	QP	
8		5.3272	4.42	9.83	14.25	50.00	-35.75	AVG	
9		7.3703	16.40	9.87	26.27	60.00	-33.73	QP	
10		7.3703	10.94	9.87	20.81	50.00	-29.19	AVG	
11		17.2320	21.30	9.95	31.25	60.00	-28.75	QP	
12		17.2320	16.17	9.95	26.12	50.00	-23.88	AVG	

**REMARKS:**

- (1) Measurement Value = Reading Level + Correct Factor.
- (2) Margin Level = Measurement Value - Limit Value.

Test Mode	Normal	Tested Date	2020/7/30
Test Frequency	-	Phase	Neutral

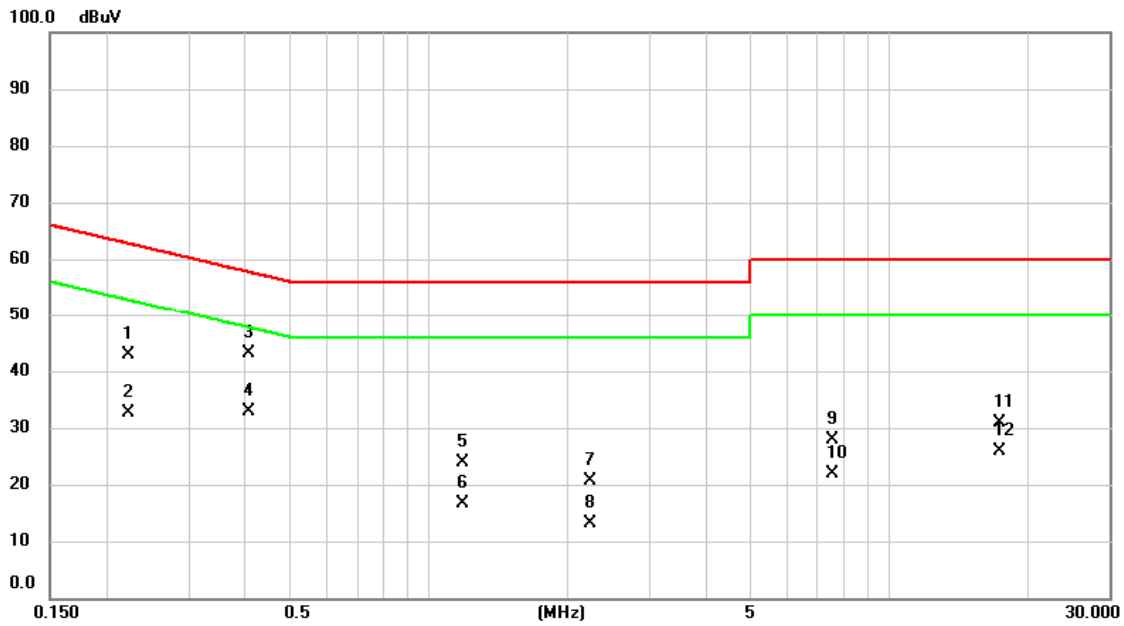

No.	Mk.	Freq. MHz	Reading Level dBuV	Correct Factor dB	Measure- ment dBuV	Limit dBuV	Over dB	Detector	Comment
1		0.2220	33.23	9.67	42.90	62.74	-19.84	QP	
2		0.2220	22.98	9.67	32.65	52.74	-20.09	AVG	
3	*	0.4087	33.53	9.68	43.21	57.67	-14.46	QP	
4		0.4087	23.16	9.68	32.84	47.67	-14.83	AVG	
5		1.1827	14.12	9.70	23.82	56.00	-32.18	QP	
6		1.1827	6.90	9.70	16.60	46.00	-29.40	AVG	
7		2.2403	10.90	9.74	20.64	56.00	-35.36	QP	
8		2.2403	3.34	9.74	13.08	46.00	-32.92	AVG	
9		7.5638	17.92	9.88	27.80	60.00	-32.20	QP	
10		7.5638	12.03	9.88	21.91	50.00	-28.09	AVG	
11		17.3603	21.05	9.95	31.00	60.00	-29.00	QP	
12		17.3603	16.03	9.95	25.98	50.00	-24.02	AVG	

**REMARKS:**

- (1) Measurement Value = Reading Level + Correct Factor.
- (2) Margin Level = Measurement Value - Limit Value.

Test Mode	Idle	Tested Date	2020/7/30
Test Frequency	-	Phase	Line

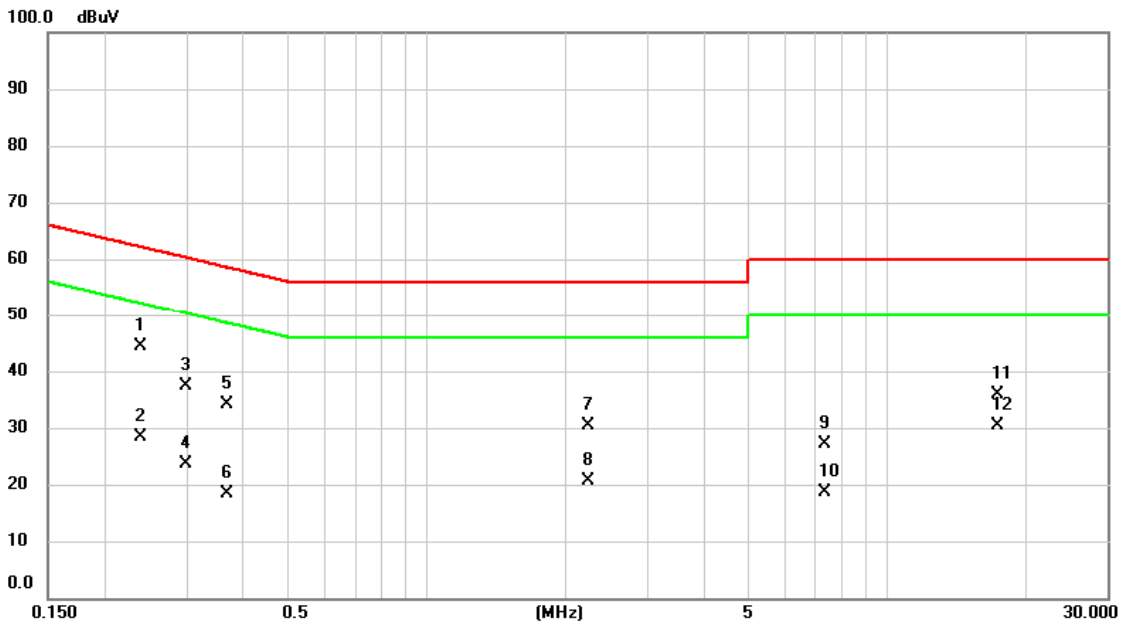

No.	Mk.	Freq. MHz	Reading Level dBuV	Correct Factor dB	Measure- ment dBuV	Limit dBuV	Over dB	Detector	Comment
1	*	0.2378	34.78	9.68	44.46	62.17	-17.71	QP	
2		0.2378	18.70	9.68	28.38	52.17	-23.79	AVG	
3		0.2985	27.81	9.69	37.50	60.28	-22.78	QP	
4		0.2985	14.02	9.69	23.71	50.28	-26.57	AVG	
5		0.3682	24.43	9.68	34.11	58.54	-24.43	QP	
6		0.3682	8.62	9.68	18.30	48.54	-30.24	AVG	
7		2.2403	20.56	9.74	30.30	56.00	-25.70	QP	
8		2.2403	10.88	9.74	20.62	46.00	-25.38	AVG	
9		7.3163	17.24	9.87	27.11	60.00	-32.89	QP	
10		7.3163	8.69	9.87	18.56	50.00	-31.44	AVG	
11		17.3760	25.89	9.95	35.84	60.00	-24.16	QP	
12		17.3760	20.45	9.95	30.40	50.00	-19.60	AVG	

**REMARKS:**

- (1) Measurement Value = Reading Level + Correct Factor.
- (2) Margin Level = Measurement Value - Limit Value.

Test Mode	Idle	Tested Date	2020/7/30
Test Frequency	-	Phase	Neutral

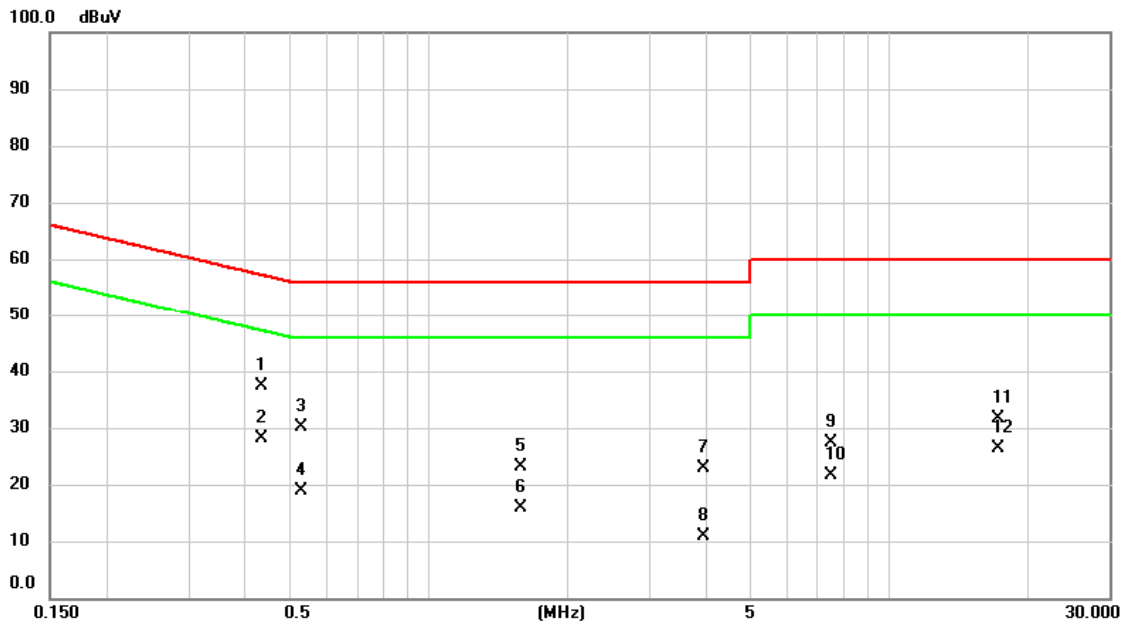

No.	Mk.	Freq. MHz	Reading Level dBuV	Correct Factor dB	Measure- ment dBuV	Limit dBuV	Over dB	Detector	Comment
1		0.4335	27.78	9.68	37.46	57.19	-19.73	QP	
2	*	0.4335	18.52	9.68	28.20	47.19	-18.99	AVG	
3		0.5280	20.56	9.68	30.24	56.00	-25.76	QP	
4		0.5280	9.09	9.68	18.77	46.00	-27.23	AVG	
5		1.5833	13.39	9.72	23.11	56.00	-32.89	QP	
6		1.5833	6.04	9.72	15.76	46.00	-30.24	AVG	
7		3.9255	13.07	9.79	22.86	56.00	-33.14	QP	
8		3.9255	1.17	9.79	10.96	46.00	-35.04	AVG	
9		7.4918	17.60	9.87	27.47	60.00	-32.53	QP	
10		7.4918	11.77	9.87	21.64	50.00	-28.36	AVG	
11		17.1848	21.61	9.95	31.56	60.00	-28.44	QP	
12		17.1848	16.34	9.95	26.29	50.00	-23.71	AVG	

**REMARKS:**

- (1) Measurement Value = Reading Level + Correct Factor.
- (2) Margin Level = Measurement Value - Limit Value.

## **APPENDIX B RADIATED EMISSIONS - 30 MHZ TO 1 GHZ**

Test Mode	BLE 5.0	Test Date	2020/7/27
Test Frequency	CH39: 2480 MHz	Polarization	Vertical

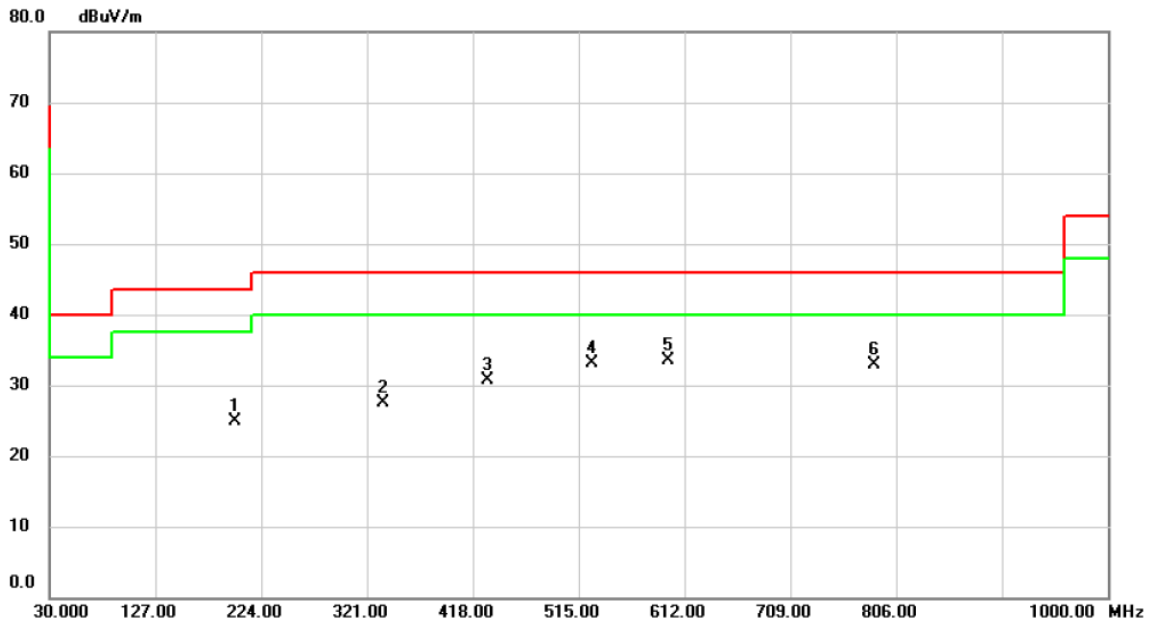

No.	Mk.	Freq. MHz	Reading Level dBuV	Correct Factor dB	Measure- ment dBuV/m	Limit dBuV/m	Over dB	Detector	Comment
1		199.7500	35.51	-10.64	24.87	43.50	-18.63	peak	
2		335.5500	33.69	-6.23	27.46	46.00	-18.54	peak	
3		431.5800	34.81	-4.08	30.73	46.00	-15.27	peak	
4		527.6100	35.20	-2.12	33.08	46.00	-12.92	peak	
5	*	597.4500	33.84	-0.40	33.44	46.00	-12.56	peak	
6		785.6300	30.37	2.50	32.87	46.00	-13.13	peak	

**REMARKS:**

- (1) Measurement Value = Reading Level + Correct Factor.
- (2) Margin Level = Measurement Value - Limit Value.



Test Mode	BLE 5.0	Test Date	2020/7/27
Test Frequency	CH39: 2480 MHz	Polarization	Horizontal

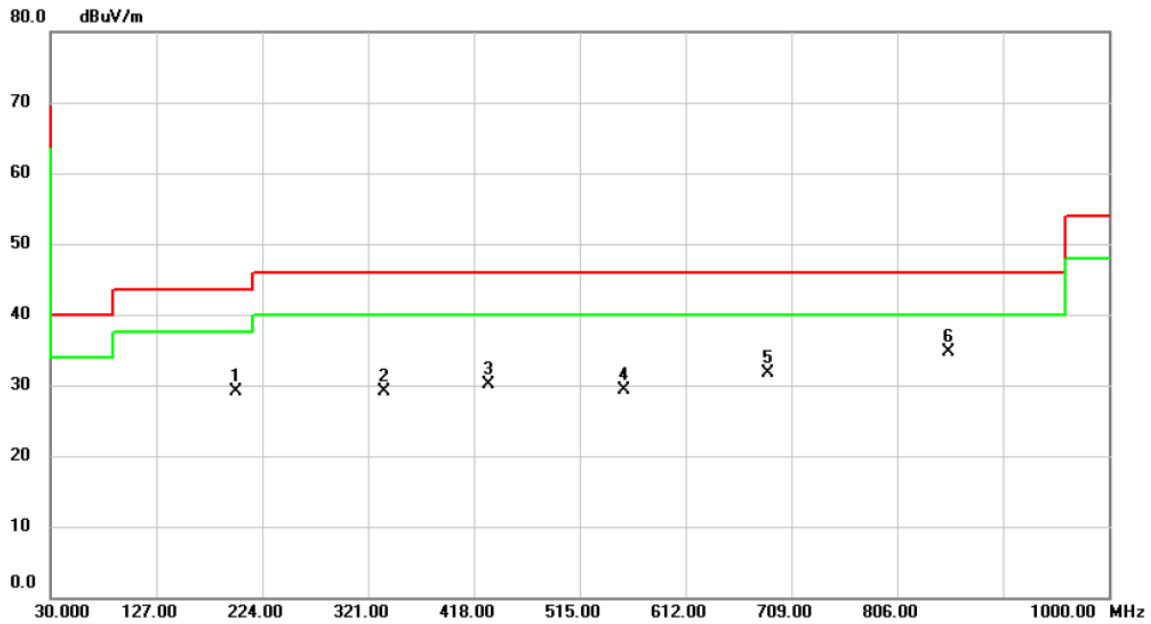

No.	Mk.	Freq.	Reading Level	Correct Factor	Measurement	Limit	Over	Detector	Comment
		MHz	dBuV	dB	dBuV/m	dBuV/m	dB		
1		199.7500	39.70	-10.64	29.06	43.50	-14.44	peak	
2		335.5500	35.29	-6.23	29.06	46.00	-16.94	peak	
3		431.5800	34.25	-4.08	30.17	46.00	-15.83	peak	
4		555.7400	30.75	-1.44	29.31	46.00	-16.69	peak	
5		687.6600	30.78	0.90	31.68	46.00	-14.32	peak	
6	*	852.5600	31.44	3.35	34.79	46.00	-11.21	peak	

**REMARKS:**

- (1) Measurement Value = Reading Level + Correct Factor.
- (2) Margin Level = Measurement Value - Limit Value.

## **APPENDIX C RADIATED EMISSIONS - ABOVE 1 GHZ**

Test Mode	BLE 4.0	Test Date	2020/7/23
Test Frequency	CH00: 2402 MHz	Polarization	Horizontal

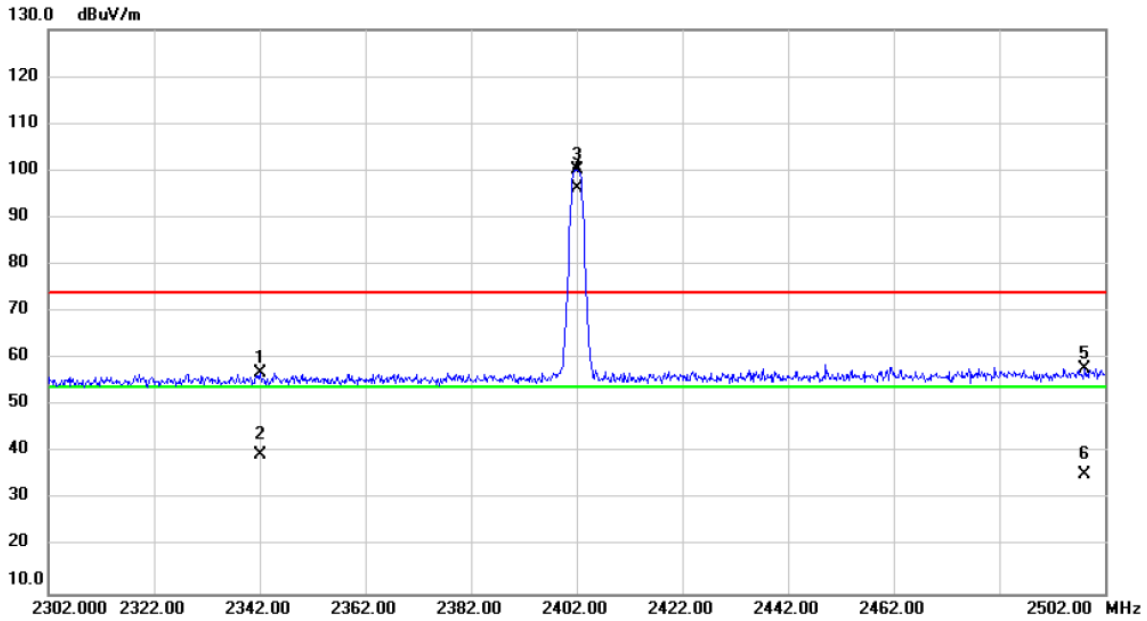

No.	Mk.	Freq.	Reading Level	Correct Factor	Measurement	Limit	Over	Detector	Comment
		MHz	dBuV	dB	dBuV/m	dBuV/m	dB		
1		2342.000	26.39	30.60	56.99	74.00	-17.01	peak	
2		2342.000	8.88	30.60	39.48	54.00	-14.52	AVG	
3	X	2402.000	69.33	30.84	100.17	74.00	26.17	peak	No Limit
4	*	2402.000	65.31	30.84	96.15	54.00	42.15	AVG	No Limit
5		2498.200	26.63	31.22	57.85	74.00	-16.15	peak	
6		2498.200	4.06	31.22	35.28	54.00	-18.72	AVG	

**REMARKS:**

- (1) Measurement Value = Reading Level + Correct Factor.
- (2) Margin Level = Measurement Value - Limit Value.

Test Mode	BLE 4.0	Test Date	2020/7/23
Test Frequency	CH39: 2480 MHz	Polarization	Horizontal

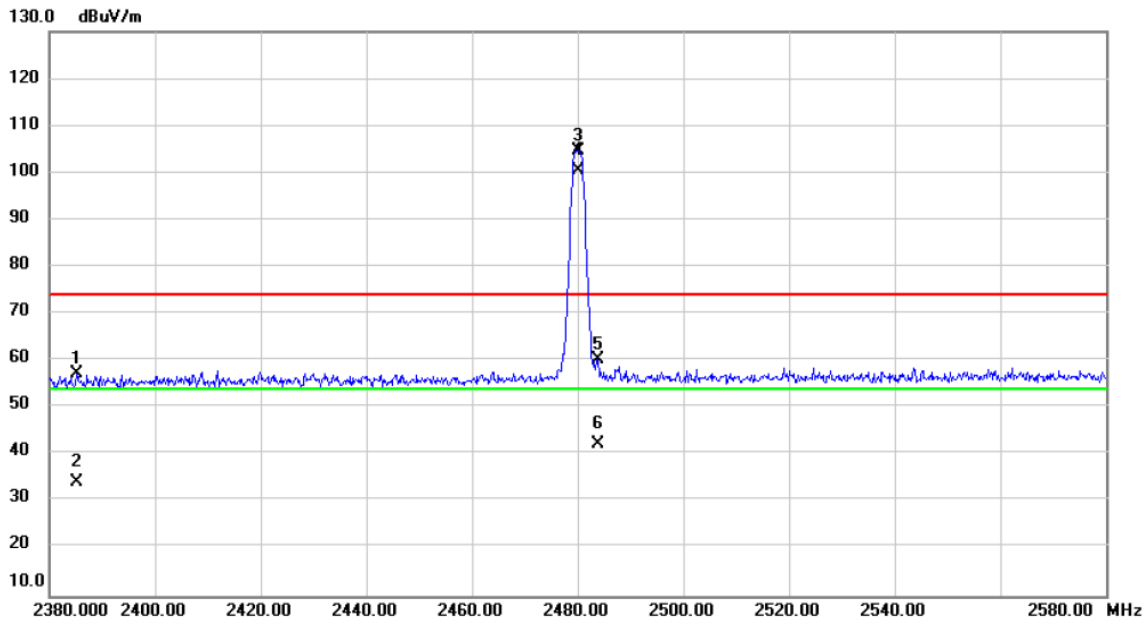

No.	Mk.	Freq.	Reading Level	Correct Factor	Measurement	Limit	Over	Detector	Comment
		MHz	dBuV	dB	dBuV/m	dBuV/m	dB		
1		2385.200	26.45	30.77	57.22	74.00	-16.78	peak	
2		2385.200	3.45	30.77	34.22	54.00	-19.78	AVG	
3	X	2480.000	73.47	31.15	104.62	74.00	30.62	peak	No Limit
4	*	2480.000	69.30	31.15	100.45	54.00	46.45	AVG	No Limit
5		2483.800	29.11	31.16	60.27	74.00	-13.73	peak	
6		2483.800	11.00	31.16	42.16	54.00	-11.84	AVG	

**REMARKS:**

- (1) Measurement Value = Reading Level + Correct Factor.
- (2) Margin Level = Measurement Value - Limit Value.

Test Mode	BLE 5.0	Test Date	2020/7/23
Test Frequency	CH00: 2402 MHz	Polarization	Horizontal

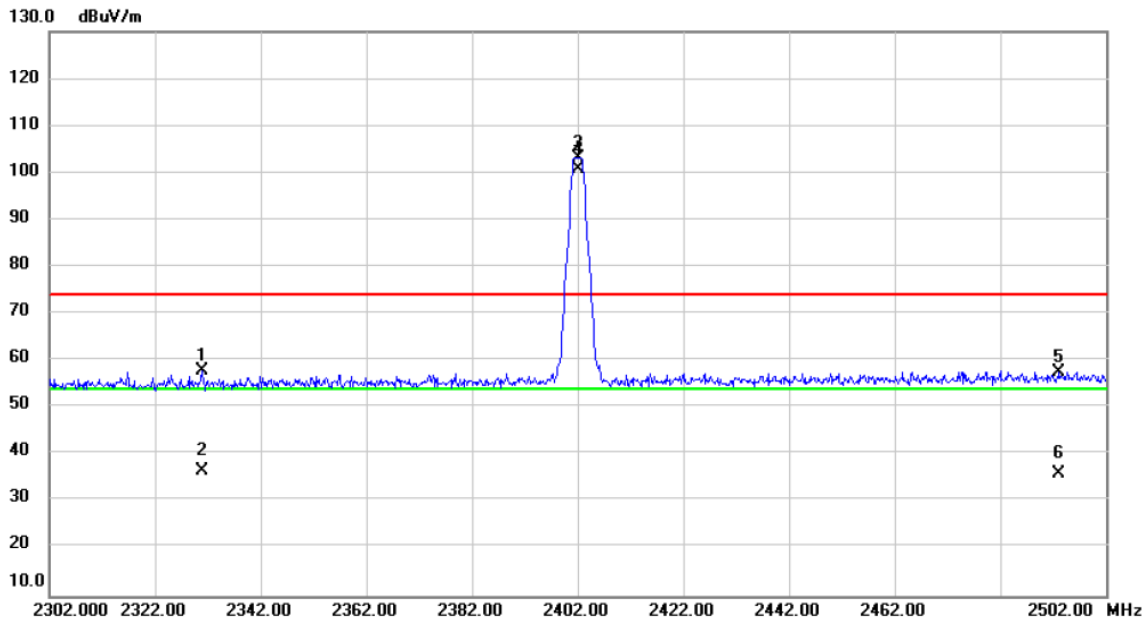

No.	Mk.	Freq.	Reading Level	Correct Factor	Measurement	Limit	Over	Detector	Comment
		MHz	dBuV	dB	dBuV/m	dBuV/m	dB		
1		2331.000	27.16	30.56	57.72	74.00	-16.28	peak	
2		2331.000	5.99	30.56	36.55	54.00	-17.45	AVG	
3	X	2402.000	72.32	30.84	103.16	74.00	29.16	peak	No Limit
4	*	2402.000	70.01	30.84	100.85	54.00	46.85	AVG	No Limit
5		2493.200	26.40	31.21	57.61	74.00	-16.39	peak	
6		2493.200	4.73	31.21	35.94	54.00	-18.06	AVG	

**REMARKS:**

- (1) Measurement Value = Reading Level + Correct Factor.
- (2) Margin Level = Measurement Value - Limit Value.

Test Mode	BLE 5.0	Test Date	2020/7/23
Test Frequency	CH39: 2480 MHz	Polarization	Horizontal

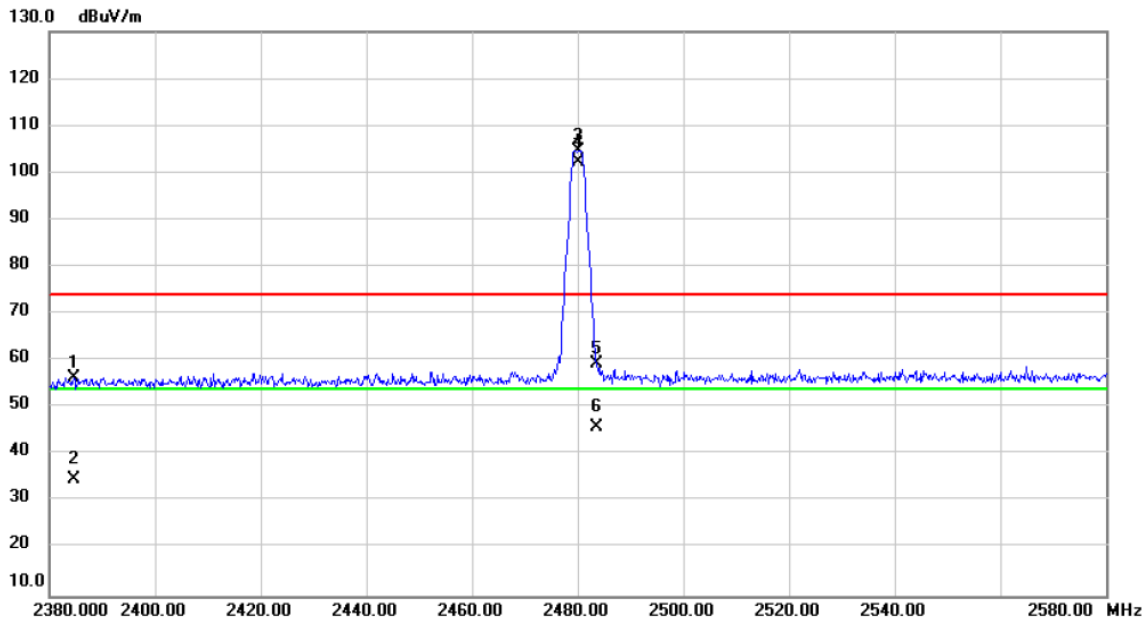

No.	Mk.	Freq.	Reading Level	Correct Factor	Measurement	Limit	Over	Detector	Comment
		MHz	dBuV	dB	dBuV/m	dBuV/m	dB		
1		2384.600	25.59	30.77	56.36	74.00	-17.64	peak	
2		2384.600	4.03	30.77	34.80	54.00	-19.20	AVG	
3	X	2480.000	73.50	31.15	104.65	74.00	30.65	peak	No Limit
4	*	2480.000	71.21	31.15	102.36	54.00	48.36	AVG	No Limit
5		2483.500	28.20	31.16	59.36	74.00	-14.64	peak	
6		2483.500	14.65	31.16	45.81	54.00	-8.19	AVG	

**REMARKS:**

- (1) Measurement Value = Reading Level + Correct Factor.
- (2) Margin Level = Measurement Value - Limit Value.

Test Mode	BLE 4.0	Test Date	2020/7/23
Test Frequency	CH00: 2402 MHz	Polarization	Vertical

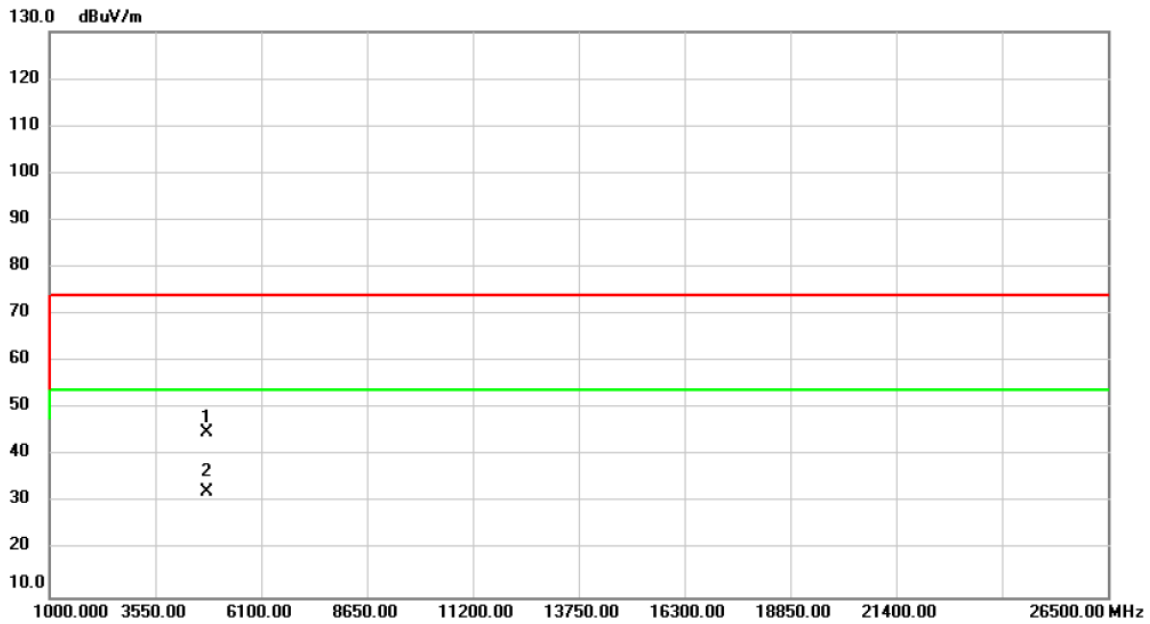

No.	Mk.	Freq.	Reading Level	Correct Factor	Measurement	Limit	Over	Detector	Comment
		MHz	dBuV	dB	dBuV/m	dBuV/m	dB		
1		4804.000	54.99	-10.03	44.96	74.00	-29.04	peak	
2	*	4804.000	42.23	-10.03	32.20	54.00	-21.80	AVG	

**REMARKS:**

- (1) Measurement Value = Reading Level + Correct Factor.
- (2) Margin Level = Measurement Value - Limit Value.

Test Mode	BLE 4.0	Test Date	2020/7/23
Test Frequency	CH00: 2402 MHz	Polarization	Horizontal

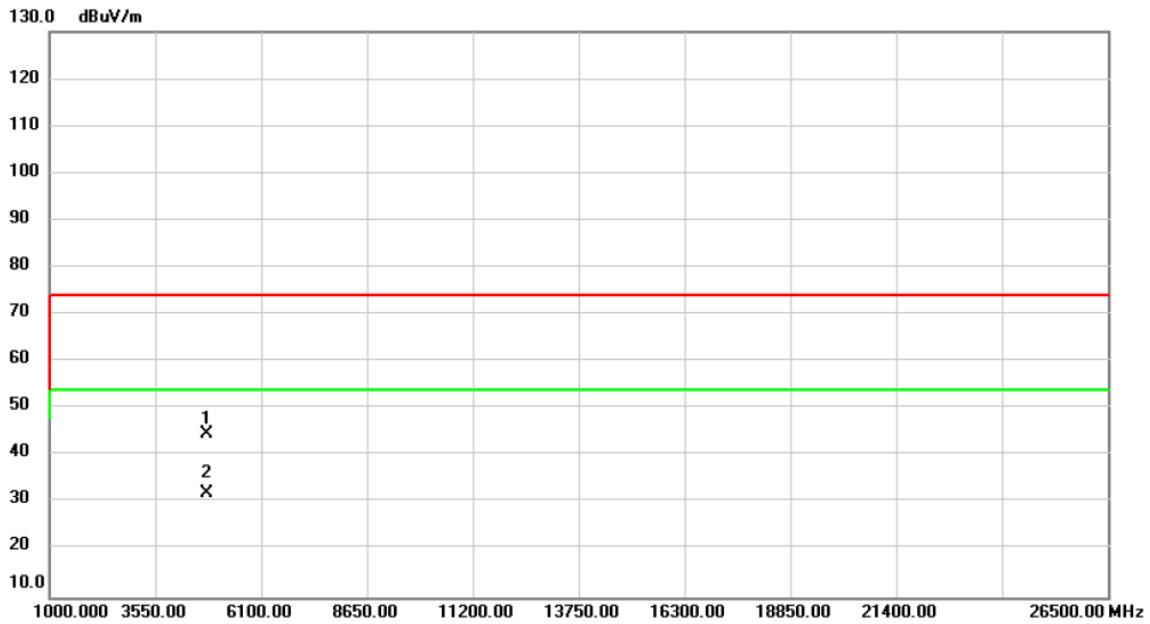

No.	Mk.	Freq.	Reading Level	Correct Factor	Measurement	Limit	Over	Detector	Comment
		MHz	dBuV	dB	dBuV/m	dBuV/m	dB		
1		4804.000	54.61	-10.03	44.58	74.00	-29.42	peak	
2	*	4804.000	42.12	-10.03	32.09	54.00	-21.91	AVG	

**REMARKS:**

- (1) Measurement Value = Reading Level + Correct Factor.
- (2) Margin Level = Measurement Value - Limit Value.



Test Mode	BLE 4.0	Test Date	2020/7/23
Test Frequency	CH19: 2440 MHz	Polarization	Vertical

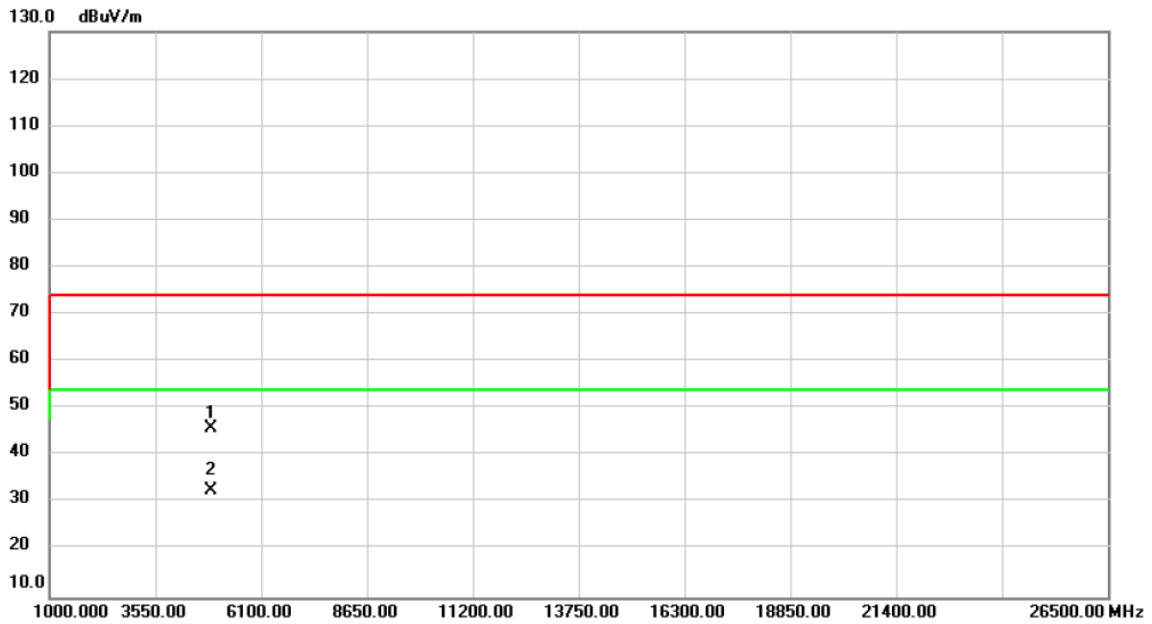

No.	Mk.	Freq.	Reading Level	Correct Factor	Measurement	Limit	Over	Detector	Comment
		MHz	dBuV	dB	dBuV/m	dBuV/m	dB		
1		4880.000	55.47	-9.77	45.70	74.00	-28.30	peak	
2	*	4880.000	42.52	-9.77	32.75	54.00	-21.25	AVG	

**REMARKS:**

- (1) Measurement Value = Reading Level + Correct Factor.
- (2) Margin Level = Measurement Value - Limit Value.

Test Mode	BLE 4.0	Test Date	2020/7/23
Test Frequency	CH19: 2440 MHz	Polarization	Horizontal

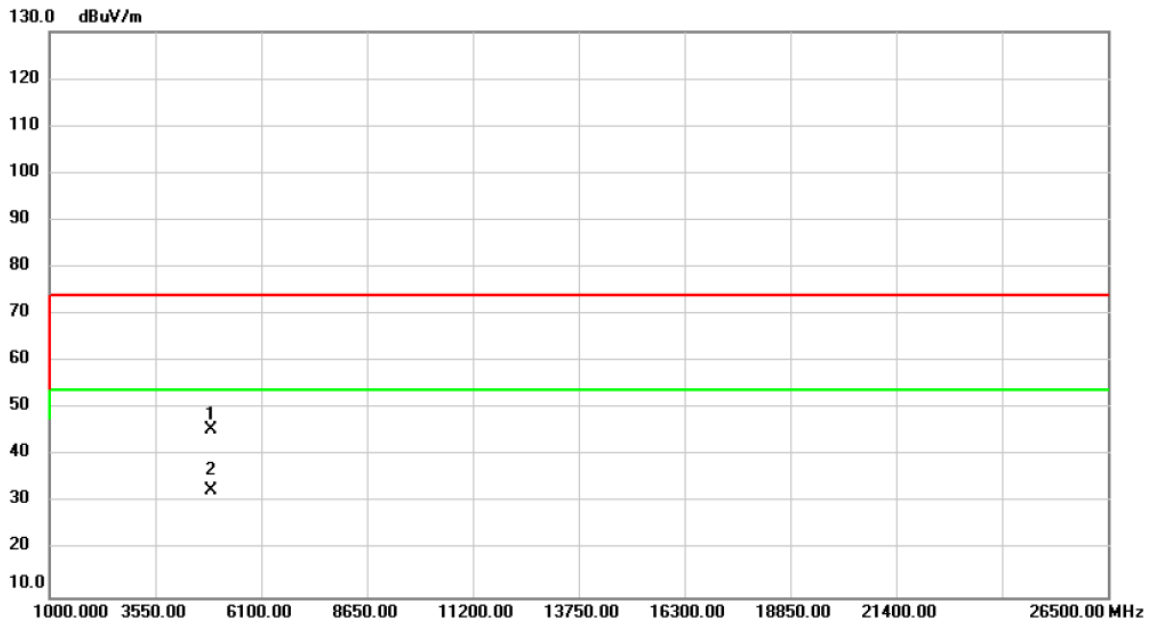

No.	Mk.	Freq.	Reading Level	Correct Factor	Measurement	Limit	Over	Detector	Comment
		MHz	dBuV	dB	dBuV/m	dBuV/m	dB		
1		4880.000	55.20	-9.77	45.43	74.00	-28.57	peak	
2	*	4880.000	42.47	-9.77	32.70	54.00	-21.30	AVG	

**REMARKS:**

- (1) Measurement Value = Reading Level + Correct Factor.
- (2) Margin Level = Measurement Value - Limit Value.

Test Mode	BLE 4.0	Test Date	2020/7/23
Test Frequency	CH39: 2480 MHz	Polarization	Vertical

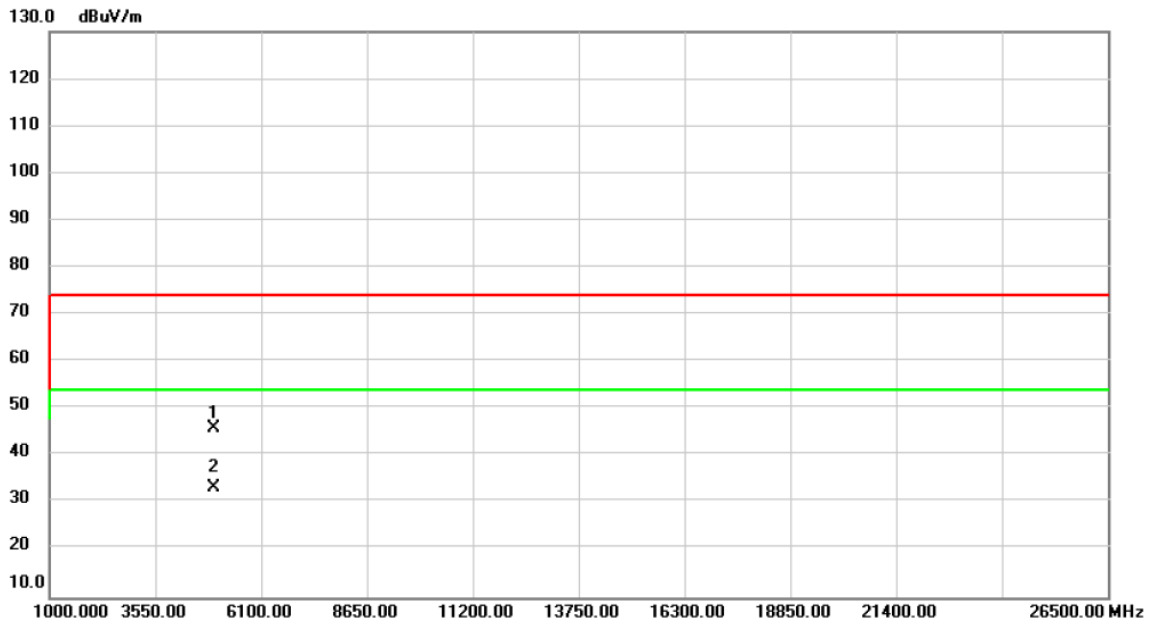

No.	Mk.	Freq.	Reading Level	Correct Factor	Measurement	Limit	Over	Detector	Comment
		MHz	dBuV	dB	dBuV/m	dBuV/m	dB		
1		4960.000	55.21	-9.49	45.72	74.00	-28.28	peak	
2	*	4960.000	42.80	-9.49	33.31	54.00	-20.69	AVG	

**REMARKS:**

- (1) Measurement Value = Reading Level + Correct Factor.
- (2) Margin Level = Measurement Value - Limit Value.

Test Mode	BLE 4.0	Test Date	2020/7/23
Test Frequency	CH39: 2480 MHz	Polarization	Horizontal

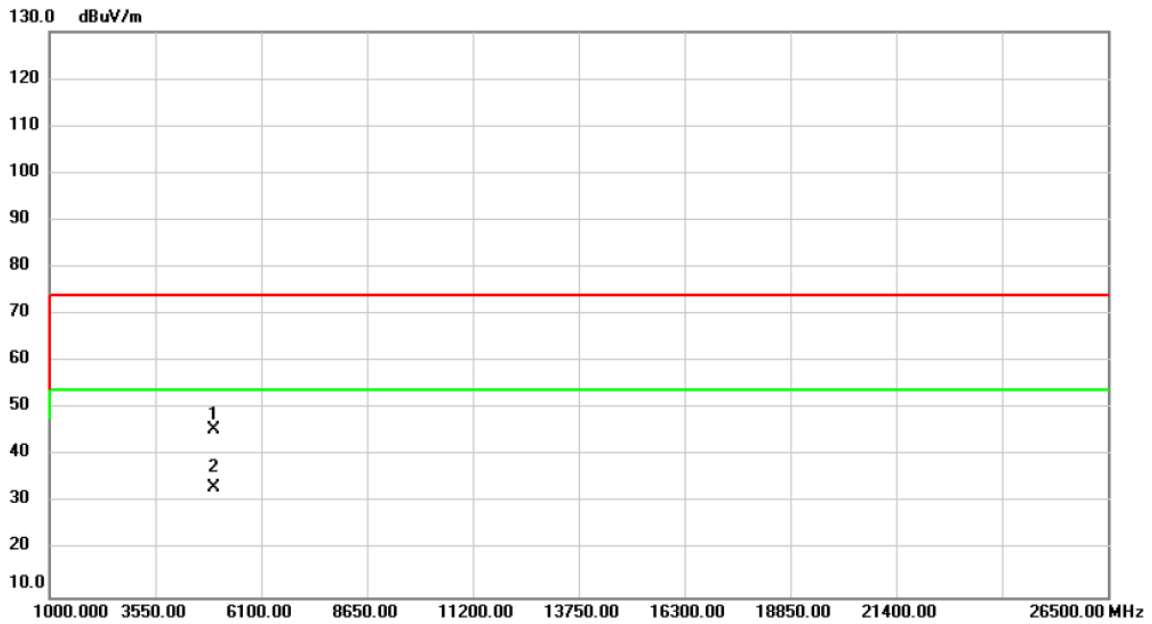

No.	Mk.	Freq.	Reading Level	Correct Factor	Measurement	Limit	Over	Detector	Comment
		MHz	dBuV	dB	dBuV/m	dBuV/m	dB		
1		4960.000	55.12	-9.49	45.63	74.00	-28.37	peak	
2	*	4960.000	42.84	-9.49	33.35	54.00	-20.65	AVG	

**REMARKS:**

- (1) Measurement Value = Reading Level + Correct Factor.
- (2) Margin Level = Measurement Value - Limit Value.

Test Mode	BLE 5.0	Test Date	2020/7/23
Test Frequency	CH00: 2402 MHz	Polarization	Vertical

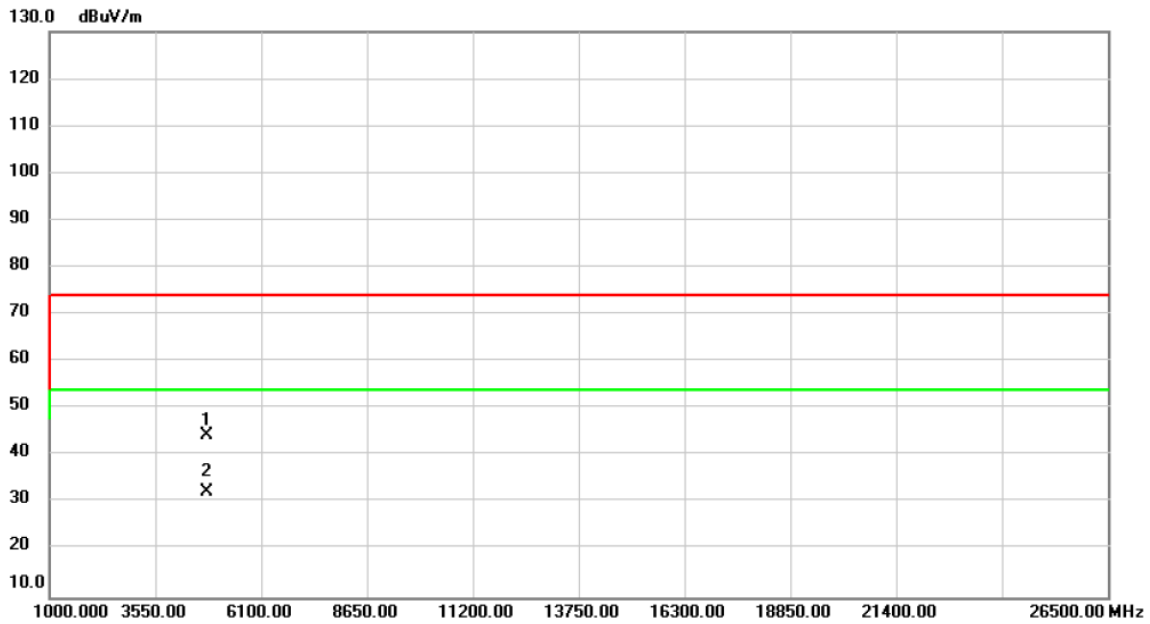

No.	Mk.	Freq.	Reading Level	Correct Factor	Measurement	Limit	Over	Detector	Comment
		MHz	dBuV	dB	dBuV/m	dBuV/m	dB		
1		4804.000	54.33	-10.03	44.30	74.00	-29.70	peak	
2	*	4804.000	42.33	-10.03	32.30	54.00	-21.70	AVG	

**REMARKS:**

- (1) Measurement Value = Reading Level + Correct Factor.
- (2) Margin Level = Measurement Value - Limit Value.

Test Mode	BLE 5.0	Test Date	2020/7/23
Test Frequency	CH00: 2402 MHz	Polarization	Horizontal

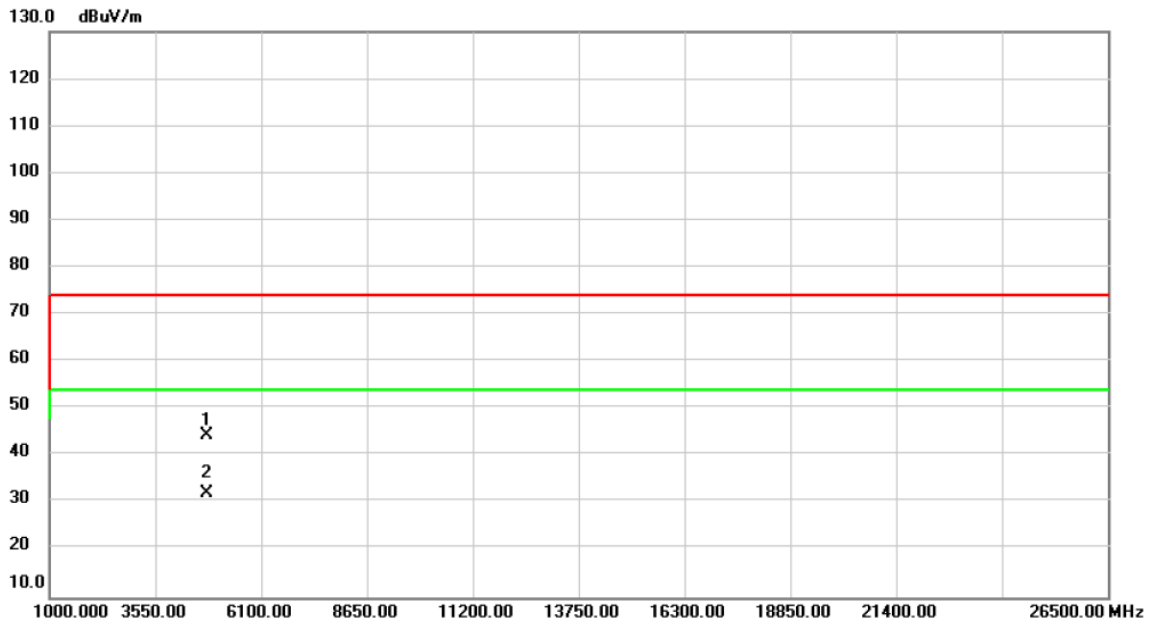

No.	Mk.	Freq.	Reading Level	Correct Factor	Measurement	Limit	Over	Detector	Comment
		MHz	dBuV	dB	dBuV/m	dBuV/m	dB		
1		4804.000	54.51	-10.03	44.48	74.00	-29.52	peak	
2	*	4804.000	42.08	-10.03	32.05	54.00	-21.95	AVG	

**REMARKS:**

- (1) Measurement Value = Reading Level + Correct Factor.
- (2) Margin Level = Measurement Value - Limit Value.

Test Mode	BLE 5.0	Test Date	2020/7/23
Test Frequency	CH19: 2440 MHz	Polarization	Vertical

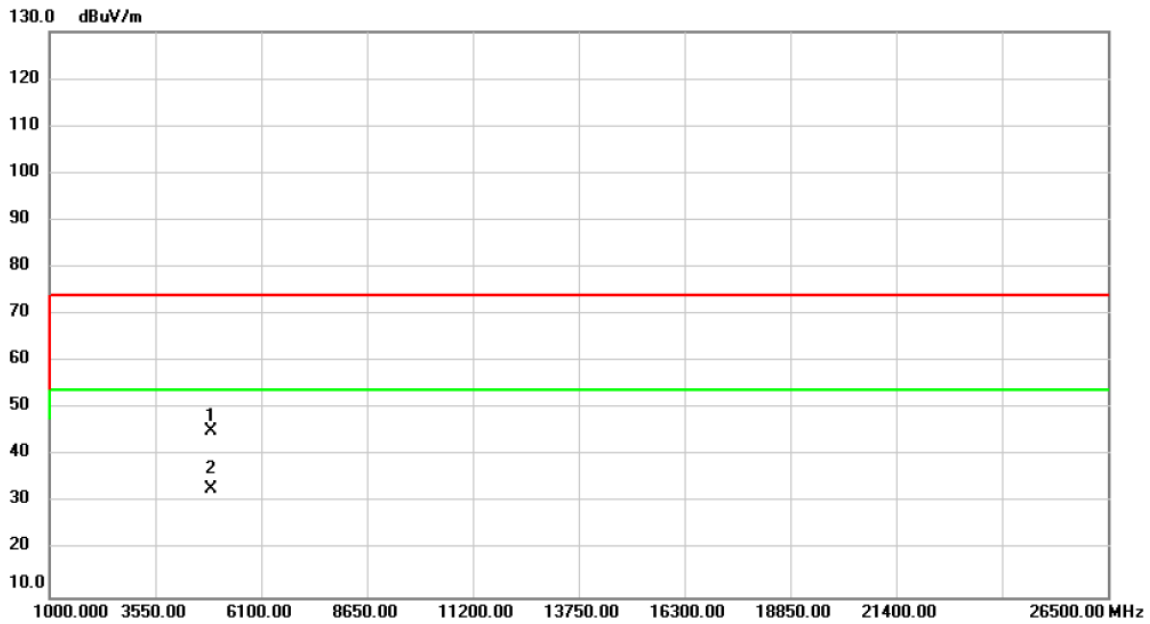

No.	Mk.	Freq.	Reading Level	Correct Factor	Measurement	Limit	Over	Detector	Comment
		MHz	dBuV	dB	dBuV/m	dBuV/m	dB		
1		4880.000	54.89	-9.77	45.12	74.00	-28.88	peak	
2	*	4880.000	42.72	-9.77	32.95	54.00	-21.05	AVG	

**REMARKS:**

- (1) Measurement Value = Reading Level + Correct Factor.
- (2) Margin Level = Measurement Value - Limit Value.

Test Mode	BLE 5.0	Test Date	2020/7/23
Test Frequency	CH19: 2440 MHz	Polarization	Horizontal

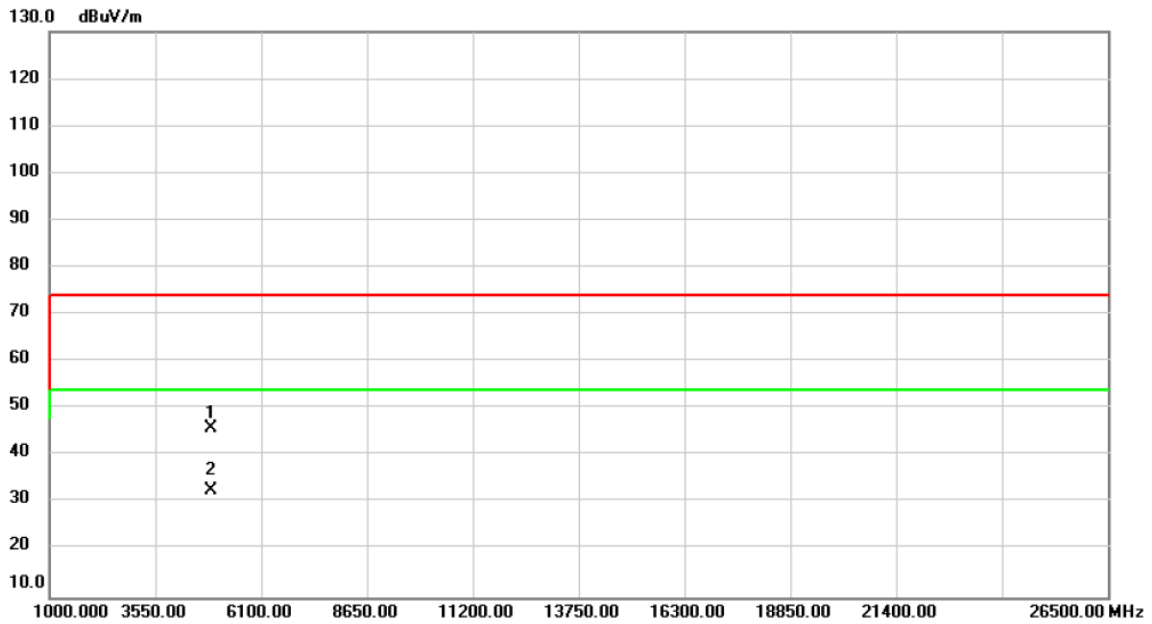

No.	Mk.	Freq.	Reading Level	Correct Factor	Measurement	Limit	Over	Detector	Comment
		MHz	dBuV	dB	dBuV/m	dBuV/m	dB		
1		4880.000	55.65	-9.77	45.88	74.00	-28.12	peak	
2	*	4880.000	42.43	-9.77	32.66	54.00	-21.34	AVG	

**REMARKS:**

- (1) Measurement Value = Reading Level + Correct Factor.
- (2) Margin Level = Measurement Value - Limit Value.



Test Mode	BLE 5.0	Test Date	2020/7/23
Test Frequency	CH39: 2480 MHz	Polarization	Vertical

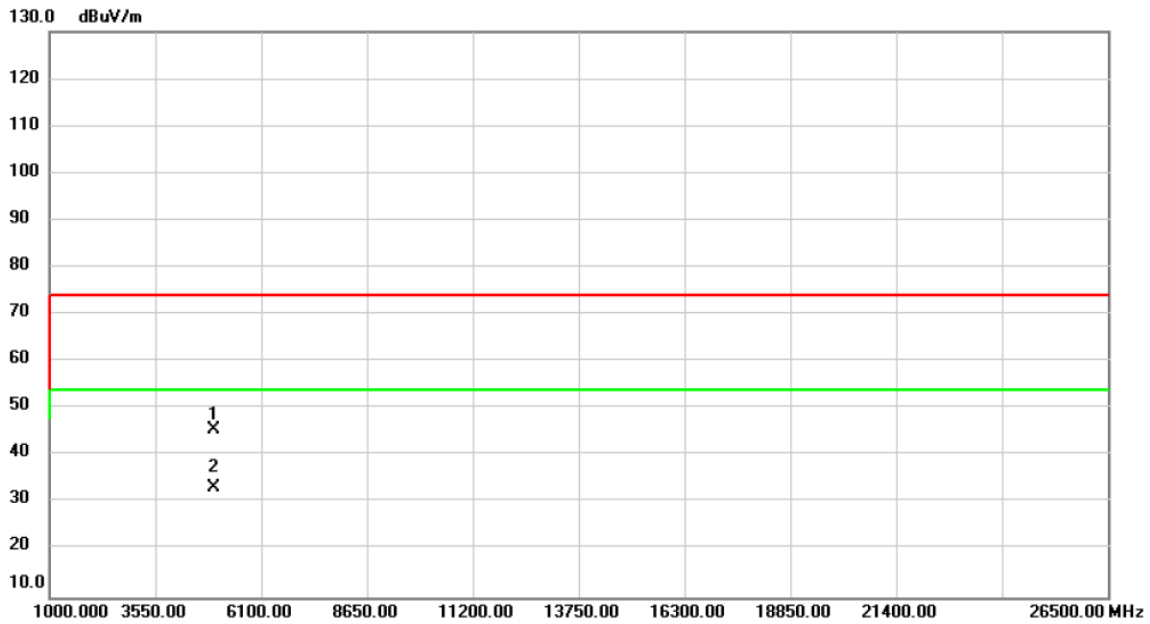

No.	Mk.	Freq.	Reading Level	Correct Factor	Measurement	Limit	Over	Detector	Comment
		MHz	dBuV	dB	dBuV/m	dBuV/m	dB		
1		4960.000	55.13	-9.49	45.64	74.00	-28.36	peak	
2	*	4960.000	42.76	-9.49	33.27	54.00	-20.73	AVG	

**REMARKS:**

- (1) Measurement Value = Reading Level + Correct Factor.
- (2) Margin Level = Measurement Value - Limit Value.

Test Mode	BLE 5.0	Test Date	2020/7/23
Test Frequency	CH39: 2480 MHz	Polarization	Horizontal

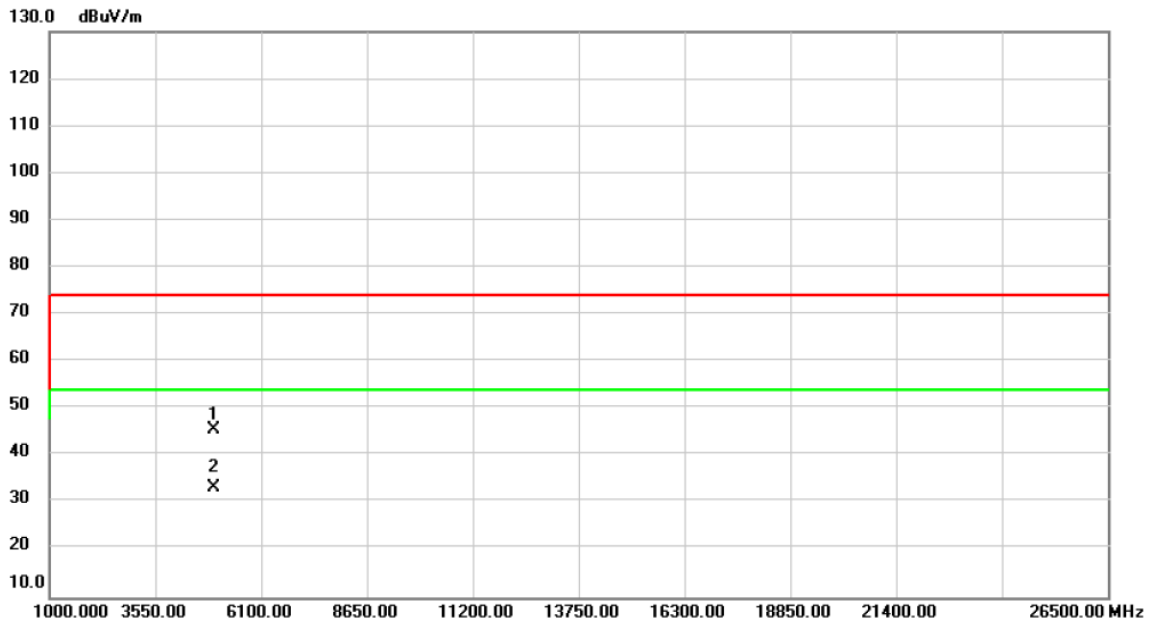

No.	Mk.	Freq.	Reading Level	Correct Factor	Measurement	Limit	Over	Detector	Comment
		MHz	dBuV	dB	dBuV/m	dBuV/m	dB		
1		4960.000	55.08	-9.49	45.59	74.00	-28.41	peak	
2	*	4960.000	42.81	-9.49	33.32	54.00	-20.68	AVG	

**REMARKS:**

- (1) Measurement Value = Reading Level + Correct Factor.
- (2) Margin Level = Measurement Value - Limit Value.

## APPENDIX D BANDWIDTH

Test Mode:	BLE 4.0
------------	---------

Frequency (MHz)	6dB Bandwidth (MHz)	99% Occupied BW (MHz)	Min. Limit (kHz)	Test Result
2402	0.66	1.05	500	Pass
2440	0.67	1.05	500	Pass
2480	0.67	1.04	500	Pass

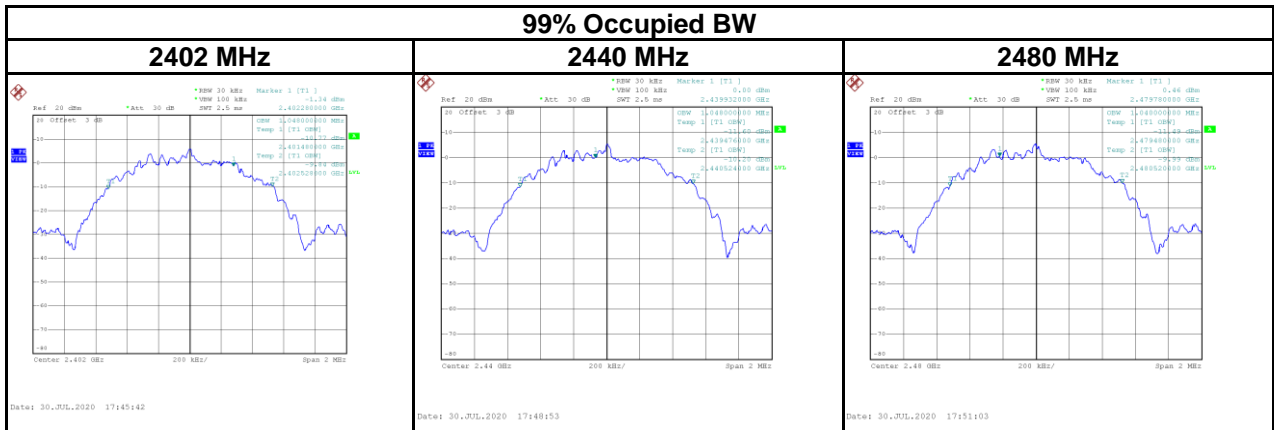
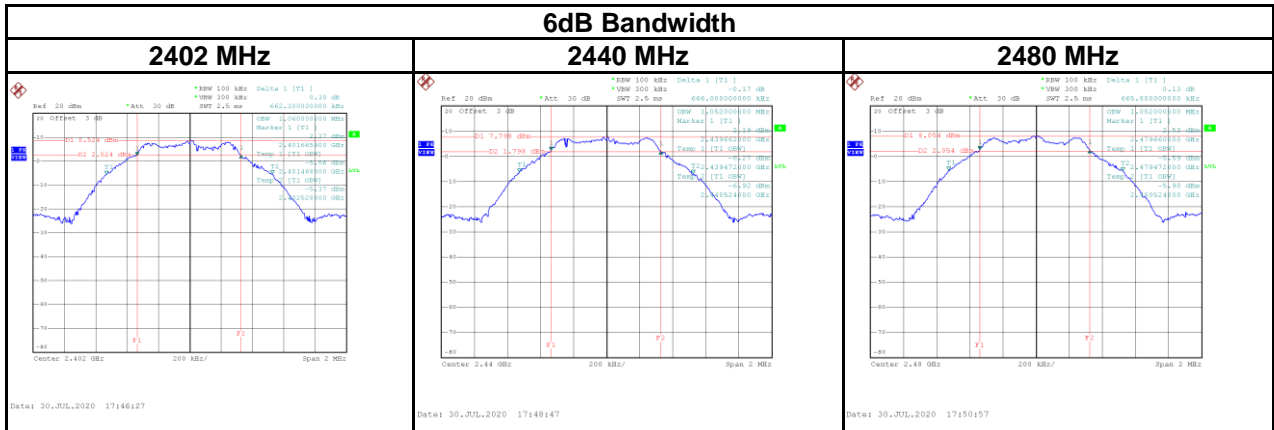

Test Mode:	BLE 5.0
------------	---------

Frequency (MHz)	6dB Bandwidth (MHz)	99% Occupied BW (MHz)	Min. Limit (kHz)	Test Result
2402	1.12	2.05	500	Pass
2440	1.11	2.04	500	Pass
2480	1.15	2.05	500	Pass

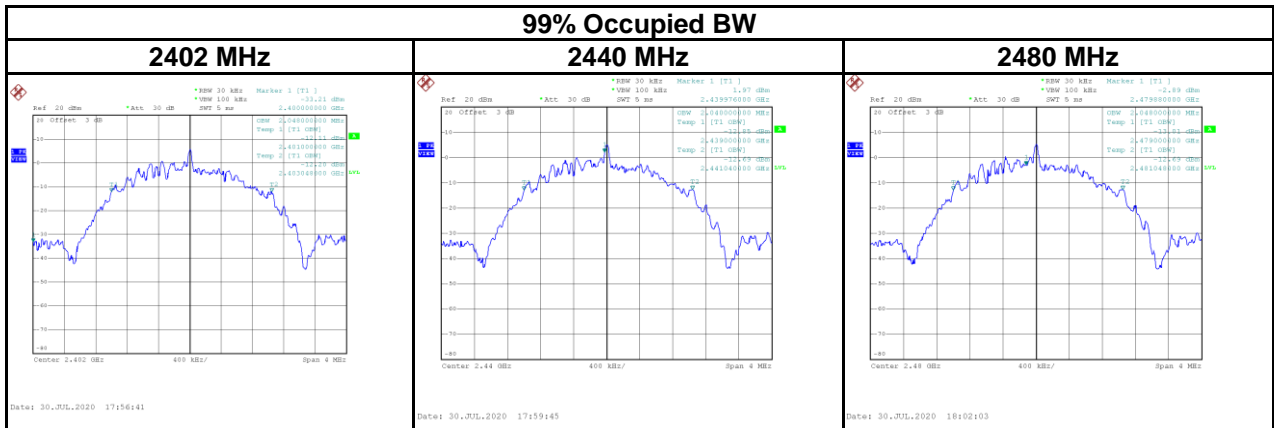
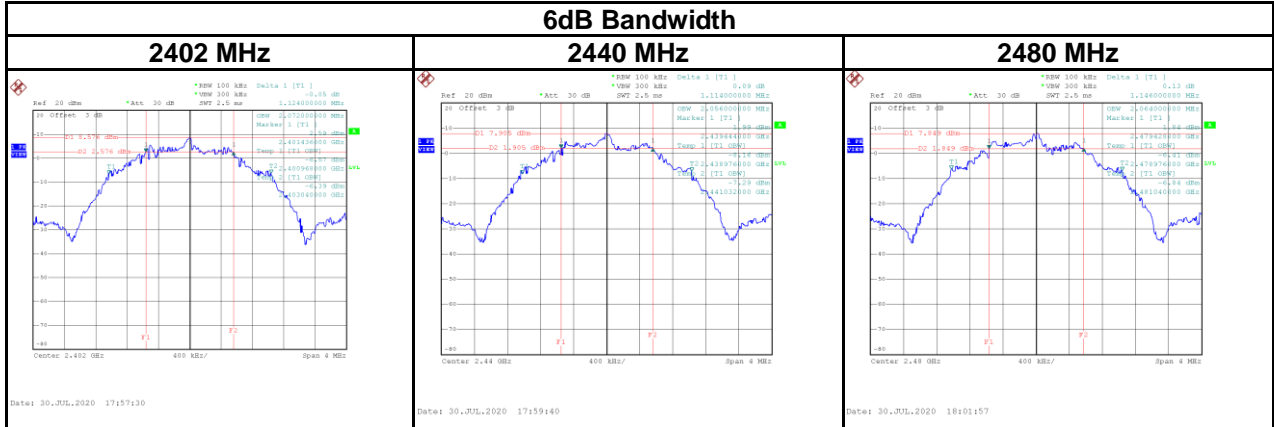

## APPENDIX E OUTPUT POWER

Test Mode :	BLE 4.0	Tested Date	2020/7/30
-------------	---------	-------------	-----------

Frequency (MHz)	Conducted Power (dBm)	Conducted Power (W)	Max. Limit (dBm)	Max. Limit (W)	Test Result
2402	8.81	0.0076	30.00	1.0000	Pass
2440	7.98	0.0063	30.00	1.0000	Pass
2480	8.18	0.0066	30.00	1.0000	Pass

Test Mode :	BLE 5.0	Tested Date	2020/7/30
-------------	---------	-------------	-----------

Frequency (MHz)	Conducted Power (dBm)	Conducted Power (W)	Max. Limit (dBm)	Max. Limit (W)	Test Result
2402	8.92	0.0078	30.00	1.0000	Pass
2440	8.07	0.0064	30.00	1.0000	Pass
2480	8.27	0.0067	30.00	1.0000	Pass

## APPENDIX F POWER SPECTRAL DENSITY TEST



Test Mode :	BLE 4.0
-------------	---------

Frequency (MHz)	Power Density (dBm/3kHz)	Max. Limit (dBm/3kHz)	Test Result
2402	-6.91	8	Pass
2440	-7.93	8	Pass
2480	-7.86	8	Pass

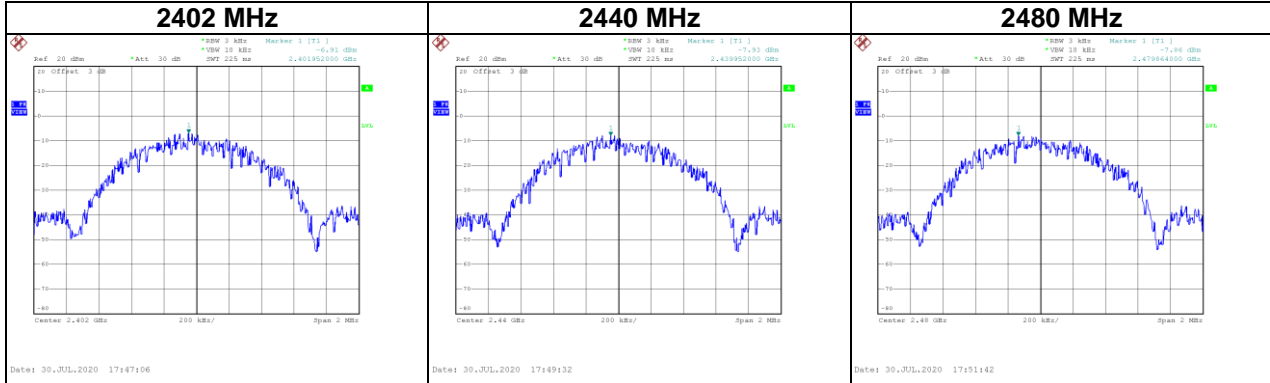

Test Mode :	BLE 5.0
-------------	---------

Frequency (MHz)	Power Density (dBm/3kHz)	Max. Limit (dBm/3kHz)	Test Result
2402	-9.26	8	Pass
2440	-10.18	8	Pass
2480	-9.88	8	Pass

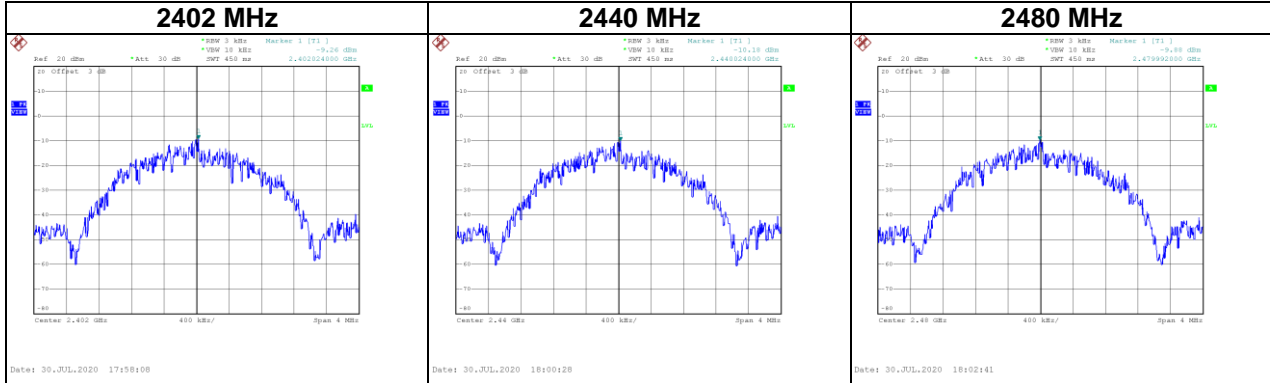

## **APPENDIX G ANTENNA CONDUCTED SPURIOUS EMISSION**

Test Mode : BLE 4.0

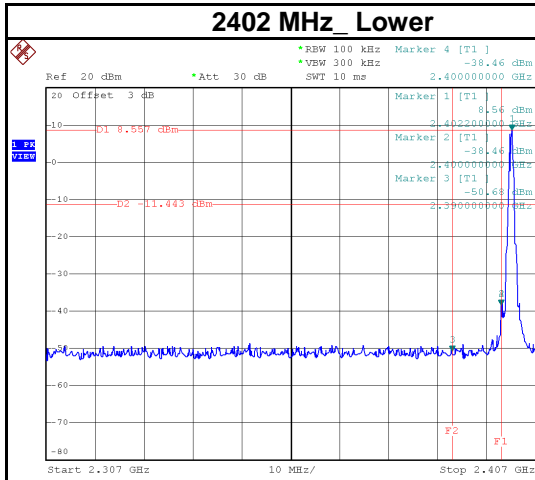

Date: 30.JUL.2020 17:46:34

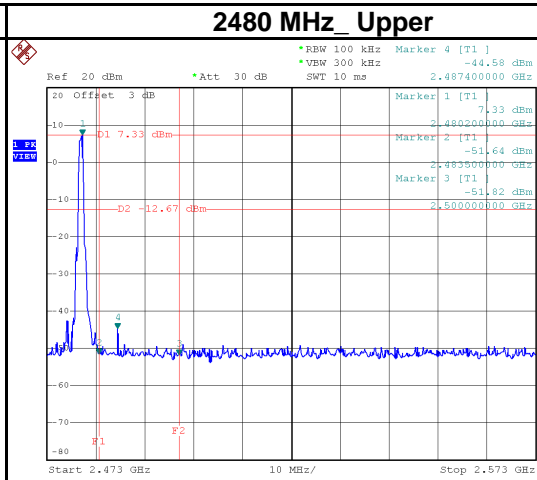

Date: 30.JUL.2020 17:51:10

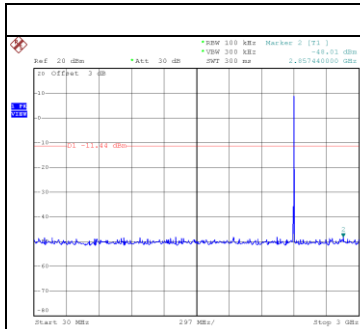

Date: 30.JUL.2020 17:46:47

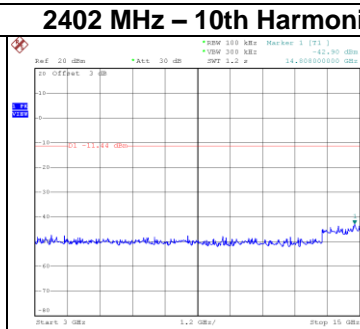

Date: 30.JUL.2020 17:46:53

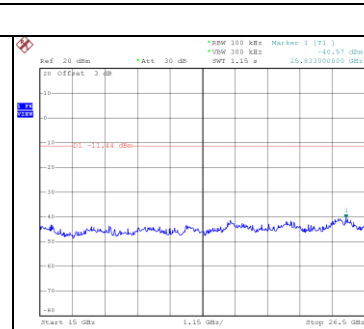

Date: 30.JUL.2020 17:47:00

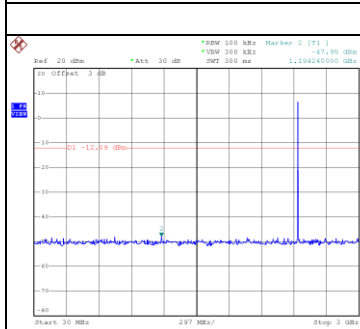

Date: 30.JUL.2020 17:49:12

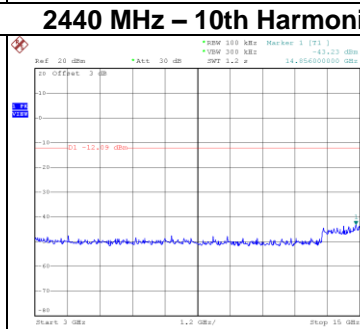

Date: 30.JUL.2020 17:49:19

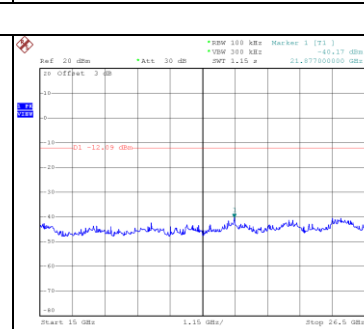

Date: 30.JUL.2020 17:49:26

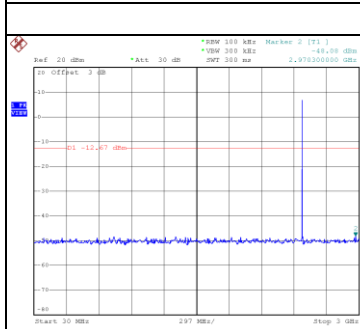

Date: 30.JUL.2020 17:51:23

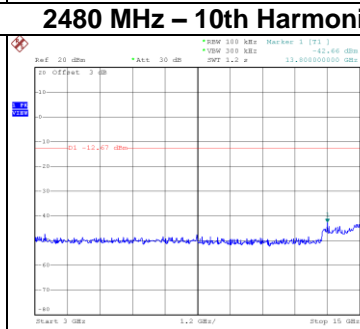

Date: 30.JUL.2020 17:51:30

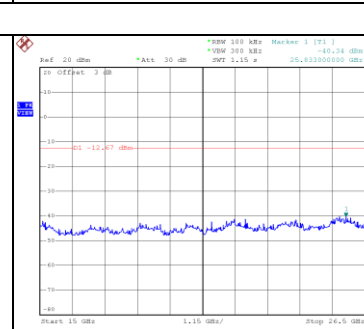

Date: 30.JUL.2020 17:51:36

Test Mode : BLE 5.0

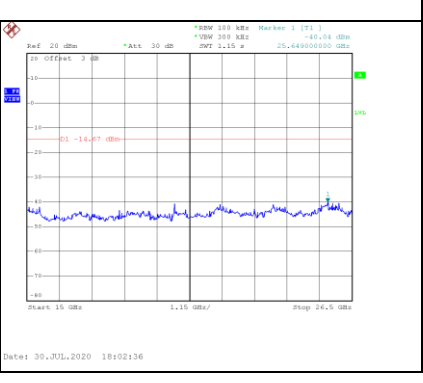
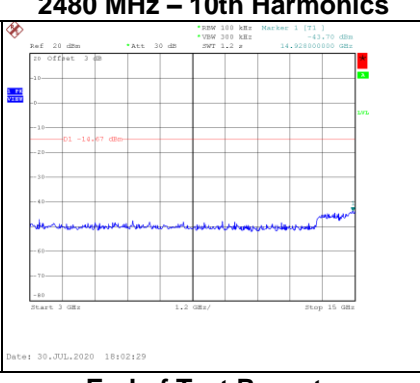
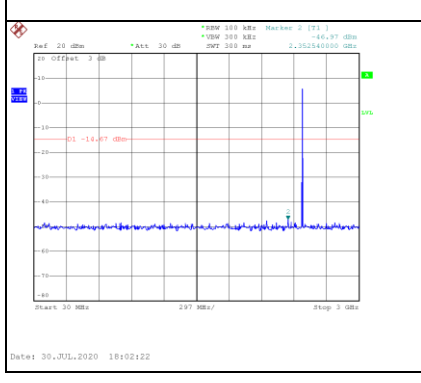
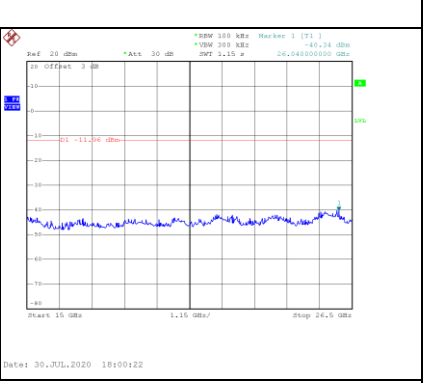
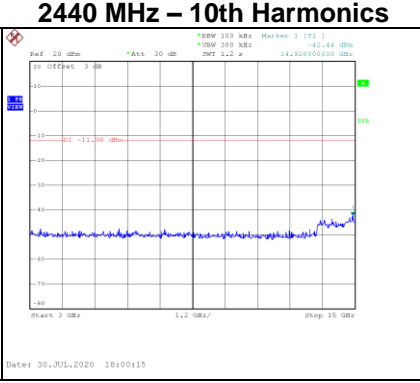
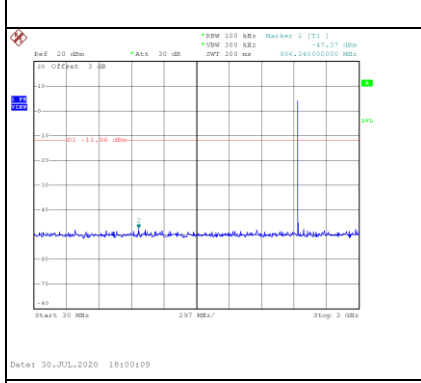
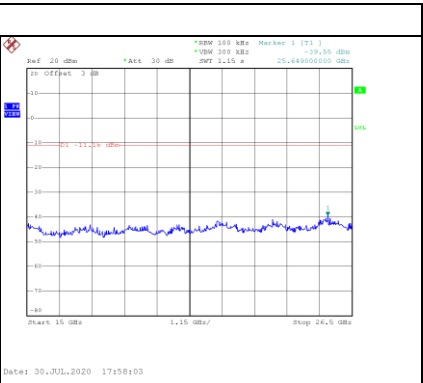
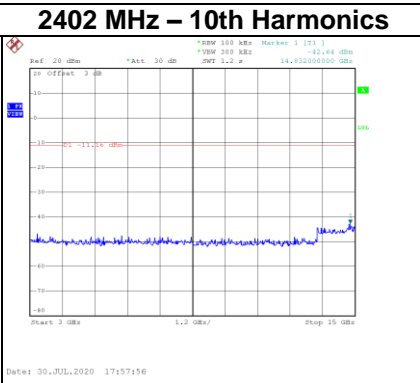
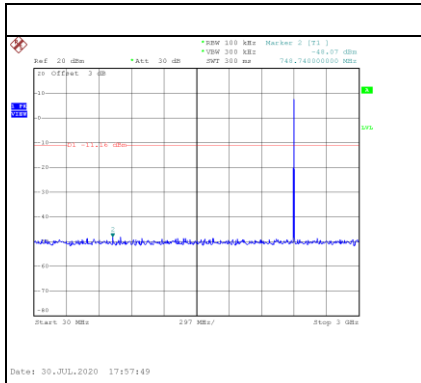
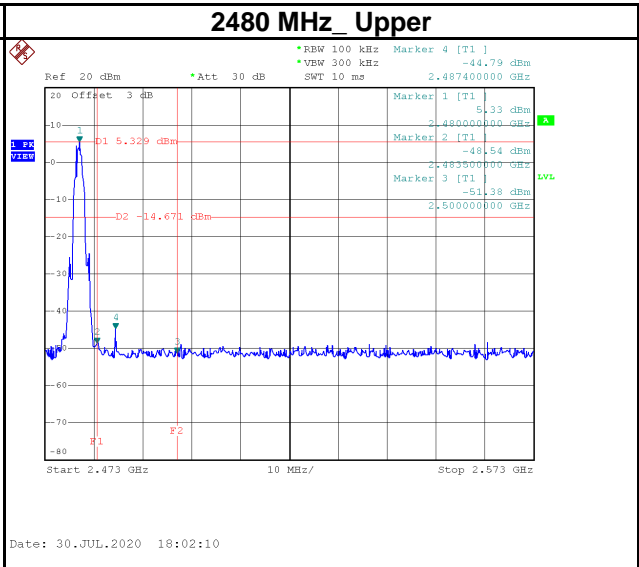
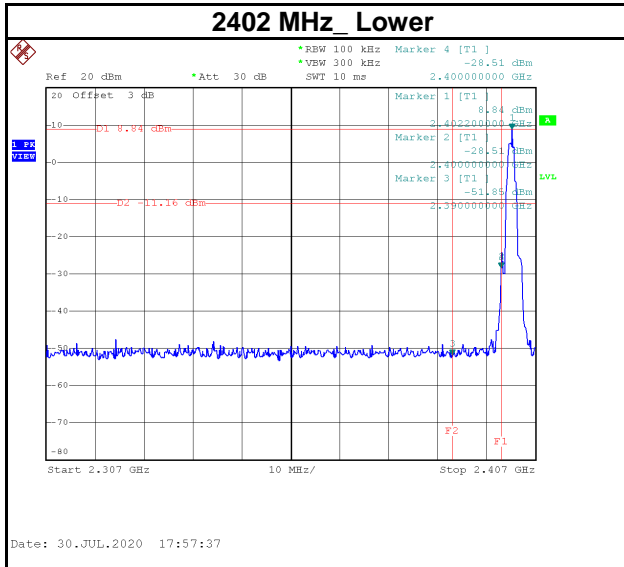

End of Test Report