



A D T

FCC TEST REPORT (Part 24)

REPORT NO.: RF110104E07-3

MODEL NO.: Dolphin 6000

FCC ID: HD5D6000

RECEIVED: Jan. 04, 2011

TESTED: Jan. 18 to Feb. 09, 2011

ISSUED: Mar. 11, 2011

APPLICANT: Honeywell International Inc

ADDRESS: 9680 OLD BAILES RD FORT MILL SC 29707
UNITED STATES

ISSUED BY: Bureau Veritas Consumer Products Services (H.K.)
Ltd., Taoyuan Branch Hsin Chu Laboratory

LAB ADDRESS : No. 81-1, Lu Liao Keng, 9th Ling, Wu Lung Tsuen,
Chiung Lin Hsiang, Hsin Chu Hsien 307, Taiwan

This test report consists of 63 pages in total. It may be duplicated completely for legal use with the approval of the applicant. It should not be reproduced except in full, without the written approval of our laboratory. The client should not use it to claim product endorsement by any government agencies. The test results in the report only apply to the tested sample.



TABLE OF CONTENTS

RELEASE CONTROL RECORD	4
1 CERTIFICATION	5
2 SUMMARY OF TEST RESULTS.....	6
2.1 MEASUREMENT UNCERTAINTY	7
3 GENERAL INFORMATION	8
3.1 GENERAL DESCRIPTION OF EUT	8
3.2 DESCRIPTION OF TEST MODES	11
3.2.1 TEST MODE APPLICABILITY AND TESTED CHANNEL DETAIL	12
3.3 GENERAL DESCRIPTION OF APPLIED STANDARDS	15
3.4 DESCRIPTION OF SUPPORT UNITS.....	16
3.5 CONFIGURATION OF SYSTEM UNDER TEST	16
4 TEST TYPES AND RESULTS.....	17
4.1 OUTPUT POWER MEASUREMENT	17
4.1.1 LIMITS OF OUTPUT POWER MEASUREMENT	17
4.1.2 TEST INSTRUMENTS.....	18
4.1.3 TEST PROCEDURES	19
4.1.4 TEST SETUP	20
4.1.5 EUT OPERATING CONDITIONS.....	21
4.1.6 TEST RESULTS	22
4.2 FREQUENCY STABILITY MEASUREMENT	25
4.2.1 LIMITS OF FREQUENCY STABILITY MEASUREMENT	25
4.2.2 TEST INSTRUMENTS.....	25
4.2.3 TEST PROCEDURE.....	26
4.2.4 TEST SETUP	26
4.2.5 TEST RESULTS	27
4.3 OCCUPIED BANDWIDTH MEASUREMENT	28
4.3.1 LIMITS OF OCCUPIED BANDWIDTH MEASUREMENT	28
4.3.2 TEST INSTRUMENTS.....	28
4.3.3 TEST SETUP	28
4.3.4 TEST PROCEDURES	29
4.3.5 EUT OPERATING CONDITION	29
4.3.6 TEST RESULTS	30
4.4 BAND EDGE MEASUREMENT	36
4.4.1 LIMITS OF BAND EDGE MEASUREMENT	36
4.4.2 TEST INSTRUMENTS.....	36
4.4.3 TEST SETUP	36
4.4.4 TEST PROCEDURES	37
4.4.5 EUT OPERATING CONDITION	37
4.4.6 TEST RESULTS	38
4.5 CONDUCTED SPURIOUS EMISSIONS.....	41
4.5.1 LIMITS OF CONDUCTED SPURIOUS EMISSIONS MEASUREMENT	41
4.5.2 TEST INSTRUMENTS.....	41
4.5.3 TEST PROCEDURE.....	42



A D T

4.5.4	TEST SETUP	42
4.5.5	EUT OPERATING CONDITIONS.....	42
4.5.6	TEST RESULTS	43
4.6	RADIATED EMISSION MEASUREMENT (BELOW 1GHZ).....	49
4.6.1	LIMITS OF RADIATED EMISSION MEASUREMENT	49
4.6.2	TEST INSTRUMENTS.....	50
4.6.3	TEST PROCEDURES	51
4.6.4	DEVIATION FROM TEST STANDARD	52
4.6.5	TEST SETUP	52
4.6.6	EUT OPERATING CONDITIONS.....	52
4.6.7	TEST RESULTS	53
4.7	RADIATED EMISSION MEASUREMENT (ABOVE 1GHZ)	54
4.7.1	LIMITS OF RADIATED EMISSION MEASUREMENT	54
4.7.2	TEST INSTRUMENTS.....	55
4.7.3	TEST PROCEDURES	56
4.7.4	DEVIATION FROM TEST STANDARD	56
4.7.5	TEST SETUP	57
4.7.6	EUT OPERATING CONDITIONS.....	57
4.7.7	TEST RESULTS	58
5	PHOTOGRAPHS OF THE TEST CONFIGURATION.....	61
6	INFORMATION ON THE TESTING LABORATORIES	62
7	APPENDIX A – MODIFICATIONS RECORDERS FOR ENGINEERING CHANGES TO THE EUT BY THE LAB.....	63



A D T

RELEASE CONTROL RECORD

ISSUE NO.	REASON FOR CHANGE	DATE ISSUED
Original release	NA	Mar. 11, 2011



1 CERTIFICATION

PRODUCT : Mobile Computer
BRAND : Honeywell
MODEL NO.: Dolphin 6000
APPLICANT : Honeywell International Inc
TESTED : Jan. 18 to Feb. 09, 2011
TEST SAMPLE : ENGINEERING SAMPLE
STANDARDS : **FCC Part 24, Subpart E**
ANSI C63.4-2003

The above equipment (model: Dolphin 6000) has been tested by **Bureau Veritas Consumer Products Services (H.K.) Ltd., Taoyuan Branch**, and found compliance with the requirement of the above standards. The test record, data evaluation & Equipment Under Test (EUT) configurations represented herein are true and accurate accounts of the measurements of the sample's EMC characteristics under the conditions specified in this report.

PREPARED BY : Midoli Peng, **DATE:** Mar. 11, 2011
(Midoli Peng, Specialist)

APPROVED BY : May Chen, **DATE:** Mar. 11, 2011
(May Chen, Deputy Manager)

2 SUMMARY OF TEST RESULTS

The EUT has been tested according to the following specifications:

APPLIED STANDARD: FCC Part 24 & Part 2			
STANDARD SECTION	TEST TYPE AND LIMIT	RESULT	REMARK
2.1046 24.232	Maximum Peak Output Power Limit: max. 2 watts e.i.r.p peak power	PASS	Meet the requirement of limit.
2.1055 24.235	Frequency Stability AFC Freq. Error vs. Voltage AFC Freq. Error vs. Temperature Limit: max. ± 2.5 ppm	PASS	Meet the requirement of limit.
2.1049 24.238(b)	Occupied Bandwidth	PASS	Meet the requirement of limit.
24.238(b)	Band Edge Measurements	PASS	Meet the requirement of limit.
2.1051 24.238	Conducted Spurious Emissions	PASS	Meet the requirement of limit.
2.1053 24.238	Radiated Spurious Emissions	PASS	Meet the requirement of limit. Minimum passing margin is -17.40dB at 14801.6MHz.



A D T

2.1 MEASUREMENT UNCERTAINTY

Where relevant, the following measurement uncertainty levels have been estimated for tests performed on the EUT as specified in CISPR 16-4-2:

This uncertainty represents an expanded uncertainty expressed at approximately the 95% confidence level using a coverage factor of $k=2$.

Measurement	Value
Radiated emissions (30MHz-1GHz)	3.94 dB
Radiated emissions (1GHz -18GHz)	2.49 dB
Radiated emissions (18GHz -40GHz)	2.70 dB

3 GENERAL INFORMATION

3.1 GENERAL DESCRIPTION OF EUT

PRODUCT	Mobile Computer
MODEL NO.	Dolphin 6000
FCC ID	HD5D6000
POWER SUPPLY	DC 3.7V from battery or DC 5V from adapter or DC 5V from car charger
MODULATION TYPE	GMSK / 8PSK
RADIO TECHNOLOGY	GSM / GPRS / E-GPRS
OPERATING FREQUENCY	1850MHz ~ 1910MHz
NUMBER OF CHANNEL	299
MAX. EIRP POWER	GSM Mode: 31.7dBm (1.4831Watts) GPRS Mode: 31.7dBm (1.4729Watts) E-GPRS Mode: 28.1dBm (0.6489Watts)
ANTENNA TYPE	Please see note 2
MAX. ANTENNA GAIN	Please see note 2
DATA CABLE	USB charger cable(Shielded, 1.2m with one core) x 1
I/O PORTS	micro SD port x 1
ASSOCIATED DEVICES	Battery, Adapter, Car Charger

NOTE:

1. There are Bluetooth technology (BT2.1+EDR), WLAN, GPS and GSM technology used for the EUT. and the functions of EUT listed as below table:

Function	Report No.
WLAN	RF110104E07
Bluetooth	RF110104E07-1
GSM	RF110104E07-2 (Part 22) RF110104E07-3 (Part 24)



A D T

2. There are three antennas provided to this EUT, please refer to the following table:

WLAN / Bluetooth Antenna Spec.				
No.	Antenna Type	Gain(dBi)	Connector Type	Frequency range (MHz)
1	PIFA	3	NA	2.4 ~ 2.5 GHz
GPS Antenna Spec.				
No.	Antenna Type	Gain(dBi)	Connector Type	Frequency range (MHz)
1	Patch	2	U.FL	1.575GHz
WWAM Antenna Spec.				
No.	Antenna Type	Gain(dBi)	Connector Type	Frequency range (MHz)
1	PIFA	3	NA	850/1900

3. The EUT was manufactured by following manufacture and factory:

Manufacturer	Manufacturer Address
Honeywell International Inc	9680 OLD BAILES RD FORT MILL SC 29707 UNITED STATES
Factory	Factory Address
Universal Scientific Industrial Co., Ltd.	141, Lane 351, Taiping Rd., Sec. 1, Tsao Tuen, Nan-Tou Hsien, Taiwan
Universal Scientific Industrial de Mexico, S.A de C.V.	Periferico Manuel Gomez Morin #656 R. Santa Isabel, Anillo 44290 Guadalajara, Jal Mexico
USI Electronics (Shenzhen)Co., Ltd.	USI Electronics Park, North of High-Tech Industry Park, Nanshan District, Shenzhen, Guangdong, China
Universal Scientific Industrial (Shanghai) Co., Ltd.	NO. 1558, ZHANGDONG RD. PUDONG SHANGHAI 201203 CHINA
Universal Global Technology (Shenzhen) Co., Ltd.	1&2&4 Floor of Building B and 2 Floor of Building C, USI Electronics Park NanShan District, ShenZhen, P.R.C 518057
Universal Scientific Industrial Co., Ltd.	1F&4F No.135, Lane 351, Taiping Road, Sec. 1, Tsao Tuen Nan-Tou, Taiwan
Universal Global Scientific Industrial Co., Ltd.	B1, 1~3F & 5F, No.135, Lane 351, Taiping Road, Sec. 1, Tsao Tuen Nan-Tou, Taiwan

4. The EUT could be supplied with a power adapter, Car Charger and battery as below table:

Battery	
Brand:	Palladium
Part No.:	Dolphin 6000 Battery
Rating:	3.7V, 1530mAh, 5.7Wh
Adapter	
Brand:	Sunfone
Model No.:	ACW010A3-05Z
Input power :	100-240V, 50-60Hz, 0.4A
Output power :	5V, 2A DC output cable(unshielded, 1.4m)
Car Charger	
Brand:	Atech OEM Inc.
Model No.:	C15C-0520CD0-S3
Input power :	12-24V
Output power :	5V, 2A DC output cable (unshielded, 1.5m)

5. The EUT was pre-tested in chamber under following test modes :

Pre-test Mode	Description
Mode A	X-Y plane: EUT + Battery
Mode B	X-Z plane: EUT + Battery
Mode C	Y-Z plane: EUT + Battery
Mode D	X-Y plane: EUT + USB charger cable + Adapter
Mode E	X-Z plane: EUT + USB charger cable + Adapter
Mode F	Y-Z plane: EUT + USB charger cable + Adapter
Mode G	X-Y plane: EUT + USB charger cable + Car charger
Mode H	X-Z plane: EUT + USB charger cable + Car charger
Mode I	Y-Z plane: EUT + USB charger cable + Car charger

The worse radiated emission was found in **Mode D**. Therefore only the test data of the modes were recorded in this report.

6. The above EUT information was declared by manufacturer and for more detailed features description, please refer to the manufacturer's specifications or user's manual.



A D T

3.2 DESCRIPTION OF TEST MODES

299 channels are provided to this EUT. Therefore, the low, middle and high channels are chosen for testing.

	CHANNEL	FREQUENCY	TX MODE
LOW	512	1850.2 MHz	GSM, GPRS, E-GPRS
MIDDLE	661	1880.0 MHz	GSM, GPRS, E-GPRS
HIGH	810	1909.8 MHz	GSM, GPRS, E-GPRS

NOTE:

1. Below 1 GHz, the channel 512, 661, and 810 were pre-tested in chamber. The channel 810 was chosen for final test.
2. Above 1 GHz, the channel 512, 661, and 810 were tested individually.
3. The worst case for final test is chosen when the power control level set 5.
4. The channel space is 0.2MHz.
5. The EUT is a GPRS class 10 device, which provide 2 up-link. After pre-tested both functions, found up-link with 1 time slot is worse, therefore, test results of output power, frequency stability, occupied bandwidth and band edge tests came out from this.
6. The EUT is an E-GPRS class 10 device, which provide 2 up-link. After pre-tested both functions, found up-link with 1 time slot is worse, therefore, test results of output power, frequency stability, occupied bandwidth and band edge tests came out from this.
7. The EUT has GSM, GPRS, E-GPRS functions. After pre-testing, GSM function is the worst case for all the emission tests.



3.2.1 TEST MODE APPLICABILITY AND TESTED CHANNEL DETAIL

EUT CONFIGURE MODE	APPLICABLE TO							DESCRIPTION
	OP	FS	OB	BE	CE	RE<1G	RE [≥] 1G	
-	√	√	√	√	√	√	√	X-Y plane: EUT + USB charger cable + Adapter

Where **OP**: Output power **FS**: Frequency stability
OB: Occupied bandwidth **BE**: Band edge
CE: Conducted spurious emissions **RE<1G**: Radiated emission below 1GHz
RE[≥]1G: Radiated emission above 1GHz

OUTPUT POWER MEASUREMENT:

- Pre-Scan has been conducted to determine the worst-case mode from all possible combinations between available modulations, data rates, xyz axis and antenna ports (if EUT with antenna diversity architecture).
- Following channel(s) was (were) selected for the final test as listed below.

AVAILABLE CHANNEL	TESTED CHANNEL	MODULATION TECHNOLOGY
512 to 810	512, 661, 810	GSM , GPRS, E-GPRS

FREQUENCY STABILITY MEASUREMENT:

- Pre-Scan has been conducted to determine the worst-case mode from all possible combinations between available modulations, data rates, and antenna ports (if EUT with antenna diversity architecture).
- Following channel(s) was (were) selected for the final test as listed below.

AVAILABLE CHANNEL	TESTED CHANNEL	MODULATION TECHNOLOGY
512 to 810	661	GSM

OCCUPIED BANDWIDTH MEASUREMENT:

- Pre-Scan has been conducted to determine the worst-case mode from all possible combinations between available modulations, data rates, and antenna ports (if EUT with antenna diversity architecture).
- Following channel(s) was (were) selected for the final test as listed below.

AVAILABLE CHANNEL	TESTED CHANNEL	MODULATION TECHNOLOGY
512 to 810	512, 661, 810	GSM , GPRS, E-GPRS

BAND EDGE MEASUREMENT:

- Pre-Scan has been conducted to determine the worst-case mode from all possible combinations between available modulations, data rates, and antenna ports (if EUT with antenna diversity architecture).
- Following channel(s) was (were) selected for the final test as listed below.

AVAILABLE CHANNEL	TESTED CHANNEL	MODULATION TECHNOLOGY
512 to 810	512, 810	GSM , GPRS, E-GPRS

CONDUCTED SPURIOUS EMISSIONS MEASUREMENT:

- Pre-Scan has been conducted to determine the worst-case mode from all possible combinations between available modulations, data rates, and antenna ports (if EUT with antenna diversity architecture).
- Following channel(s) was (were) selected for the final test as listed below.

AVAILABLE CHANNEL	TESTED CHANNEL	MODULATION TECHNOLOGY
512 to 810	512, 661, 810	GSM

RADIATED EMISSION MEASUREMENT (BELOW 1 GHz):

- Pre-Scan has been conducted to determine the worst-case mode from all possible combinations between available modulations, data rates, xyz axis and antenna ports (if EUT with antenna diversity architecture).
- Following channel(s) was (were) selected for the final test as listed below.

AVAILABLE CHANNEL	TESTED CHANNEL	MODULATION TECHNOLOGY
512 to 810	810	GSM



A D T

RADIATED EMISSION MEASUREMENT (ABOVE 1 GHz):

- Pre-Scan has been conducted to determine the worst-case mode from all possible combinations between available modulations, data rates, xyz axis and antenna ports (if EUT with antenna diversity architecture).
- Following channel(s) was (were) selected for the final test as listed below.

AVAILABLE CHANNEL	TESTED CHANNEL	MODULATION TECHNOLOGY
512 to 810	512, 661, 810	GSM

TEST CONDITION:

APPLICABLE TO	ENVIRONMENTAL CONDITIONS	INPUT POWER	TESTED BY
OP	18deg. C, 63%RH, 1024 hPa	120Vac, 60Hz	Wen Yu
FS	18deg. C, 63%RH, 1024 hPa	120Vac, 60Hz	Wen Yu
OB	18deg. C, 63%RH, 1024 hPa	120Vac, 60Hz	Wen Yu
EM	18deg. C, 63%RH, 1024 hPa	120Vac, 60Hz	Wen Yu
BE	18deg. C, 63%RH, 1024 hPa	120Vac, 60Hz	Wen Yu
CE	18deg. C, 63%RH, 1024 hPa	120Vac, 60Hz	Wen Yu
RE < 1G	18deg. C, 63%RH, 1024 hPa	120Vac, 60Hz	Wen Yu
RE ³ 1G	18deg. C, 63%RH, 1024 hPa	120Vac, 60Hz	Wen Yu

3.3 GENERAL DESCRIPTION OF APPLIED STANDARDS

The EUT is a RF product. According to the specifications of the manufacturer, it must comply with the requirements of the following standards:

FCC 47 CFR Part 2

FCC 47 CFR Part 24

ANSI C63.4-2003

ANSI/TIA/EIA-603-C 2004

NOTE: All test items have been performed and recorded as per the above standards.

3.4 DESCRIPTION OF SUPPORT UNITS

The EUT has been tested as an independent unit together with other necessary accessories or support units. The following support units or accessories were used to form a representative test configuration during the tests.

NO.	PRODUCT	BRAND	MODEL NO.	SERIAL NO.	FCC ID
1	NOTEBOOK COMPUTER	DELL	E6400	D814C A00 APCC	FCC DoC
2	PRINTER	CANON	K10202	FASF84644	FCC DoC
3	iPod	APPLE	A1199	YM712NB3VQ5	FCC DoC

NO.	SIGNAL CABLE DESCRIPTION OF THE ABOVE SUPPORT UNITS
1	USB charger cable(Shielded, 1.2m with one core)
2	1.8m braid shielded wire, terminated with DB25 and Centronics connector via metallic frame, w/o core.
3	1 m shielded cable, terminated with USB connector, w/o core.

NOTE: All power cords of the above support units are non shielded (1.8m).

3.5 CONFIGURATION OF SYSTEM UNDER TEST

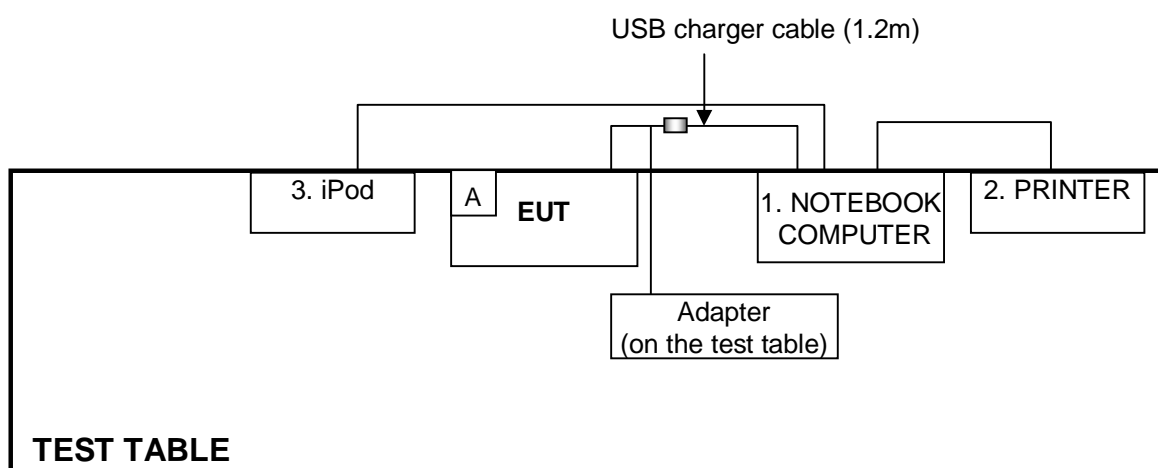

NOTE: 1. Item A is the micro SD Card.

4 TEST TYPES AND RESULTS

4.1 OUTPUT POWER MEASUREMENT

4.1.1 LIMITS OF OUTPUT POWER MEASUREMENT

The radiated peak output power shall be according to the specific rule Part 24.232(b) that “Mobile / Portable station are limited to 2 watts e.i.r.p” and 24.232(c) specific that “Peak transmit power must be measure over any interval of continuous transmission using instrumentation calibration in terms of rms-equivalent voltage.”



A D T

4.1.2 TEST INSTRUMENTS

DESCRIPTION & MANUFACTURER	MODEL NO.	SERIAL NO.	CALIBRATED DATE	CALIBRATED UNTIL
ROHDE & SCHWARZ Spectrum Analyzer	FSP40	100036	Dec. 08, 2010	Dec. 07, 2011
Agilent PSA Spectrum Analyzer	E4446A	MY46180622	May 12 , 2010	May 11 , 2011
HP Pre_Amplifier	8449B	300801923	Nov. 01, 2010	Oct. 31, 2011
ROHDE & SCHWARZ Test Receiver	ESCS30	847124/029	Sep. 03, 2010	Sep. 02, 2011
SCHWARZBECK TRILOG Broadband Antenna	VULB 9168	138	Apr. 28, 2010	Apr. 27, 2011
Schwarzbeck Horn_Antenna	BBHA9120	D124	Dec. 17, 2010	Dec. 16, 2011
Schwarzbeck Horn_Antenna	BBHA 9170	BBHA9170153	Jan. 22, 2010	Jan. 21, 2011
RF Switches	EMH-011	1001	NA	NA
RF CABLE (Chaintek)	Sucoflex 104+ Sucoflex 106	RF104-101+R F106-101	Aug. 24, 2010	Aug. 23, 2011
RF Cable	8DFB	STCCAB-30M- 1GHz	NA	NA
Software	ADT_Radiated_ V7.6.15.9.2	NA	NA	NA
CT Antenna Tower & Turn Table	NA	NA	NA	NA

- Note: 1. The calibration interval of the above test instruments is 12 months and the calibrations are traceable to NML/ROC and NIST/USA.
2. The horn antenna, preamplifier (model: 8449B) and Spectrum Analyzer (model: FSP40) are used only for the measurement of emission frequency above 1GHz if tested.
3. The test was performed in Open Site No. C.
4. The FCC Site Registration No. is 656396.
5. The VCCI Site Registration No. is R-1626.
6. The CANADA Site Registration No. is IC 7450G-3.

4.1.3 TEST PROCEDURES

- a. The power was measured with R&S Spectrum Analyzer. All measurements were done at 3 channels, 512, 661 and 810 (low, middle and high operational frequency range.)
- b. The conducted peak output power used the power splitter via EUT RF power connector between simulation base station and spectrum analyzer. The path loss included the splitter loss, cable loss and 20dB pad loss. The spectrum set RB/VB 1MHz, then read peak power value and record to the test. (All transmitted path loss shall be considered in the test report data.)
- c. E.I.R.P peak power measurement. In the open site, EUT placed on the 0.8m height of Turn Table, rotated the table around 360 degrees to search the maximum radiation power and receiver antenna shall be rotated vertical and horizontal polarization to find the maximum polar radiated power. The “Read Value” is the spectrum reading the maximum power value.
- d. The substitution horn antenna is substituted for EUT at the same position and signal generator export the CW signal to the calibration antenna. Rotated the Turn Table to find the maximum radiation power. “Raw” is the spectrum reading value, “SG” is signal generator export power, “TX Gain” is calibration antenna isotropic gain value, “TX cable” is the transmitted cable loss between the calibration antenna and signal generator. The “Factor” means that the transmission path loss is equal to “SG” - “TX cable” + “TX Gain” – “Raw”.
- e. Actually the real E.I.R.P peak power is equal to “Read Value” + “Factor”

4.1.4 TEST SETUP

EIRP POWER MEASUREMENT:

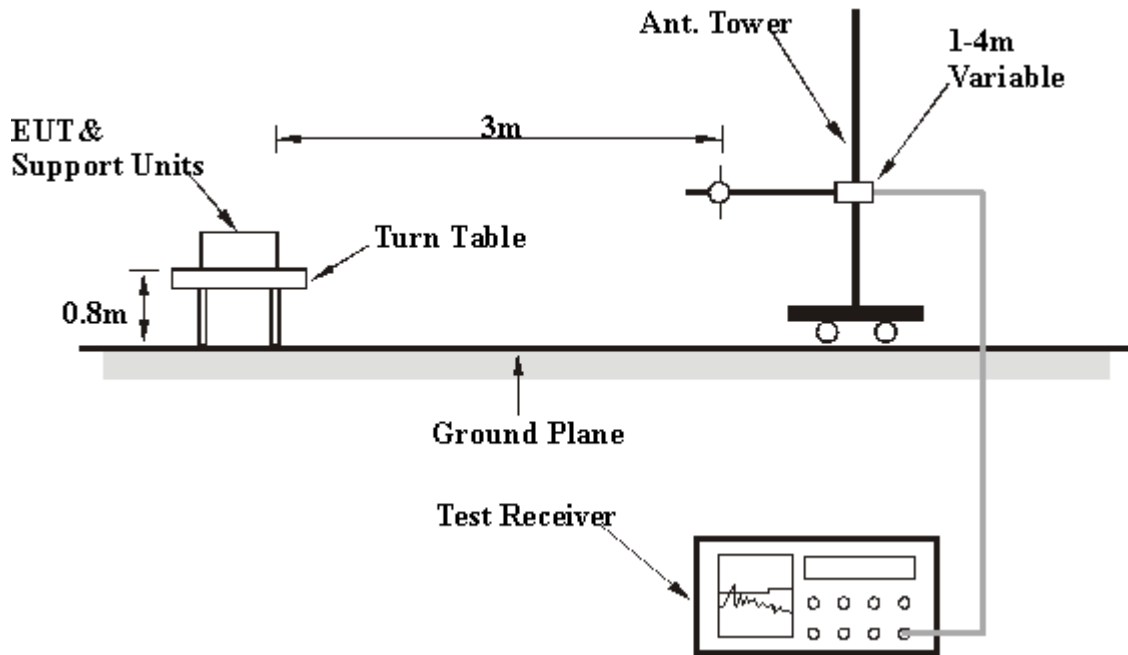

For the actual test configuration, please refer to the attached file (Test Setup Photo).

CONDUCTED POWER MEASUREMENT:

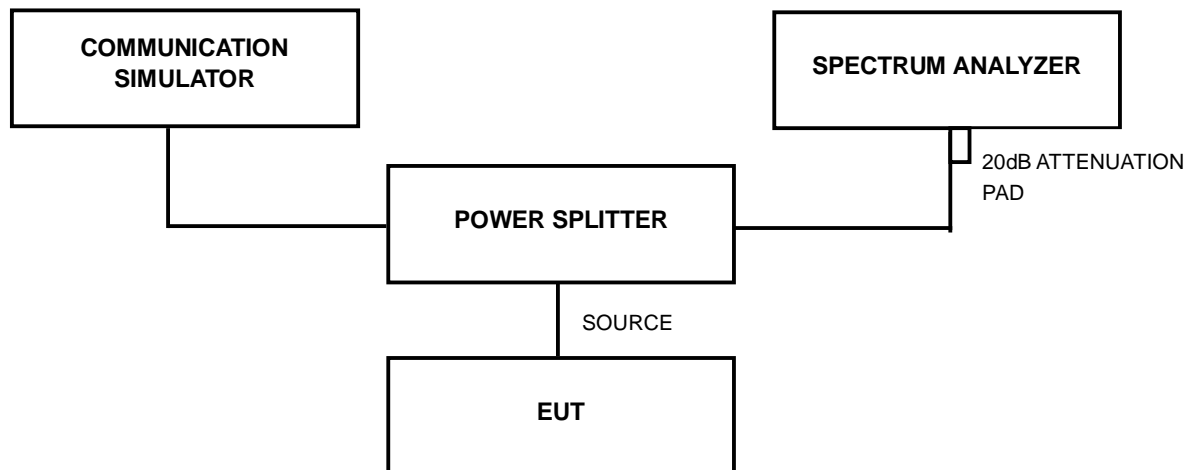

For the actual test configuration, please refer to the related item – Photographs of the Test Configuration.



A D T

4.1.5 EUT OPERATING CONDITIONS

- a. The EUT makes a phone call to the communication simulator.
- b. The communication simulator station system controlled a EUT to export maximum output power under transmission mode and specific channel frequency.



A D T

4.1.6 TEST RESULTS

FOR GSM MODE

CONDUCTED PEAK OUTPUT POWER					
CHANNEL NO.	FREQUENCY (MHz)	RAW VALUE (dBm)	CORRECTION FACTOR (dB)	PEAK OUTPUT POWER	
				dBm	Watt
512	1850.2	24.4	5.3	29.7	0.9333
661	1880.0	24.5	5.3	29.8	0.9550
810	1909.8	24.6	5.3	29.9	0.9772

REMARKS: 1. Peak Output Power (dBm) = Raw Value (dBm) + Correction Factor (dB).
2. Correction Factor (dB) = Power Splitter Loss (dB) + Cable Loss (dB).

EIRP POWER					
CHANNEL NO.	FREQUENCY (MHz)	S.G VALUE (dBm)	CORRECTION FACTOR (dB)	PEAK OUTPUT POWER	
				dBm	Watt
512	1850.2	25.1	6.60	31.7	1.4831
661	1880.0	24.3	6.70	31.0	1.2629
810	1909.8	23.6	6.70	30.3	1.0804

REMARKS: 1. Peak Output Power (dBm) = Raw Value (dBm) + Correction Factor (dB).
2. Correction Factor (dB) = substitution Antenna Gain (dBi) + Cable Loss (dB) + Free Space Loss (dB).



A D T

FOR GPRS MODE

CONDUCTED PEAK OUTPUT POWER					
CHANNEL NO.	FREQUENCY (MHz)	RAW VALUE (dBm)	CORRECTION FACTOR (dB)	PEAK OUTPUT POWER	
				dBm	Watt
512	1850.2	24.4	5.3	29.7	0.9333
661	1880.0	24.5	5.3	29.8	0.9550
810	1909.8	24.6	5.3	29.9	0.9772

REMARKS: 1. Peak Output Power (dBm) = Raw Value (dBm) + Correction Factor (dB).
2. Correction Factor (dB) = Power Splitter Loss (dB) + Cable Loss (dB).

EIRP POWER					
CHANNEL NO.	FREQUENCY (MHz)	S.G VALUE (dBm)	CORRECTION FACTOR (dB)	PEAK OUTPUT POWER	
				dBm	Watt
512	1850.2	25.1	6.6	31.7	1.4729
661	1880.0	24.3	6.7	31.0	1.2514
810	1909.8	23.6	6.7	30.3	1.0730

REMARKS: 1. Peak Output Power (dBm) = Raw Value (dBm) + Correction Factor (dB).
2. Correction Factor (dB) = substitution Antenna Gain (dBi) + Cable Loss (dB) + Free Space Loss (dB).



A D T

FOR E-GPRS MODE

CONDUCTED PEAK OUTPUT POWER					
CHANNEL NO.	FREQUENCY (MHz)	RAW VALUE (dBm)	CORRECTION FACTOR (dB)	PEAK OUTPUT POWER	
				dBm	Watt
512	1850.2	20.9	5.3	26.2	0.4169
661	1880.0	21.0	5.3	26.3	0.4266
810	1909.8	21.3	5.3	26.6	0.4571

REMARKS: 1. Peak Output Power (dBm) = Raw Value (dBm) + Correction Factor (dB).
2. Correction Factor (dB) = Power Splitter Loss (dB) + Cable Loss (dB).

EIRP POWER					
CHANNEL NO.	FREQUENCY (MHz)	S.G VALUE (dBm)	CORRECTION FACTOR (dB)	PEAK OUTPUT POWER	
				dBm	Watt
512	1850.2	21.5	6.6	28.1	0.6489
661	1880.0	20.6	6.7	27.3	0.5400
810	1909.8	20.3	6.7	27.0	0.4973

REMARKS: 1. Peak Output Power (dBm) = Raw Value (dBm) + Correction Factor (dB).
2. Correction Factor (dB) = substitution Antenna Gain (dBi) + Cable Loss (dB) + Free Space Loss (dB).

4.2 FREQUENCY STABILITY MEASUREMENT

4.2.1 LIMITS OF FREQUENCY STABILITY MEASUREMENT

According to the FCC part 24.235 shall be tested the frequency stability. The rule is defined that” The frequency stability shall be sufficient to ensure that the fundamental emission stays within the authorized frequency block.” The frequency error rate is according to the JTC standard that the frequency error rate shall be accurate to within 2.5ppm of the received frequency from the base station. The test extreme voltage is according to the 2.1055(d)(1) Vary primary supply voltage from 85 to 115 percent of the nominal value for other than hand carried battery equipment and the extreme temperature rule is comply with the 2.1055(a)(1) $-30^{\circ}\text{C} \sim 50^{\circ}\text{C}$.

4.2.2 TEST INSTRUMENTS

DESCRIPTION & MANUFACTURER	MODEL NO.	SERIAL NO.	CALIBRATED DATE	CALIBRATED UNTIL
R&S SPECTRUM ANALYZER	FSP40	100037	Aug. 02, 2010	Aug. 01, 2011
OVEN	MHU-225AU	911033	Dec. 17, 2010	Dec. 16, 2011
HUBER+SUHNER	SUCOFLEX104	222684/4	Aug. 14, 2010	Aug. 13, 2011
AC POWER SOURCE	6205	1140503	NA	NA

NOTE: The calibration interval of the above test instruments is 12 months. And the calibrations are traceable to NML/ROC and NIST/USA.

4.2.3 TEST PROCEDURE

- a. Because of the measure the carrier frequency under the condition of the AFC lock, it shall be used the mobile station in the GSM link mode. This is accomplished with the use of the R&S CMU200 simulator station. The oven room could control the temperatures and humidity. The GSM link channel is the 661.
- b. Power must be removed when changing from one temperature to another or one voltage to another voltage. Power warm up is at least 15 min and power applied should perform before recording frequency error.
- c. EUT is connected the external power supply to control the AC input power. The various Volts from the minimum 138 Volts to 102 Volts. Each step shall be record the frequency error rate.
- d. The temperature range step is 10 degrees in this test items. All temperature levels shall be hold the $\pm 0.5^{\circ}\text{C}$ during the measurement testing.
- e. The each temperature step shall be at least 0.5 hours, consider the EUT could be test under the stability condition.

4.2.4 TEST SETUP

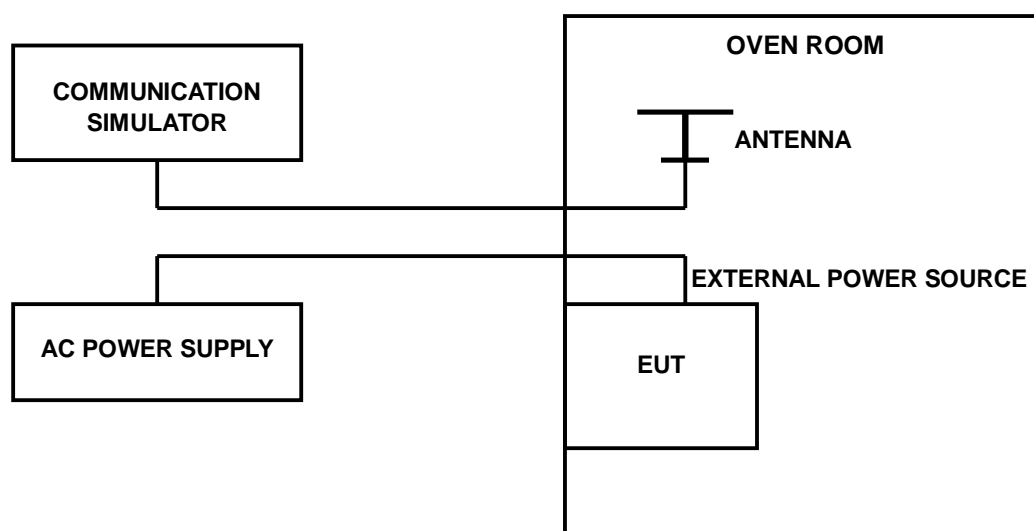



A D T

4.2.5 TEST RESULTS

AFC FREQUENCY ERROR vs. VOLTAGE			
VOLTAGE (Volts)	FREQUENCY ERROR (Hz)	FREQUENCY ERROR (ppm)	LIMIT (ppm)
138	68	0.036	2.5
102	59	0.031	2.5

AFC FREQUENCY ERROR vs. TEMP.			
TEMP. (°C)	FREQUENCY ERROR (Hz)	FREQUENCY ERROR (ppm)	LIMIT (ppm)
50	89	0.047	2.5
40	76	0.040	2.5
30	73	0.039	2.5
20	64	0.034	2.5
10	62	0.033	2.5
0	58	0.031	2.5
-10	65	0.035	2.5
-20	69	0.037	2.5
-30	75	0.040	2.5

4.3 OCCUPIED BANDWIDTH MEASUREMENT

4.3.1 LIMITS OF OCCUPIED BANDWIDTH MEASUREMENT

According to FCC 24.238(b) specified that emission bandwidth is defined as the width of the signal between two points, one below the carrier center frequency and one above the carrier center frequency, outside of which all emissions are attenuated at least 26 dB below the transmitter power.

4.3.2 TEST INSTRUMENTS

DESCRIPTION & MANUFACTURER	MODEL NO.	SERIAL NO.	CALIBRATED DATE	CALIBRATED UNTIL
R&S SPECTRUM ANALYZER	FSP40	100037	Aug. 02, 2010	Aug. 01, 2011
OVEN	MHU-225AU	911033	Dec. 17, 2010	Dec. 16, 2011
HUBER+SUHNER	SUCOFLEX104	222684/4	Aug. 14, 2010	Aug. 13, 2011
AC POWER SOURCE	6205	1140503	NA	NA

NOTE: The calibration interval of the above test instruments is 12 months. And the calibrations are traceable to NML/ROC and NIST/USA.

4.3.3 TEST SETUP

Same as Item 4.2.4 (Conducted Power Setup)

4.3.4 TEST PROCEDURES

- a. The EUT was set up for the maximum peak power with GSM link data modulation. The power was measured with R&S Spectrum Analyzer. All measurements were done at 3 channels, 512, 661 and 810 (low, middle and high operational frequency range.)
- b. The conducted occupied bandwidth used the power splitter via EUT RF power connector between simulation base station and spectrum analyzer. This splitter loss and cable loss are the worst loss 6.5dB in the transmitted path track.
- c. The communication simulator station system controlled a EUT to export maximum output power under transmission mode and specific channel frequency. Use OBW measurement function of Spectrum analyzer to measure 99 % occupied bandwidth.

4.3.5 EUT OPERATING CONDITION

Same as the 4.1.5

4.3.6 TEST RESULTS

FOR GSM MODE

CHANNEL	FREQUENCY (MHz)	99% OCCUPIED BANDWIDTH (kHz)
512	1850.2	244.0
661	1880.0	244.0
810	1909.8	244.0

CH 512

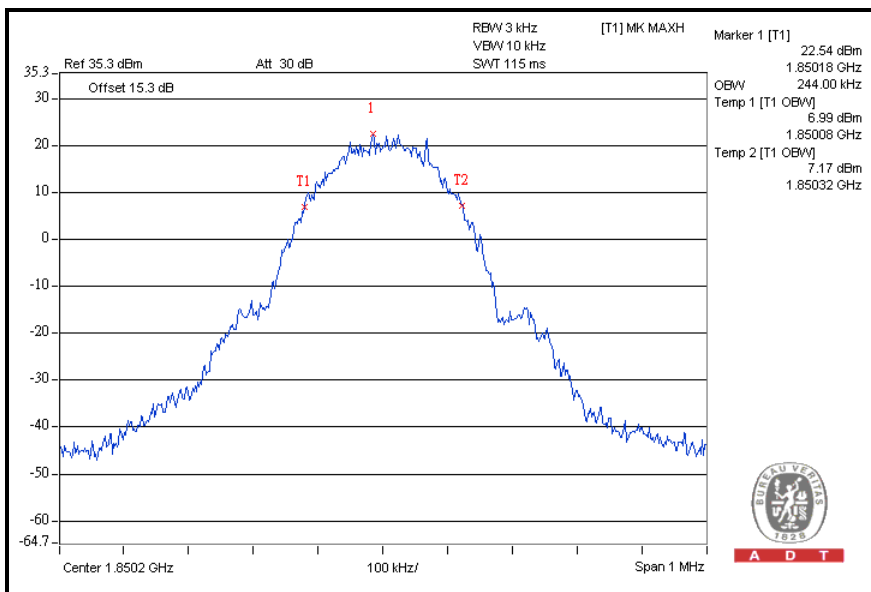



A D T

CH 661

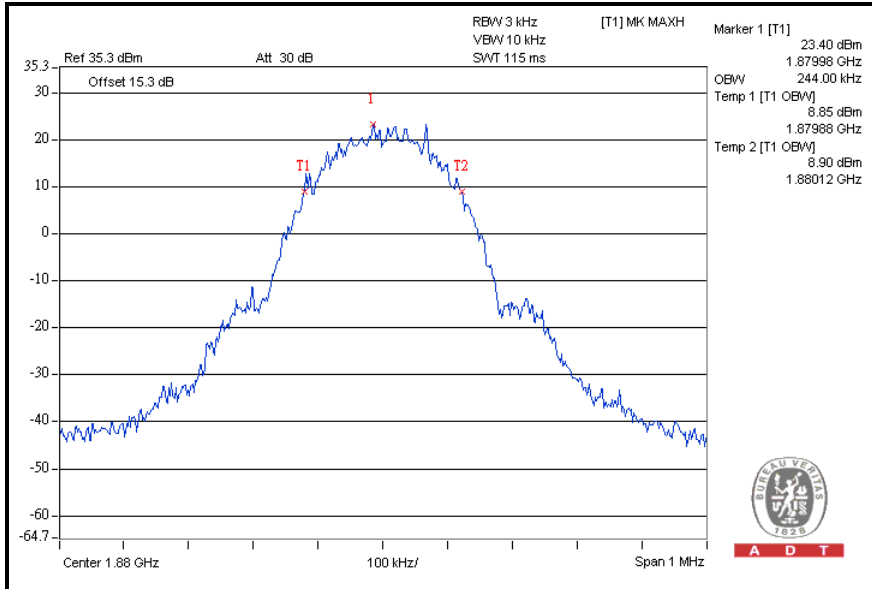

CH 810

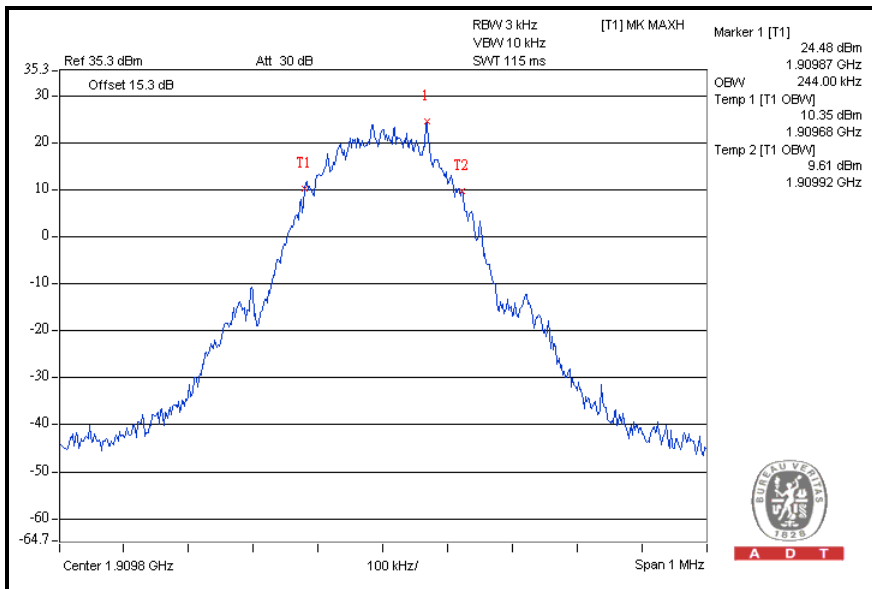

FOR GPRS MODE

CHANNEL	FREQUENCY (MHz)	99% OCCUPIED BANDWIDTH (kHz)
512	1850.2	244.0
661	1880.0	242.0
810	1909.8	248.0

CH 512

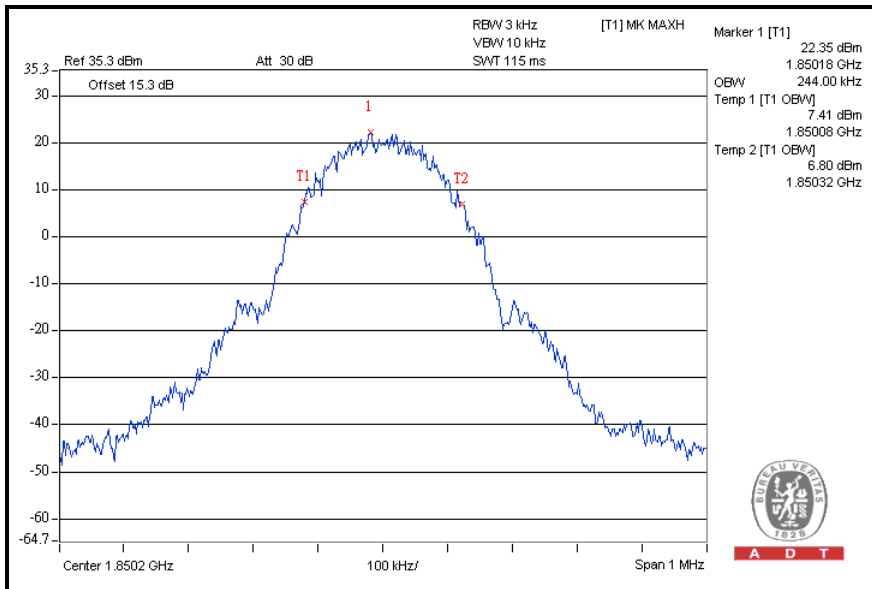



A D T

CH 661

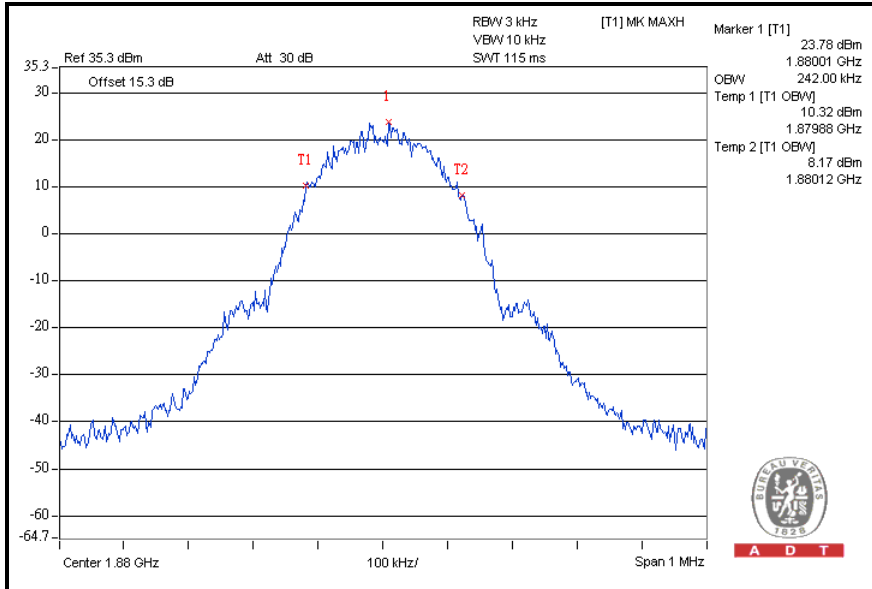

CH 810

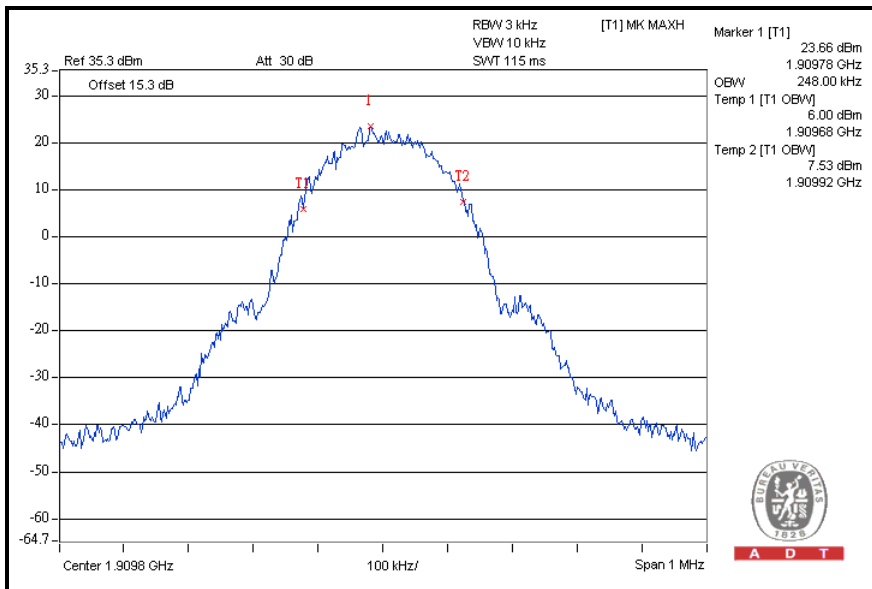



A D T

FOR E-GPRS MODE

CHANNEL	FREQUENCY (MHz)	99% OCCUPIED BANDWIDTH (kHz)
512	1850.2	248.0
661	1880.0	246.0
810	1909.8	246.0

CH 512

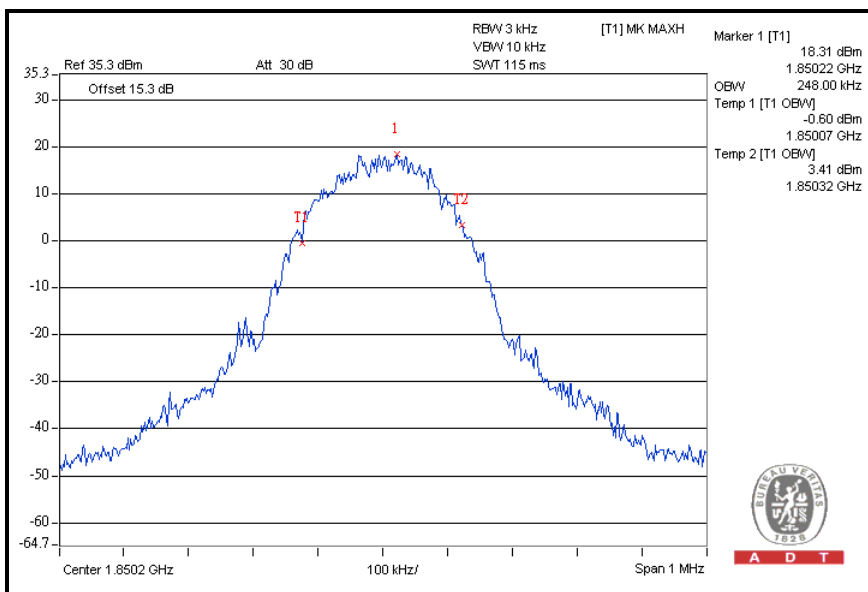



A D T

CH 661

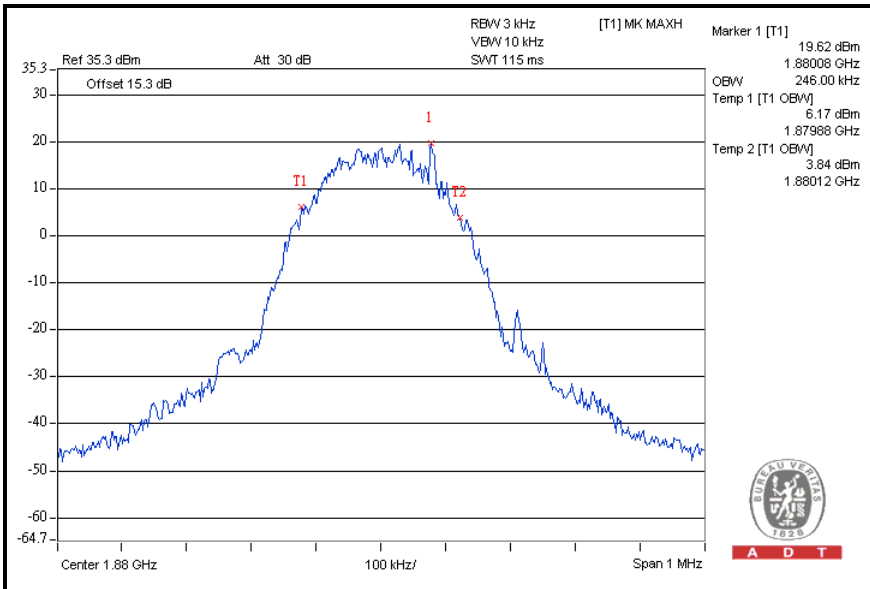

CH 810

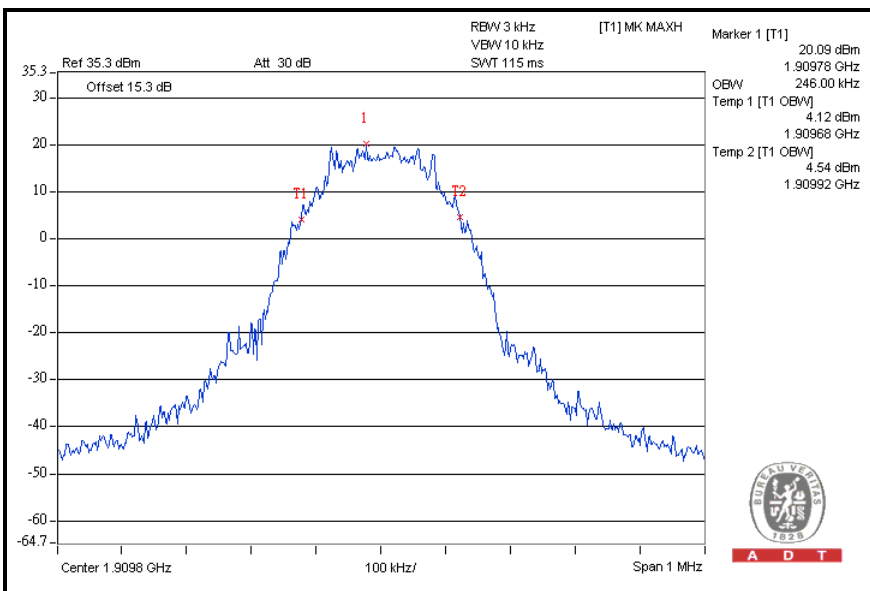



4.4 BAND EDGE MEASUREMENT

4.4.1 LIMITS OF BAND EDGE MEASUREMENT

According to FCC 24.238(a) specified that power of any emission outside of the authorized operating frequency ranges must be attenuated below the transmitting power (P) by a factor of at least $43 + 10 \log(P)$ dB. In the 1 MHz bands immediately outside and adjacent to the frequency block a resolution bandwidth of at least one percent of the emission bandwidth of the fundamental emission of the transmitter may be employed.

4.4.2 TEST INSTRUMENTS

DESCRIPTION & MANUFACTURER	MODEL NO.	SERIAL NO.	CALIBRATED DATE	CALIBRATED UNTIL
R&S SPECTRUM ANALYZER	FSP40	100037	Aug. 02, 2010	Aug. 01, 2011
OVEN	MHU-225AU	911033	Dec. 17, 2010	Dec. 16, 2011
HUBER+SUHNER	SUCOFLEX104	222684/4	Aug. 14, 2010	Aug. 13, 2011
AC POWER SOURCE	6205	1140503	NA	NA

NOTE: The calibration interval of the above test instruments is 12 months. And the calibrations are traceable to NML/ROC and NIST/USA.

4.4.3 TEST SETUP

Same as Item 4.2.4 (Conducted Power Setup)

4.4.4 TEST PROCEDURES

- a. The EUT was set up for the maximum peak power with GSM link data modulation. The power was measured with R&S Spectrum Analyzer. All measurements were done at 2 channels, 512 and 810 (low and high operational frequency range.)
- b. The band edge measurement used the power splitter via EUT RF power connector between simulation base station and spectrum analyzer. This splitter loss and cable loss are the worst loss 6.5dB in the transmitted path track.
- c. The center frequency of spectrum is the band edge frequency and span is 1.5 MHz. RB of the spectrum is 3kHz and VB of the spectrum is 10kHz.
- d. Record the max trace plot into the test report.

4.4.5 EUT OPERATING CONDITION

Same as the 4.1.5

4.4.6 TEST RESULTS

FOR GSM MODE LOWER BAND EDGE

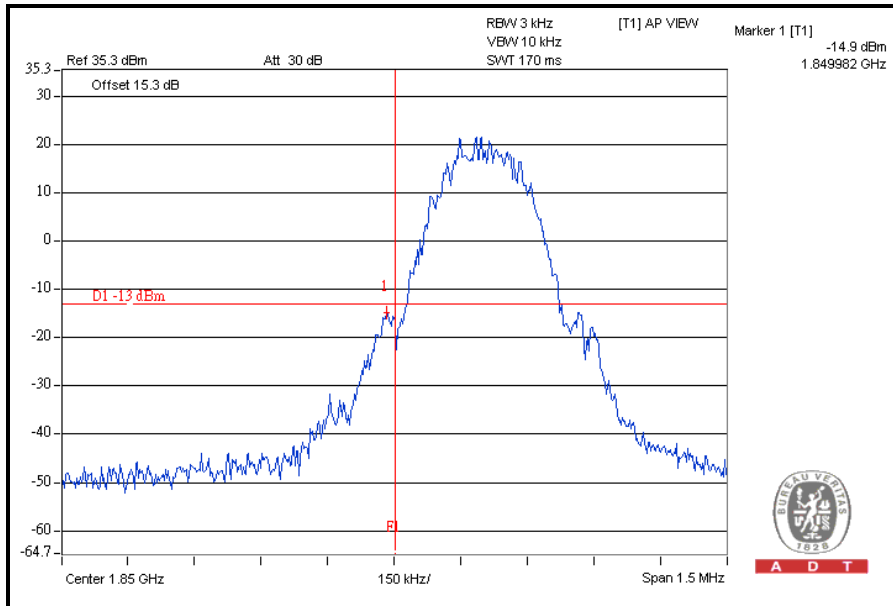

HIGHER BAND EDGE

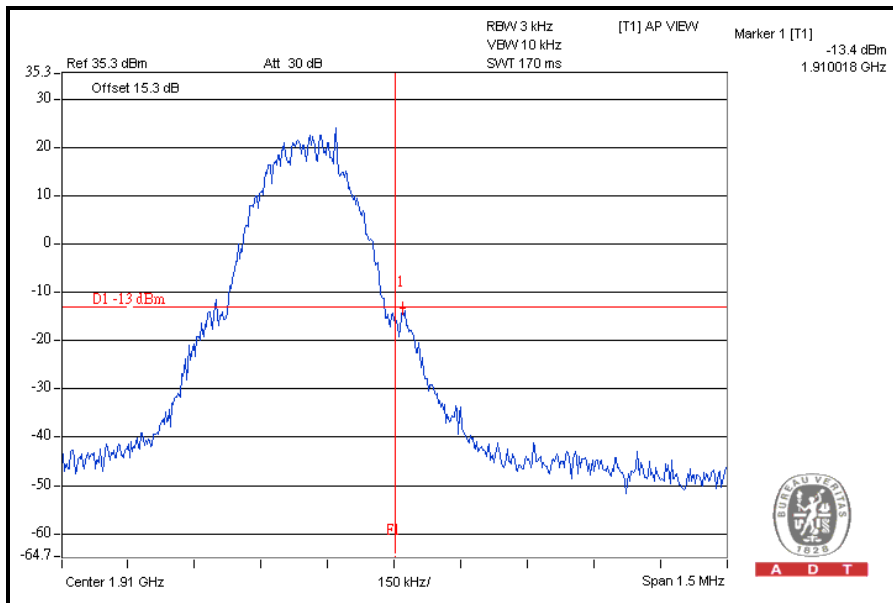



A D T

FOR GPRS MODE LOWER BAND EDGE

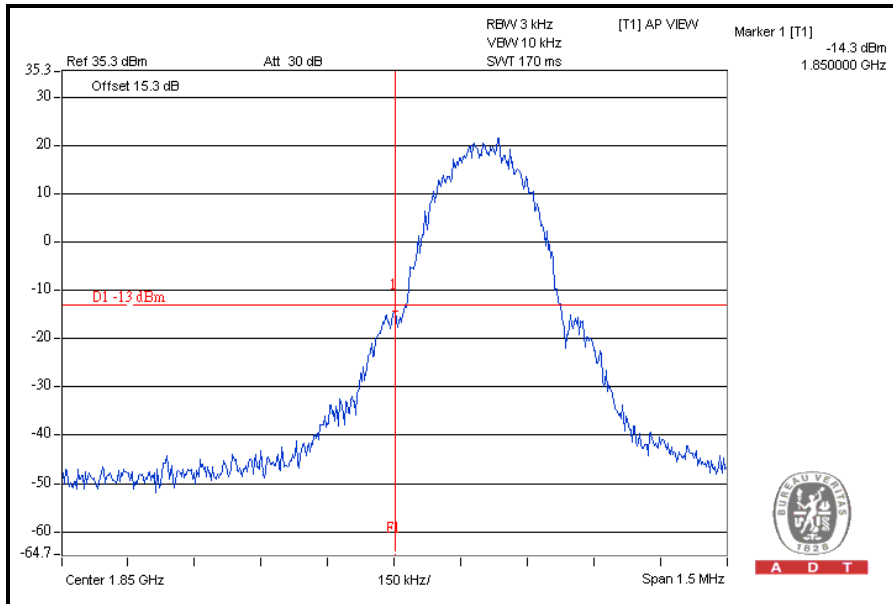

HIGHER BAND EDGE

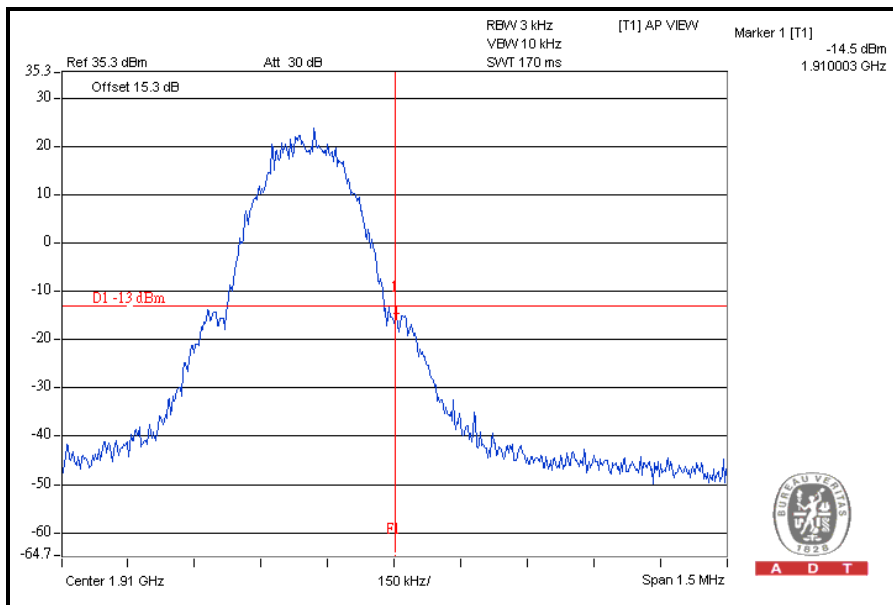



A D T

FOR E-GPRS MODE LOWER BAND EDGE

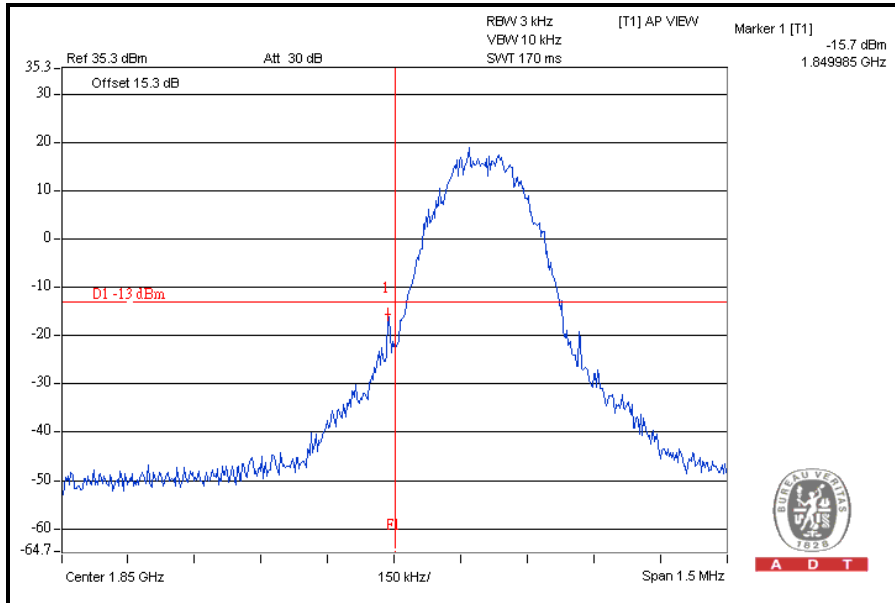

HIGHER BAND EDGE

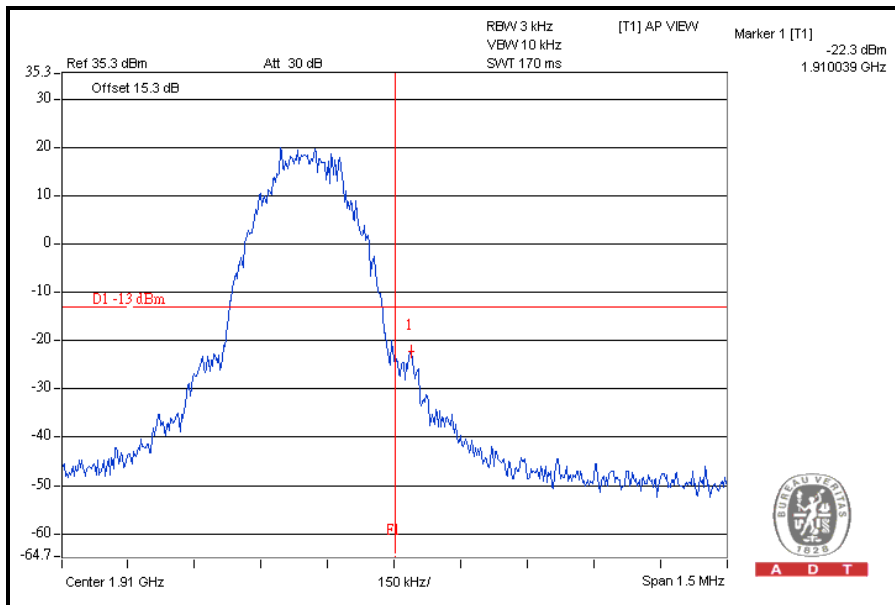



4.5 CONDUCTED SPURIOUS EMISSIONS

4.5.1 LIMITS OF CONDUCTED SPURIOUS EMISSIONS MEASUREMENT

In the FCC 24.238(a), On any frequency outside a licensee's frequency block within USPCS spectrum, the power of any emission shall be attenuated below the transmitter power (P) by at least $43 + 10 \log (P)$ dB. The limit of emission equal to -13dBm .

4.5.2 TEST INSTRUMENTS

DESCRIPTION & MANUFACTURER	MODEL NO.	SERIAL NO.	CALIBRATED DATE	CALIBRATED UNTIL
R&S SPECTRUM ANALYZER	FSP40	100037	Aug. 02, 2010	Aug. 01, 2011
OVEN	MHU-225AU	911033	Dec. 17, 2010	Dec. 16, 2011
HUBER+SUHNER	SUCOFLEX104	222684/4	Aug. 14, 2010	Aug. 13, 2011
AC POWER SOURCE	6205	1140503	NA	NA
Wainwright Instruments Band Reject Filter	WRCG1850/191 0-1830/1930-60/ 10SS	SN1	NA	NA
* Wainwright Instruments High Pass Filter	WHK3.1/18G-10 SS	SN1	NA	NA

NOTE: The calibration interval of the above test instruments is 12 months. And the calibrations are traceable to NML/ROC and NIST/USA.

4.5.3 TEST PROCEDURE

- a. The EUT was set up for the maximum peak power with GSM link data modulation. The power was measured with R&S Spectrum Analyzer. All measurements were done at 3 channels, 512, 661 and 810 (low, middle and high operational frequency range.)
- b. The conducted spurious emission used the power splitter via EUT RF power connector between simulation base station and spectrum analyzer. This splitter loss and cable loss are the worst loss 6.5dB in the transmitted path track.
- c. When the spectrum scanned from 9kHz to 3GHz, it shall be connected to the band reject filter attenuated the carried frequency. The spectrum set RB=1MHz, VB=3MHz.
- d. When the spectrum scanned from 3kHz to 20GHz, it shall be connected to the high pass filter attenuated the carried frequency. The spectrum set RB=1MHz, VB=3MHz.

4.5.4 TEST SETUP

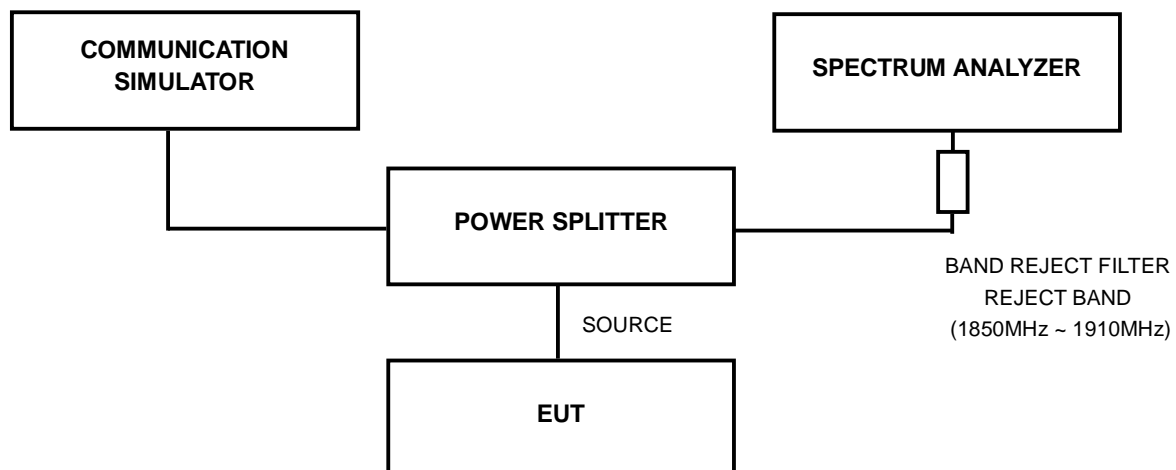

4.5.5 EUT OPERATING CONDITIONS

Same as the 4.1.5

4.5.6 TEST RESULTS

CH 512: 9kHz ~ 3GHz

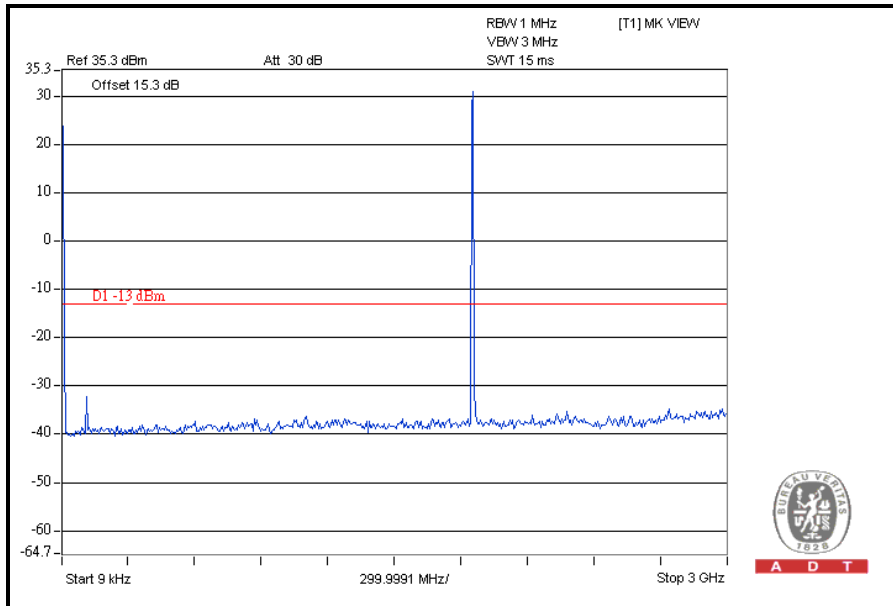

3GHz ~ 10GHz

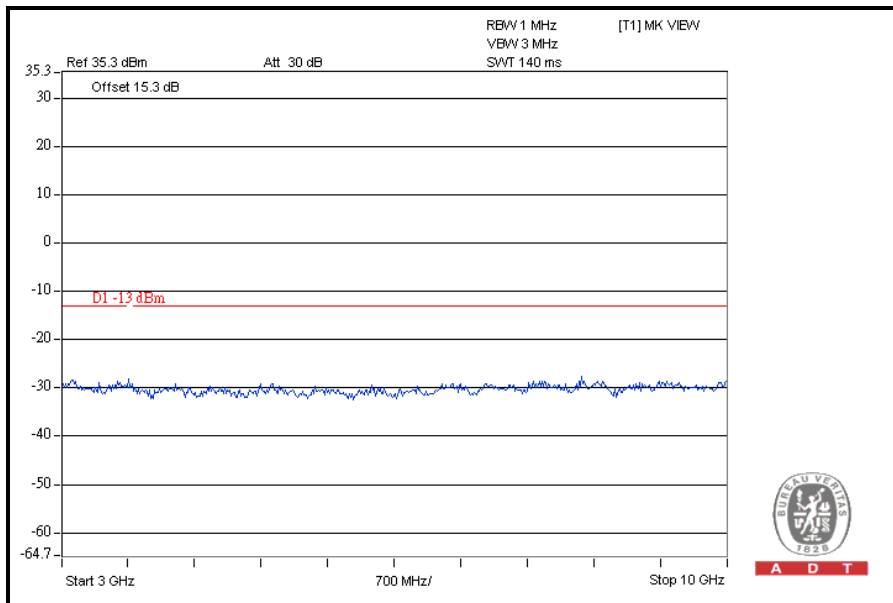



A D T

10GHz ~ 20GHz

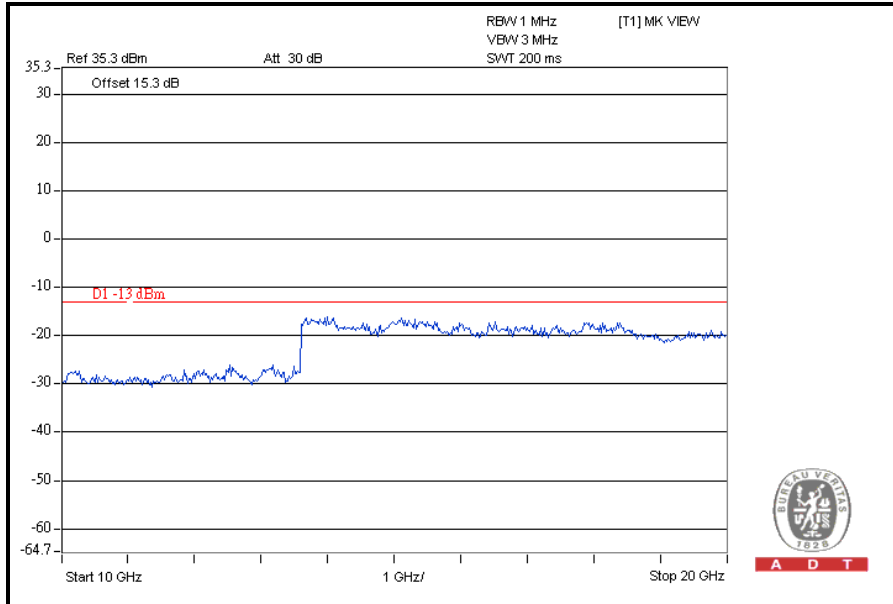

A D T



A D T

CH 661: 9kHz ~ 3GHz

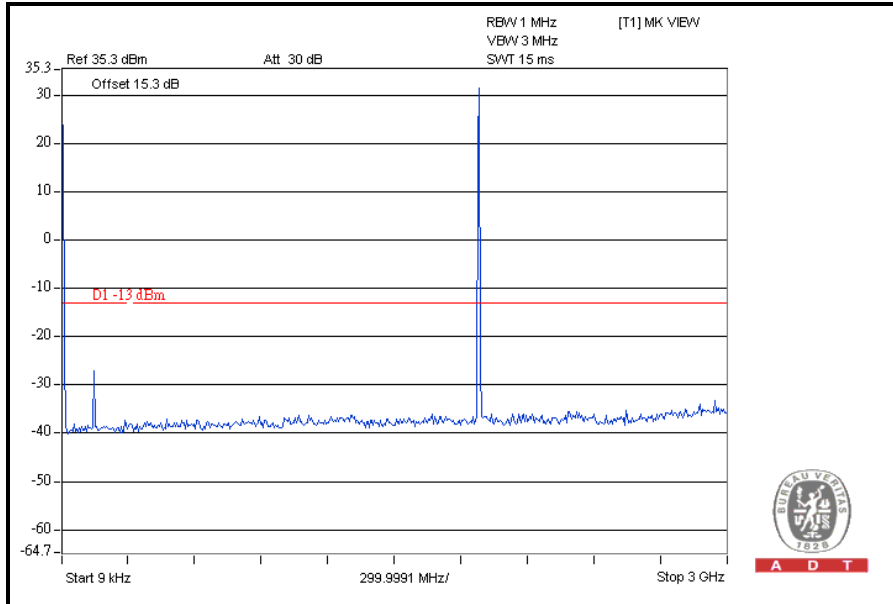

3GHz ~ 10GHz

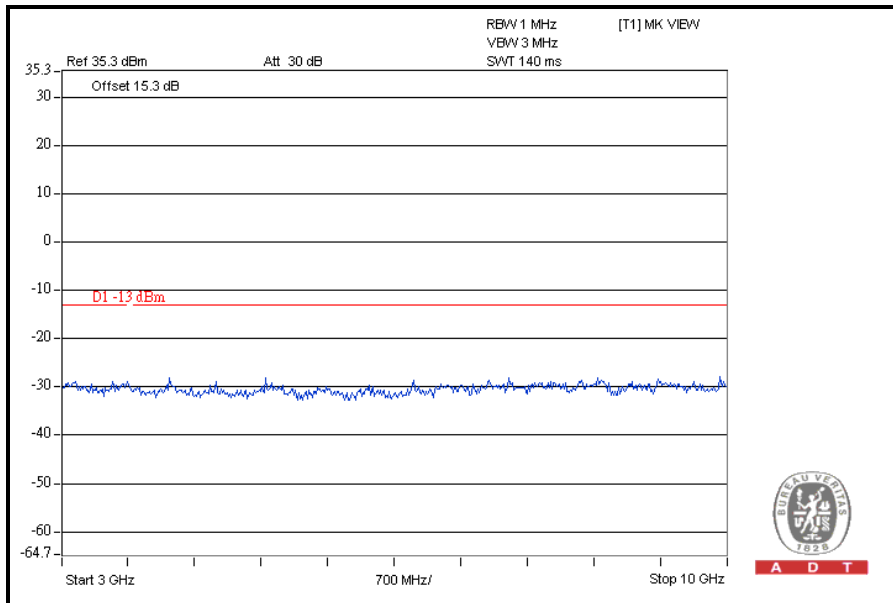



A D T

10GHz ~ 20GHz

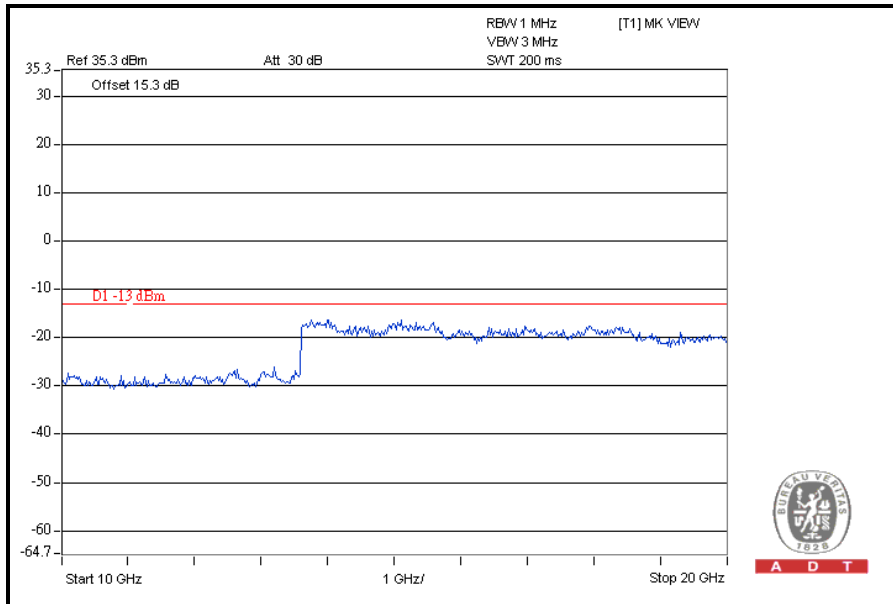



A D T

CH 810: 9kHz ~ 3GHz

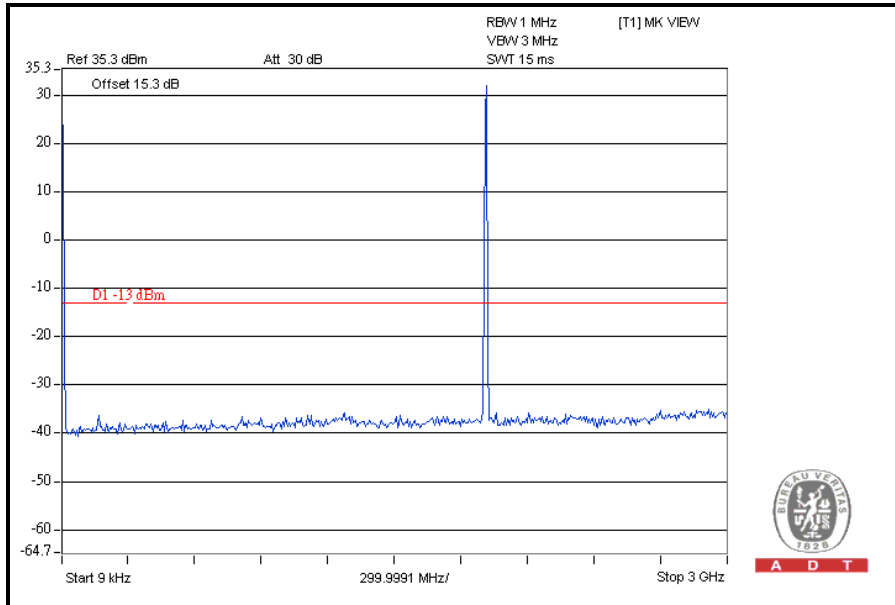

3GHz ~ 10GHz

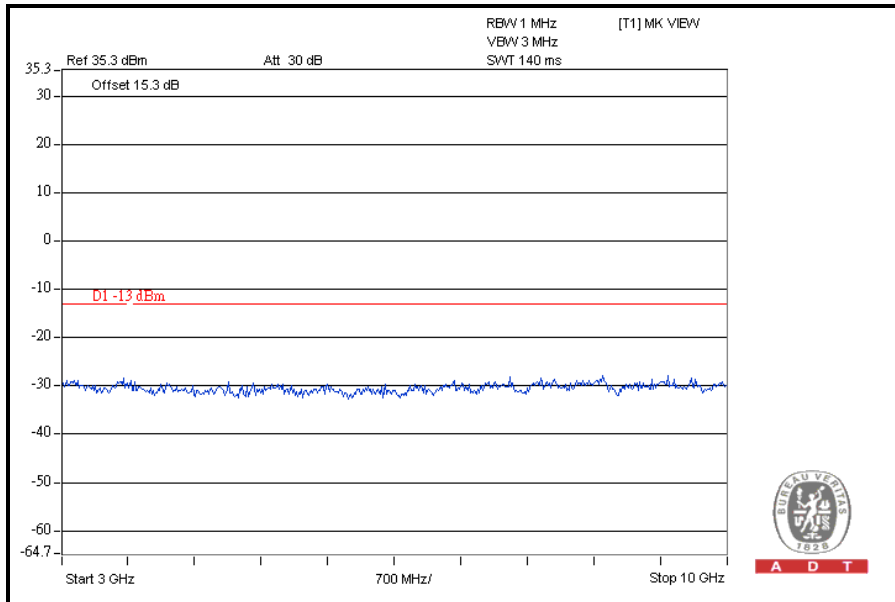



A D T

10GHz ~ 20GHz

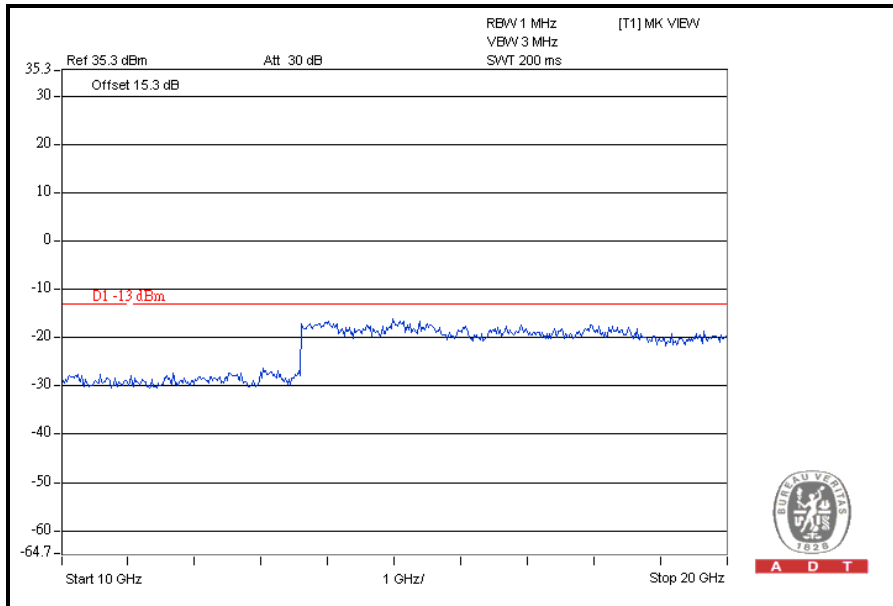

A D T

4.6 RADIATED EMISSION MEASUREMENT (BELOW 1GHz)

4.6.1 LIMITS OF RADIATED EMISSION MEASUREMENT

In the FCC 24.238(a), On any frequency outside a licensee's frequency block within USPCS spectrum, the power of any emission shall be attenuated below the transmitter power (P) by at least $43 + 10 \log (P)$ dB. The emission of limit equal to -13 dBm. So the limit of emission is the same absolute specified line.

LIMIT (dBm)	EQUIVALENT FIELD STRENGTH AT 3m (dBuV/m) (NOTE)
-13	82.22

NOTE: The following formula is used to convert the equipment radiated power to field strength.

$$E = [1000000\sqrt{(30P)}] / 3 \text{ uV/m, where P is Watts.}$$



A D T

4.6.2 TEST INSTRUMENTS

DESCRIPTION & MANUFACTURER	MODEL NO.	SERIAL NO.	CALIBRATED DATE	CALIBRATED UNTIL
ROHDE & SCHWARZ Spectrum Analyzer	FSP40	100036	Dec. 08, 2010	Dec. 07, 2011
Agilent PSA Spectrum Analyzer	E4446A	MY46180622	May 12 , 2010	May 11 , 2011
HP Pre_Amplifier	8449B	300801923	Nov. 01, 2010	Oct. 31, 2011
ROHDE & SCHWARZ Test Receiver	ESCS30	847124/029	Sep. 03, 2010	Sep. 02, 2011
SCHWARZBECK TRILOG Broadband Antenna	VULB 9168	138	Apr. 28, 2010	Apr. 27, 2011
Schwarzbeck Horn_Antenna	BBHA9120	D124	Dec. 17, 2010	Dec. 16, 2011
Schwarzbeck Horn_Antenna	BBHA 9170	BBHA9170153	Jan. 22, 2010	Jan. 21, 2011
RF Switches	EMH-011	1001	NA	NA
RF CABLE (Chaintek)	Sucoflex 104+ Sucoflex 106	RF104-101+R F106-101	Aug. 24, 2010	Aug. 23, 2011
RF Cable	8DFB	STCCAB-30M- 1GHz	NA	NA
Software	ADT_Radiated_ V7.6.15.9.2	NA	NA	NA
CT Antenna Tower & Turn Table	NA	NA	NA	NA

Note: 1. The calibration interval of the above test instruments is 12 months and the calibrations are traceable to NML/ROC and NIST/USA.

2. The horn antenna, preamplifier (model: 8449B) and Spectrum Analyzer (model: FSP40) are used only for the measurement of emission frequency above 1GHz if tested.

3. The test was performed in Open Site No. C.

4. The FCC Site Registration No. is 656396.

5. The VCCI Site Registration No. is R-1626.

6. The CANADA Site Registration No. is IC 7450G-3.

4.6.3 TEST PROCEDURES

- a. Substitution method is used for E.I.R.P measurement. In the open site, EUT placed on the 0.8m height of Turn Table, rotated the table around 360 degrees to search the maximum radiation power and receiver antenna shall be rotated vertical and horizontal polarization and moved height from 1m to 4m to find the maximum polar radiated power. The “Read Value” is the spectrum reading the maximum power value.
- b. The substitution horn antenna is substituted for EUT at the same position and signals generator export the CW signal to the substitution antenna via a TX cable. Rotated the Turn Table and moved receiving antenna to find the maximum radiation power. Adjust output power level of S.G to get a Value of spectrum reading equal to “Read Value “ of step a. Record the power level of S.G
- c. $EIRP = \text{Output power level of S.G} - \text{TX cable loss} + \text{Antenna gain of substitution horn.}$
- d. E.R.P power can be calculated form E.I.R.P power by subtracting the gain of dipole,
 $E.R.P \text{ power} = E.I.P.R \text{ power} - 2.15\text{dBi.}$

NOTE: The resolution bandwidth of spectrum analyzer is 1 MHz and the video bandwidth is 3 MHz.

4.6.4 DEVIATION FROM TEST STANDARD

No deviation

4.6.5 TEST SETUP

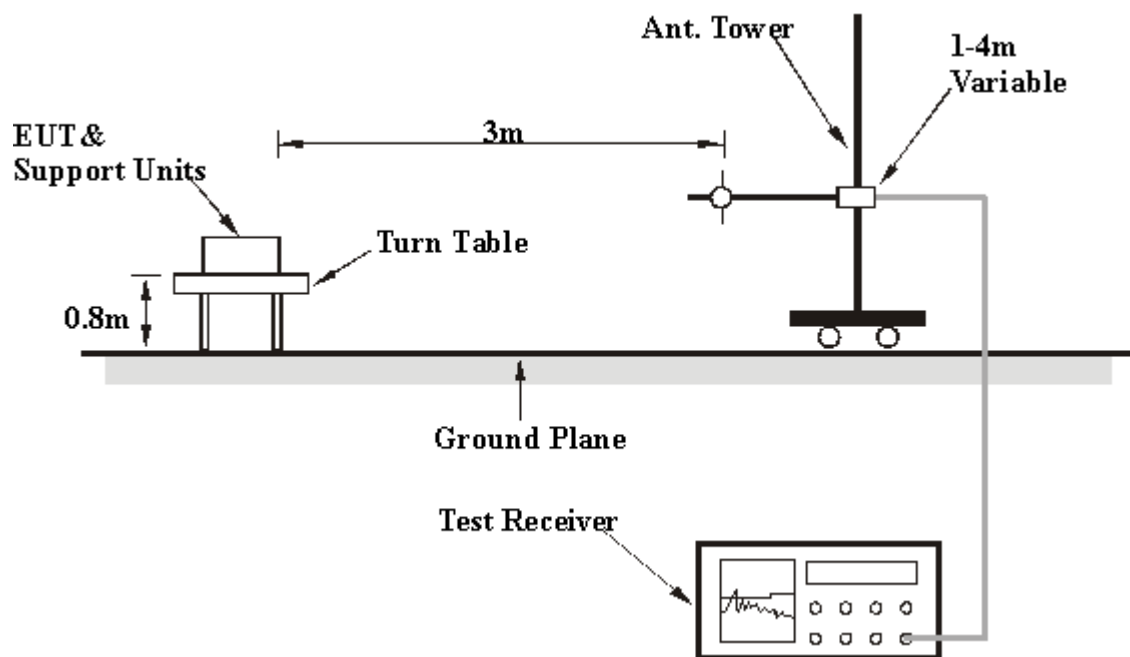

For the actual test configuration, please refer to the attached file (Test Setup Photo).

4.6.6 EUT OPERATING CONDITIONS

Same as the 4.1.5



A D T

4.6.7 TEST RESULTS

MODE	TX channel 810	FREQUENCY RANGE	Below 1000 MHz
ENVIRONMENTAL CONDITIONS	22deg. C, 69%RH, 1024 hPa	INPUT POWER	120Vac, 60 Hz
TESTED BY	Wen Yu		

ANTENNA POLARITY & TEST DISTANCE: HORIZONTAL AT 3 M						
No.	Freq. (MHz)	Emission Level (dBuV)	Limit (dBm)	S.G Power Value (dBm)	Correction Factor (dB)	Power Value (dBm)
1	113.16	33.64	-13	-56.32	-0.99	-57.32
2	194.7	32.75	-13	-62.29	3.77	-58.52
3	261.66	32.46	-13	-62.16	3.96	-58.20
4	486.2	36.12	-13	-60.16	2.87	-57.29
5	799.8	45.26	-13	-53.45	1.55	-51.90
6	862.8	37.34	-13	-62.06	4.60	-57.46
7	946.8	39.26	-13	-63.46	4.86	-58.60

ANTENNA POLARITY & TEST DISTANCE: VERTICAL AT 3 M						
No.	Freq. (MHz)	Emission Level (dBuV)	Limit (dBm)	S.G Power Value (dBm)	Correction Factor (dB)	Power Value (dBm)
1	58.08	34.23	-13	-47.20	-8.05	-55.24
2	106.68	37.15	-13	-53.16	-0.81	-53.98
3	195.24	36.84	-13	-58.25	3.83	-54.42
4	476.4	41.23	-13	-55.58	2.85	-52.73
5	546.4	42.55	-13	-52.42	2.54	-49.88
6	564.6	42.26	-13	-52.58	2.31	-50.27
7	946.8	45.62	-13	-57.10	4.86	-52.24

NOTE: Power Value (dBum) = S.G Power Value (dBm) + Correction Factor (dB).



4.7 RADIATED EMISSION MEASUREMENT (ABOVE 1GHz)

4.7.1 LIMITS OF RADIATED EMISSION MEASUREMENT

In the FCC 24.238(a), On any frequency outside a licensee's frequency block within USPCS spectrum, the power of any emission shall be attenuated below the transmitter power (P) by at least $43 + 10 \log (P)$ dB. The limit of emission equal to -13dBm .



A D T

4.7.2 TEST INSTRUMENTS

DESCRIPTION & MANUFACTURER	MODEL NO.	SERIAL NO.	CALIBRATED DATE	CALIBRATED UNTIL
ROHDE & SCHWARZ Spectrum Analyzer	FSP40	100036	Dec. 08, 2010	Dec. 07, 2011
Agilent PSA Spectrum Analyzer	E4446A	MY46180622	May 12 , 2010	May 11 , 2011
HP Pre_Amplifier	8449B	300801923	Nov. 01, 2010	Oct. 31, 2011
ROHDE & SCHWARZ Test Receiver	ESCS30	847124/029	Sep. 03, 2010	Sep. 02, 2011
SCHWARZBECK TRILOG Broadband Antenna	VULB 9168	138	Apr. 28, 2010	Apr. 27, 2011
Schwarzbeck Horn_Antenna	BBHA9120	D124	Dec. 17, 2010	Dec. 16, 2011
Schwarzbeck Horn_Antenna	BBHA 9170	BBHA9170153	Jan. 22, 2010	Jan. 21, 2011
RF Switches	EMH-011	1001	NA	NA
RF CABLE (Chaintek)	Sucoflex 104+ Sucoflex 106	RF104-101+R F106-101	Aug. 24, 2010	Aug. 23, 2011
RF Cable	8DFB	STCCAB-30M- 1GHz	NA	NA
Software	ADT_Radiated_ V7.6.15.9.2	NA	NA	NA
CT Antenna Tower & Turn Table	NA	NA	NA	NA

Note: 1. The calibration interval of the above test instruments is 12 months and the calibrations are traceable to NML/ROC and NIST/USA.

2. The horn antenna, preamplifier (model: 8449B) and Spectrum Analyzer (model: FSP40) are used only for the measurement of emission frequency above 1GHz if tested.

3. The test was performed in Open Site No. C.

4. The FCC Site Registration No. is 656396.

5. The VCCI Site Registration No. is R-1626.

6. The CANADA Site Registration No. is IC 7450G-3.

4.7.3 TEST PROCEDURES

- a. Substitution method is used for E.I.R.P measurement. In the open site, EUT placed on the 0.8m height of Turn Table, rotated the table around 360 degrees to search the maximum radiation power and receiver antenna shall be rotated vertical and horizontal polarization and moved height from 1m to 4m to find the maximum polar radiated power. The “Read Value” is the spectrum reading the maximum power value.
- b. The substitution horn antenna is substituted for EUT at the same position and signals generator export the CW signal to the substitution antenna via a TX cable. Rotated the Turn Table and moved receiving antenna to find the maximum radiation power. Adjust output power level of S.G to get a Value of spectrum reading equal to “Read Value “ of step a. Record the power level of S.G
- c. $EIRP = \text{Output power level of S.G} - \text{TX cable loss} + \text{Antenna gain of substitution horn.}$
- d. E.R.P power can be calculated form E.I.R.P power by subtracting the gain of dipole,
 $E.R.P \text{ power} = E.I.P.R \text{ power} - 2.15\text{dBi.}$

NOTE: The resolution bandwidth of spectrum analyzer is 1 MHz and the video bandwidth is 3 MHz.

4.7.4 DEVIATION FROM TEST STANDARD

No deviation

4.7.5 TEST SETUP

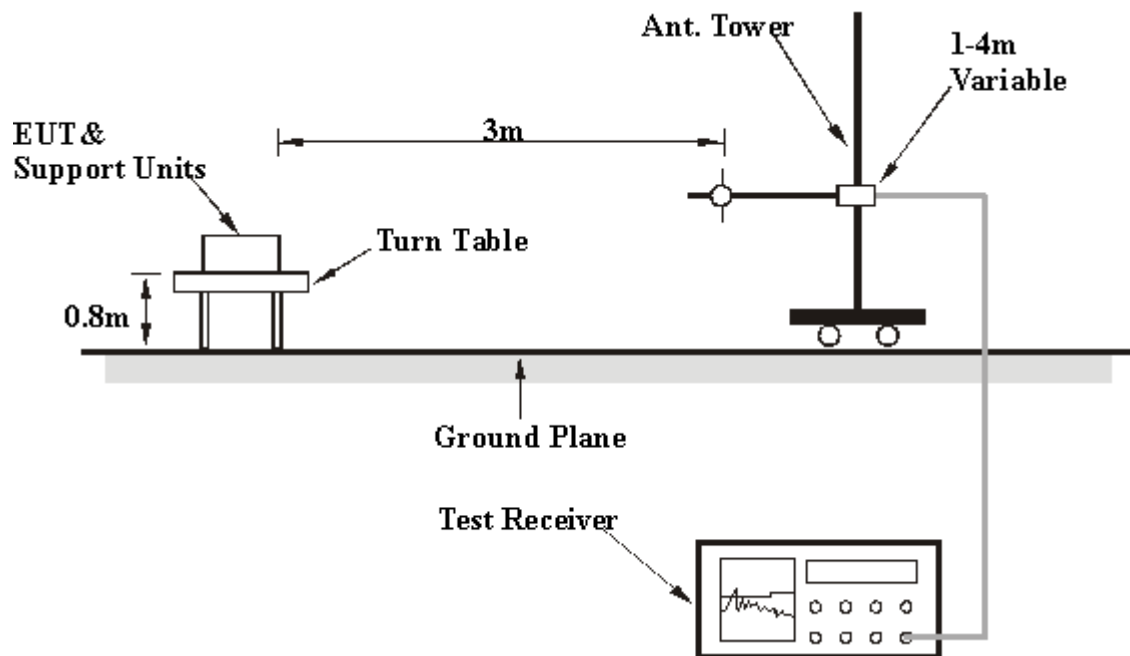

For the actual test configuration, please refer to the attached file (Test Setup Photo).

4.7.6 EUT OPERATING CONDITIONS

Same as the 4.1.5



A D T

4.7.7 TEST RESULTS

MODE	TX channel 512	DETECTOR FUNCTION	Above 1000 MHz
FREQUENCY RANGE	Below 1000 MHz	INPUT POWER	120Vac, 60 Hz
ENVIRONMENTAL CONDITIONS	18deg. C, 60%RH, 1024 hPa	TESTED BY	Wen Yu

ANTENNA POLARITY & TEST DISTANCE: HORIZONTAL AT 3 M						
No.	Freq. (MHz)	Emission Level (dBuV)	Limit (dBm)	S.G Power Value (dBm)	Correction Factor (dB)	Power Value (dBm)
1	3700.4	51.71	-13	-52.23	7.72	-44.51
2	5550.6	47.39	-13	-57.50	7.08	-50.42
3	7400.8	59.90	-13	-42.60	4.63	-37.97
4	9251	55.55	-13	-46.71	4.24	-42.47
5	11101.2	57.07	-13	-44.46	3.23	-41.23
6	12951.4	61.37	-13	-39.54	4.44	-35.10
7	14801.6	60.11	-13	-37.54	3.41	-34.13

ANTENNA POLARITY & TEST DISTANCE: VERTICAL AT 3 M						
No.	Freq. (MHz)	Emission Level (dBuV)	Limit (dBm)	S.G Power Value (dBm)	Correction Factor (dB)	Power Value (dBm)
1	3700.4	51.94	-13	-52.00	7.72	-44.28
2	5550.6	48.46	-13	-56.43	7.08	-49.35
3	7400.8	63.46	-13	-39.04	4.63	-34.41
4	9251	56.84	-13	-45.42	4.24	-41.18
5	11101.2	57.81	-13	-43.72	3.23	-40.49
6	12951.4	60.10	-13	-40.81	4.44	-36.37
7	14801.6	63.84	-13	-33.81	3.41	-30.40

NOTE: Power Value (dBum) = S.G Power Value (dBm) + Correction Factor (dB).



A D T

MODE	TX channel 661	DETECTOR FUNCTION	Above 1000 MHz
FREQUENCY RANGE	Below 1000 MHz	INPUT POWER	120Vac, 60 Hz
ENVIRONMENTAL CONDITIONS	18deg. C, 60%RH, 1024 hPa	TESTED BY	Wen Yu

ANTENNA POLARITY & TEST DISTANCE: HORIZONTAL AT 3 M						
No.	Freq. (MHz)	Emission Level (dBuV)	Limit (dBm)	S.G Power Value (dBm)	Correction Factor (dB)	Power Value (dBm)
1	3760	56.10	-13	-48.05	7.68	-40.37
2	5640	49.23	-13	-55.51	7.02	-48.49
3	7520	59.54	-13	-43.08	4.53	-38.55
4	9400	59.15	-13	-42.73	4.21	-38.52
5	11280	58.00	-13	-43.49	3.48	-40.01
6	13160	57.22	-13	-43.38	4.06	-39.32

ANTENNA POLARITY & TEST DISTANCE: VERTICAL AT 3 M						
No.	Freq. (MHz)	Emission Level (dBuV)	Limit (dBm)	S.G Power Value (dBm)	Correction Factor (dB)	Power Value (dBm)
1	3760	52.99	-13	-51.16	7.68	-43.48
2	5640	50.12	-13	-54.62	7.02	-47.60
3	7520	64.22	-13	-38.40	4.53	-33.87
4	9400	57.60	-13	-44.28	4.21	-40.07
5	11280	58.32	-13	-43.17	3.48	-39.69
6	13160	60.75	-13	-39.85	4.06	-35.79

NOTE: Power Value (dBum) = S.G Power Value (dBm) + Correction Factor (dB).



A D T

MODE	TX channel 810	DETECTOR FUNCTION	Above 1000 MHz
FREQUENCY RANGE	Below 1000 MHz	INPUT POWER	120Vac, 60 Hz
ENVIRONMENTAL CONDITIONS	18deg. C, 60%RH, 1024 hPa	TESTED BY	Wen Yu

ANTENNA POLARITY & TEST DISTANCE: HORIZONTAL AT 3 M						
No.	Freq. (MHz)	Emission Level (dBuV)	Limit (dBm)	S.G Power Value (dBm)	Correction Factor (dB)	Power Value (dBm)
1	3819.6	57.79	-13	-46.58	7.64	-38.94
2	5729.4	47.63	-13	-56.96	6.96	-50.00
3	7639.2	59.21	-13	-43.41	4.43	-38.98
4	9549	58.05	-13	-43.56	4.17	-39.39
5	11458.8	56.48	-13	-44.98	3.73	-41.25
6	13368.6	64.71	-13	-35.61	3.57	-32.04

ANTENNA POLARITY & TEST DISTANCE: VERTICAL AT 3 M						
No.	Freq. (MHz)	Emission Level (dBuV)	Limit (dBm)	S.G Power Value (dBm)	Correction Factor (dB)	Power Value (dBm)
1	3819.6	55.63	-13	-48.74	7.64	-41.10
2	5729.4	49.11	-13	-55.48	6.96	-48.52
3	7639.2	64.84	-13	-37.78	4.43	-33.35
4	9549	57.64	-13	-43.97	4.17	-39.80
5	11458.8	58.02	-13	-43.44	3.73	-39.71
6	13368.6	62.30	-13	-38.02	3.57	-34.45

NOTE: Power Value (dBm) = S.G Power Value (dBm) + Correction Factor (dB).



5 PHOTOGRAPHS OF THE TEST CONFIGURATION

Please refer to the attached file (Test Setup Photo).



6 INFORMATION ON THE TESTING LABORATORIES

We, Bureau Veritas Consumer Products Services (H.K.) Ltd., Taoyuan Branch, were founded in 1988 to provide our best service in EMC, Radio, Telecom and Safety consultation. Our laboratories are accredited and approved according to ISO/IEC 17025.

Copies of accreditation certificates of our laboratories obtained from approval agencies can be downloaded from our web site: www.adt.com.tw/index.5/phtml.

If you have any comments, please feel free to contact us at the following:

Linko EMC/RF Lab:

Tel: 886-2-26052180

Fax: 886-2-26051924

Hsin Chu EMC/RF Lab:

Tel: 886-3-5935343

Fax: 886-3-5935342

Hwa Ya EMC/RF/Safety/Telecom Lab:

Tel: 886-3-3183232

Fax: 886-3-3185050

Web Site: www.adt.com.tw

The address and road map of all our labs can be found in our web site also.



A D T

7 APPENDIX A – MODIFICATIONS RECORDERS FOR ENGINEERING CHANGES TO THE EUT BY THE LAB

No any modifications are made to the EUT by the lab during the test.

---END---