



Test report no. : 58344-7

Item tested : DPC2223

Type of equipment : Isochronous UPCS Device

FCC ID : H8NPKE525VB

Client : Askey Computer Corp.

FCC Part 15, subparts B and D

Isochronous UPCS Device

1920 - 1930 MHz

Industry Canada RSS-213, Issue 2

2 GHz Licence-exempt Personal
Communications Service Devices
(LE-PCS)

7 August 2006

Authorized by : 

Egil Hauger
Technical Verificator



CONTENTS

1	GENERAL INFORMATION.....	3
1.1	Tested by.....	3
1.2	Client Information.....	3
1.3	Manufacturer (if other than client).....	3
2	Test Information.....	4
2.1	Tested Item.....	4
2.2	Test Environment.....	5
2.3	Test Period.....	5
2.4	Test Engineer.....	5
2.5	Test Equipment.....	5
2.6	Other Comments.....	5
3	TEST REPORT SUMMARY.....	6
3.1	General.....	6
3.2	Test Summary.....	7
4	TEST RESULTS.....	8
4.1	Power-line Conducted Emissions.....	8
4.2	Coordination with fixed microwave.....	10
4.3	Digital Modulation Techniques.....	10
4.4	Labelling Requirements.....	10
4.5	Antenna Requirement.....	11
4.6	Channel Frequencies.....	11
4.7	Automatic Discontinuation of Transmission.....	12
4.8	Peak Power Output.....	13
4.9	Emission Bandwidth B.....	16
4.10	Power Spectral Density.....	20
4.11	In-band Unwanted Emissions, Conducted.....	22
4.12	Out-of-band Emissions, Conducted.....	24
4.13	Carrier Frequency Stability.....	27
4.14	Frame Repetition Stability.....	28
4.15	Frame Period and Jitter.....	28
4.16	Monitoring Threshold, Least Interfered Channel.....	31
4.17	Threshold Monitoring Bandwidth.....	33
4.18	Reaction Time and Monitoring Interval.....	34
4.19	Time and Spectrum Window Access Procedure.....	37
4.20	Acknowledgements and Transmission Duration.....	39
4.21	Dual Access Criteria Check.....	40
4.22	Alternative Monitoring Interval.....	40
4.23	Duty Cycle Correction Factor Calculation.....	41
4.24	Spurious Emissions (Radiated).....	42
4.25	Receiver Spurious Emissions.....	54
5	Test Setups.....	55
5.1	Frequency Measurements.....	55
5.2	Timing Measurements.....	55
5.3	Conducted Emission Tests.....	55
5.4	Radiated Emission Tests.....	56
5.5	Powerline Conducted Tests.....	56
5.6	Monitoring Tests.....	57
6	Test Equipment Used.....	58

1 GENERAL INFORMATION

1.1 Tested by

Name : Nemko Comlab
Address : Gåsevikveien 8, Box 96
N-2027 Kjeller, NORWAY
Telephone : +47 64 84 57 00
Fax : +47 64 84 57 05
E-mail: post@comlab.no
FCC test firm registration # : 994405
IC OATS registration # : 4443
Total Number of Pages: 58

1.2 Client Information

Name : Askey Computer Corp.
Address : 10F, No. 119, ChienKang Rd., Chunggho, Taipei, Taiwan, R.O.C.
Telephone : +886 2 222 87558
Fax : +886 2 323 49211

Contact:

Name : Mr. Michael Jeng
E-mail : michaelj@askey.com.tw

1.3 Manufacturer (if other than client)

Name : /
Address : /
Telephone : /
Fax : /
Contact : /
E-mail : /

2 Test Information

2.1 Tested Item

Brand Names :	WebSTAR, Scientific Atlanta
FCC ID :	H8NPKE525VB
Industry Canada ID :	1353A-PKE525VB
Model/version :	DPC2223
Serial number :	/
Hardware identity and/or version:	PKE525VB-D17, HW Version: EOHA
Software identity and/or version :	v.1.11 DECT SW
Frequency Range :	1921.536 – 1928.448 MHz
Tunable Bands :	1
Number of Channels :	5 RF Channels, 5x12 = 60 TDMA Duplex Channels
Operating Modes :	/
Type of Modulation :	GFSK (Gaussian Frequency Shift Keying)
User Frequency Adjustment :	None
Rated Output Power :	70 mW Peak Power; 17.5 mW Average Power (6 active slots)
Type of Power Supply :	External Power Adaptor
Antenna Connector :	None
Antenna Diversity Supported :	Yes
Power Adaptor :	Plug In Class II Power Unit AD-151A

Description of Tested Device(s)

The tested equipment is a DECT Base Station which complies with ETSI EN 300175. The frequencies have been reprogrammed to comply with the FCC requirements to an Isochronous UPCS device after FCC Part 15D.

The EUT is a responding device as described in ANSI C63.17 and is designed to operate together with a DECT handset, which is then the initiating device.

Exposure Evaluation

The EUT is designed to be placed on a table or fixed to a wall etc. and the user manual contains text that it shall be mounted with a separation distance of at least 20 cm from any part of the body. For the purposes of exposure evaluation this EUT is a mobile or fixed device.

MPE Calculation at 20 cm satisfying FCC requirements is submitted as a separate document.

The EUT is exempted from RF Exposure Evaluation to Industry Canada SAR requirements since the output power is below the limit in RSS-102 Issue 2, clause 2.5.2.

2.2 Test Environment

2.2.1 Normal test condition

Temperature:	20 – 22 °C
Relative humidity:	30 – 50 %
Normal test voltage:	115 V AC

The values are the limits registered during the test period.

2.3 Test Period

Item received date:	2006-02-01
Test period :	from 2006-02-01 to 2006-04-07

2.4 Test Engineer

Frode Sveinsen / Tore Løvlien

2.5 Test Equipment

See list of test equipment in clause 6.

2.6 Other Comments

The Monitoring and Time and Spectrum Window Access tests were performed with Test Set-Up 6 (Ref. clause 5). A clock signal from the EUT was used to synchronize the Arbitrary Generator and the Spectrum Analyzer to the start of the DECT time window. The EUT was limited by administrative commands to operate on only two frequency carriers. For the tests where the EUT was required to operate on only one frequency carrier, one carrier was blocked by applying a CW interfering signal from RF Generator 3. The Arbitrary Generator was used to apply time synchronized interference to time windows where this was required.

Since the EUT was programmed to operate on only two RF carriers, it was only necessary with two RF generators for the monitoring tests, however a third generator was applied for the tests that required specific time slots to be blocked.

All tests except the Radiated spurious emissions and the Power line conducted emissions tests were performed in conducted mode with a temporary antenna connector.

The DPC2223 is a Cable System Terminal Device (Cable Modem) with a built in DECT Base Station. The circuitry of the Cable Modem is not directly related to the DECT Base Station and therefore requires testing to FCC Part 15B as a Class B Device. Since the Cable Modem is associated with a Category I transmitter (the DECT Base) it is classified as Category I equipment according to Industry Canada RSS-Gen and therefore requires certification.

All Radiated Emissions tests were performed with all ports populated and operating, including the Cable Modem.

3 TEST REPORT SUMMARY

3.1 General

Manufacturer: Askey Computer Corp.
Model No.: DPC2223
Serial No.: /

All measurements are traceable to national standards.

The tests were conducted on a sample of the equipment for the purpose of demonstrating compliance with FCC CFR47 Part 15.323 for Isochronous UPCS Devices and Industry Canada RSS-213 Issue 2. Tests were also conducted to show compliance with FCC CFR Part 15B for a Class B device and Industry Canada RSS-GEN for a Category I Equipment Receiver.

The conducted test methods have been in accordance with ANSI C63.17-2006 Draft 3.5 where applicable.

Radiated tests were conducted in accordance with ANSI C63.4-2003. Radiated emissions are made in a 10m semi-anechoic chamber. A description of the test facility is on file with the FCC and Industry Canada.

- | | |
|---|---|
| <input checked="" type="checkbox"/> New Submission | <input checked="" type="checkbox"/> Production Unit |
| <input type="checkbox"/> Class II Permissive Change | <input type="checkbox"/> Pre-production Unit |
| PUB Equipment Code | <input type="checkbox"/> Family Listing |

THIS TEST REPORT RELATES ONLY TO THE ITEM (S) TESTED.

Deviations from, additions to, or exclusions from the test specifications are described in "Summary of Test Data".



TEST REPORT NO: 58344-7

TESTED BY :



Frode Sveinsen, Test Engineer

DATE: 7 August 2006

Nemko Comlab authorizes the above named company to reproduce this report provided it is reproduced in its entirety and for use by the company's employees only. Any reproduction of parts of this report requires approval in writing from Nemko Comlab.

Any use which a third party makes of this report, or any reliance on or decisions to be made based on it, are the responsibility of such third parties. Nemko Comlab accepts no responsibility for damages suffered by any third party as a result of decisions made or actions based on this report.

This test report applies only to the items and configurations tested.

3.2 Test Summary

Name of test	FCC CFR 47 Paragraph #	IC RSS-213 Paragraph #	Verdict
Coordination with fixed microwave	15.307(b)	N/A	Complies
Digital Modulation Techniques	15.319(b)	6.1	Complies
Labelling requirements	15.19(a)(3)	RSS-GEN 5.2	Complies
Antenna Requirement	15.317, 15.203	4.1(e)	Complies
Power-line Conducted Emission	15.107(a) 15.207(a)	6.3 RSS-GEN 7.2.2	Complies
Emission Bandwidth	15.323(a)	6.4	Complies
In-band emissions	15.323(d)	6.7.2	Complies
Out-of-band emissions	15.323(d)	6.7.1	Complies
Peak transmit Power	15.319(c), 15.31(e)	6.5	Complies
Power Spectral Density	15.319(d)	4.3.2.1	Complies
Automatic discontinuation of transmission	15.319(f)	4.3.4(a)	Complies
Carrier frequency stability	15.323(f)	6.2	Complies
Frame repetition stability	15.323(e)	4.3.4(c)	Complies
Frame period and jitter	15.323(e)	4.3.4(c)	Complies
Monitoring threshold, Least interfered channel	15.323(c)(2);(5); (9)	4.3.4(b)	Complies
Monitoring of intended transmit window and maximum reaction time	15.323(c)(1)	4.3.4(b)	Complies
Threshold monitoring bandwidth	15.323(c)(7)	4.3.4(b)	Complies
Reaction time and monitoring interval	15.323(c)(1);(5); (7)	4.3.4(b)	Complies
Access criteria test interval	15.323(c)(4);(6)	4.3.4(b)	Complies
Access Criteria functional test	15.323(c)(4);(6)	4.3.4(b)	Complies
Acknowledgements	15.323(c)(4)	4.3.4(b)	Complies
Transmission duration	15.323(c)(3)	4.3.4(b)	N/A ¹
Dual access criteria	15.323(c)(10)	4.3.4(b)	N/A ¹
Alternative monitoring interval	15.323(c)(10);(11)	4.3.4(b)	N/A ²
Spurious Emissions (Antenna Conducted)	15.323(d)	6.7.1	Complies ³
Spurious Emissions (Radiated)	15.319(g) 15.109(a) 15.209(a)	4.3.3 RSS-GEN 7.2.3	Complies
Receiver Spurious Emissions	N/A	6.8	Complies

¹ Only applies for EUT that can be initiating device

² The manufacturer declares that the tested EUT does not implement this provision

³ The tested equipment has integrated antennas only

4 TEST RESULTS

4.1 Power-line Conducted Emissions

Para. No.: 15.107(a), 15.207(a)

Test Performed By: Tore Løvlien	Date of Test: 7 April 2007
---------------------------------	----------------------------

Measurement procedure: ANSI C63.4-2003 using 50 µH/50 ohms LISN.

Test Results: **Complies**
 Measurement Data: **See attached graph, (Peak detector).**

Highest measured values (L1 and N):

Frequency	Detector	Measured value	Limit	Margin
MHz	Peak/QP/AV	dBµV	dBµV	dB
0.150	QP	59.6	66	6.4
	AV	27.8	56	28.2
0.340	QP	52.7	59.2	6.5
	AV	24.0	49.2	25.2
0.700	QP	42.4	56	13.6
	AV	19.6	46	26.4
1.18825	QP	38.4	56	17.6
	AV	22.8	46	23.2
1.49	QP	40.6	56	15.4
	AV	24.9	46	21.1



Date 07.Apr.'06 Time 12:15:38
 Ref.Lvl
 100.00 dBuV

Res.Bw 9 kHz[imp]
 TG.Lvl off
 Scan.Stp 4.500 kHz

T1: PK+ T3:
 T2: PK+ T4:
 RF.Att 10 dB
 Unit [dBuV]

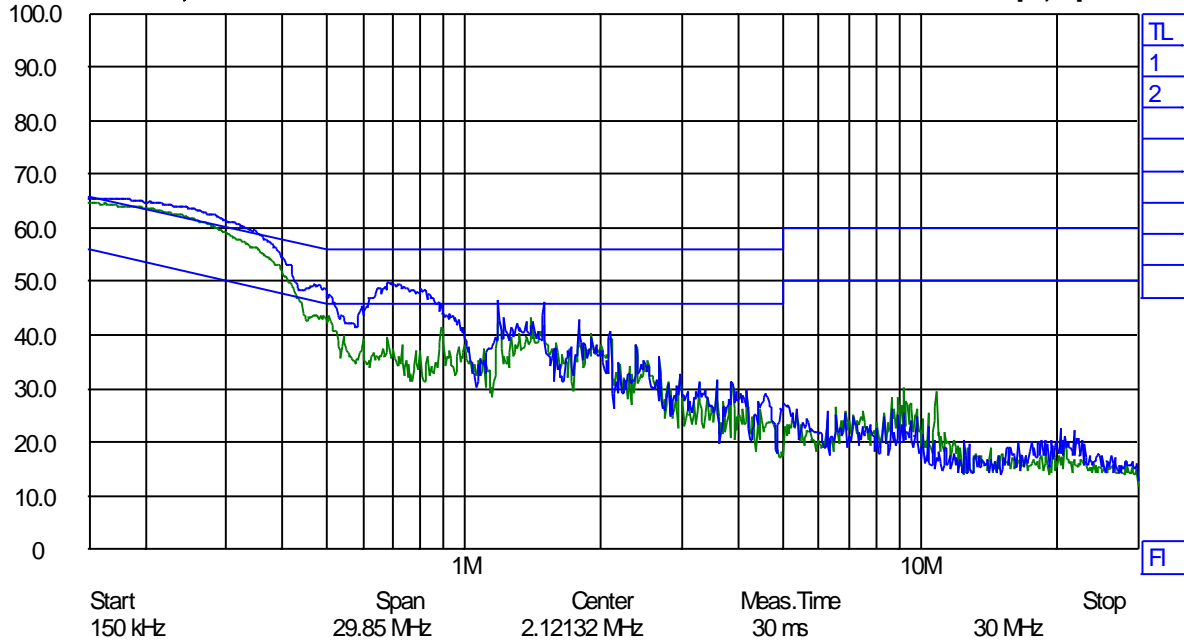

RTX Sabrina FCC 60 Hz 115V AC N to gnd, L1 to gnd

Conducted Emissions, Peak, N and L1

4.2 Coordination with fixed microwave

The affidavit from UTAM, Inc. is included in the documentation supplied by the applicant:

Yes

No

Requirement, FCC 15.307 (b):

Each application for certification of equipment operating under the provisions of this Subpart must be accompanied by an affidavit from UTAM, Inc. certifying that the applicant is a participating member of UTAM, Inc. In the event a grantee fails to fulfill the obligations attendant to participation in UTAM, Inc., the Commission may invoke administrative sanctions as necessary to preclude continued marketing and installation of devices covered by the grant of certification, including but not limited to revoking certification.

4.3 Digital Modulation Techniques

The tested equipment is based on DECT technology described in the ETSI standard EN 300175, the only difference is that the channel allocation is modified to operate in the 1920-1930 MHz band.

The EUT used Multi Carrier / Time Division Multiple Access / Time Division Duplex and Digital GFSK modulation.

For further details see the operational description provided by the applicant.

Requirement, FCC 15.319(b):

All transmissions must use only digital modulation techniques.

4.4 Labelling Requirements

See separate documents showing the label design and the placement of the label on the EUT.

Requirements FCC 15.19

The FCC Identifier shall be displayed on the label, and the device(s) shall bear the following statement in a conspicuous location on the device or in the user manual if the device is too small:

This device complies with Part 15 of the FCC Rules. Operation is subject to the following two conditions: (1) this device may not cause harmful interference, and (2) this device must accept any interference received, including interference that may cause undesired operation.

The label itself shall be of a permanent type, not a paper label, and shall last the lifetime of the equipment.

4.5 Antenna Requirement

Does the EUT have detachable antenna? Yes No
 If detachable, is the antenna connector non-standard? Yes No

The tested equipment has only integral antennas. The conducted tests were performed on a sample with a temporary antenna connector.

Requirement: FCC 15.203, 15.317.

4.6 Channel Frequencies

UPCS CHANNEL	FREQUENCY (MHz)
Upper Band Edge	1930.000
0 (Highest)	1928.448
1	1926.720
2	1924.992
3	1923.264
4 (Lowest)	1921.536
Lower Band Edge	1920.000

Requirement: FCC 15.303 (d), (g)

Within 1920 -1930 MHz band for isochronous devices.

4.7 Automatic Discontinuation of Transmission

The EUT transmits Control and Signalling Information?	<input checked="" type="checkbox"/> YES	<input type="checkbox"/> NO
TYPE OF EUT :	<input type="checkbox"/> INITIATING DEVICE	<input checked="" type="checkbox"/> RESPONDING DEVICE

The following tests simulate the reaction of the EUT in case of either absence of information to transmit or operational failure after a connection with the companion device is established.

Number	Test	EUT Reaction	Verdict
1	Power removed from the EUT	A	Pass
2	EUT Switch Off	N/A	Pass
3	Hook-On by companion device	B	Pass
4	Hook-On by EUT	N/A	Pass
5	Power Removed from Companion Device	B	Pass
6	Companion Device Switch Off	B	Pass

- A - Connection breakdown, Cease of all transmissions
- B - Connection breakdown, EUT transmits control and signalling information
- C - Connection breakdown, Companion Device transmits control and signalling information
- N/A - Not Applicable (Hook-On and Switch Off is not possible on EUT)

Requirements, FCC 15.319(f)

The device shall automatically discontinue transmission in case of either absence of information to transmit or operational failure. These provisions are not intended to preclude transmission of control and signalling information or use of repetitive codes used by certain digital technologies to complete frame or burst intervals.

4.8 Peak Power Output

Test Method:

ANSI C63.17 D3.5, clause 6.1.2.

Test Results: Complies

Measurement Data:

Maximum Conducted Output Power

Channel No.	Frequency (MHz)	Maximum Conducted Output Power (dBm)	Maximum Radiated Output Power (dBm)	Maximum Antenna Gain
4	1921.536	18.3	22.2	3.9
0	1928.448	18.0	21.2	3.2

Measurement method according to ANSI C63.17 D3.5 paragraph 6.1.3

For this test it was also checked that input voltage variation of 85 and 115% of nominal value did not have any effect on the measured output power, either radiated or conducted.

Limit:

Conducted: $100 \mu\text{W} \times \text{SQRT}(B) = 114 \text{ mW} = \mathbf{20.6 \text{ dBm}}$, where B is the measured Emission Bandwidth in Hz

Manufacturer declared antenna gain: +5 dBi

Limit is reduced by 2.0 dB for antenna gain ≥ 3 dB: **New calculated limit: 18.6 dBm**

Requirements, FCC 15.319(c)(f)

Peak transmit power shall not exceed 100 microwatts multiplied by the square root of the emission bandwidth in hertz.

The peak transmit power shall be reduced by the amount in decibels that the maximum directional gain of the antenna exceeds 3 dBi.

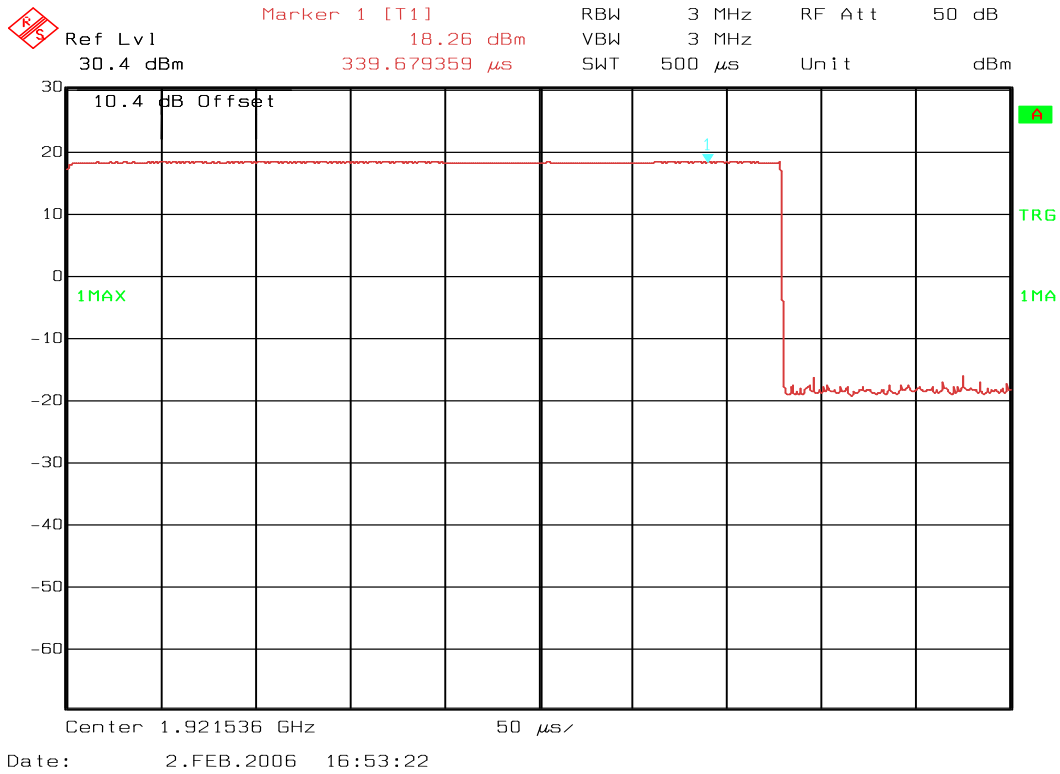

Conducted Peak Transmit Power, ch 04

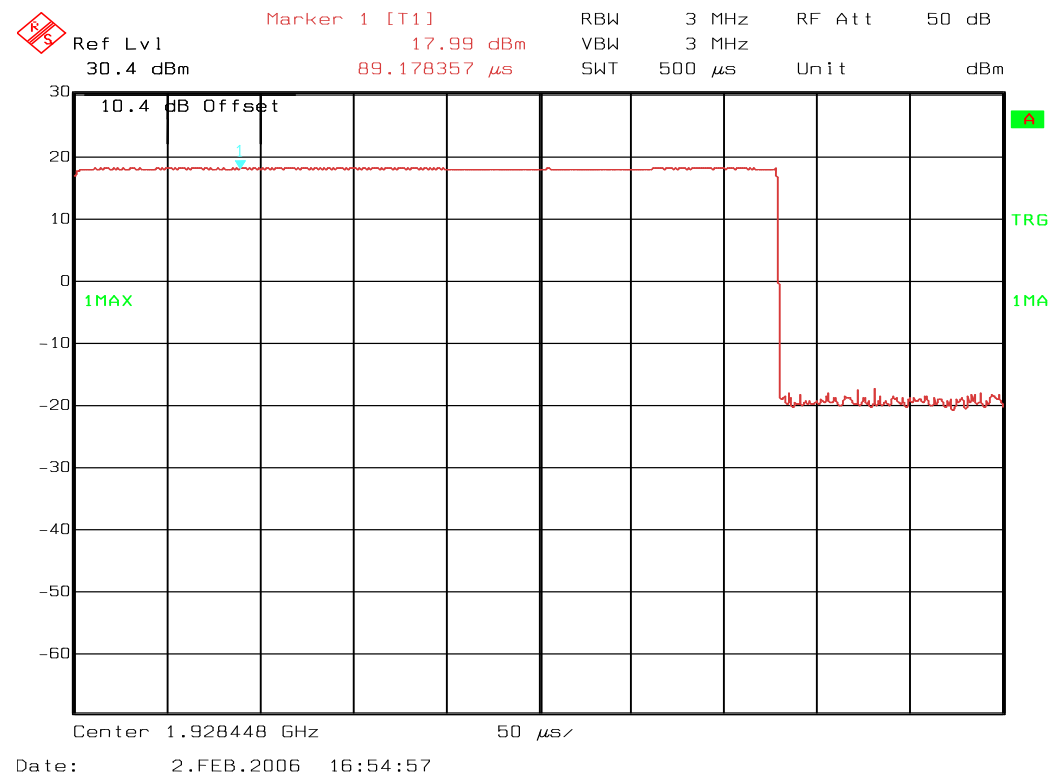

Conducted Peak Transmit Power, ch 00

Radiated Peak Transmit Power

Antenna 0:

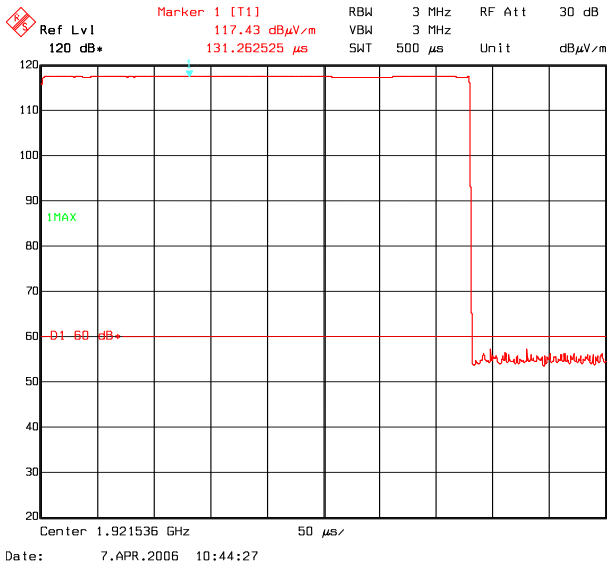

channel 4

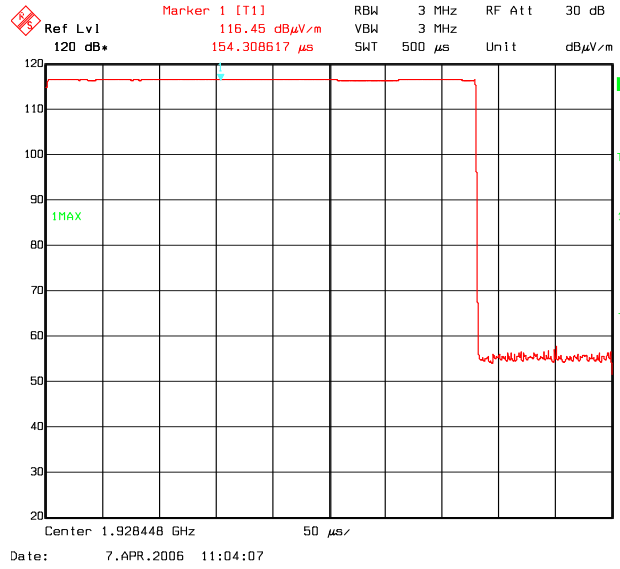

channel 0

Antenna 1:

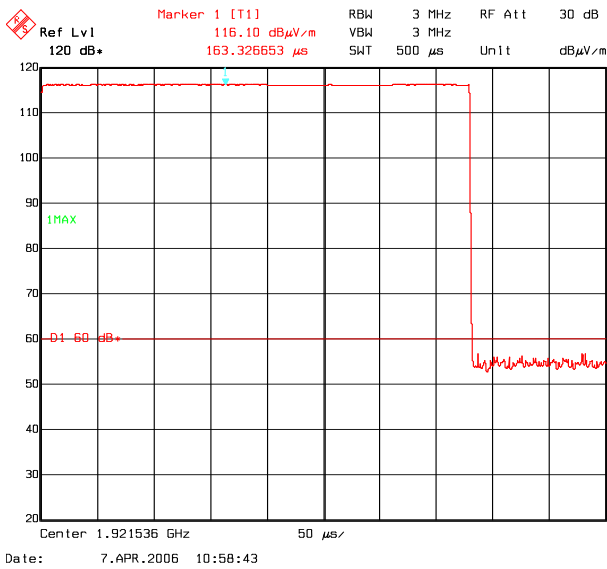

channel 4

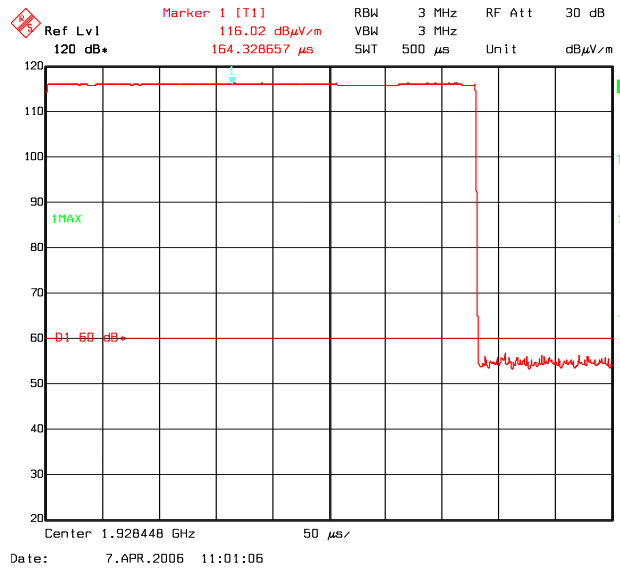

channel 0

4.9 Emission Bandwidth *B*

Test Method:

ANSI C63.17 D3.5, clause 6.1.3.

Test Results: Complies

Measurement Data:

Channel No.	Frequency (MHz)	26 dB Bandwidth <i>B</i> (kHz)
4	1921.536	1303
0	1928.448	1303

Channel No.	Frequency (MHz)	6 dB Bandwidth (kHz)
4	1921.536	782
0	1928.448	782

Channel No.	Frequency (MHz)	12 dB Bandwidth (kHz)
4	1921.536	1202
0	1928.448	1202

Measurement method according to ANSI C63.17 D3.5 paragraph 6.1.3

Requirements, FCC 15.323(a)

The 26 dB Bandwidth *B* shall be larger than 50 kHz and less than 2.5 MHz.

No requirements for 6 and 12 dB Bandwidth. These values are only used when testing the Threshold Monitoring Bandwidth using the Simple Compliance Test (ANSI C63.17 D3.5 clause 7.4).

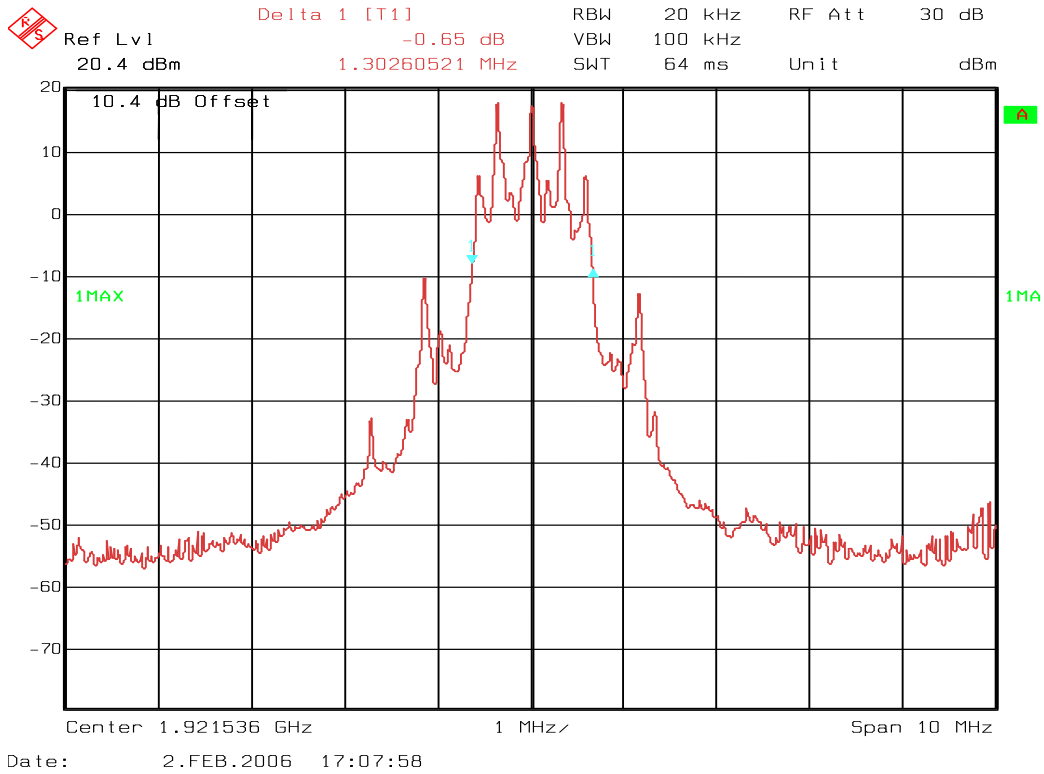

Conducted Emission Bandwidth B 26 dB, ch 04

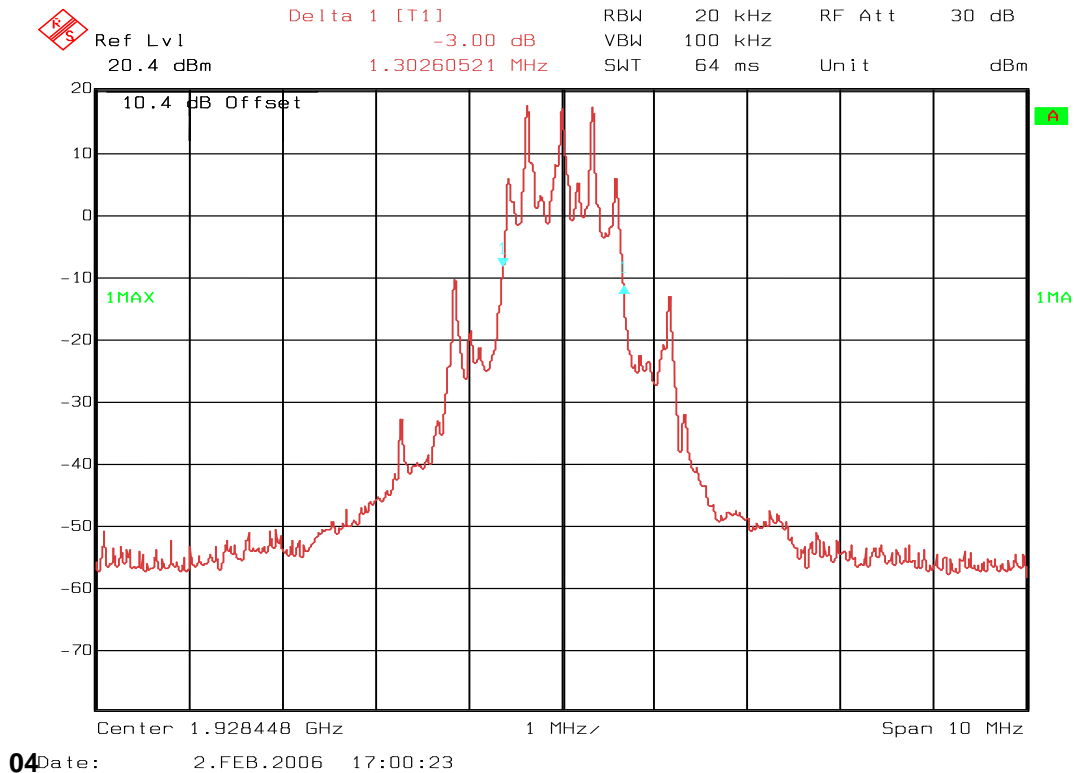

Conducted Emission Bandwidth B 26 dB, ch 00

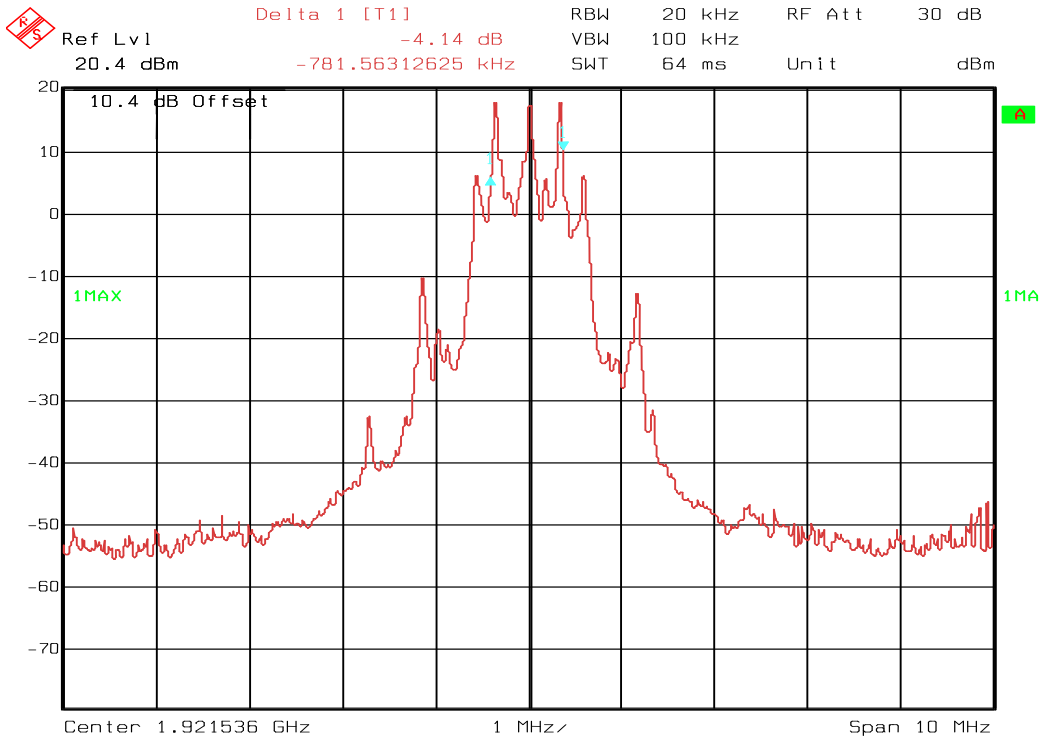

Date: 2.FEB.2006 17:30:32

Conducted 6dB Bandwidth, ch 04

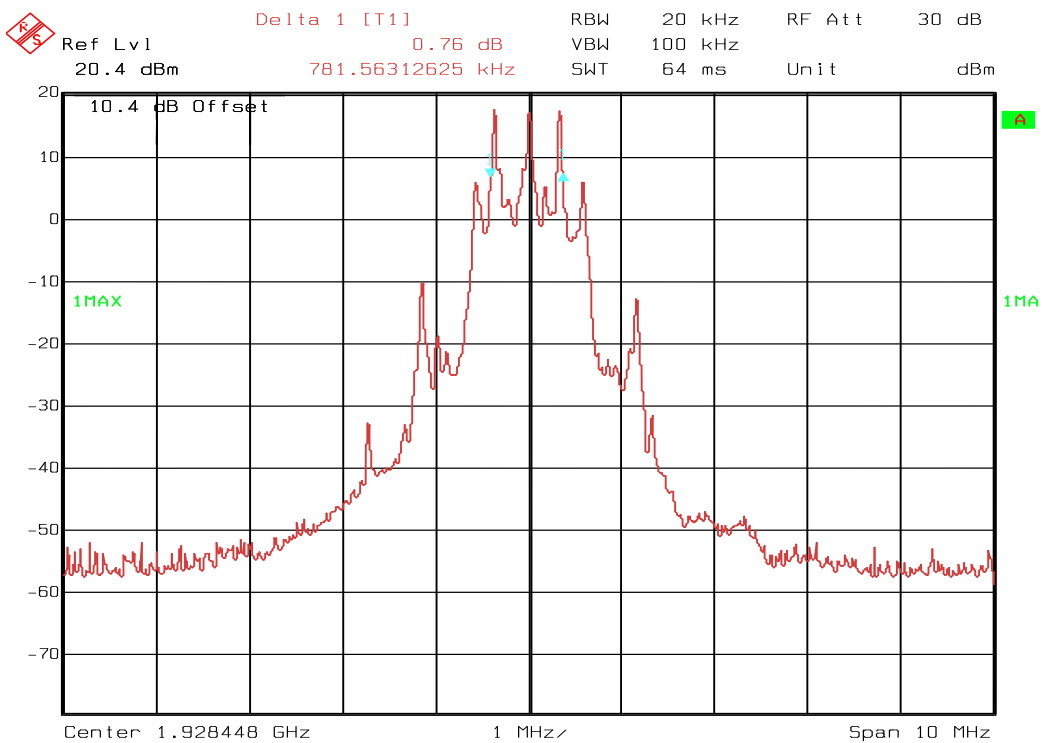

Date: 2.FEB.2006 17:39:13

Conducted 6dB Bandwidth, ch 00

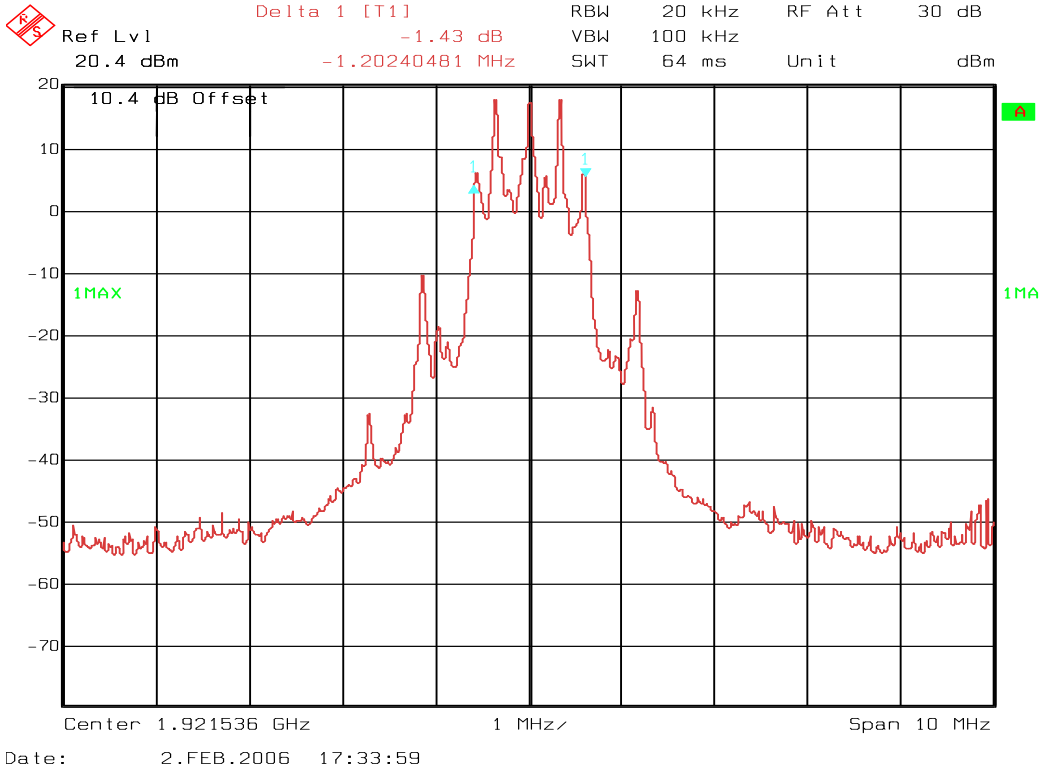

Conducted 12dB Bandwidth, ch 04

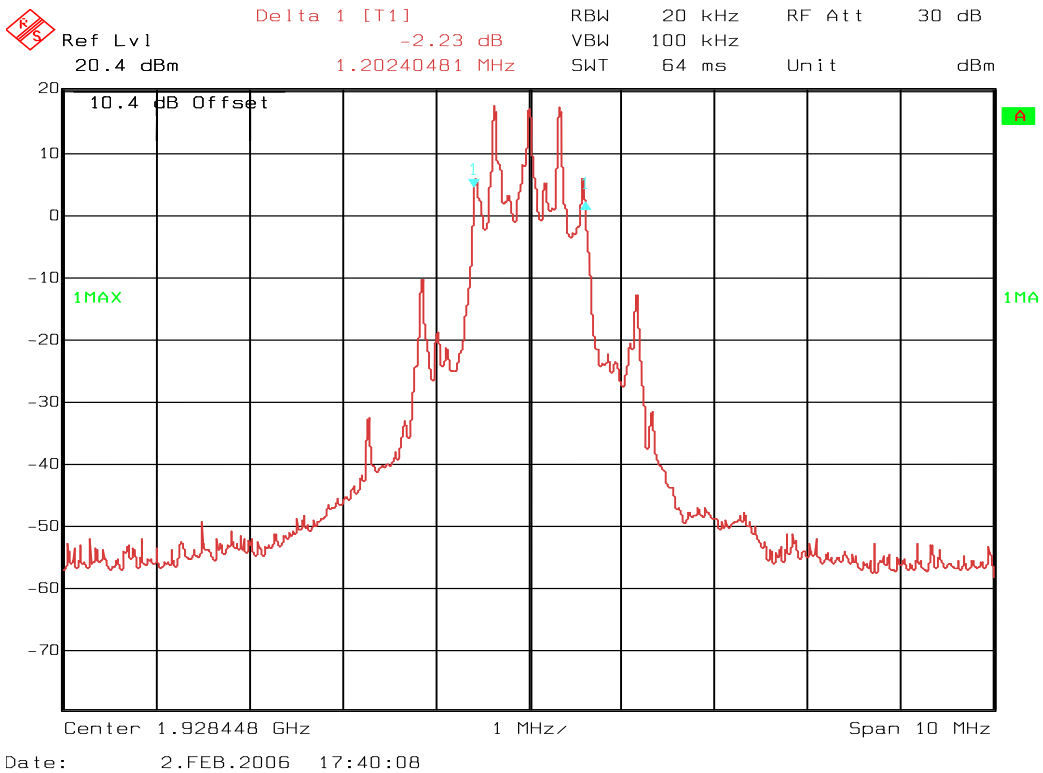

Conducted 12dB Bandwidth, ch 00

4.10 Power Spectral Density

Test Method:

ANSI C63.17 D3.5, clause 6.1.5.

Test Results: Complies

Measurement Data:

Channel No.	Frequency (MHz)	Power Spectral Density (dBm)
4	1921.536	-1.1
0	1928.448	-2.3

Averaged over 100 sweeps.

Measurement method according to ANSI C63.17 D3.5 paragraph 6.1.5.

Requirements, FCC 15.319(d)

The Power Spectral Density shall be less than 3 mW (4.77 dBm) when averaged over 100 sweeps.

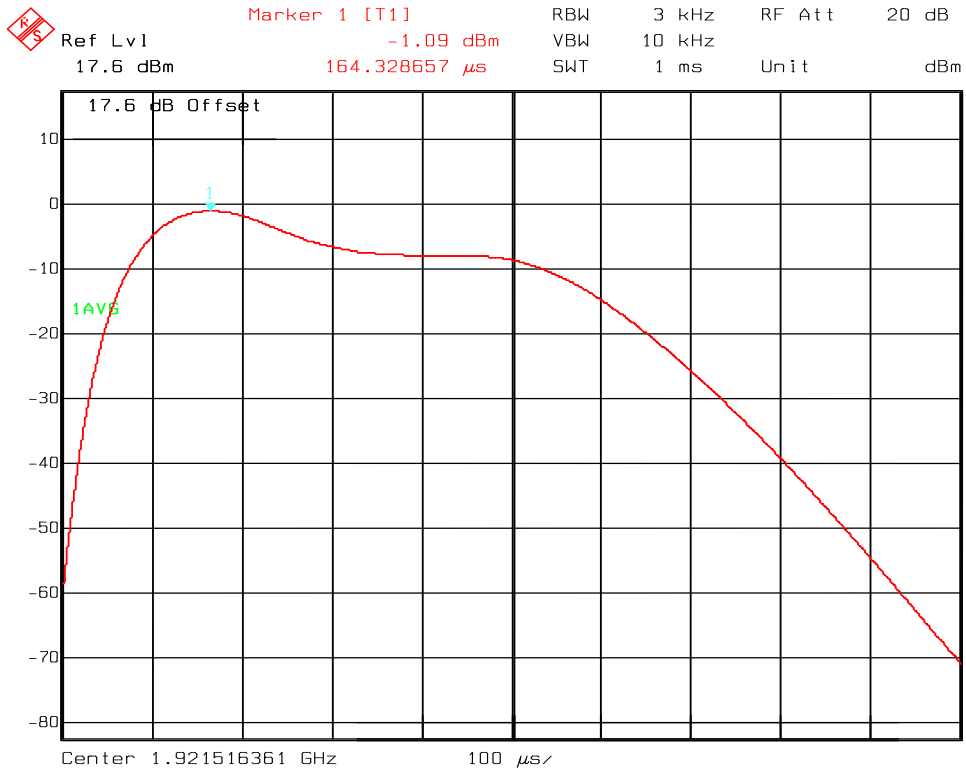

Date: 9.FEB.2006 17:14:02

Power Spectral Density, Average 100 sweeps, Lower Channel

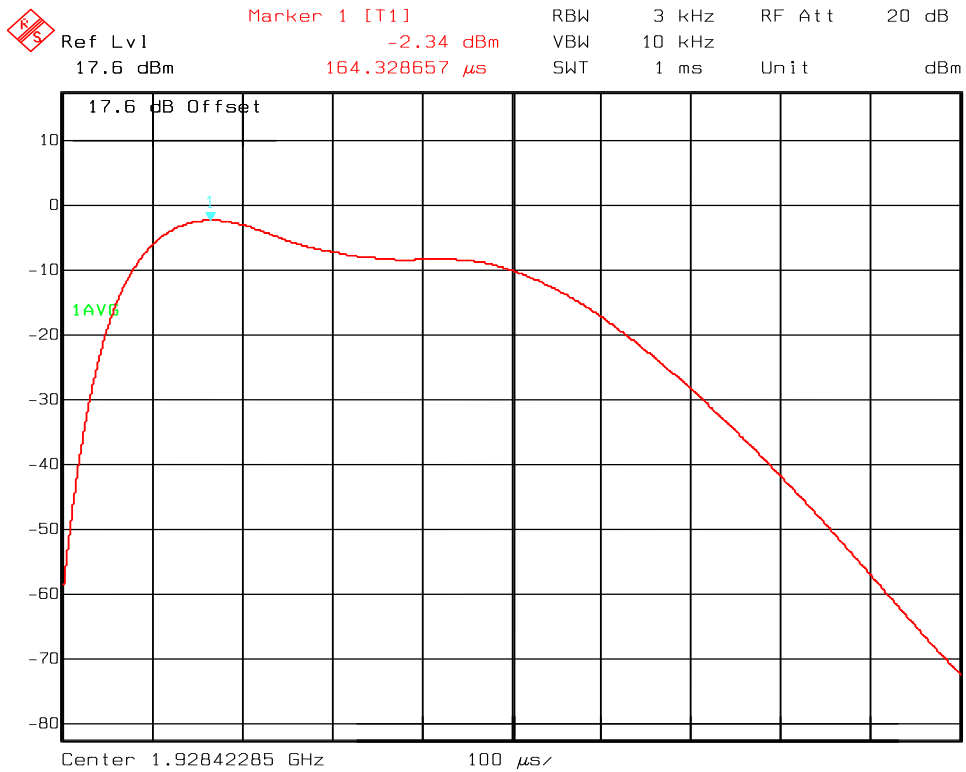

Date: 9.FEB.2006 16:56:56

Power Spectral Density, Average 100 sweeps, Upper Channel

4.11 In-band Unwanted Emissions, Conducted

Test Method:

ANSI C63.17 D3.5, clause 6.1.6.1.

Test Results: Complies

Measurement Data:

See plots.

Requirements, FCC 15.323(d):

$B < f \leq 2B$: less than or equal to 30 dB below max. permitted peak power level

$2B < f \leq 3B$: less than or equal to 50 dB below max. permitted peak power level

$3B < f \leq$ UPCS Band Edge : less than or equal to 60 dB below max. permitted peak power level

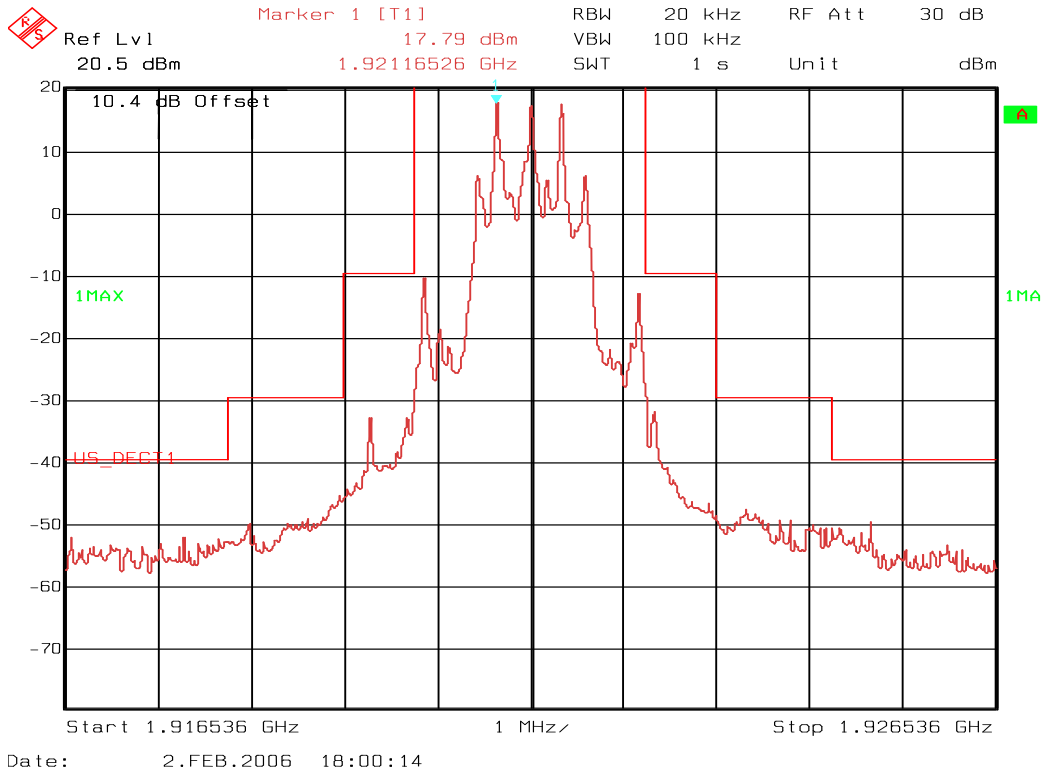

Conducted In-Band Emissions, Lower Channel

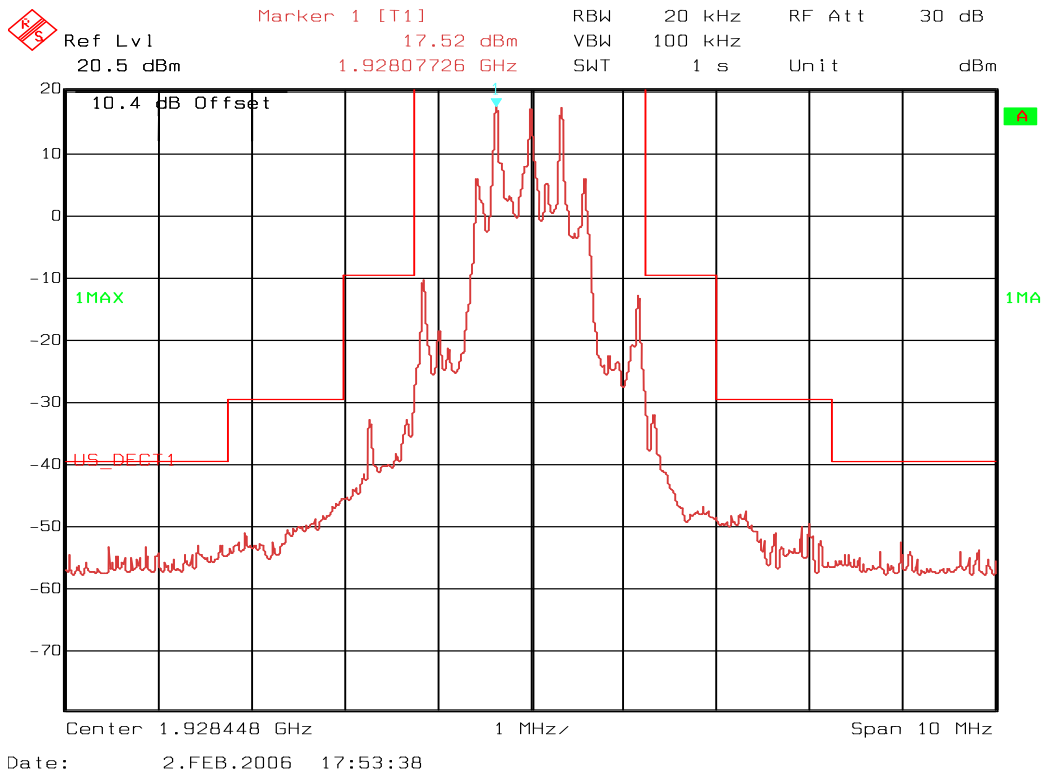

Conducted In-Band Emissions, Upper Channel

4.12 Out-of-band Emissions, Conducted

Test Method:

ANSI C63.17 D3.5, clause 6.1.6.2.

Test Results: Complies

Measurement Data:

See plots.

Requirements, FCC 15.323(d):

$f \leq 1.25\text{MHz}$ outside UPCS band :	$\leq -9.5\text{dBm}$
$1.25\text{MHz} \leq f \leq 2.5\text{MHz}$ outside UPCS band :	$\leq -29.5 \text{ dBm}$
$f \geq 2.5\text{MHz}$ outside UPCS band :	$\leq -39.5 \text{ dBm}$

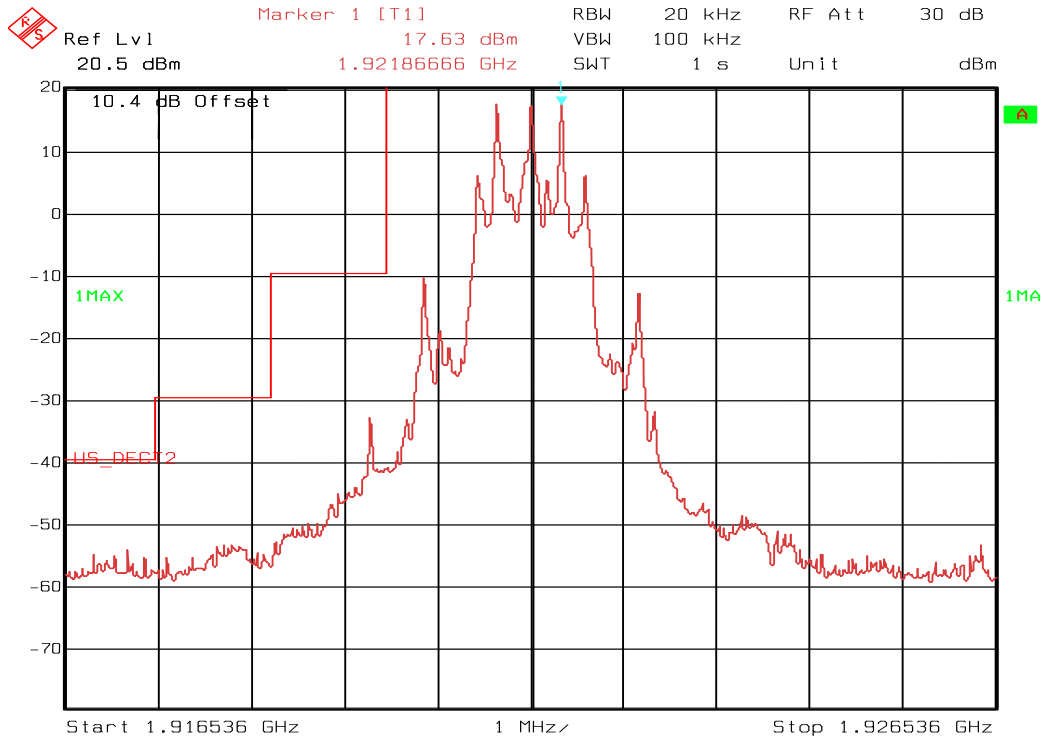

Date: 2.FEB.2006 18:03:23

Conducted Out-of-Band Emissions, Lower Channel

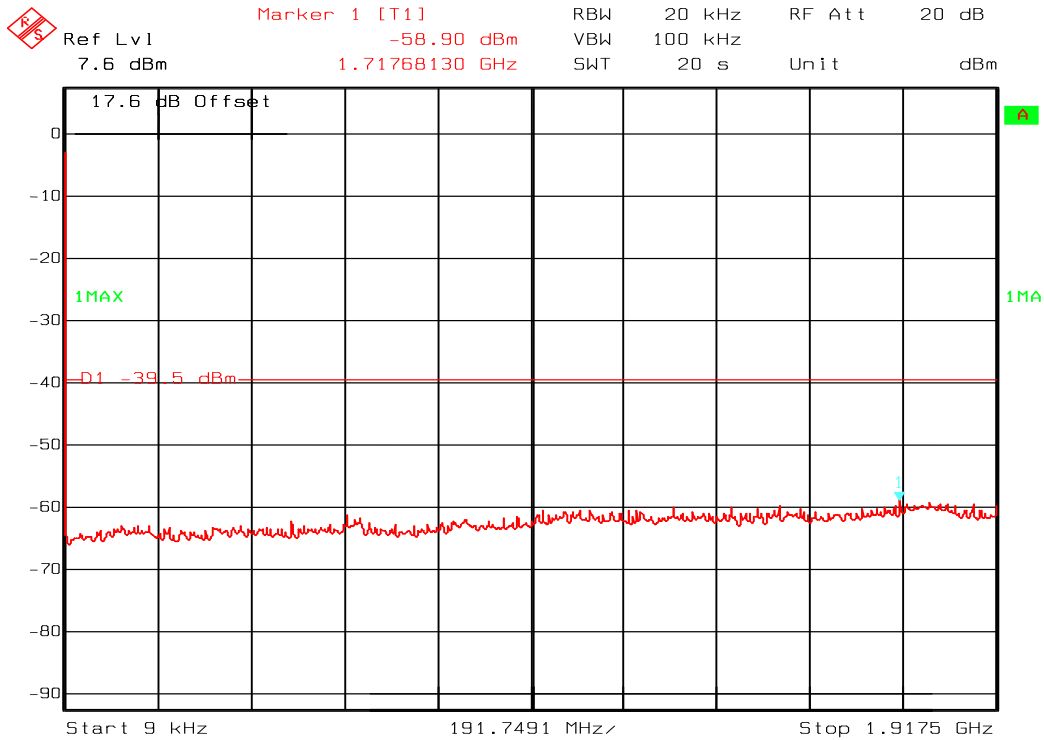

Date: 9.FEB.2006 17:22:47

Conducted Out-of-Band Emissions, Lower Channel

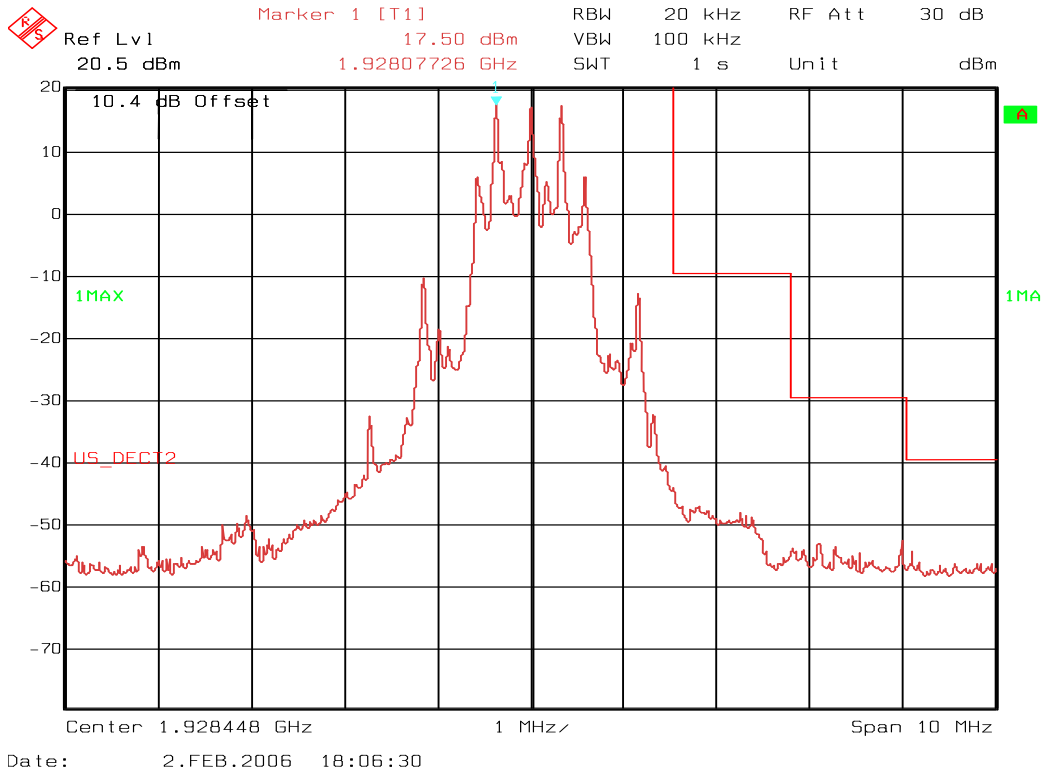

Conducted Out-of-Band Emissions, Upper Channel

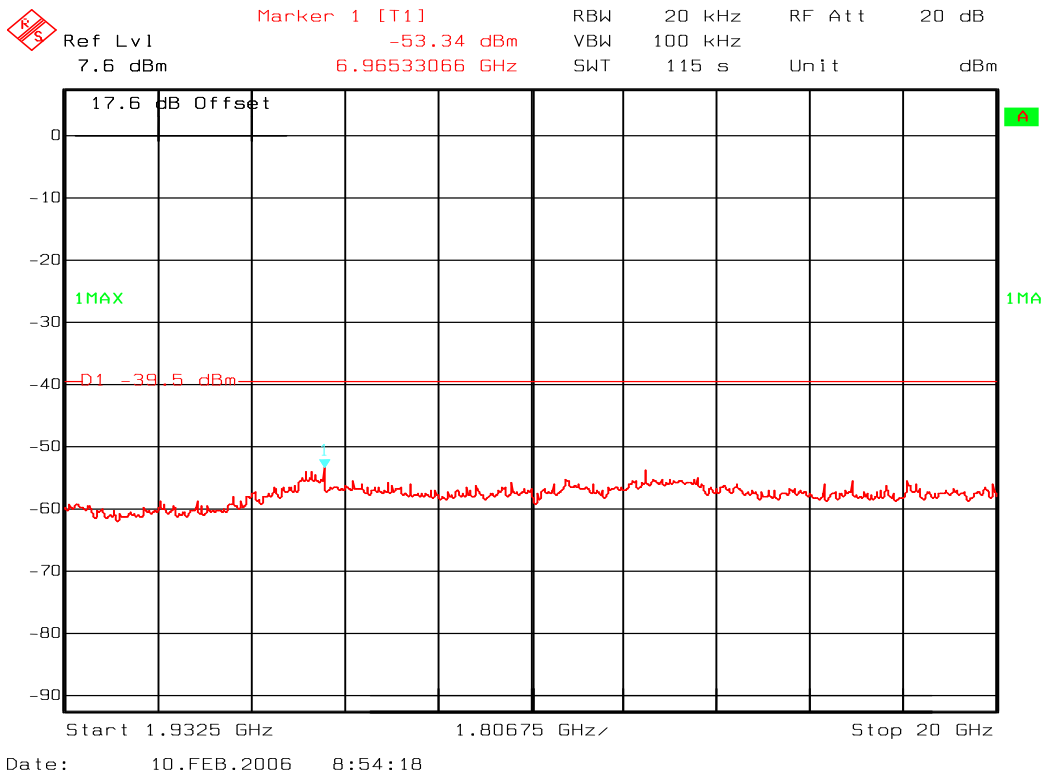

Conducted Out-of-Band Emissions, Upper Channel

4.13 Carrier Frequency Stability

Test Method:

ANSI C63.17, clause 6.2.1.

Test Results: Complies

Measurement Data:

The Carrier frequency stability is measured directly with a Frequency Domain Analyzer in histogram mode. Frequency Deviation in ppm is calculated.

Frequency Stability over 1 hour of operation at Nominal Temperature

Voltage	Measured Carrier Frequency (MHz)	Pk-Pk Difference (kHz)	Deviation ppm	Limit
115V AC	1924.974217	31.2	8.1	±10 ppm

$$\text{Deviation ppm} = ((\text{Pk-Pk difference} / 2) / \text{Mean}) \times 10^6$$

Frequency Stability over Power Supply Voltage at Nominal Temperature

Voltage	Measured Carrier Frequency (MHz)	Difference (kHz)	Deviation ppm	Limit
115 V AC	1924.949235	0	0	±10 ppm
98V AC	1924.949161	-0.074	0.038	
132V AC	1924.949229	-0.006	0.003	

$$\text{Deviation ppm} = ((\text{Mean} - \text{Measured Frequency}) / \text{Mean}) \times 10^6$$

Frequency Stability over Temperature

Temperature	Measured Carrier Frequency (MHz)	Difference (kHz)	Deviation ppm	Limit
T = +20 °C	1924.952244	0	0	
T = -20 °C	1924.948876	3.4	1.7	
T = +50 °C	1924.942430	9.8	5.1	

$$\text{Deviation ppm} = ((\text{Mean} - \text{Measured Frequency}) / \text{Mean}) \times 10^6$$

4.14 Frame Repetition Stability

Test Results: Complies

Measurement Data:

The envelope of the RF signal from the EUT is detected with a Crystal Detector and the mean and standard deviation of the frame repetition frequency is then gated over 100 frames and measured with a frequency domain analyzer. The frame repetition stability is 3 times the standard deviation.

Carrier Frequency	Mean (Hz)	Standard Deviation (Hz)	Frame Repetition Stability (ppm)
1924.992	101.052	0.00000283	0.084

Limit:

Frame Repetition Stability	±10 ppm (TDMA)
-----------------------------------	----------------

Ref. FCC 15.323(e), ANSI C63.17 clause 6.2.2

4.15 Frame Period and Jitter

Test Results: Complies

Measurement Data:

Carrier Frequency	Frame Period (ms)	Max Jitter (µs)	3xStandard Deviation of Jitter (µs)
1924.992	9.8958	0.035	0.022

Max Jitter = (1/ (Frame period + Pk-Pk/2)) - (1/Frame Period), when Pk-Pk and Frame Period are in Hz

Limit:

Frame Period	20 or 10/x ms
Max Jitter	25 µs
3 times St.Dev of Jitter	12.5 µs

Ref. FCC 15.323(e), ANSI C63.17 clause 6.2.3

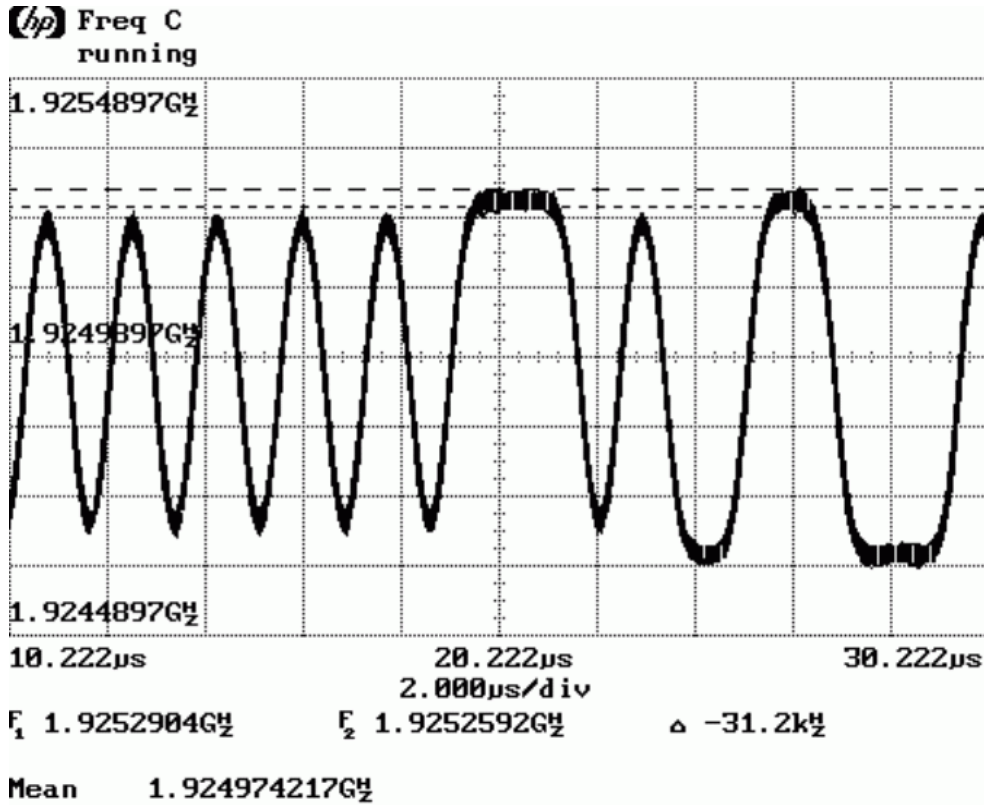

Long Term Carrier Frequency Stability

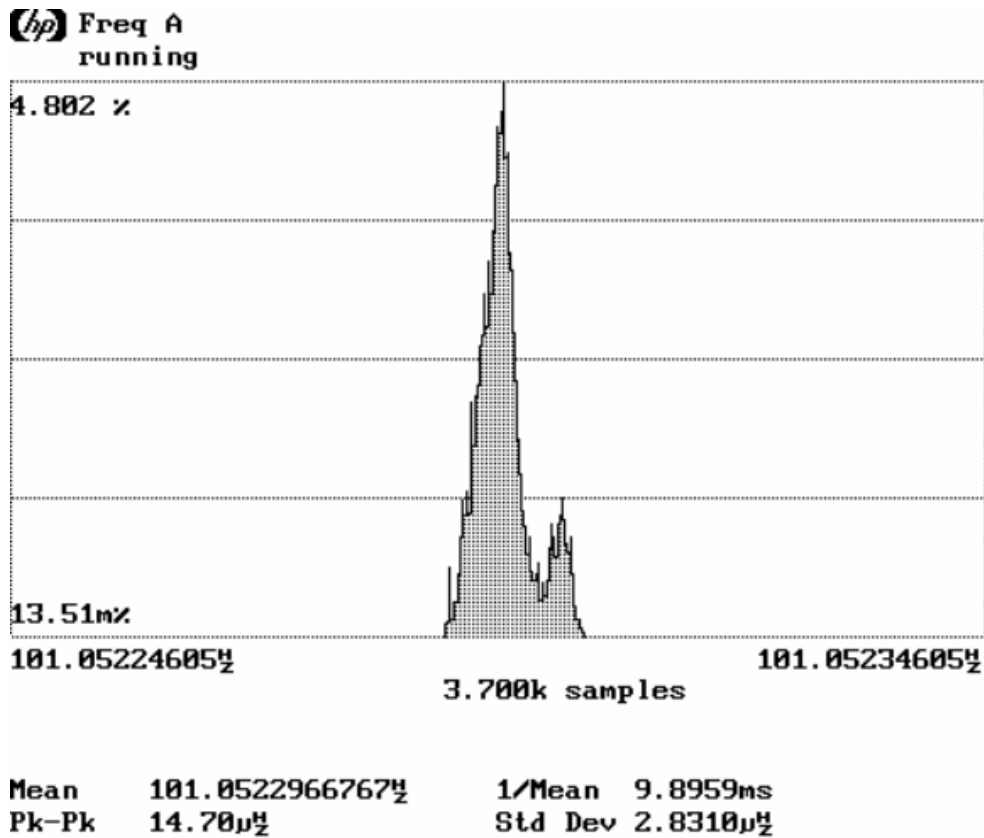

Frame Repetition Stability, Gated over 100 Frames

4.16 Monitoring Threshold, Least Interfered Channel

Monitoring Threshold Limits:

Lower Threshold:

$$T_L = 15 \log B - 184 + 30 - P_{EUT} \quad (\text{dBm})$$

Upper Threshold:

$$T_U = 15 \log B - 184 + 50 - P_{EUT} \quad (\text{dBm})$$

B is measured Emission Bandwidth in Hz
 P is measured Transmitter Power in dBm

Calculated values:

Lower Threshold	-80.6 dBm
Upper Threshold	-60.6 dBm

The upper Threshold is applicable for systems which have defined a minimum of 40 duplex system access channels.

Measurement Procedure:

The Upper or Lower Threshold is found by the procedure defined in ANSI C63.17 clause 7.3.1 or 7.3.2.

Least Interfered Channel	
Lower Threshold	N.A.
Upper Threshold	-61.1 dBm

Least Interfered Channel (LIC) Procedure Test, FCC 15.323(b), (c)(2) and (c)(5)

ANSI C63.17 clause 7.3.3 ref.	Observation	Verdict
b) f_1 $T_L + 13$ dB, f_2 at $T_L + 6$ dB	Transmission always on f_2	Pass
c) f_1 $T_L + 6$ dB, f_2 at $T_L + 13$ dB	Transmission always on f_1	Pass
d) f_1 $T_L + 7$ dB, f_2 at T_L	Transmission always on f_2	Pass
e) f_1 T_L , f_2 at $T_L + 7$ dB	Transmission always on f_1	Pass

Selected Channel Confirmation, FCC 15.323(c)(1) and (5)

ANSI C63.17 clause 7.3.4	Observation	Verdict
b) Shall not transmit on f_1	EUT transmits on f_2	Pass
d) Shall not transmit on f_2	EUT transmits on f_1	Pass

Limits:

Lower Threshold + 6 dB margin	-74.6 dBm
Upper Threshold + 6 dB margin	-54.6 dBm

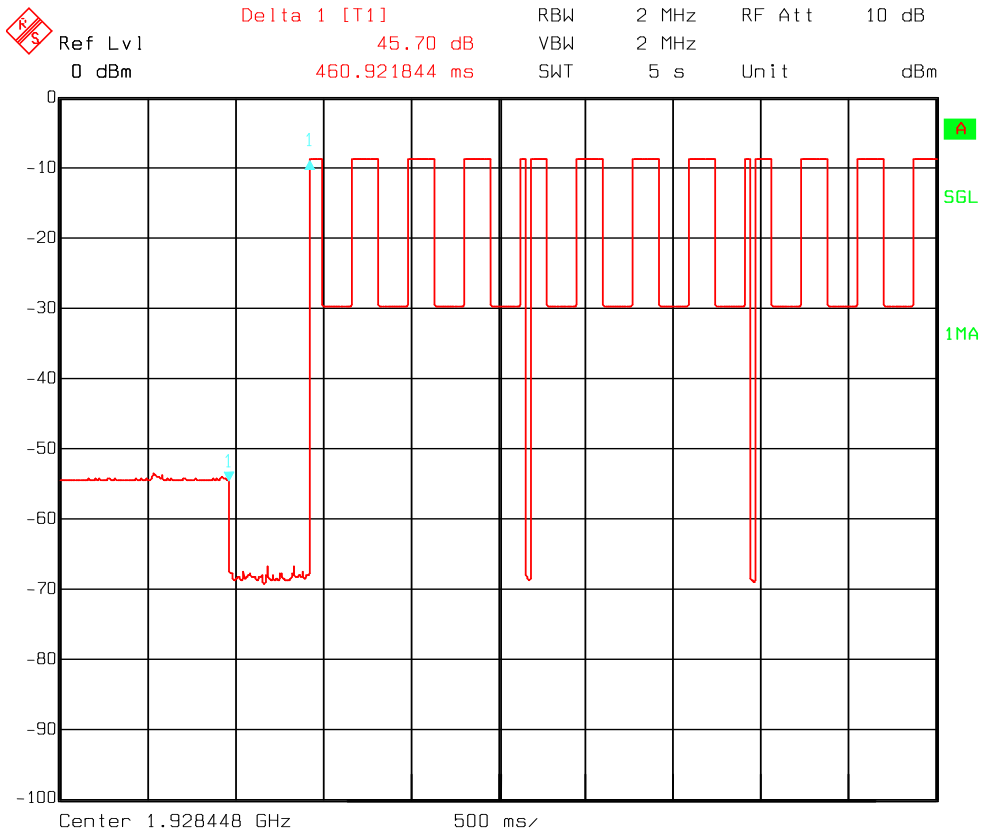

Date: 10.FEB.2006 15:28:31

7.3.4 c) d) EUT transmission on f_2 , 460 ms after interferer is removed

4.17 Threshold Monitoring Bandwidth

This test is only required if a dedicated monitoring receiver is used. However, if the test is not carried out the manufacturer shall declare and provide proper evidence that the monitoring is made through the radio receiver used for communication.

Measurement Procedure:

Simple Compliance Test, ANSI C63.17, clause 7.4.1

More Detailed Test, ANSI C63.17, clause 7.4.2

The test is passed if either the Simple Compliance Test or the More Detailed test is passed.

During this test the spectrum analyzer is observed visually to see if the EUT transmits or not.

Test Results:

Test performed	Observation	Verdict
Simple Compliance test, at $\pm 30\%$ of B	No connection	Pass
More Detailed Test, at -6 dB points	N/A	N/A
More Detailed Test, at -12 dB points	N/A	N/A

The more detailed test must be pass at both the -6 and -12 dB points if the Simple Compliance test fails.

Comment: This test is not required since the tested EUT uses the same receiver for monitoring and communication, but the test has been performed anyway.

Limits, FCC 15.323(c)(7):

The monitoring system bandwidth must be equal to or greater than the emission bandwidth of the intended transmission.

4.18 Reaction Time and Monitoring Interval

Measurement Procedure

ANSI C63.17, clause 7.5

Test results:

By administrative commands and out-of-operating region interference, the EUT is restricted to operate on a single carrier frequency. Time-synchronized pulsed interference is than applied on the the carrier at pulsed level $T_U+6\text{dB}$ or $T_L+6\text{dB}$, as appropriate.

The pulses are synchronized with the EUT timeslots and applied centered within all timeslots.

Pulse Width, ref. to ANSI C63.17 clause 7.5	Observation	Verdict
c) > largest of 50 μs and $50 \cdot \text{SQRT}(1.25/B)$	No Connection established	Pass
d) > largest of 35 μs and $35 \cdot \text{SQRT}(1.25/B)$, and with interference level raised 6 dB	No Connection established	Pass

Comment: The test was performed with pulse lengths of 50 μs and 35 μs .
 The rise and fall times from 10% to 90 % (-0.5 to -10 dB) of the final amplitude is less than 1 μs , see plots.

Limits, FCC 15.323(c)(1), (5) and (7)

The maximum reaction time must be less than $50 \cdot \text{SQRT}(1.25/\text{emission bandwidth in MHz})$ microseconds for signals at the applicable threshold level but shall not be required to be less than 50 microseconds.

If a signal is detected that is 6 dB or more above the applicable threshold level, the maximum reaction time shall be $35 \cdot \text{SQRT}(1.25/\text{emission bandwidth in MHz})$ microseconds but shall not be required to be less than 35 microseconds.

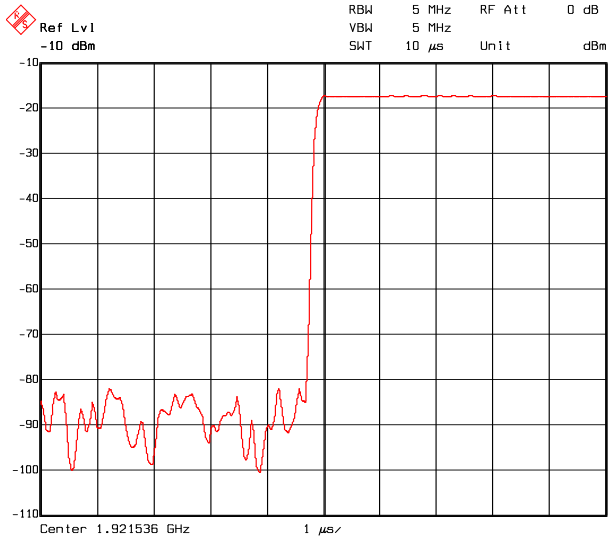

Date: 14.MAR.2006 10:07:50

50 µs pulse, Rise Time

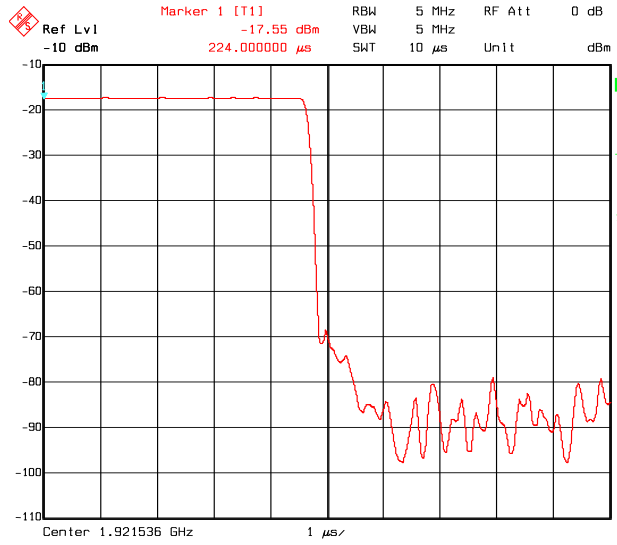

Date: 14.MAR.2006 10:09:06

50 µs pulse, Fall Time

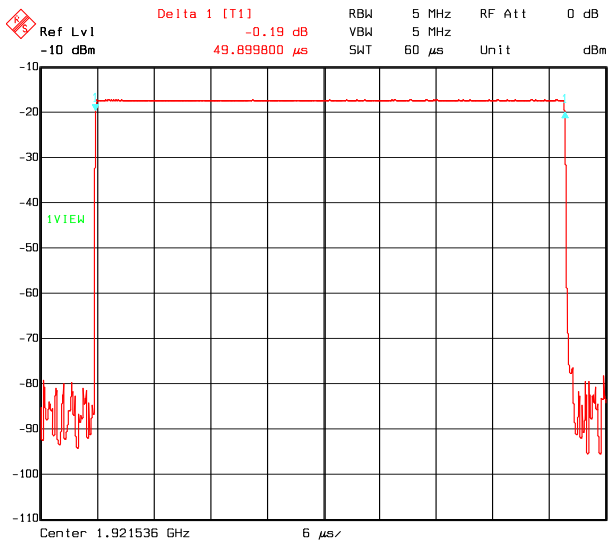

Date: 14.MAR.2006 10:14:25

50 µs pulse

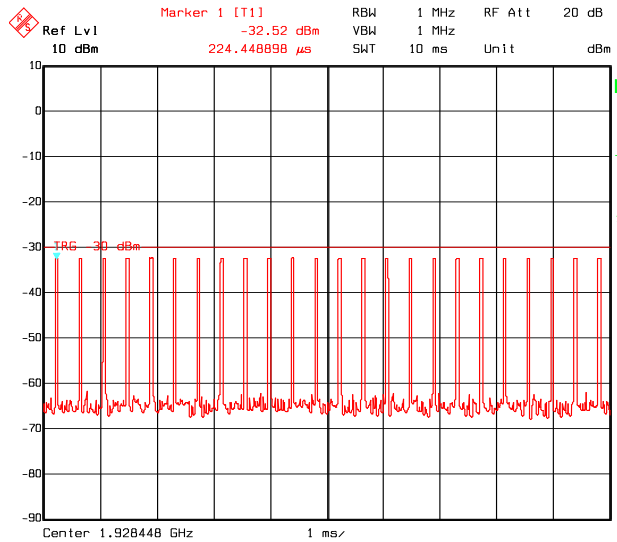

Date: 24.FEB.2006 14:11:18

50 µs pulses synced to DECT frame

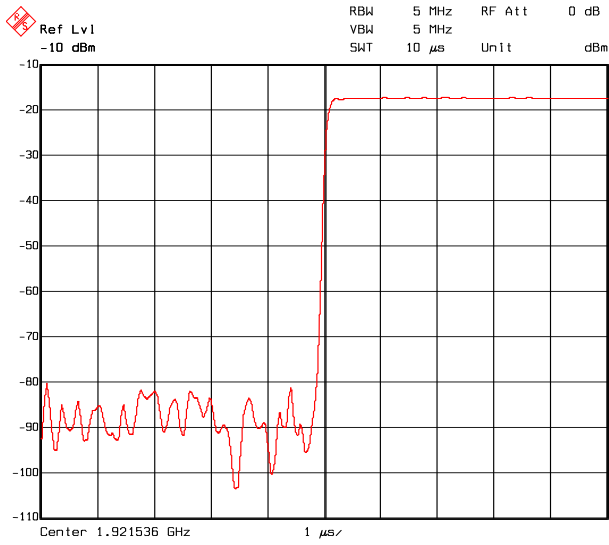

Date: 14.MAR.2006 10:02:05

35 µs pulse, Rise Time

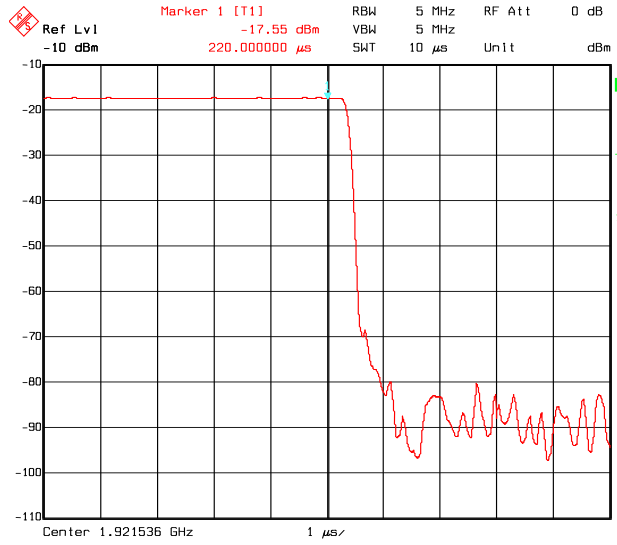

Date: 14.MAR.2006 10:03:43

35 µs pulse, Fall Time

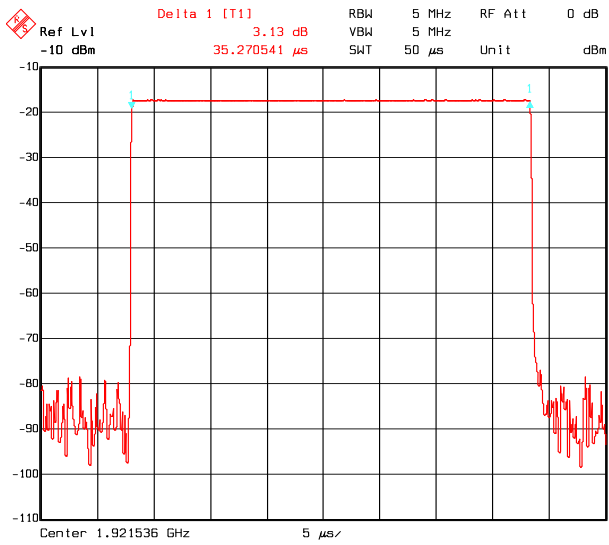

Date: 14.MAR.2006 10:12:38

35 µs pulse

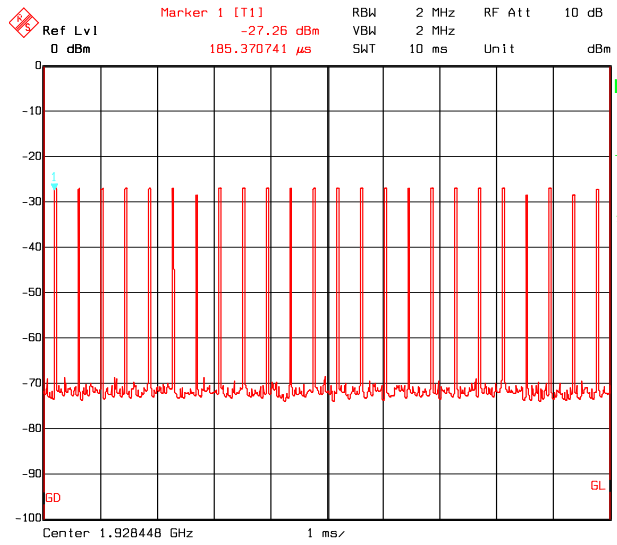

Date: 15.FEB.2006 14:06:53

35 µs pulses synced to DECT frame

4.19 Time and Spectrum Window Access Procedure

This requirement is only for EUTs which transmit unacknowledged control and signalling information.

Measurement Procedure:

Timing for EUTs using control and signaling channel type transmissions: ANSI C63.17, clause 8.1

Test results:

Access Criteria, ref. to ANSI C63.17 clause 8.1.1	Observation	Verdict
b) Check that the EUT transmits on the interference free time-slot	EUT always transmits on the interference free time-slot	Pass
b) The Access Criteria must be repeated at least every 30s.	Access criteria repeated every 1.3 sec. See plots.	Pass

If FCC 15.323(c)(6) option, **Random Waiting Interval NOT implemented**

Access Criteria, ref. to ANSI C63.17 clause 8.1.2	Observation	Verdict
b) Check that the EUT changes to an interference-free slot when interference is introduced on the time slot in use	EUT changes to the interference-free time-slot, and stays there	Pass

If FCC 15.323(c)(6) option, **Random Waiting Interval implemented**

Access Criteria, ref. to ANSI C63.17 clause 8.1.3	Observation	Verdict
b-d) Check that the EUT uses random waiting interval before continuing transmission on an interfered time slot	N/A	N/A

Comment: The tested EUT does not support the Random Waiting Interval option.

Limits:

FCC 15.323(c)(4):

Once access to specific combined time and spectrum windows is obtained an acknowledgement from a system participant must be received by the initiating transmitter within one second or transmission must cease. Periodic acknowledgements must be received at least every 30 seconds or transmission must cease. Channels used exclusively for control and signalling information may transmit continuously for 30 seconds without receiving an acknowledgement, at which time the access criteria must be repeated.

FCC 15.323(c)(6):

If the selected combined time and spectrum windows are unavailable, the device may either monitor and select different windows or seek to use the same windows after waiting an amount of time, randomly chosen from a uniform random distribution between 10 and 150 milliseconds, commencing when the channel becomes available

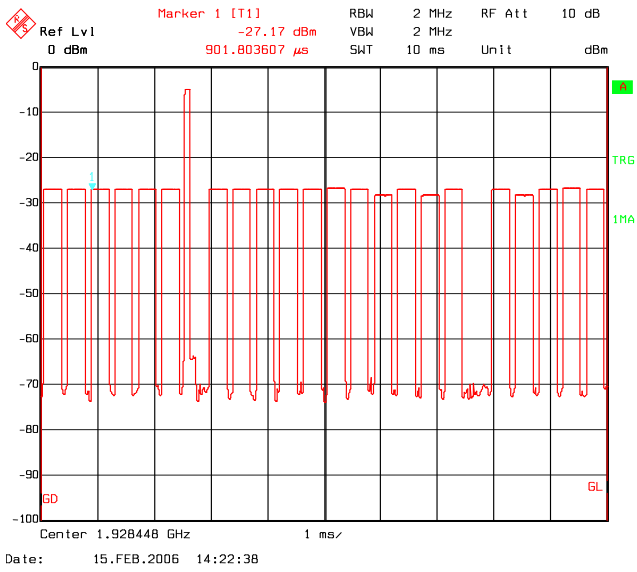

8.1.1 b) Transmission on the unblocked timeslot

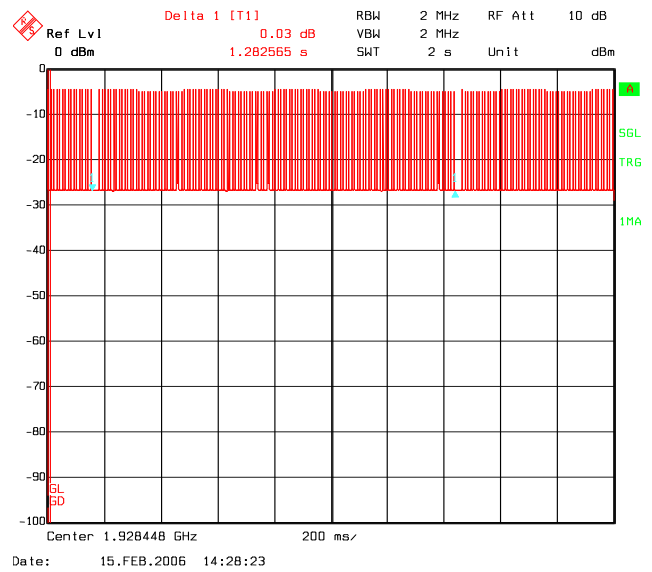
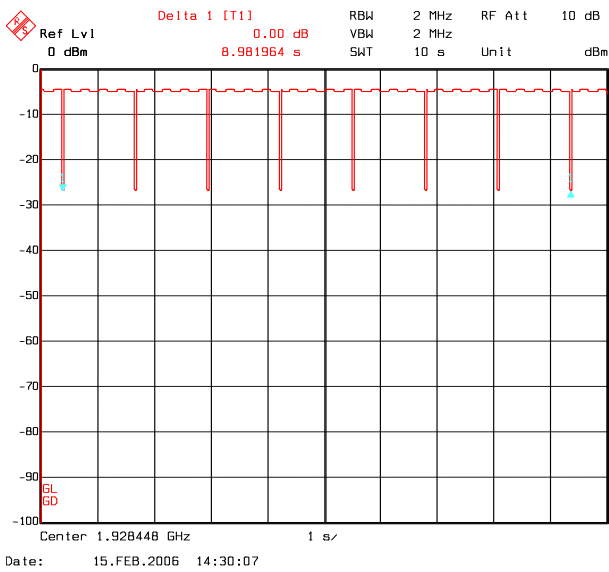

8.1.1 b) Access Criteria Interval

4.20 Acknowledgements and Transmission Duration

Measurement Procedure:

Acknowledgements: ANSI C63.17, clause 8.2.1

Transmission Duration: ANSI C63.17, clause 8.2.2

Test Results:

Acknowledgements

Test ref. to ANSI C63.17 clause 8.2.1	Observation	Verdict
a) Initial transmission without acknowledgements	The tested EUT is not the initiating device and can not start transmissions on the communications channel.	N/A
c) transmission time without acknowledgements	5.0 sec	Pass

Transmission Duration

Test ref. to ANSI C63.17 clause 8.2.2	Observation	Verdict
b) Transmission duration on same time and frequency window	The tested EUT is not the initiating device.	N/A

Comment: The test of **transmission time without acknowledgements** was performed by removing the signal from the companion device with an RF switch. Then it was observed on a spectrum analyzer how long it took before the EUT released the bearer.

Limits, FCC 15.323(c)(3) and (4)

Occupation of the same combined time and spectrum windows by a device or group of cooperating devices continuously over a period of time longer than 8 hours is not permitted without repeating the access criteria.

Once access to specific combined time and spectrum windows is obtained an acknowledgement from a system participant must be received by the initiating transmitter within one second or transmission must cease.

Periodic acknowledgements must be received at least every 30 seconds or transmission must cease.

Channels used exclusively for control and signalling information may transmit continuously for 30 seconds without receiving an acknowledgement, at which time the access criteria must be repeated.

4.21 Dual Access Criteria Check

Measurement Procedure:

EUTs that does not implement the Upper Threshold: ANSI C63.17, clause 8.3.1

EUTs that implement the Upper Threshold: ANSI C63.17, clause 8.3.2

This test is required for equipment that uses the access criteria in FCC 15.323(c)(10).

Test Results:

EUTs that Implements the Upper Threshold:

Test ref. to ANSI C63.17 clause 8.3.2	Observation	Verdict
b) EUT is restricted to a single carrier f_i for TDMA systems	N/A	N/A
c) d) Transmission on interference-free receive time/spectrum window	N/A	N/A
e) f) Transmission on interference-free transmit time/spectrum window	N/A	N/A
g) Transmission not possible on any time/spectrum window	N/A	N/A

Comment: The tested EUT is **not** an initiating device. Since the channel selection is decided by the initiating device and not the responding device this test has not been performed on this EUT.

Limits, FCC 15.323(c)(10)

An initiating device may attempt to establish a duplex connection by monitoring both its intended transmit and receive time and spectrum windows. If both the intended transmit and receive time and spectrum windows meet the access criteria, then the initiating device can initiate a transmission in the intended transmit time and spectrum window. If the power detected by the responding device can be decoded as a duplex connection signal from the initiating device, then the responding device may immediately begin transmitting on the receive time and spectrum window monitored by the initiating device.

4.22 Alternative Monitoring Interval

Test procedure described in ANSI C63.17 clause 8.4.

This test is required if the EUT implements the provisions of FCC 15.323(c)(11).

Test result:

Not tested, the tested EUT is not initiating device.

4.23 Duty Cycle Correction Factor Calculation

The tested EUT is a DECT base station that can transmit on up to six single timeslots per 10ms DECT system frame.

Frame length: 9.92ms
 Slot length: 0.379ms

Calculation of DC Correction Factor:

$$-20 \log (6 \times \text{slot length} / \text{Frame length}) = -20 \log (6 \times 0.395/10) = 12.4 \text{ dB}$$

Duty Cycle Correction Factor : 12.4 dB

The Duty Cycle Correction Factor is used to calculate the Peak Limit for Spurious Emissions above 1 GHz. The Peak Limit is equal to the Average Limit (54 dBµV/m) plus the DC Correction Factor.

Slot Length:

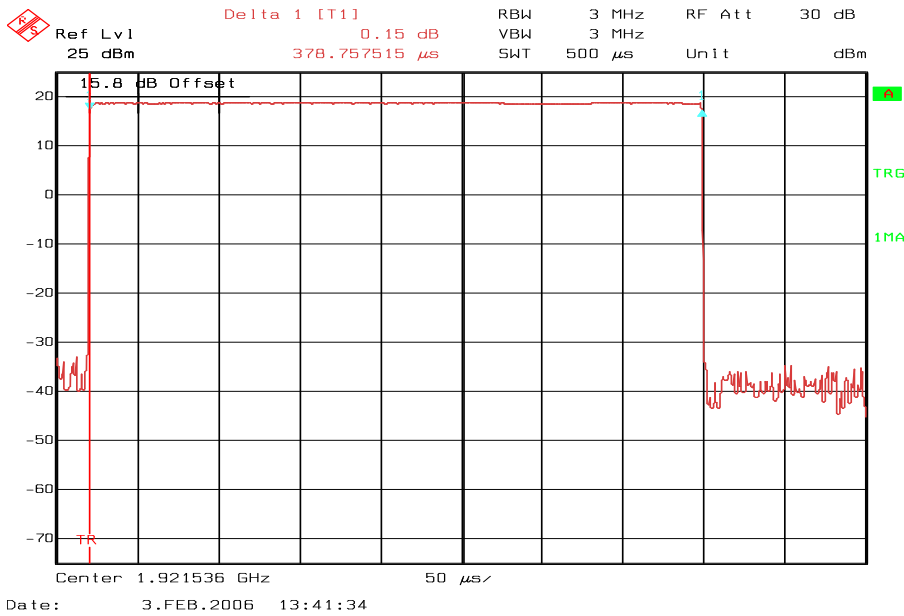

Frame Length:

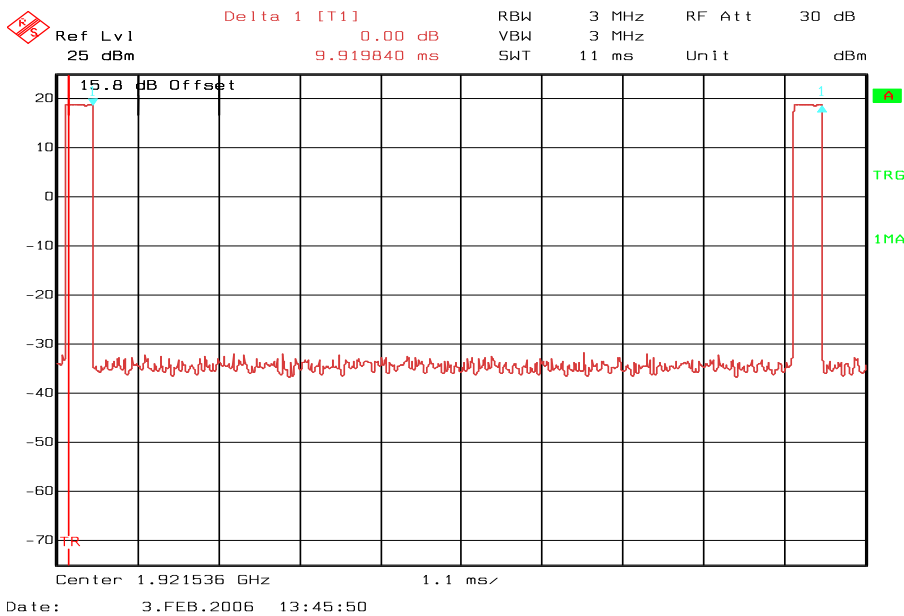

4.24 Spurious Emissions (Radiated)

Measurement Procedure:

FCC 15.209

Test Results:

Radiated emission 10 kHz-30 MHz.

Measuring distance 10 m, measured with Peak detector.

See attached graph.

Transmitter active, all connections populated and operating

Limit is converted to 10 m using 40 dB/decade according to 15.31 (f) (2).

Frequency	RF channel	Dist. corr. factor	Detector	Field strength, 10 meters	Limit	Margin
MHz	/	dB	QP/AV	dB μ V/m	dB μ V/m	dB
/	/	/	AV	/	/	/

No spurious emissions were detected in this frequency range.

Radiated Emissions 30 - 1000 MHz.

Detector: Quasi-Peak

Measuring distance 3 m.

Transmitter active, all connections populated and operating

Frequency	Polarization	Dist. corr. factor	Field strength, 3 meters	Detector	Limit	Margin
MHz	V/H	dB	dB μ V/m	QP	dB μ V/m	dB
145.10	H	0	43.5	QP	43.5	0.0
145.30	V	0	39.3	QP	43.5	4.2
154.65	H	0	41.5	QP	43.5	2.0
253.45	V	0	27.6	QP	46.0	18.4
266.65	H	0	39.0	QP	46.0	7.0
533.35	H	0	29.7	QP	46.0	16.3
533.35	V	0	40.8	QP	46.0	5.2
674.50	H	0	27.7	QP	46.0	18.3
676.10	V	0	27.8	QP	46.0	18.2
800.00	H	0	42.5	QP	46.0	3.5
909.35	V	0	25.8	QP	46.0	20.2

The measured emissions below 1 GHz comes from the cable modem chip. The exact frequency and level varies a little but the reported value is the highest measured value.

Radiated Emissions 1 - 18 GHz

Detector: Peak

Measuring distance 3 m. Measured in 3 axis.

Transmitter active, all connections populated and operating

No Spurious emissions were detected.

Radiated Emissions 18 - 20 GHz

Detector: Peak

Measuring distance 1 m. Measured in 3 axis.

Transmitter active, all connections populated and operating

No Spurious emissions were detected.

NEMKO COMLAB
 PK

07. Apr 06 12:47

Operator: FS
 Comment: RTX Sabrina
 FCC 15.209, 10m

Scan Settings (4 Ranges)

Frequencies			Receiver Settings					
Start	Stop	Step	IF BW	Detector	M-Time	Atten	Preamp	OpRge
10k	100k	1k	1k	PK	20ms	0dB	LN OFF	60dB
20k	20k	5k	9k	PK	20ms	AUTO	LN ON	60dB
20k	10M	5k	9k	PK	20ms	AUTO	LN OFF	60dB
10M	30M	5k	9k	PK	20ms	AUTO	LN OFF	60dB

Transducer No.	Start	Stop	Name
13	10k	30M	HFH222

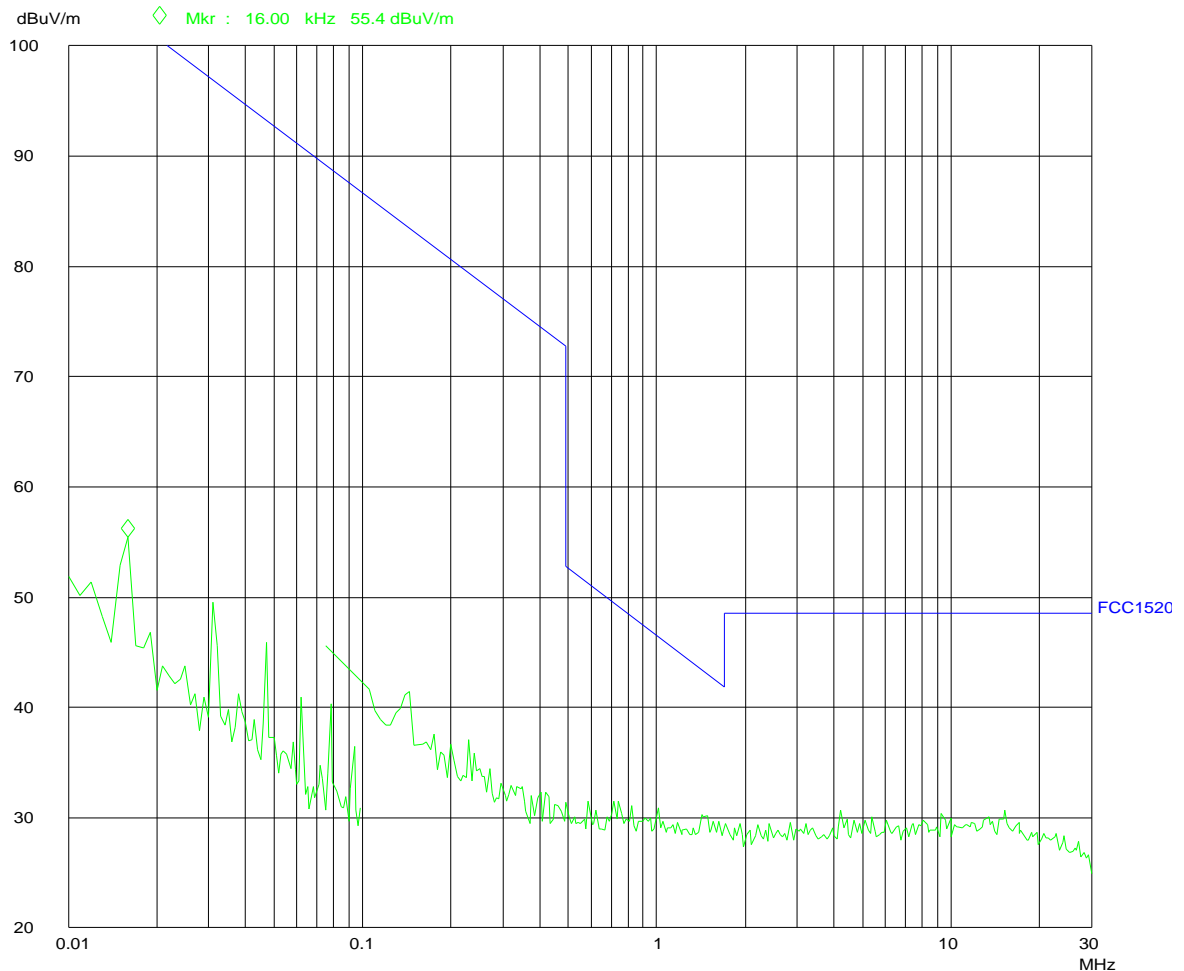

Radiated Emissions, 0.010 - 30 MHz

Nemko Comlab
Peak

07. Apr 06 10:07

EUT: Sabrina US-DECT
 Manuf: RTX Telecom
 Op Cond: 1m VP
 Operator: FS
 Test Spec: FCC 15.209, @3m

Scan Settings (1 Range)

Frequencies			Receiver Settings					
Start	Stop	Step	IF BW	Detector	M-Time	Atten	Preamp	OpRge
30M	200M	50k	120k	PK	50ms	AUTO	LN ON	60dB

Transducer No.	Start	Stop	Name
20	30M	200M	HK116

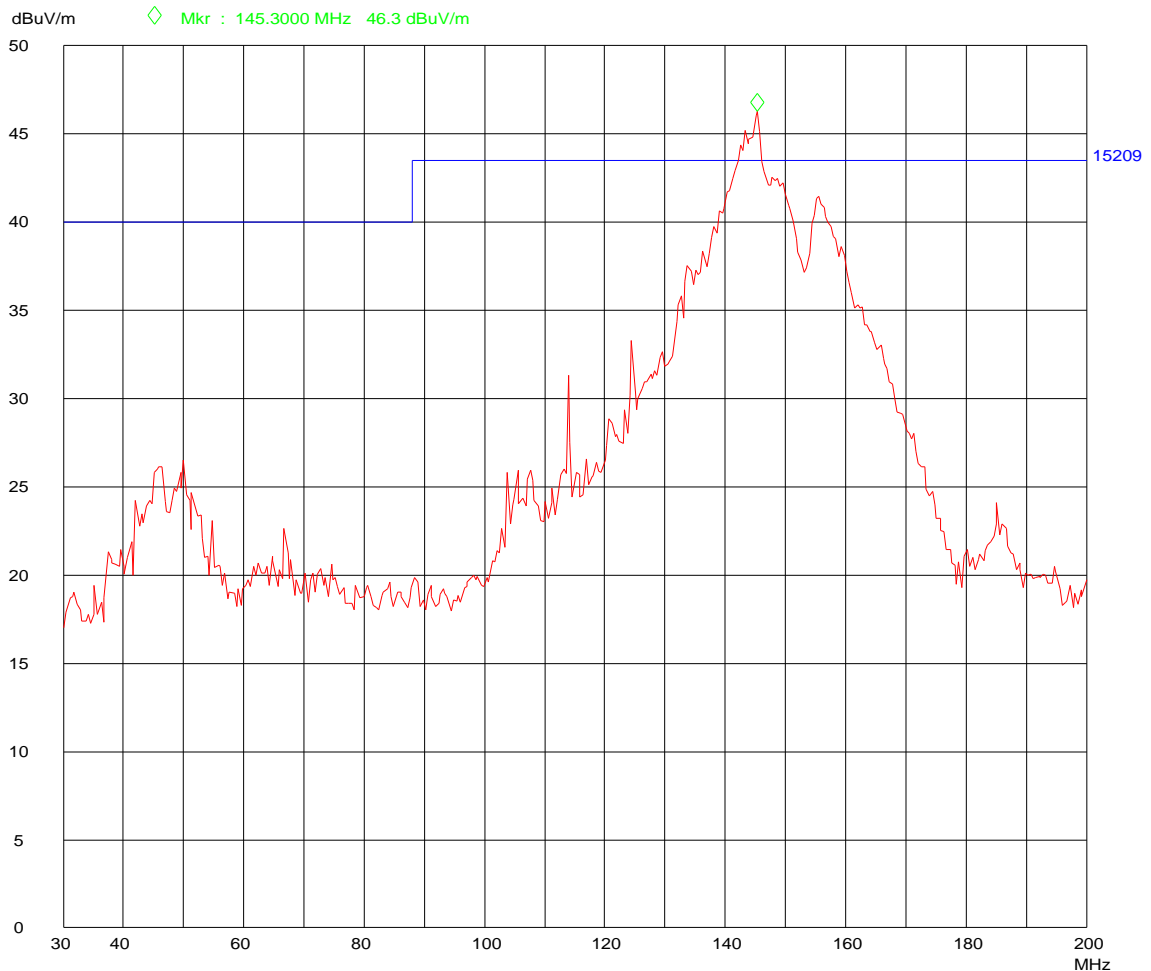

Radiated Emissions, 30 – 200 MHz Vertical Polarization

Nemko Comlab
Peak

07. Apr 06 10:15

EUT: Sabrina US-DECT
 Manuf: RTX Telecom
 Op Cond: 1m HP
 Operator: FS
 Test Spec: FCC 15.209, @3m

Scan Settings (1 Range)

Frequencies			Receiver Settings					
Start	Stop	Step	IF BW	Detector	M-Time	Atten	Preamp	OpRge
30M	200M	50k	120k	PK	50ms	AUTO	LN ON	60dB

Transducer No.	Start	Stop	Name
20	30M	200M	HK116

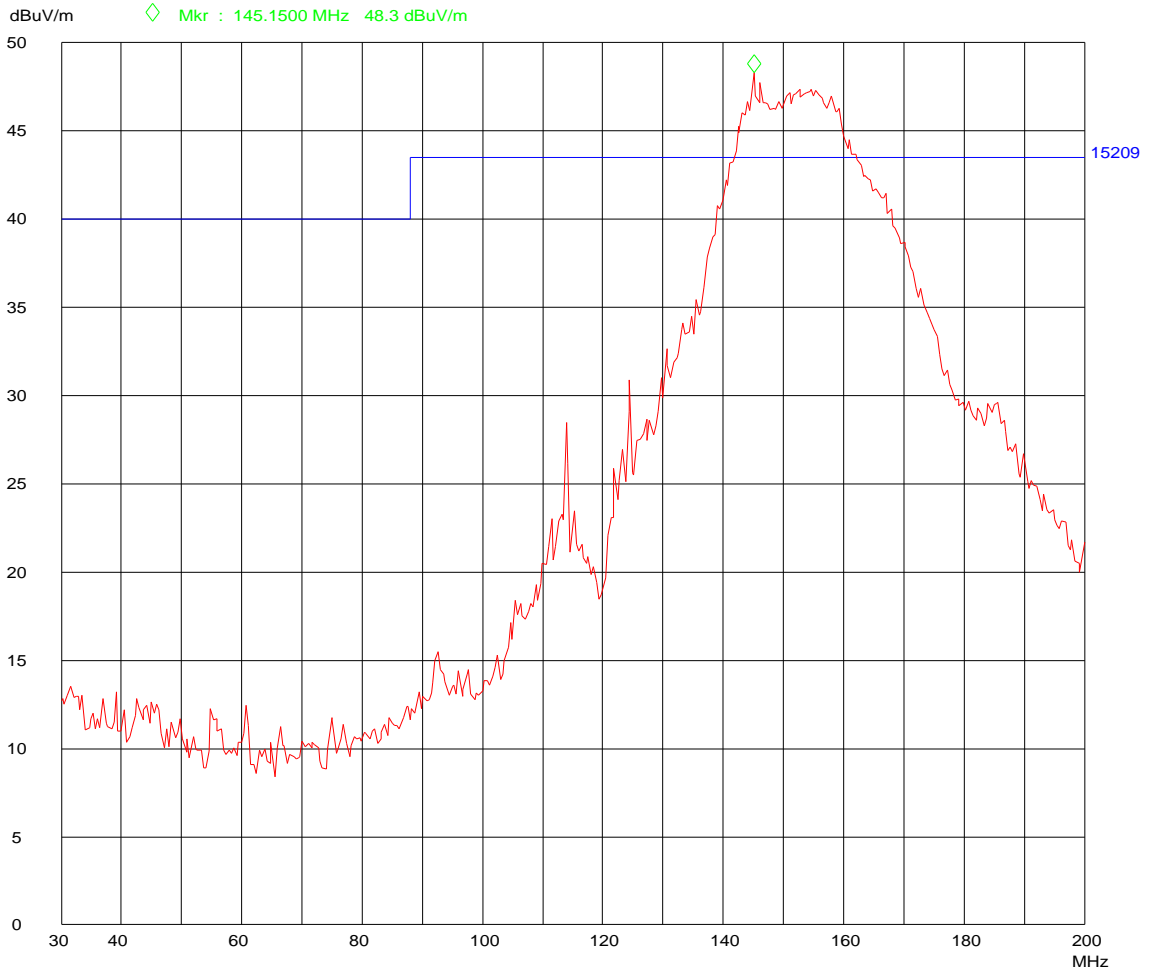

Radiated Emissions, 30 – 200 MHz Horizontal Polarization

Nemko Comlab
Peak

07. Apr 06 08:50

EUT: Sabrina US-DECT
 Manuf: RTX Telecom
 Op Cond: 1m VP
 Operator: FS
 Test Spec: FCC 15.209, @3m

Scan Settings (1 Range)

Frequencies				Receiver Settings			
Start	Stop	Step	IF BW	Detector	M-Time	Atten	Preamp OpRge
200M	1000M	50k	120k	PK	50ms	AUTO LN	ON 60dB

Transducer No.	Start	Stop	Name
21	200M	1000M	HL223

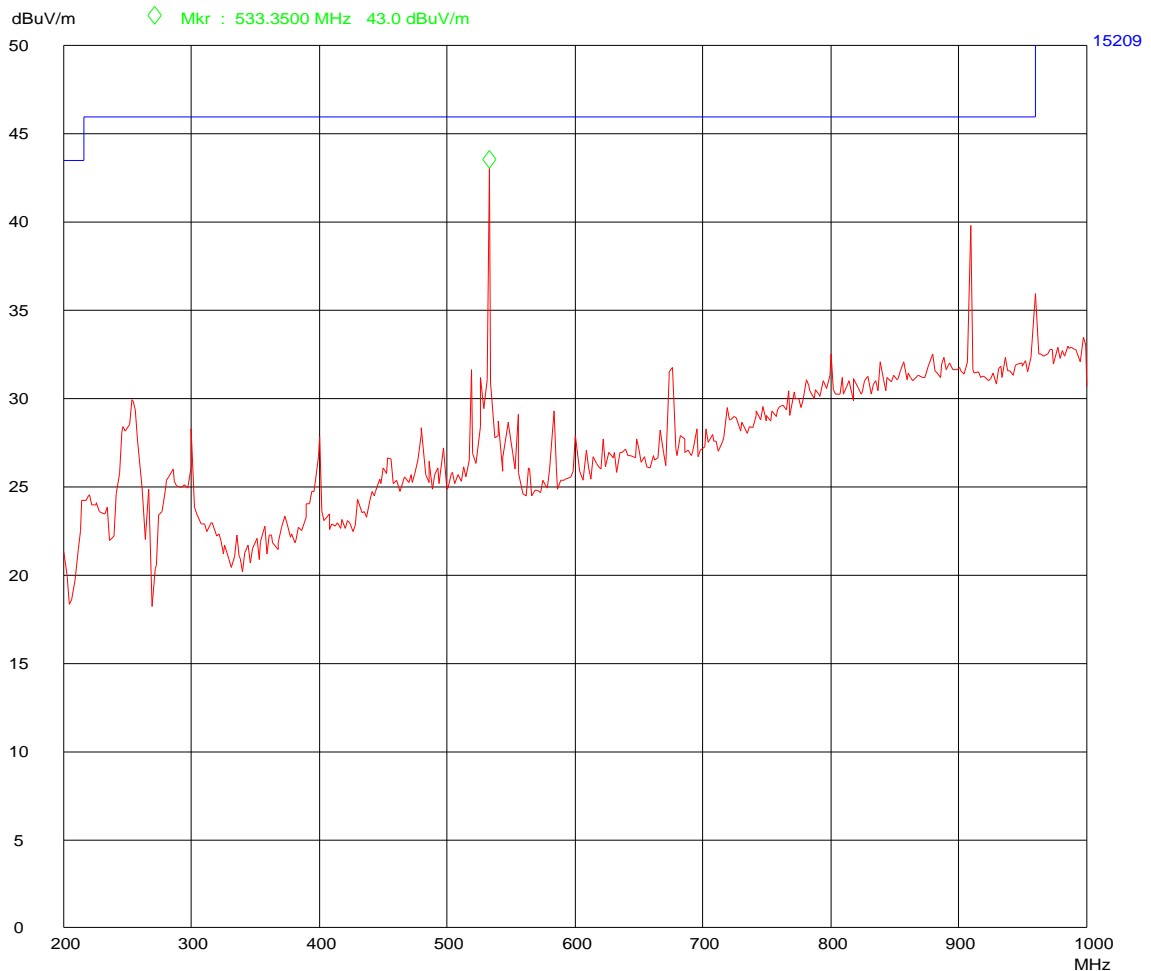

Radiated Emissions, 200 – 1000 MHz Vertical Polarization

Nemko Comlab
Peak

07. Apr 06 09:16

EUT: Sabrina US-DECT
 Manuf: RTX Telecom
 Op Cond: 1m HP
 Operator: FS
 Test Spec: FCC 15.209, @3m

Scan Settings (1 Range)

Frequencies			Receiver Settings					
Start	Stop	Step	IF BW	Detector	M-Time	Atten	Preamp	OpRge
200M	1000M	50k	120k	PK	50ms	AUTO	LN ON	60dB

Transducer No.	Start	Stop	Name
21	200M	1000M	HL223

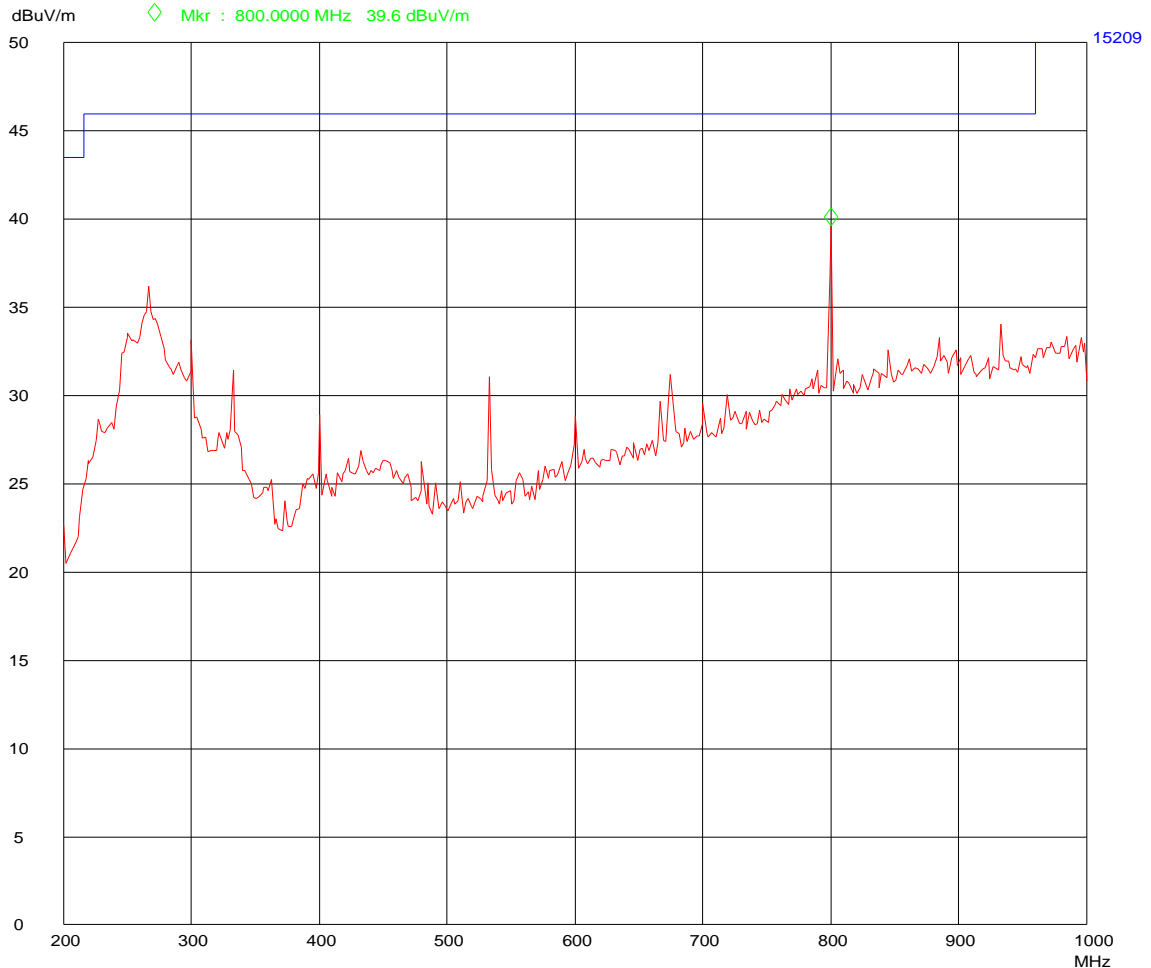

Radiated Emissions, 200 – 1000 MHz Horizontal Polarization

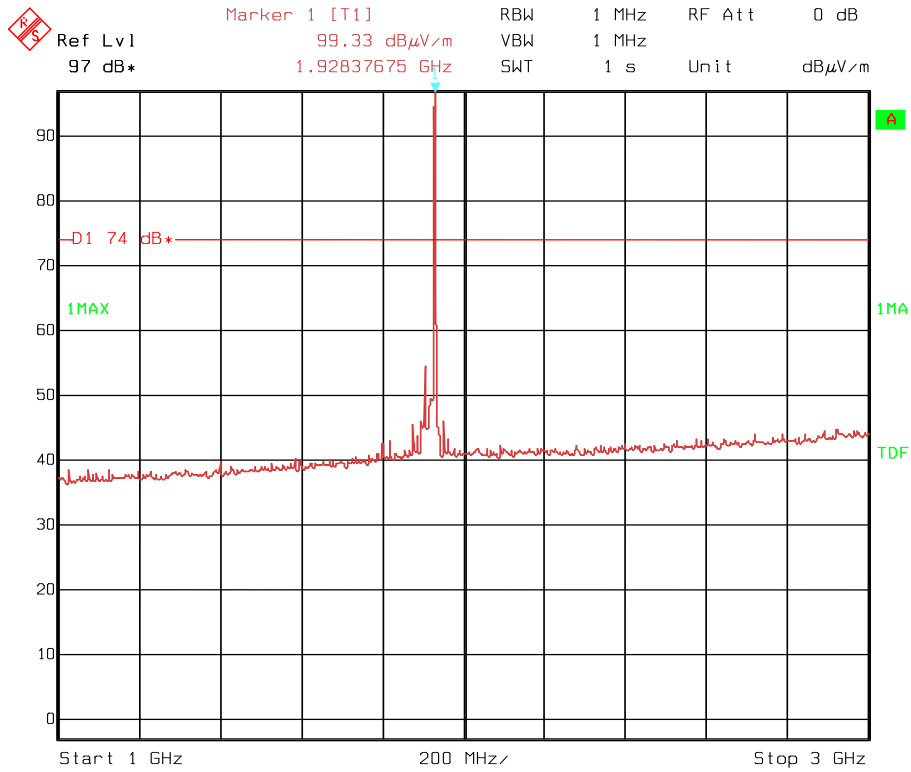

Date: 1.FEB.2006 15:24:30

Spurious Emissions 1-3 GHz, ch 0, Ant 0, V Pol , Level 10 dempet

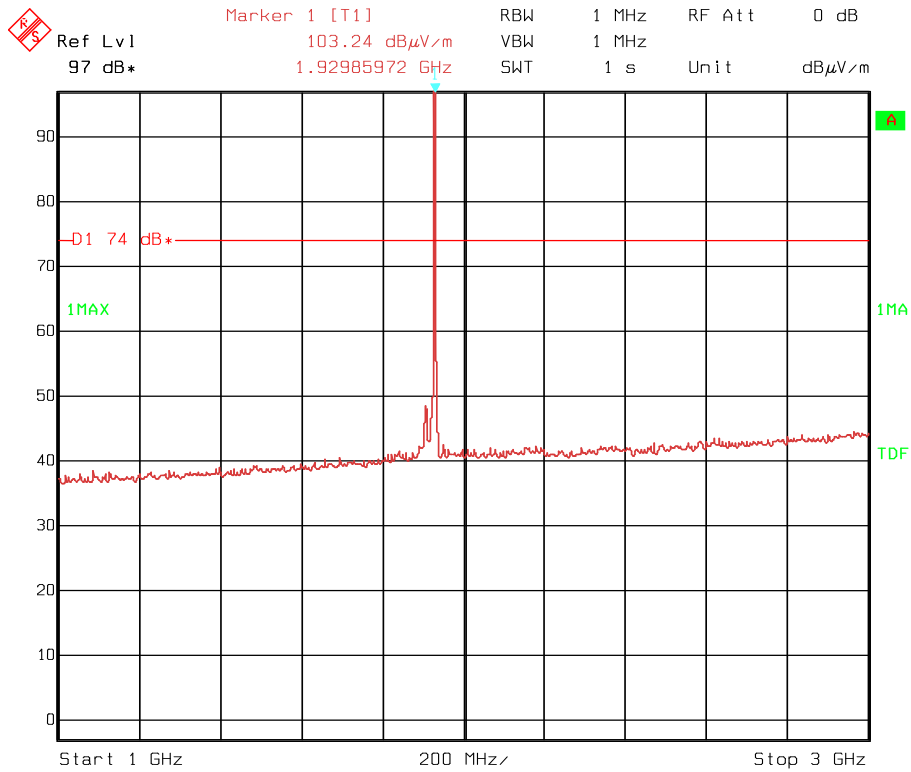

Date: 1.FEB.2006 15:30:38

Spurious Emissions 1-3 GHz, ch 0, Ant 0 H Pol, Level 10 dempet

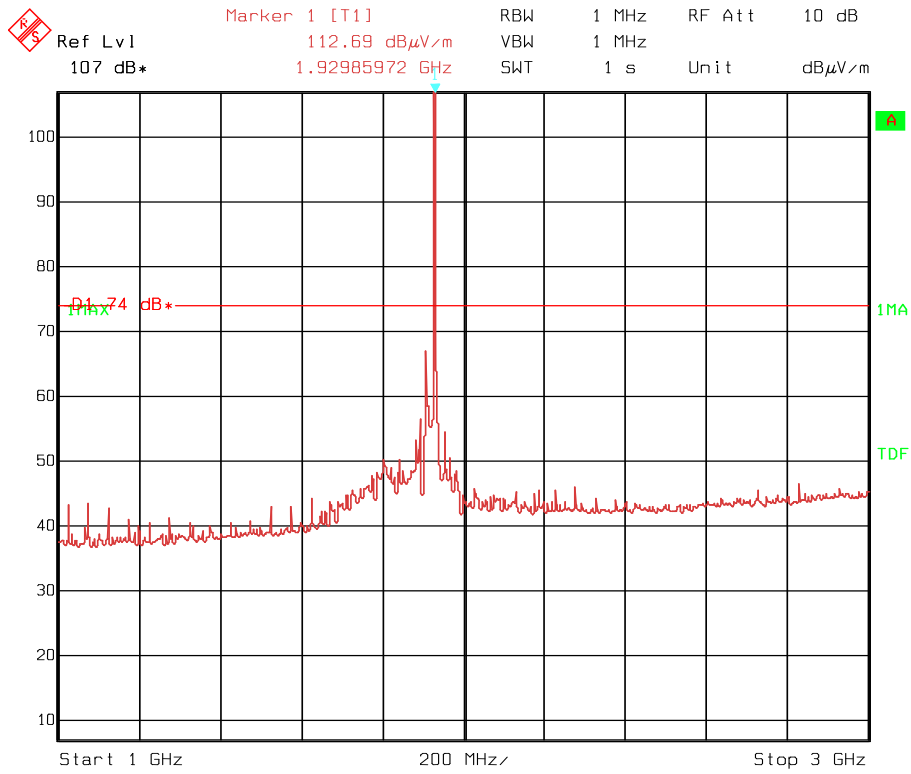

Date: 1.FEB.2006 15:42:07

Spurious Emissions 1-3 GHz, ch 0, Ant 1 V Pol,

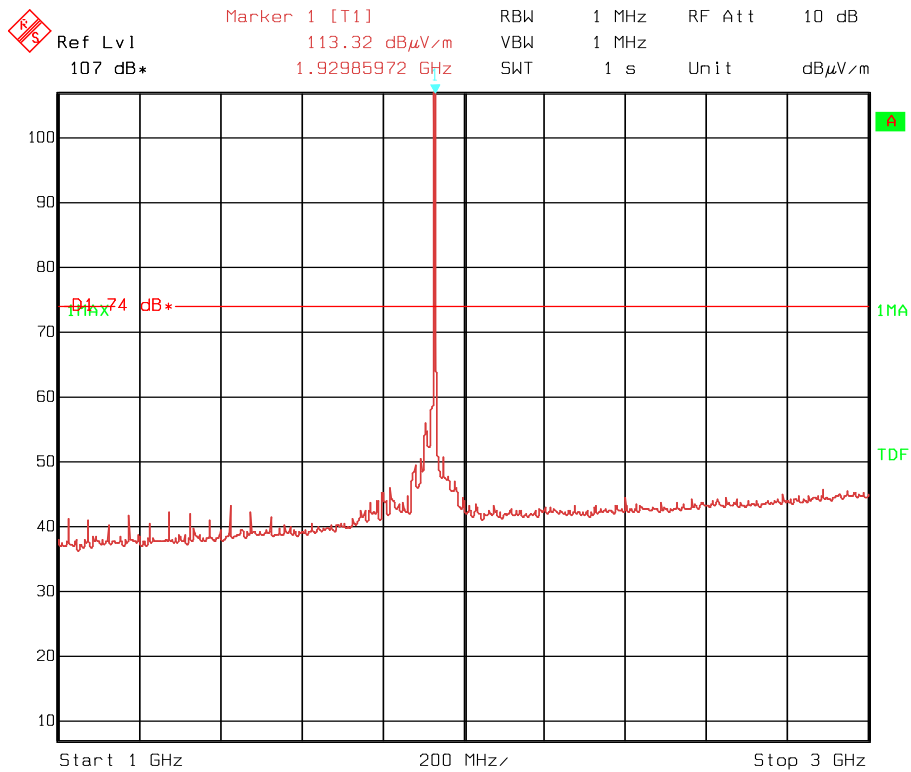

Date: 1.FEB.2006 15:44:36

Spurious Emissions 1-3 GHz, ch 0, Ant 1 H Pol,

	Ref Lvl	Marker 1 [T1]	RBW	1 MHz	RF Att	0 dB
	97 dB*	55.72 dB μ V/m	VBW	1 MHz		
		8.27955912 GHz	SWT	1 s	Unit	dB μ V/m

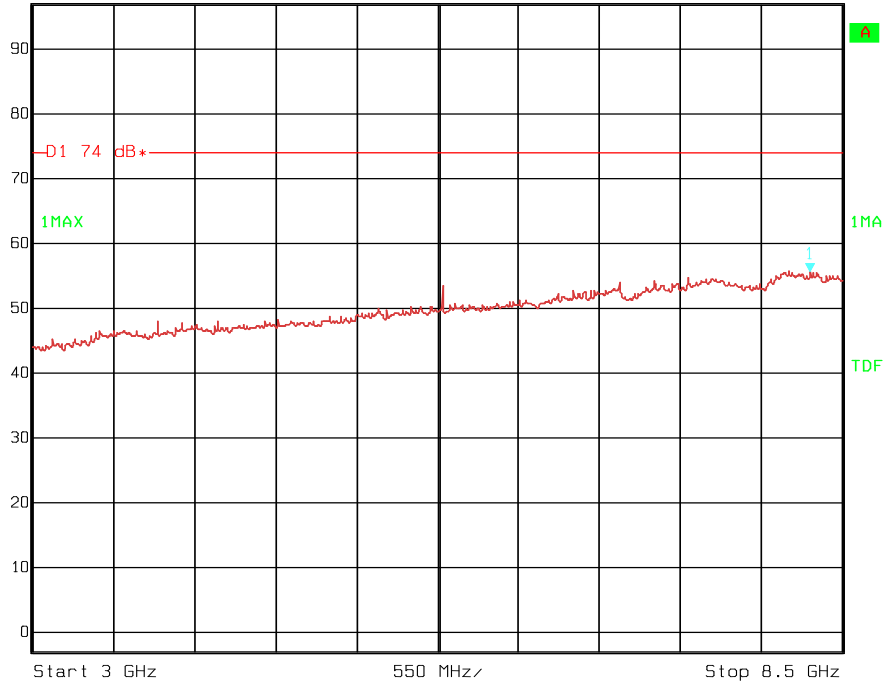

Date: 1.FEB.2006 15:49:24

Spurious Emissions 3-8.5 GHz, ch 0, Ant 1 H Pol,

	Ref Lvl	Marker 1 [T1]	RBW	1 MHz	RF Att	0 dB
	97 dB*	55.42 dB μ V/m	VBW	1 MHz		
		8.08116232 GHz	SWT	1 s	Unit	dB μ V/m

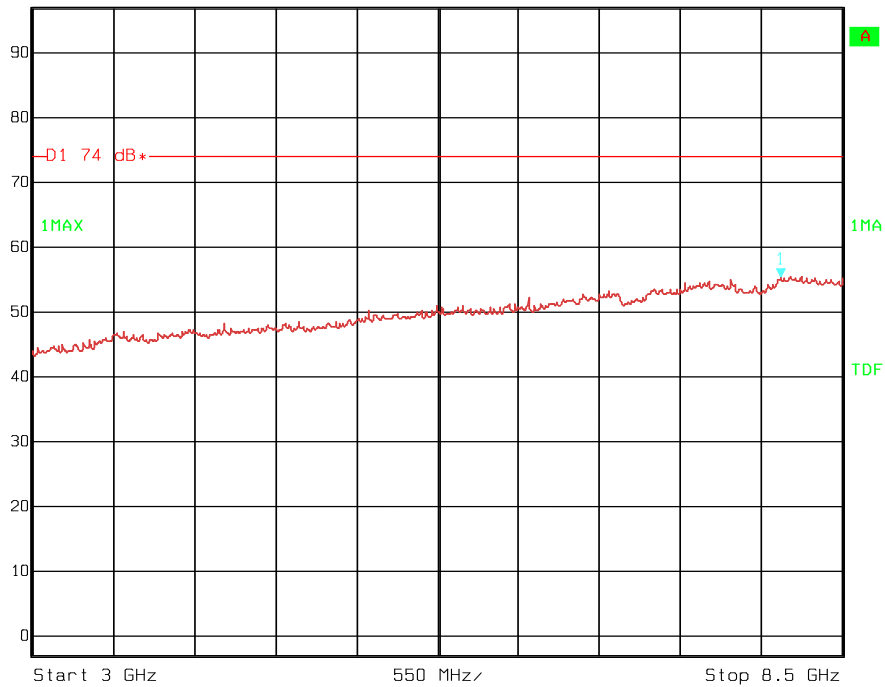

Date: 1.FEB.2006 15:53:27

Spurious Emissions 3-8.5 GHz, ch 0, Ant 1 V Pol,

	Ref Lvl	Marker 1 [T1]	RBW	1 MHz	RF Att	0 dB
	97 dB*	56.86 dB μ V/m	VBW	1 MHz		
		11.64929860 GHz	SWT	20 ms	Unit	dB μ V/m

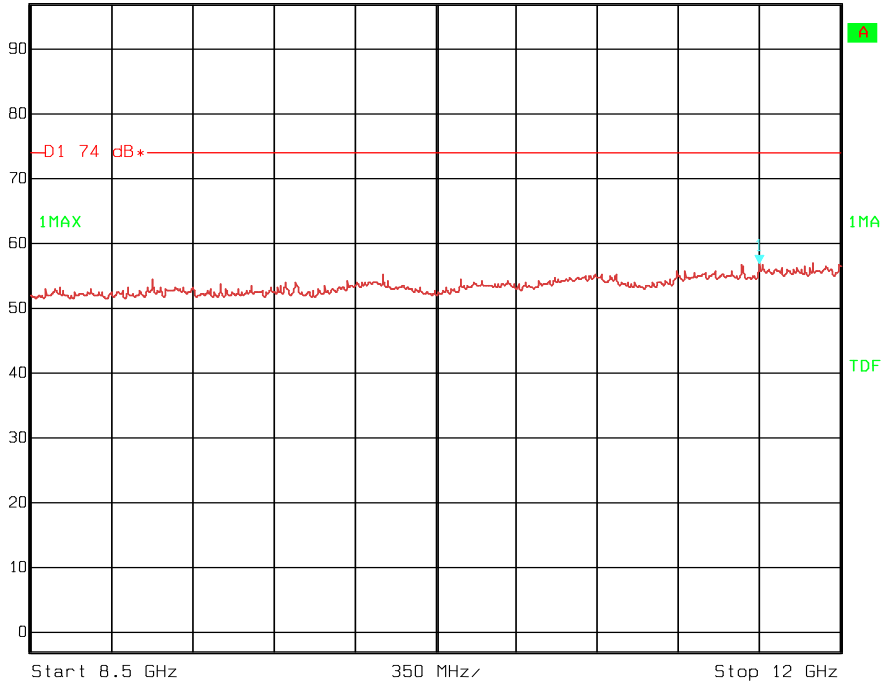

Date: 1.FEB.2006 16:14:41

Spurious Emissions 8.5-12 GHz, ch 0, Ant 0 H Pol,

	Ref Lvl	Marker 1 [T1]	RBW	1 MHz	RF Att	0 dB
	97 dB*	56.50 dB μ V/m	VBW	1 MHz		
		9.63627255 GHz	SWT	20 ms	Unit	dB μ V/m

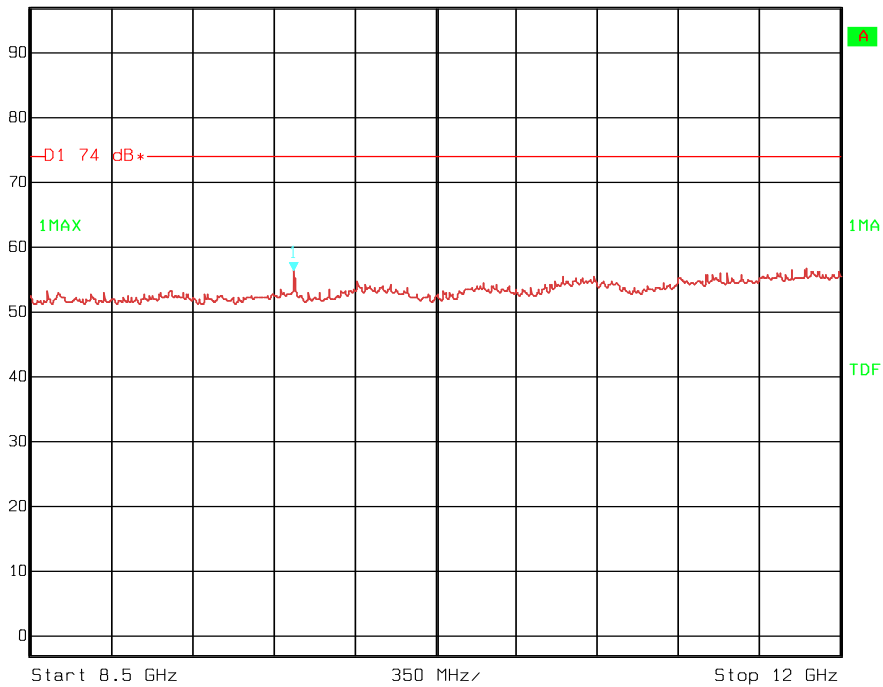

Date: 1.FEB.2006 16:17:02

Spurious Emissions 8.5-12 GHz, ch 0, Ant 0 V Pol,

4.25 Receiver Spurious Emissions

Measurement Procedure:

Industry Canada RSS-213 paragraph 6.8 and RSS-GEN paragraphs 4.8 and 6.

Test results:

The Receiver Spurious Emissions were tested with the EUT in receive mode with the transmitter off. No Receiver Spurious Emissions were detected during the radiated test.

5 Test Setups

5.1 Frequency Measurements



Test equipment included: 5

Test Set-up 1

This setup is used for measuring Carrier frequency stability at normal and extreme temperatures.

5.2 Timing Measurements

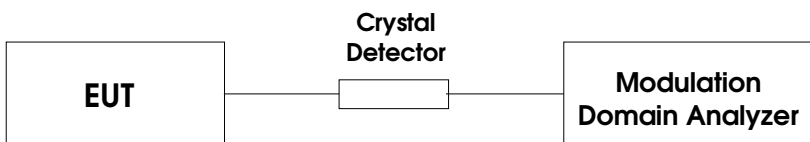

Test equipment included: 5, 7

Test Set-up 2

This setup is used for measuring Frame repetition stability, Frame period and Jitter.

5.3 Conducted Emission Tests

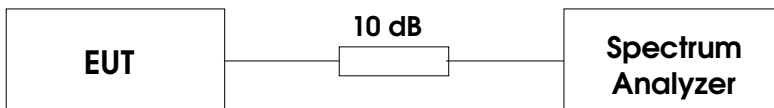

Test equipment included: 1, 13

Test Set-up 3

This setup is used for all conducted emission tests.

5.4 Radiated Emission Tests

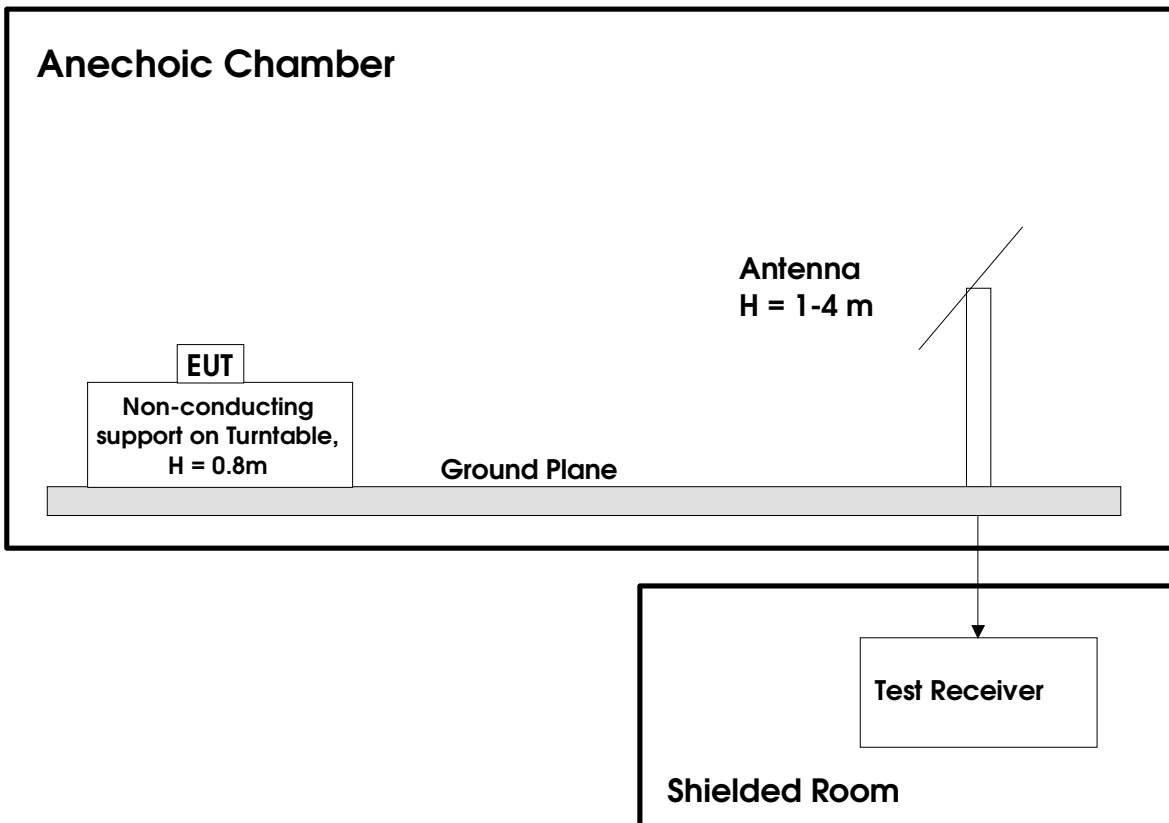

Test equipment: 1, 8, 9, 10, 11, 20, 21, 22, 23, 24, 25, 26

Test Set-Up 4

This test setup is used for all radiated emissions tests. For frequencies below 30 MHz the measuring distance is 10m, for all other frequencies it is 3m or 1m. Emissions above 1 GHz were measured with a Spectrum Analyzer and Horn Antenna with the preamplifier after the antenna.

5.5 Powerline Conducted Tests

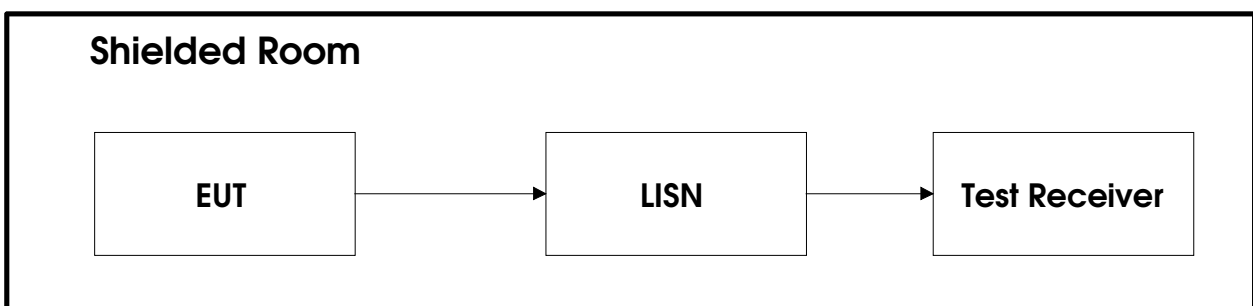

Test equipment: 12, 27, 28

Test Set-Up 5

5.6 Monitoring Tests

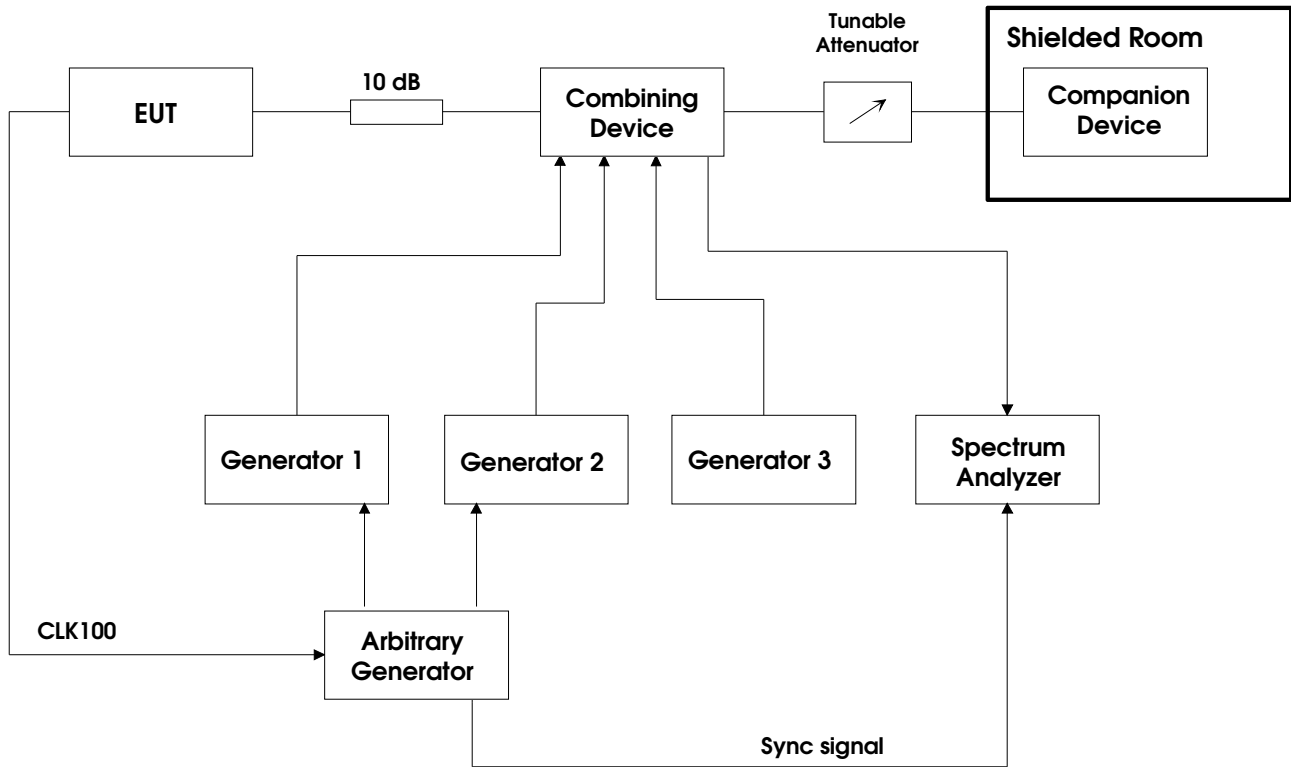

Test equipment: 1, 2, 3, 4, 6, 13, 14, 15, 16, 17, 18, 19

Test Set-Up 6

This test setup is used for all Monitoring and Time and Spectrum Access Procedure tests.

6 Test Equipment Used

To facilitate inclusion on each page of the test equipment used for related tests, each item of test equipment and ancillaries are identified (numbered) by the Test Laboratory.

No.	Instrument/ancillary	Type of instrument/ancillary	Manufacturer	Ref. no.
1	FSEK30	Spectrum Analyzer	Rohde & Schwarz	LR 1337
2	SME03	Signal generator	Rohde & Schwarz	LR 1238
3	SMP04	Signal generator	Rohde & Schwarz	LR 1336
4	SMHU52	Signal generator	Rohde & Schwarz	LR 1240
5	53310A	Modulation Domain Analyzer	Hewlett Packard	LR 1483
6	AFG320	Arbitrary Generator	Sony Tektronix	S.No.: J311690
7	8470B	Crystal Detector	Hewlett Packard	LR 1207
8	8449B	Preamplifier	Hewlett Packard	LR 1322
9	4HC3000/18000	Highpass filter	Trilithic	S.No.: 9849045
10	ESVS30	Measuring Receiver	Rohde & Schwarz	LR 1101
11	ESN	Measuring Receiver	Rohde & Schwarz	LR 1237
12	ESAI	Measuring Receiver	Rohde & Schwarz	LR 1090
13	6810.17B	Attenuator	Narda	LR1212
14	745-69	Step Attenuator	Narda	LR 1442
15	WE 1506A	Power Splitter	Weinchel	LR 244
16	WE 1506A	Power Splitter	Weinchel	LR 245
17	H-9	Hybrid	Anzac	LR 86
18	H-9	Hybrid	Anzac	LR 257
19	S212DS	RF Switch	Narda	LR 1244
20	3115	Horn Antenna	EMCO	LR 1226
21	PM7320-X	Horn Antenna	Sivers Lab	LR 102
22	DBF-520-20	Horn Antenna	Systron Donner	LR 100
23	638	Horn Antenna	Narda	LR 1480
24	HL223	Biconical Antenna	Rohde & Schwarz	LR 1261
25	HK116	Logperiod Antenna	Rohde & Schwarz	LR 1260
26	HFH2-Z2	Loop Antenna	Rohde & Schwarz	LR 285
27	ESH3-Z5	Two Line V-Network	Rohde & Schwarz	LR 1076
28	80S	Signal Generator	Powertron	LT 502