

**Vesta Series**  
*Smart Anytime, Safe Anywhere*

**HSGW Series  
IP Alarm System  
User Manual**

---

May-09-2017

# Table of Contents

---

<b>1. INTRODUCTION</b>	<b>1</b>
1.1. SYSTEM SPECIFICATION	2
<b>2. PANEL INFORMATION</b>	<b>4</b>
2.1. IDENTIFYING THE PARTS:	4
2.2. THE POWER SUPPLY:	5
2.3. SYSTEM REQUIREMENTS:	5
<b>3. GETTING STARTED</b>	<b>6</b>
3.1. SYSTEM DEPLOYMENT	6
3.2. INSTALLATION	6
3.3. SOFTWARE INSTALLATION	8
<b>4. CONNECTION TO PANEL WEBPAGE</b>	<b>11</b>
<b>5. DEVICE MANAGEMENT</b>	<b>13</b>
5.1. LEARNING	13
5.2. ADD RF DEVICE	20
5.3. LEARN RULE	21
5.4. WALK TEST	23
5.5. EXCLUSION	24
5.6. Z-WAVE TOOL	25
5.7. PSS CONTROL	26
5.8. UPIC CONTROL	27
5.9. SURVEILLANCE	28
5.10. GROUP CONTROL	29
5.11. SOUND/SIREN SETTING	30
<b>6. PROGRAM THE SYSTEM</b>	<b>34</b>
6.1. PANEL CONDITION	34
6.2. PANEL SETTINGS	37
6.3. PIN CODE	41
<b>7. NETWORK SETTINGS</b>	<b>42</b>
7.1. GSM (HSGW-G8 SERIES ONLY)	42
7.2. NETWORK	45
7.3. WIRELESS	46
7.4. UPNP	47
<b>8. SYSTEM SETTINGS</b>	<b>48</b>

8.1. ADMINISTRATOR SETTING	48
8.2. HOME AUTOMATION	49
8.3. SCENE	54
8.4. REPORTING	56
8.5. CODE SETTINGS	59
8.6. SMTP SETTING	61
8.7. MEDIA UPLOAD	62
8.8. POLLING	63
8.9. XMPP	64
8.10. DATE & TIME	65
8.11. DYNAMIC DNS	66
8.12. TEST IP	67
8.13. FIRMWARE UPGRADE	68
8.14. RF FIRMWARE UPGRADE	69
8.15. FACTORY RESET	70
8.16. BACKUP & RESTORE	72
8.17. SYSTEM LOG	73
<b>9. EVENT &amp; HISTORY</b>	<b>74</b>
9.1. CAPTURED EVENTS	74
9.2. REPORTED EVENTS	75
9.3. EVENT LOG	76
9.4. DEVICE HISTORY	77
<b>10. APPENDIX</b>	<b>78</b>
10.1. FAULT EVENT DESCRIPTION	78
10.2. CONTROL PANEL MODE AND RESPONSE TABLE	79
10.3. CROSS ZONE VERIFICATION	81
10.4. FIRE VERIFICATION	81
10.5. CONTACT-ID PROTOCOL & FORMAT	82
10.6. EVENT CODE	83

# 1. Introduction

This section covers unpacking your IP Security System with HSGW Series IP Panel and Security Sensors. Refer to later chapters for information on setting up and configuring the system over the Web Page in more detail.

The advanced IP Security System with fully integrated TCP/IP technology and Ethernet connectivity is able to take full advantage of new advances in IP Home Security and Home Automation and multi-path signalling.

The HSGW Series include the following models:

Name	Reporting Path	Modules
HSGW-G1-4B/6B- S	IP Reporting	IP Gateway with built-in module
HSGW-G1-4B/6B-ZW	IP Reporting	IP Gateway with built-in Z-Wave module
HSGW-G3-4B/6B- S-F1 433/	IP Reporting	IP Gateway with built-in RF and module
HSGW-G3-4B/6B-ZW-F1 433/	IP Reporting	IP Gateway with built-in RF and Z-Wave module
HSGW-G5-4B/6B- S-ZW	IP Reporting	IP Gateway with built-in and Z-Wave module
HSGW-G8-6B- S-F1 433/	IP/GPRS Reporting	IP Gateway with built-in RF, 3G, and module
HSGW-G8-6B-ZW-F1 433/	IP/GPRS Reporting	IP Gateway with built-in RF, 3G, and Z-Wave module
HSGW-G15-4B/6B- S-ZW-F1 433/	IP Reporting	IP Gateway with built-in , Z-Wave, and RF modules

**\*4B = 4 batteries, 6B = 6 batteries**

## 1.1. System Specification

Function	
Zone Number	80 Wireless Zones (Includes up to 6 Remote Keypads and 20 Remote Controllers)  Z-Wave devices  Devices
Zone Types	Start Entry Delay, Burglar Follow, Burglar Instant, Burglar Outdoor, 24 Hours, Fire, Medical, Emergency, Emergency (Quiet), Water, Set/Unset, Silent Panic, CO, Gas, Heat  For information on configuring Zone Groups, please see Appendix A
User PIN Codes	6 Users, 1 PIN Code each user (4-digits, number 0~9 ), available combination from 0000~9999 (10000 different combinations, no disallowed PIN Code )  Note: Input of 5 invalid User PIN codes at the remote keypad will lock the remote keypad for 15 minutes.
Control Facilities	Remote Keypad & Remote Controller <b>Home Portal Server</b>
Report Destinations	20 Monitoring Stations or mobile number
Reporting Format	Contact ID, SIA, SMS Text,
Arming Modes	Away, Home 1, Home 2, Home 3
Alarm Type	Burglar, Panic, Fire, Medical, Emergency, Water, Silent
Siren Timeout	Programmable (3 min. by default), For Remote Keypad use only
Supervision	Programmable time frame for inactivity alert
Special Function	Tamper Protection
Real Time Clock (RTC)	The Control Panel keeps and display time and date. This feature is also used for the log file by providing the date and time of each event.
GSM Standards	<b>Compiles with CE &amp; FCC standards.</b>
<b>Electrical</b>	
External AC adaptor	100-240V, 50/60Hz input, <b>9V 1A output (HSGW-X-4B series)</b>  100-240V, 50/60Hz input, <b>12V 1A output (HSGW-X-6B series)</b>
Power Supply Type	PS Type A, not suitable for use external to supervised premises.
Backup Battery	<b>Ni-Mh 4.8V 1100mAH rechargeable battery pack (HSGW-X-4B series)</b>

	Ni-Mh 7.2V, 1600mAH rechargeable battery pack (HSGW-X-6B series)	
APS fault Low Voltage SD signal threshold	4.85 V $\pm$ 3% (HSGW-X-4B series) 7.5 V $\pm$ 3% (HSGW-X-6B series)	
Battery Duration	6.5 hours for (HSGW-X-4B series) 13 hours or more for (HSGW-X-6B series)	
Battery Recharge Time to 80% of 1100mAH/1600mAH	72 hours	
Current Drain	AC Powered	Min: 94mA, Max: 103mA. (HSGW-X-4B series) 230mA standby, 639mA at full load. (HSGW-X-6B series)
	Battery Powered	Min: 167mA, Max: 183mA (HSGW-X-4B series) 117mA standby, 799mA at full load. (HSGW-X-6B series)
<b>Wireless</b>		
Frequency	MHz(RF), Z-Wave	
Antenna Type	Monopole, On-board PIFA	
Encryption	Private Encryption Method	
Protocol	Climax	
<b>Physical Properties</b>		
Operating Temperature	-10°C ~ 40°C	
Humidity	85% relative humidity @23°C	

## 2. Panel Information

### 2.1. Identifying the parts:

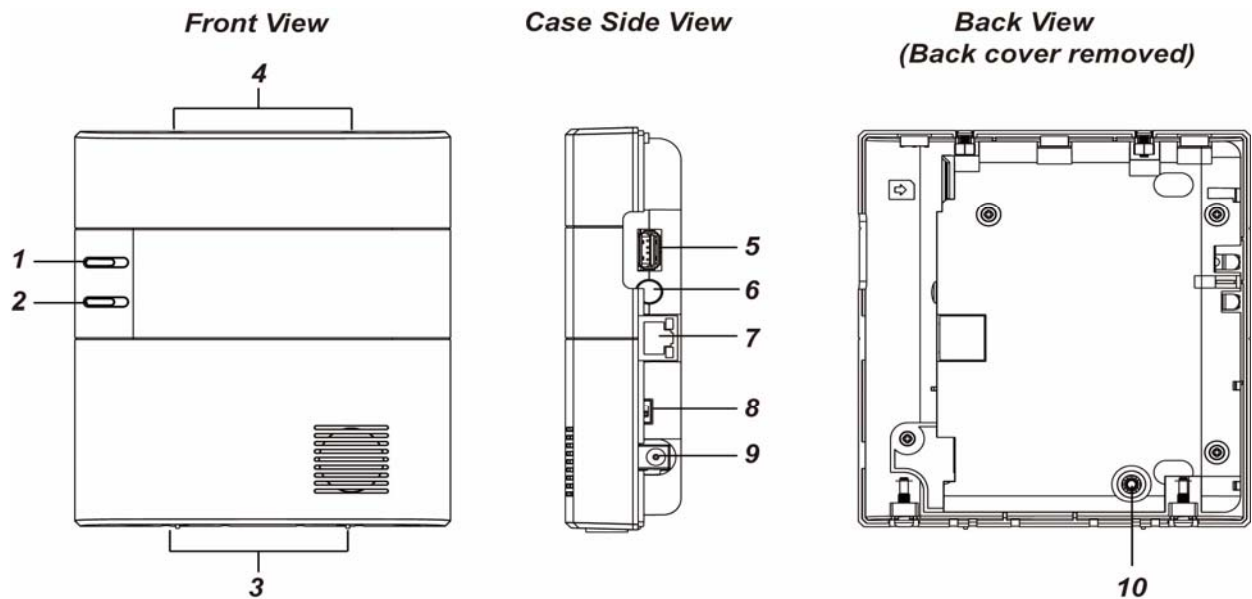

#### 1. LED 1 (Green/Red)

LED 1 Red On – Area 1 in the Full Arm mode.

LED 1 Red Flash– Area 1 in the Home 1/Home2/Home3 mode

LED 1 Green On – System in the learning mode.

LED 1 Green Flash – System in the Walk Test mode.

#### 2. LED 2 (Red/Yellow)

LED 2 Red On –Alarm in Memory

LED 2 Red Flash– Alarm

LED 2 Yellow On – System Fault

#### 3. Bottom Fixing Screw (x2)

#### 4. Clasp Hook (x2)

#### 5. USB Port

- Z-Wave dongle USB port

#### 6. Reset/Learn Button

#### 7. Ethernet Port

#### 8. Battery Switch

#### 9. DC Jack

- For connecting DC 9V 1A switching power.

#### 10. Tamper Switch

#### 11. Wall Mounting Knockouts (x4)

#### 12. Wiring Hole

#### 13. Bracket (for Desktop Deployment)

#### 14. Bracket Hooks (for Desktop Deployment)

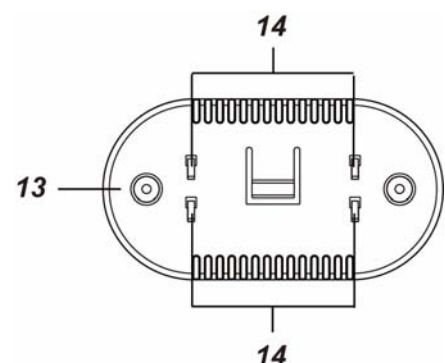
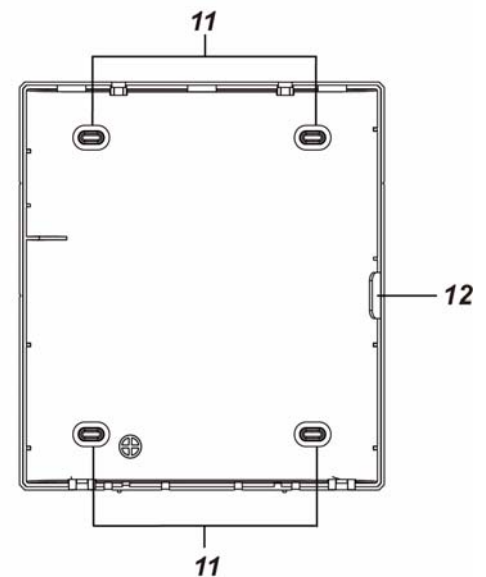

## 2.2. The Power Supply:

An AC power adapter is required to connect to a wall outlet. Be sure only to use an adapter with the appropriate AC voltage rating to prevent component damage. DC 9V 1A switching power output adaptor is generally used to power the Control Panel with 4.8V, 1100mAh Ni-mH rechargeable battery pack and DC 12V 1A switching power is used to power the Control Panel with 7.2V, 1600 mAh, Ni-mH rechargeable battery pack.

### Rechargeable Battery

- HSGW-X-4B series includes 4.8V, 1100 mAh, Ni-mH rechargeable battery pack or HSGW-X-6B series includes 7.2V, 1600 mAh, Ni-mH rechargeable battery pack (required for 3Gor 3G dongle option)
- In addition to the adapter, there is a rechargeable battery inside the Control Panel, which serves as a backup in case of a power failure.
- During normal operation, the AC power adapter is used to supply power to the Control Panel and at the same time recharge the battery. Slide the Battery Switch to ON to activate and charge the battery. It takes approximately 72 hours to fully charge the battery
- The battery status information is displayed in the Panel section of local area webpage.

## 2.3. System Requirements:

The system requires a TCP/IP network environment for you to connect to the Control Panel for system programming.

Hardware requirement for programming the panel vial LAN webpage:

- Microsoft Windows 98, ME, NT4.0, 2000, XP, Windows 7 or 8operating system.
- Microsoft Internet Explorer 6.x, or later and Mozilla Firefox 3.0 compatible.
- CD-ROM drive
- CPU: Intel Pentium II 266MHz or above
- Memory: 32MB (64MB recommended)
- VGA resolution: 800x600 or above



## 3. Getting Started

Read this section of the manual to learn how to set up your Control Panel and program System Settings over the Web page.

### 3.1. System Deployment

Follow guidelines below when planning installation location:

- The Control Panel requires Ethernet connection.
- The Control Panel should be installed at a location that is hidden from outside view.
- Avoid mounting the Control Panel near large metal objects which may affect wireless radio strength.
- The Control Panel should be protected by sensors so that no intruder can reach the Control Panel without first activating a sensor.
- When using routers to improve network coverage, remember to use only Router with backup batteries for security sensors. If you use a Router without backup battery for security sensors, the Router will be powered down in case of AC failure, and you security sensors will lose connection with the network.

Home Automation devices (Power Switches...etc) do not have this limit and can be used with any Router.

### 3.2. Installation

The Control Panel can be placed on deskop.

- 1 The panel casing is secured by two top clasp hooks and two bottom screws and loosen the 2 bottom fixing screws and then two top clasp hooks to open cover.
- 2 Flip over the panel for configuration:
  - I. Connect Ethernet cable to panel Ethernet port.
  - II. Connect the Power Adaptor to a Wall Outlet and the other end to the Control Panel. After several seconds, the Control Panel will emit 2 beeps to indicate that the system is now operational.
  - III. Slide Battery Switch to ON position.

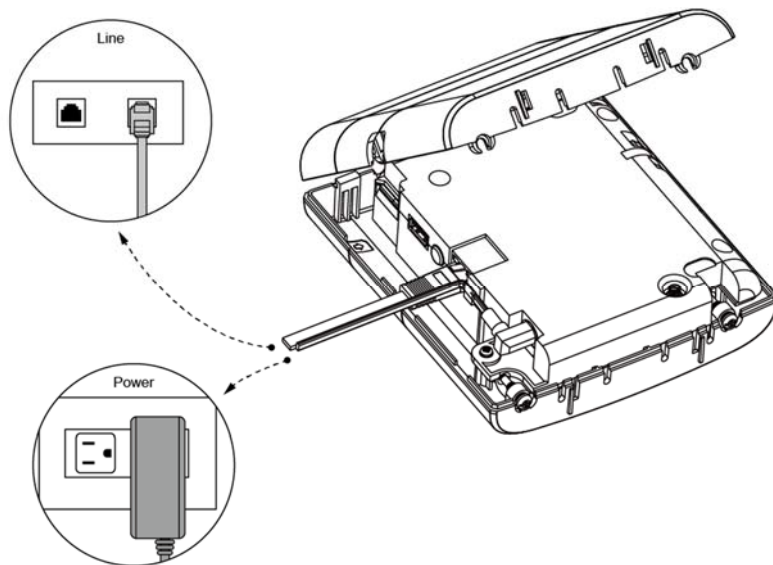

3 The back cover of the panel has one line hole for wiring purpose.

4 Choose to install the panel on desktop.

Desktop:

- I. Replace the back cover, wire the cable through the side line hole and tighten the 2 fixing screws on the bottom.
- II. Replace the standing base bracket.



III. Put the panel at desired location to finish installation.

### 3.3. Software Installation

※ THIS INSTALLATION IS ONLY REQUIRED FOR FIRST TIME USER ※

#### 1. RUNNING THE FINDER SOFTWARE

The Finder software is required for your computer to identify the control panel on the LAN. To install the “Finder” software”

**Step 1.** Insert the supplied CD-ROM into your CD-ROM drive

**Step 2.** Find the **Finder** software in the CD-ROM.

**Step 3.** Double click on the **Finder\_v1.x** to initiate the installation.

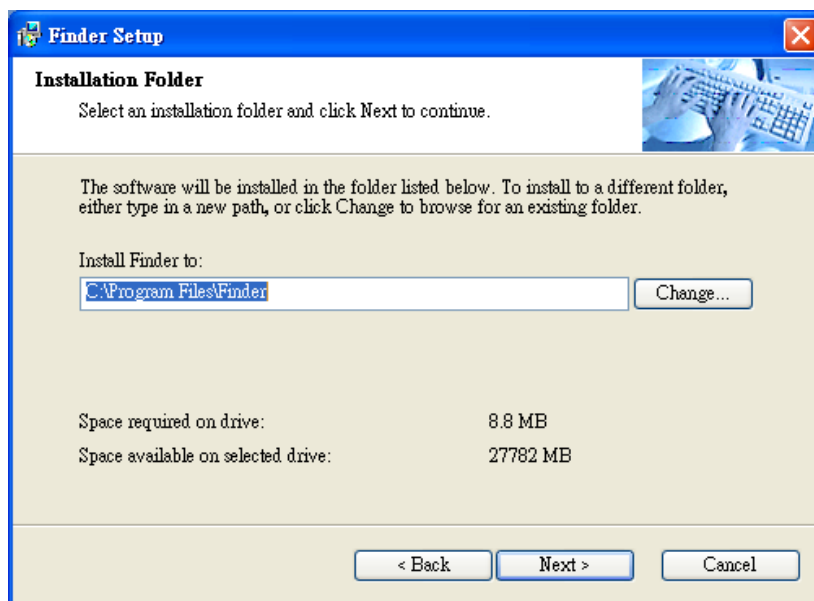

**Step 4.** Follow on screen instruction to complete installation

**Step 5.** Once complete, the Finder icon will be displayed on your desktop.



**Step 6.** Double click on the “**Finder.exe**” to start the software. Finder will automatically search for control panel on the LAN and display its information. If available, the panel’s LAN IP address, Firmware version and MAC address will be displayed

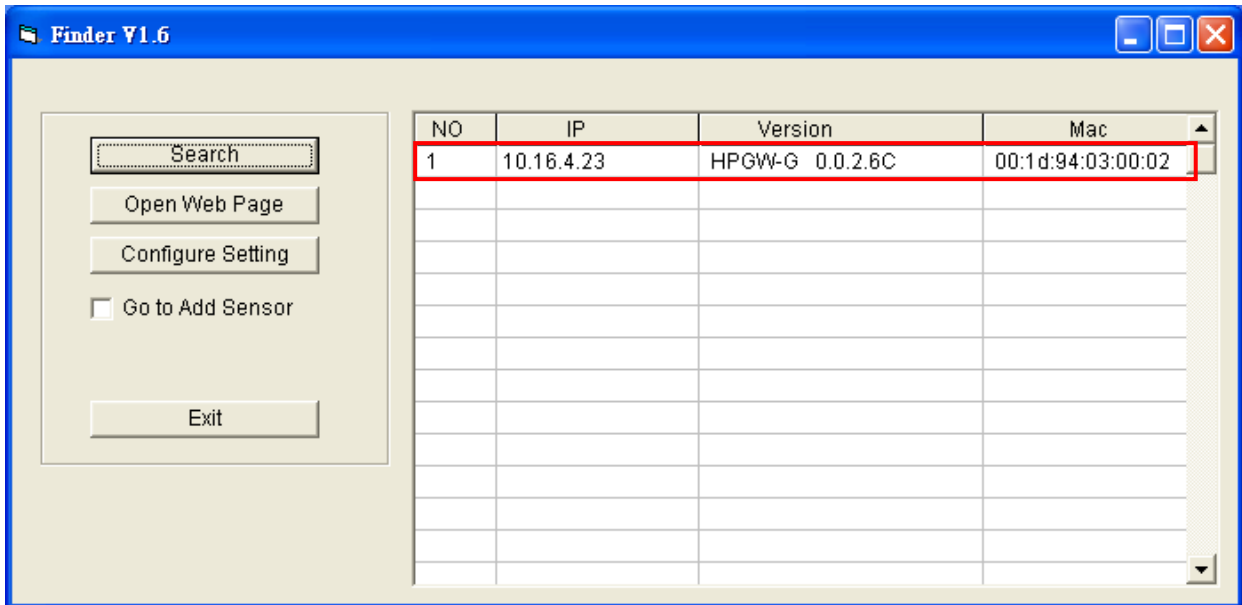

**Step 7.** If the panel information is not displayed, check panel power and Ethernet connection and click on “**Search**” to update the panel information.

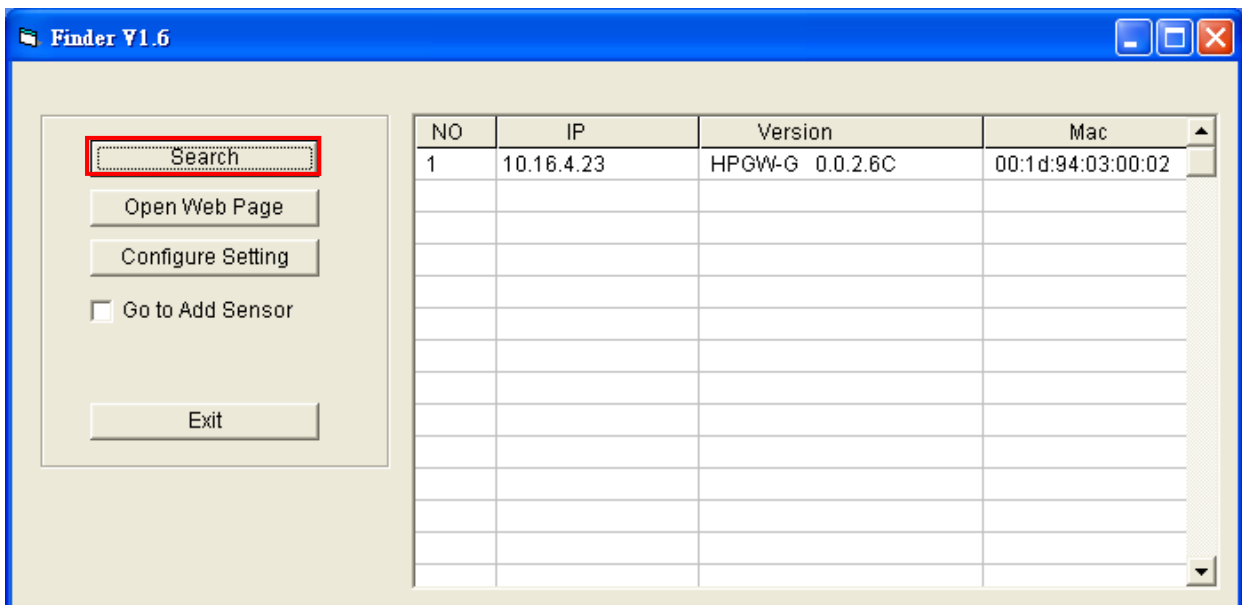

**Step 8. (Optional)** You can choose to edit the panel's network setting by clicking on the panel column, then click "Configure Setting"

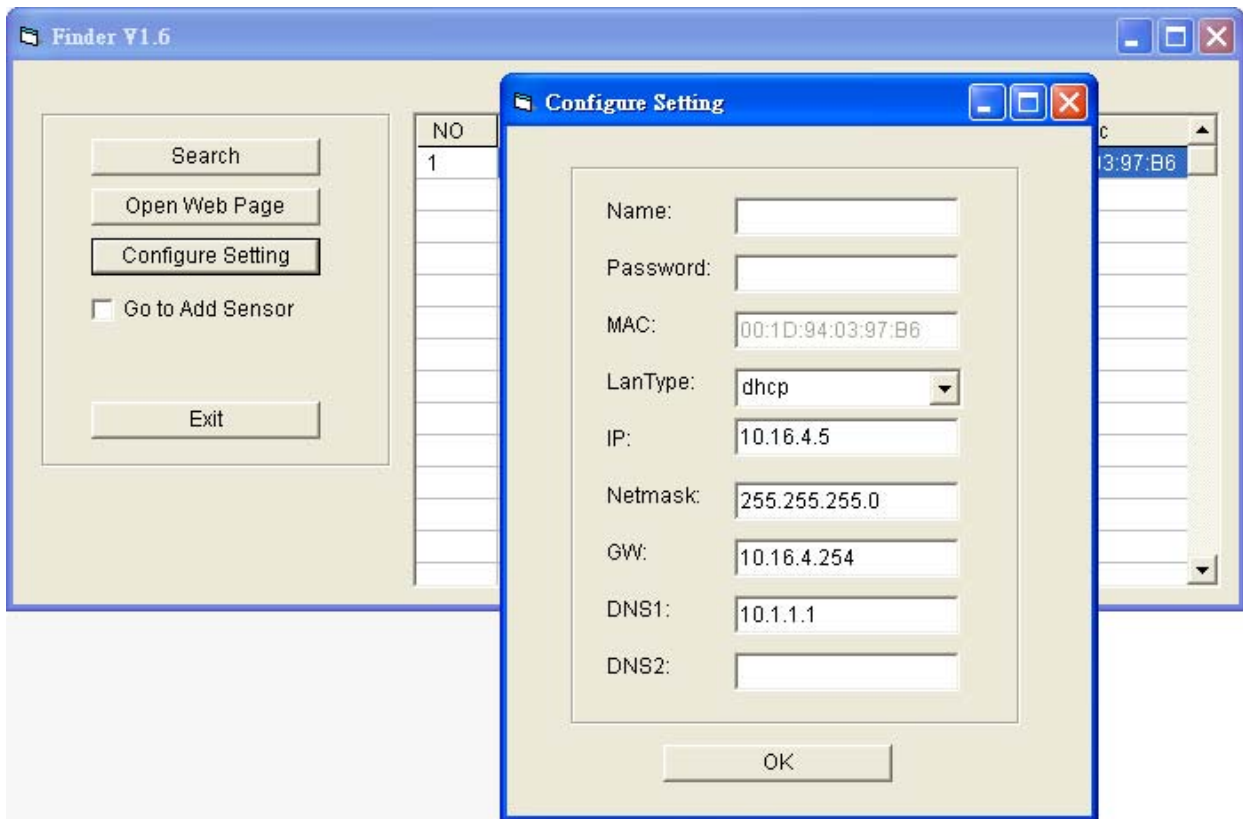

The LanType is default to **DHCP** and does not require manual input of IP/Netmask/Gateawy/DNS setting. If you wish to configure these setting manually, change LanType to **Static**.

After finish changing network setting, enter the user name (default: **admin**) and password (default: **cX+HsA\*7F1**) then click **OK** to confirm. The user name and password can be changed later in panel configuration webpage

**Step 9.** Click the panel information column and click on "**Open Web Page**", or double click on the panel column to link to the panel configuration webpage. Your default browser will start automatically to connect to the LAN IP displayed in Finder.

## 4. Connection to Panel Webpage

For first time setup, webpage connection is only available within 1 hour after the panel is powered on; if the panel has been powered on for more than 1 hour. Webpage access will be disabled. Reboot the panel to enable webpage function again.

Change default password after login to gain unrestricted webpage access.

**Step 1.** Select the Control Panel in the Finder software and click on “Open Webpage” to connect to panel webpage.

Alternatively, enter the Control Panel IP address displayed in Finder into your browser’s address section and proceed.

**Step 2.** Enter the User name & Password to proceed

Default user name: **admin**

Default password: **cX+HsA\*7F1**

(If wrong user name and password are entered for **5** times, the local webpage login will be disabled for **5** minutes.)

**Step 3.** You will enter change password page. Enter and repeat a new password (username change is optional), take care that both username and password are case sensitive. Click OK to confirm.

The screenshot shows a web browser window with a title bar that says "Change Password". The page content includes:

- User Name: **admin**
- New Name:
- New Password:
- Repeated Password:
- Two buttons: "OK" and "Reset"
- Copyright notice at the bottom right: ©2016 Climax Tech. Co., Ltd.

**Step 4.** Upon confirming new username and password. You will enter panel Welcome page. The panel will prompt you to re login with new username and password.

**Step 5.** You will enter panel Welcome page. The Control Panel’s information will be displayed. Click on the pages and folders on the left to access the Control Panel’s various functions



- Home
- Panel
- History Records
- Event Log
- Panel Setting
- PIN Code
- Captured Events
- Reported Events
- Device History
- + Device Management
- + Network Setting
- + System Setting
- Logout

## Welcome to Alarm Panel!

Firmware revision:	HPGW-G 0.0.2.6C HPGW-L2-XA24 2.0.2.6.1
Firmware/RF revision:	HPGW-L2-XA24
ZigBee revision:	2.0.2.6.1
Z-wave revision:	
GSM revision:	Cinterion BGS2-W REVISION 01.301
Public IP Address:	59.124.230.221
Internal IP Address:	10.16.4.23
MAC Address:	00:1d:94:03:00:02

©2014 Climax Tech. Co., Ltd.

The Welcome page displays current control panel firmware version information according to different panel model and MAC address.

### <IMPORTANT NOTE>

- ☞ If the default login password is not changed, webpage access will be disabled 1 hour after power on. Reboot the panel and changed password to allow unrestricted webpage access.

## 5. Device Management

The Device Management section allows you to learn in, edit, control and view all available accessory devices that can be included in the HSGW Series Control Panel.

### 5.1. Learning

Use this function to add new devices into the Control Panel. HSGW Series supports up to 160 zones of accessory devices, in 2 areas, up to 80 zones each area.

The following types of accessory devices are supported:

- **RF device:** All Climax RF devices are supported. (For only model, RF devices are not supported.)
- **device:** All device with Home Automation 1.2 profile are supported.

#### <IMPORTANT NOTE>

- ☞ The Control Panel built-in module supports up to **40** devices by itself. If you wish to include more than 40 devices into the Control Panel, you must add extra Routers into the Control Panel's network to increase the network's maximum device capacity.
- **IP Cameras:** The Control Panel is compatible with Climax VST-1818 Series IP Camera. Up to 6 IP Cameras are supported.
- **Z-Wave Device:** Available for Z-Wave modules only, other modules requires additional USB Z-Wave Dongle.

#### 5.1.1. Add Sensor

**Step 1.** Click on “Learning” to enter learn page.

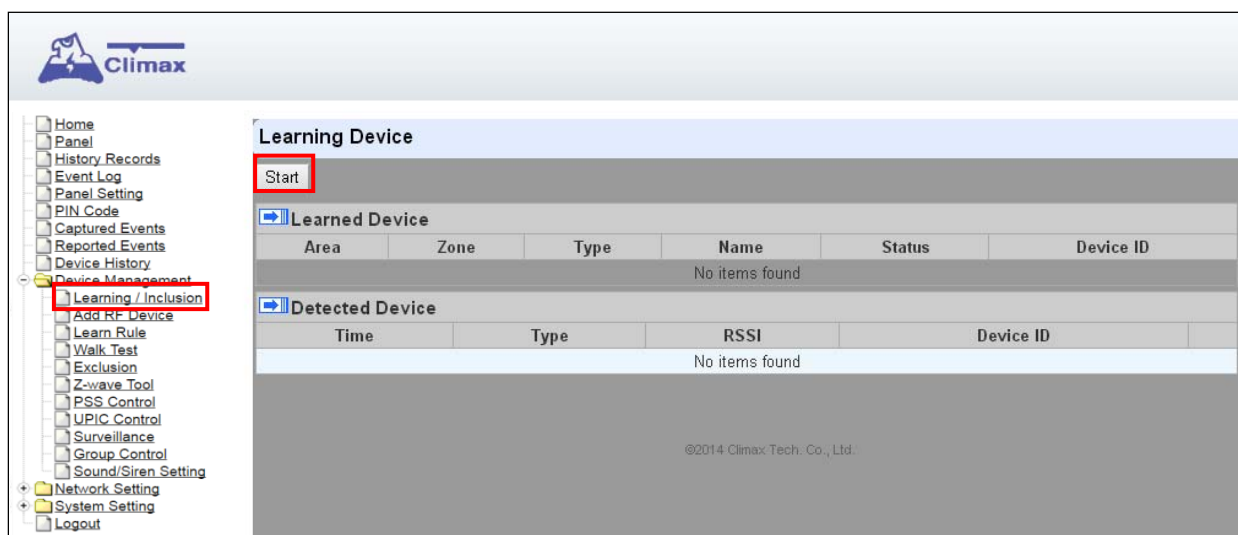

**Step 2.** Click on “Start” to enter learning mode.

**Step 3.** Press the test or learn button on the each device or any button on the Remote Controller. (Please refer to each sensor's user manual for test or learn button position).

#### <NOTE>

- ☞ For sensors, press and hold the learn button for 10~12 seconds to transmit a learn



code.

- For IP Camera VST-1818 Series, press and hold the Privacy button for 10 seconds.

**Step 4.** When the system received the signal transmitted from device, the screen will display its information for selection.

**<NOTE>**

- It takes 5-10 seconds for the Control Panel to receive a learn code from or Z-Wave Sensor.

**Step 5.** Click “Add” to include selected device into panel. If the sensor you wish to learn into already exists in the system, the sensor information will be displayed in the **Learned Device** section. If not, the sensor information will be displayed in the **Detected Device** section.

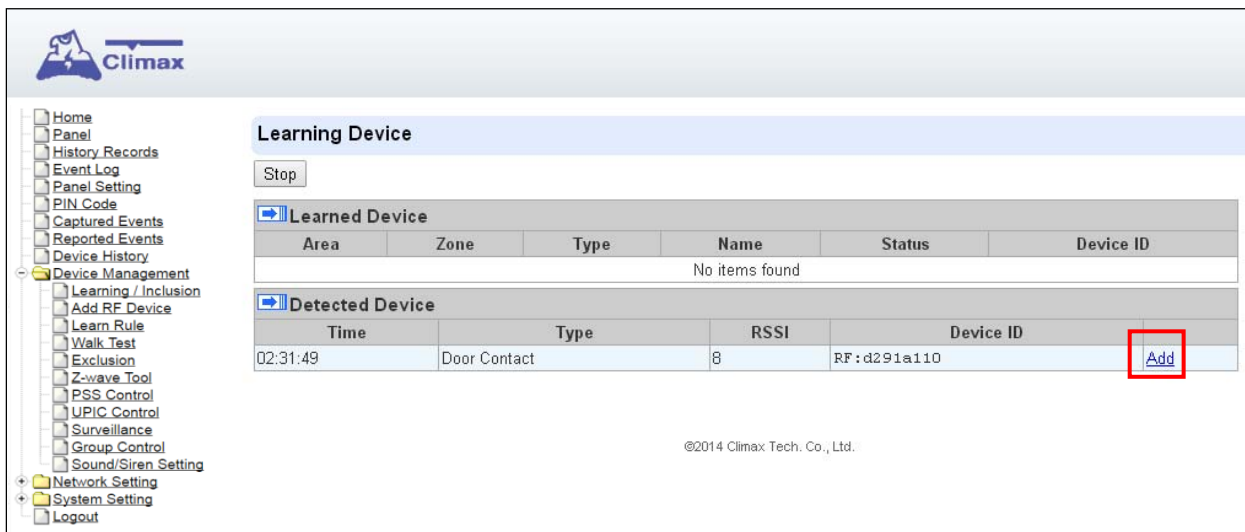

**Step 6.** If the device is successfully learnt into the system, the added device will be displayed in the “Learned Device” section.

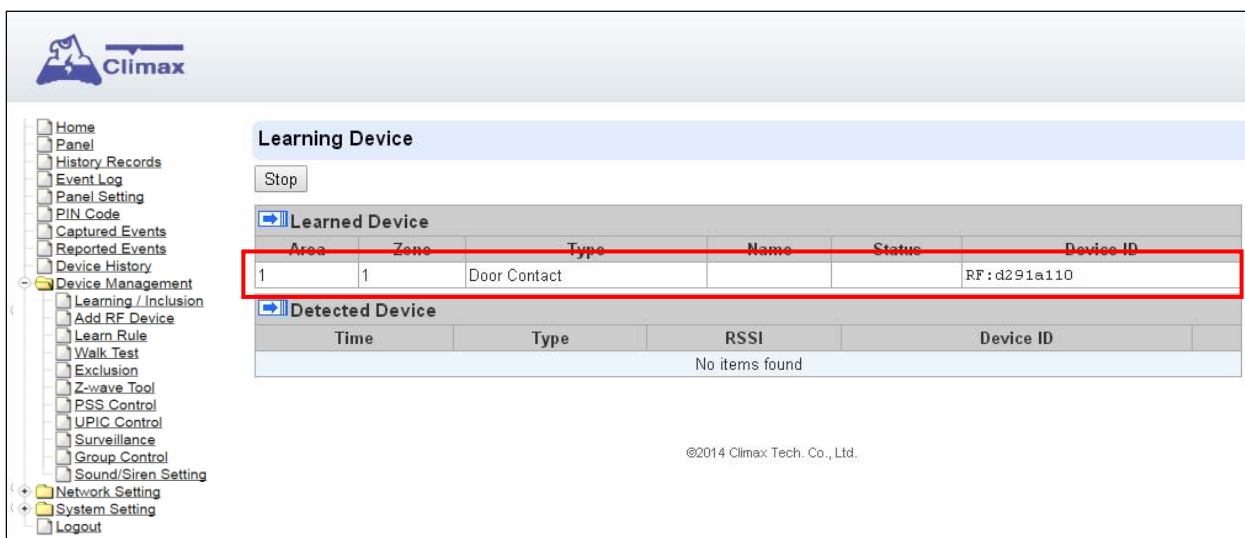

**Step 7.** Repeat Step 3~5 to learn in all device, click Stop to exit learn mode when complete. The system will automatically exit Learn mode if left idle for 5 minutes.

### 5.1.2. Local Learning

Instead of learning devices via configuration webpage, you can also learn in devices by using the learn button located on the back of Control Panel.

**Step 1.** Press and hold the **Learn** Button on the back of Control Panel for 10 seconds, release

when the Control Panel emits one short beep. **LED 1 Green will turn ON** to indicate the Control Panel is now in learning mode

**Step 2.** Press the test or learn button on each device to transmit signal, refer to device manual for detail.

**Step 3.** When the Control Panel receives signal from device, it will emit 2 beeps to confirm. The device will be included in the panel automatically.

**Step 4.** After finish learning all devices, press and holde the Learn button for 1 second. The Control Panel will emit 2 short beeps to indicate it has returned to normal mode. **LED1 will dim.**

**<NOTE>**

- ☞ Device learnt in via Local Learning will be assigned to Area 1 only, which is limited to 80 devices.
- ☞ The Control Panel cannot enter learning mode when under Away Arm/Home Arm or Walk Test mode. The Control Panel will emit 5 beeps to indicate error.

**5.1.3. Edit Devices**

After finish learning devices, proceed to edit the device setting.

**Step 1.** Click **Panel** to enter Panel webpage. All learnt in devices will be displayed under **Device List** section.

**Panel Control**

**Area 1**  
Current mode: Disarm  
 Disarm  Full Arm  Home Arm 1  Home Arm 2  Home Arm 3

**Area 2**  
Current mode: Disarm  
 Disarm  Full Arm  Home Arm 1  Home Arm 2  Home Arm 3

**Panel Status**

Battery	Tamper	Interference	AC activation	Signal GSM	Background RSSI
Normal	N/A	Normal	Normal	N/A	0

Test System:

**System in maintenance**

**Fault Status**

Fault	Setting
SIM Not Inserted	<input type="checkbox"/> Clear
GSM No Signal	<input type="checkbox"/> Clear

Reload

**Device List**

Area	Zone	Type	Name	Condition	Battery	Tamper	Bypass	RSSI	Status
1	1	Door Contact		Normal	Normal	Normal	No	N/A	<a href="#">Edit</a> <a href="#">Delete</a>

**Note**

No.	Type	Description
#1		<a href="#">Edit</a>
#2		<a href="#">Edit</a>
#3		<a href="#">Edit</a>
#4		<a href="#">Edit</a>
#5		<a href="#">Edit</a>

**Step 1.** To edit the device setting or information, click “**Edit**” at end of device entry.

Device List										
Area	Zone	Type	Name	Condition	Battery	Tamper	Bypass	RSSI	Status	
1	1	Door Contact		<span style="color: green;">█</span>	<span style="color: green;">█</span>	<span style="color: green;">█</span>	No	N/A		<a href="#">Edit</a> <a href="#">Delete</a>

**Step 2.** You will enter Device Edit webpage

**Step 3.** Edit your device setting and information according to instruction below. Click “**OK**” to save your new changes when finished. Alternatively, click “**Default**” to reset all parameters to default values or click “**Reset**” to re-enter all the information.

- **Name:** Enter a name for the device.
- **Area:** Select the area which the device belongs to.
- **Zone:** Select the Device zone number.
- **Attribute List:**  
The attribute list determines panel behaviour when the panel receives trigger signal from the device. There are

**General Attribute:**

[Permanently Bypass](#)

This function allows user to permanently deactivate (bypass) the selected device.

- If bypassed, then the Control Panel will not respond at all when the sensor is

triggered.

- If bypassed, the system can be armed directly regardless the device's fault situation. However, its fault situation will still be monitored, logged and displayed in the webpage.

#### Latch report

This function **ONLY** applies to Remote Control or Door Contact with Set/Unset attribute enabled.

- Latch Report **ON**: When the device is used to change system arm mode, the Control Panel will report the arm/disarm action by the particular device.
- Latch Report **OFF**: When the device is used to change system arm mode, the Control Panel will not report the arm/disarm action by the particular device.

#### Set/Unset

This function is for Door Contact only. This function allows Door Contact to control system mode.

- **Normal Close**: The system will be armed when the Door Contact is opened, and disarmed when Door Contact is closed.
- **Normal Open**: The system will be armed when the Door Contact is closed, and disarmed when Door Contact is open.

#### 24HR

This function enables the device to activated selected alarm event whenever it is triggered regardless of system mode. System mode response will be disabled if 24HR attribute is enabled.

### **System Mode Attributes:**

The System Mode Attributes determines system behavior under particular arming mode when the sensor is triggered.

#### No Response

- When a sensor with **No Response** is triggered, the Control Panel will not respond.

#### Start Entry Delay 1/ Start Entry Delay 2

- When the system is under Full Arm or Home Arm mode, if a sensor with **Start Entry Delay 1/2** attribute is triggered, Control Panel will start an entry countdown period to give enough time to disarm the system.
- When the Control Panel is in the Disarm mode, if a sensor with **Start Entry Delay 1/2** attribute is triggered, the Control Panel will immediately report a burglar interior alarm (**CID code: 132**).
- When the Control Panel is in the Full Arm mode, if a sensor with **Start Entry Delay 1/2** attribute is triggered, the Entry Delay 1/2 timer starts counting down. If no correct pin code is entered during the entry delay timer to disarm the system, the Control Panel will report a burglar perimeter alarm (**CID code:131**) immediately after entry delay timer 1/2 expires.
- When the Control Panel is in the Home Arm 1/2/3 mode, if a sensor with **Start Entry Delay 1/2** attribute is triggered, the Entry Delay 1/2 timer starts counting down. If no correct pin code is entered during the entry delay period to disarm the system, the Control Panel will report a burglar interior alarm (**CID code: 132**) immediately after entry delay timer 1/2 expires.

☞ [Chime](#)

- When the system is in Arm/ Home Arm 1/ Home Arm 2/ Home Arm 3 mode, if a sensor set to Chime is triggered, the Control Panel will sound a Door Chime (Ding-Dong Sound).

☞ [Burglar Follow](#)

- When the system is in Full Arm or Home Arm mode mode, if a sensor set to **Burglar Follow** is triggered, the Control Panel will report a burglar alarm immediately.
- When a Start Entry sensor is triggered and the system is under Entry Delay Timer countdown, if a sensor set to **Burglar Follow** is triggered, the Control Panel will wait until the Entry Delay Timer expires before activating a burglar alarm. If the system is disarmed before the timer expires, the Control Panel will not activate alarm.

☞ [Burglar Instant](#)

- When the system is under Full arm or Home Arm/ Disarm / Entry Time mode, if a sensor set to **Burglar Instant** is triggered, the Control Panel will report a burglar alarm immediately.

☞ [Burglar Outdoor](#)

- When the system is in Full Arm or Home Arm / Disarm / / Entry Time mode, if a sensor set to **Burglar Outdoor** is triggered, the Control Panel will report a burglar outdoor event immediately.

☞ [Cross Zone](#)

- See **12.2 Appendix – Cross Zone Verification** for detail.

☞ [Apply Scene](#)

- This function is only available for Remote Keypad and Remote Control.
- Select a Home Automation Scene number for a Remote Keypad or Remote Control button. When the button is pressed, the Control Panel will execute the actions programming in the Scene accordingly. For more information, please refer to **8.3. Scene**.

**Home Automation Attributes:**

The Home Automation Attributes allows a device to control Home Automation function.

☞ [Trigger Response](#)

- When the device is triggered, the Control Panel will activated selected Home Automation Scene number. Please refer to **8.3. Scene** webpage for detail.

☞ [Restore Response](#)

- When the device transmits restore signal after trigger, the Control Panel will activate selected Home Automation Scene number.

**Other Attributes:**

☞ [Permanent Bypass](#)

- When checked, the panel will completely ignore all signal received from this device. A bypassed device will be unable to trigger any response, including alarm or fault from the Control Panel. All other attribute settings will be also be ignored.

☞ **Exit (No Response)**

- If checked, the panel will ignore trigger signal from this sensor during Exit Time countdown. If deselected, the panel will activated burglar alarm and report immediately when the sensor triggered during Exit Delay Timer.

☞ **24HR**

- A sensor set to 24HR attribute will ignore Disarm, Full Arm, Home are and Exit response setting. The panel will activate selected alarm when this sensor is triggered regardless of system mode under any time.

**<NOTE>**

- ☞ Some devices have their own unique functions and will have its own attribute setting which is not listed in this section. Please refer to the device manual for its setting detail.

### 5.1.4. Delete Devices

**Step 1.** To delete a sensor, click “Delete” under “Device List”

Device List										
Area	Zone	Type	Name	Condition	Battery	Tamper	Bypass	RSSI	Status	
1	1	Door Contact		█	█	█	No	N/A		<a href="#">Ed</a> <a href="#">Delete</a>

**Step 2.** A message “Delete success” is displayed and the sensor you choose is deleted successfully.

### 5.1.5. Identify Device

The Identify function is available for device only, it can be used to locate devices after learning.

For battery powered devices, the identify fuction should be used within 1 minute after pressing device button, or 3 minute after learning in the device. Otherwise due to network mechanisms, the device may not be able to receive signal successfullly from panel.

AC powered devices do not have such limits and you can use Identify function anytime.

**Step 1.** Click “Identify” under the Device List after the device column entry.

Device List										
Area	Zone	Type	Name	Condition	Battery	Tamper	Bypass	RSSI	Status	
1	1	Repeater		█	█	█	No	N/A		<a href="#">Edit</a> <a href="#">Delete</a> <a href="#">Identify</a>

**Step 2.** If the device receives signal successfully, the webpage will display a success message and the device LED indicator will flash 10 times to confirm.

**<NOTE>**

- ☞ If a timeout message is displayed on webpage, it means the device did not receive signal from Control Panel, please check device range from panel and make sure to follow instruction above about Identifying battery powered devices.

## 5.2. Add RF Device

Besides learning, you can also add RF devices into the system by entering its RF code into the system with **Add RF Device** function.

**Step 1.** Click **Add RF Device**.



The screenshot shows the Climax web interface. On the left is a navigation tree with the following items: Home, Panel, History Records, Event Log, Panel Setting, PIN Code, Captured Events, Reported Events, Device History, Device Management (expanded), Learning / Inclusion, Add RF Device (highlighted with a red box), Learn Rule, Walk Test, Exclusion, Z-wave Tool, PSS Control, UPIC Control, Surveillance, Group Control, Sound/Siren Setting, Network Setting, System Setting, and Logout. The main content area is titled 'Add RF Device' and contains the following fields: 'Area' (dropdown menu set to 1), 'Zone' (dropdown menu set to 5), 'RF code:' (text input field), and 'Name:' (text input field). Below these fields are three buttons: 'OK', 'Reset', and 'Or Cancel'. At the bottom right of the main content area, there is a copyright notice: '©2017 Climax Tech. Co., Ltd.'

**Step 2.** Select Area and Zone number for the device you wish to add into system.

**Step 3.** Enter the device RF code, and preferred device name (up to 31 characters)

**Step 4.** Press “OK” to save

**Step 5.** If the RF code you entered is valid, the device will be added into the system according to the Area and Zone number. You do not need to learn the device as instructed in **5.1.1. Add Sensor**.

## 5.3. Learn Rule

You can enter the sensor RF code or MAC address manually to assign area and zone number to this sensor. Sensors learned with pre-assigned rule will be put under the area and zone number you specified. This function does not work with Z-Wave devices and DECT device.

**Step 1.** Click **Learn Rule**.

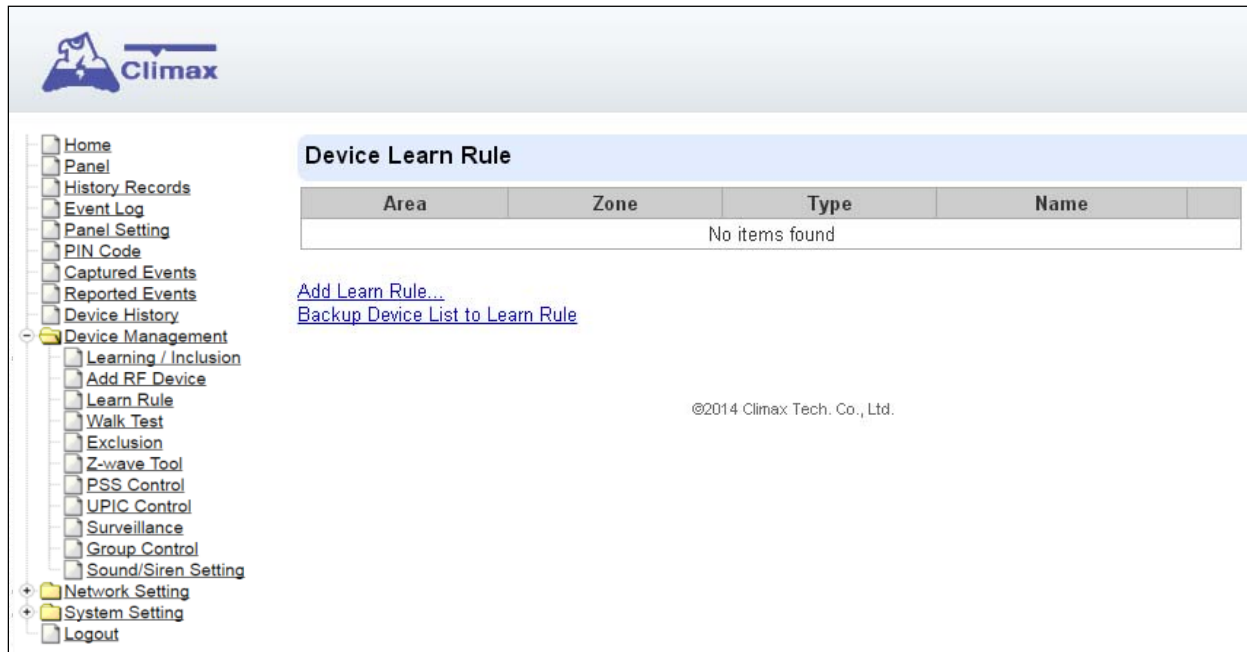

**Step 2.** You will see the **Add Learn Rule** menu.

The 'Add Learn Rule' dialog box contains the following fields and options:

- Area: 1 (dropdown)
- Zone: 1 (dropdown)
- System:  RF  ZigBee
- RF code: [text input field]
- ZigBee MAC: [text input field]
- ZigBee Device Type: IR (dropdown)
- Name: [text input field]
- Buttons: OK, Reset, Or Cancel

**Step 3.** Select **Area** and **Zone** number for this device.

**Step 4.** Select **RF** or **ZigBee**.

**Step 5.** Key in the RF code or ZigBee MAC info

**Step 6.** For ZigBee device, select a ZigBee Device Type

**Step 7.** Enter a preferred name for sensor (up to 31 letters or numbers).

**Step 8.** Press "OK" to save.

**Step 9.** If the process is successful, the screen will display "**Updated Successfully.**" You can then check, edit or delete the rule under the **Learn Rule** menu.

**Step 10** Repeat the steps to add more rules.



**Step 11.** Learn in the sensors you have entered rules for according to **5.1.1 Add Sensor**.

<NOTE>

- ☞ Learn rule function is only used to pre-assign area and zone number to sensors before learning. To add sensor to control panel, you still need to follow the instruction in **5.1.1 Add Sensor** to complete the learning process.

- **Backup Device List to Learn Rule**

You can choose to import learn rule from current learnt in devices

**Step 1.** Click “Backup Device List to Learn Rule”.

**Step 2.** Click OK to confirm.

**Step 3.** The Learn Rule page will be updated with new rules according to current device list information. Z-wave device and IP Camera will not be included.

## 5.4. Walk Test

This is to test the sensor operation range for installation purpose.

**Step 1.** Click “**Start**” to enter Walk Test mode.

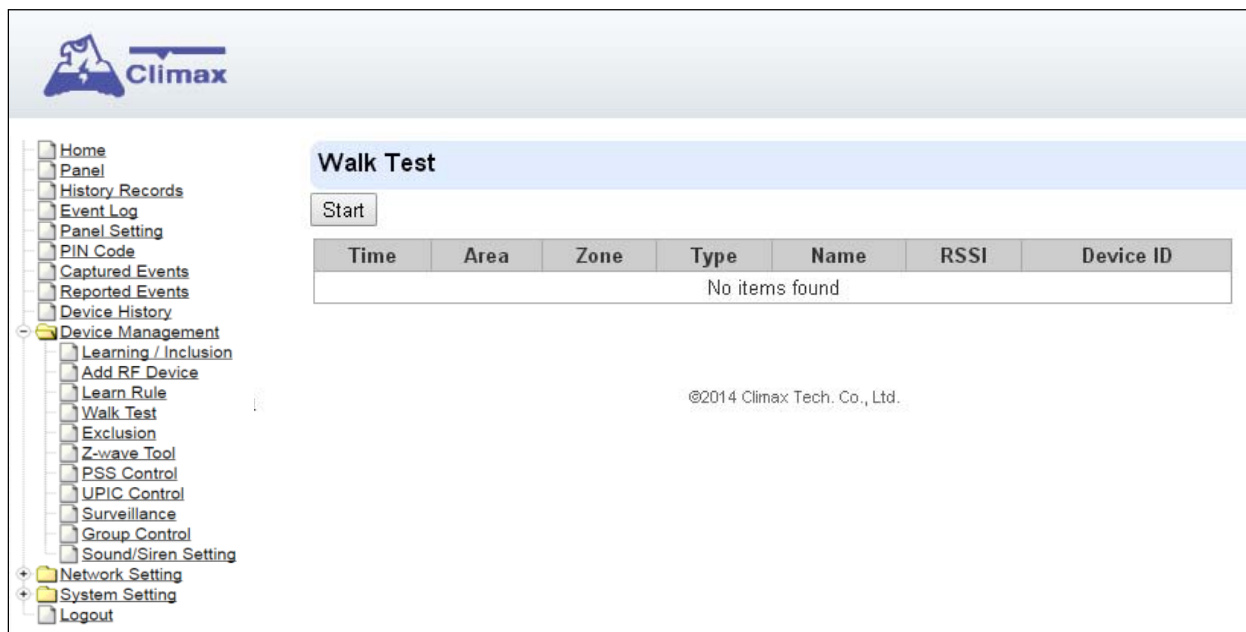

**Step 2.** Press the test button on the sensor(s) or any button on the Remote Controller or triggering the sensor.

**Step 3.** When the Control Panel receives a signal, it will show as below and a 2-tone beep will be heard to indicate that it is safe to install the particular sensor in the location.

- **Time:** time information
- **Area:** operation area
- **Zone:** device zone
- **Type:** device type
- **Name:** device name
- **Rssi:** the RF signal strength between Control Panel and sensor. The Rssi value here must be higher than the Rssi value of Panel’s background noise (please refer to 6.1 *Panel Condition* section for details). If not, you may still learn in the sensor; however, please relocate the sensor and use Walk test to find a more suitable location.
- **DeviceID:** device’s unique identification code.

**Step 4.** Once all sensors are tested, click on “**Stop**” to exit Walk Test mode. The system will automatically exit Walk Test mode if left idle for 5 minutes.

## 5.5. Exclusion

This feature is only available for Z-Wave modules only, or when a Z-wave dongle is inserted into the Control Panel. This feature is for you to remove Z-Wave device only.

**Step 1.** Click on “**Exclusion**” and click on “**Start**” to start the procedure. Then the Panel will enter the removing mode.

The screenshot shows the Climax web interface. On the left sidebar, the 'Exclusion' option under 'Device Management' is highlighted with a red box. The main content area is titled 'Remove Z-wave device' and features a 'Start' button. Below the button is a table with two columns: 'Time' and 'Device ID'. The table currently displays 'No items found'. A copyright notice '©2011 Climax Tech. Co., Ltd.' is visible at the bottom of the main content area.

**Step 2.** Refer to the Z-Wave device manual to transmit signal.

**Step 3.** Select the desired Z-Wave and click **delete** to remove it from the Z-wave list under **Device List** section (**Panel**). Then the Control Panel will remove the Z-Wave device.

The screenshot displays the Climax web interface with the 'Device List' section expanded. Above the device list, there are sections for 'Test System: OK', 'System in maintenance', and 'Fault Status' (which is currently empty). The 'Device List' table contains 19 rows of device information. The 'Delete' button for the device with ID 6 is highlighted with a red box. A 'Reload' link is located to the right of the table header.

Area	Zone	Type	Name	Condition	Battery	Tamper	Bypass	RSSI	Status	Edit	Delete
1	1	Remote Controller	RC-16	█	█	█	No	N/A		Edit	Delete
1	2	Remote Controller	RC-8	█	█	█	No	N/A		Edit	Delete
1	3	Remote Controller	RC Plus	█	█	█	No	N/A		Edit	Delete
1	4	Remote Controller	RC-18	█	█	█	No	N/A		Edit	Delete
1	5	Door Contact	DC-8	█	█	█	No	Strong, 8	DC Close	Edit	Delete
1	6	Door Contact		█	█	█	No	Strong, 8		Edit	Delete
1	7	Thermostat		█	█	█	No	N/A		Edit	Delete
1	8	IR	IR-9	█	█	█	No	Strong, 8		Edit	Delete
1	9	IR	IR-18	█	█	█	No	Strong, 8		Edit	Delete
1	10	Outdoor IR	EIR	█	█	█	No	Strong, 8		Edit	Delete
1	11	IR	PIR-23	█	█	█	No	Strong, 8		Edit	Delete
1	12	Keypad	KP-9	█	█	█	No	N/A		Edit	Delete
1	13	Keypad	KP-23	█	█	█	No	N/A		Edit	Delete
1	14	Keypad	KP-16	█	█	█	No	N/A		Edit	Delete
1	15	Keypad	KP-23SW	█	█	█	No	N/A		Edit	Delete
1	16	Smoke Detector	HD-9	█	█	█	No	Strong, 8		Edit	Delete
1	17	Night Switch	WL-8	█	█	█	No	N/A		Edit	Delete
1	18	CO	CO	█	█	█	No	Strong, 8		Edit	Delete
1	19	WTR	WTRQ	█	█	█	No	N/A		Edit	Delete

## 5.6. Z-Wave Tool

The Z-wave Tool is used to reset Z-wave module to factory default and remove all Z-wave devices, or change routing setting.

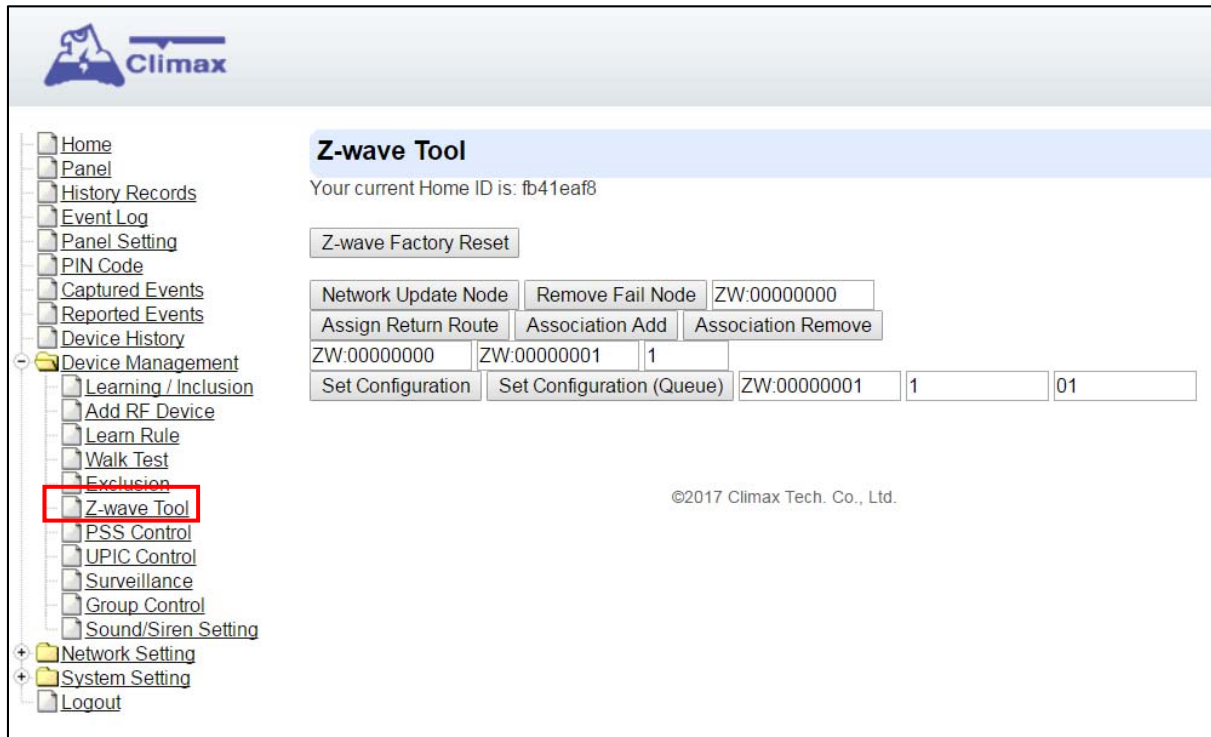

**Step 1.** Click "Z-Wave Factory Reset", the Z-Wave module is reset to factory default and all Z-Wave devices will be removed automatically. The Control Panel Home ID will also be changed automatically for a newly added Z-Wave device to recognize.

**Step 2.** The list of Z-Wave devices is still displayed in the **Panel** webpage. Please go to panel webpage and remove all Z-wave devices.

- **Change Z-Wave Routing Setting**

Use the other functions to configure your Z-Wave routing settings.

## 5.7. PSS Control

This feature is designed to control/edit/delete Power Switches included in the panel.



The screenshot shows the Climax web interface. On the left is a navigation tree with 'PSS Control' highlighted. The main area is titled 'Power Switch Sensor' and contains a table with the following data:

Area	Zone	Type	Name	Status	
1	1	Power Switch Meter		Off, 0.0W	<a href="#">Edit</a> <a href="#">Delete</a> <a href="#">Switch On</a> <a href="#">Switch Off</a> <a href="#">Switch Toggle</a>

©2011 Climax Tech. Co., Ltd.

- Click **Edit** to edit attributes of power switches.
- Click **Delete** to remove power switch from panel.
- Click **Switch On/Switch Off** to turn on/off power switches. Or click **Switch Toggle** to toggle between on/off status. For Power Switch Dimmer, you can also set its power output level with the slide down menu.

## 5.8. UPIC Control

UPIC Control webpage allows you to control UPIC IR Transmitter included in Control Panel

The screenshot displays the Climax UPIC Control interface. On the left is a navigation tree with 'UPIC Control' selected. The main panel shows a table for device configuration:

Area	Zone	Type	Name
1	1	UPIC	Off

Below the table, there are dropdown menus for 'Air Conditioner', 'TV', 'Home Audio', 'Set-top Box', and 'Others', each with a 'Setup LED' button. A diagram titled 'UPIC5 LEDs' illustrates a central LED connected to five peripheral LEDs labeled 1 through 5.

- **Transmit IR Signal**

Depending on the UPIC model number, select the function to be performed in the drop down menu, then click “Setup UPIC” for the UPIC to transmit IR Signal.

- **UPIC5 LED Setup (UPIC5 only)**

UPIC5 has 6 IR LEDs, a central one and 5 surrounding ones. The central LED will always transmit IR signal when activated; besides the central LED, one of the 5 surrounding LEDs can be selected to activate upon IR signal transmission to increase the IR signal coverage.

**Step 1:** Refer to the diagram on the webpage and UPIC5 manual to determine which LED should be used for signal transmission to each particular home appliance.

**Step 2:** Select the LED number from the drop down menu for each appliance type, then click “Setup LED” to confirm. Please refer to UPIC5 manual for more information.

### <EXAMPLE>

- ☞ If “Air Conditioner” is set to LED 1, UPIC5 will transmit all Air Condition functions with both Central LED and LED1.
- ☞ If “TV” is set to LED 5, UPIC5 will transmit all Air Condition functions with both Central LED and LED5.

## 5.9. Surveillance

The PIR Camera/Video Cameras and IP Cameras are listed under **Surveillance** for separate control.



The screenshot shows the Climax web interface. On the left is a navigation menu with items like Home, Panel, History Records, Event Log, Panel Setting, PIN Code, Captured Events, Reported Events, Device History, Device Management (expanded), Learning / Inclusion, Add RF Device, Learn Rule, Walk Test, Exclusion, Z-wave Tool, PSS Control, **Surveillance** (highlighted with a red box), Group Control, Sound/Siren Setting, Network Setting, System Setting, and Logout. The main content area is titled 'Surveillance' and contains a table with the following data:

Area	Zone	Type	Name				
1	2	IR Camera		<a href="#">Edit</a>	<a href="#">Delete</a>	<a href="#">Request Media</a>	<a href="#">Request Media (No Flash)</a>
1	9	IP Camera		<a href="#">Edit</a>	<a href="#">Delete</a>	<a href="#">Request Media</a>	<a href="#">View</a> <a href="#">Setting</a>

©2015 Climax Tech. Co., Ltd.

- Click **Edit** to edit camera attributes.
- Click **Delete** to remove device from panel.
- Click **Request Media** to capture a picture or vide
  - PIR camera: A picture will be captured upon request
  - PIR Video Camera: A 10-second video will be recorded upon request
  - IP Camera: The IP Camera will record a video according to its video length setting (Please refer to IP Camera manual for detail.)
  - For PIR Camera/Video Camera, you can choose to take the picture/video without activating the camera's flash.

Picture and video captured by PIR Camera and PIR Video Camera will be stored under the **Captured Event** webpage. Video Recorded by IP Camera will be stored in the IP Camera, please refer to IP Camera manual to view the video

- For IP Camera, click "View" or "Setting" to access IP Camera webpage for video streaming or setting configuration. A new webpage will open and you will be required to enter the username and password for the IP Camera to access streaming or setting.

## 5.10. Group Control

This feature is designed for you to edit a name of group, switch on or off a group of Power Switches. You can also assign Power Switches to groups you desire.

### 5.10.1. Group Control/Edit

**Step 1.** Specify a new name for a group.

The screenshot shows the Climax web interface. On the left is a navigation menu with 'Group Control' highlighted. The main area is divided into two sections: 'Group List' and 'Device List'.

**Group List Table:**

Group	Name	Switch On	Switch Off
1	<input type="text"/>	<a href="#">Switch On</a>	<a href="#">Switch Off</a>
2	<input type="text"/>	<a href="#">Switch On</a>	<a href="#">Switch Off</a>
3	<input type="text"/>	<a href="#">Switch On</a>	<a href="#">Switch Off</a>
4	<input type="text"/>	<a href="#">Switch On</a>	<a href="#">Switch Off</a>
5	<input type="text"/>	<a href="#">Switch On</a>	<a href="#">Switch Off</a>
6	<input type="text"/>	<a href="#">Switch On</a>	<a href="#">Switch Off</a>
7	<input type="text"/>	<a href="#">Switch On</a>	<a href="#">Switch Off</a>
8	<input type="text"/>	<a href="#">Switch On</a>	<a href="#">Switch Off</a>

Buttons:

**Device List Table:**

Area	Zone	Type	Name	Group 1	Group 2	Group 3	Group 4	Group 5	Group 6	Group 7	Group 8	
1	4	Power Switch Meter		<input type="checkbox"/>	<input type="checkbox"/>	<input type="checkbox"/>	<input type="checkbox"/>	<input type="checkbox"/>	<input type="checkbox"/>	<input type="checkbox"/>	<input type="checkbox"/>	<a href="#">Edit</a> <a href="#">Delete</a>

Buttons:

**Step 2.** Click Switch On or Switch Off to turn on or off one group of power switches.

### 5.10.2 Device Edit/Delete

**Step 1.** Check on the groups you wish to assign the Power Switch. This is a multiple-choice field and you can assign one Power Switch to multiple groups. Whenever one of the assigned groups receives request to turn on/off, all Power Switches belonging to the group will be activated accordingly.

The screenshot shows a close-up of the 'Device List' table. The 'Group 1' checkbox for the 'Power Switch Meter' device is checked.

**Device List Table:**

Area	Zone	Type	Name	Group 1	Group 2	Group 3	Group 4	Group 5	Group 6	Group 7	Group 8	
1	1	Power Switch Meter		<input checked="" type="checkbox"/>	<input type="checkbox"/>	<input type="checkbox"/>	<input type="checkbox"/>	<input type="checkbox"/>	<input type="checkbox"/>	<input type="checkbox"/>	<input type="checkbox"/>	<a href="#">Edit</a> <a href="#">Delete</a>

Buttons:

**Step 2.** Click **Edit** to edit attributes of an added power switch or power switch meter or **Delete** to delete this device.



## 5.11. Sound/Siren Setting

The Sound/Siren Setting page includes setting Siren configuration function.

The screenshot shows the Climax web interface. On the left is a navigation menu with items like Home, Panel, History Records, Event Log, Panel Setting, PIN Code, Captured Events, Reported Events, Device History, Device Management (with sub-items like Learning / Inclusion, Add RF Device, Learn Rule, Walk Test, Exclusion, Z-wave Tool, PSS Control, UPIC Control, Surveillance, Group Control, and Sound/Siren Setting), Network Setting, System Setting, and Logout. The main content area is titled "Sound/Siren Setting" and contains a table with the following data:

Area	Zone	Type	Name	
1	4	Siren		<a href="#">Edit</a> <a href="#">Delete</a>

Below the table is the "RF Siren Setup" section with two buttons: "Tamper On" and "Tamper Off". The copyright notice "©2017 Climax Tech. Co., Ltd." is visible at the bottom right of the main content area.

### 5.11.1. Device Edit/Delete

Click **Edit** to edit the Siren's attribute, volume and voice settings, or **Delete** to delete the Siren.

This is a close-up of the "Sound/Siren Setting" section from the previous screenshot. It shows the table with the "Edit" and "Delete" links highlighted with red boxes. Below the table is the "RF Siren Setup" section with "Tamper On" and "Tamper Off" buttons.

After clicking **Edit**, you will be directed to the Device Edit page:

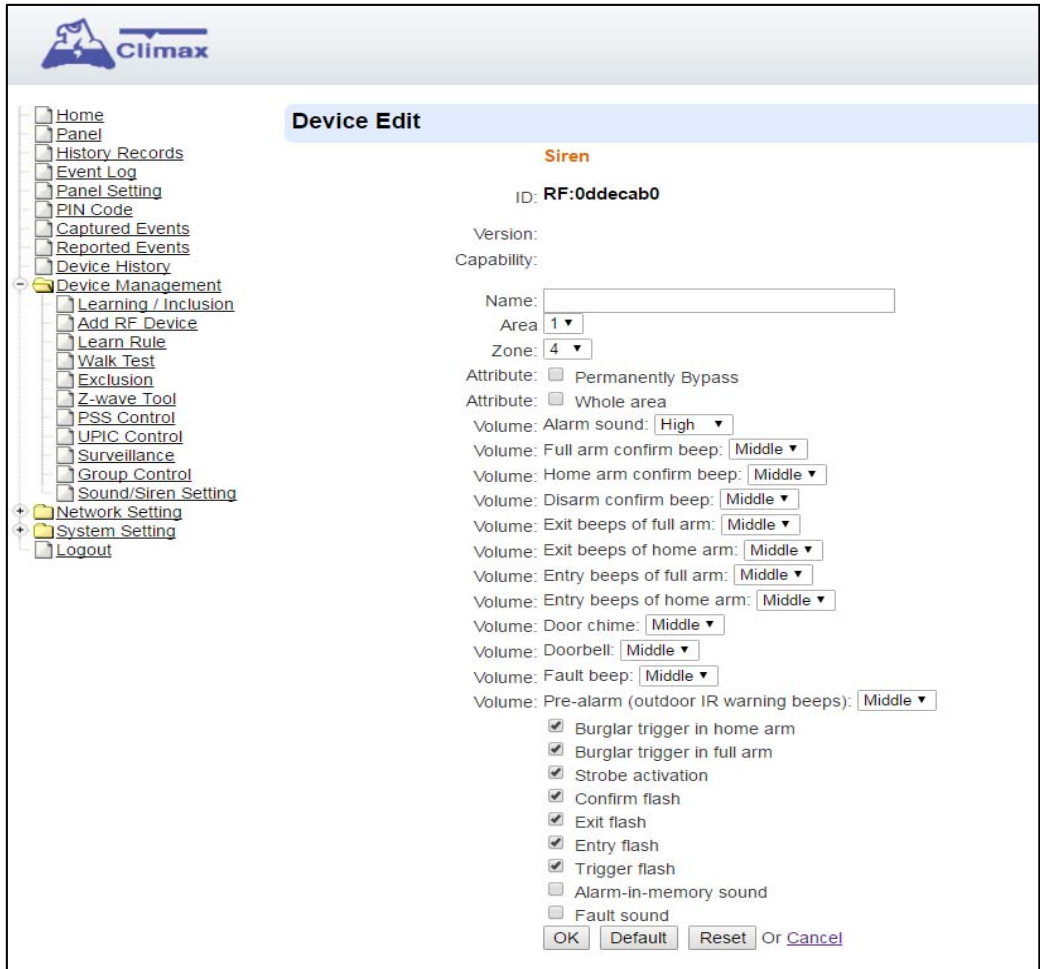

**<NOTE>**

☞ The Device Edit page is only available for the newest BX/Siren series and BX series **without DIP Switch**.

Edit your Siren setting and information accordingly to instruction below. Click “OK” to save your new changes when finished. Alternatively, click “Default” to reset all parameters to default values or click “Reset” to re-enter all the information.

- **Name:** Enter a name for the Siren.
- **Area:** Select the area which the Siren belongs to.
- **Zone:** Select the Siren zone number.

☞ **Attribute:**

- **Permanently Bypass:** If checked, the Control Panel will completely ignore all signal received from the Siren. A bypassed Siren will not be able to trigger any response, including alarm or fault from the Control Panel. All other attribute settings will also be ignored.
- **Whole Area:** if checked, all the Volume, Voice and Behavior functions will be simultaneously enabled in Area 1 and Area 2.

☞ **Volume:**

- **Alarm Sound:** set the volume of the alarm sound of the Siren when alarming.
- **Full arm confirm beep:** set the volume of the confirm beep sound of the Siren when

Control Panel is put into Full Arm Mode.

- **Home arm confirm beep:** set the volume of the confirm beep sound of the Siren when Control Panel is put into Home Arm Mode.
- **Disarm confirm beep:** set the volume of the confirm beep sound of the Siren when Control Panel is put into Disarm Mode.
- **Exit beeps of full arm:** set exit countdown beep volume under Full Arm Mode.
- **Exit beeps of home arm:** set exit countdown beep volume under Home Arm Mode.
- **Entry beeps of full arm:** set entry countdown beep volume under Full Arm Mode.
- **Entry beeps of home arm:** set entry countdown beep volume under Home Arm Mode.
- **Door Chime:** set the volume of the Door Chime sound (Ding-Dong Sound).

☞ Voice:

*(The following functions are only available for **SRV** devices):*

- **Doorbell:** set the volume of the ring tone when pressing the button on the Video Door Phone (VDP).
- **Fault beep:** set the volume of the voice played when system is force armed under fault conditions.
- **Pre-alarm (outdoor IR warning beeps):** set the volume of the voice played when an outdoor burglar sensor(Door Contact, IR) is triggered.

☞ Behavior

*(The following functions are only available for **RF modules**):*

- **Burglar trigger in home arm:** Enable or Disable whether Siren is activated when an alarm is triggered under Home Arm.
- **Burglar trigger in full arm:** Enable or Disable whether Siren is activated when an alarm is triggered under Full Arm.
- **Strobe activation:** Enable or Disable Siren LED strobe activation.
- **Confirm flash:** Enable or Disable Siren LED flash when system Armed/Disarmed.
- **Exit flash:** Enable or Disable Siren LED flash during an exit countdown period.
- **Entry flash:** Enable or Disable Siren LED flash during an entry countdown period.
- **Trigger flash:** Enable or Disable the flashing from the Siren LED when alarming.
- **Alarm-in-memory sound:** Enable or Disable Alarm in Memory sound.
- **Fault sound:** Enable or Disable system fault sounds.

## 5.11.2. RF Siren Setup

The screenshot displays the Climax web interface. On the left is a navigation menu with items like Home, Panel, History Records, Event Log, Panel Setting, PIN Code, Captured Events, Reported Events, Device History, Device Management (with sub-items like Learning / Inclusion, Add RF Device, Learn Rule, Walk Test, Exclusion, Z-wave Tool, PSS Control, UPIC Control, Surveillance, Group Control, Sound/Siren Setting), Network Setting, System Setting, and Logout. The main content area is titled "Sound/Siren Setting" and contains a table with one row: Area 1, Zone 4, Type Siren, and Name. Below the table is a red-bordered box titled "RF Siren Setup" containing two buttons: "Tamper On" and "Tamper Off". A copyright notice "©2017 Climax Tech. Co., Ltd." is visible at the bottom right of the interface.

Area	Zone	Type	Name	
1	4	Siren		<a href="#">Edit</a> <a href="#">Delete</a>

**RF Siren Setup**

©2017 Climax Tech. Co., Ltd.

### ➤ Tamper On/Off

You can enable/disable all RF Sirens tamper protection with this function. Select to turn on or off the sirens tamper function.

### <NOTE>

- ☞ When turned off, if siren tamper will be enabled again automatically after one hour if not turn on manually during the one hour period.

## 6. Program the System

After the initial set-up, you can then program your system by clicking on the left menu to set them individually.

### 6.1. Panel Condition

In the **Panel** Section, user can arm, disarm or partially arm the system. Besides, it displays the current **Panel Status & Device Information**.

**Panel Control**

**Area 1**  
Current mode: Disarm  
 Disarm  Full Arm  Home Arm 1  Home Arm 2  Home Arm 3

**Area 2**  
Current mode: Disarm  
 Disarm  Full Arm  Home Arm 1  Home Arm 2  Home Arm 3

**Panel Status**

Battery	Tamper	Interference	AC activation	Signal GSM	Background RSSI
Normal	Normal	Normal	Normal	9	1

Test System:

**System in maintenance**

**Fault Status**

Fault	Setting
Area1Zone6 Tamper	<input checked="" type="checkbox"/> Clear

[Reload](#)

**Device List**

Area	Zone	Type	Name	Condition	Battery	Tamper	Bypass	RSSI	Status	
1	1	Keypad		Normal	Good	Normal	No	Strong		<a href="#">Edit</a> <a href="#">Delete</a>
1	2	Remote Controller		Normal	Good	Normal	No	Strong		<a href="#">Edit</a> <a href="#">Delete</a>
1	3	WTRV		Normal	Good	Normal	No	N/A		<a href="#">Edit</a> <a href="#">Delete</a>
1	4	IR Camera		Normal	Good	Normal	No	Good		<a href="#">Edit</a> <a href="#">Delete</a>
1	5	809		Normal	Good	Normal	No	Strong		<a href="#">Edit</a> <a href="#">Delete</a>
1	6	Door Contact		Normal	Good	Tamper	No	Strong	DC Open	<a href="#">Edit</a> <a href="#">Delete</a>

#### **Panel Control**

Select a choice to arm, disarm or partially arm the system.

#### **Panel Status**

The Control Panel will update the panel status periodically. However, in order to show the current status, you must reload the screen to refresh the display.

- **Battery:** When battery is running low, a “low battery” message will be displayed to

inform you to recharge the battery.

- **Tamper:** (reserved)
- **Interference:** This is for you to check whether the Control Panel is purposely interfered. Whenever the signal jamming period lasts longer than 30 seconds, a “Jamming” message will be shown and reported to the Central Monitoring Station accordingly.
- **AC activation:** To check whether AC power is connected. If not, it will show “AC Failure”.
- **Background RSSI:** Rssi value is for you to check the RF environment around the Control Panel. It ranges from 0 to 9, where 0 refers to the weakest and 9 refers to the strongest background noise. Therefore, the lower the Rssi value, the better the environment.

## Test System

The function is designed to send a command to sever over the polling or XMPP protocol.

## Fault Status

Fault Status	
Fault	Setting
Area1Zone6 Tamper	<input checked="" type="checkbox"/> Clear

OK Reset

The fault events that exist in the alarm system is displayed under this section. When fault event exists in system, the control panel Fault LED will light up to indicate fault status under Disarm or Home Arm mode (The Fault LED will not light up under Arm mode).

When fault event exists, and you attempt to arm the system, the arming action will be prohibited and the panel will display fault information on the webpage. If you still want to arm the system, perform the arming action again to force arm.

You can check the “Clear” box in the setting column then click “OK” to ignore the fault event. Cleared fault event will not cause the Fault LED to light up, nor prohibit arming.

## Device List

1. The Control Panel will update the device information periodically. However, in order to show the current status, you must **reload** the screen to refresh the display.
  - **Area:** operation area
    - **Zone:** device zone
    - **Type:** device type
    - **Name:** device title
    - **Status:** device’s current status, such as tamper status, battery status, out of order condition or DC open. If PSM is added into the system, the data of PSM, such as On/Off status, voltage, electric current and watt, will be displayed.
2. Under **Device**, you could further **edit** or **delete** an added device (please refer to **5.1.3** and **5.1.4** for details). Beside, you can reset Panel settings or clear the system faults by pressing **Reset Panel**.

Device List											
Area	Zone	Type	Name	Condition	Battery	Tamper	Bypass	RSSI	Status		
1	2	UPIC					No	Strong, 7		<a href="#">Edit</a>	<a href="#">Delete</a>
1	3	IR					No	Strong, 8		<a href="#">Edit</a>	<a href="#">Delete</a>
1	6	Keypad					No	Strong, 6		<a href="#">Edit</a>	<a href="#">Delete</a>

- After pressing **Reset Panel**, the Control Panel will restart in 60 seconds and all configured values will be kept without any change.

**Note**

Note			
No.	Type	Description	
#1			<a href="#">Edit</a>
#2			<a href="#">Edit</a>
#3			<a href="#">Edit</a>
#4			<a href="#">Edit</a>
#5			<a href="#">Edit</a>

The function is designed for installer to make a note for each control panel. The note you make here can be delivered to a server over XMPP or polling protocol.

## 6.2. Panel Settings

Program the **Panel, Time** and **Sound Settings** at your discretion.

### Panel Setting

- **AC Fail Report:** Set the waiting time before Control Panel report to Central Monitoring Station when AC failure is detected.
- **AC Fail Suspend:** After AC failure is detected, the panel will enter sleeping mode and wake up at regular interval. Use this option to set the wake up period duration.
- **Jamming Report:** this function is reserved.
- **Auto Check-in:** this is to select whether the Control Panel needs to send check-in reporting to the Central Station automatically and to select the period of time between check-in reports. Options available are **Disable, 1 hour, 2 hours, 3 hours... up to 4 Weeks.**
- **Auto Check-in Offset Period:** This is to set the time delay before the first **Auto Check-In** report is made. After power is supplied or re-supplied to the Control Panel, a test report will be sent to the Central Monitoring Station (CMS) based on the Offset



Period. This is used to test whether the CMS is able to receive the report from the Panel accurately.

After this test report is sent, the Control Panel will then send reports at regular interval based on the setting of the Auto Check-in Report.

For example, if **Offset Period** is set to 2 Hours, and **Auto Check-in Report** is set to 12 hours, the Control Panel will transmit an event code 602 to the CMS after 2 hours, and then report 602 event code periodically at a regular intervals of 12 hours.

- **IR Camera Resolution of Alarm Images:** This is to select the resolution and number of pictures taken by PIR Camera when the camera detects a movement in armed mode.

Options available are **320x240x3 images (Default)**, **320x240x6 images** and **640x320x3 images**.

- **Outdoor IR Camera in Greyscale:** This is to select whether pictures from Outdoor PIR Camera should be taken in greyscale instead of color pictures.

Options available are: **Disable**(Color Picture) and **Enable** (Greyscale picture)

### Area Setting

- **Area:** Select operation area to apply setting.
- **Final Door:** If set to **On**: When the system is Away Armed and under exit timer countdown, if a opened Door Contact set to Entry attribute is closed, the system will automatically arm the system even if the exit delay timer has not expired yet.
- **Arm Fault Type:** Select how the system should respond when it is being armed under fault condition.
  - ✓ Confirm: The panel will first display a “Mode Change Fault” message and emit 2 beeps. Arming again within 10 seconds will force arm the system.
  - ✓ Direct Confirm: The system will be force armed directly without displaying fault message and report an event.
- **Tamper Alarm:** Select whether the siren should sound alarm when the tamper is triggered.
  - ✓ Full Arm: when tamper is triggered under Full arm mode, Control Panel raises a local alarm and sends report to the monitoring center. While under Home Arm or Disarm modes no alarm will be activated, nor report sent.
  - ✓ Always: Control Panel raises a local alarm and send report for tamper-trigger in all modes.
- **Supervision Check:** Select to enable or disable system supervision function. When **ON** is selected, the Control Panel will monitor the accessory devices according to the supervision signal received.

### Time Setting

- **Supervision Timer:** The Control Panel monitors accessory devices according to the supervision signal transmitted regularly from the device. User this option to set a time period for receiving supervision signals. If the Control Panel fails to receive supervision signal from a device within this duration, it will consider the device out of order and report the event accordingly.
- **Entry Delay 1 for Full Arm:** Set Entry Delay Timer 1 for full arm mode. When a sensor set to Start Entry Delay 1 is triggered under Full Arm mode, the control panel will begin Entry Delay Timer countdown according to duration set with this option

If the Control Panel is disarmed before the Entry Delay Timer expires, the panel returns to Disarm mode and no alarm is activated. If the Control Panel is not disarmed before the Entry Delay Timer expires, the alarm will be activated and the panel will send

report.

- **Entry Delay 2 for Full Arm:** Set Entry Delay Timer 2 for full arm mode. When a sensor set to Start Entry Delay 2 is triggered under Full Arm mode, the control panel will begin Entry Delay Timer countdown according to duration set with this option

If the Control Panel is disarmed before the Entry Delay Timer expires, the panel returns to Disarm mode and no alarm is activated. If the Control Panel is not disarmed before the Entry Delay Timer expires, the alarm will be activated and the panel will send report.

- **Exit Delay for Full Arm:** Set the Exit Delay Timer when entering Full Arm mode. When the user changes system mode to Full Arm, the panel will begin Exit Delay Timer Countdown and enter Full Arm mode when the timer expires. The user must leave area protected by sensors before the timer expires, otherwise an alarm will be activated with the sensor is triggered.

- **Entry Delay 1 for Home Arm:** Set Entry Delay Timer 1 for Home Arm mode. When a sensor set to Start Entry Delay 1 is triggered under Home Arm mode, the control panel will begin Entry Delay Timer countdown according to duration set with this option

If the Control Panel is disarmed before the Entry Delay Timer expires, the panel returns to Disarm mode and no alarm is activated. If the Control Panel is not disarmed before the Entry Delay Timer expires, the alarm will be activated and the panel will send report.

- **Entry Delay 2 for Home Arm:** Set Entry Delay Timer 2 for Home Arm mode. When a sensor set to Start Entry Delay 2 is triggered under Home Arm mode, the control panel will begin Entry Delay Timer countdown according to duration set with this option

If the Control Panel is disarmed before the Entry Delay Timer expires, the panel returns to Disarm mode and no alarm is activated. If the Control Panel is not disarmed before the Entry Delay Timer expires, the alarm will be activated and the panel will send report.

- **Alarm Length:** Set the duration the external siren should sound when an alarm is activated.
- **Cross Zone Timer:** Please refer to *10.3 Cross Zone Timer* for details
- **Fire Verification Time:** Please refer to *10.4 Fire Verification Timer* below for details.

### Sound Setting

- **Door Chime Setting:** this function is available only when the attribute of Door Contact (DC) and/or PIR detector (IR) is set as **Door Chime**.

The Control Panel sounds a Door Chime (Ding-Dong Sound) while the DC and/or IR is activated in Disarm / Full / Home / Entry mode.

- **Entry Delay Sound for Full Arm:** this is for you to decide whether the Control Panel sounds count-down beeps and volume of beep during the entry delay time in the full arm mode.
- **Exit Delay Sound for Full Arm:** this is for you to decide whether the Control Panel sounds count-down beeps and volume of beep during the exit delay timer in the full arm mode.
- **Entry Delay Sound for Home Arm:** this is for you to decide whether the Control Panel sounds count-down beeps and volume of beep during the entry delay time in the home arm mode.
- **Exit Delay Sound for Home Arm:** this is for you to decide whether the Control Panel sounds count-down beeps and volume of beep during the exit delay timer in the home arm mode.

- **Confirm Sound:** this is for you to decide whether to turn off/or adjust Control Panel beeping sounds when changing Arm/Home Arm/Disarm mode.
- **Warning beep:** this is for you to decide whether the Control Panel will sound a warning beep whenever a fault condition has been detected and displayed. The warning beep will be silenced after the Fault message has been read by the user. When a new fault condition is detected, it will then again emit a warning beep every 30 sec.
- **Entry/ Exit Only Final Beeps:** This is for you to determine when the Control Panel should start warning beep during Entry or Exit countdown timer. For example, if the setting is set to 5 seconds, the Control Panel will only stat warning beep during the last 5 seconds of Entry or Exit countdown timer. When set to Disable, the Control Panel will sound warning beep during the entire Entry or Exit countdown timer.

## 6.3. PIN Code

The User PIN Codes are used by Remote Keypad accessory to control system mode remotely. The 2 areas in the control panel each has 6 User PIN Codes available for setting. Each consists of 4 digits (numeric number 0~9). User PIN code #1 for each Area is always activated factory default.

User PIN #1 in Area 1

Password: **1234**

User PIN #1 in Area 2

Password: **4321**

No.	User Code	User Name	Latch	Delete
1.	1234	user	<input checked="" type="checkbox"/>	<input type="checkbox"/>
2.			<input type="checkbox"/>	<input type="checkbox"/>
3.			<input type="checkbox"/>	<input type="checkbox"/>
4.			<input type="checkbox"/>	<input type="checkbox"/>
5.			<input type="checkbox"/>	<input type="checkbox"/>
6.			<input type="checkbox"/>	<input type="checkbox"/>

### Area

**Area:** Select the area for setting User PIN Code.

### User Code Setting

- **User Code:** Enter the 4-digit code in the field.
- **User Name:** Enter a user name for easy recognition of system events. Up to 17 alphanumerical characters are allow for each user name.
- **Latch:**
  - Latch → **Latch Report ON** = Whenever the User PIN Code is used to change system mode, the panel will report the event.
  - Latch → **Latch Report OFF** = When the User PIN Code is used to change system mode, the panel will not report the event.
- **Delete:** Check the box if you want to delete selected user. User#1 in each area cannot be deleted

After finish all setting, click **OK** to confirm change.

## 7. Network Settings

### 7.1. GSM (HSGW-G8 Series only)

The screenshot shows the Climax web interface. On the left is a navigation tree with 'GSM' selected under 'Network Setting'. The main content area is divided into several sections:

- GSM**: Includes 'Insert SIM' and a 'Check SIM' section with radio buttons for 'No' (selected) and 'Yes', and 'OK' and 'Reset' buttons.
- GPRS**: Includes input fields for 'APN', 'User', and 'Password', with 'OK' and 'Reset' buttons.
- MMS**: Includes input fields for 'APN', 'User', 'Password', 'URL', 'Proxy Address', and 'Proxy Port' (set to 8080), with 'OK' and 'Reset' buttons.
- SMS**: Includes input fields for 'SMS Keyword' and 'SMS P-word' (set to 'PROG'), with 'OK' and 'Reset' buttons.
- Two-Way Setting**: Includes dropdown menus for 'Speaker' (set to 9) and 'Microphone' (set to 7), with 'OK' and 'Reset' buttons.

At the bottom, there are links for 'Send SMS...' and a 'GSM Reset' button.

#### **Check SIM**

This is designed for the system to check the SIM card or not. (***If users do not intend to use the GSM function, please tick “NO” to ensure the system will not check if the SIM card is inserted or not and it will not display the GSM fault by LED flashing.***)

#### **GPRS**

In order to allow GPRS to serve as a back-up IP Reporting method, this section will need to be programmed before reporting.

- **APN (Access Point) Name**

It is the name of an access point for GPRS. Please inquire your service provider for an APN. When APN is set, the system becomes valid for internet connection.

- **User (GPRS)**

It is the Log-in name to input before accessing the GPRS feature. Please inquire your service provider.

- **Password (GPRS)**

It is the User Password to input before accessing the GPRS feature. Please inquire your service provider.

<NOTE>

☞ All values will be applied to both Areas 1 & 2.

**MMS**

The MMS settings are offered by your telecom service provider. Before configuring this function, contact your service provider for correct MMS setting information of the inserted SIM card.

- **APN (Access Point) Name**

Enter a MMS APN name provided by your service provider.

- **User**

Enter the Log-in name for accessing the MMS feature provided by your telecom service provider.

- **Password**

Enter the password for accessing the MMS feature provided by your telecom service provider.

- **URL**

Enter the MMS APN URL provided by your telecom service provider.

- **Proxy Address**

Enter the MMS Proxy Address provided by your telecom service provider.

- **Proxy Port**

Enter the MMS Proxy Port provided by your telecom service provider.

**SMS**

- **SMS Keyword**

For sending remote commands to system via SMS message, a personalized password is required for the Control Panel to recognize your authority.

- **SMS P-Word**

Program Keyword is used to recognize the identity of a valid user; and to give authority for Remote Installing (through SMS Text) or Remote Upgrading purposes (through GPRS). This keyword will need to be inserted whenever the Remote Setting or Remote Upgrading is required. A maximum of 15 characters is allowed.

**Two Way Setting**

The two-way setting is designed to adjust speaker volume and microphone sensitivity on DECT device for two-way communication.

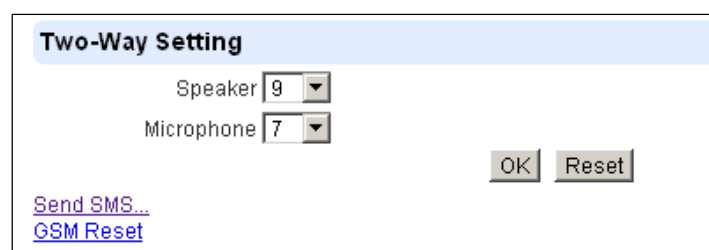

**Send SMS Message**

This feature is designed for you to send a SMS message on this web configuration page.

**Step 1. Click Send SMS.**

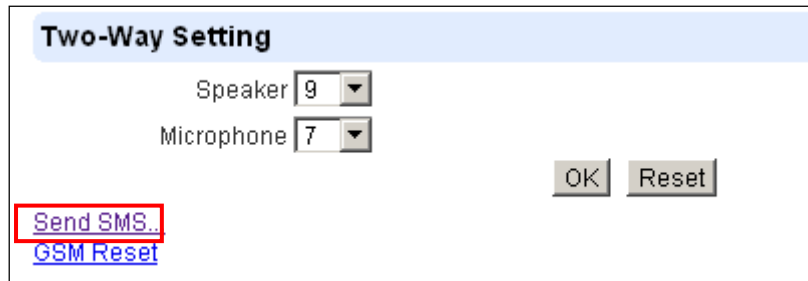

**Two-Way Setting**

Speaker

Microphone

[Send SMS..](#)

[GSM Reset](#)

**Step 2. Enter a desired phone number and text message.**

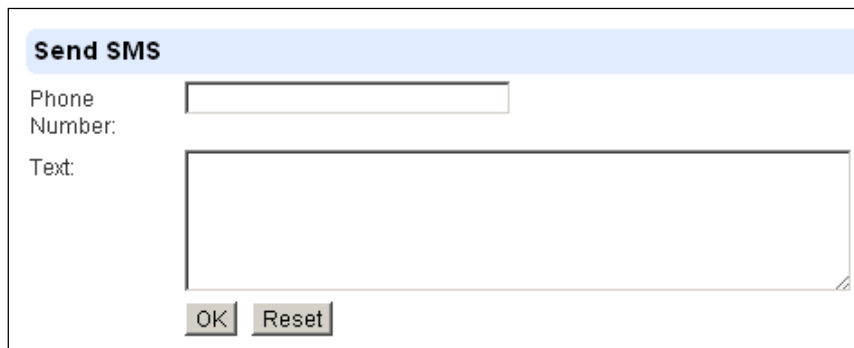

**Send SMS**

Phone Number:

Text:

### **Reset GSM**

This feature is designed for you to reset GSM module.

**Step 1. Click GSM Reset.**

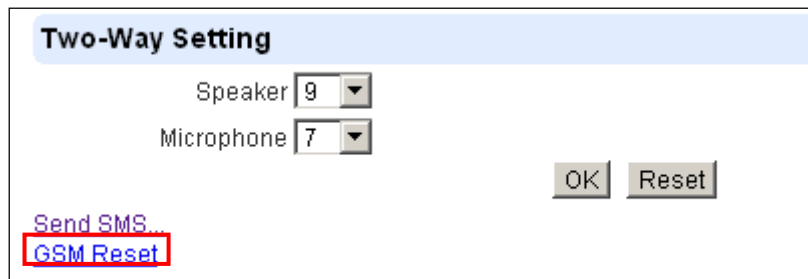

**Two-Way Setting**

Speaker

Microphone

[Send SMS..](#)

[GSM Reset](#)

**Step 2. A pop-out message “Are you sure?” is displayed. Click Yes to confirm resetting.**

## 7.2. Network

This is for you to program the Network for IP connection.

The screenshot displays the Climax Network configuration page. The sidebar on the left lists various system settings, with 'Network' highlighted. The main content area is titled 'Network' and features two radio button options: 'Obtain an IP address automatically (DHCP)' (selected) and 'Use the following IP address'. Below these options are several input fields for manual configuration: IP Address (192.168.0.1), Subnet Mask (255.255.255.0), Default Gateway (192.168.0.254), Default DNS 1 (192.168.0.100), and Default DNS 2 (192.168.0.101). A 'DNS Flush Period' dropdown is set to 'Disable'. 'OK' and 'Reset' buttons are located at the bottom of the configuration area. The footer of the interface reads '©2016 Climax Tech. Co., Ltd.'

- **Obtain an IP address automatically (DHCP)**

If DHCP is selected, the Network will obtain an IP address automatically with a valid Network DHCP Server. Therefore, manual settings are not required.

This is only to be chosen if your Network environment supports DHCP. It will automatically generate all information.

- **Use following IP address**

You can also enter the Network information manually for IP Address, Subnet Mask, Default Gateway, Default DNS 1 and Default DNS 2.

Please make sure that you have obtained all required values according to your Network environment. Please contact your network administrator and/or internet service provider for more information.

- **DNS Flush Period**

You can set the system to clear current DNS resolution records for all entered URL settings (Reporting, Upload, XMPP...etc.) after a set time period. The system will then resolve the Domain Name again and acquire new IP address for the URL settings. This function is disabled by default.



### 7.3. Wireless

Use “Wireless” webpage to setup the panel’s wireless setting

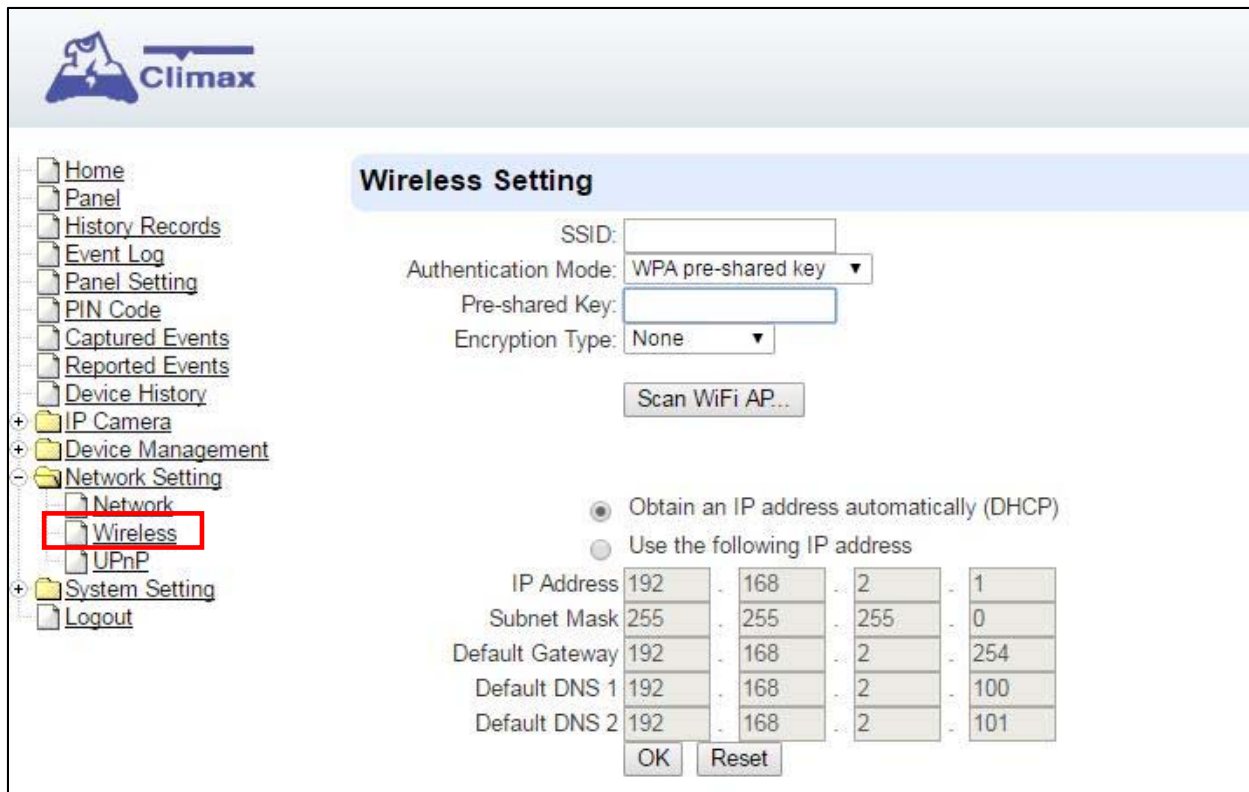

There are 3 ways you can connect to the wireless network.

1. Search for AP: Click “Scan AP” to search for available wireless network. Select the available Wireless APs from the list by clicking “Set” after AP info column and enter the required information (pre-shared key, etc.) and click the “OK” button.

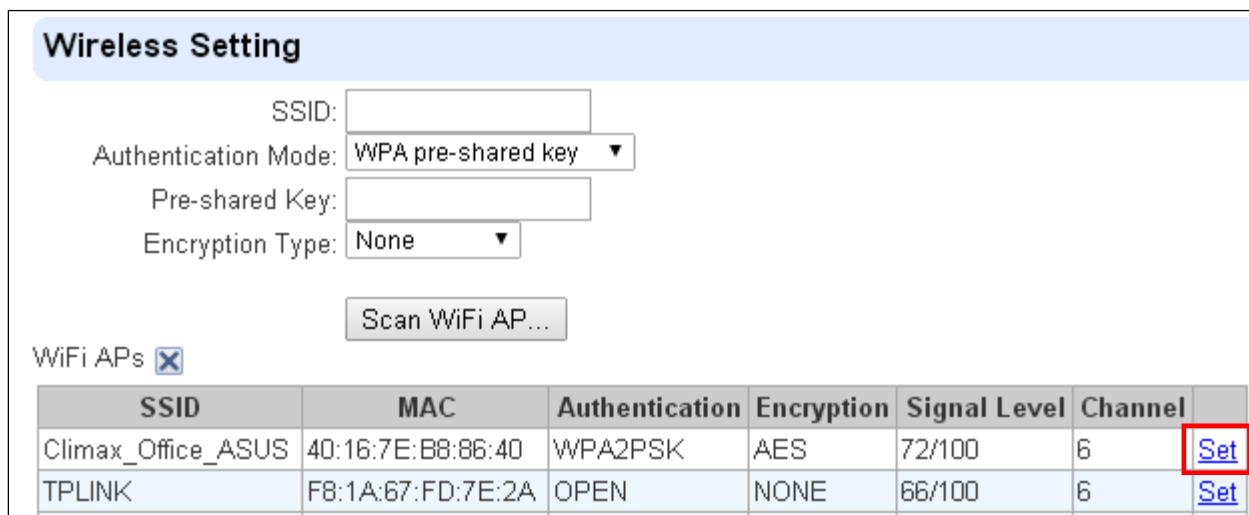

2. Enter the Wireless information manually and click “OK” to connect.

## 7.4. UPnP

UPnP is Universal Plug and Play, which opens networking architecture that leverages TCP/IP and the Web technologies to enable seamless proximity networking in addition to control and data transfer among networked devices in the home, office, and public spaces.

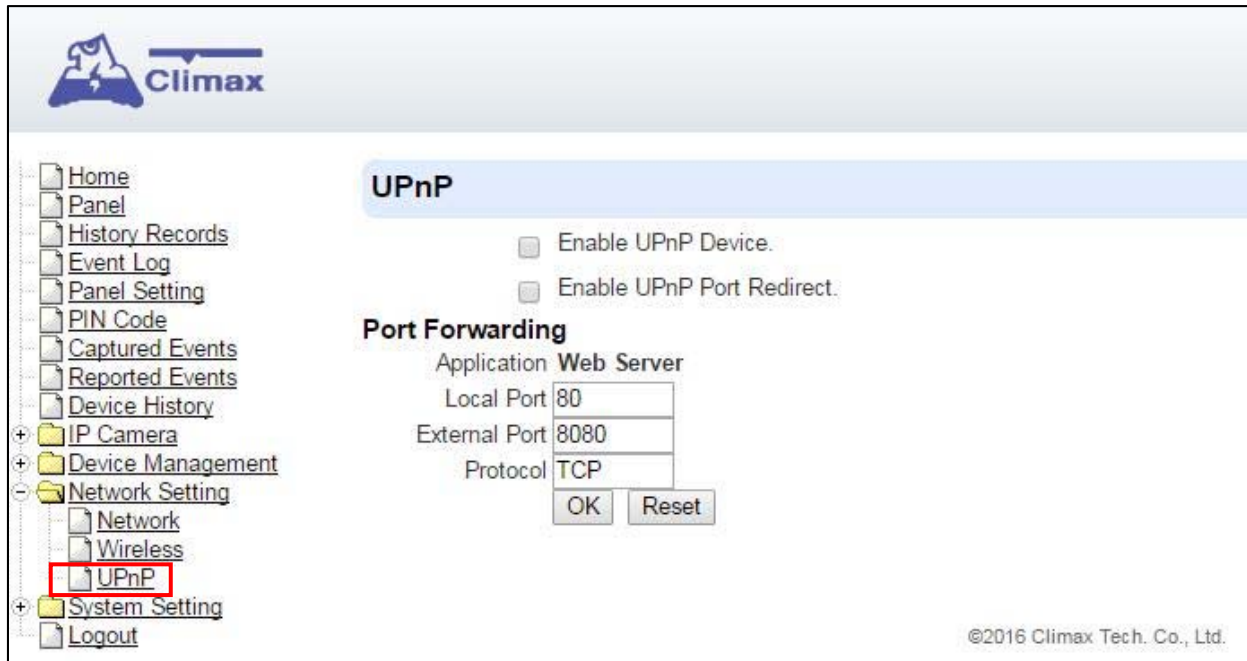

- **Enable UPnP Device:**

When enabled, you will be able to see this device via any UPnP discovery tool

- **Enable UPnP Port Redirect:**

The device will try to find an UPnP-supported router and set up the port to redirect to the router.

- **Port Forwarding:**

1. **Local Port**
2. **External Port**
3. **Protocol**

## 8. System Settings

### 8.1. Administrator Setting

For setting new Administrator Log-in Name and Password. Please note both User Name and Password are **case sensitive**.

**Step 1.** Enter the preferred **User Name**.

**Step 2.** Enter the preferred **Password** in the “New Password” field and repeat the same Password in the **Repeat Password** field.

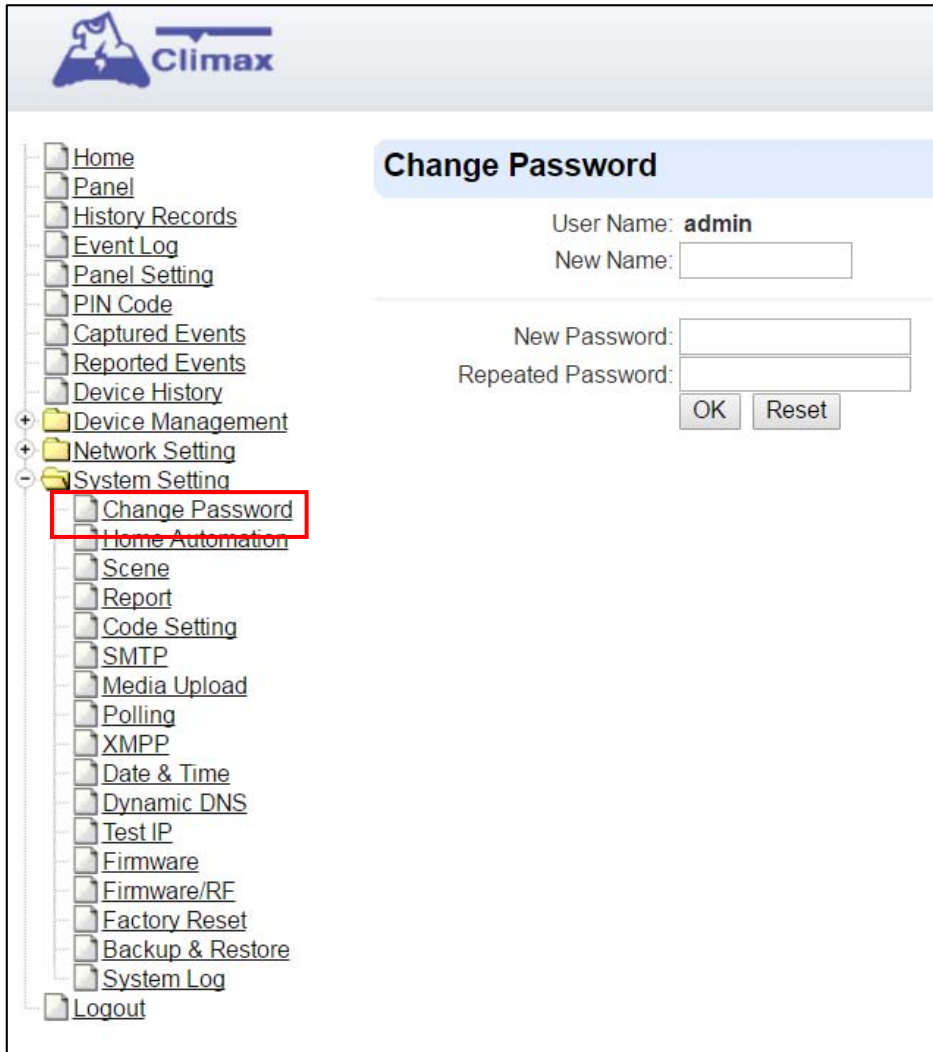

The screenshot displays the Climax web interface. On the left is a navigation tree with the following items: Home, Panel, History Records, Event Log, Panel Setting, PIN Code, Captured Events, Reported Events, Device History, Device Management, Network Setting, System Setting, Change Password (highlighted with a red box), Home Automation, Scene, Report, Code Setting, SMTP, Media Upload, Polling, XMPP, Date & Time, Dynamic DNS, Test IP, Firmware, Firmware/RF, Factory Reset, Backup & Restore, System Log, and Logout. The main content area is titled "Change Password" and contains the following fields and buttons:

- User Name: **admin**
- New Name:
- New Password:
- Repeated Password:
- Buttons:

## 8.2. Home Automation

It is used to set Home Automation rules to control sensors and home appliances. You can set up to 100 rules.

- Step 1.** Click on **Edit**.
- Step 2.** Select an operation area.
- Step 3.** Set a rule condition.
- Step 4.** Set a rule schedule.
- Step 5.** Select the corresponding action rules in the **Execution** field.

Home Automation					
#	Area	Rule Condition	Rule Schedule	Execution	Edit
1		Empty	Always	Empty	Edit
2		Empty	Always	Empty	Edit
3		Empty	Always	Empty	Edit
4		Empty	Always	Empty	Edit
5		Empty	Always	Empty	Edit
6		Empty	Always	Empty	Edit
7		Empty	Always	Empty	Edit
8		Empty	Always	Empty	Edit
9		Empty	Always	Empty	Edit
10		Empty	Always	Empty	Edit
11		Empty	Always	Empty	Edit
12		Empty	Always	Empty	Edit
13		Empty	Always	Empty	Edit
14		Empty	Always	Empty	Edit
15		Empty	Always	Empty	Edit

- **Area**  
Select an operation area.

- **Rule Condition**

The rule condition determines under which circumstances the rule should be activated.

☞ **Empty** : When set as **Empty**, the system will follow the schedule time and execution rule to respond accordingly.

☞ **Trigger Alarm** : When set as **Trigger Alarm**, if the specified alarm event (Burglar/Some/Medical/Water/Silent Panic/Panic/Emergency/Fire /CO Alarm) is triggered, the rule will be activated according to rule schedule and execution setting.

☞ **Mode Change** : When set as **Mode Change**, when the system enters specified mode, the rule will be activated according to rule schedule and execution setting.

A dropdown menu with 'Mode Change' selected and 'Disarm' as an option below it.

- ☞ **Mode Change and Exit Timer Stopped** : When set as **Mode Change and Exit Timer Stopped**, when the system changes mode to and Exit Delay Timer expires, , the rule will be activated according to rule schedule and execution setting.

A dropdown menu with 'Mode Change And Exit Timer Stopped' selected and 'Full Arm' as an option below it.

- ☞ **Mode Start Entry Timer** : When set as **Mode Start Entry Timer**, when the system begins to countdown Entry Delay, the rule will be activated according to rule schedule and execution setting.

A dropdown menu with 'Mode Start Entry Timer' selected and 'Full Arm' as an option below it.

- ☞ **Temperature Below** : When set as **Temperature Below**, if the temperature detected by specified temperature sensor drops below set threshold, the rule will be activated according to rule schedule and execution setting.

A dropdown menu with 'Temperature Below' selected and 'Zone 1 : 28 °C' as an option below it.

- ☞ **Temperature Above** : When set as **Temperature Above**, if the temperature detected by specified temperature sensor exceeds set threshold, the rule will be activated according to rule schedule and execution setting.

A dropdown menu with 'Temperature Above' selected and 'Zone 1 : 26 °C' as an option below it.

- ☞ **Temperature Between** : When set as **Temperature Between**, if the temperature detected by specified temperature sensor falls within the range specified, the rule will be activated according to rule schedule and execution setting.

A dropdown menu with 'Temperature Between' selected and 'Zone 1 : 25 °C ~ 28 °C' as an option below it.

- ☞ **High Power Consumption** : When set as **Power Consumption Above**, if the power output watt from a specific Power Switch exceeds, the rule will be activated according to rule schedule and execution setting.

A dropdown menu with 'Power Consumption Above' selected and 'Zone 1 : 1000W' as an option below it.

- ☞ **Humidity Above** : When set as **Humidity Above**,if the humidity reading from specified room sensor rises above the level specified, the rule will be activated according to rule schedule and execution setting.

A dropdown menu with 'Humidity Above' selected and 'Zone 1 : 0%' as an option below it.

- ☞ **Humidity Below** : When set as **Humidity Below**,if the humidity reading from specified room sensor falls below the level specified, the rule will be activated according to rule schedule and execution setting.

- ☞ **LUX Between** : When set as **LUX Between**, if the lux reading from specified light sensor falls below the level specified, the rule will be activated according to rule schedule and execution setting.

- ☞ **Random** : The **Random** condition must be used along with Rule Schedule setting. Set a percentage from 1 to 10%. When the panel time reaches programmed Rule Schedule time. The Panel will activate rule according to set chance.

**Example:** If set as 10%, whenever the panel reaches programmed Rule Schedule time, there will be a 10% chance the rule is activated.

## ● Rule Schedule

- ☞ **Always** : When set as **Always**, the rule can be activated anytime.
- ☞ **Schedule Once** : When set as **Schedule Once**, the system will follow the rule condition and execute rule according to the exact date and time specified..

- ☞ **Schedule Every Month** : When set as **Schedule Every Month**, the system will follow the rule condition and execute rule according to date and time specified every month.

- ☞ **Schedule Every Week** : When set as **Schedule Every Week**, the system will follow the rule condition and execute rule according to day of the week and time specified every week.

- ☞ **Schedule Every Day** : When set as **Schedule Every Day**, the system will follow the rule condition and execute rule according to time specified every day

## ● Execution

Execution is the actual action performed by Control Panel when both Rule Condition and Rule Schedule requirements are met

- ☞ **Zone Switch Off:** Turn on the Power Switch at specified zone.

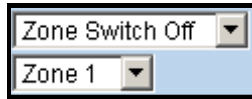

☞ **Zone Switch On** : Turn on the Power Switch at specified zone.

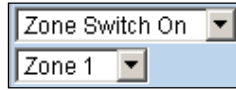

☞ **Zone Switch On For** : Turn on the Power Switch at specified zone for a set duration.

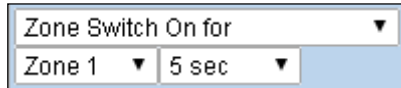

☞ **Zone Switch Level**: Change the power output level for Dimmer at specified zone.



☞ **Zone Switch Toggle** : Toggle on/off the Power Switch at specified zone.

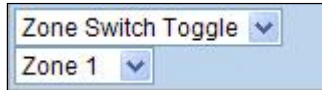

☞ **Group Switch Off** : Turn off all Power Switches assigned to specified group.

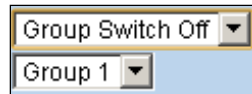

☞ **Group Switch On** : Turn on all Power Switches assigned to specified group.

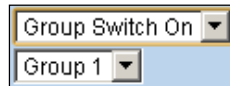

☞ **Group Switch On For** : Turn on all Power Switches assigned to specified group for a set duration.

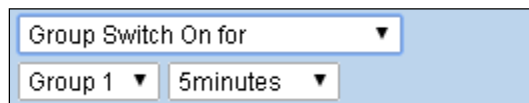

☞ **Mode Change** : The system will change to the mode as you specified.



☞ **Request Image** : The PIR Camera in specified zone will take a picture.

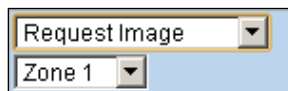

☞ **Request Image (All)** : All PIR Cameras in the system will take a picture.

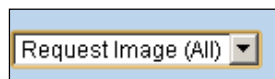

☞ **Request Image (No Flash)**: The PIR Camera in specified zone will take a picture without activating its LED flash.

☞ **Request Image (All, No Flash)**: All PIR Cameras in the system will take a picture without activating LED Flash.

☞ **Request Video**: The PIR Video Camera or IP Camera in specified zone will record a video.

☞ **Request Video (All)**: All PIR Video Cameras and IP Cameras in the system will record a video.

☞ **Setup UPIC**: The UPIC and specified zone will transmit Off/Heat/Cool command to the air conditioner as programmed.

☞ **Hue Control**: Adjust the hue and saturation of the Philips Hue at sepecified zone as programmed.

☞ **Trigger Alarm**: Choose to activate one of the following alarms: High Temperature Alarm, Low Temperature Alarm, High Power Consumption Alarm, High Humidity Alarm and Low Humidity Alarm

☞ **Apply Scene**: the system will execute preprogrammed Scene number. Please refer to **8.3. Scene** for detail.



### 8.3. Scene

The Scene setting allows you to customize a series of actions with your devices, such as Power Switch control, image/video request, mode change and trigger alarm. The programmed scene can be set to activated when a device is triggered. (See 5.1.3. **Edit Devices**), or when a Home Automation Rule is executed. (See 8.2. **Home Automation**) For example, you can set a scene to control multiple lightings, then set your Remote Controller to activate the scene when the button is pressed, or set a Home Automation Rule to activate the scene.

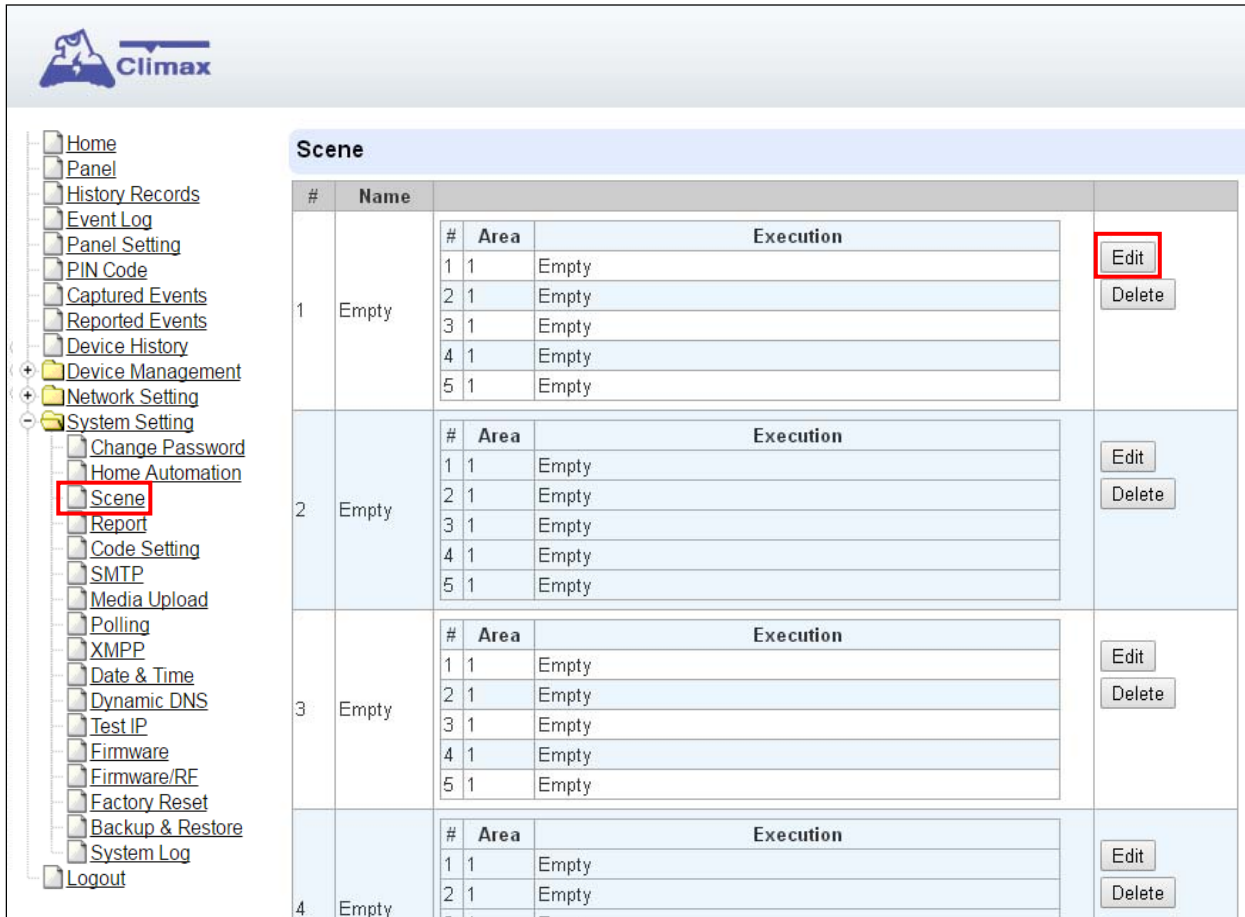

**Step 1.** Click on **Edit**.

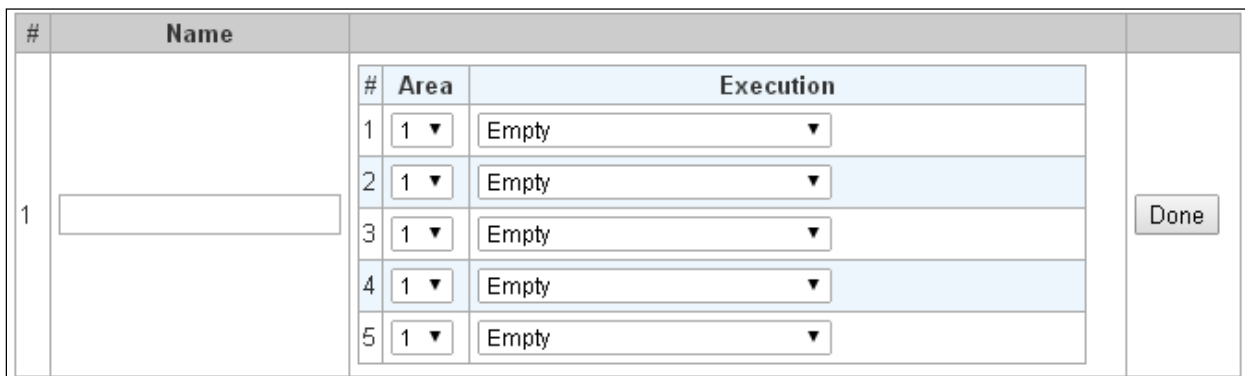

**Step 2.** Enter a name for the scene.

**Step 3.** Select an Area

**Step 4.** Select an action to be executed when the scene is activated. Refer to the Rule Execution section in 8.2. **Home Automation** for detail.

- Step 5.** Repeat Step 2-3 to setup the execution you wanted. As many as 5 executions can be included in one scene.
- Step 6.** Click **“Done”**.
- Step 7.** Click **“OK”** at bottom of webpage to confirm the new scene setting..

## 8.4. Reporting

This is used for installer to program/ set all requirements for reporting purposes.

Report							
#	Reporting URL	Level	Group 1	Group 2	Group 3	Group 4	Group 5
1		All events ▼	<input type="radio"/>	<input type="radio"/>	<input type="radio"/>	<input type="radio"/>	<input type="radio"/>
2		All events ▼	<input type="radio"/>	<input type="radio"/>	<input type="radio"/>	<input type="radio"/>	<input type="radio"/>
3		All events ▼	<input type="radio"/>	<input type="radio"/>	<input type="radio"/>	<input type="radio"/>	<input type="radio"/>
4		All events ▼	<input type="radio"/>	<input type="radio"/>	<input type="radio"/>	<input type="radio"/>	<input type="radio"/>
5		All events ▼	<input type="radio"/>	<input type="radio"/>	<input type="radio"/>	<input type="radio"/>	<input type="radio"/>
6		All events ▼	<input type="radio"/>	<input type="radio"/>	<input type="radio"/>	<input type="radio"/>	<input type="radio"/>
7		All events ▼	<input type="radio"/>	<input type="radio"/>	<input type="radio"/>	<input type="radio"/>	<input type="radio"/>
8		All events ▼	<input type="radio"/>	<input type="radio"/>	<input type="radio"/>	<input type="radio"/>	<input type="radio"/>
9		All events ▼	<input type="radio"/>	<input type="radio"/>	<input type="radio"/>	<input type="radio"/>	<input type="radio"/>
10		All events ▼	<input type="radio"/>	<input type="radio"/>	<input type="radio"/>	<input type="radio"/>	<input type="radio"/>
11		All events ▼	<input type="radio"/>	<input type="radio"/>	<input type="radio"/>	<input type="radio"/>	<input type="radio"/>
12		All events ▼	<input type="radio"/>	<input type="radio"/>	<input type="radio"/>	<input type="radio"/>	<input type="radio"/>
13		All events ▼	<input type="radio"/>	<input type="radio"/>	<input type="radio"/>	<input type="radio"/>	<input type="radio"/>
14		All events ▼	<input type="radio"/>	<input type="radio"/>	<input type="radio"/>	<input type="radio"/>	<input type="radio"/>
15		All events ▼	<input type="radio"/>	<input type="radio"/>	<input type="radio"/>	<input type="radio"/>	<input type="radio"/>
16		All events ▼	<input type="radio"/>	<input type="radio"/>	<input type="radio"/>	<input type="radio"/>	<input type="radio"/>
17		All events ▼	<input type="radio"/>	<input type="radio"/>	<input type="radio"/>	<input type="radio"/>	<input type="radio"/>
18		All events ▼	<input type="radio"/>	<input type="radio"/>	<input type="radio"/>	<input type="radio"/>	<input type="radio"/>
19		All events ▼	<input type="radio"/>	<input type="radio"/>	<input type="radio"/>	<input type="radio"/>	<input type="radio"/>
20		All events ▼	<input type="radio"/>	<input type="radio"/>	<input type="radio"/>	<input type="radio"/>	<input type="radio"/>
			Essential	Essential ▼	Essential ▼	Essential ▼	Essential ▼
			5 Retry ▼	5 Retry ▼	5 Retry ▼	5 Retry ▼	5 Retry ▼

- **Reporting URL**

This is used for installer to program report destinations.

- 1 Climax CID protocol via IP**

Format: ip://(Account Number)@(server ip):(port)/CID

Example: ip://1234@54.183.182.247:8080/CID

- 2 SIA DC-09 protocol via IP**

Format: ip://(Account Number)@(server ip):(port)/SIA

Example: ip://1234@54.183.182.247:8080/SIA

- 3 SIA DC-09 protocol via IP with AES encryption**

Format: ip://(Account Number)@(server ip):(port)/SIA/KEY/(128,196 or 256 bits Key)

Example:

ip://1234@54.183.182.247:8080/SIA/KEY/ 4A46321737F890F654D632103F86B4F3

- 4 SIA DC-09 protocol using CID event code via IP**

Format: ip://(Account Number)@(server ip):(port)/CID\_SIA

Example: ip://1234@54.183.182.247:8080/CID\_SIA

- 5 SIA DC-09 protocol using CID event code via IP, with HEX encryption.**

Format: ip://(Account Number)@(server ip):(port)/CID\_SIA/KEY/(HEX)

Example:

ip://1234@54.183.182.247:8080/CID\_SIA/KEY/4A46321737F890F654D632103F86B4  
F3

## 6 CSV protocol via IP

Format: ip//(Account Number)@(server ip):(port)/CSV

Example: ip://1234@54.183.182.247:8080/CSV

## 7 CSV protocol via IP including username and password

Format: ip//(Account Number)@(server ip):(port)/CSV/User/Pasword

Example: ip://1234@54.183.182.247:8080/CSV/abcd/1357

## 8 Email

Format: mailto:user@example.com

Example: mailto:john@gmail.com

### ● Level

Select a reporting condition:

All events: The system will report all events to this destination.

Alarm events: The system will only report alarm event to this destination.

Status events: The system will only report status event(non-alarm events) to this destination.

### ● Group

Select a group for your report destination The system will make report according to the following principle:

- ☞ Group with higher priority will be reported first: Ex: Group 1 → Group 2 → Group 3....
- ☞ If reporting to the first destination in a group fails, the system will move on to the next report destination in the group.
- ☞ If reporting to one of the report destinations in a group is successful, the system will consider reporting to this group successful and stop reporting to rest of the destinations in the group. It will then move on to report to the next group.
- ☞ If reporting to all destinations in a group fails, the system will retry report to group according to retry times set below. If reporting is still unsuccessful after retries, the system will move on to report the the next group according to Essential/Optional setting below.
- ☞ After completing a round of reporting (From Group 1 → Group 2 ..... →Group5), If there is any group set as Essential which has not received report successfully, the system will restart the reporting cycle to retry reporting until every group set as Essential is reported successfully.

### ● Essential/Optional

**Essential**: the system will report to all groups set as **Essential**. The system will never give up trying to report to any group set as Essential until at least one of the destinations in every Essential group successfully receives the report. Group 1 is always set as **Essential** and cannot be changed.

**Optional**: The system will only report to group set as **Optional** when reporting to its previous group fails. For example: if Group 3 is set is optional, the Control Panel

will only report to Group 3 if reporting to Group 2 fails.

- **1 Retry/ 3 Retry/ 5 Retry/ 10 Retry/ 99 Retry:**

If reporting to all destinations in a group fails, the system will retry reporting to the group according to the retries times set here.

<NOTE>

- ☞ When the panel is registered into Climax's Home Portal Server, URL1 will be filled in with Home Portal Server report information. Do not change the information once registration is complete or reporting to Home Portal Server may encounter error.
- ☞ After registering the panel in Home Portal Server, if you wish to set more reporting destination, the new report destination should be set to different group than URL1 otherwise it may not be able to receive report successfully.

## 8.5. Code Settings

The Duress Code, Master Code & Temporary Code adds the flexibility of different security level for operation in **Code Settings** menu.

**Step 1.** Key in your preferred 4 digit **Installer Code**, **Duress Code**, **Master Code**, and/or **Temporary Code**.

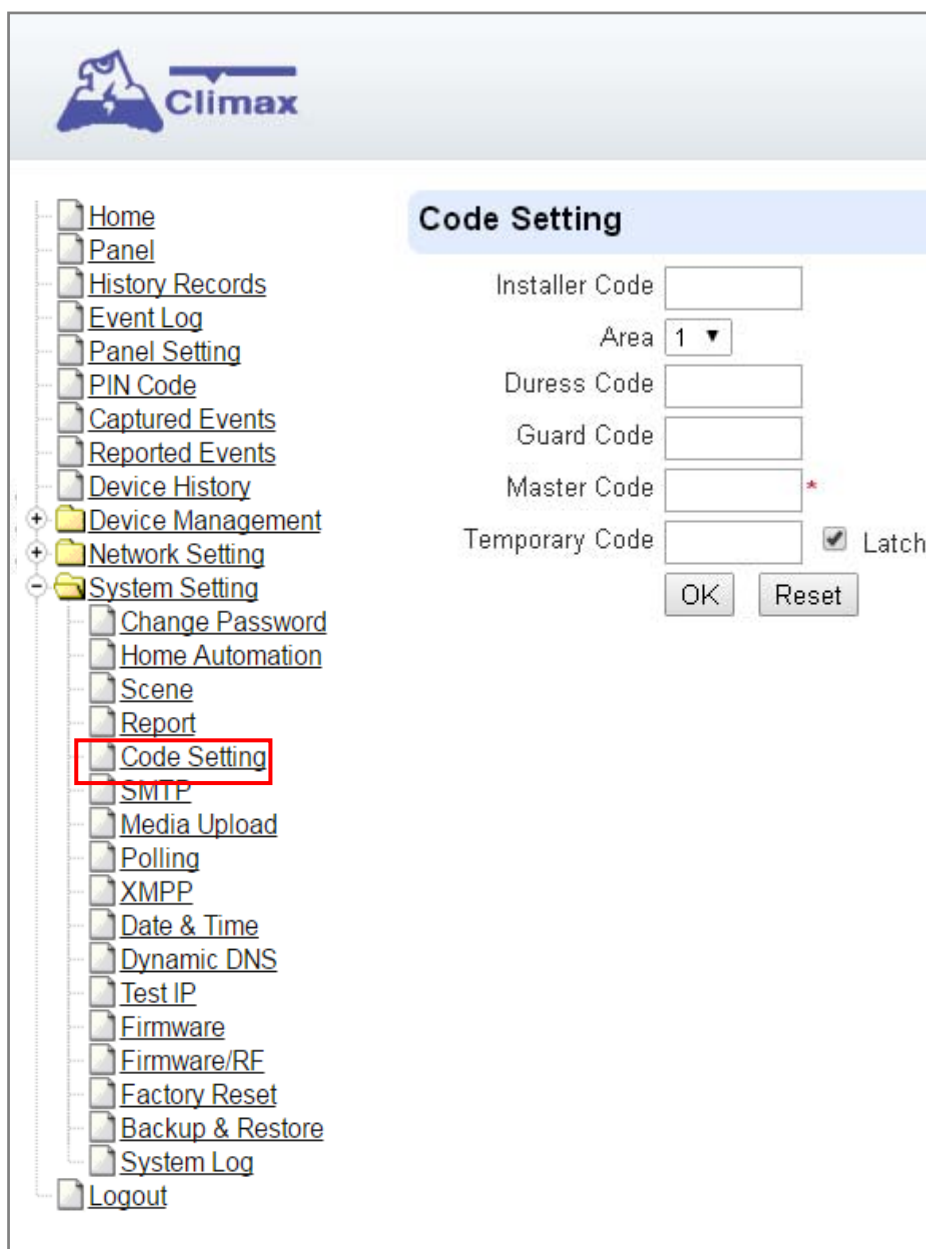

The screenshot displays the Climax web interface. On the left is a navigation tree with the following items: Home, Panel, History Records, Event Log, Panel Setting, PIN Code, Captured Events, Reported Events, Device History, Device Management, Network Setting, System Setting (expanded), Change Password, Home Automation, Scene, Report, Code Setting (highlighted with a red box), SMTP, Media Upload, Polling, XMPP, Date & Time, Dynamic DNS, Test IP, Firmware, Firmware/RF, Factory Reset, Backup & Restore, System Log, and Logout. The main content area is titled 'Code Setting' and contains the following fields: Installer Code (text input), Area (dropdown menu showing '1'), Duress Code (text input), Guard Code (text input), Master Code (text input with an asterisk), and Temporary Code (text input with a checked 'Latch' checkbox). At the bottom of the form are 'OK' and 'Reset' buttons.

**Step 2.** You can also choose to have Latch Option On / Off for Temporary Code by tick the Latch Option box and press **OK** to confirm the settings.

- **Installer Code**

The Installer Code is used for SMS Remote Programming, when sending a remote programming message, the user needs to enter Installer Code in the message to be able to program the system. The default Installer code is: **7982**.

- **Area**

Each Area has different Duress Code, Master Code, and Temporary Code. Select the Area to program the code setting in this area.

- **Duress Code**

The Duress Code is designed for transmitting a secret & silence alarm.

When Duress Code is used for accessing the system, the Control Panel will report a secret alarm message without sounding the siren to the Central Monitoring Station to indicate of a **Duress Situation in Progress**.

The Duress Code consists of 4 digits and is not activated as default by the factory.

- **Guard Code**

The Guard Code is designed for security patrol personnel to arm/disarm the system. It can be set the same as a User PIN Code.

The Guard Code consists of 4 digits and is not activated as default by the factory.

- **Master Code**

This function is currently disabled.

- **Temporary Code**

Temporary Code is also used to arm/disarm the system, but it is for a temporary user. The temporary Code is **ONLY** valid for one-access per arming and disarming. Afterwards, the Temporary Code will be automatically erased and needs to be reset for a new Temporary user.

The Temporary Code consists of 4 digits and is not activated as default by the factory.

- **Latch Option**

This is to program the Latch Key Reporting feature for Temporary Code. Please click the box to select the options.

Latch → **Latch Report ON** = Whenever the system is armed, home/ day home/ night home armed or disarmed, the Panel will transmitt Contact ID code / SMS message / GPRS reporting (according to pre-setting) to notify the Central Monitoring Station.

Latch → **Latch Reprot OFF** = Whenever the system is armed, home/ day home/ night home armed or disarmed, the Panel will NOT transmit reporting(s) to notify the Central Monitoring Station.

- **Delete**

Except Master Code which can't be disabled in any way, Temporary and Duress Code can be disabled by cleaning the code box and leaving the box as blank.

## 8.6. SMTP Setting

Program the mail server related settings. The email account you set here would be used to send report for events or picture and video clip captured by PIR Camera and PIR Video Camera.

The screenshot shows the Climax web interface. On the left is a navigation menu with the following items: Home, Panel, History Records, Event Log, Panel Setting, PIN Code, Captured Events, Reported Events, Device History, Device Management, Network Setting, System Setting (expanded), Change Password, Home Automation, Scene, Report, Code Setting, SMTP (highlighted with a red box), Media Upload, Polling, XMPP, Date & Time, Dynamic DNS, Test IP, Firmware, Firmware/RF, Factory Reset, Backup & Restore, System Log, and Logout. The main content area is titled 'SMTP Setting' and contains the following fields and controls:

- Server:
- Port:
- User:
- Password:
- From:
- Using TLS/SSL encrypted channels (Secure SMTP)
- OK  Reset

Below this is a section titled 'Test E-Mail' with the following field and controls:

- Receiver:
- OK  Reset

**Step 1.** Enter the following settings:

- **Server:** set the mail server (max. 60 digits/alphabets).
- **Port:** set the port number (max. 5 digits/alphabets).
- **User:** set the mail account name (max. 30 digits/alphabets).
- **Password:** set the password corresponding to the mail account name (max. 30 digits/alphabets).
- **From:** set the email address according to your mail sever and account name. If your mail server supports other email address, you can enter the email address here. (max. 30 digits/alphabets).
- **Using TLS/SSL encrypted channels (Secure SMTP):** If your mail server uses TLS or SSL encryption method for secure transfer, please click the box to enable the setting

**Step 2.** Click **OK** to confirm the setting.



## 8.7. Media Upload

The system can deliver captured images and video clips captured by PIR Cameras and PIR Video Camera to cell phone, email or ftp.

**Media Upload**

URL 1:

URL 2:

URL 3:

URL 4:

URL 5:

Prefix:

Delete events after uploaded.

Note: 1. Upload via IP (Ethernet or GPRS) in FTP protocol, ex: ftp://user:password@server/path  
2. Upload via IP (Ethernet or GPRS) in HTTP protocol, ex: http://server/path  
3. Mail via IP (Ethernet or GPRS), ex: mailto: user@server  
4. Send MMS e-mail via GPRS, ex: mms: user@mail.server  
5. Send MMS via GPRS, ex: mms: telephone

©2014 Climax Tech. Co., Ltd.

- **FTP:** <ftp://user.password@server/path>
- **HTTP:** <http://ip:port/path>
- **Email:** <mailto:user@server> (transmitting an alarm image over Ethernet)
- **MMS via Telephone:** mms: telephone number
- **MMS via GPRS:** mms: [user@mail.server](mms:user@mail.server) (transmitting an alarm image over MMS)

### <NOTE>

- ☞ If “**Deleted events after uploaded**” is checked, the system will automatically clear all captured images which are displayed in the Captured Events menu after it successfully sends out those captured images to preset reporting destinations.

## 8.8. Polling

The polling function enables the Control Panel to query the destination you set (URL1 or URL2) in turn as to whether it has any data to transmit.

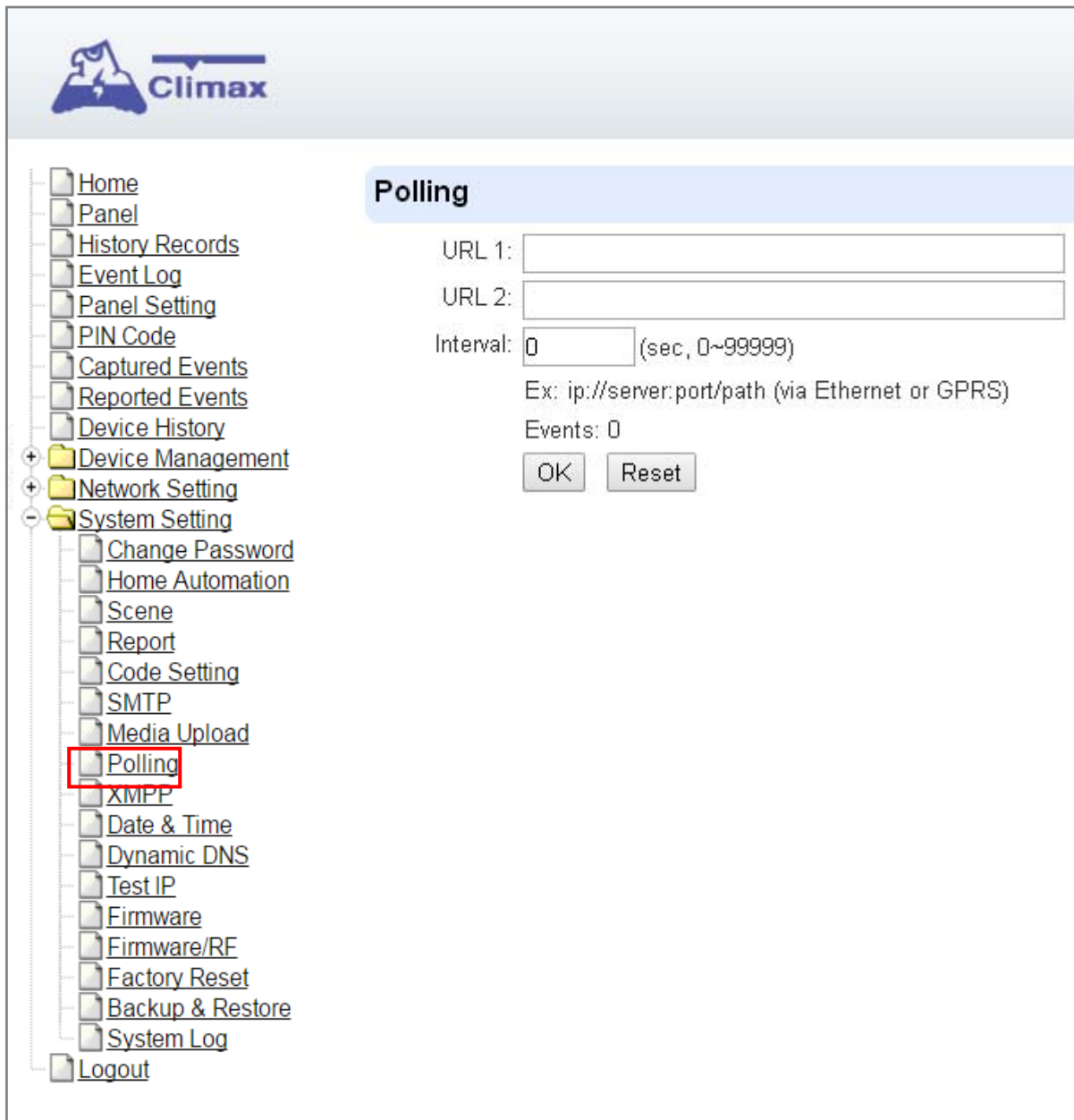

The screenshot shows the Climax Control Panel interface. On the left is a navigation tree with the following items: Home, Panel, History Records, Event Log, Panel Setting, PIN Code, Captured Events, Reported Events, Device History, Device Management (expanded), Network Setting (expanded), System Setting (expanded), Change Password, Home Automation, Scene, Report, Code Setting, SMTP, Media Upload, Polling (highlighted with a red box), XMPP, Date & Time, Dynamic DNS, Test IP, Firmware, Firmware/RF, Factory Reset, Backup & Restore, System Log, and Logout. The main content area is titled "Polling" and contains the following fields and controls:

- URL 1:
- URL 2:
- Interval:  (sec, 0~99999)
- Ex: ip://server:port/path (via Ethernet or GPRS)
- Events:
- OK
- Reset

- **URL/URL2:** ip://server:port/path
- **Interval :** interval time of polling

## 8.9. XMPP

XMPP setting enables the Control Panel to query the set destination. This setting is required for the Control Panel to connect to Climax's Home Portal Server for remote control. If the panel is disconnected from the server, it will retry connection every 3 minutes.

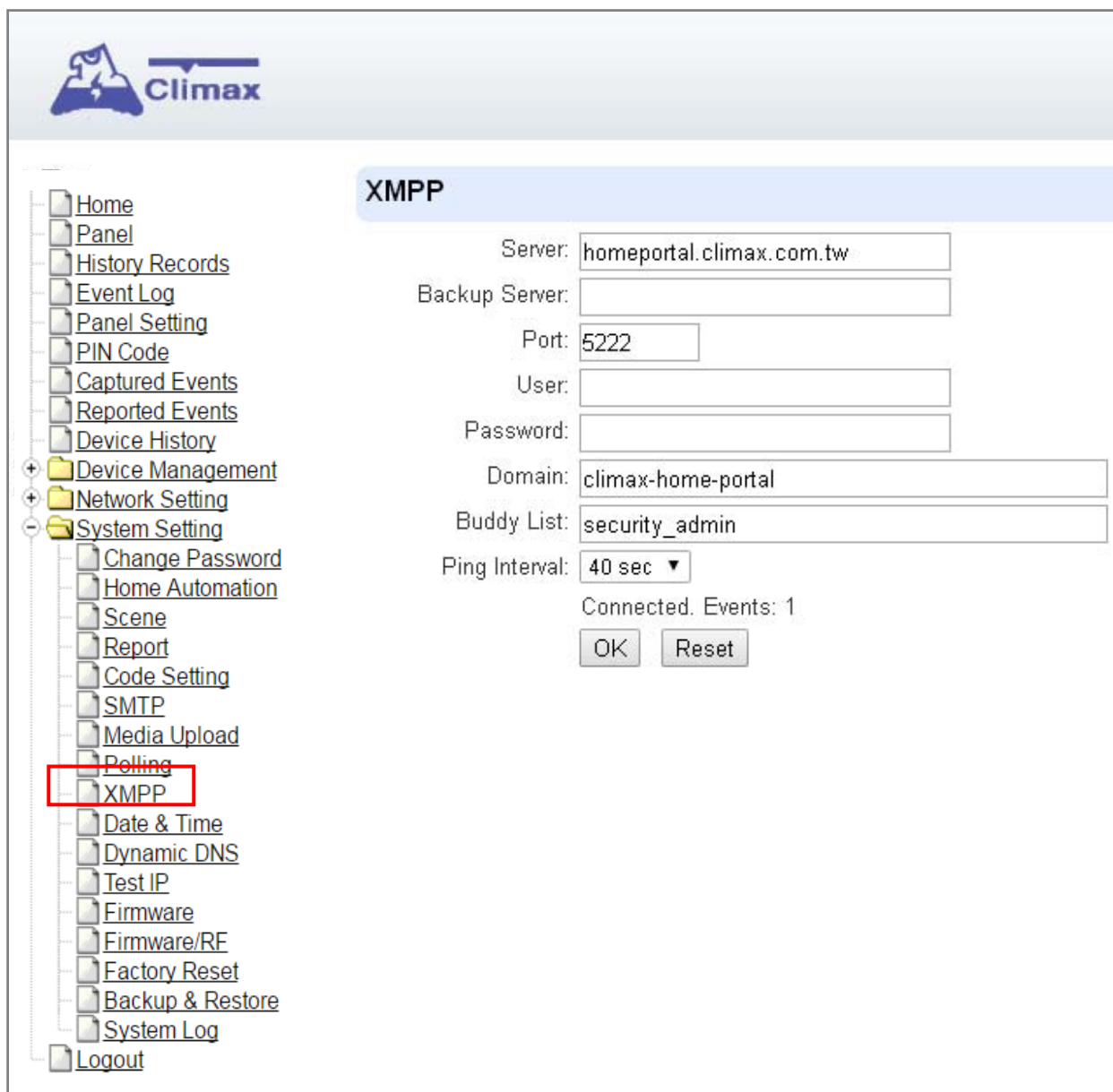

The screenshot displays the Climax control panel interface. On the left is a navigation tree with the following items: Home, Panel, History Records, Event Log, Panel Setting, PIN Code, Captured Events, Reported Events, Device History, Device Management, Network Setting, System Setting (expanded), Change Password, Home Automation, Scene, Report, Code Setting, SMTP, Media Upload, Polling, XMPP (highlighted with a red box), Date & Time, Dynamic DNS, Test IP, Firmware, Firmware/RF, Factory Reset, Backup & Restore, System Log, and Logout. The main content area is titled 'XMPP' and contains the following configuration fields:

- Server: homeportal.climax.com.tw
- Backup Server: (empty)
- Port: 5222
- User: (empty)
- Password: (empty)
- Domain: climax-home-portal
- Buddy List: security\_admin
- Ping Interval: 40 sec (dropdown menu)

Below the fields, it shows 'Connected. Events: 1' and two buttons: 'OK' and 'Reset'.

- **Server:** server address
- **Port:** server's port number
- **User:** authorized user account name
- **Password:** authorized user password
- **Domain:** domain address
- **Buddy List:** contact destination
- **Ping Interval:** server connection test interval

## 8.10. Date & Time

Program the current **Date & Time** and set automatic synchronization with internet time server.

The screenshot shows the Climax web interface. On the left is a navigation menu with the following items: Home, Panel, History Records, Event Log, Panel Setting, PIN Code, Captured Events, Reported Events, Device History, Device Management, Network Setting, System Setting (highlighted), Change Password, Home Automation, Scene, Report, Code Setting, SMTP, Media Upload, Polling, XMPP, Date & Time (highlighted with a red box), Dynamic DNS, Test IP, Firmware, Firmware/RF, Factory Reset, Backup & Restore, System Log, and Logout. The main content area has three sections: **Date & Time** with fields for Date (2014/05/08) and Time (11:43), **Time Zone** with a dropdown menu set to (GMT+00:00) Greenwich Mean Time: Dublin, Edinburgh, Lisbon, London, and **Internet Time** with a checkbox for 'Automatically synchronize with an Internet time server.' and a dropdown menu for 'Server' set to pool.ntp.org. There are OK and Reset buttons for each section. A copyright notice '©2014 Climax Tech. Co., Ltd.' is visible at the bottom right.

- **Date & Time:** set current month, date and time.
- **Time Zone:** choose your time zone, and then the system will calculate the daylight saving time automatically (if necessary).
- **Internet Time:** the system will automatically synchronize with an internet time server. Tick the check box to enable this function. Available options: [pool.ntp.gov](http://pool.ntp.gov), [time.nist.gov](http://time.nist.gov) and [tick.usno.navy.mil](http://tick.usno.navy.mil).

## 8.11. Dynamic DNS

This page is used to provide you the Control Panel's current public IP address.

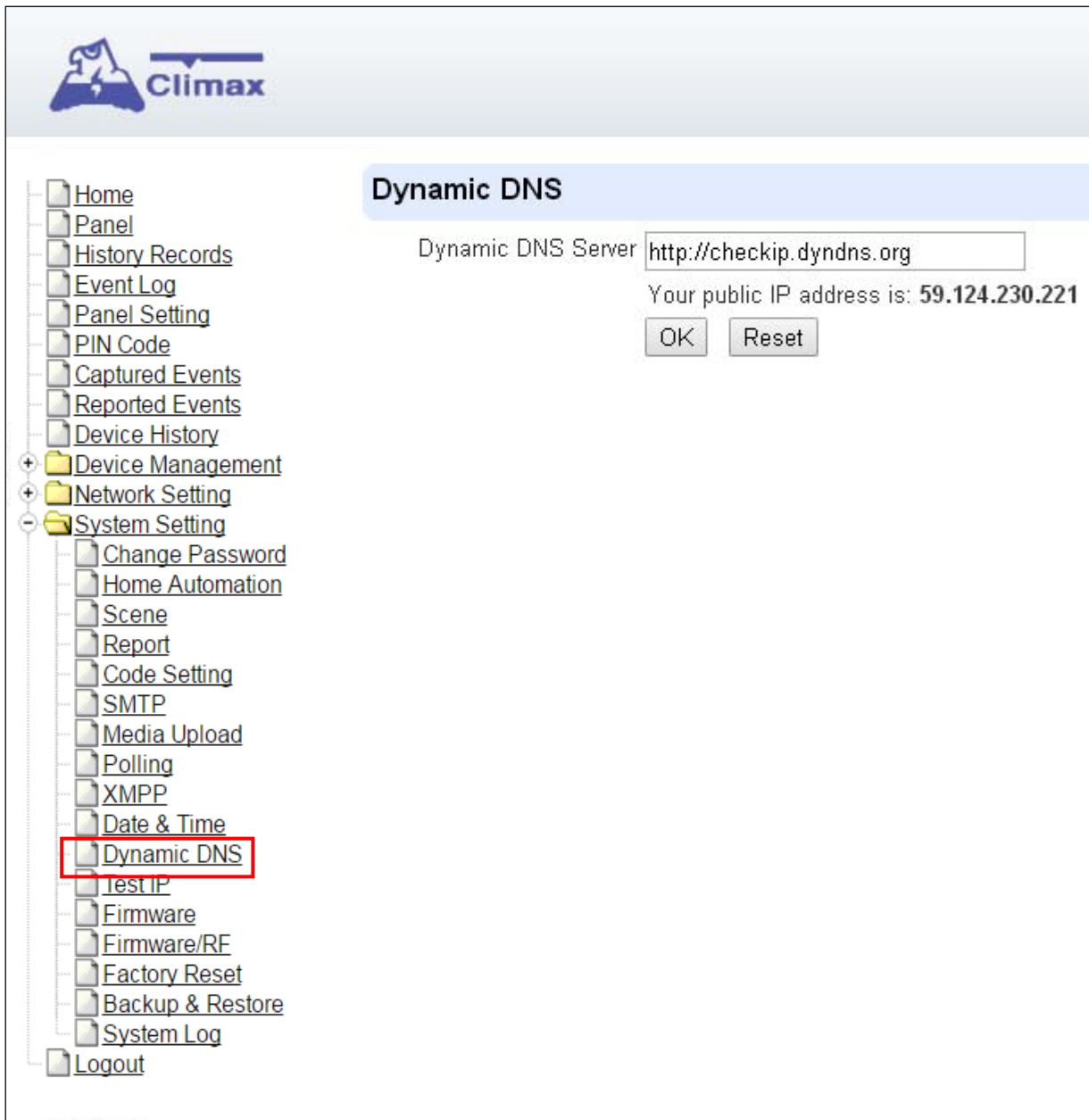

The screenshot shows the Climax Control Panel interface. On the left is a navigation menu with items like Home, Panel, History Records, Event Log, Panel Setting, PIN Code, Captured Events, Reported Events, Device History, Device Management, Network Setting, System Setting, Change Password, Home Automation, Scene, Report, Code Setting, SMTP, Media Upload, Polling, XMPP, Date & Time, Dynamic DNS (highlighted with a red box), Test IP, Firmware, Firmware/RF, Factory Reset, Backup & Restore, System Log, and Logout. The main content area is titled "Dynamic DNS" and contains the following information:

- Dynamic DNS Server:
- Your public IP address is: **59.124.230.221**
- Buttons:

- **Dynamic DNS Server:** <http://checkip.dyndns.org>

## 8.12. Test IP

This is for you to test the Control Panel internet connection.

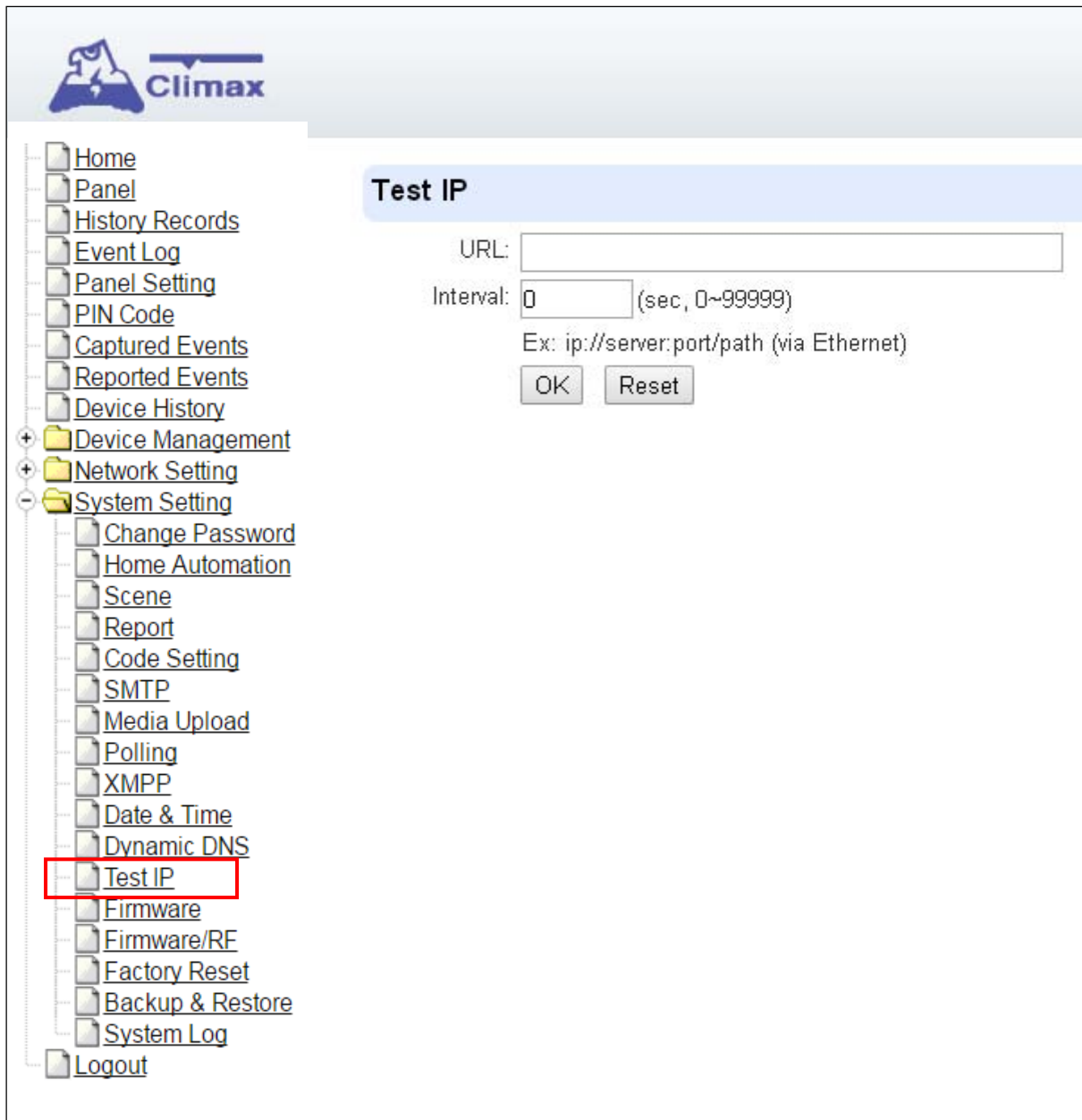

**Step 1.** Enter the URL destination you want to test connection to.

**Step 2.** Enter the test interval.

**Step 3.** Click “OK”

You can check the test connect result in **System Log**.

## 8.13. Firmware Upgrade

You can update the firmware via this web page.

**Step 1.** Click on “**Browse**” and locate the latest firmware file (“**unzipped image.bin**” file) in your PC.

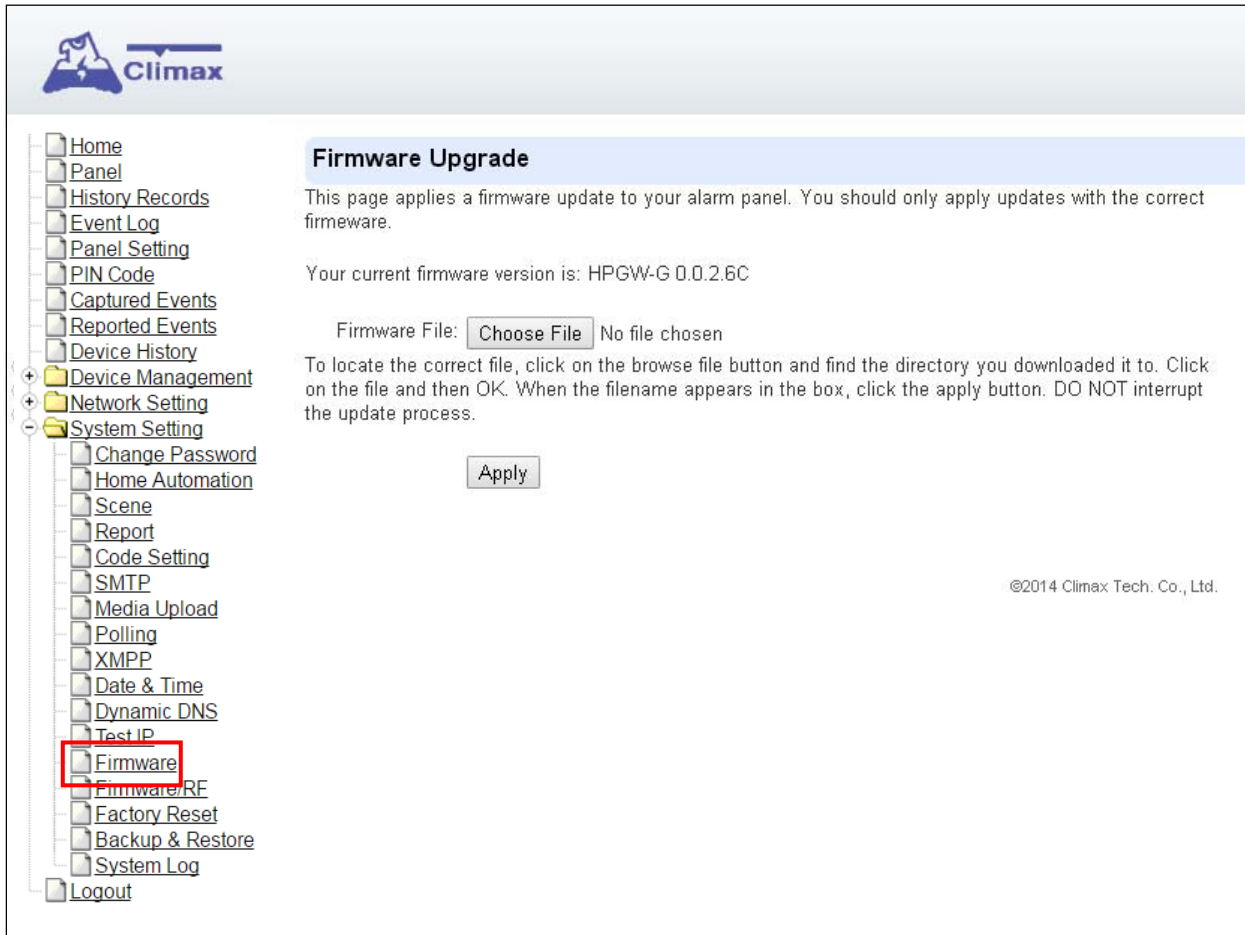

The screenshot displays the Climax web interface for the Firmware Upgrade process. On the left, a navigation tree lists various system settings, with 'Firmware' highlighted in red. The main content area is titled 'Firmware Upgrade' and contains the following text:

This page applies a firmware update to your alarm panel. You should only apply updates with the correct firmware.

Your current firmware version is: HPGW-G 0.0.2.6C

Firmware File:  No file chosen

To locate the correct file, click on the browse file button and find the directory you downloaded it to. Click on the file and then OK. When the filename appears in the box, click the apply button. DO NOT interrupt the update process.

©2014 Climax Tech. Co., Ltd.

**Step 2.** Press “**Apply**” to upload the latest firmware to Control Panel

**Step 3.** Wait for 1 min and do NOT power off during this time.

**Step 4.** Once Firmware upgrading is complete, the Control Panel will reboot automatically

## 8.14. RF Firmware Upgrade

You can update the Control Panel's RF firmware via this web page.

**Step 1.** Click on **"Browse"** and locate the latest firmware file ("**unzipped image.bin**" file) in your PC.

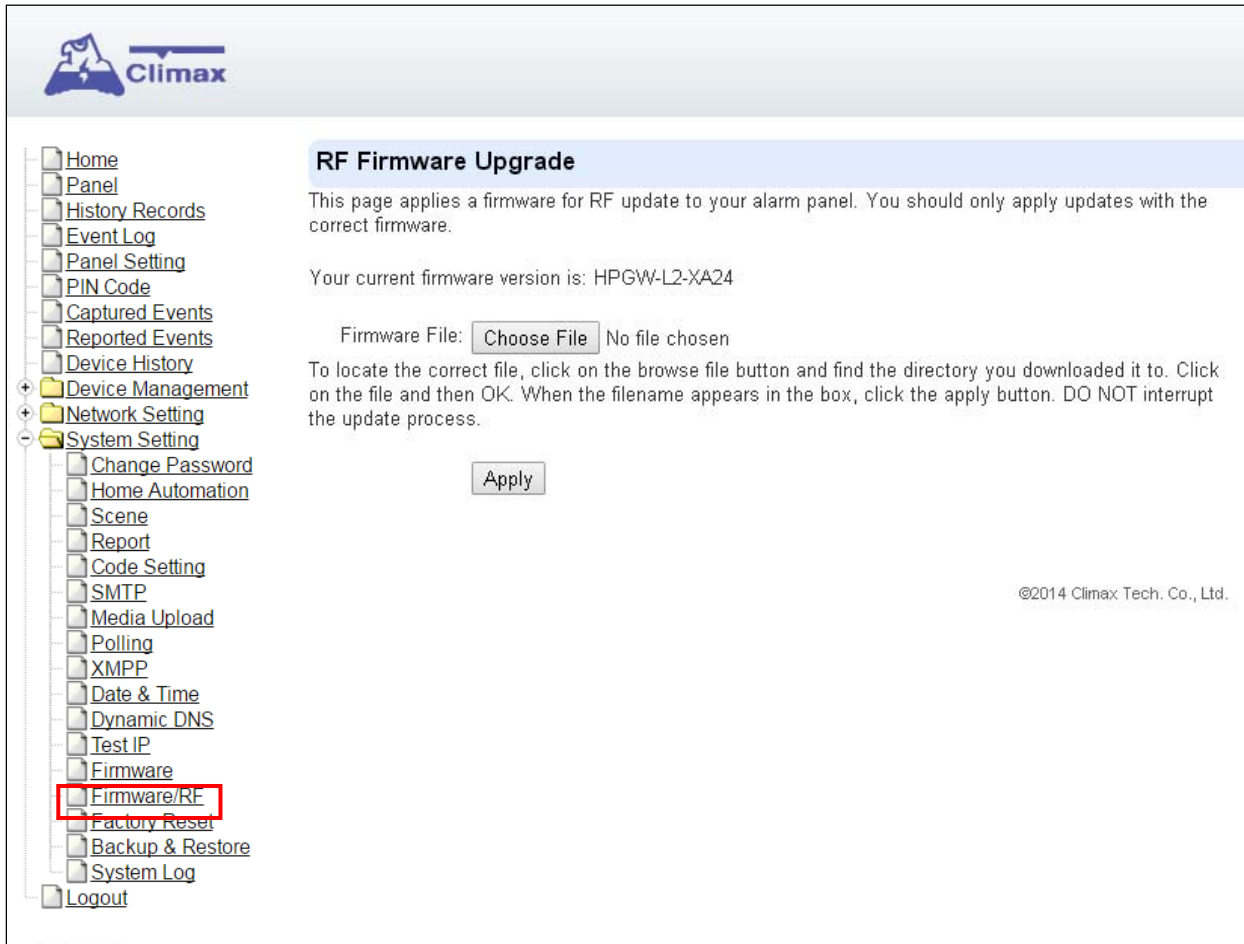

The screenshot shows the Climax web interface for the RF Firmware Upgrade page. On the left is a navigation tree with 'Firmware/RF' highlighted in a red box. The main content area has a title 'RF Firmware Upgrade' and instructions: 'This page applies a firmware for RF update to your alarm panel. You should only apply updates with the correct firmware.' It shows the current version as 'HPGW-L2-XA24'. There is a 'Firmware File:' label followed by a 'Choose File' button and the text 'No file chosen'. Below this is an 'Apply' button. A copyright notice '©2014 Climax Tech. Co., Ltd.' is visible in the bottom right corner.

**Step 2.** Press **"Apply"** to upload the latest firmware to Control Panel

**Step 3.** Wait for 1 min and do NOT power off during this time.

**Step 4.** Once Firmware upgrading is complete, the Control Panel will reboot automatically



## 8.15. Factory Reset

You can clear all programmed parameters in the Control Panel and reset it to Factory Default.

Once the **Factory Reset** is executed, all the programmed settings will be returned to its default value, and all the learnt-in devices will be removed. You will need to restart the programming and learning process again.

### Remote Reset

**Step 1.** Tick the **Kept current network setting** box to keep the current Network settings. Otherwise, the system will reset its value back to factory default.

Tick the **Kept current device list** box to keep the current learnt-in devices. Otherwise, the system will reset its value back to factory default.

**Step 2.** Press **Yes** to continue the Reset procedure.

**Step 3.** Wait for 1 min and do NOT power off during this time.

**Step 4.** Once reset is complete, it will automatically reboot the main unit.

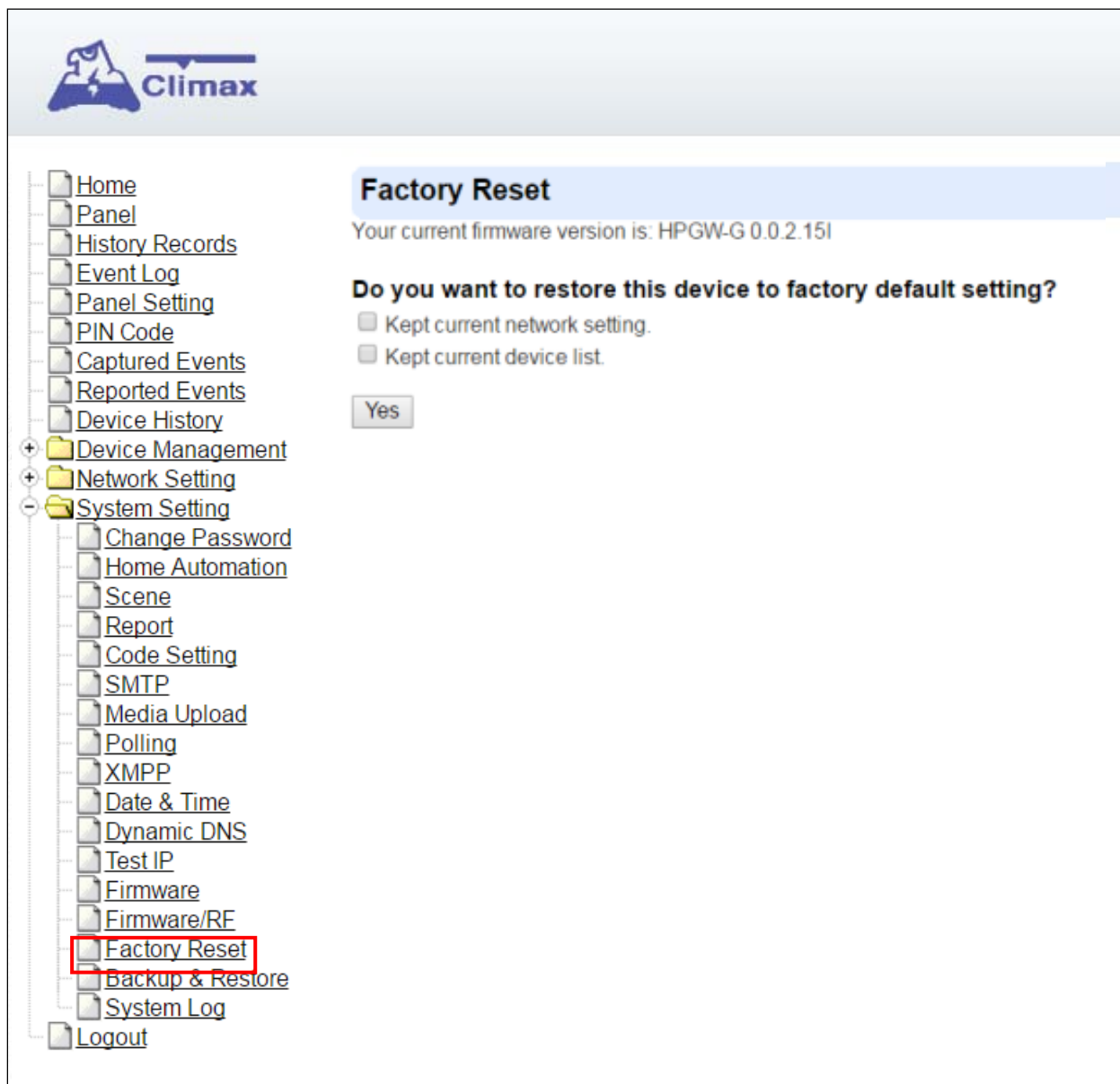

The screenshot displays the Climax control panel interface. On the left is a navigation tree with the following items: Home, Panel, History Records, Event Log, Panel Setting, PIN Code, Captured Events, Reported Events, Device History, Device Management, Network Setting, System Setting, Change Password, Home Automation, Scene, Report, Code Setting, SMTP, Media Upload, Polling, XMPP, Date & Time, Dynamic DNS, Test IP, Firmware, Firmware/RF, Factory Reset (highlighted with a red box), Backup & Restore, System Log, and Logout. The main content area is titled "Factory Reset" and shows the current firmware version as "HPGW-G 0.0.2.15!". Below this, a question asks "Do you want to restore this device to factory default setting?". There are two checkboxes: "Kept current network setting." and "Kept current device list.", both of which are currently unchecked. A "Yes" button is located below the checkboxes.

## Local Reset

**Step 1.** Disconnect the AC adaptor, slide battery switch to OFF.

**Step 2.** Press and Hold the reset button and connect the AC adaptor to the Control Panel. All 3 LEDs will turn on for 10 seconds.

**Step 3.** Keep holding the reset button for 30 seconds then release. After 10 seconds, the Control Panel will restart and all 3 LEDs will turn on.

**Step 4.** Wait for 10 seconds and all 3 LEDs will turn off to indicate factory reset is complete.

## 8.16. Backup & Restore

You can backup all programmed parameters and save these programmed values into a file. Besides, you also can restore pre-programmed settings.

### 8.16.1 Backup Data

You can backup all programmed data and save these programmed values into a file.

**Step 1.** Click **Download configuration file**.

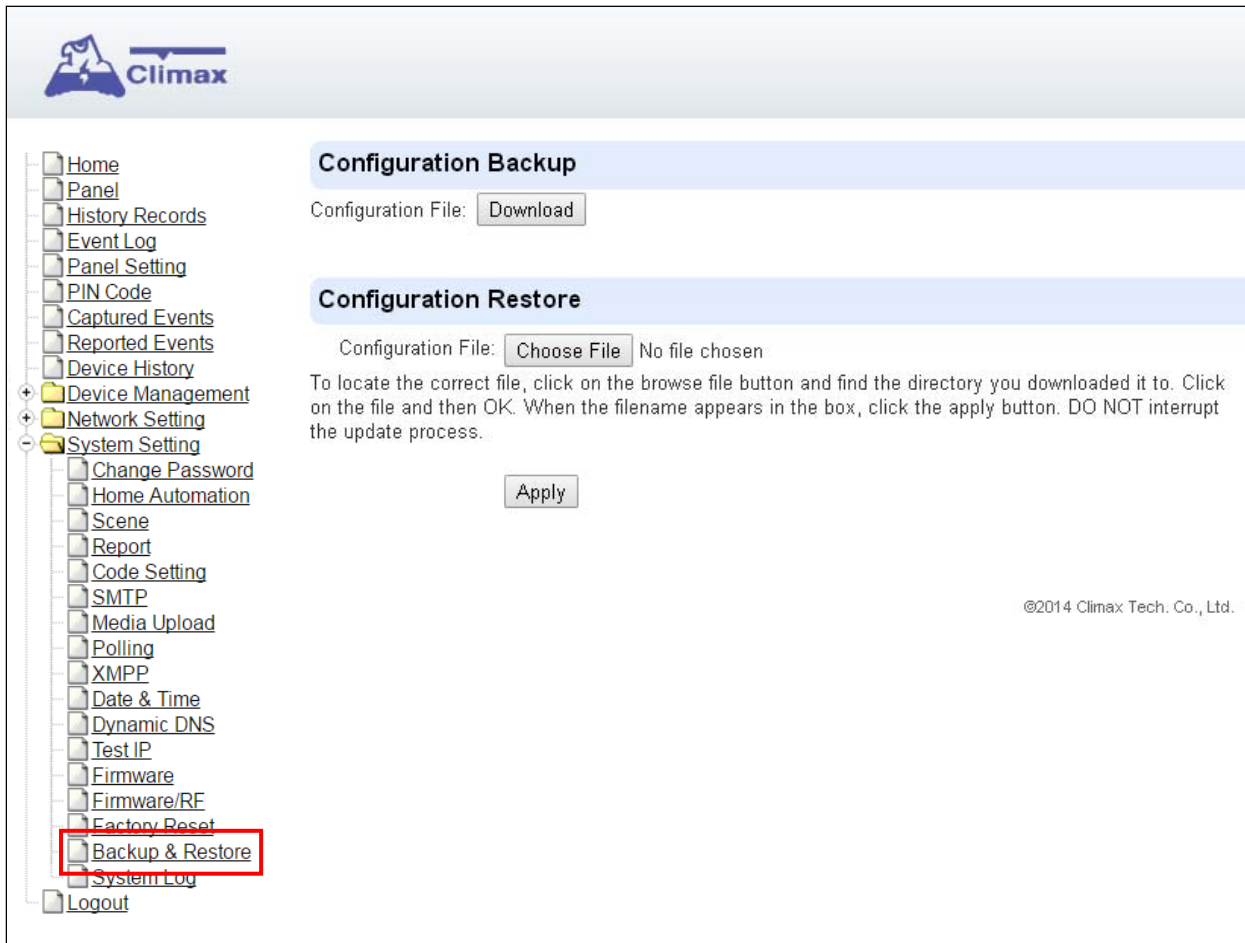

The screenshot displays the Climax web interface. On the left is a navigation tree with the following items: Home, Panel, History Records, Event Log, Panel Setting, PIN Code, Captured Events, Reported Events, Device History, Device Management, Network Setting, System Setting (expanded), Change Password, Home Automation, Scene, Report, Code Setting, SMTP, Media Upload, Polling, XMPP, Date & Time, Dynamic DNS, Test IP, Firmware, Firmware/RF, Factory Reset, Backup & Restore (highlighted with a red box), System Log, and Logout. The main content area has two sections: 'Configuration Backup' with a 'Download' button, and 'Configuration Restore' with a 'Choose File' button and the text 'No file chosen'. Below the restore section is an 'Apply' button and a copyright notice: '©2014 Climax Tech. Co., Ltd.'

**Step 2.** Click **Download configuration file**.

### 8.16.2 Restore Settings

**Step 1.** Click **Browse**, select a saved file.

**Step 2.** Click **Apply** to apply the pre-programmed values to the main unit.

## 8.17. System Log

The system log webpage logs the control panel's detail system operation history.

**System Log**

Reload

Time	Priority	Class	Action	Source	Message
2014/12/12 05:39:15	6	30	Wireless LAN	Worker	Disconnected
2014/12/12 05:39:14	6	30	Wireless LAN	Worker	Disconnected
2014/12/12 05:38:48	6	30	Wireless LAN	Worker	Disconnected
2014/12/12 05:38:47	6	30	Wireless LAN	Worker	Disconnected
2014/12/12 05:37:48	6	30	Wireless LAN	Worker	Disconnected
2014/12/12 05:37:47	6	30	Wireless LAN	Worker	Disconnected
2014/12/12 05:37:39	6	30	Wireless LAN	Worker	Disconnected
2014/12/12 05:37:38	6	30	Wireless LAN	Worker	Disconnected
2014/12/12 05:37:26	6	30	Wireless LAN	Worker	Disconnected
2014/12/12 05:37:25	6	30	Wireless LAN	Worker	Disconnected
2014/12/12 05:37:16	6	30	Wireless LAN	Worker	Disconnected
2014/12/12 05:37:12	6	30	Wireless LAN	Worker	Disconnected
2014/12/12 05:37:11	6	30	Wireless LAN	Worker	Disconnected
2014/12/12 05:36:59	6	30	Wireless LAN	Worker	Disconnected
2014/12/12 05:36:58	6	30	Wireless LAN	Worker	Disconnected
2014/12/12 05:36:50	6	30	Wireless LAN	Worker	Disconnected
2014/12/12 05:36:49	6	30	Wireless LAN	Worker	Disconnected
2014/12/12 05:36:31	6	30	Wireless LAN	Worker	Disconnected
2014/12/12 05:36:30	6	30	Wireless LAN	Worker	Disconnected
2014/12/12 05:36:18	6	30	Wireless LAN	Worker	Disconnected

Limit # of items: 20

System Log File: [Download](#)

- **System Log File Download** Click to download a detail log files into your computer for more information.

## 9. Event & History

This section introduces event history of the system.

### 9.1. Captured Events

This page stores all captured pictures and videos by PIR Camera and PIR Video Camera. When a PIR Camera is triggered, it will take 3 pictures in quick succession, when a PIR Video Camera is triggered, it will take a 10-second video clip. You can also request the PIR Camera to take a picture and PIR Video Camera to take a 10-second video clip manually.

Captured events will be displayed in this page with their information for you to view. Simply click on the picture or video to view them. You can also click **Delete** to delete the event.



The screenshot shows the Climax web interface. On the left is a navigation menu with items like Home, Panel, History Records, Event Log, Panel Setting, PIN Code, Captured Events (highlighted with a red box), Reported Events, Device History, Device Management, Network Setting, System Setting, and Logout. The main content area is titled 'Captured Events' and features a 'Reload' button. Below this is a table with the following data:

Time	Area	Zone	Type	Status	Media	Comment	
2012-09-12 16:24:52	1	10	Requested	Done		No Packet Lost.	<a href="#">Delete</a>
2012-08-28 14:30:42			Requested	Done	<a href="#">Video</a>	No Packet Lost.	<a href="#">Delete</a>
2012-08-28 14:21:12			Requested	Done	<a href="#">Video</a>	No Packet Lost.	<a href="#">Delete</a>

At the bottom of the table, there is a 'Limit # of items' dropdown menu set to 10.

- **Reload** : Click to refresh the page content
- **Limit # of Items**: Click the drop down menu on the page to select the numbers of captured events you want to display.

## 9.2. Reported Events

This page stores all triggered events by the control panel by recording the events' CID event code and report status.

**Reported Events**

Reload

Time	Area	Zone / User	Trigger / Restore	CID event	Message	Report Status	Comment
2012-09-12 15:09:37	1	6	Trigger	383	Tamper	Done	
2012-09-12 14:49:33	1	5	Trigger	383	Tamper	Done	
2012-09-12 14:49:27	1	5	Restore	383	Tamper Restore	Done	
2012-09-12 14:48:57	1	5	Trigger	383	Tamper	Done	
2012-09-12 14:48:56	1	5	Restore	383	Tamper Restore	Done	
2012-09-12 14:48:51	1	5	Trigger	383	Tamper	Done	
2012-09-12 14:48:49	1	5	Restore	383	Tamper Restore	Done	
2012-09-12 14:45:07	1	5	Trigger	383	Tamper	Done	
2012-09-12 14:45:05	1	5	Restore	383	Tamper Restore	Done	
2012-09-12 14:43:29	1	5	Trigger	383	Tamper	Done	
2012-09-12 14:43:27	1	5	Restore	383	Tamper Restore	Done	
2012-09-12 14:42:46	1	5	Trigger	383	Tamper	Done	
2012-09-12 04:04:16	1	1	Trigger	147	Supervision Failure	Done	
2012-09-12 04:04:16	1	3	Trigger	147	Supervision Failure	Done	
2012-09-12 04:04:15	1	2	Trigger	147	Supervision Failure	Done	
2012-09-11 16:35:18	0	0	Trigger	311	Panel Battery Missing/Dead	Done	
2012-09-11 16:04:16	0	0	Trigger	137	Panel Tamper	Done	
2012-09-11 10:40:58	0	0	Trigger	311	Panel Battery Missing/Dead	Done	
2012-09-11 10:16:07	0	0	Trigger	137	Panel Tamper	Done	
2012-08-28 19:18:02	1	1	Trigger	383	Tamper	Done	

Limit # of items: 20

- **Reload** : Click to refresh the page content
- **Limit # of Items**: Click the drop down menu on the pageto select the numbers of captured events you want to display.

### 9.3. Event Log

The Event Log page records specific actions performed by the Control Panel and accessory devices.

Time	Area	Mode	Action	User	Source	Device Type	Message
2015/01/12 05:26:09			Switch To Standard Mode		Panel		Web
2015/01/12 05:25:35	1		Device Added		Zone4	IP Camera	Web
2015/01/12 05:25:04			Switch To Learn Mode		Panel		Web
2015/01/12 05:25:03			Switch To Standard Mode		Panel		Web
2015/01/12 05:23:49			Switch To Learn Mode		Panel		Web
2015/01/12 04:09:49			Switch To Standard Mode		Panel		Web
2015/01/12 04:08:20			System Fault		Panel		Area1Zone1 Tamper; Area1Zone3 Tamper
2015/01/12 04:08:20	1	Disarm	Device Tamper		Zone3	IR Camera	Trigger
2015/01/12 04:04:48			Switch To Learn Mode		Panel		Web
2015/01/12 04:04:45			Switch To Standard Mode		Panel		Web
2015/01/12 04:03:31	1		Device Added		Zone3	IR Camera	Web
2015/01/12 04:02:32	1		Device Added		Zone2	Dimmer	Web
2015/01/12 04:01:38			Switch To Learn Mode		Panel		Web
2015/01/12 03:41:13			System Fault		Panel		Area1Zone1 Tamper
2015/01/12 03:41:12	1	Disarm	Ignored		Zone1	Door Contact	Tamper Ignored
2015/01/12 03:41:12	1	Disarm	Device Tamper		Zone1	Door Contact	Trigger
			System Fault		Panel		Restore
			System Fault		Panel		Network Cable Unplugged; ZigBee Not Ready
			Initialize		Panel		Ready
2015/01/12 03:16:07			System Fault		Panel		Area1Zone1 Tamper

- **Reload** : Click to refresh the page content
- **Limit # of Items**: Click the drop down menu on the pageto select the numbers of captured events you want to display.

## 9.4. Device History

You can track your accessory device status history under **Device History**. For Power Switch Meter or Temperature Sensor, the update history power consumption or temperature reading will be displayed under this page (the current info is also displayed under **Panel** and **PSS Control**).

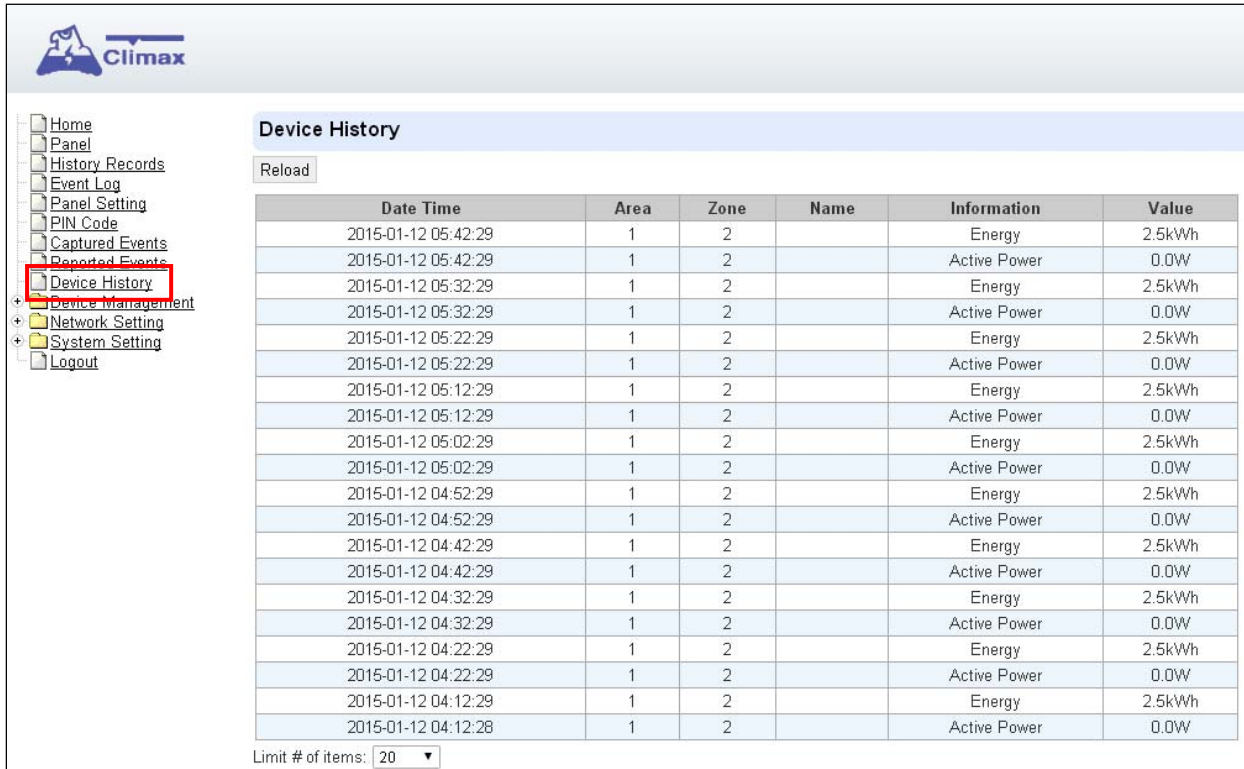

**Device History**

Reload

Date Time	Area	Zone	Name	Information	Value
2015-01-12 05:42:29	1	2		Energy	2.5kWh
2015-01-12 05:42:29	1	2		Active Power	0.0W
2015-01-12 05:32:29	1	2		Energy	2.5kWh
2015-01-12 05:32:29	1	2		Active Power	0.0W
2015-01-12 05:22:29	1	2		Energy	2.5kWh
2015-01-12 05:22:29	1	2		Active Power	0.0W
2015-01-12 05:12:29	1	2		Energy	2.5kWh
2015-01-12 05:12:29	1	2		Active Power	0.0W
2015-01-12 05:02:29	1	2		Energy	2.5kWh
2015-01-12 05:02:29	1	2		Active Power	0.0W
2015-01-12 04:52:29	1	2		Energy	2.5kWh
2015-01-12 04:52:29	1	2		Active Power	0.0W
2015-01-12 04:42:29	1	2		Energy	2.5kWh
2015-01-12 04:42:29	1	2		Active Power	0.0W
2015-01-12 04:32:29	1	2		Energy	2.5kWh
2015-01-12 04:32:29	1	2		Active Power	0.0W
2015-01-12 04:22:29	1	2		Energy	2.5kWh
2015-01-12 04:22:29	1	2		Active Power	0.0W
2015-01-12 04:12:29	1	2		Energy	2.5kWh
2015-01-12 04:12:28	1	2		Active Power	0.0W

Limit # of items: 20

- **Reload** : Click to refresh the page content
- **Limit # of Items**: Click the drop down menu on the page to select the numbers of captured events you want to display.



## 10. Appendix

### 10.1. Fault Event Description

During operation, when the panel detects faulty events, the panel will log the event and make reports. When fault events exist in the system, the panel Fault LED will light up and the panel will emit a beep every 30 seconds.

- **Fault Event Table**

<b>Fault Event</b>	<b>Descriptions</b>
<b>Panel AC Failure</b>	The Control Panel's AC power is disconnected When AC failure is detected, the panel will turn off both Ethernet and mobile network functions when idle to conserve power. Ethernet and mobile network will be activated temporarily when an event is detected by the panel (i.e. alarm trigger) to send report, and will turn off again after finishing report. Accessing the panel via remote server XMPP connection is disabled during AC failure.
<b>Panel Low Battery</b>	The panel's backup battery is only used when AC failure is detected. When the backup battery voltage is low, the panel low battery event is generated
<b>Panel Tamper</b>	The tamper switch on back of the panel is not compressed against the back cover. This means the panel's cover is opened and not properly sealed.
<b>Battery Dead/Missing</b>	The panel cannot detect backup battery, this means the battery is either dysfunctional, or the battery switch is not slid to ON position.
<b>Interference/Jamming</b>	The panel detects radio frequency jamming, which will affect its ability to receive signal from RF devices (Does not include /Z-wave/Wi-fi signal)
<b>Device Low Battery</b>	The accessory device at indicated zone number is low on battery
<b>Device AC Failure</b>	The accessory device at indicated zone number does not have AC power connection.
<b>Device Tamper</b>	The tamper switch of the device at indicated zone number is open
<b>Device Supervision Failure</b>	The panel was unable to receive supervision signal sent from accessory device at indicated zone number for the duration of Supervision Timer programmed. (i.e. If Supervision Timer is set to 12 hours, the panel will generate supervision failure event after failing to receive supervision signal for 12 hours)

## 10.2. Control Panel Mode and Response Table

For Alarm Activation by Events and Control Panel Responses, please refer to the following table:

Attribute	System Mode / Status					
	Disarm	Full Arm	Home Arm	Under Exit Timer	Under Exit Timer (No Response)	Under Entry Timer
No Response	No Response	No Response	No Response	Instant Burglar Alarm	No Response	No Response
Start Entry Delay 1	Instant Burglar Alarm (Interior)	Start Entry 1 → Burglar Alarm (Perimeter)	Start Entry 1 → Burglar Alarm (Interior)	Instant Burglar Alarm	No Response	Delayed Burglar Alarm
Start Entry Delay 2	Instant Burglar Alarm (Interior)	Start Entry 2 → Burglar Alarm (Perimeter)	Start Entry 2 → Burglar Alarm (Interior)	Instant Burglar Alarm	No Response	Delayed Burglar Alarm
Chime	Door Chime	Door Chime	Door Chime	Instant Burglar Alarm	No Response	Door Chime
Burglar Follow	Instant Burglar Alarm	Instant Burglar Alarm	Instant Burglar Alarm	Instant Burglar Alarm	No Response	Delayed Burglar Alarm
Burglar Instant	Instant Burglar Alarm	Instant Burglar Alarm	Instant Burglar Alarm	Instant Burglar Alarm	No Response	Instant Burglar Alarm
Burglar Outdoor	Instant Burglar Outdoor Alarm	Instant Burglar Outdoor Alarm	Instant Burglar Outdoor Alarm	Instant Burglar Alarm	No Response	Instant Burglar Outdoor Alarm
Cross Zone	<b>See 10.3. Appendix – Cross Zone Verification</b>			Instant Burglar Alarm	No Response	Delayed Burglar Alarm
Set/Unset (Opening)	Full Arm	No Response	Full Arm	Full Arm	No Response	No Response
Set/Unset (Closing)	No Response	Disarm	Disarm	Disarm	Disarm	Disarm
24H – Burglar	Instant Burglar Alarm	Instant Burglar Alarm	Instant Burglar Alarm	Instant Burglar Alarm	Instant Burglar Alarm	Instant Burglar Alarm

24H – Smoke	Instant Smoke Alarm	Instant Smoke Alarm	Instant Smoke Alarm	Instant Smoke Alarm	Instant Smoke Alarm	Instant Smoke Alarm
24H – Medical	Instant Medical Alarm	Instant Medical Alarm	Instant Medical Alarm	Instant Medical Alarm	Instant Medical Alarm	Instant Medical Alarm
24H – Fire	Instant Fire Alarm	Instant Fire Alarm	Instant Fire Alarm	Instant Fire Alarm	Instant Fire Alarm	Instant Fire Alarm
24H – Water	Instant Water Alarm	Instant Water Alarm	Instant Water Alarm	Instant Water Alarm	Instant Water Alarm	Instant Water Alarm
24H – CO	Instant CO Alarm	Instant CO Alarm	Instant CO Alarm	Instant CO Alarm	Instant CO Alarm	Instant CO Alarm
24H – Gas	Instant Gas Alarm	Instant Gas Alarm	Instant Gas Alarm	Instant Gas Alarm	Instant Gas Alarm	Instant Gas Alarm
24H – Heat	Instant Heat Alarm	Instant Heat Alarm	Instant Heat Alarm	Instant Heat Alarm	Instant Heat Alarm	Instant Heat Alarm
24H – Silent Panic	Instant Silent Panic Alarm	Instant Silent Panic Alarm	Instant Silent Panic Alarm	Instant Silent Panic Alarm	Instant Silent Panic Alarm	Instant Silent Panic Alarm
24H – Panic	Instant Panic Alarm	Instant Panic Alarm	Instant Panic Alarm	Instant Panic Alarm	Instant Panic Alarm	Instant Panic Alarm
24H – Emergency	Instant Emergency Alarm	Instant Emergency Alarm	Instant Emergency Alarm	Instant Emergency Alarm	Instant Emergency Alarm	Instant Emergency Alarm
24H – Emergency (Quiet)	Instant Silent Emergency Alarm	Instant Silent Emergency Alarm	Instant Silent Emergency Alarm	Instant Silent Emergency Alarm	Instant Silent Emergency Alarm	Instant Silent Emergency Alarm
24H – Fire with Verification	<b>See 10.4. Appendix – Fire Verification</b>					
Trigger Scene	Trigger Scene Number	Trigger Scene Number	Trigger Scene Number	Trigger Scene Number	Trigger Scene Number	Trigger Scene Number

**<NOTE>**

- ☞ **“Delayed Burglar Alarm”** reponse means the Control Panel will wait for the Entry Time to expire. If the Entry Time expires without disarming the system, the Control Panel will activate a Burglar Alarm after Entry Time expiry.
- ☞ **“Silent Panic Alarm”, “Silent Emergency Alarm”** and **“Burglar Outdoor Alarm”** does not activate any audible alarm. The Control Panel will report the alarm event silently without any warning sound.

## 10.3. Cross Zone Verification

Cross Zone Verification is use to setup cross verification for intrusion sensors.

To use Cross Zone Verification, the following sensor and panel setting must be adjusted:

- 1 At least **1** intrusion sensor must be set to **Cross Zone** attribute.
- 2 The **Cross Zone Timer** option under Panel Setting webpage must be enabled.

### Cross Zone Verification Rule

- Cross Zone function does not activate under Exit and Entry Time.
- When a sensor set to Cross Zone attribute is triggered, the panel begins to sound alarm, counts down Cross Zone Timer and reports a Cross Zone First Trip event (CID 693).
  - If the Cross Zone Timer expires without any other sensor trigger, the panel reports Cross Zone Trouble event (CID 378) when the timer expires.
  - If the same sensor is triggered again during Cross Zone Timers, the Cross Zone Timer is reset and extended.
  - If another sensor is triggered during the timer:
    - ☞ The Panel report Burglar (CID 130) for both sensors.
    - ☞ If the newly triggered sensor is set to Cross Zone attribute, the Panel also report Burglar Verified (CID 139) for this sensor.
    - ☞ The Cross Zone Timer is reset and extended.
    - ☞ When the Cross Zone Timer expires, the panel reports Cross Zone Timeout (CID 694).

## 10.4. Fire Verification

Fire Verification is use to setup verification for Smoke Detector.

To use Fire Verification, the following sensor and panel setting must be adjusted:

- 1 At least **1** Smoke Detector must be set to **24 HR – Fire with Verification** attribute.
- 2 The **Fire Verification Timer** option under Panel Setting webpage must be enabled.

### Fire Verification Rule

- When a Smoke Detector set to Fire Verification attribute is triggered, the panel begins to sound alarm, counts down Fire Verification Timer and reports a Near Alarm event (CID 118).
  - Triggering any Smoke Detector with Fire Verification attribute (including the original Some Detector) during Fire Verification Timer will prompt panel to report Smoke Alarm event (CID 111), the timer will be reset and extended.
  - Triggering a regular Smoke Detector with Smoke attribute during the Fire Verification Timer will prompt panel to report Smoke Alarm event (CID 111), the timer will not be reset..
  - When the Fire Verification Timer expires, the panel reports Fire Verification Timeout event (CID 695).

## 10.5. Contact-ID Protocol & Format

Where	<b>ACCT MT QXYZ GG C<sub>1</sub>C<sub>2</sub>C<sub>3</sub></b>																									
ACCT	= 4 Digit Account number (0-9, B-F)																									
MT	= Message Type, 18H.																									
Q	= Event qualifier, which gives specific event information:																									
XYZ	= Event code (3 Hex digits 0-9, B-F)																									
GG	= Group, Partition number (00H), or Area Number - 00 = panel - 01= area 1.....xx= area xx																									
C <sub>1</sub> C <sub>2</sub> C <sub>3</sub>	= 1. For devices: zone <table border="1" data-bbox="635 808 1024 1037"> <tr> <td><b>C<sub>1</sub>C<sub>2</sub>C<sub>3</sub> = Zone number</b></td> </tr> <tr> <td>001, Zone 1</td> </tr> <tr> <td>002, Zone 2</td> </tr> <tr> <td>.....</td> </tr> <tr> <td>XXX Zone XXX</td> </tr> </table> 2. For Panel: code <table border="1" data-bbox="635 1137 1000 1630"> <tr> <td><b>C<sub>1</sub>C<sub>2</sub>C<sub>3</sub> =</b></td> <td></td> </tr> <tr> <td>User PIN Code 1</td> <td>001</td> </tr> <tr> <td>User PIN Code 2</td> <td>002</td> </tr> <tr> <td>User PIN Code 3</td> <td>003</td> </tr> <tr> <td>User PIN Code 4</td> <td>004</td> </tr> <tr> <td>User PIN Code 5</td> <td>005</td> </tr> <tr> <td>User PIN Code 6</td> <td>006</td> </tr> <tr> <td>Temporary Code</td> <td>997</td> </tr> <tr> <td>Duress Code</td> <td>998</td> </tr> <tr> <td colspan="2">000= Control Panel</td> </tr> </table>	<b>C<sub>1</sub>C<sub>2</sub>C<sub>3</sub> = Zone number</b>	001, Zone 1	002, Zone 2	.....	XXX Zone XXX	<b>C<sub>1</sub>C<sub>2</sub>C<sub>3</sub> =</b>		User PIN Code 1	001	User PIN Code 2	002	User PIN Code 3	003	User PIN Code 4	004	User PIN Code 5	005	User PIN Code 6	006	Temporary Code	997	Duress Code	998	000= Control Panel	
<b>C<sub>1</sub>C<sub>2</sub>C<sub>3</sub> = Zone number</b>																										
001, Zone 1																										
002, Zone 2																										
.....																										
XXX Zone XXX																										
<b>C<sub>1</sub>C<sub>2</sub>C<sub>3</sub> =</b>																										
User PIN Code 1	001																									
User PIN Code 2	002																									
User PIN Code 3	003																									
User PIN Code 4	004																									
User PIN Code 5	005																									
User PIN Code 6	006																									
Temporary Code	997																									
Duress Code	998																									
000= Control Panel																										

## 10.6. Event Code

- **100 – Medical**
  - ◆ When a device set to Medical attribute is triggered.
- **101 – Personal emergency**
  - ◆ When a device set to Personal Emergency attribute is triggered.
- **110 – Fire**
  - ◆ When a device set to Fire attribute is triggered.
- **111 – Smoke**
  - ◆ When the Smoke Detector (SD) set to Smoke Alarm is triggered.
  - ◆ When the Smoke Detector (SD) set to Fire Verification verifies an alarm during Fire Verification Time.
- **118 – Near Alarm**
  - ◆ When the Smoke Detector (SD) set to Fire Verification is triggered.
- **120 – Panic**
  - ◆ When a device set to Panic attribute is pressed.
- **121 – Duress**
  - ◆ When the Duress Code is entered to disarm or arm the system.
- **122 – Silent Panic**
  - ◆ When a device set to Silent Panic is pressed.
- **130 – Burglar**
  - ◆ Whenever a device set as Burglar Instant is triggered.
  - ◆ Whenever a device set as Burglar Instant is triggered under **Disarm, Full Arm** or **Home Arm** mode.
- **131 – Burglar Perimeter**
  - ◆ When a device set as **Entry** is triggered in Full Arm mode.
  - ◆ When a device set as **Burglar Follow** is triggered during Full Arm Entry Time and the system is not disarmed before entry time expiry.
- **132 – Burglar Interior**
  - ◆ When a device set at **Entry** is triggered in Home Arm mode.
  - ◆ When a device set as **Burglar Follow** is triggered during Home Arm Entry Time and the system is not disarmed before entry time expiry.
- **136 – Burglar Outdoor**
  - ◆ Whenever a device set at **Burglar Outdoor** is triggered.
- **137 – Panel Tamper/ Panel Tamper Restore**
  - ◆ When the panel's tamper protection is triggered.
  - ◆ When the panel's tamper function is restored.
- **139 – Burglar Verified.**
  - ◆ When a sensor set to Cross Zone attribute verifies an alarm.
- **147 – Sensor Supervision Failure/ Sensor Supervision Restore**
  - ◆ When the panel fails to receive supervision signal from a device within preset

supervision timer.

- ◆ When the panel receives signal again from sensor that previously failed supervision.
- **154 – Water leakage**
  - ◆ When the Water Sensor connected to Door Contact set at **Water (@W)** is triggered.
- **158 – High Temperature Alarm**
  - ◆ When high temperature alarm is triggered.
- **159 – Low Temperature Alarm**
  - ◆ When low temperature alarm is triggered.
- **162 – CO Alarm**
- **170 – High Power Consumption**
  - ◆ When high power consumption alarm is triggered.
- **171 – High Humidity Alarm**
  - ◆ When high humidity alarm is triggered.
- **172 – Low Humidity Alarm**
  - ◆ When low humidity alarm is triggered.
- **301 – AC Failure/ AC Power Restore**
  - ◆ When the AC power fails for more than 10 sec.
  - ◆ Restore from AC power failure.
- **302 – Low battery/ Battery Normal**
  - ◆ When the battery voltage of the Panel is low.
  - ◆ When the panel battery restores voltage.
- **311 – Battery Disconnection/ Battery Reconnected**
- **344 – Interference/ Interference problem solved**
- **358 – Network Cable Unplugged**
  - ◆ When the Ethernet cable is disconnected.
- **374 – Force Arm**
  - ◆ When the system is armed with existing fault events
- **693 – Cross Zone Trouble**
  - ◆ When Cross Zone Timer expires without alarm verification.
- **380 – Device AC Failure**
  - ◆ When an AC power device loses AC power connection.
- **383 – Sensor Tamper/ Sensor Tamper Restore**
  - ◆ When any sensor's tamper protection is triggered.
  - ◆ When the sensor's tamper function is restored.
- **384 – Sensor Low battery/ Sensor Battery Normal**
  - ◆ When a device detects low battery voltage.
  - ◆ When a device's low battery condition is restored.
- **400 – Arm/Disarm (by Remote Controller)**
  - ◆ When the system is armed or disarmed by using the Remote Controller.

- **401 – Remote Arm/Disarm**
  - ◆ When the system is armed or disarmed by SMS message or web access
- **407 – Disarm/Away Arm/Home Arm by Remote Keypad**
- **408 – Set/Unset Arm/Disarm**
  - ◆ When the DC set at Set\Unset is triggered.
- **456 - Partial Arm**
  - ◆ When partially arm the system from Disarm to Home arm
- **570 – Device out of order/ Door Contact Not Closed**
  - ◆ When any device is out of order after the preset exit delay time is reached
  - ◆ Door Contact is not closed after the preset exit delay time is reached.
- **602 – Periodic test report**
  - ◆ When the control panel makes periodic Check-in reporting.
- **616 – Call Request**
  - ◆ When the service call is activated by VST-809.
- **693 – Cross Zone First Trip**
  - ◆ When a sensor set to Cross Zone is triggered to start Cross Zone Timers.
- **694 – Cross Zone Timeout**
  - ◆ When Cross Zone Timer expires after the alarm has been verified.
- **693 – Fire Verification Timeout**
  - ◆ When Fire Verification Timer expires.



# Cinterion® EHS6 Features

## GENERAL FEATURES

- > 3GPP Rel.7 Compliant Protocol Stack
- > Five Bands UMTS (WCDMA/FDD)  
Bands: 800, 850, 900, 1900 and 2100 MHz
- > Quad-Band GSM  
Bands: 850, 900, 1800 and 1900 MHz
- > SIM Application Toolkit, Class 3,  
with BIP and RunAT support
- > Embedded IP stack
- > Control via standardized and extended  
AT commands (Hayes, TS 27.007 and 27.005)
- > TCP/IP stack access via AT command and  
transparent TCP services
- > Secure Connection for client IP services
- > Internet Services TCP/UDP server/client, DNS, Ping,  
FTP client, HTTP client
- > Supply voltage range 3.1 - 4.5 V, highly optimized  
for minimal power consumption. (Baseband) Supply  
voltage range 2.8 - 4.5 V (RF-PA)
- > Dimension: 27.6 x 25.4 x 2.3 mm
- > Weight: 3 g
- > Operating Temperature: -40 °C to +90 °C

## SPECIFICATIONS

- > HSDPA Cat.8 / HSUPA Cat.6 data rates  
DL: max. 7.2 Mbps, UL: max. 5.76 Mbps
- > EDGE Class 12 data rates  
DL: max. 237 kbps, UL: max. 237 kbps
- > GPRS Class 12 data rates  
DL: max. 85.6 kbps, UL: max. 85.6 kbps
- > EU eCall and ERA/GLONASS support
- > CSD data transmission up to 9.6 kbps, V.110,  
non-transparent
- > SMS text and PDU mode support
- > High quality voice support for handset, headset and  
hands-free operation
- > Integrated TTY modem
- > Speech codec: FR, HR, EFR and AMR

## SPECIAL FEATURES

- > USB interface supports multiple composite modes  
and a Linux-/Mac- compliant mode
- > Firmware update via USB and serial interface
- > Real time clock with alarm functionality
- > Multiplexer according 3GPP TS 27.010
- > RLS Monitoring (Jamming detection) in 2G and 3G
- > Informal Network Scan
- > Customer IMEI/SIM-Lock as variant
- > Integrated FOTA, configurable and free of charge

## JAVA OPEN PLATFORM

- > Java™ ME 3.2
- > Secure data transmission with HTTPS/SSL
- > Multi-Threading programming and Multi-Application  
execution
- > 10 MB RAM and 10 MB Flash File System

## INTERFACES (LGA PADS)

- > Pad for GSM/WCDMA Antenna
- > USB 2.0 HS interface up to 480 Mbps
- > High speed serial modem interface ASC0
- > HSIC HS interface up to 480 Mbps
- > 16 GPIO lines shared with DSR, DTR, DCD (all ASC0),  
ASC1 (RXD, TXD, RTS, CTS), SPI, Fast-Shutdown,  
Network-Status-Indication
- > ADC and I<sup>2</sup>C interface
- > 4-wire high speed serial interfaces ASC1
- > Digital audio interface (analog audio optional)
- > UICC and U/SIM card interface 1.8 V / 3 V
- > Lines for Module-On and Reset

## DRIVERS

- > USB, MUX driver for Microsoft® Windows XP™,  
Vista™ and 7™
- > RIL, USB driver for Microsoft® Windows Embedded  
Handheld™ >= 6.x
- > USB, MUX driver for Microsoft® Windows Embedded  
Compact™ >= 5.x

## APPROVALS

- > R&TTE, GCF, CE, FCC, PTCRB, IC, UL
- > AT&T and other local approvals and provider  
certifications
- > EuP, RoHS and REACH compliant

## Federal Communication Commission Interference Statement

This equipment has been tested and found to comply with the limits for a Class B digital device, pursuant to Part 15, 22, 24 of the FCC Rules. These limits are designed to provide reasonable protection against harmful interference in a residential installation.

This equipment generates, uses and can radiate radio frequency energy and, if not installed and used in accordance with the instructions, may cause harmful interference to radio communications. However, there is no guarantee that interference will not occur in a particular installation. If this equipment does cause harmful interference to radio or television reception, which can be determined by turning the equipment off and on, the user is encouraged to try to correct the interference by one of the following measures:

- . Reorient or relocate the receiving antenna.
- . Increase the separation between the equipment and receiver.
- . Connect the equipment into an outlet on a circuit different from that to which the receiver is connected.
- . Consult the dealer or an experienced radio/TV technician for help.

***FCC Caution:*** To assure continued compliance, any changes or modifications not expressly approved by the party responsible for compliance could void the user's authority to operate this equipment. (Example - use only shielded interface cables when connecting to computer or peripheral devices).

### ***FCC Radiation Exposure Statement***

This equipment complies with FCC RF radiation exposure limits set forth for an uncontrolled environment. This equipment should be installed and operated with a minimum distance of 70 centimeters between the radiator and your body.

This transmitter must not be co-located or operating in conjunction with any other antenna or transmitter.

The antennas used for this transmitter must be installed to provide a separation distance of at least 70 cm from all persons and must not be co-located or operating in conjunction with any other antenna or transmitter.

This device complies with Part 15, 22, 24 of the FCC Rules. Operation is subject to the following two conditions:

- (1) This device may not cause harmful interference, and
- (2) This device must accept any interference received, including interference that may cause undesired operation.