



Flom Test Labs
EMI, EMC, RF Testing Experts Since 1963

toll-free: (866) 311-3268
fax: (480) 926-3598
<http://www.flomlabs.com>
info@flomlabs.com

Date of Report: May 16, 2006
Date of Submission: May 25, 2006

Federal Communications Commission
Via: Electronic Filing

Attention: Authorization & Evaluation Division

Applicant: Wulfsberg Electronics Division
Equipment: XTS-5000A (VHF/FM Radio)
FCC ID: Part of FRWRT-5000A
FCC Rules: 80.379, 90, 90.210, Confidentiality

Gentlemen:

On behalf of the Applicant, enclosed please find Application Form 731, Engineering Test Report and all pertinent documentation, the whole for approval of the referenced equipment as shown.

Filing fees are attached.

We trust the same is in order. Should you need any further information, kindly contact the writer who is authorized to act as agent.

Sincerely yours,

Michael Schafer, President

enclosure(s)
cc: Applicant
MS/del



Flom Test Labs
EMI, EMC, RF Testing Experts Since 1963

toll-free: (866) 311-3268
fax: (480) 926-3598
<http://www.flomlabs.com>
info@flomlabs.com

Transmitter Certification

of

Model: XTS-5000A (VHF/FM Radio)
Part of
FCC ID: FRWRT-5000A

to

Federal Communications Commission

Rule Part(s) 80.379, 90, 90.210, Confidentiality

Date of report: May 16, 2006

On the Behalf of the Applicant:

Wulfsberg Electronics Division

At the Request of:

Wulfsberg Electronics Division
6400 Wilkinson Drive
Prescott, AZ 86301-6164

Attention of:

Main: (928) 708-1550; Fax: (928) 541-7627
Dave Auer, Project Manager
Direct (928) 708-1576
Email: dave.auer@wulfsberg.com

Report Prepared By:

David E. Lee, FCC/IC Compliance
Manager

Approved by:

Sam Baum, Technical Manager

Flom Test Labs
3356 North San Marcos Place, Suite 107
Chandler, Arizona 85225-7176
(480) 926-3100 phone, (480) 926-3598 fax

FCC ID: FRWRT-5000A
MFA p0640009, d0650020

List of Exhibits

(FCC **Certification** (Transmitters) - Revised 9/28/98)

Applicant: Wulfsberg Electronics Division

FCC ID: FRWRT-5000A

By Applicant:

1. Letter of Authorization
2. Confidentiality Request: 0.457 And 0.459
3. Part 90.203(e) & (g) Attestation
4. Identification Drawings, 2.1033(c)(11)
 - Label
 - Location of Label
 - Compliance Statement
 - Location of Compliance Statement
5. Photographs, 2.1033(c)(12)
6. Documentation: 2.1033(c)
 - (3) User Manual
 - (9) Tune Up Info
 - (10) Schematic Diagram
 - (10) Circuit Description
 - Block Diagram
 - Parts List
 - Active Devices
7. MPE Report

By M.F.A. Inc.:

- A. Testimonial & Statement of Certification

The Applicant has been cautioned as to the following:

15.21 Information to the User.

The users manual or instruction manual for an intentional radiator shall caution the user that changes or modifications not expressly approved by the party responsible for compliance could void the user's authority to operate the equipment.

15.27(a) Special Accessories.

Equipment marketed to a consumer must be capable of complying with the necessary regulations in the configuration in which the equipment is marketed. Where special accessories, such as shielded cables and/or special connectors are required to enable an unintentional or intentional radiator to comply with the emission limits in this part, the equipment must be marketed with, i.e. shipped and sold with, those special accessories. However, in lieu of shipping or packaging the special accessories with the unintentional or intentional radiator, the responsible party may employ other methods of ensuring that the special accessories are provided to the consumer, without additional charge.

Information detailing any alternative method used to supply the special accessories for a grant of equipment authorization or retained in the verification records, as appropriate. The party responsible for the equipment, as detailed in § 2.909 of this chapter, shall ensure that these special accessories are provided with the equipment. The instruction manual for such devices shall include appropriate instructions on the first page of text concerned with the installation of the device that these special accessories must be used with the device. It is the responsibility of the user to use the needed special accessories supplied with the equipment.

Table of Contents

<u>Rule</u>	<u>Description</u>	<u>Page</u>
2.1033(c)(14)	Rule Summary	2
	Standard Test Conditions, Engineering Practices and Calibration	3
2.1033(c)	General Information Required	4
2.1046(a)	Carrier Output Power (Conducted)	7
2.1053(a)	Field Strength of Spurious Radiation	9
2.1049(c)(1)	Emission Masks (Occupied Bandwidth)	16
90.214	Transient Frequency Behavior	18
2.1047(a)	Audio Low Pass Filter (Voice Input)	24
2.1047(a)	Audio Frequency Response	26
2.1047(b)	Modulation Limiting	28
2.1055(a)(1)	Frequency Stability (Temperature Variation)	31
2.1055(b)(1)	Frequency Stability (Voltage Variation)	33
2.202(g)	Necessary Bandwidth and Emission Bandwidth	35

Required information per ISO/IEC Guide 25-1990, paragraph 13.2:

- a) **Test Report**
- b) Laboratory: M. Flom Associates, Inc.
 (FCC: 31040/SIT) 3356 N. San Marcos Place, Suite 107
 (Canada: IC 2044) Chandler, AZ 85225
- c) Report Number: d0650020
- d) Client: Wulfsberg Electronics Division
 6400 Wilkinson Drive
 Prescott, AZ 86301-6164
- e) Identification: XTS-5000A (VHF/FM Radio)
 Part of FCC ID: FRWRT-5000A
 EUT Description: Mobile FM Transceiver
- f) EUT Condition: Not required unless specified in individual tests.
- g) Report Date: May 16, 2006
 EUT Received: April 8, 2006
- h, j, k): As indicated in individual tests.
- i) Sampling method: No sampling procedure used.
- l) Uncertainty: In accordance with MFA internal quality manual.
- m) Supervised by: 
 David E. Lee, FCC/IC Compliance Manager
- n) Results: The results presented in this report relate only to the item tested.
- o) Reproduction: This report must not be reproduced, except in full, without written permission from this laboratory.

Accessories used during testing:

Type	Quantity	Manufacturer	Model	Serial No.	FCC ID
Control Unit	1	Wulfsberg	C-5000	-	No Required
Interface	1	Wulfsberg	TS-1	-	-

Sub-part

2.1033(c)(14):

Test and Measurement Data

All tests and measurement data shown were performed in accordance with FCC Rules and Regulations, Volume II; Part 2, Sub-part J, Sections 2.947, 2.1033(c), 2.1041, 2.1046, 2.1047, 2.1079, 2.1051, 2.1053, 2.1055, 2.1057 and the following individual Parts:

- 21 – Domestic Public Fixed Radio Services
- 22 – Public Mobile Services
- 22 Subpart H - Cellular Radiotelephone Service
- 22.901(d) - Alternative technologies and auxiliary services
- 23 – International Fixed Public Radiocommunication services
- 24 – Personal Communications Services
- 74 Subpart H - Low Power Auxiliary Stations
- 80 – Stations in the Maritime Services
- 80 Subpart E - General Technical Standards
- 80 Subpart F - Equipment Authorization for Compulsory Ships
- 80 Subpart K - Private Coast Stations and Marine Utility Stations
- 80 Subpart S - Compulsory Radiotelephone Installations for Small Passenger Boats
- 80 Subpart T - Radiotelephone Installation Required for Vessels on the Great Lakes
- 80 Subpart U - Radiotelephone Installations Required by the Bridge-to-Bridge Act
- 80 Subpart V - Emergency Position Indicating Radio Beacons (EPIRB'S)
- 80 Subpart W - Global Maritime Distress and Safety System (GMDSS)
- 80 Subpart X - Voluntary Radio Installations
- 87 – Aviation Services
- 90 – Private Land Mobile Radio Services
- 94 – Private Operational-Fixed Microwave Service
- 95 Subpart A - General Mobile Radio Service (GMRS)
- 95 Subpart C - Radio Control (R/C) Radio Service
- 95 Subpart D - Citizens Band (CB) Radio Service
- 95 Subpart E - Family Radio Service
- 95 Subpart F - Interactive Video and Data Service (IVDS)
- 97 - Amateur Radio Service
- 101 – Fixed Microwave Services

Standard Test Conditions and Engineering Practices

Except as noted herein, the following conditions and procedures were observed during the testing:

In accordance with ANSI C63.4-1992/2003, and unless otherwise indicated in the specific measurement results, the ambient temperature of the actual EUT was maintained within the range of 10° to 40°C (50° to 104 °F) unless the particular equipment requirements specify testing over a different temperature range. Also, unless otherwise indicated, the humidity levels were in the range of 10% to 90% relative humidity.

Prior to testing, the EUT was tuned up in accordance with the manufacturer's alignment procedures. All external gain controls were maintained at the position of maximum and/or optimum gain throughout the testing.

Measurement results, unless otherwise noted, are worst-case measurements.

Calibration List

Asset	Description	s/n	Cycle	
i00231/2	PASTERNAK PE7021-30 (30 dB)	231 or 232	NCR	-
i00122/3	NARDA 766 (10 dB)	7802 or 7802A	NCR	-
i00020	HP 8901A Power / Frequency Modes	2105A01087	12 mo.	May-05
i00017	HP 8903A Audio Analyzer	2216A01753	12 mo.	Aug-05
i00002	HP 3336B Synthesizer / Level Gen.	1931A01465	12 mo.	May-05
i00048	HP 8566B Spectrum Analyzer	2511A01467	24 mo.	Sep-04
i00029	HP 8563E Spectrum Analyzer	3213A00104	12 mo.	Jan-06
i00088	EMCO 3109-B 25MHz-300MHz	2336	24 mo.	Oct-05
i00089	Apriel 2001 200MHz-1GHz	001500	24 mo.	Oct-05
i00103	EMCO 3115 1GHz-18GHz	9208-3925	24 mo.	Oct-05
i00028	HP 8449A	2749A00121	12 mo.	Jun-05
i00033	HP 85462A	3625A00357	24 mo.	Oct-05
i00067	HP 8920A Communication TS	3345U01242	24 mo.	May-05
i00207	HP 8753D Network Analyzer	3410A08514	24 mo.	May-06
i00021	HP 8954A Transceiver Interface	2146A00159	NCR	-
i00159	HP 8470B Crystal Detector	1822A10054	NCR	-
i00030	HP 54502A Digital Oscilloscope	2927A00209	12 mo.	May-05
i00001	HP 3586B Selective Level Meter	1928A01360	12 mo.	Jul-05
i00027	Tenney Temp. Chamber	9083-765-234	NCR	-

List of General Information Required for Certification

In Accordance with FCC Rules and Regulations,
 Volume II, Part 2 and to 80.379, 90, 90.210, Confidentiality

Sub-part 2.1033

(c)(1): **Name and Address of Applicant:**

Wulfsberg Electronics Division
 6400 Wilkinson Drive
 Prescott, AZ 86301-6164

Manufacturer:

Wulfsberg Electronics Division
 6400 Wilkinson Drive
 Prescott, AZ 86301-6164

(c)(2): **FCC ID:**

FRWRT-5000A (Part of)

Model Number:

XTS-5000A (VHF/FM Radio)

(c)(3): **Instruction Manual(s):**

Please see attached exhibits

(c)(4): **Type of Emission:**

16K0F3E, 11K0F3E, 8K10F1E,
 8K10F1D, 20K0F1E

(c)(5): **Frequency Range, MHz:**

137.000 to 174.000

(c)(6): **Power Rating, Watts:**

Switchable

Variable

1 / 10

N/A

(c)(7): **Maximum Power Rating, Watts:**

300

DUT Results:

Passes Fails

Please Note: The Applicant is submitting five applications for transmitters, four of which use distinct Motorola manufactured, and previously certified, Integrated Transceiver Modules (ITMs). In this case, Motorola module FCC ID: AZ489FT3804. A copy of the Grant has been uploaded with the exhibits

Information for Push-To-Talk Devices

Type and number of antenna to be used for this device:

One (1), Comant AT-5000 or equivalent

Maximum antenna gain for antenna indicated above:

0dBd

Can this device sustain continuous operation with respect to its hardware capabilities and allowable operating functions?

No, 50% Duty Cycle

Other hardware or operating restrictions that could limit a person's RF Exposure:

N/A

Source-based time-averaging (see 2.1093 of rules) applicable to reduce the average output power:

N/A

If device has headset and belt-clip accessories that would allow body-worn operations, what is the minimum separation distance between the antenna and the user's body in this operating configuration?

N/A

Can device access wire-line services to make phone calls, either directly or through an operator?

No

Can specific operating instructions be given to users to eliminate any potential RF Exposure concerns for both front-of-the-face and body-worn operating configurations?

Mobile Unit

Other applicable information the applicant may provide that can serve as effective means for ensuring RF Exposure compliance:

See ' Instructions to Installers and Users'

Subpart 2.1033 (continued)

(c)(8): Voltages & currents in all elements in final RF stage, including final transistor or solid-state device:

Collector Current, A	=	0.357
Collector Voltage, Vdc	=	7.5
Supply Voltage, Vdc	=	28.0

(c)(9): **Tune-Up Procedure:**

Please see attached exhibits

(c)(10): **Circuit Diagram/Circuit Description:**

Including description of circuitry & devices provided for determining and stabilizing frequency, for suppression of spurious radiation, for limiting modulation and limiting power.

Please see attached exhibits

(c)(11): **Label Information:**

Please see attached exhibits

(c)(12): **Photographs:**

Please see attached exhibits

(c)(13): **Digital Modulation Description:**

Attached Exhibits
 N/A

(c)(14): **Test and Measurement Data:**

Follows

Name of Test: Carrier Output Power (Conducted)

Specification: 47 CFR 2.1046(a)

Guide: ANSI/TIA/EIA-603-C

Measurement Procedure

A) The EUT was connected to a resistive coaxial attenuator of normal load impedance, and the unmodulated output power was measured by means of an RF Power Meter.

B) Measurement accuracy is $\pm 3\%$.

Transmitter Test Set-Up: RF Power Output

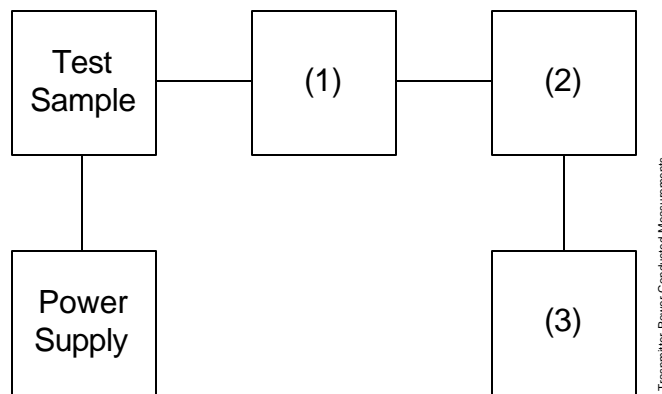

Asset	Description	s/n
(1)	Coaxial Attenuator	
X	i00231/2 PASTERNAK PE7021-30 (30 dB)	231 or 232
	i00122/3 NARDA 766 (10 dB)	7802 or 7802A
(2)	Power Meters	
X	i00020 HP 8901A Power Mode	2105A01087
(3)	Frequency Counter	
X	i00020 HP 8901A Frequency Mode	2105A01087

Name of Test: Carrier Output Power (Conducted)

Measurement Results
(Worst case)

Frequency of Carrier, MHz = 137.025, 155.025, 173.975
Ambient Temperature = 23°C ± 3°C

Power Setting	RF Power, dBm	RF Power, Watts
Low	30.00, 30.01, 30.07	1.00, 1.00, 1.02
High	39.97, 39.85, 39.88	9.93, 9.66, 9.73



Performed by:

David E. Lee, FCC/IC Compliance Manager

Name of Test: Field Strength of Spurious Radiation

Specification: 47 CFR 2.1053(a)

Guide: ANSI/TIA/EIA-603-C, 47 CFR 22.917

Measurement Procedure

Definition:

Radiated spurious emissions are emissions from the equipment when transmitting into a non-radiating load on a frequency, or frequencies, which are outside an occupied band sufficient to ensure transmission of information of required quality for the class of communications desired.

Method of Measurement:

- A) Connect the equipment as illustrated
- B) Adjust the spectrum analyzer for the following settings:
 - 1) Resolution Bandwidth 100 kHz (<1 GHz), 1 MHz (> 1GHz).
 - 2) Video Bandwidth = 3 times Resolution Bandwidth, or 30 kHz (22.917)
 - 3) Sweep Speed ≤ 2000 Hz/second
 - 4) Detector Mode = Mean or Average Power
- C) Place the transmitter to be tested on the turntable in the standard test site. The transmitter is transmitting into a non-radiating load that is placed on the turntable. The RF cable to this load should be of minimum length.

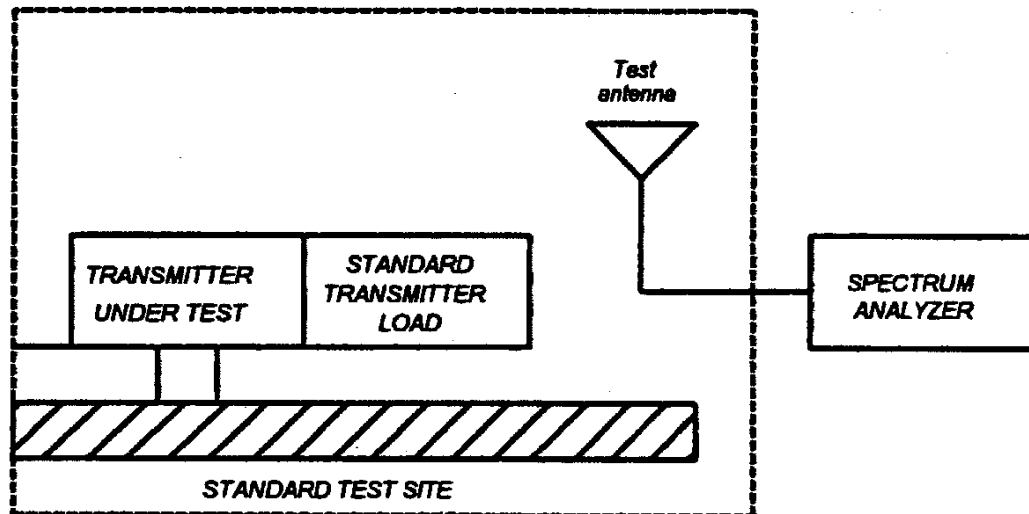

Name of Test: Field Strength of Spurious Radiation (Cont.)

- D) For each spurious measurement the test antenna should be adjusted to the correct length for the frequency involved. This length may be determined from a calibration ruler supplied with the equipment. Measurements shall be made from the lowest radio frequency generated in the equipment to the tenth harmonic of the carrier, except for the region close to the carrier equal to \pm the test bandwidth (see section 1.3.4.4).
- E) For each spurious frequency, raise and lower the test antenna from 1 m to 4 m to obtain a maximum reading on the spectrum analyzer with the test antenna at horizontal polarity. Repeat this procedure to obtain the highest possible reading. Record this maximum reading.
- F) Repeat step E) for each spurious frequency with the test antenna polarized vertically.

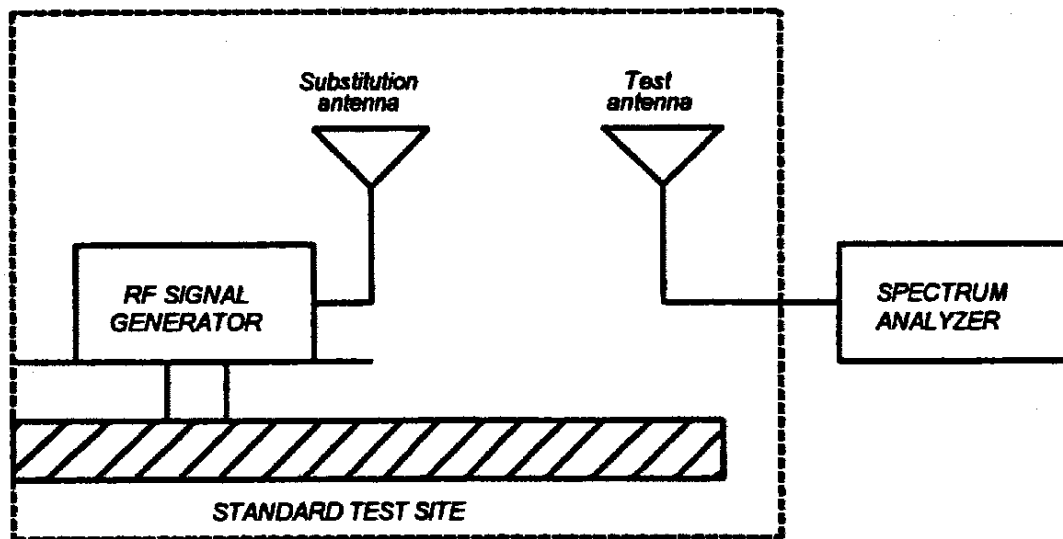

- G) Reconnect the equipment as illustrated.
- H) Keep the spectrum analyzer adjusted as in step B).
- I) Remove the transmitter and replace it with a substitution antenna (the antenna should be half-wavelength for each frequency involved). The center of the substitution antenna should be approximately at the same location as the center of the transmitter. At lower frequencies, where the substitution antenna is very long, this will be impossible to achieve when the antenna is polarized vertically. In such case the lower end of the antenna should be 0.3 m above the ground.

Name of Test: Field Strength of Spurious Radiation (Cont.)

- J) Feed the substitution antenna at the transmitter end with a signal generator connected to the antenna by means of a non-radiating cable. With the antennas at both ends horizontally polarized and with the signal generator tuned to a particular spurious frequency, raise and lower the test antenna to obtain a maximum reading at the spectrum analyzer. Adjust the level of the signal generator output until the previously recorded maximum reading for this set of conditions is obtained. This should be done carefully repeating the adjustment of the test antenna and generator output.
- K) Repeat step J) with both antennas vertically polarized for each spurious frequency.
- L) Calculate power in dBm into a reference ideal half-wave dipole antenna by reducing the readings obtained in steps J) and K) by the power loss in the cable between the generator and the antenna and further corrected for the gain of the substitution antenna used relative to an ideal half-wave dipole antenna.
- M) The levels recorded in step L) are absolute levels of radiated spurious emissions in dBm. The radiated spurious emissions in dB can be calculated by the following:

Radiated spurious emissions dB =

$$10\log_{10}(\text{TX power in watts}/0.001) - \text{the levels in step I)}$$

NOTE: It is permissible that other antennas provided can be referenced to a dipole.

Test Equipment

Asset	Description	s/n
Transducer		
i00088	EMCO 3109-B 25MHz-300MHz	2336
X i00089	Apriel 2001 200MHz-1GHz	001500
X i00103	EMCO 3115 1GHz-18GHz	9208-3925
Amplifier		
X i00028	HP 8449A	2749A00121
Spectrum Analyzer		
X i00029	HP 8563E	3213A00104
X i00033	HP 85462A	3625A00357
Substitution Generator		
X i00067	HP 8920A Communication TS	3345U01242
i00207	HP 8753D Network Analyzer	3410A08514
Microphone, Antenna Port, and Cabling		
Microphone	<u>No</u>	Cable Length <u> - </u> Meters
Antenna Port Terminated	<u>Yes</u>	Load <u> Yes </u> Antenna Gain <u> - </u>
All Ports Terminated by Load	<u>Yes</u>	Peripheral <u> No </u>

Name of Test: Field Strength of Spurious Radiation

Measurement Results

Limit = -13dBm

g0650096: 2006-May-09 Tue 10:31:00

STATE: 1:Low Power, 25kHz Channel

Ambient Temperature: 33°C ± 3°C

Frequency Tuned, MHz	Frequency Emission, MHz	ERP, dBm	ERP, dBc
137.025000	274.050000	-67.6	
155.025000	310.050000	-68.5	
173.975000	347.950000	-74.9	
137.025000	411.075000	-78.4	
155.025000	465.075000	-74.6	
173.975000	521.925000	-76.3	
137.025000	548.100000	-72.0	
155.025000	620.100000	-70.7	
137.025000	685.125000	-38.1	
173.975000	695.900000	-65.2	
155.025000	775.125000	-69.4	
137.025000	822.150000	-69.4	
173.975000	869.875000	-62.1	
155.025000	930.150000	-65.3	≥ -68.1
137.025000	959.175000	-67.6	
173.975000	1043.850000	-74.0	
155.025000	1085.175000	-68.1	
137.025000	1096.200000	-67.1	
173.975000	1217.825000	-66.3	
137.025000	1233.225000	-64.8	
155.025000	1240.200000	-69.6	
137.025000	1370.275000	-67.7	
173.975000	1391.800000	-66.0	
155.025000	1395.225000	-66.8	
155.025000	1550.250000	-69.2	
173.975000	1565.775000	-67.6	
173.975000	1739.750000	-66.6	



Performed by:

David E. Lee, FCC/IC Compliance Manager

Name of Test: Field Strength of Spurious Radiation

Measurement Results

Limit = -20dBm

g0650097: 2006-May-09 Tue 10:38:00

STATE: 1:Low Power, 12.5kHz Channel

Ambient Temperature: 33°C ± 3°C

Frequency Tuned, MHz	Frequency Emission, MHz	ERP, dBm	ERP, dBc
137.025000	274.050000	-62.7	
155.025000	310.050000	-69.7	
173.975000	347.950000	-71.6	
137.025000	411.075000	-76.8	
155.025000	465.075000	-74.3	
173.975000	521.925000	-68.9	
137.025000	548.100000	-70.6	
155.025000	620.100000	-69.4	
137.025000	685.125000	-42.1	
173.975000	695.900000	-64.6	
155.025000	775.125000	-71.0	
137.025000	822.150000	-66.7	
173.975000	869.875000	-66.9	≥ -72.1
155.025000	930.150000	-63.0	
137.025000	959.175000	-68.1	
173.975000	1043.850000	-67.3	
155.025000	1085.175000	-65.3	
137.025000	1096.200000	-66.1	
173.975000	1217.825000	-70.2	
137.025000	1233.225000	-69.2	
155.025000	1240.200000	-66.2	
137.025000	1370.250000	-70.0	
173.975000	1391.800000	-68.3	
155.025000	1395.225000	-68.4	
155.025000	1550.250000	-69.3	
173.975000	1565.775000	-70.8	
173.975000	1739.750000	-69.4	



Performed by:

David E. Lee, FCC/IC Compliance Manager

Name of Test: Field Strength of Spurious Radiation

Measurement Results

Limit = -13dBm

g0650094: 2006-May-09 Tue 09:54:00

STATE: 2:High Power, 25kHz Channel

Ambient Temperature: 33°C ± 3°C

Frequency Tuned, MHz	Frequency Emission, MHz	ERP, dBm	ERP, dBc
137.025000	274.050000	-64.8	
155.025000	310.050000	-70.9	
173.975000	347.950000	-70.4	
137.025000	411.075000	-71.1	
155.025000	465.075000	-72.3	
173.975000	521.925000	-65.1	
137.025000	548.100000	-67.4	
155.025000	620.100000	-66.2	
137.025000	685.125000	-42.1	
173.975000	695.900000	-62.3	
155.025000	775.125000	-64.7	
137.025000	822.150000	-73.0	
173.975000	869.875000	-64.9	≥ -82.1
155.025000	930.150000	-66.7	
137.025000	959.175000	-66.0	
173.975000	1043.850000	-66.8	
155.025000	1085.175000	-69.1	
137.025000	1096.200000	-69.0	
173.975000	1217.825000	-64.8	
137.025000	1233.225000	-68.8	
155.025000	1240.200000	-65.0	
137.025000	1370.250000	-73.9	
173.975000	1391.800000	-65.4	
155.025000	1395.225000	-64.9	
155.025000	1550.250000	-68.0	
173.975000	1565.775000	-67.7	
173.975000	1739.750000	-68.7	



Performed by:

David E. Lee, FCC/IC Compliance Manager

Name of Test: Field Strength of Spurious Radiation

Measurement Results

Limit = -20dBm

g0650095: 2006-May-09 Tue 10:12:00

STATE: 2:High Power, 12.5kHz Channel

Ambient Temperature: 33°C ± 3°C

Frequency Tuned, MHz	Frequency Emission, MHz	ERP, dBm	ERP, dBc
137.025000	274.050000	-56.0	
155.025000	310.050000	-65.9	
173.975000	347.950000	-71.9	
137.025000	411.075000	-73.2	
155.025000	465.075000	-66.0	
173.975000	521.925000	-71.0	
137.025000	548.100000	-68.2	
155.025000	620.100000	-66.1	
137.025000	685.125000	-45.3	
173.975000	695.900000	-73.5	
155.025000	775.125000	-65.9	
137.025000	822.150000	-70.2	
173.975000	869.875000	-59.8	≥ - 85.3
155.025000	930.150000	-60.1	
137.025000	959.175000	-69.2	
173.975000	1043.850000	-67.7	
155.025000	1085.175000	-67.9	
137.025000	1096.200000	-64.8	
173.975000	1217.825000	-66.0	
137.025000	1233.225000	-69.1	
155.025000	1240.200000	-65.0	
137.025000	1370.250000	-64.7	
173.975000	1391.800000	-65.0	
155.025000	1395.225000	-64.2	
155.025000	1550.250000	-62.9	
173.975000	1565.775000	-63.6	
173.975000	1739.750000	-66.3	



Performed by:

David E. Lee, FCC/IC Compliance Manager

Name of Test: Emission Masks (Occupied Bandwidth)

Specification: 47 CFR 2.1049(c)(1), 90.210

Guide: ANSI/TIA/EIA-603-C

Measurement Procedure

- A) The EUT and test equipment were set up as shown below
- B) For EUTs supporting audio modulation, the audio signal generator was adjusted to the frequency of maximum response and with output level set for $\pm 2.5/\pm 1.25$ kHz deviation (or 50% modulation). With level constant, the signal level was increased 16 dB.
- C) For EUTs supporting digital modulation, the digital modulation mode was operated to its maximum extent.
- D) The Occupied Bandwidth was measured with the Spectrum Analyzer controls set as shown on the test results.

Transmitter Test Set-Up: Occupied Bandwidth

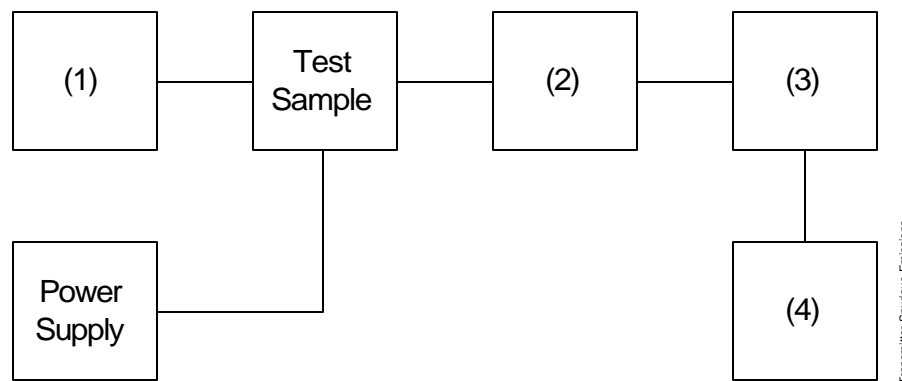

Asset	Description	s/n
(1) Audio Oscillator/Generator		
X i00017	HP 8903A Modulation Meter	2216A01753
(2) Coaxial Attenuator		
X i00231/2	PASTERNAK PE7021-30 (30 dB)	231 or 232
i00123	NARDA 766 (10 dB)	7802A
(3) Interface		
X i00021	HP 8954A Transceiver Interface	2146A00159
(4) Spectrum Analyzer		
X i00048	HP 8566B Spectrum Analyzer	2511A01467
i00029	HP 8563E Spectrum Analyzer	3213A00104

Name of Test: Emission Masks (Occupied Bandwidth)

Measurement Results

Attached as Annex A (High Power) and Annex B (Low Power)

Reference levels taken with SA set RBW = 3MHz

Plots taken with SA set RBW = 300Hz, VBW = 1kHz, Span = 50kHz

Mask B used for 25kHz Channels, Mask D used for 12.5kHz Channels

Name of Test: Transient Frequency Behavior
Specification: 47 CFR 90.214
Guide: ANSI/TIA/EIA-603-C, TIA-102-CAAA

Measurement Procedure

- A) The EUT was setup as shown on the attached page, following TIA/EIA-603 steps a, b, and c as a *guide*.
- B) The transmitter was turned on.
- C) Sufficient attenuation was provided so that the transmitter carrier level measured at the output of the combiner was 40 dB below the maximum input level of the test receiver. This level was recorded.
- D) The transmitter was turned off.
- E) An RF signal generator (1) modulated with a 1 kHz tone at either 25, 12.5, or 6.25 kHz deviation, and set to the same frequency as the assigned transmitter frequency, (2) was adjusted to a level -20 dB below the level recorded for step C) above, measured at the output of the combiner. This level was then fixed for the remainder of the test.
- F) The oscilloscope was setup using TIA/EIA-603 steps j and k as a guide, and to either 10 ms/div (UHF) or 5 ms/div (VHF).
- G) The 30 dB attenuator was removed, the transmitter was turned on, and the level of the carrier at the output of the combiner was recorded.
- H) The carrier on-time as referenced in TIA/EIA-603 steps m, n, and o was captured and plotted. The carrier off-time as referenced in TIA/EIA-603 steps p, q, r, and s was captured and plotted.

Name of Test: Transient Frequency Behavior

Transmitter Set-Up

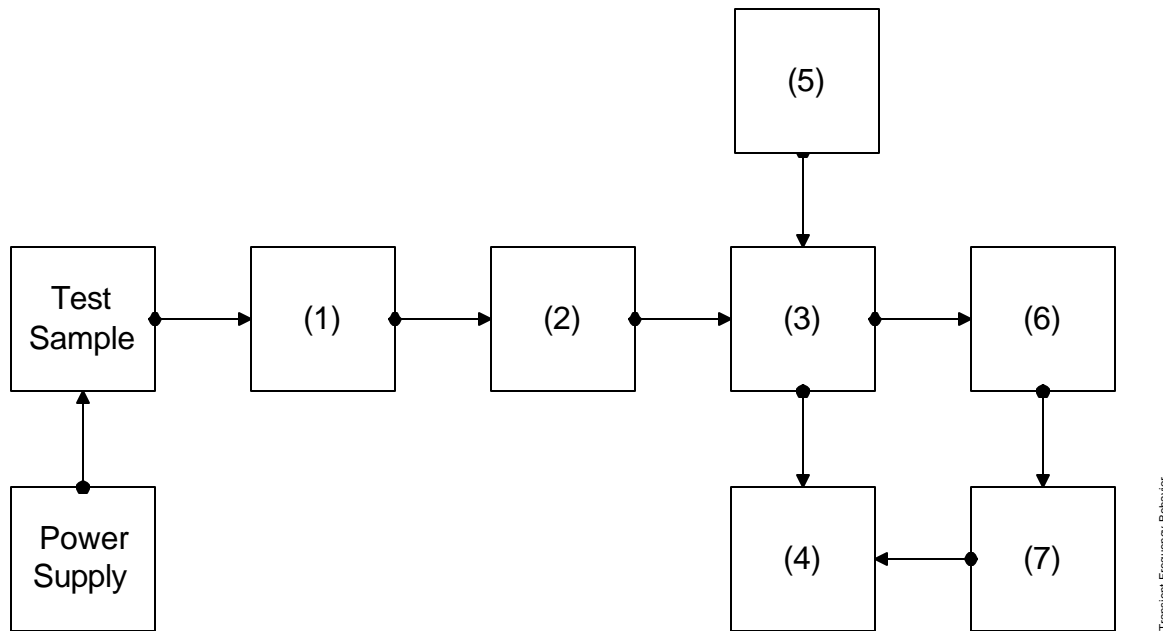

Asset	Description	s/n
(1) Attenuator	(Removed after 1st step)	
X i00231/2	PASTERNAK PE7021-30 (30 dB)	231 or 232
(2) Attenuator		
X i00231/2	PASTERNAK PE7021-30 (30 dB)	231 or 232
i00122/3	NARDA 766 (10 dB)	7802 or 7802A
(3) Combiner		
X i00154	4 x 25 Ω Combiner	154
(4) Crystal Decoder		
X i00159	HP 8470B Crystal Detector	1822A10054
(5) RF Signal Generator		
X i00067	HP 8920A Communication TS	3345U01242
(6) Modulation Analyzer		
X i00020	HP 8901A Modulation Meter	2105A01087
(7) Oscilloscope		
X i00030	HP 54502A Digital Oscilloscope	2927A00209

Name of Test: Transient Frequency Behavior

State: Ambient Temperature: 23°C ± 3°C

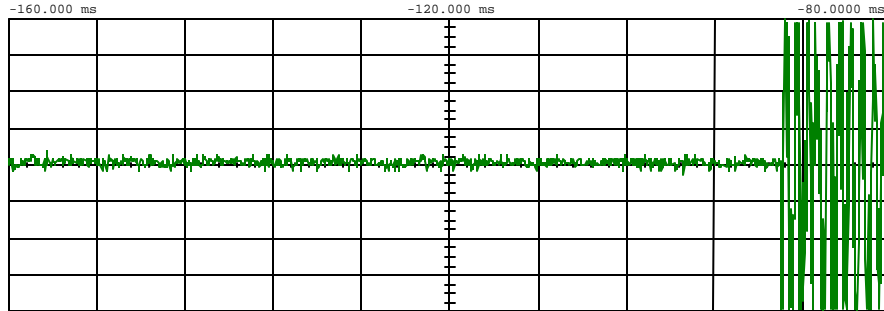

	Timebase	Delay/Pos	Reference	Mode
Main	8.00 ms/div	-120.000 ms	Center	Realtime (EXTENDED)
Channel 1	Sensitivity 8.00 mV/div	Offset 5.000 mV	Probe 1.000 :1	Coupling dc (1M ohm)

Trigger mode : Edge
On Positive Edge Of Chan2
Trigger Level
Chan2 = -175.000 mV (noise reject ON)
Holdoff = 40.000 ns

Power:
Modulation:
Description:

High
12.5 kHz Deviation
XTS-5000A VHF

Performed by:

David E. Lee, FCC/IC Compliance Manager

Name of Test: Transient Frequency Behavior

State: Carrier Off Time

Ambient Temperature: 22°C ± 3°C

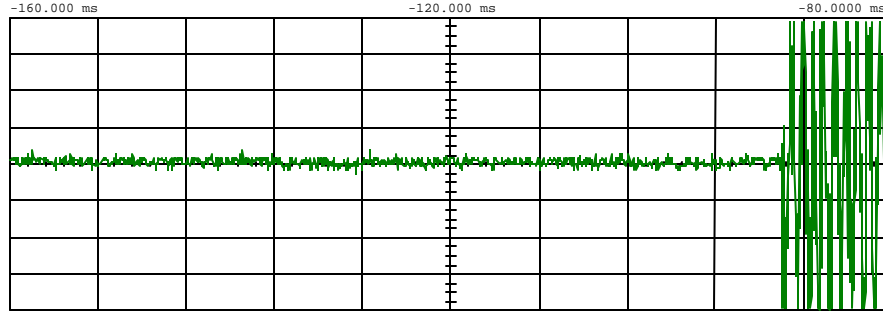

	Timebase	Delay/Pos	Reference	Mode
Main	8.00 ms/div	-120.000 ms	Center	Realtime (EXTENDED)
Channel 1	Sensitivity	Offset	Probe	Coupling
	8.00 mV/div	5.000 mV	1.000 :1	dc (1M ohm)

Trigger mode : Edge
 On Positive Edge Of Chan2
 Trigger Level
 Chan2 = -175.000 mV (noise reject ON)
 Holdoff = 40.000 ns

Power:
 Modulation:
 Description:

High
 25 kHz Deviation
 XTS-5000A VHF

Performed by:

David E. Lee, FCC/IC Compliance Manager

Name of Test: Transient Frequency Behavior

State: Carrier On Time

Ambient Temperature: 22°C ± 3°C

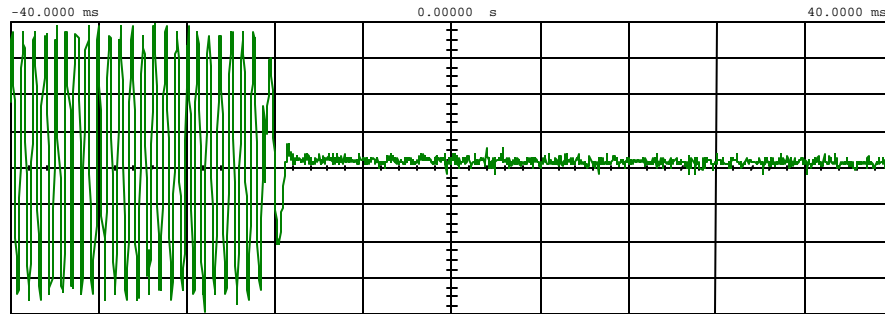

Main	Timebase 8.00 ms/div	Delay/Pos -40.0000 ms	Reference Left	Mode Realtime (EXTENDED)
Channel 1	Sensitivity 8.00 mV/div	Offset 5.000 mV	Probe 1.000 :1	Coupling dc (1M ohm)

Trigger mode : Edge
On Negative Edge Of Chan2
Trigger Level
Chan2 = -325.000 mV (noise reject ON)
Holdoff = 40.000 ns

Power:
Modulation:
Description:

High
25 kHz Deviation
XTS-5000A VHF

Performed by:

David E. Lee, FCC/IC Compliance Manager

Name of Test: Transient Frequency Behavior

State: Carrier On Time

Ambient Temperature: 22°C ± 3°C

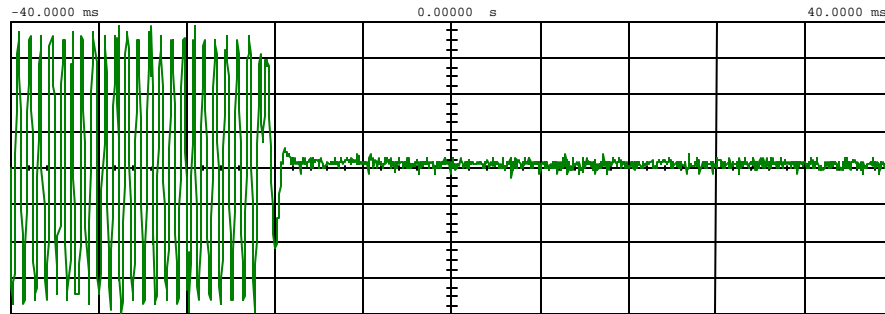

Main	Timebase 8.00 ms/div	Delay/Pos -40.0000 ms	Reference Left	Mode Realtime (EXTENDED)
Channel 1	Sensitivity 8.00 mV/div	Offset 5.000 mV	Probe 1.000 :1	Coupling dc (1M ohm)

Trigger mode : Edge
On Negative Edge Of Chan2
Trigger Level
Chan2 = -325.000 mV (noise reject ON)
Holdoff = 40.000 ns

Power:
Modulation:
Description:

High
12.5 kHz Deviation
XTS-5000A VHF

Performed by:

David E. Lee, FCC/IC Compliance Manager

Name of Test: Audio Low Pass Filter (Voice Input)

Specification: 47 CFR 2.1047(a)

Guide: ANSI/TIA/EIA-603-C

Measurement Procedure

- A) The EUT and test equipment were set up such that the audio input was connected at the input to the modulation limiter, and the modulated stage.
- B) The audio output was connected at the output to the modulated stage.

Transmitter Test Set-Up: Response of Low Pass Filter

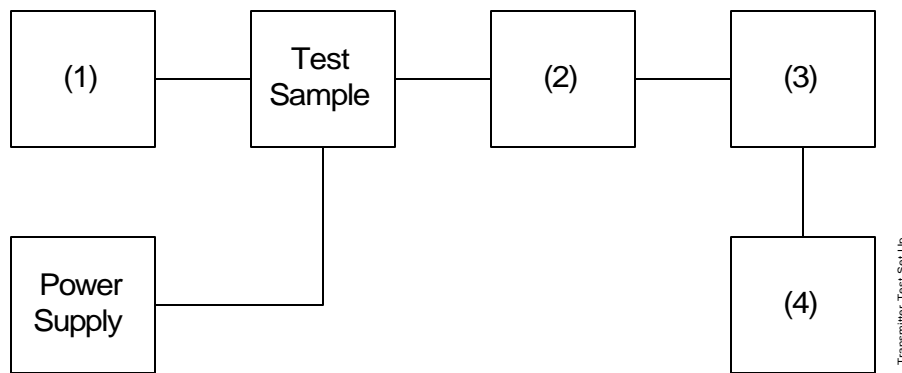

Asset	Description	s/n
(1) Audio Oscillator		
X i00002	HP 3336B Synthesizer / Level Gen.	1931A01465
(2) Coaxial Attenuator		
i00122/3	NARDA 766 (10dB)10	7802 or 7802A
X i00231/2	PASTERNAK PE7021-30 (30 dB)	231 or 232
(3) Modulation Analyzer		
X i00020	HP 8901A Modulation Meter	2105A01087
(4) Audio Analyzer		
X i00001	HP 3586B Selective Level Meter	1928A01360

Name of Test: Audio Low Pass Filter (Voice Input)

Measurement Results

State: Ambient Temperature: 23°C ± 3°C

Low Pass Filter

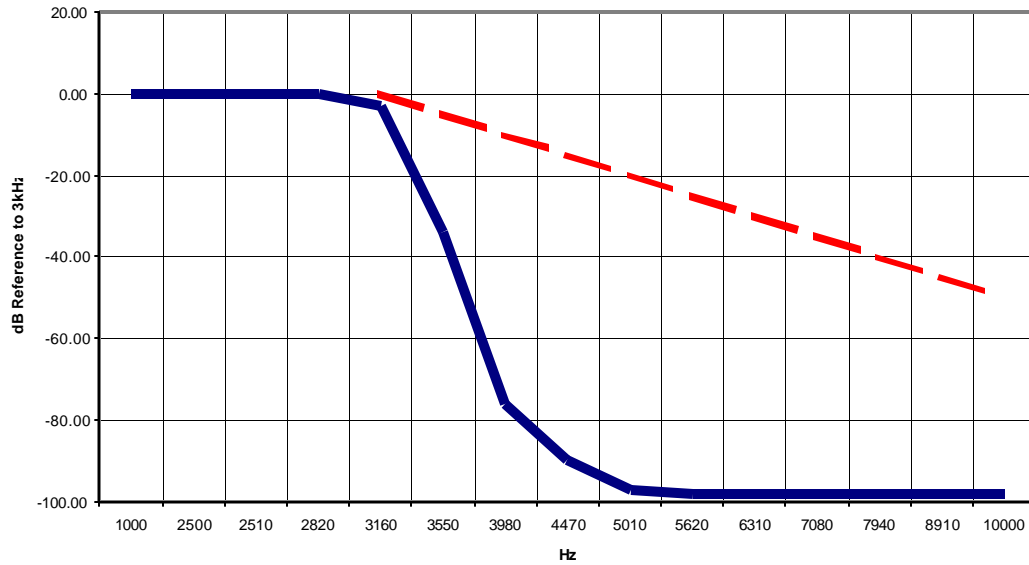

Performed by:

David E. Lee, FCC/IC Compliance Manager

Name of Test: Audio Frequency Response

Specification: 47 CFR 2.1047(a)

Guide: ANSI/TIA/EIA-603-C

Measurement Procedure

- A) The EUT and test equipment were set up as shown below.
- B) The audio signal generator was connected to the audio input circuit/microphone of the EUT.
- C) The audio signal input was adjusted to obtain 20% modulation at 1 kHz, and this point was taken as the 0 dB reference level.
- D) With input levels held constant and below limiting at all frequencies, the audio signal generator was varied from 100 Hz to 50 kHz.
- E) The response in dB relative to 1 kHz was measured, using the HP 8901A Modulation Meter.

Transmitter Test Set-Up: Audio Frequency Response

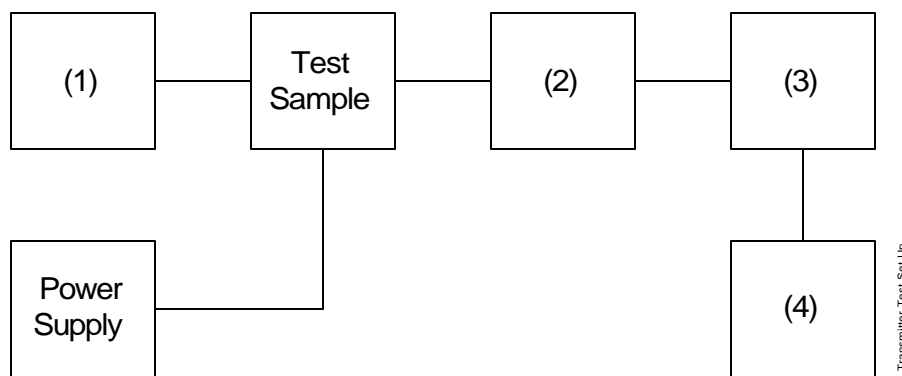

Asset	Description	s/n	Cycle	Last Cal
(1) Audio Oscillator				
X i00017	HP 8903A Audio Analyzer	2216A01753	12 mo.	Apr-05
(2) Coaxial Attenuator				
i00122/3	NARDA 766-(10 dB)	7802 or 7802A	NCR	
X i00231/2	PASTERNAK PE7021-30 (30 dB)	231 or 232	NCR	
(3) Modulation Analyzer				
X i00020	HP 8901A Modulation Meter	2105A01087	12 mo.	May-05
(4) Audio Analyzer				
X i00017	HP 8903A Audio Analyzer	2216A01753	12 mo.	Apr-05

Name of Test: Audio Frequency Response

Measurement Results

State: Ambient Temperature: 23°C ± 3°C

Audio

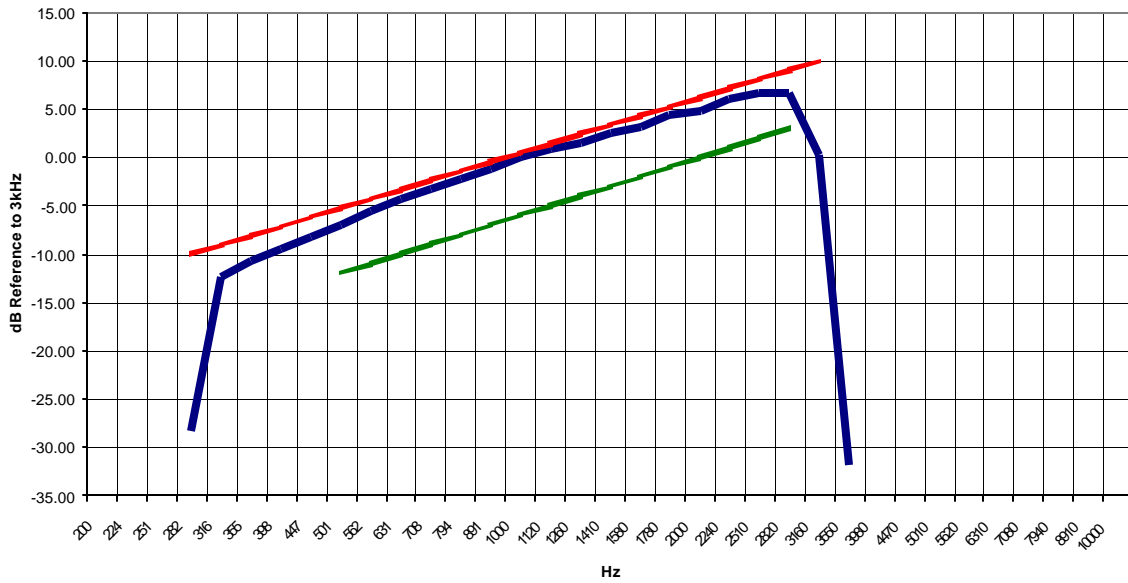

Frequency of Maximum Audio Response, Hz = 2820

Additional points:

Frequency, Hz	Level, dB
300	-10.55
20000	-30.11
30000	-31.60
50000	-32.45

Performed by:

David E. Lee, FCC/IC Compliance Manager

Name of Test: Modulation Limiting

Specification: 47 CFR 2.1047(b)

Guide: ANSI/TIA/EIA-603-C

Measurement Procedure

- A) The signal generator was connected to the input of the EUT as shown below.
- B) The modulation response was measured for each of three frequencies (one of which was the frequency of maximum response), and the input voltage was varied and was observed on an HP 8901A Modulation Analyzer.
- C) The input level was varied from 30% modulation (± 1.5 kHz deviation) to at least 20 dB higher than the saturation point.
- D) Measurements were performed for both negative and positive modulation and the respective results were recorded.

Transmitter Test Set-Up: Modulation Limiting

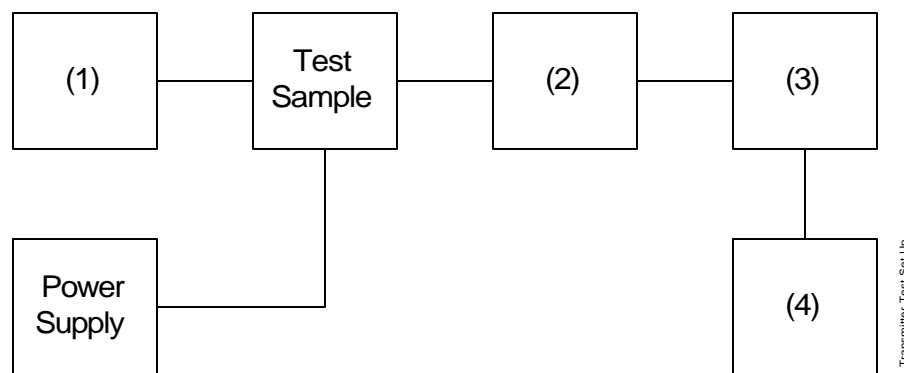

Asset	Description	s/n
(1) Audio Oscillator		
X i00017	HP 8903A Audio Analyzer	2216A01753
(2) Coaxial Attenuator		
i0012/23	NARDA 766-(10 dB)	7802 or 7802A
X i00231/2	PASTERNAK PE7021-30 (30 dB)	231 or 232
(3) Modulation Analyzer		
X i00020	HP 8901A Modulation Meter	2105A01087
(4) Audio Analyzer		
X i00017	HP 8903A Audio Analyzer	2216A01753

Name of Test: Modulation Limiting

Measurement Results

g0650008: 2006-May-8 Mon 16:06:00
 State: 0:General

Ambient Temperature: 23°C ± 3°C

Positive
 Peaks:

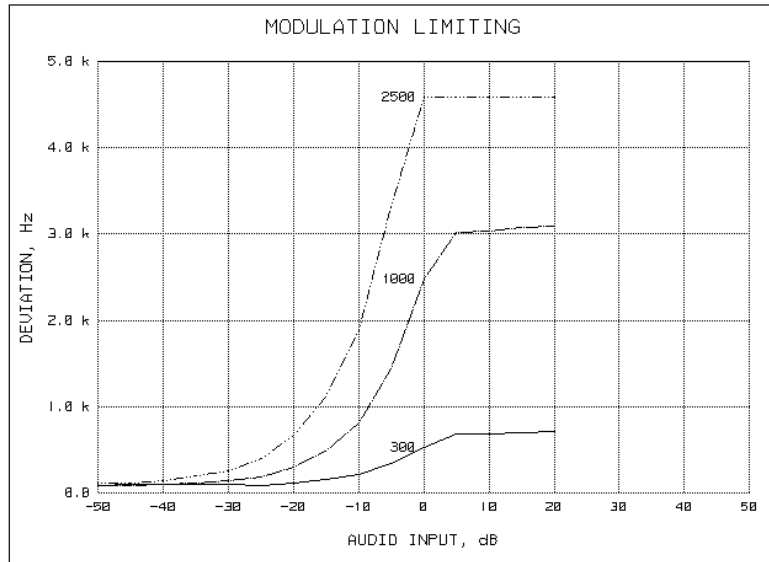

Negative
 Peaks:

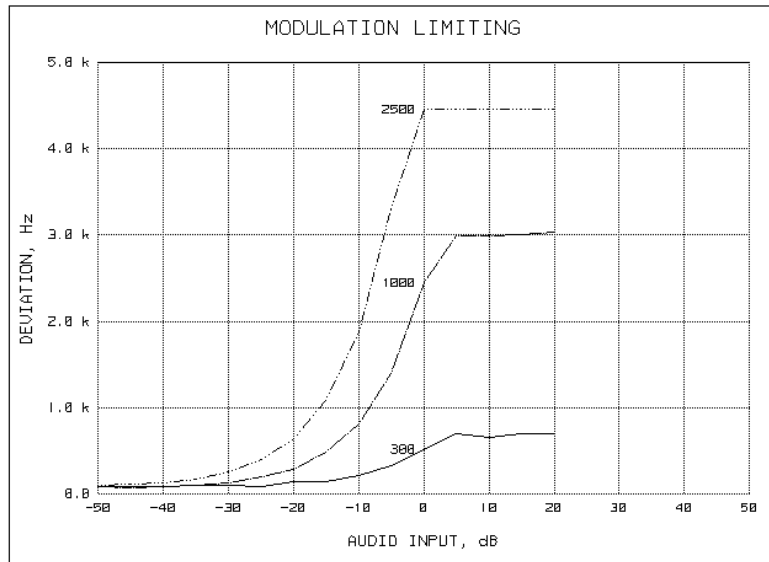

Performed by:

David E. Lee, FCC/IC Compliance Manager

Name of Test: Modulation Limiting

Measurement Results

g0650009: 2006-May-08 Mon 16:09:00
 State: 0:General

Ambient Temperature: 23°C ± 3°C

Positive
 Peaks:

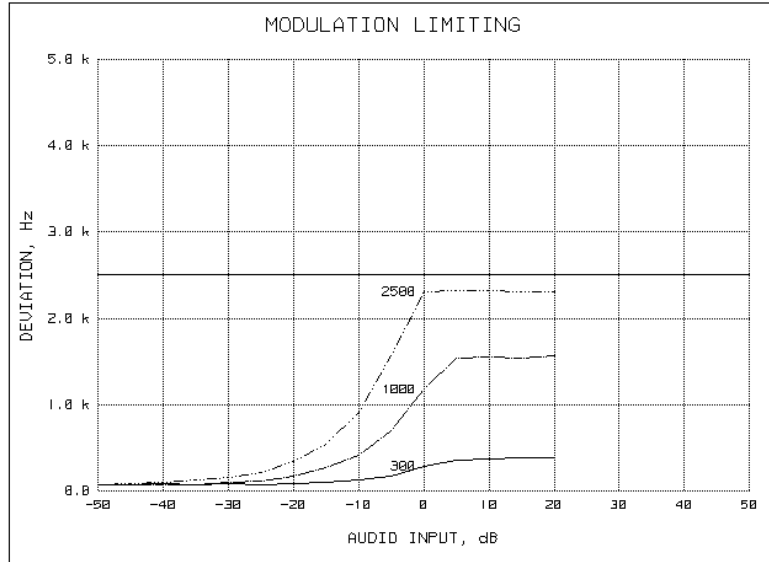

Negative
 Peaks:

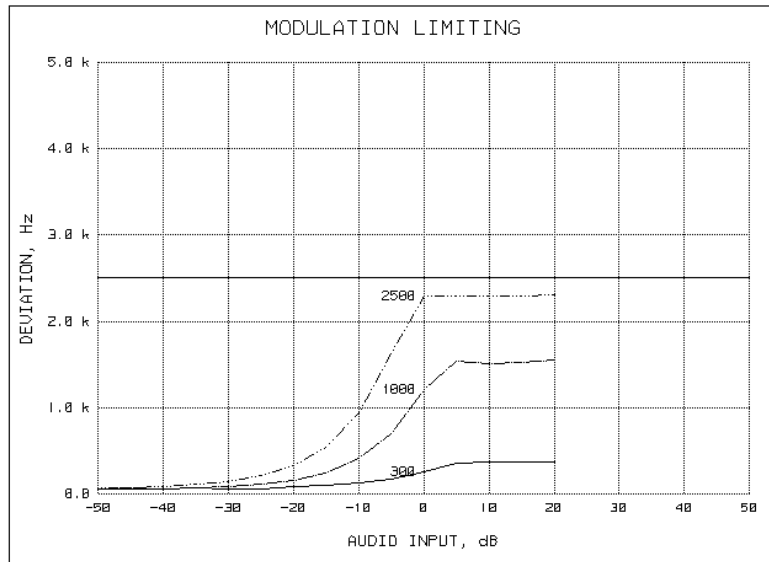

Performed by:

David E. Lee, FCC/IC Compliance Manager

Name of Test: Frequency Stability (Temperature Variation)

Specification: 47 CFR 2.1055(a)(1)

Guide: ANSI/TIA/EIA-603-C

Measurement Procedure

- A) The EUT and test equipment were set up as shown on the following page.
- B) With all power removed, the temperature was decreased to -30°C and permitted to stabilize for three hours. Power was applied and the maximum change in frequency was noted within one minute.
- C) With power OFF, the temperature was raised in 10°C steps. The sample was permitted to stabilize at each step for at least one-half hour. Power was applied and the maximum frequency change was noted within one minute.
- D) The temperature tests were performed for the worst case.

Transmitter Test Set-Up: Temperature Variation

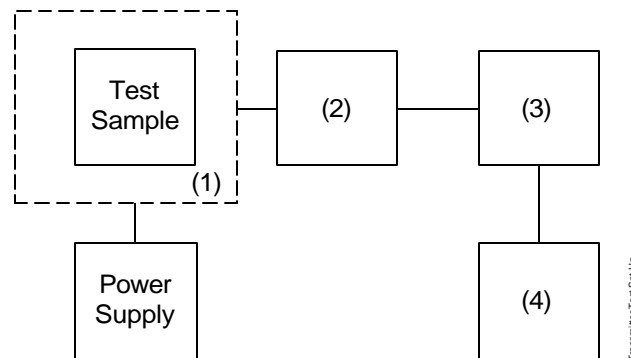

Asset	Description	s/n
(1) Temperature, Humidity, Vibration		
X i00027	Tenney Temp. Chamber	9083-765-234
(2) Coaxial Attenuator		
X i00231/2	PASTERNAK PE7021-30 (30 dB)	231 or 232
i00122/3	NARDA 766 (10 dB)	7802 or 7802A
(3) RF Power		
X i00067	HP 8920A Communications TS	3345U01242
(4) Frequency Counter		
X i00067	HP 8920A Communications TS	3345U01242

Name of Test: Frequency Stability (Temperature Variation)

Measurement Results

State: Ambient Temperature: 23°C ± 3°C

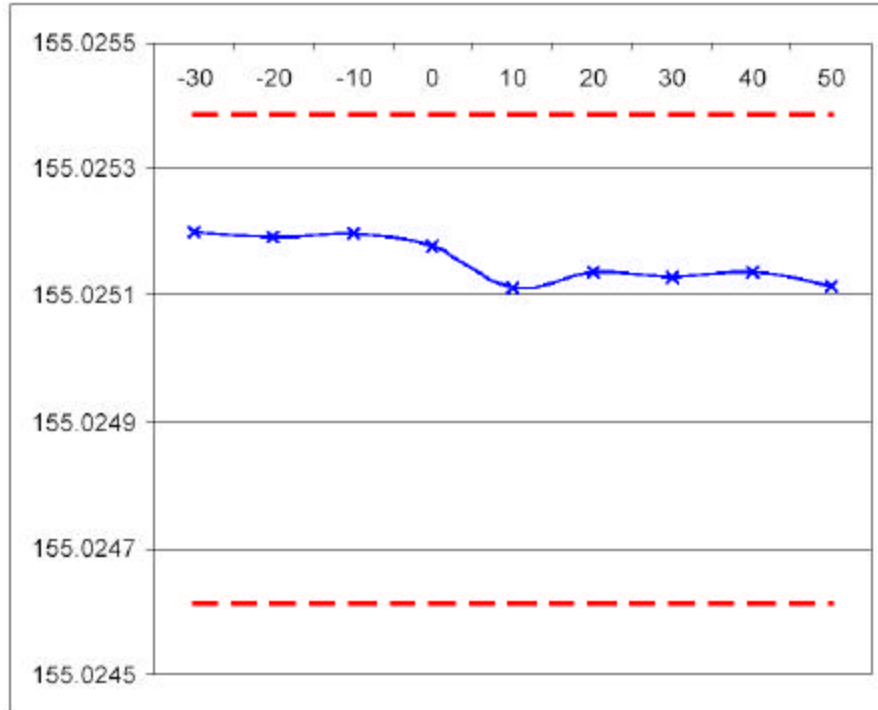

Performed by:

David E. Lee, FCC/IC Compliance Manager

Name of Test: Frequency Stability (Voltage Variation)

Specification: 47 CFR 2.1055(d)(1)

Guide: ANSI/TIA/EIA-603-C

Measurement Procedure

- A) The EUT was placed in a temperature chamber (if required) at 25±5°C and connected as shown below.
- B) The power supply voltage to the EUT was varied from 85% to 115% of the nominal value measured at the input to the EUT.
- C) The variation in frequency was measured for the worst case.

Transmitter Test Set-Up: Voltage Variation

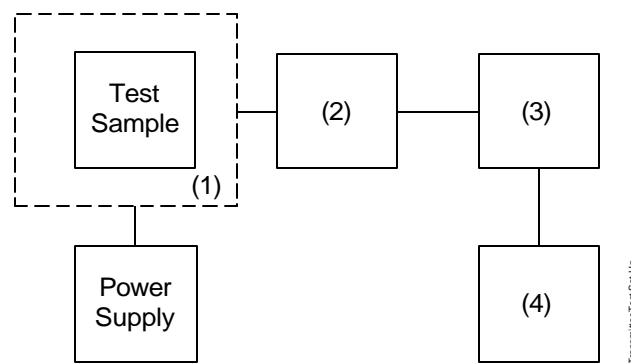

Asset	Description	s/n
(1) Temperature, Humidity, Vibration		
i00027	Tenney Temp. Chamber	9083-765-234
(2) Coaxial Attenuator		
X i00231/2	PASTERNAK PE7021-30 (30 dB)	231 or 232
i00122/3	NARDA 766 (10 dB)	7802 or 7802A
(3) RF Power		
X i00020	HP 8901A Power Mode	2105A01087
(4) Frequency Counter		
X i00020	HP 8901A Frequency Mode	2105A01087

Results: Frequency Stability (Voltage Variation)

State: Ambient Temperature: 23°C ± 3°C

Limit, ppm = ±2.5
 Limit, Hz = ±387.5
 Battery End Point (Voltage) = 21.5

% of STV	Voltage	Frequency, MHz	Change, Hz	Change, ppm
115	32.2	155.025080	+80	>1
100	28.0	155.025090	+90	>1
85	23.8	155.025100	+100	>1
BEP	21.5	155.025090	+90	>1



Performed by:

David E. Lee, FCC/IC Compliance Manager

Name of Test: Necessary Bandwidth and Emission Bandwidth

Specification: 47 CFR 2.202(g)

Modulation = 16K0F3E

Necessary Bandwidth Calculation:

Maximum Modulation (M), kHz	=	3.0
Maximum Deviation (D), kHz	=	5.0
Constant Factor (K)	=	1
Necessary Bandwidth (B _N), kHz	=	(2xM)+(2xDxK)
	=	16.0

Modulation = 11K0F3E

Necessary Bandwidth Calculation:

Maximum Modulation (M), kHz	=	3.0
Maximum Deviation (D), kHz	=	2.5
Constant Factor (K)	=	1
Necessary Bandwidth (B _N), kHz	=	(2xM)+(2xDxK)
	=	11.0

Modulation = 8K10F1E

Necessary Bandwidth Calculation:

Maximum Modulation (M), kHz	=	2.0
Maximum Deviation (D), kHz	=	2.0
Constant Factor (K)	=	1
Necessary Bandwidth (B _N), kHz	=	(2xM)+(2xDxK)
	=	8.1

Modulation = 8K10F1D

Necessary Bandwidth Calculation:

Maximum Modulation (M), kHz	=	2.0
Maximum Deviation (D), kHz	=	2.0
Constant Factor (K)	=	1
Necessary Bandwidth (B _N), kHz	=	(2xM)+(2xDxK)
	=	8.1

Modulation = 20K0F1E

Necessary Bandwidth Calculation:

Maximum Modulation (M), kHz	=	6.0
Maximum Deviation (D), kHz	=	4.0
Constant Factor (K)	=	1
Necessary Bandwidth (B _N), kHz	=	(2xM)+(2xDxK)
	=	20.0



Performed by:

David E. Lee, FCC/IC Compliance Manager

END OF TEST REPORT

**Testimonial
and
Statement of Certification**

This is to Certify:

1. **That** the application was prepared either by, or under the direct supervision of, the undersigned.
2. **That** the technical data supplied with the application was taken under my direction and supervision.
3. **That** the data was obtained on representative units, randomly selected.
4. **That**, to the best of my knowledge and belief, the facts set forth in the application and accompanying technical data are true and correct.



Certifying Engineer:

Sam Baum, Technical Manager