

FCC PART 15 Subpart C
EMI MEASUREMENT AND TEST REPORT
FOR
LG INFORMATION & COMMUNICATIONS, LTD.

LG Kangseo B/D, 36, Munlae-Dong, 6-Ga,
Youngdungpo-Gu, Seoul, 150-096, Korea

FCC ID: FFMGT8110

March 4, 2000

This Report Concerns: <input checked="" type="checkbox"/> Original Report	Equipment Type: Digital Spread Spectrum Cordless Phone – Household Appliances
Test Engineer:	Thomas Huang / John Chan
Test Date:	February 24, 2000
Reviewed By:	John Y. Chan – Engineering Manager
Prepared By:	Bay Area Compliance Laboratory Corporation 230 Commercial Street, Suite 2 Sunnyvale, CA 94086 (408) 732-9162

Note: This report may not be duplicated without prior written consent of Bay Area Compliance Laboratory Corporation. This report **must not** be used by the client to claim product endorsement by NVLAP or any agency of the U.S. Government.

TABLE OF CONTENTS

1 - GENERAL INFORMATION 3

1.1 PRODUCT DESCRIPTION FOR EQUIPMENT UNDER TEST (EUT) 3

1.2 OBJECTIVE..... 3

1.3 RELATED SUBMITTAL(S)/GRANT(S) 3

1.4 TEST METHODOLOGY 3

1.5 TEST FACILITY 4

1.6 TEST EQUIPMENT LIST 4

1.7 EQUIPMENT UNDER TEST (EUT) 5

1.8 SUPPORT EQUIPMENT 5

1.9 EUT CONFIGURATION DETAILS AND LIST 5

1.10 EXTERNAL I/O CABLING..... 5

2 - SYSTEM TEST CONFIGURATION..... 6

2.1 JUSTIFICATION..... 6

2.2 BLOCK DIAGRAM 6

2.3 TEST SETUP BLOCK DIAGRAM..... 7

FOR BASE: 8

2.4 EQUIPMENT MODIFICATIONS 9

3.0 SUMMARY OF TEST RESULTS..... 10

3.1.0 PEAK OUTPUT POWER..... 10

3.2.0 6 DB BANDWIDTH..... 18

3.3.0 POWER DENSITY 31

3.4.0 BAND EDGES TESTING 38

3.5.0 SPURIOUS EMISSIONS 45

3.6.0 FIELD STRENGTH OF SPURIOUS RADIATION (30 MHZ-90000MHZ)..... 58

3.7.0 PROCESSING GAIN..... 63

4 - CONDUCTED EMISSIONS TEST DATA 66

4.1 MEASUREMENT UNCERTAINTY 66

4.2 EUT SETUP 66

4.3 SPECTRUM ANALYZER SETUP..... 66

4.4 TEST PROCEDURE..... 67

4.5 SUMMARY OF TEST RESULTS..... 67

4.6 CONDUCTED EMISSIONS TEST DATA 67

4.7 PLOT OF CONDUCTED EMISSIONS TEST DATA..... 67

APPENDIX A – AGENT AUTHORIZATION LETTER..... 69

1 - GENERAL INFORMATION

1.1 Product Description for Equipment Under Test (EUT)

The *LG Information & Communications, Ltd.*, FCC ID *FFMGT8110* or the "EUT" as referred to in this report is a Digital Spread Spectrum Cordless Phone which has 20 channel possible in the 904-926 MHz Bandwidth, and the transmission range up to 1 Km in open sight (longer range than analog 900MHz cordless phone).

The EUT was composed of two parts: one is the handset which measures 9" L x 2.125" W x 1.675" H, the other is the base which measures 7" L x 5.5" W x 2.25" H.

1.2 Objective

This type approval report is prepared on behalf of *LG Information & Communications, Ltd.* in accordance with Part 2, Subpart J, Part 15, Subparts A and B of the Federal Communication Commissions rules.

The objective of the manufacturer is to demonstrate compliance with FCC rules for Output Power, 6 dB Bandwidth, Power Density, Band Edge, Spurious Emission, Processing Gain, Antenna Gain, and Conducted and Radiated Emission.

1.3 Related Submittal(s)/Grant(s)

No Related Submittals

1.4 Test Methodology

All measurements contained in this report were conducted with ANSI C63.4 –1992, American National Standard for Methods of Measurement of Radio-Noise Emissions from Low-Voltage Electrical and Electronic Equipment in the range of 9 kHz to 40 GHz. All radiated and conducted emissions measurement was performed at Bay Area Compliance Laboratory, Corp. The radiated testing was performed at an antenna-to-EUT distance of 3 meters.

1.5 Test Facility

The Open Area Test site used by Bay Area Compliance Laboratory Corporation to collect radiated and conducted emission measurement data is located in the back parking lot of the building at 230 Commercial Street, Suite 2, Sunnyvale, California, USA.

Test sites at Bay Area Compliance Laboratory Corporation has been fully described in reports submitted to the Federal Communication Commission (FCC) and Voluntary Control Council for Interference (VCCI). The details of these reports has been found to be in compliance with the requirements of Section 2.948 of the FCC Rules on February 11 and December 10, 1997 and Article 8 of the VCCI regulations on December 25, 1997. The facility also complies with the radiated and AC line conducted test site criteria set forth in ANSI C63.4-1992.

The Federal Communications Commission and Voluntary Control Council for Interference has the reports on file and is listed under FCC file 31040/SIT 1300F2 and VCCI Registration No.: C-674 and R-657. The test sites has been approved by the FCC and VCCI for public use and is listed in the FCC Public Access Link (PAL) database.

Additionally, Bay Area Compliance Laboratory Corporation is a National Institute of Standards and Technology (NIST) accredited laboratory, under the National Voluntary Laboratory Accredited Program (NVLAP). The scope of the accreditation covers the FCC Method - 47 CFR Part 15 - Digital Devices, IEC/CISPR 22: 1993, and AS/NZS 3548: Electromagnetic Interference - Limits and Methods of Measurement of Information Technology Equipment test methods under NVLAP Lab Code 200167-0.

1.6 Test Equipment List

Manufacturer	Description	Model	Serial Number	Cal. Due Data
HP	Spectrum Analyzer	8566B	2610A02165	12/6/00
HP	Spectrum Analyzer	8593B	2919A00242	12/20/00
HP	Amplifier	8349B	2644A02662	12/20/00
HP	Quasi-Peak Adapter	85650A	917059	12/6/00
HP	Amplifier	8447E	1937A01046	12/6/00
A.H. System	Horn Antenna	SAS0200/571	261	12/27/00
Com-Power	Log Periodic Antenna	AL-100	16005	11/2/00
Com-Power	Biconical Antenna	AB-100	14012	11/2/00
Solar Electronics	LISN	8012-50-R-24-BNC	968447	12/28/00
Com-Power	LISN	LI-200	12208	12/20/00
Com-Power	LISN	LI-200	12005	12/20/00
BACL	Data Entry Software	DES1	0001	12/20/00
Rohde & Schwarz	Signal Generator	SMIQ03B	1125.5555.03	7/10/2002
Rohde & Schwarz	I/Q Modulation Generator	AMIQ	1110.2003.02	8/10/2002

1.7 Equipment Under Test (EUT)

Manufacturer	Description	Model	Serial Number	FCC ID
LG Information & Communications, Ltd.	Handset	GT-8110	None	FFMGT8110
LG Information & Communications, Ltd.	Base	GT-8110	None	FFMGT8110

1.8 Support Equipment

Manufacturer	Description	Model	Serial Number	FCC ID
FUJITSU	Notebook	LiftBook C350	8Y627225	DOC
FUJITSU	AC adapter	CA010007-0600	N/A	DOC

1.9 EUT Configuration Details and List

NOT APPLICABLE

1.10 External I/O Cabling

For Handset:

Cable Description	Length (M)	Port/From	To
Shielded Cable	1	Com1/Host PC	Circuit board of Handset

For Base:

Cable Description	Length (M)	Port/From	To
Shielded Cable	1	Com1/Host PC	Circuit board of Base

2 - SYSTEM TEST CONFIGURATION

2.1 Justification

The EUT was configured for testing in a typical fashion (as normally used in a typical application).

The final qualification test was performed with the EUT operating at normal mode.

2.2 Block Diagram

Appendix A contains a copy of the EUT's block diagram as reference.

2.3 Test Setup Block Diagram

For Handset:

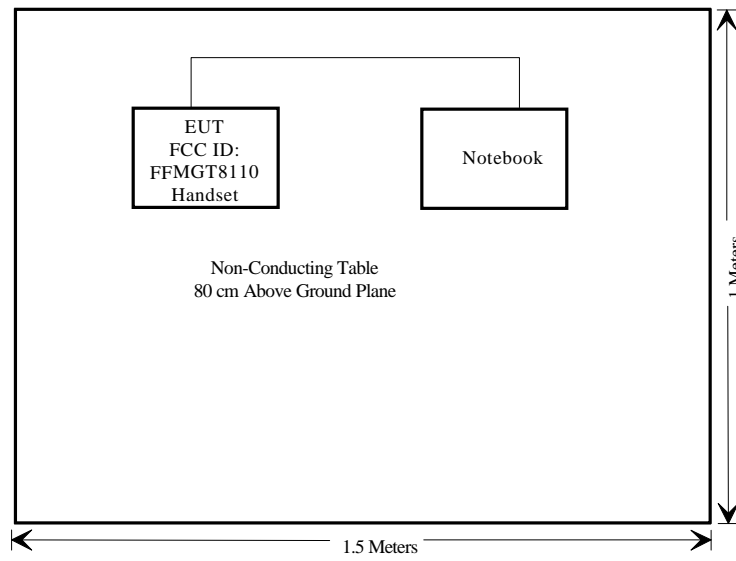

For Base:

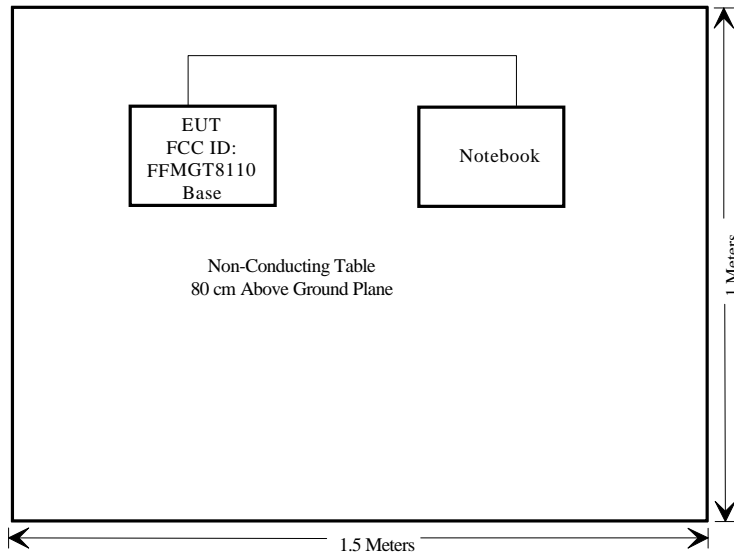

2.4 Equipment Modifications

No modifications were necessary for the EUT to comply.

3.0 Summary of Test Results

FCC RULE	DESCRIPTION OF TEST	RESULT
15.247 (b)	Peak Output Power	Pass
15.247 (a) (2)	6dB Bandwidth	Pass
15.247 (2) (d)	Power Density	Pass
15.247 (2) (c)	Band Edges Testing	Pass
15.247 (2) (c)	Spurious Emission	Pass
15.247, 15.205	Field Strength of Spurious Radiation	Pass
15.207	Conduction Emission	Pass
15.247 (e)	Processing Gain	Pass

3.1.0 Peak Output Power

Requirements: FCC Part 15.247 (b)

3.1.1 Test Procedure

The antenna was removed and SMA connector was connected to the transmitter output. The transmitter output was connected to a calibrated coaxial attenuator (50 Ohm), the other end of which was connected to a spectrum analyzer. Transmitter output was read off the spectrum analyzer in dBm. The power output at the transmitter was determined by adding the value of the attenuator to the spectrum analyzer reading.

The test was performed at three frequencies (low, middle, and high channels) and on all power levels that can be setup on the transmitter.

3.1.2 Test equipment

Hewlett Packard HP8566B Spectrum Analyzer
Hewlett Packard HP 7470A Plotter

3.1.3 Test Results

Refer to the attached to the following plots:

BASE

Peak Output Power	
Low Channel	Page 16
Middle Channel	Page 17
High Channel	Page 18

HANDSET

Peak Output Power	
Low Channel	Page 14
Middle Channel	Page 13
High Channel	Page 15

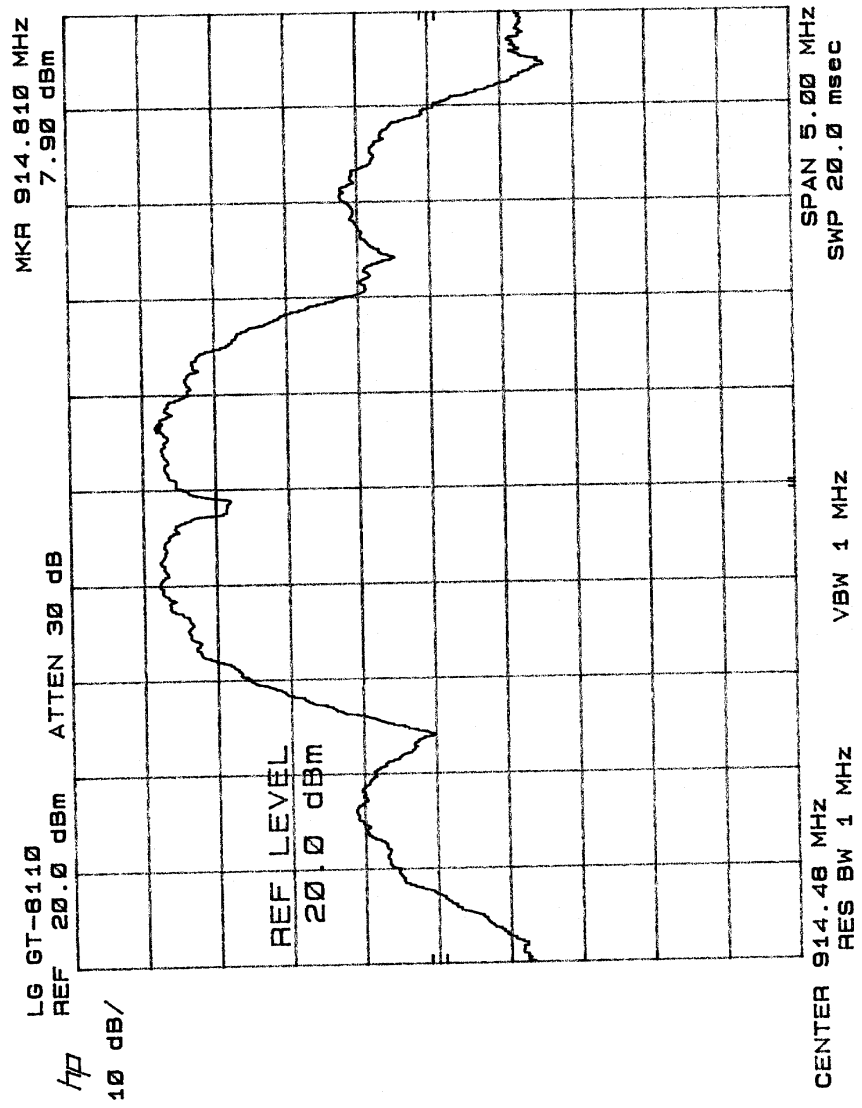

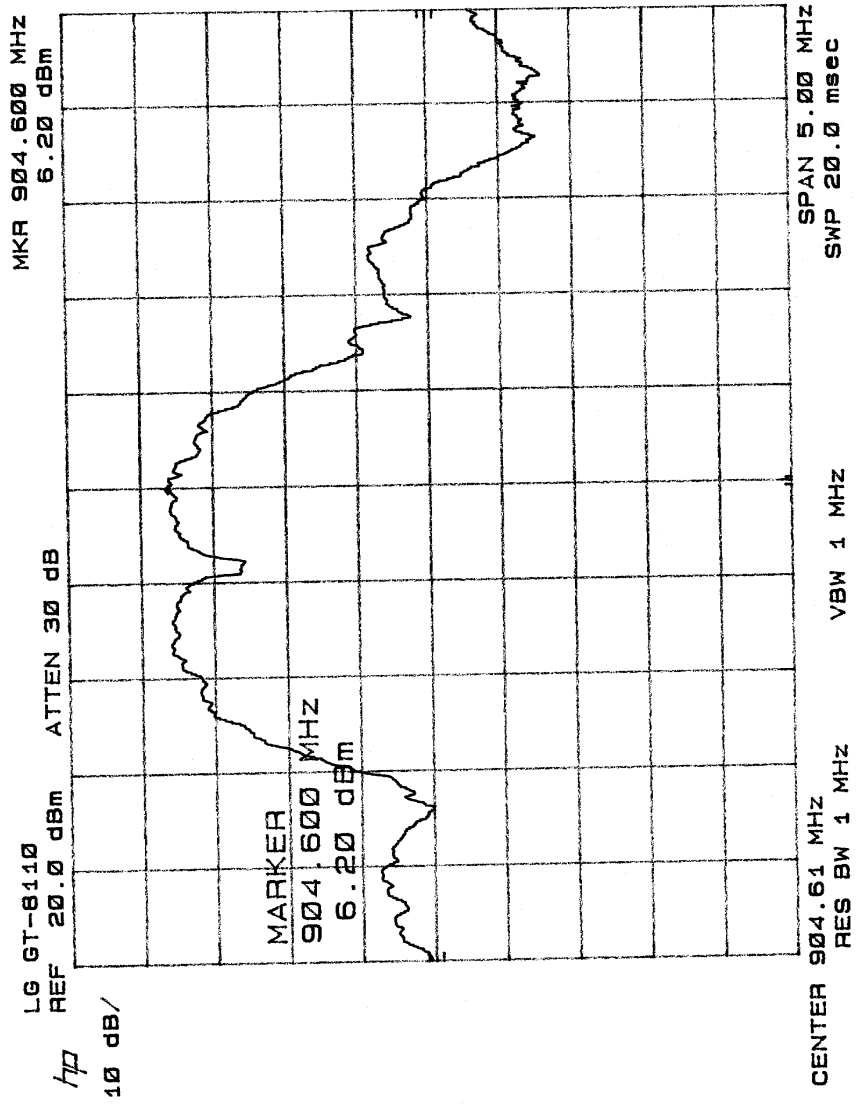

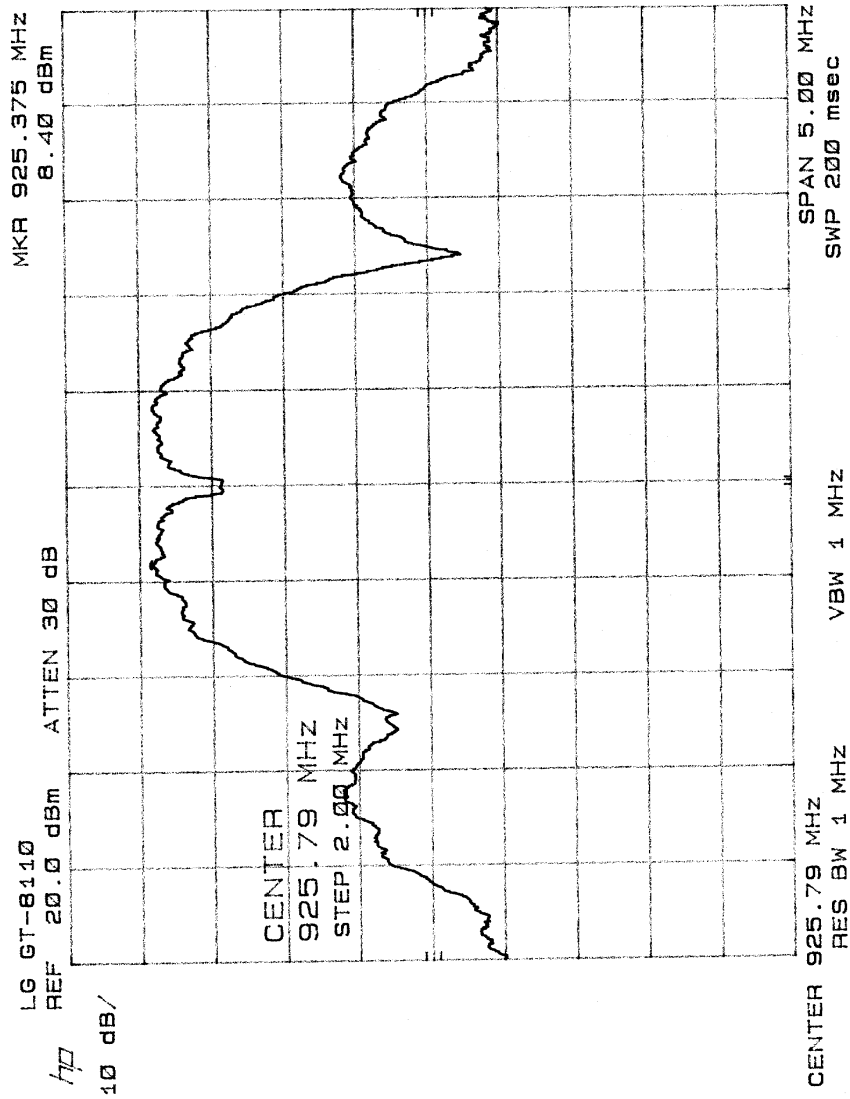

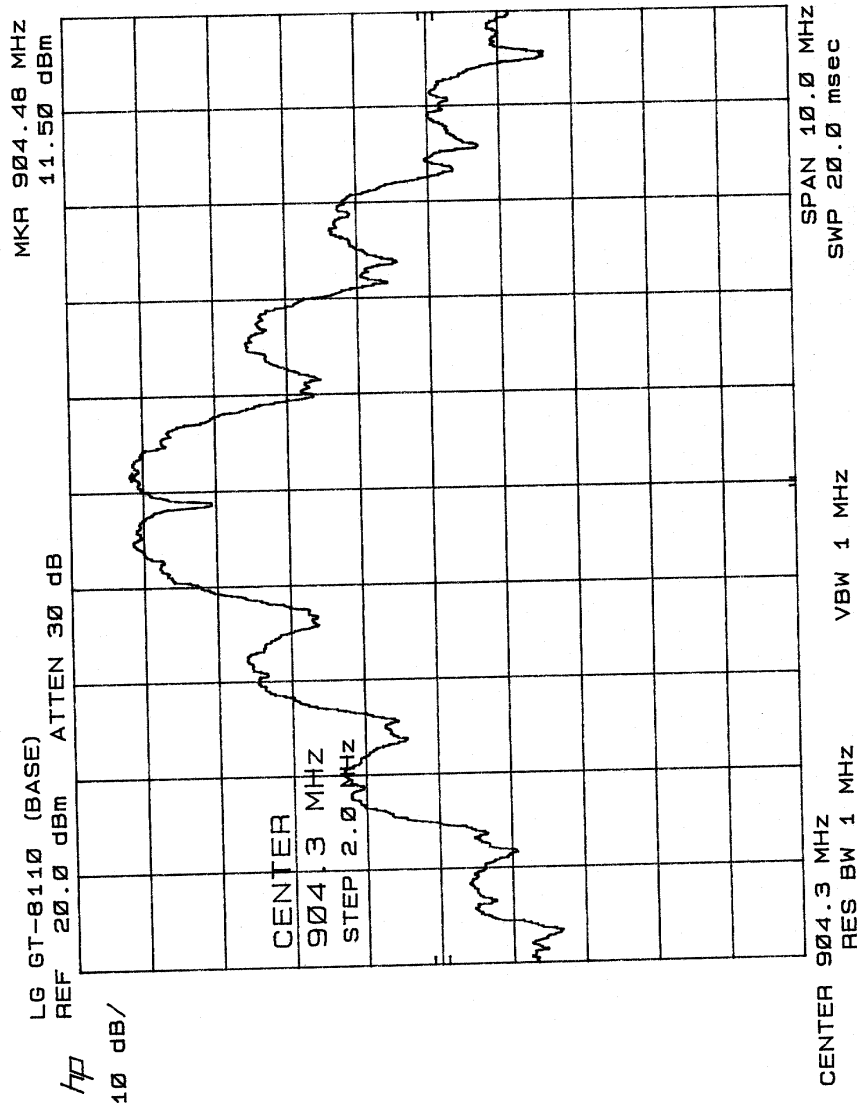

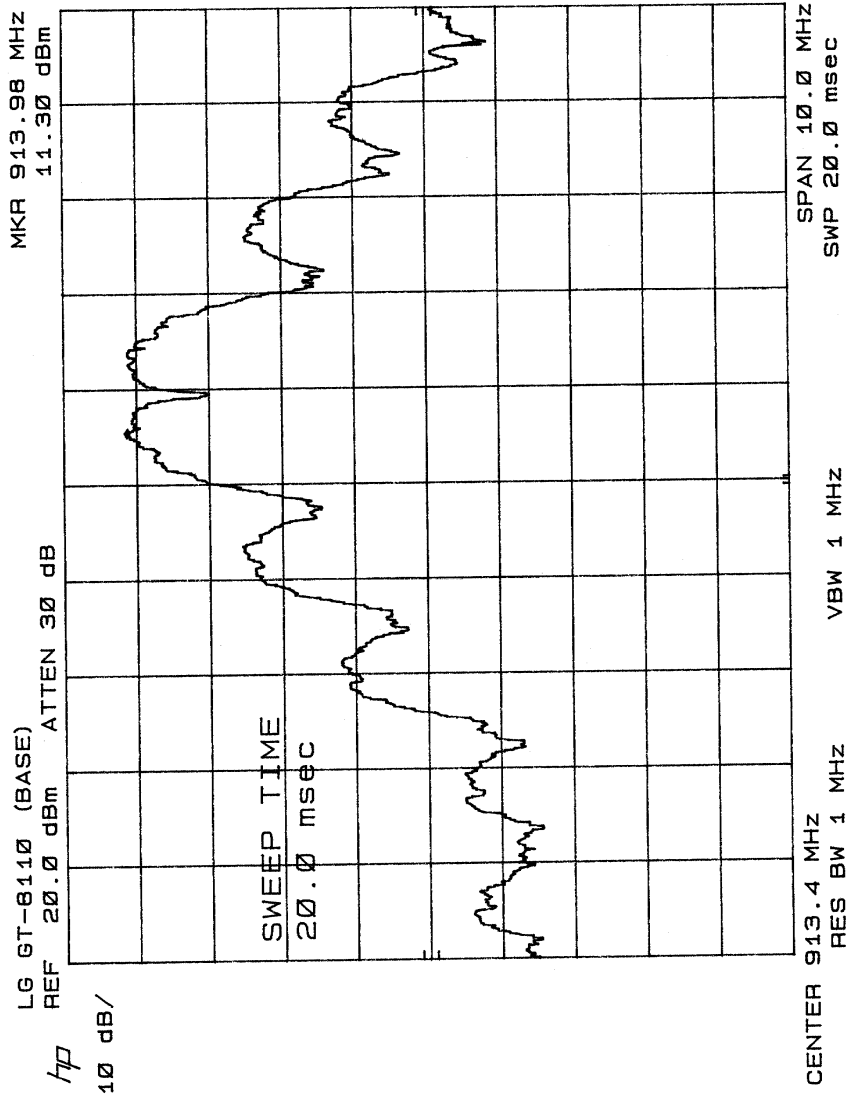

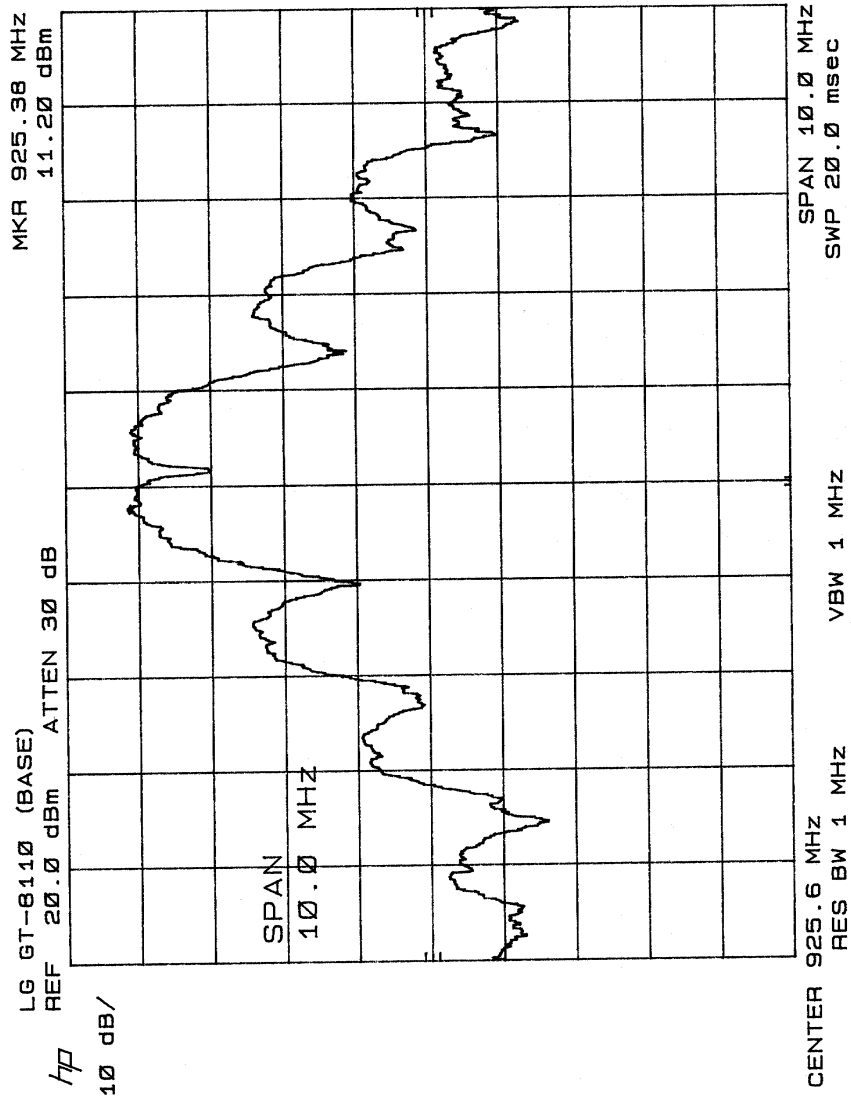

3.2.0 6 dB Bandwidth

Requirement: FCC 15.247 (a)(2), the 6 dB Bandwidth shall not be less than 500 kHz.

3.2.1 Test Procedure

The antenna was removed and SMA connector was connected to the transmitter output. The transmitter output was connected to a calibrated coaxial attenuator (50 Ohm), the other end of which was connected to a spectrum analyzer with the VBW > RBW. Transmitter output was read off the spectrum analyzer in dBm. The power output at the transmitter was determined by adding the value of the attenuator to the spectrum analyzer reading.

The test was performed at three frequencies (low, middle, and high channels) and on all power levels that can be setup on the transmitter.

3.2.2 Test Equipment

Hewlett Packard HP8566B Spectrum Analyzer
 Hewlett Packard HP 7470A Plotter

3.2.3 Test Results:

Included are plots of 6dB bandwidth for low, middle and high channel.

BASE

6dB bandwidth	
Low Channel	Page 26, 27
Middle Channel	Page 28, 29
High Channel	Page 30, 31

HANDSET

6dB bandwidth	
Low Channel	Page 22, 23
Middle Channel	Page 20, 21
High Channel	Page 24, 25

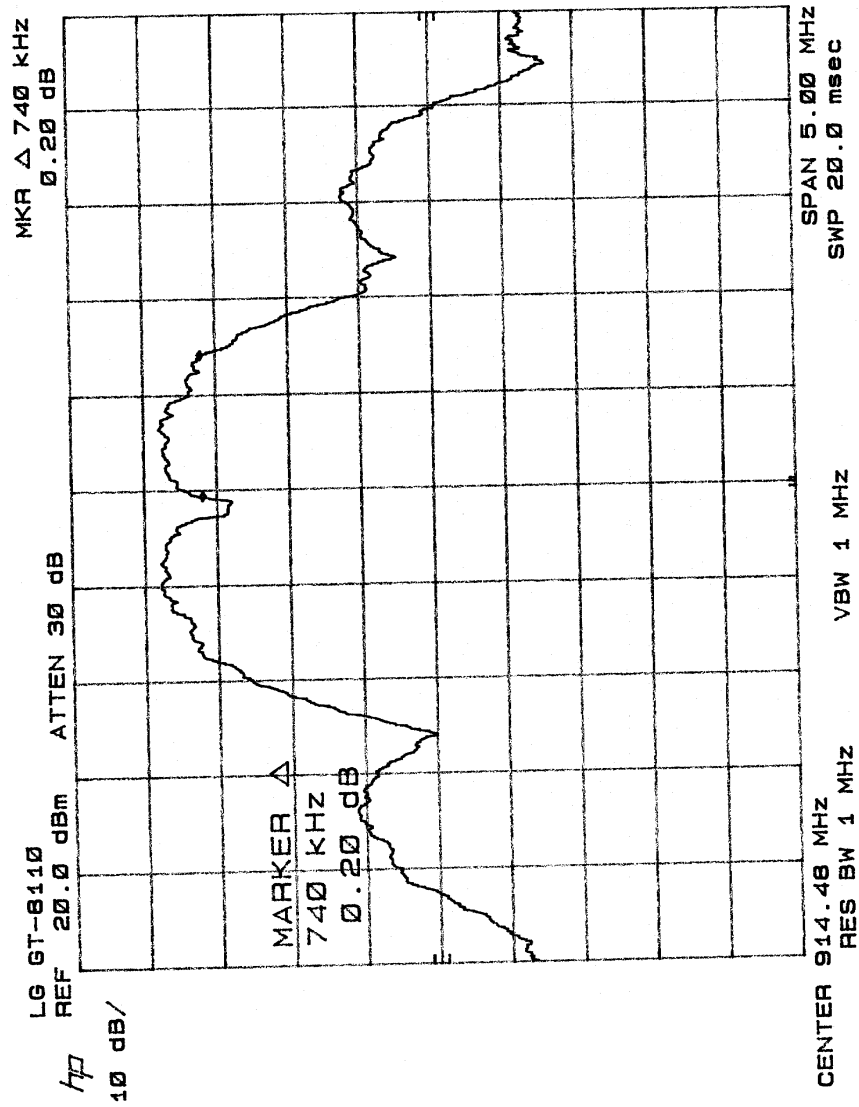

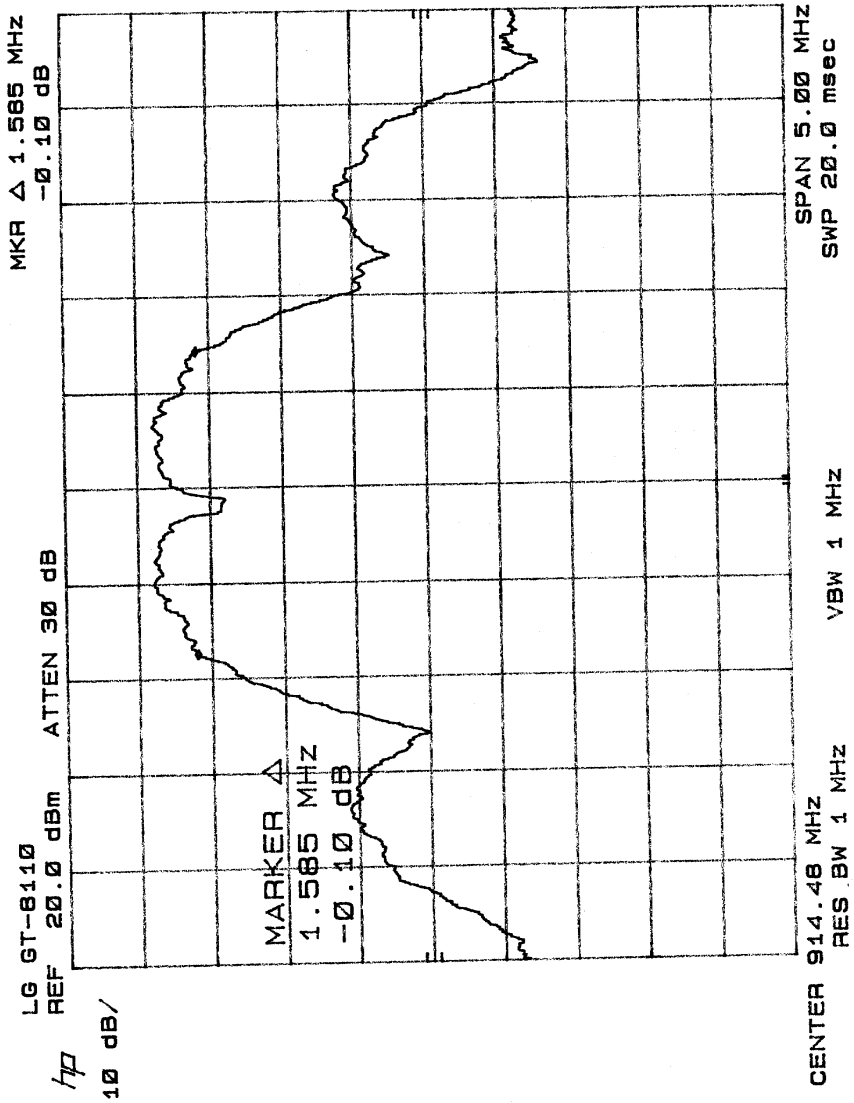

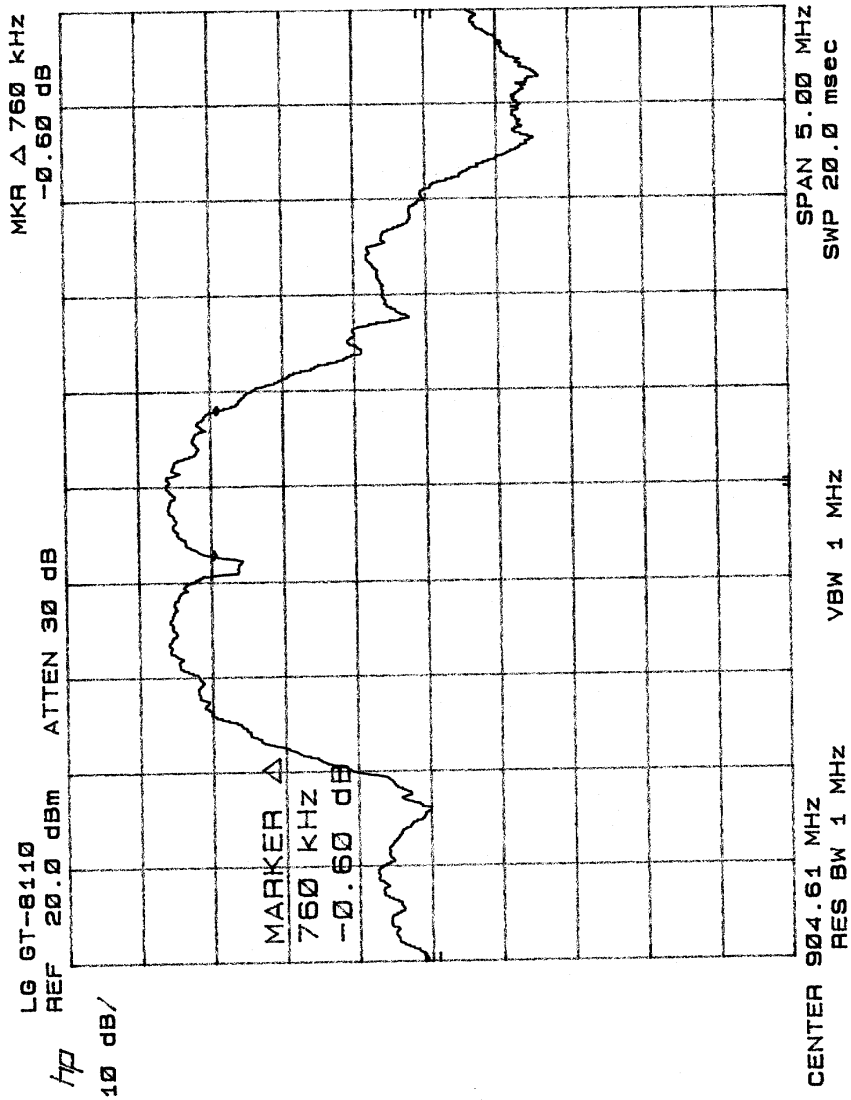

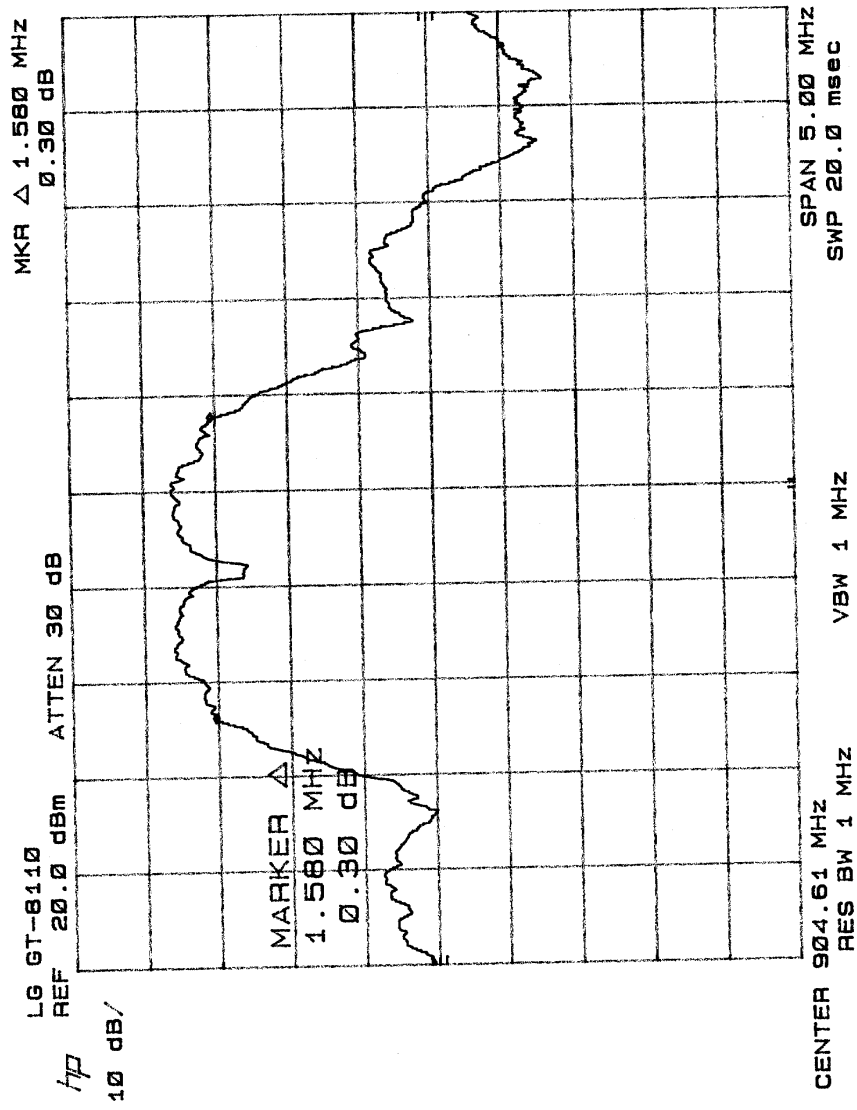

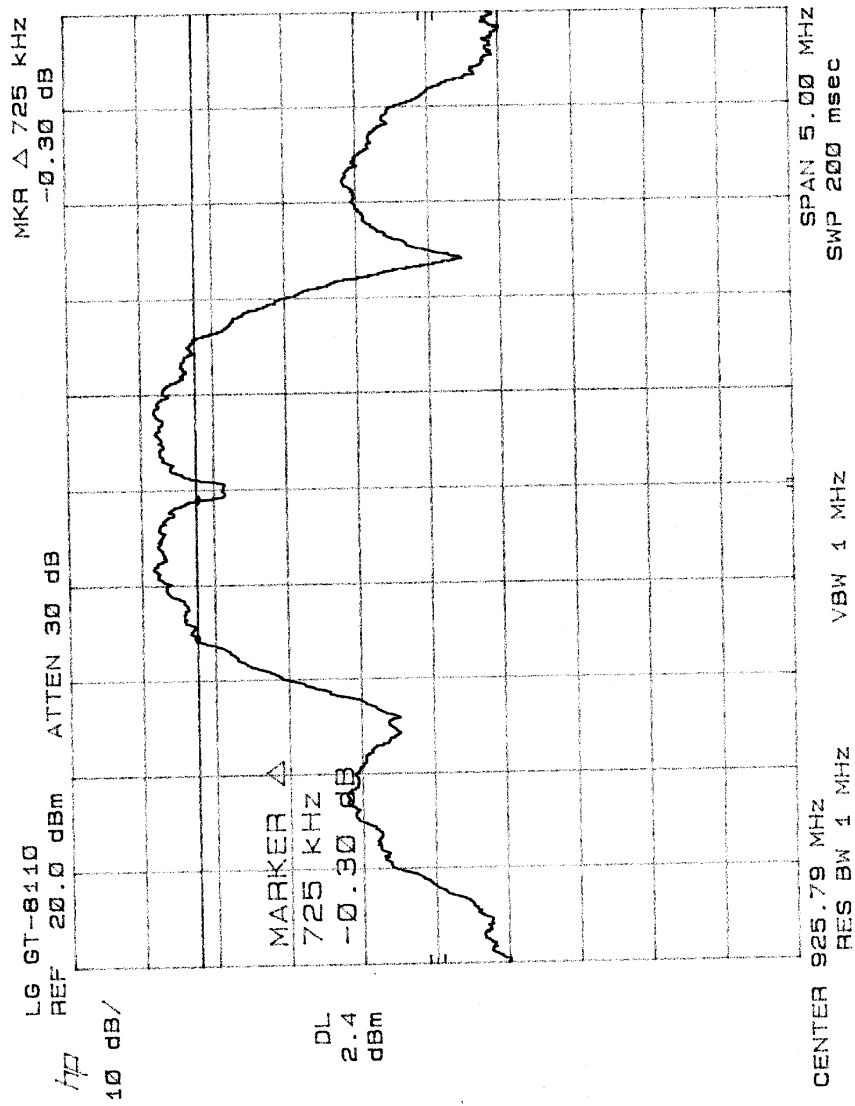

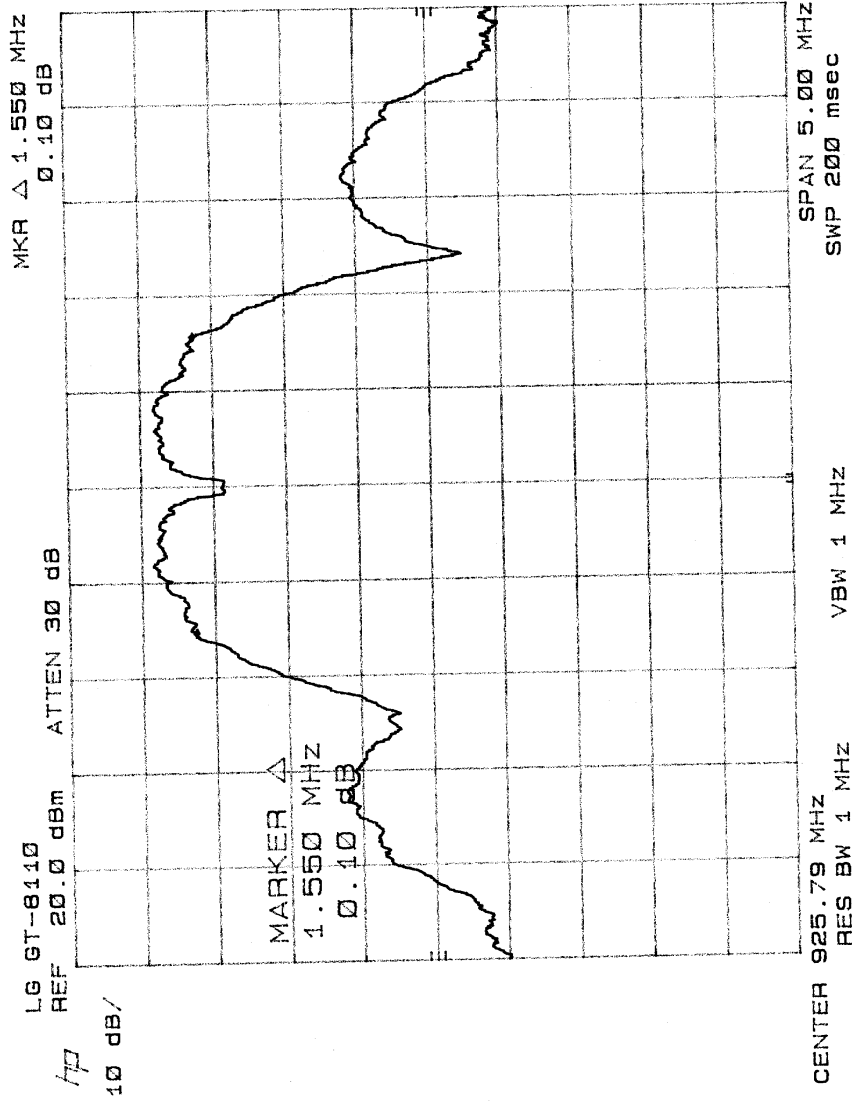

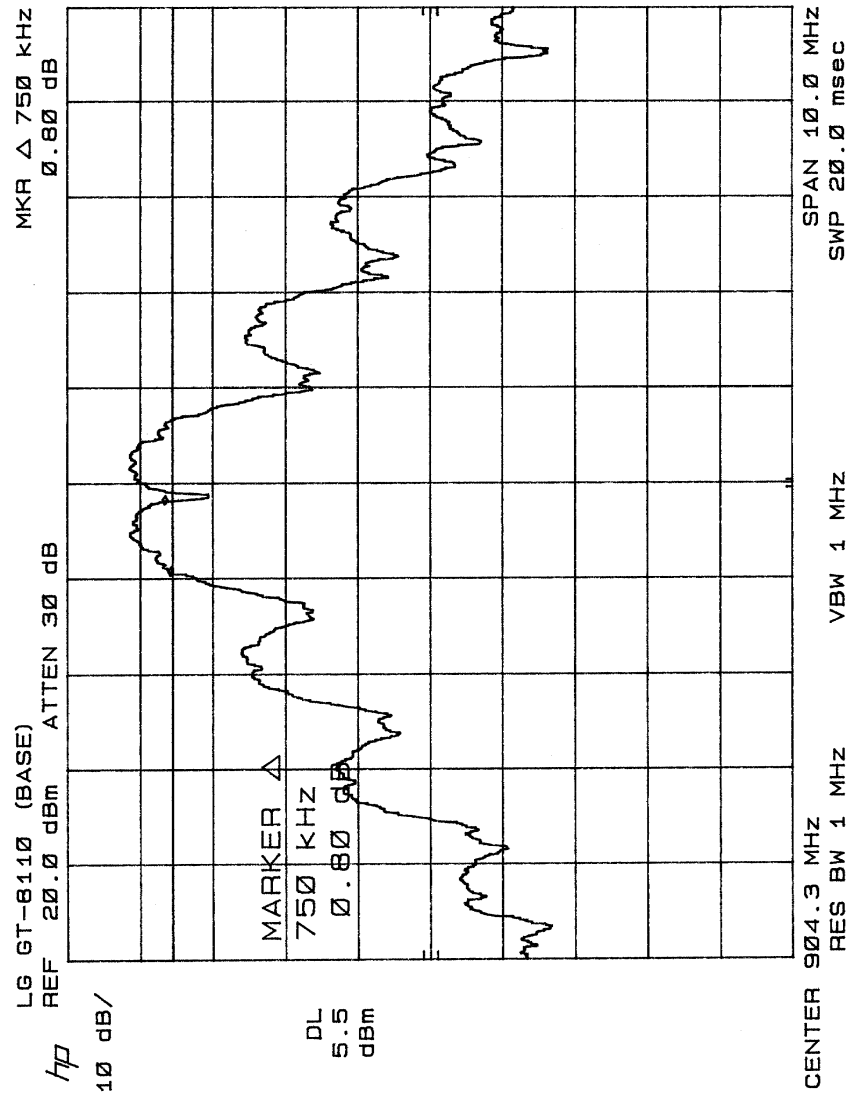

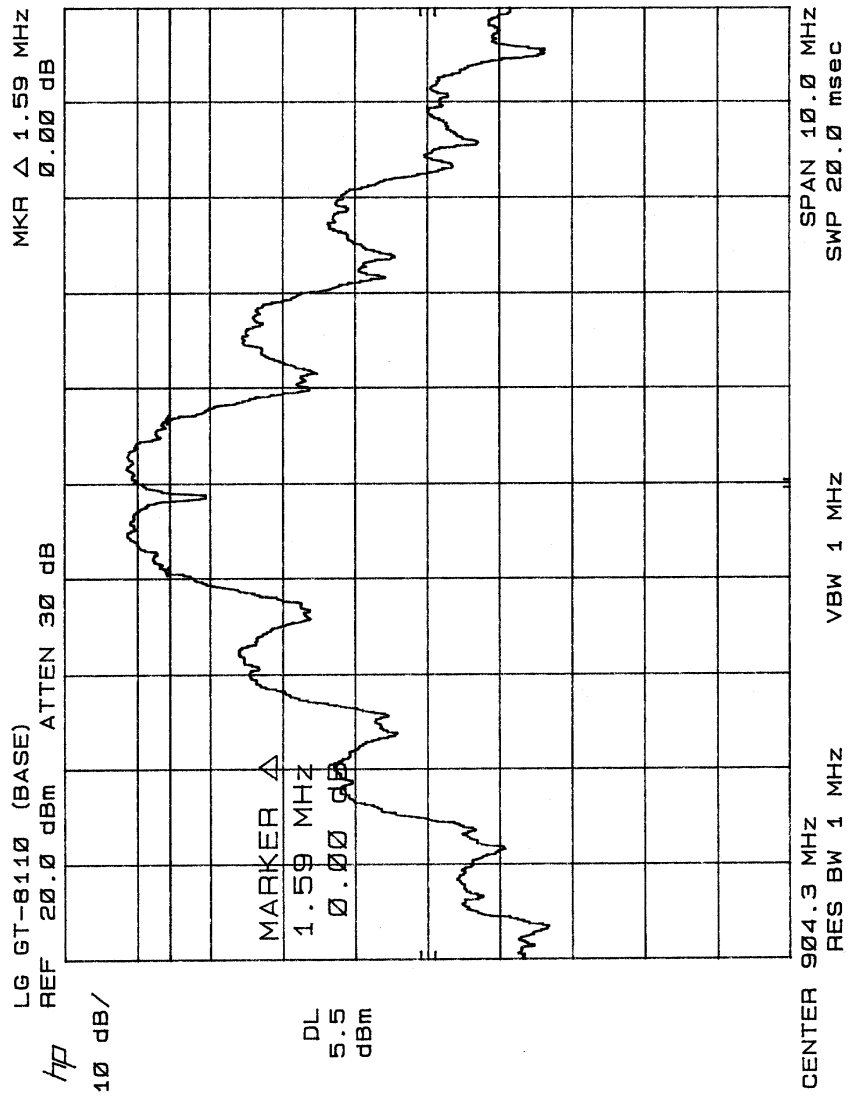

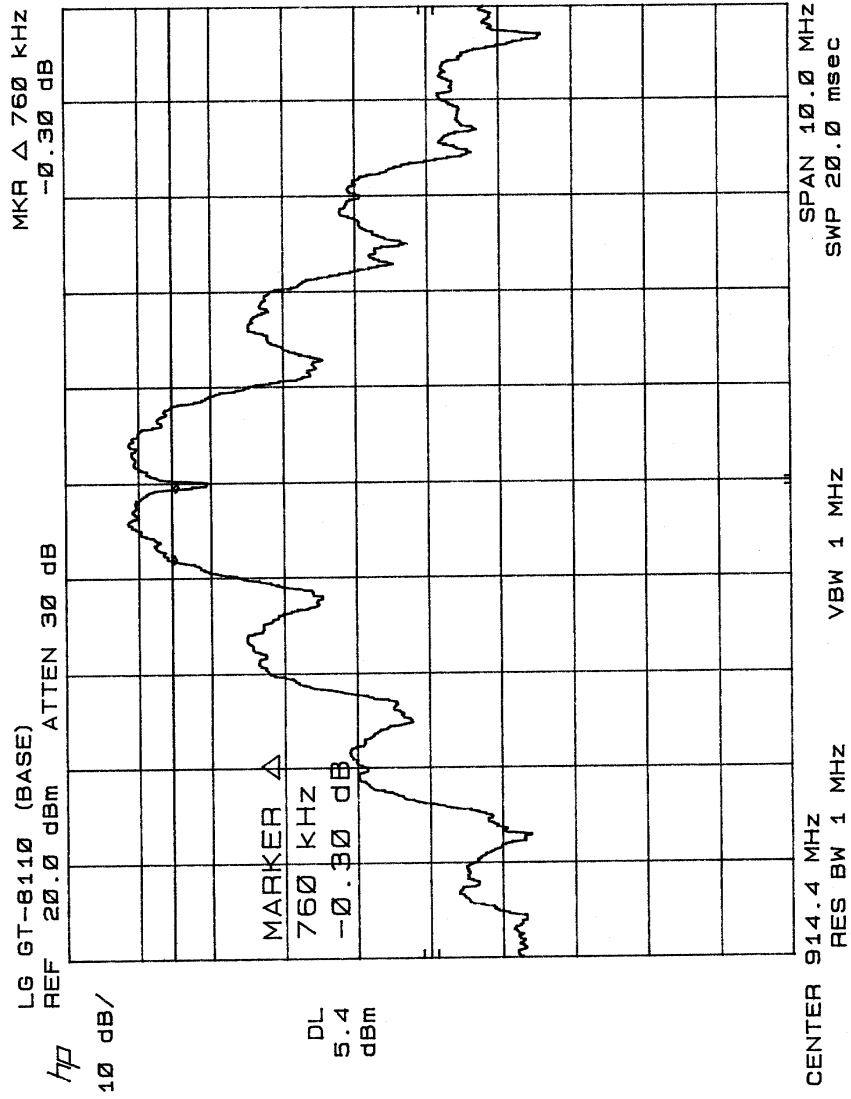

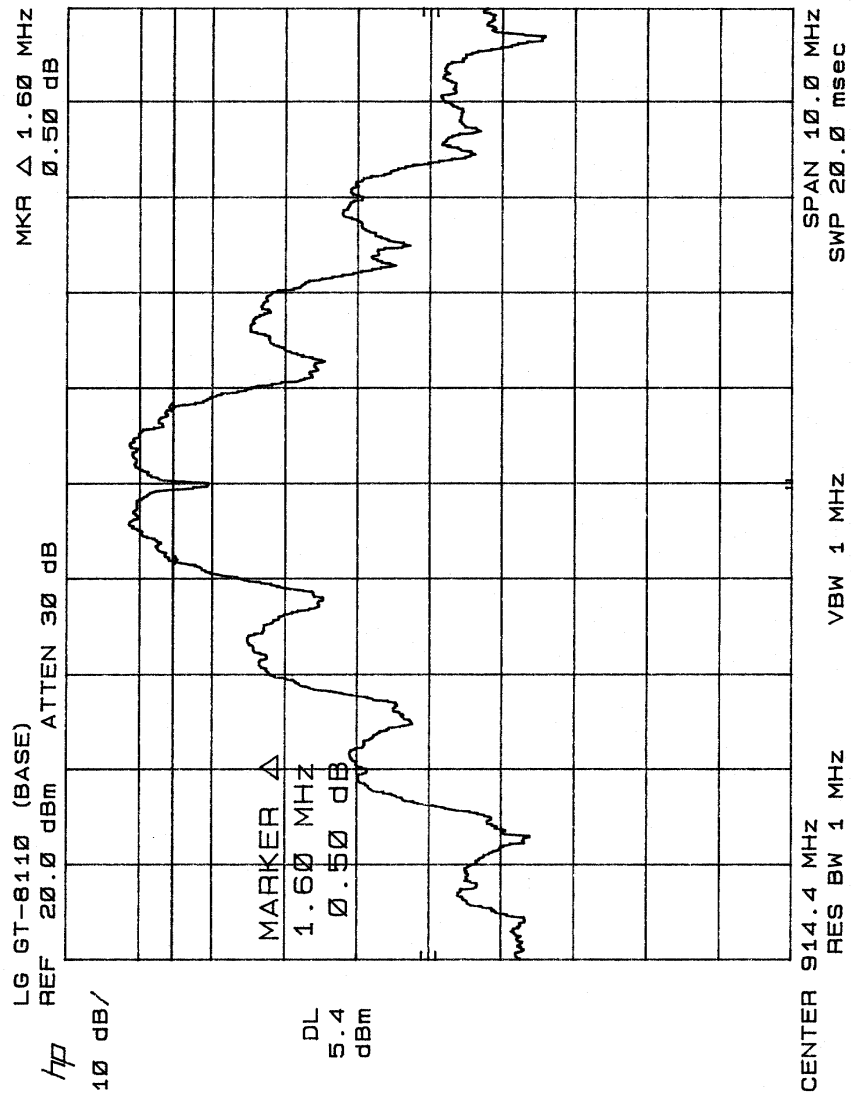

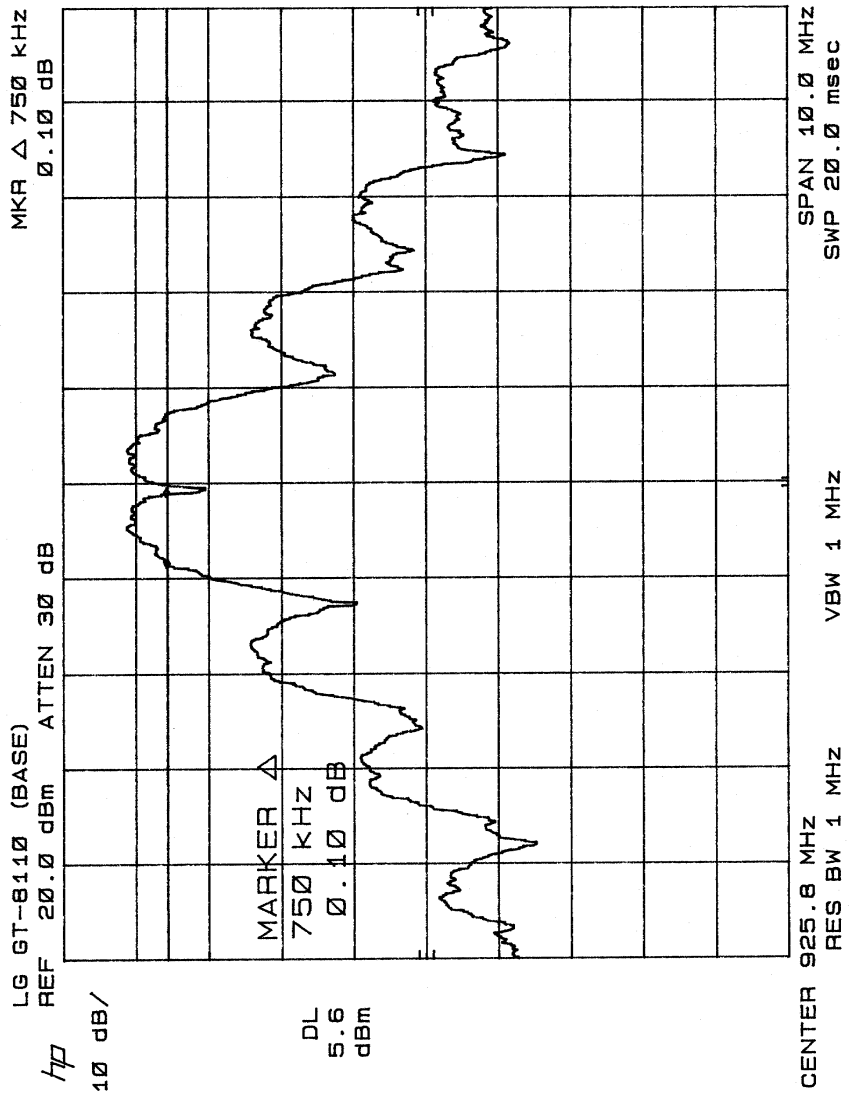

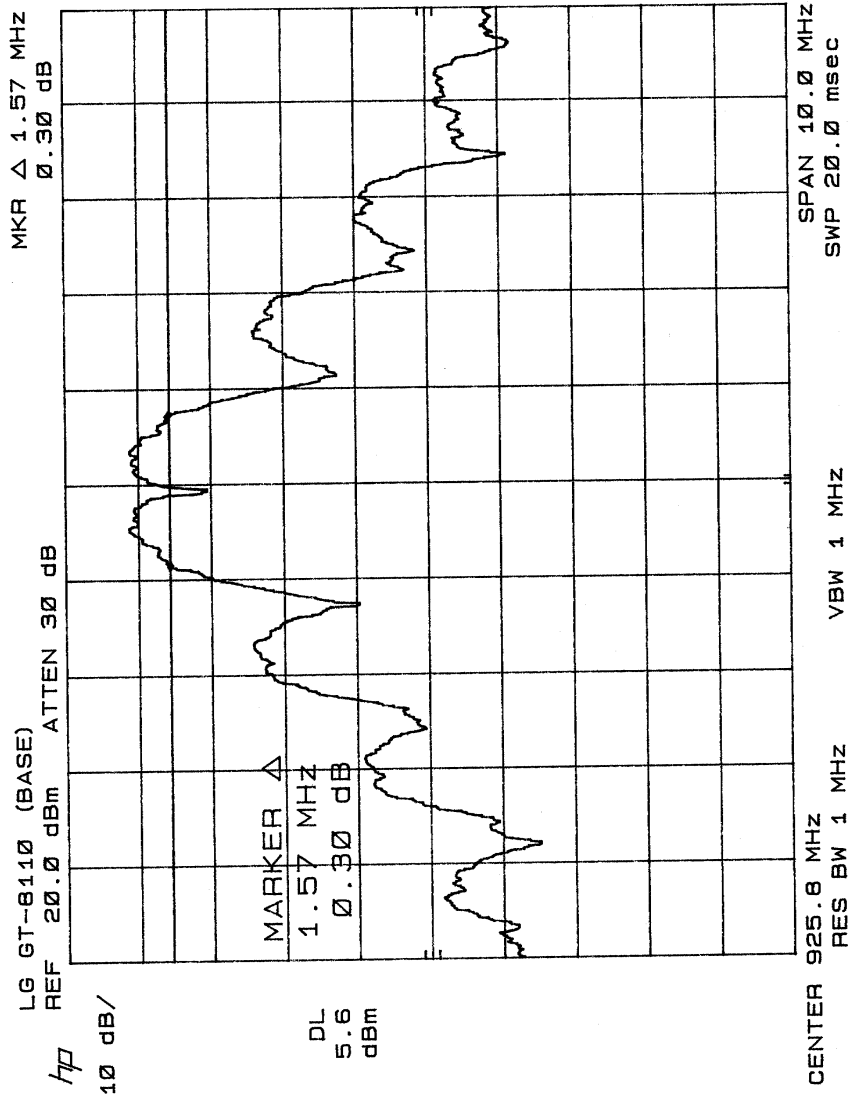

3.3.0 Power Density

Requirements: FCC 15.247 (2) (d), the transmitted power density averaged over any 1 second interval shall not be greater than 8 dBm in any 3 kHz bandwidth within these bands.

3.3.1 Test Procedure

The antenna was removed and SMA connector was connected to the transmitter output. The transmitter output was connected to a calibrated coaxial attenuator (50 Ohm), the other end of which was connected to a spectrum analyzer with the RBW set to 3kHz and VBW > RBW. The start and stop frequencies of the Spectrum Analyzer should be set according to the maximum emission frequency range seen from the 6 dB bandwidth test. The sweep time of the spectrum analyzer should be set to the value that allows to observe each 3 kHz interval for at least 1 second.

The test was performed at three frequencies (low, middle, and high channels) and on all power levels that can be setup on the transmitter.

3.3.2 Test Equipment

Hewlett Packard HP8566B Spectrum Analyzer
 Hewlett Packard HP 7470A Plotter

3.3.3 Test Results

Refer to the attached Plots

BASE

Power Density	
Low Channel	Page 36
Middle Channel	Page 37
High Channel	Page 38

HANDSET

Power Density	
Low Channel	Page 33
Middle Channel	Page 34
High Channel	Page 35

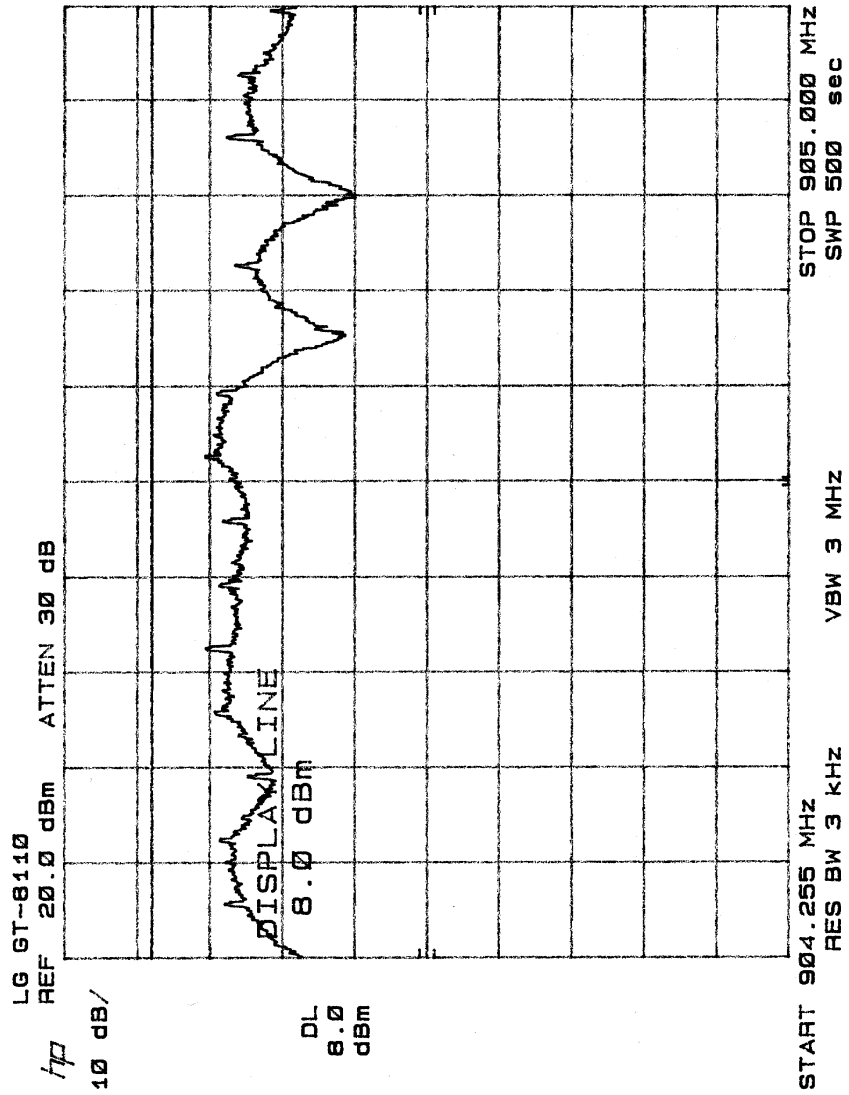

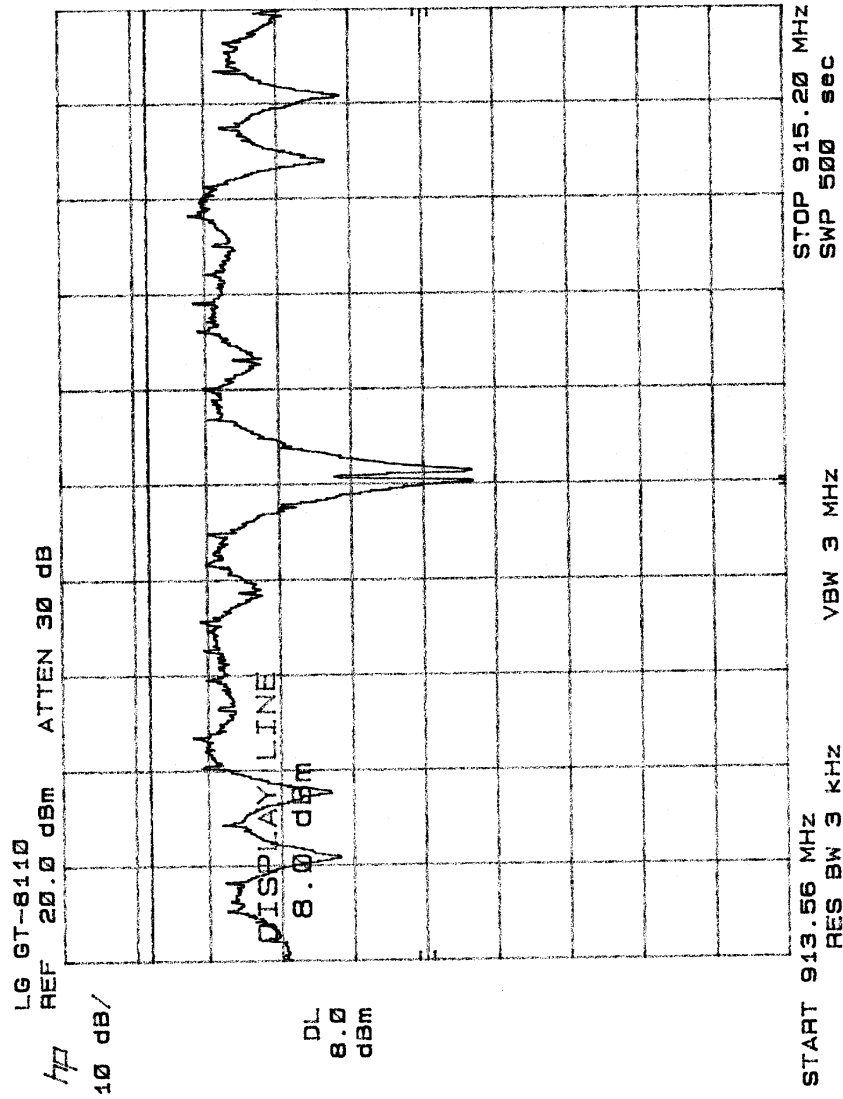

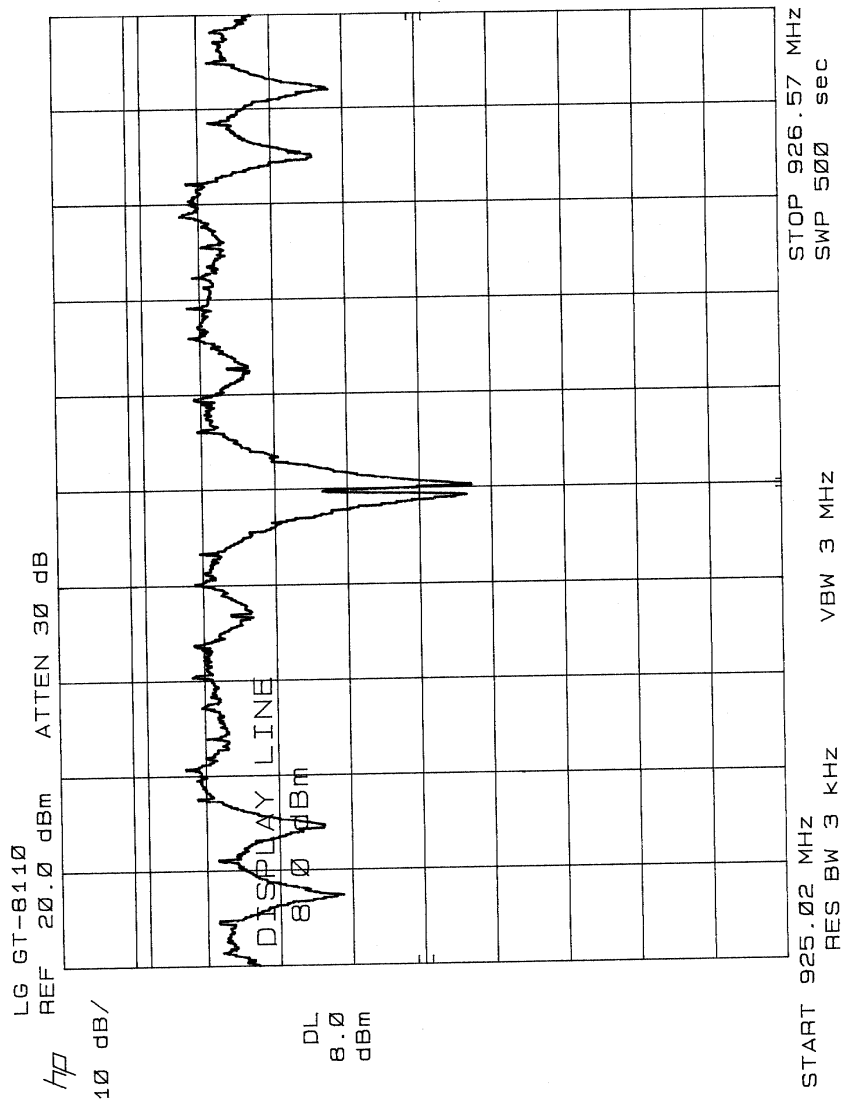

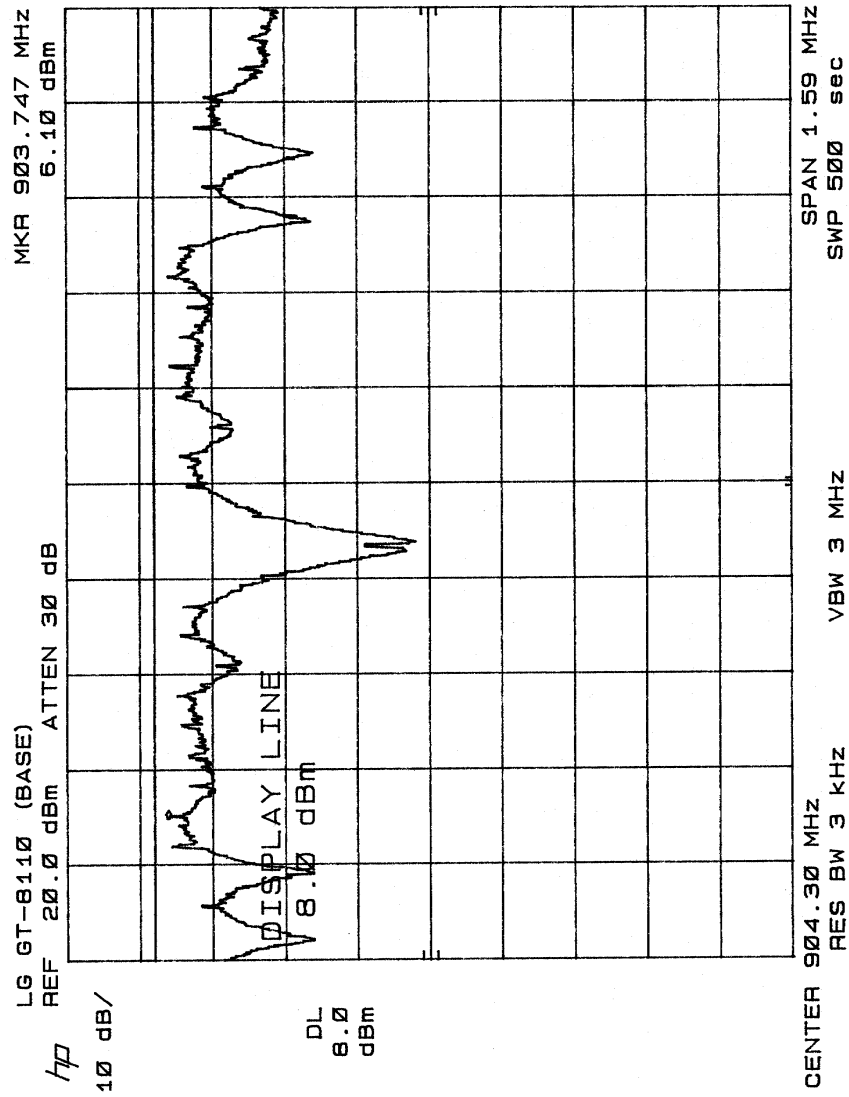

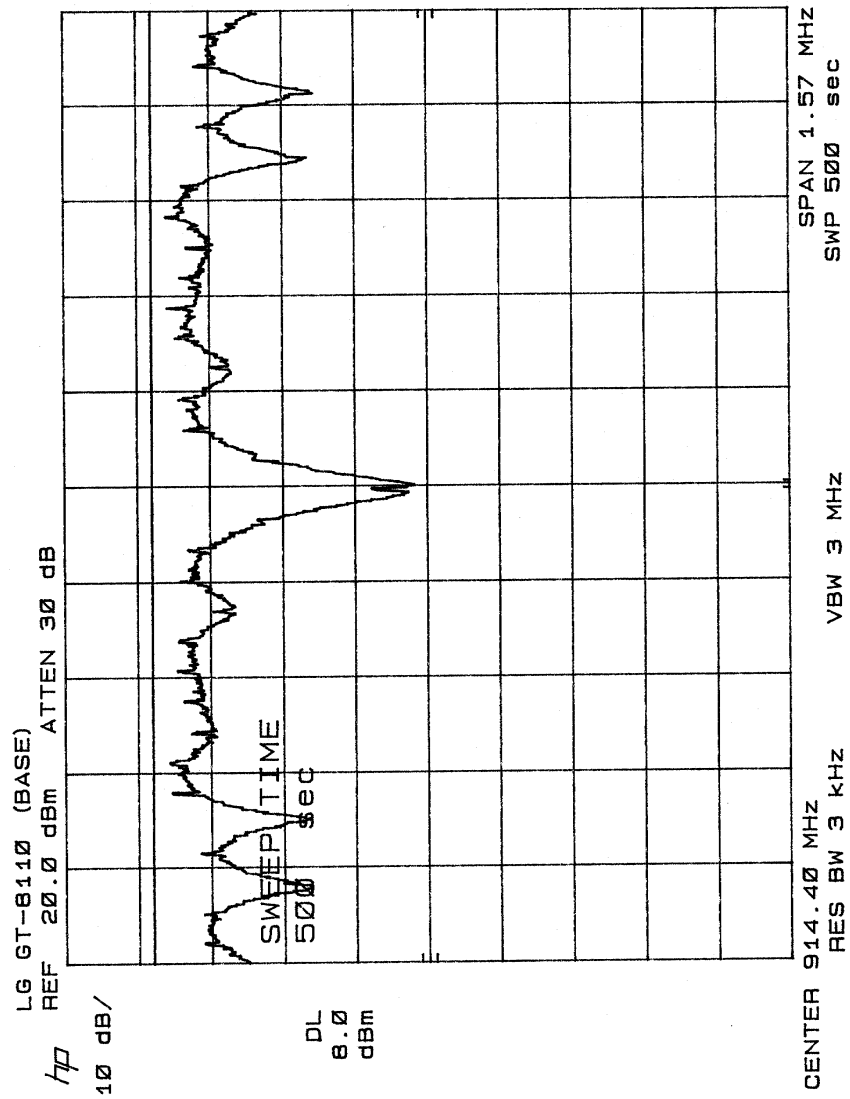

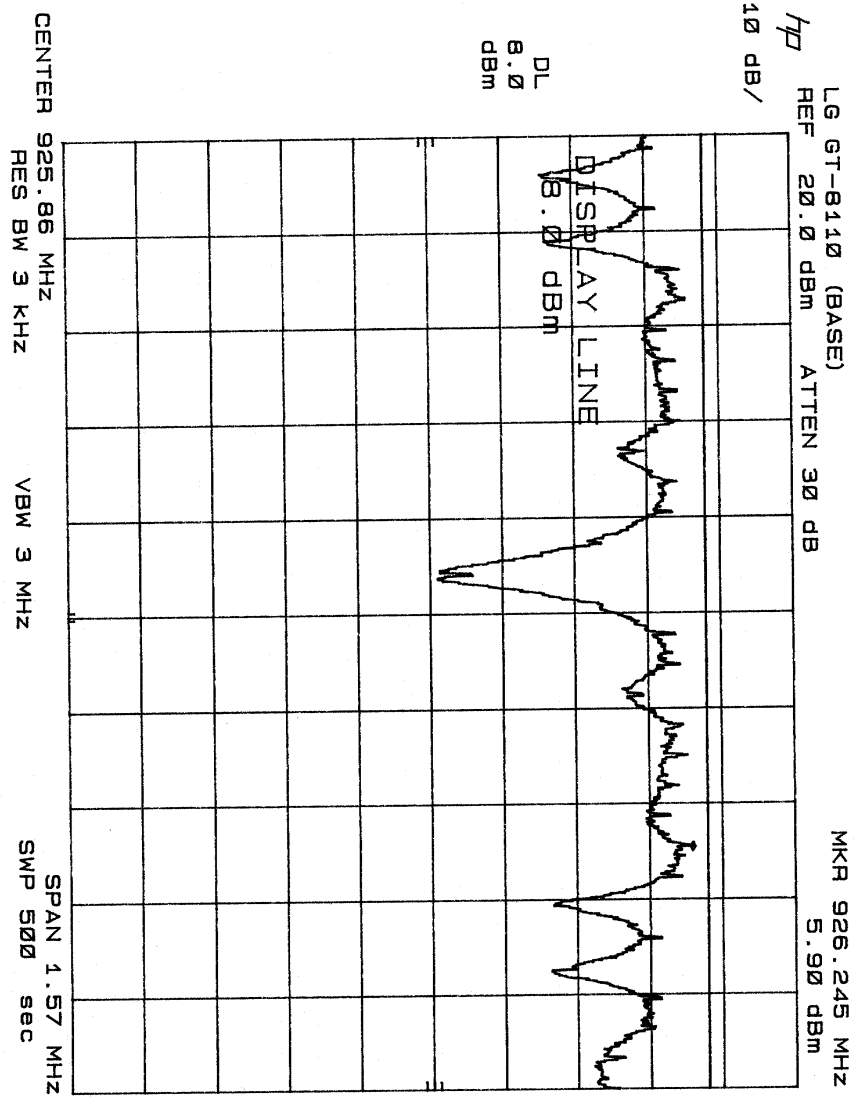

3.4.0 Band Edges Testing

Requirements : FCC 15.247 (2) ©, the emission power at the START and STOP frequencies shall be at least 20 dB below than the peak of the EUT’s emission inside the operation band.

3.4.1 Test Procedure

The antenna was removed and SMA connector was connected to the transmitter output. The transmitter output was connected to a calibrated coaxial attenuator (50 Ohm), the other end of which was connected to a spectrum analyzer with the START and STOP frequencies set to the operation band. Transmitter output was read off the spectrum analyzer in dBm. The power output at the transmitter was determined by adding the value of the attenuator to the spectrum analyzer reading.

The test was performed at three frequencies (low, middle, and high channels) and on all power levels that can be setup on the transmitter.

3.4.2 Test Equipment

HP 8566B Spectrum Analyzer
 HP 7470A Plotter

3.4.3 Test Results

Refer to the attached plots.

BASE

Band Edge	
Low Channel	Page 43
Middle Channel	Page 44
High Channel	Page 45

HANDSET

Band Edge	
Low Channel	Page 41
Middle Channel	Page 40
High Channel	Page 42

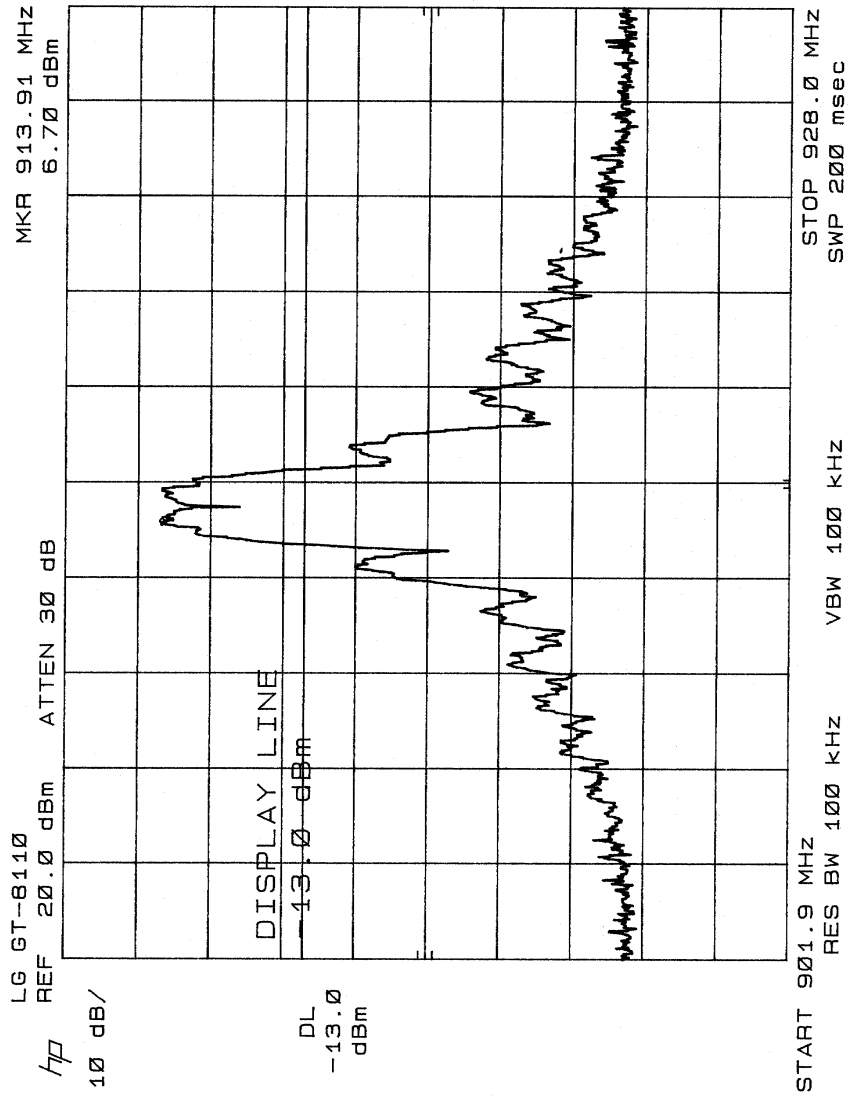

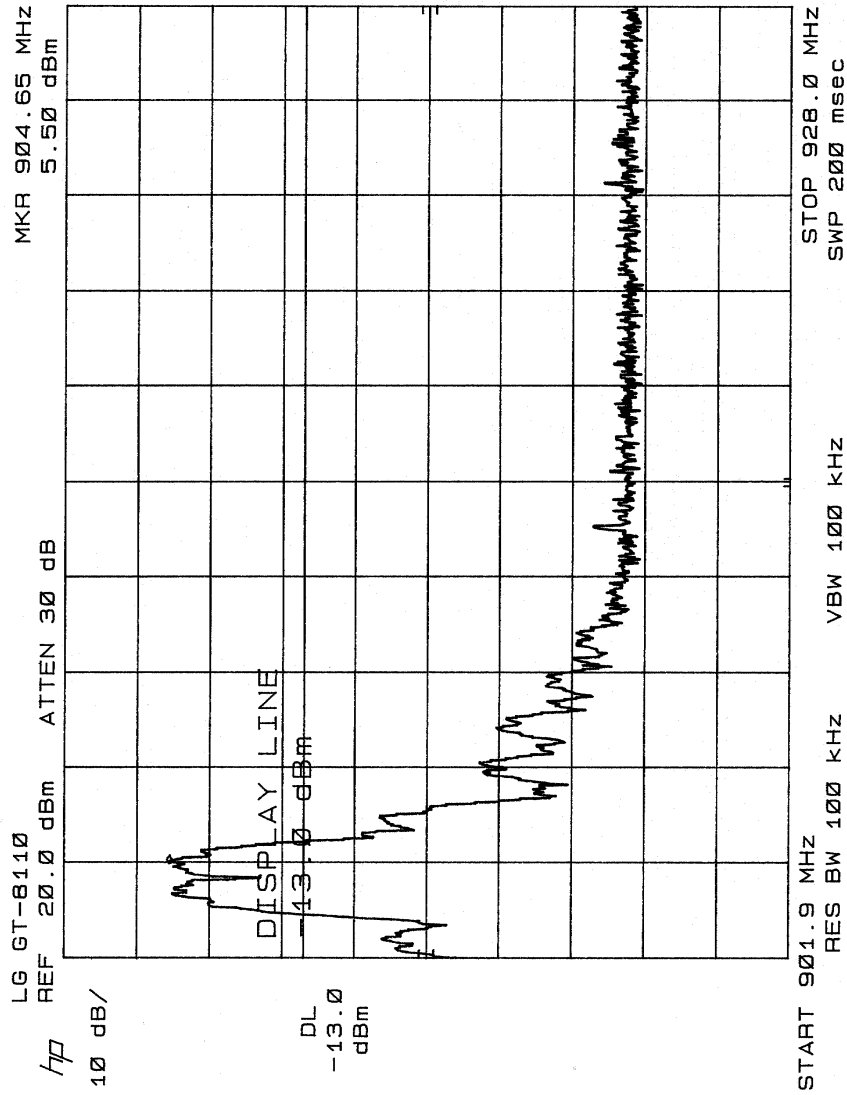

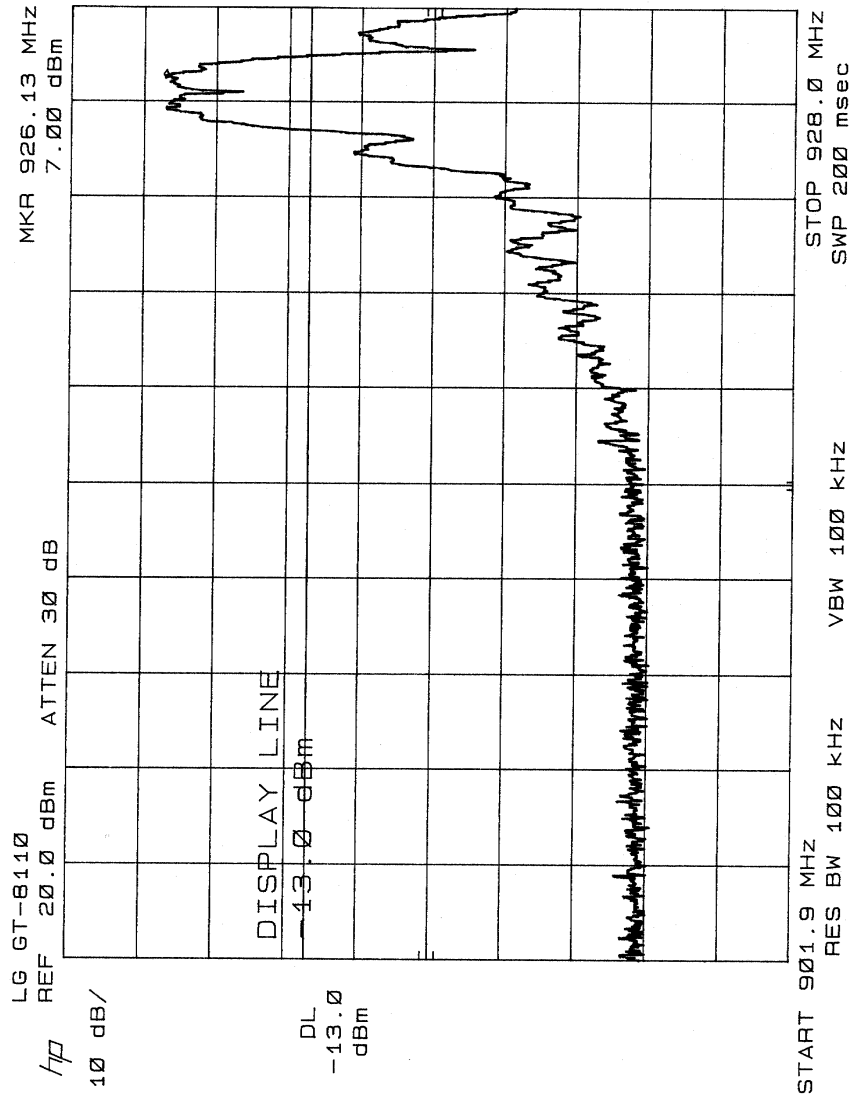

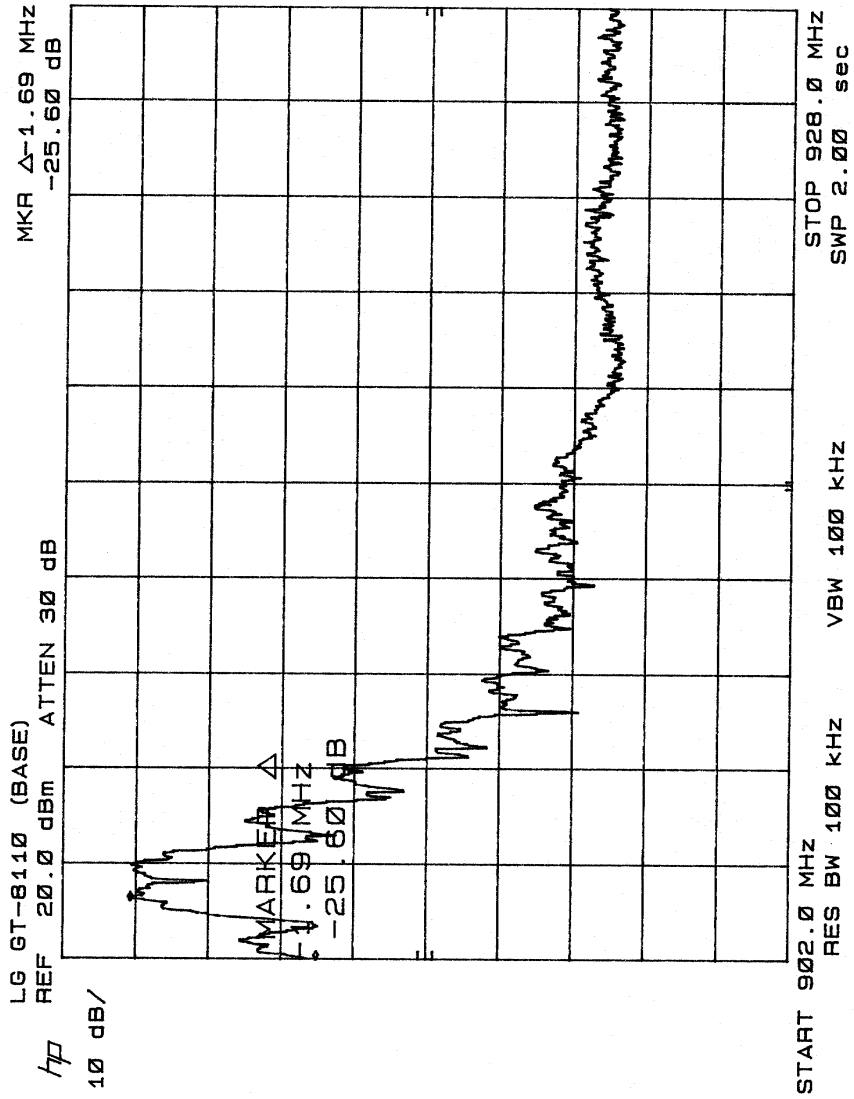

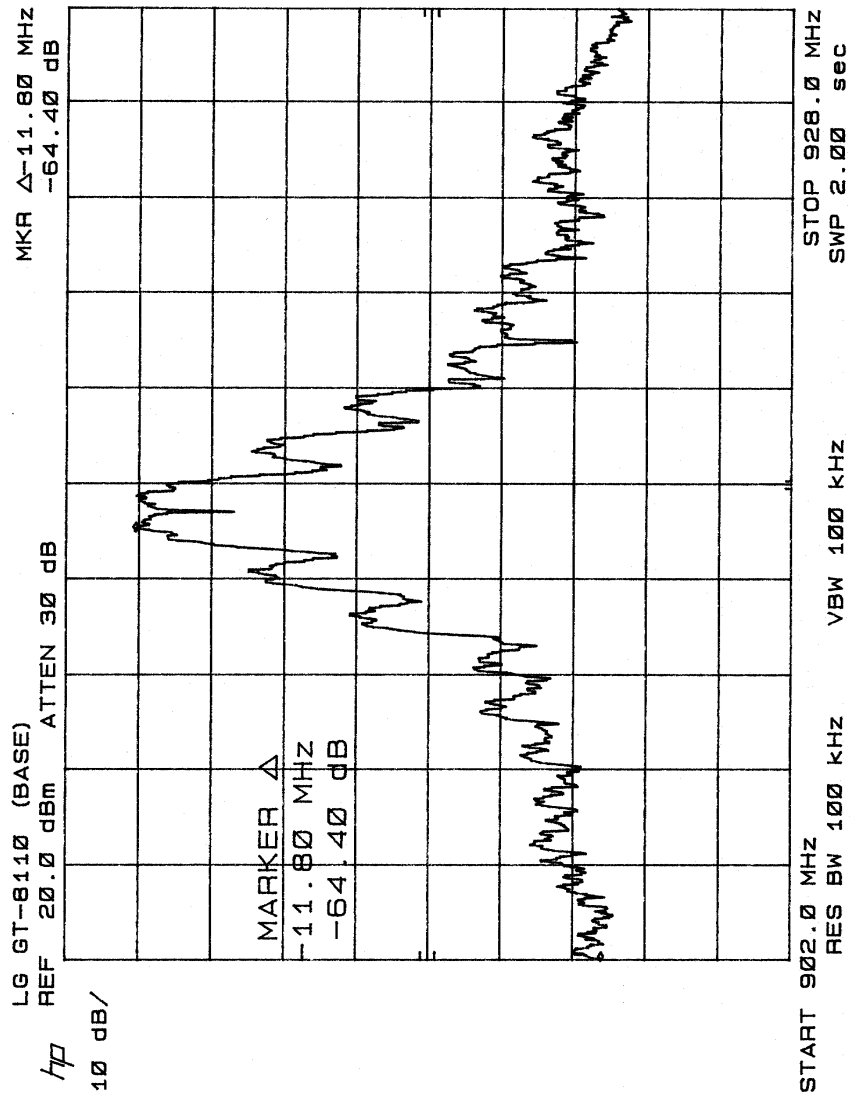

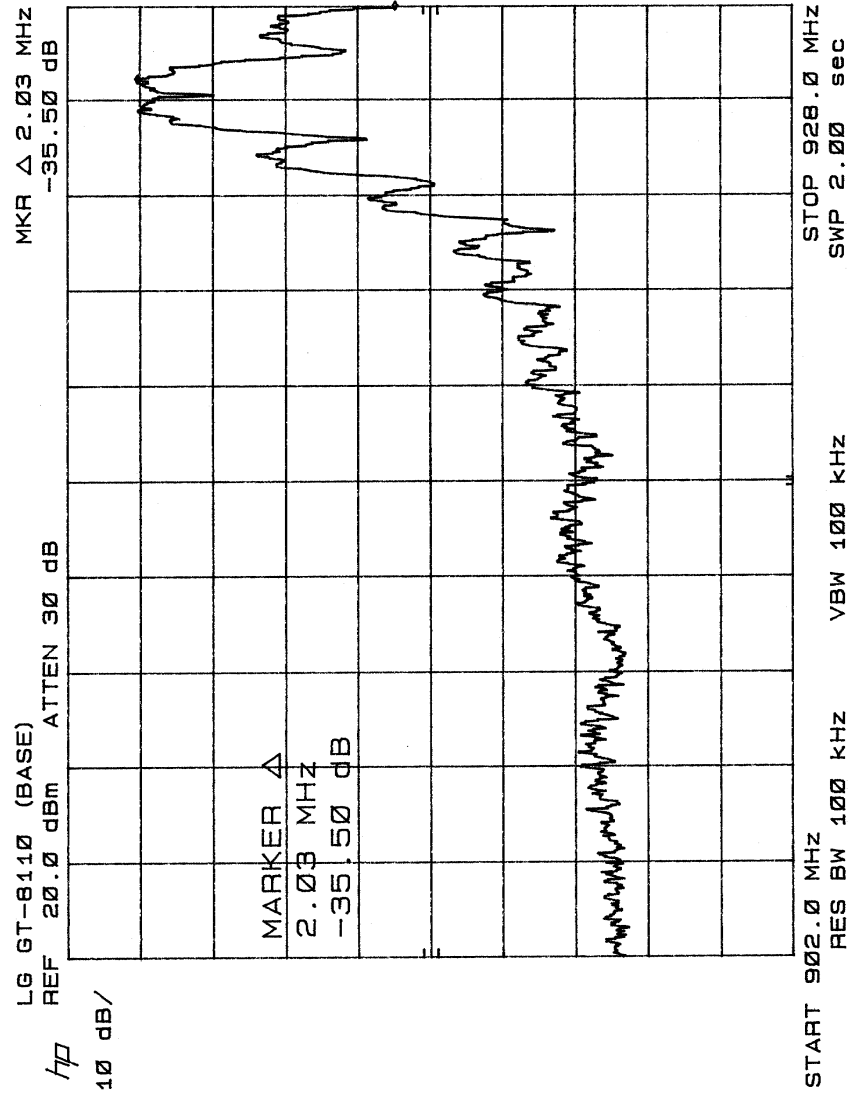

3.5.0 Spurious Emissions

Requirements : FCC 15.247 (2) © The harmonics and other signals must be at least 20 dB below than the highest emissions level within the operation band.

3.5.1 Test Procedure

The RF output of the transceiver was connected to a spectrum analyzer through appropriate attenuation. The resolution bandwidth of the spectrum analyzer was set at 100 kHz. Sufficient scans were taken to show any out of band emissions up to 10th harmonic.

3.5.2 Test Equipment

Hewlett Packard HP8566B Spectrum Analyzer
 Hewlett Packard HP 7470A Plotter

3.5.3 Test Results

Refer to the attached plots.

BASE

Spurious Emission	
Low Channel	Page 52, 53
Middle Channel	Page 54, 55
High Channel	Page 56, 57

HANDSET

Spurious Emission	
Low Channel	Page 47, 48
Middle Channel	Page 49, 50
High Channel	Page 51, 58

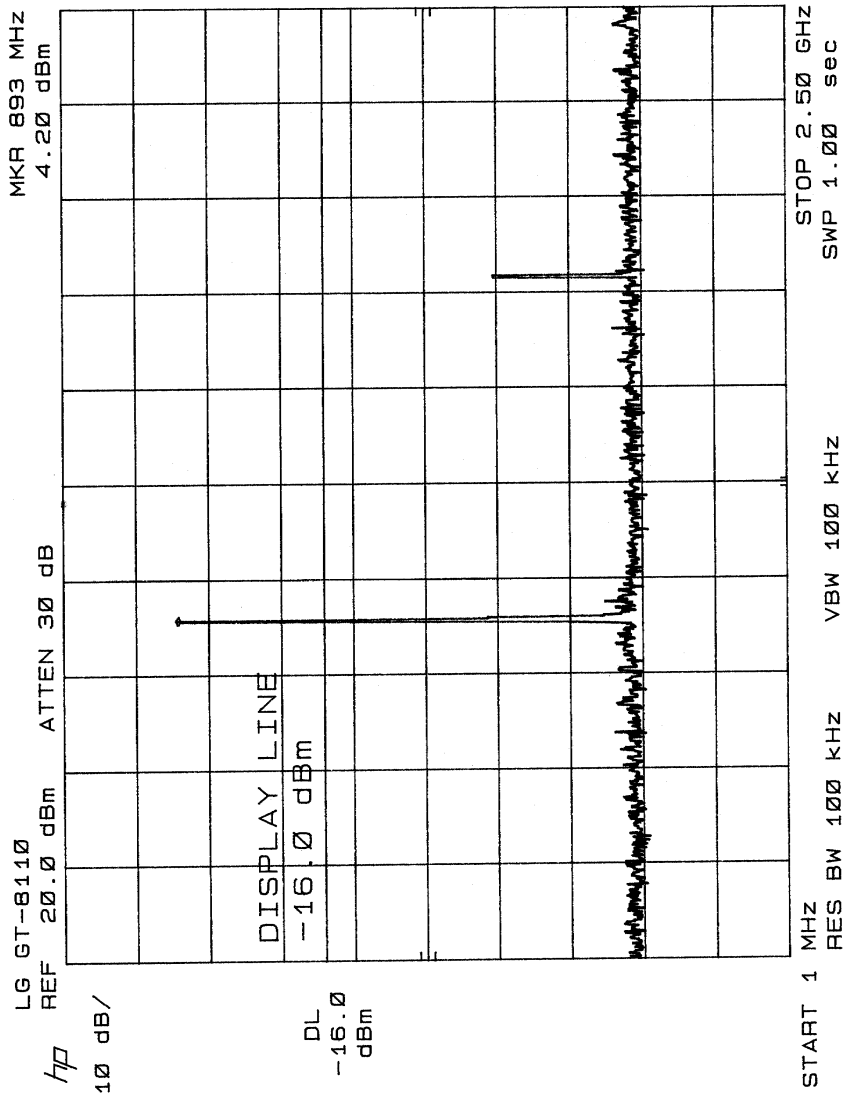

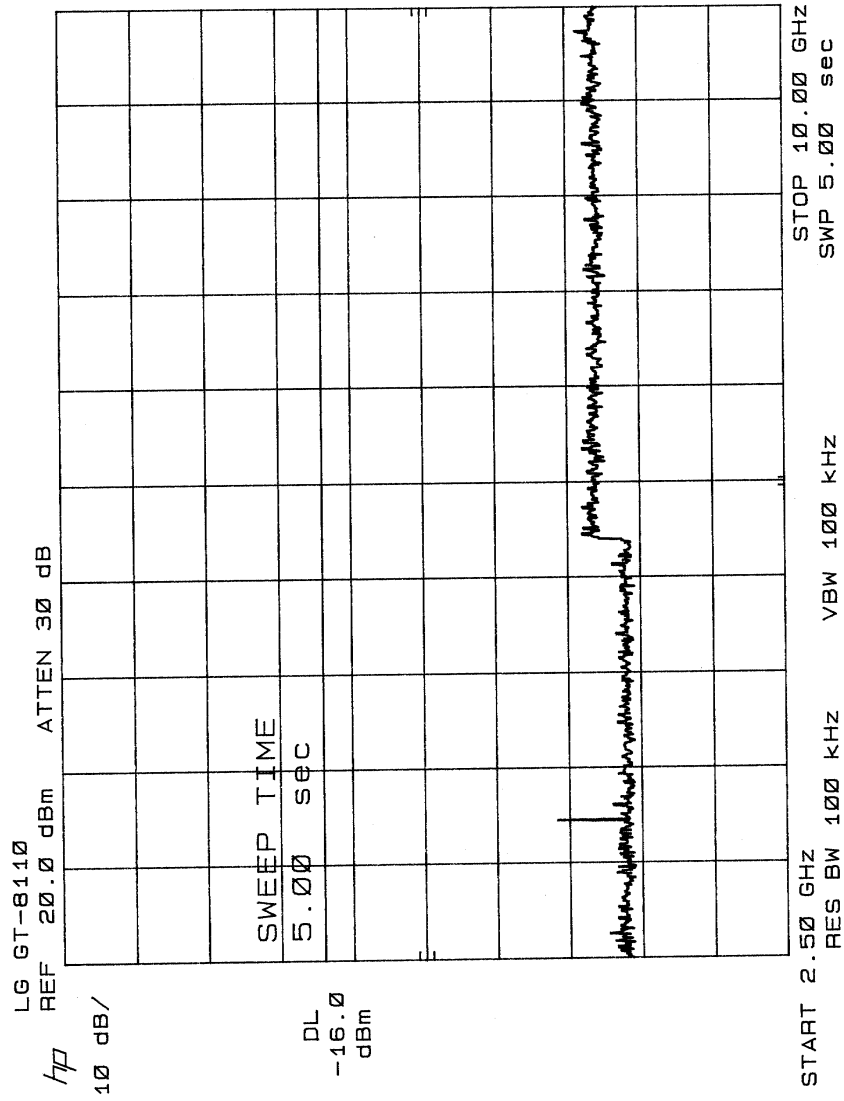

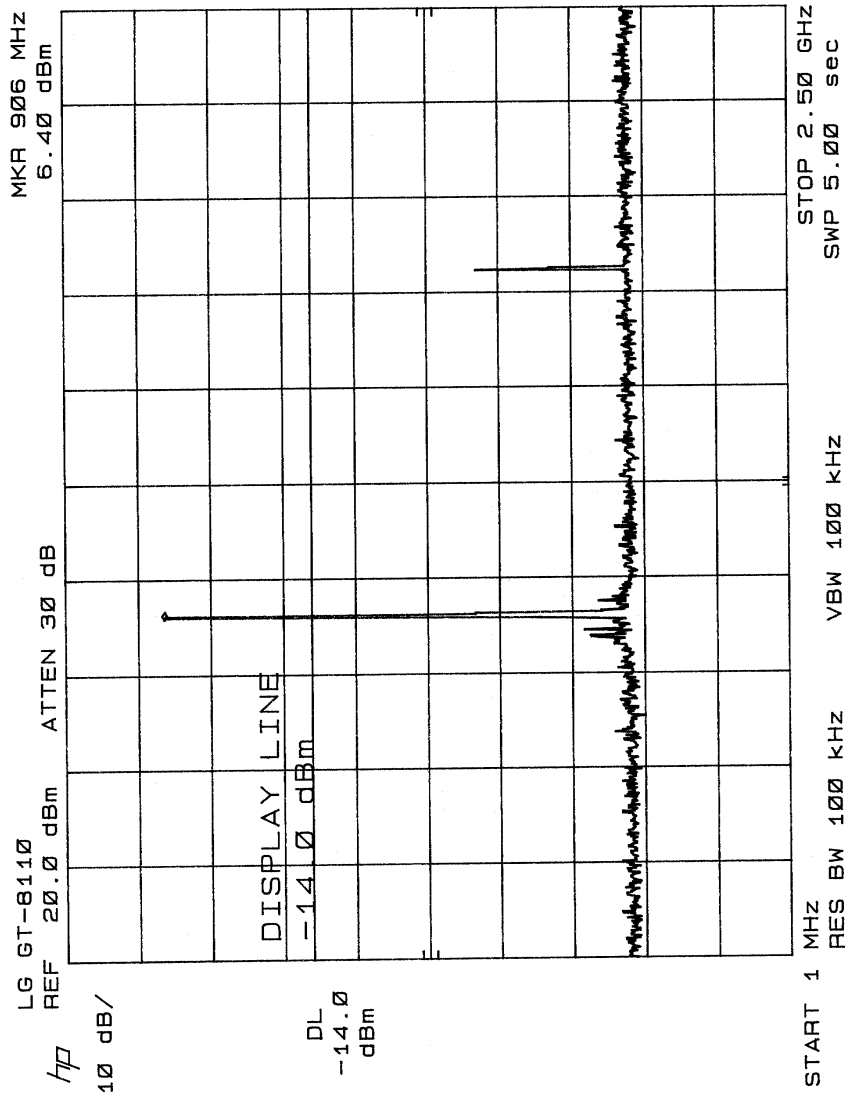

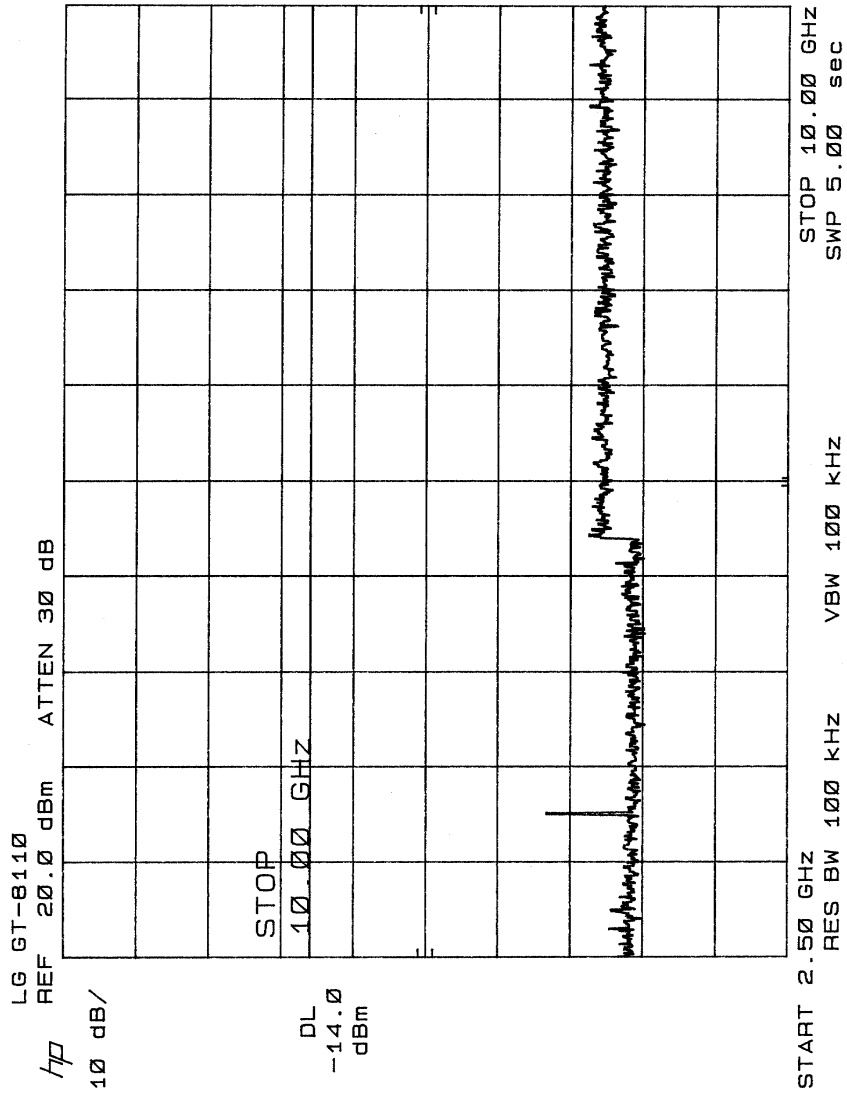

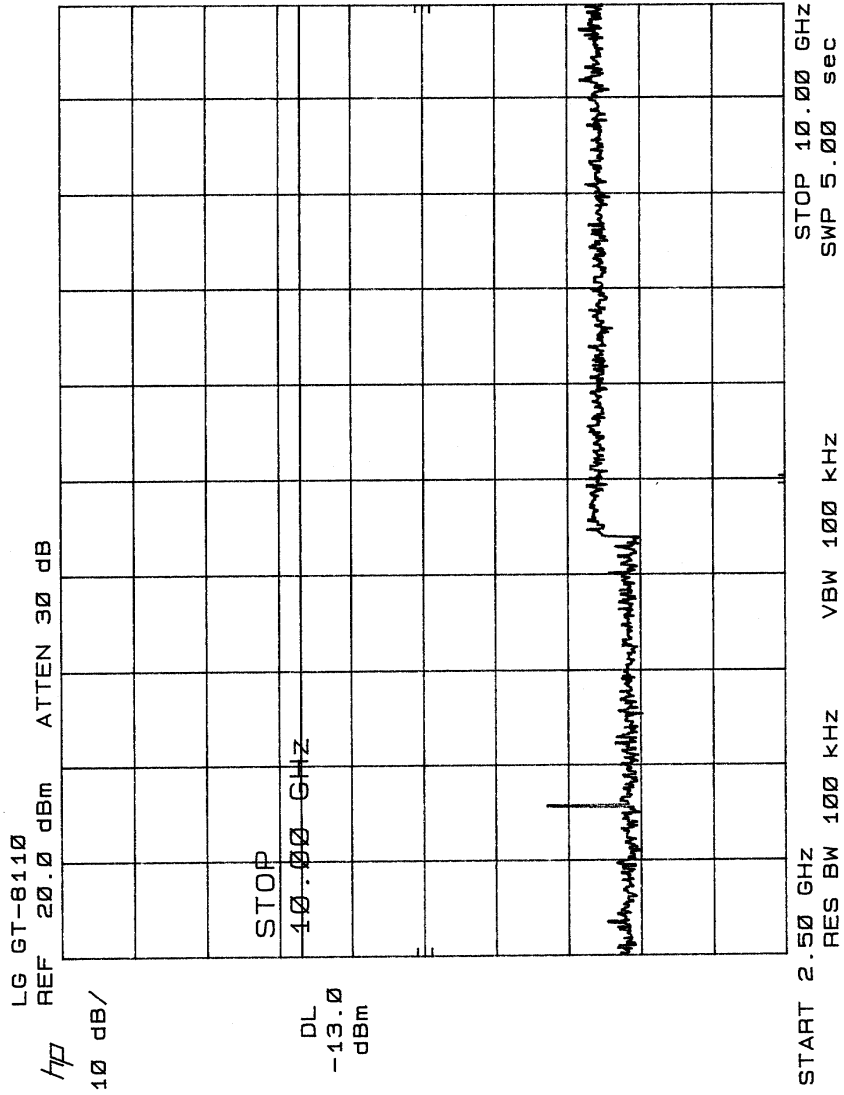

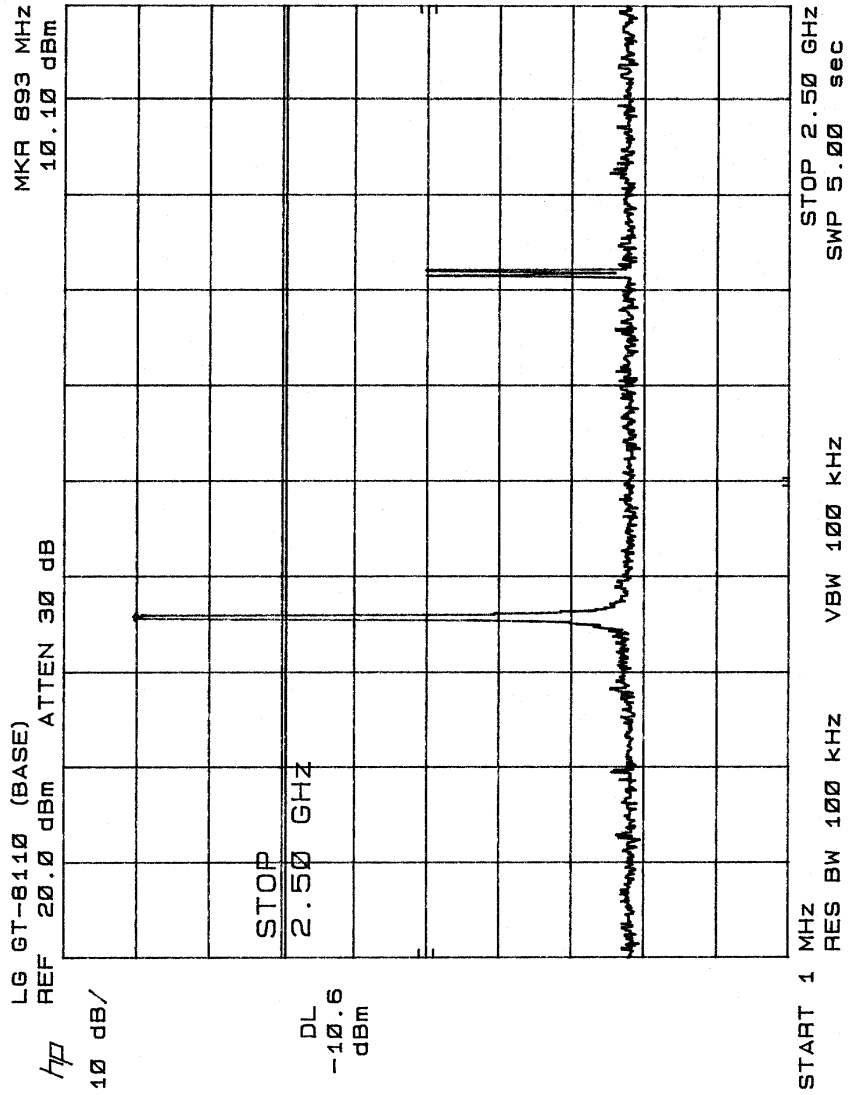

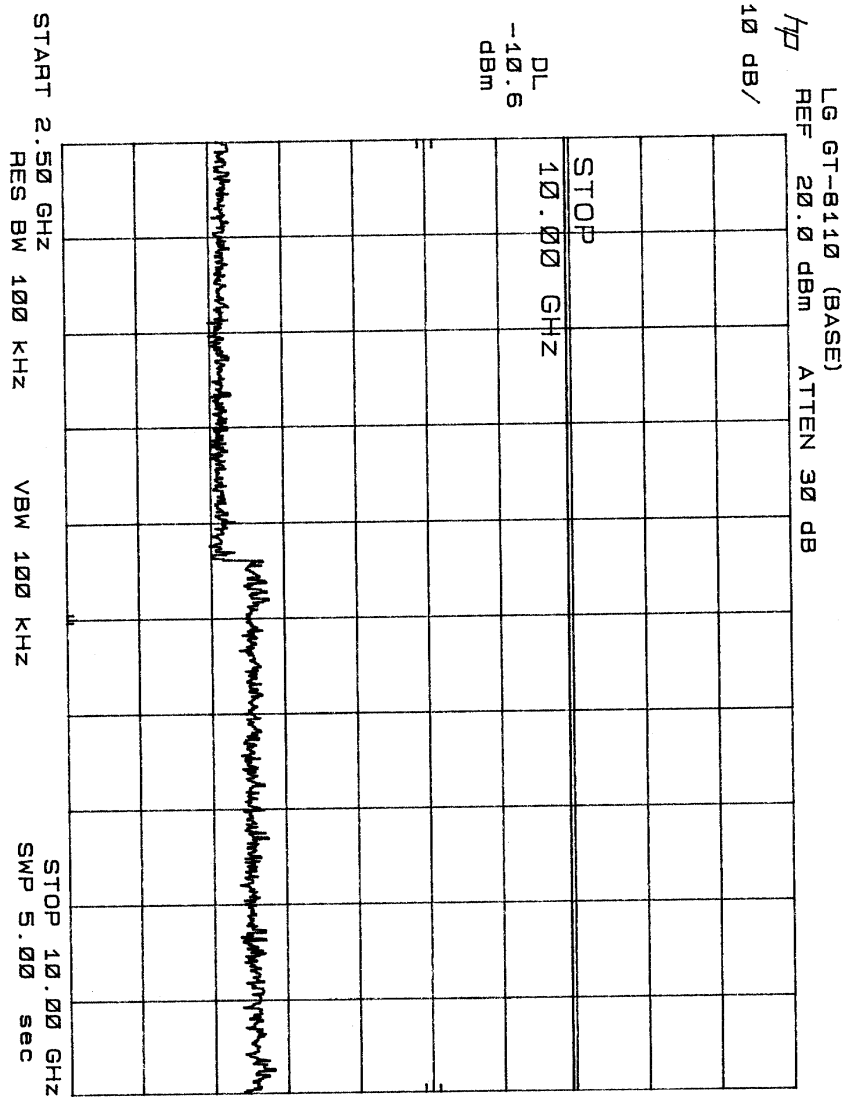

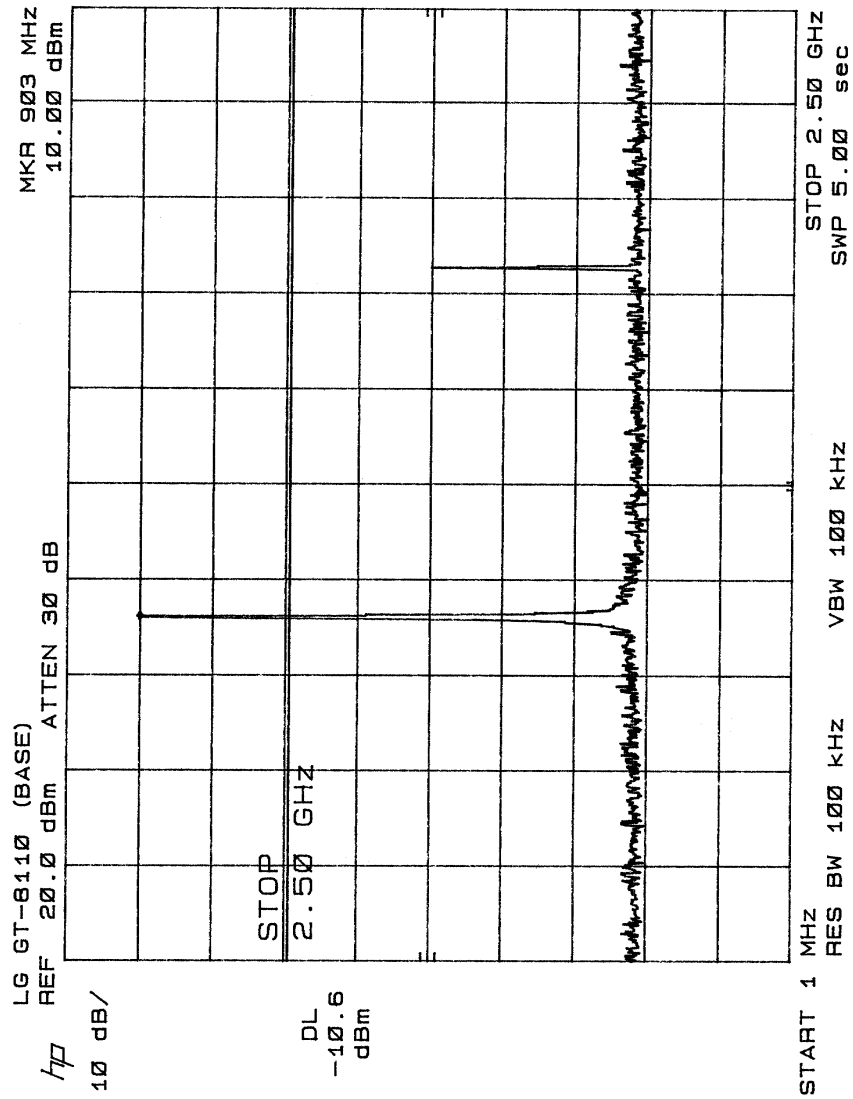

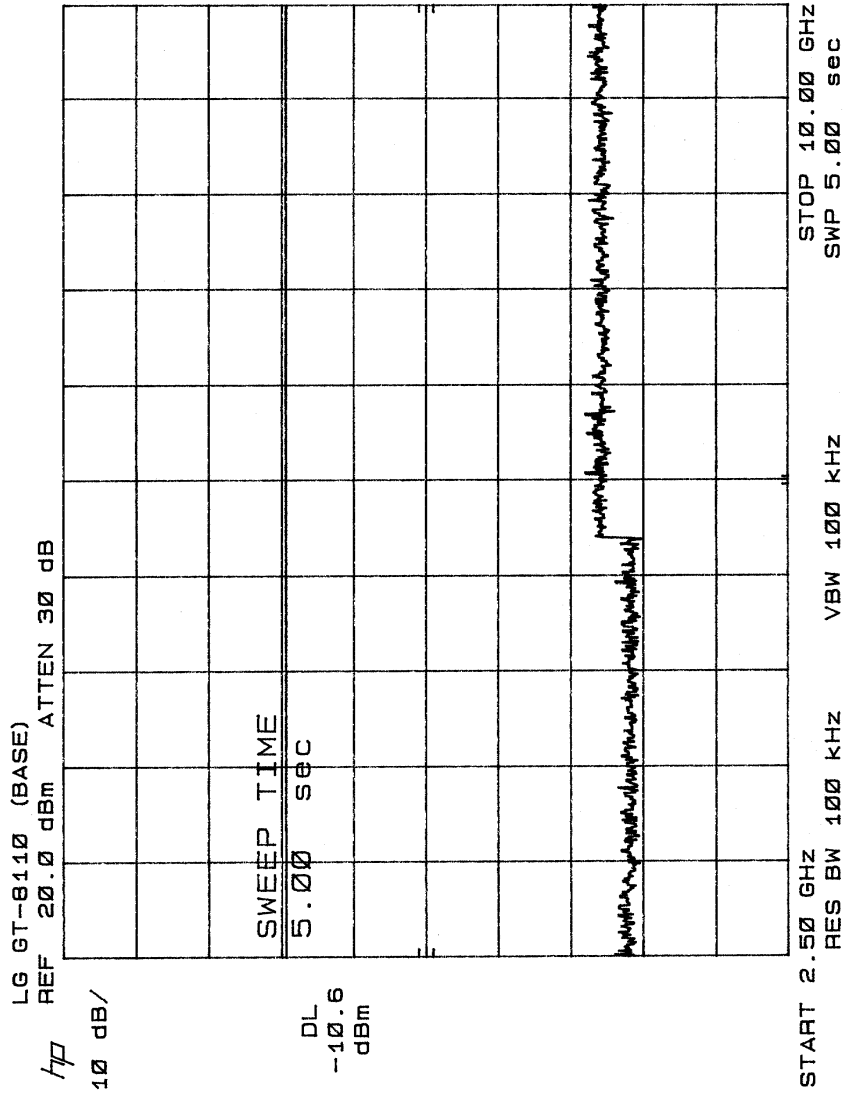

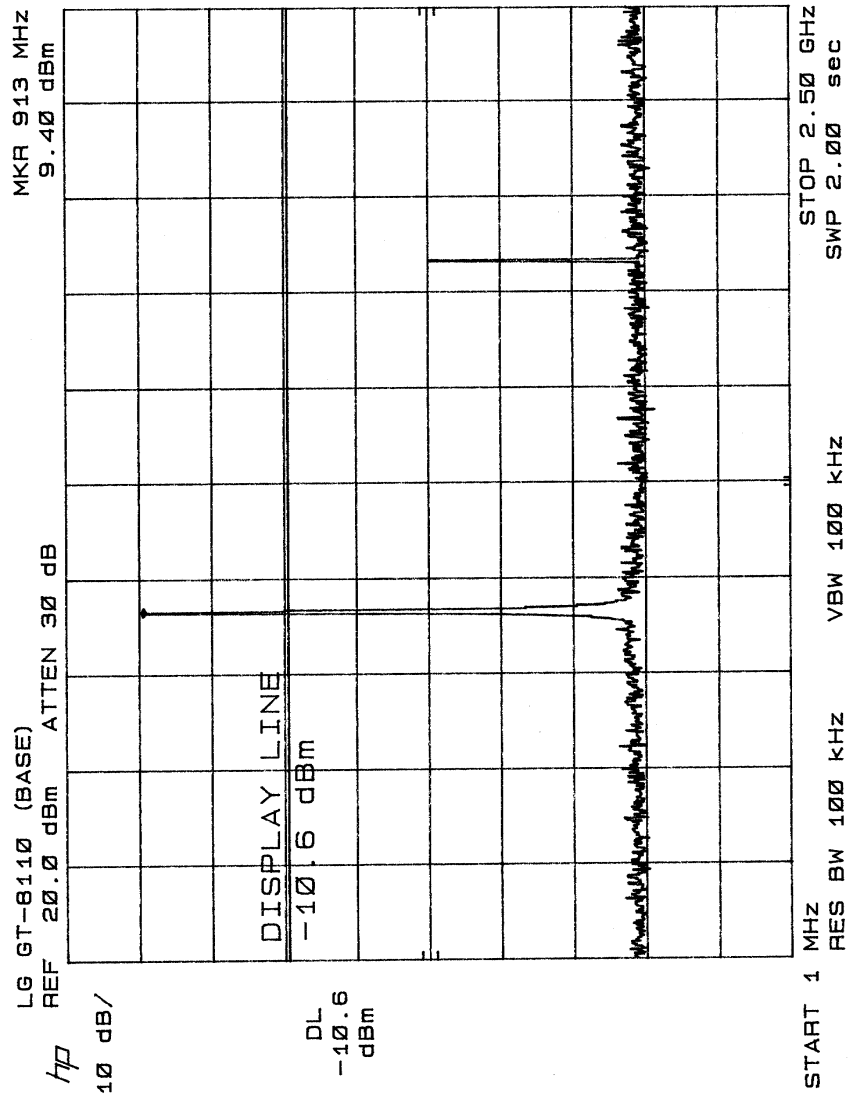

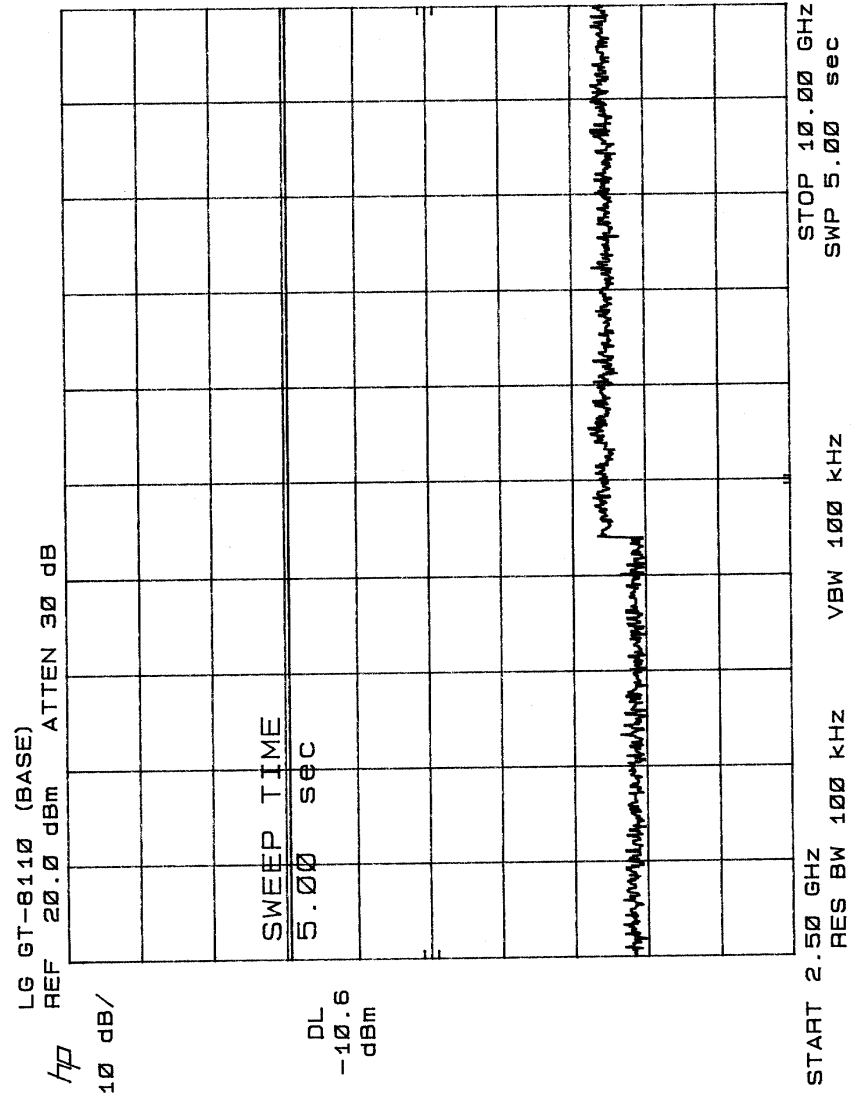

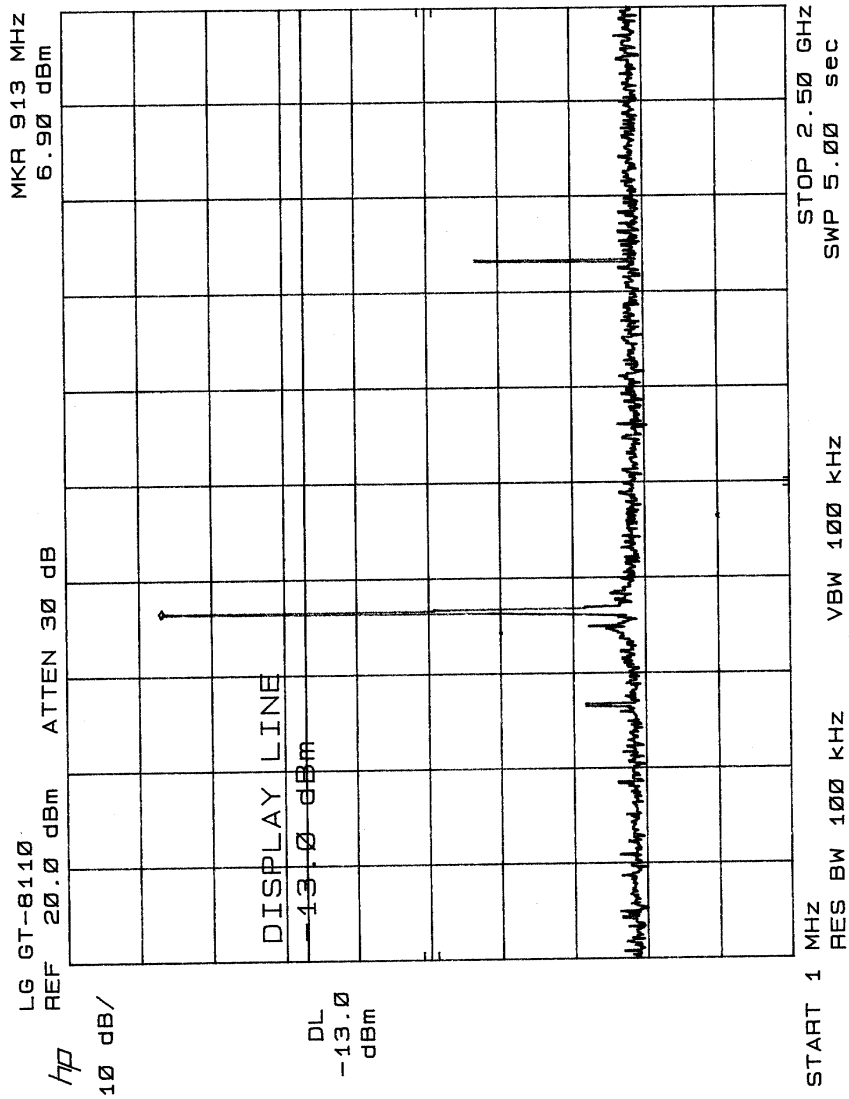

3.6.0 Field Strength of Spurious Radiation (30 MHz-90000MHz)

Requirements: FCC15.247 (2) (c)

3.6.1 Test Procedure

The measurement antenna was placed at a distance of 3 meter from the EUT. During the tests, the antenna height and polarization as well as EUT azimuth were varied in order to identify the maximum level of emissions from the EUT.

The frequency range up to tenth harmonics of each of the three fundamental frequency (low, middle, and high channels) was investigated.

The spurious emissions attenuation was calculated as the difference between EIRP in dB(pW) at the fundamental frequency and at the spurious emissions frequency.

3.6.2 Test Equipment

A.H. System Horn Antenna

High Pass Filter

Preamplifier

Hewlett Packard HP8566B Spectrum Analyzer

Hewlett Packard HP 7470A Plotter

3.6.3 Test Results

Refer to the attached data sheets.

3.6.3.a Final Scan, Base, High Channel.

INDICATED		TABLE	ANTENNA		CORRECTION FACTOR			CORRECTED AMPLITUDE	FCC CLASS B	
Frequency	Ampl.	Angle	Height	Polar	Antenna	Cable	Amp.	Corr. Ampl.	Limit	Margin
MHz	dBµV/m	Degree	Meter	H/ V	dBµV/m	dB	dB	dBµV/m	dBµV/m	dB
926.00	95.3	90	2.0	H	24.7	4.4	20.2	104.2		
926.06	101.3	180	2.0	V	24.7	4.4	20.2	110.2		
1851.60	82.4	300	1.1	V	25.3	2.6	22.0	88.3	90.2	-1.9
325.06	43.9	90	1.3	V	15.5	2.8	22.1	40.1	46.0	-5.9
325.00	43.7	100	1.2	H	15.5	2.8	22.1	39.9	46.0	-6.1
403.21	41.3	0	1.3	H	16.5	2.9	22.5	38.2	46.0	-7.8
409.10	40.9	30	1.9	H	16.5	2.9	22.5	37.8	46.0	-8.2
172.83	40.7	180	1.1	V	13.3	1.4	22.2	33.2	43.5	-10.3
403.22	38.6	180	1.2	V	16.5	2.9	22.5	35.5	46.0	-10.5
266.15	39.9	315	1.2	V	13.3	4.9	22.8	35.3	46.0	-10.7
611.92	33.1	270	1.2	H	20.0	3.3	22.8	33.6	46.0	-12.4
611.92	28.4	90	1.2	V	20.0	3.3	22.8	28.9	46.0	-17.1
1851.60	60.3	270	1.0	H	25.3	2.6	22.0	66.2	90.2	-24.0

3.6.3.b Final Scan, Base, Middle Channel.

INDICATED		TABLE	ANTENNA		CORRECTION FACTOR			CORRECTED AMPLITUDE	FCC CLASS B	
Frequency	Ampl.	Angle	Height	Polar	Antenna	Cable	Amp.	Corr. Ampl.	Limit	Margin
MHz	dBµV/m	Degree	Meter	H/ V	dBµV/m	dB	dB	dBµV/m	dBµV/m	dB
914.84	102.8	90	1.1	V	24.6	4.2	19.8	111.8		
914.84	95.5	180	2.0	H	24.6	4.2	19.8	104.5		
1828.00	83.0	170	1.1	V	25.3	2.6	22.0	88.9	91.8	-2.9
325.00	42.7	270	1.2	V	15.5	2.8	22.1	38.9	46.0	-7.1
266.01	40.0	280	1.9	H	13.3	4.9	22.8	35.4	46.0	-10.6
403.21	37.7	120	1.9	H	16.5	2.9	22.5	34.6	46.0	-11.4
325.02	38.3	190	1.6	H	15.5	2.8	22.1	34.5	46.0	-11.5
264.01	38.8	315	1.2	V	13.3	4.9	22.8	34.2	46.0	-11.8
403.25	36.8	0	1.2	V	16.5	2.9	22.5	33.7	46.0	-12.3
611.92	30.3	60	2.1	H	20.0	3.3	22.8	30.8	46.0	-15.2
407.58	33.6	180	1.8	H	16.5	2.9	22.5	30.5	46.0	-15.5
611.92	28.5	270	1.2	V	20.0	3.3	22.8	29.0	46.0	-17.0
1828.00	66.0	170	1.1	H	25.3	2.6	22.0	71.9	91.8	-19.9

3.6.3.c Final Scan, Base, Low Channel.

INDICATED		TABLE	ANTENNA		CORRECTION FACTOR			CORRECTED AMPLITUDE	FCC CLASS B	
Frequency	Ampl.	Angle	Height	Polar	Antenna	Cable	Amp.	Corr. Ampl.	Limit	Margin
MHz	dBµV/m	Degree	Meter	H/ V	dBµV/m	dB	dB	dBµV/m	dBµV/m	dB
904.57	100.1	90	2.0	V	24.8	3.0	19.8	108.1		
904.57	94.4	120	1.5	H	24.8	3.0	19.8	102.4		
1808.00	79.4	170	1.1	V	25.3	2.6	22.0	85.3	88.1	-2.8
403.24	42.7	45	1.5	H	16.5	2.9	22.5	39.6	46.0	-6.4
324.97	42.9	270	1.2	V	15.5	2.8	22.1	39.1	46.0	-6.9
266.19	43.5	45	1.6	H	13.3	4.9	22.8	38.9	46.0	-7.1
403.17	38.1	180	1.1	V	16.5	2.9	22.5	35.0	46.0	-11.0
608.95	34.2	170	1.1	V	20.1	3.0	22.8	34.5	46.0	-11.5
610.16	33.0	315	1.1	V	20.0	3.3	22.8	33.5	46.0	-12.5
264.75	37.1	290	1.1	V	13.3	4.9	22.8	32.5	46.0	-13.5
611.94	30.2	90	1.6	H	20.0	3.3	22.8	30.7	46.0	-15.3
246.80	34.2	270	1.2	V	12.6	2.3	22.5	26.6	46.0	-19.4
1808.00	60.0	170	1.3	H	25.3	2.6	22.0	65.9	88.1	-22.2

3.6.3.d Final Scan, Handset, High Channel.

INDICATED		TABLE	ANTENNA		CORRECTION FACTOR			CORRECTED AMPLITUDE	FCC CLASS B	
Frequency	Ampl.	Angle	Height	Polar	Antenna	Cable	Amp.	Corr. Ampl.	Limit	Margin
MHz	dBµV/m	Degree	Meter	H/ V	dBµV/m	dB	dB	dBµV/m	dBµV/m	dB
925.78	100.7	270	2.0	H	24.7	4.4	20.2	109.6		
925.78	99.7	180	2.0	V	24.7	4.4	20.2	108.6		
172.83	45.8	90	2.1	H	13.3	1.4	22.2	38.3	43.5	-5.2
326.45	43.4	0	1.5	H	15.5	2.8	22.1	39.6	46.0	-6.5
325.06	42.6	135	1.4	H	15.5	2.8	22.1	38.8	46.0	-7.2
326.40	42.1	135	1.2	H	15.5	2.8	22.1	38.3	46.0	-7.7
172.83	42.3	270	1.2	V	13.3	1.4	22.2	34.8	43.5	-8.7
246.07	43.2	270	1.2	H	12.6	2.3	22.5	35.6	46.0	-10.4
1851.61	71.7	270	1.1	H	25.3	2.6	22.0	77.6	89.6	-12.0
407.61	33.4	90	2.1	H	16.5	2.9	22.5	30.3	46.0	-15.7
611.93	29.2	315	1.1	H	20.0	3.3	22.8	29.7	46.0	-16.3
403.22	32.2	180	1.2	V	16.5	2.9	22.5	29.1	46.0	-16.9
246.07	35.3	315	1.2	V	12.6	2.3	22.5	27.7	46.0	-18.3
611.92	26.3	0	1.2	V	20.0	3.3	22.8	26.8	46.0	-19.2
1851.61	63.7	90	1.3	V	25.3	2.6	22.0	69.6	89.6	-20.0

3.6.3.e Final Scan, Handset, Middle Channel.

INDICATED		TABLE	ANTENNA		CORRECTION FACTOR			CORRECTED AMPLITUDE	FCC CLASS B	
Frequency	Ampl.	Angle	Height	Polar	Antenna	Cable	Amp.	Corr. Ampl.	Limit	Margin
MHz	dBµV/m	Degree	Meter	H/ V	dBµV/m	dB	dB	dBµV/m	dBµV/m	dB
914.68	96.7	170	1.1	V	24.6	4.2	19.8	105.7		
914.68	95.6	280	2.0	H	24.6	4.2	19.8	104.6		
325.00	44.3	280	1.9	H	15.5	2.8	22.1	40.5	46.0	-5.5
325.02	42.1	270	1.2	V	15.5	2.8	22.1	38.3	46.0	-7.7
266.01	40.6	120	1.9	H	13.3	4.9	22.8	36.0	46.0	-10.0
264.01	37.0	90	1.2	V	13.3	4.9	22.8	32.4	46.0	-13.6
1828.81	65.6	315	1.4	V	25.3	2.6	22.0	71.5	85.7	-14.2
1828.81	63.9	135	1.1	H	25.3	2.6	22.0	69.8	85.7	-15.9
611.91	28.0	170	1.1	H	20.0	3.3	22.0	29.3	46.0	-16.7
407.60	32.3	190	1.6	H	16.5	2.9	22.5	29.2	46.0	-16.8
403.25	31.6	90	1.4	V	16.5	2.9	22.5	28.5	46.0	-17.5
611.97	27.6	90	1.2	V	20.0	3.3	22.8	28.1	46.0	-17.9

3.6.3.f Final Scan, Handset, Low Channel.

INDICATED		TABLE	ANTENNA		CORRECTION FACTOR			CORRECTED AMPLITUDE	FCC CLASS B	
Frequency	Ampl.	Angle	Height	Polar	Antenna	Cable	Amp.	Corr. Ampl.	Limit	Margin
MHz	dBµV/m	Degree	Meter	H/ V	dBµV/m	dB	dB	dBµV/m	dBµV/m	dB
904.50	96.4	170	1.0	V	24.8	3.0	19.8	104.4		
904.50	94.8	120	2.0	H	24.8	3.0	19.8	102.8		
1809.00	72.7	120	1.1	H	25.3	2.6	22.0	78.6	84.4	-5.8
172.85	41.1	270	1.4	H	13.3	1.4	22.2	33.6	43.5	-9.9
172.85	40.4	135	1.2	V	13.3	1.4	22.2	32.9	43.5	-10.6
264.75	40.0	315	1.1	V	13.3	4.9	22.8	35.4	46.0	-10.6
1809.00	65.7	350	1.0	V	25.3	2.6	22.0	71.6	84.4	-12.8
611.94	32.4	90	1.7	H	20.0	3.3	22.8	32.9	46.0	-13.1
266.19	36.5	90	1.8	H	13.3	4.9	22.8	31.9	46.0	-14.1
611.92	30.4	0	1.0	V	20.0	3.3	22.8	30.9	46.0	-15.1
403.24	32.0	90	2.1	H	16.5	2.9	22.5	28.9	46.0	-17.1
403.21	28.8	100	1.1	V	16.5	2.9	22.5	25.7	46.0	-20.3
3616.00	36.6	350	1.6	V	30.3	4.3	15.0	56.2	84.4	-28.2
3616.00	34.4	90	1.4	H	30.3	4.3	15.0	54.0	84.4	-30.4

3.7.0 Processing Gain

Processing Gain Measurements for GT-8110 DCT TEST report

3.7.1 Introduction

Scope

This document is a LG Engineering test report for GT-8110 basic DCT cordlessphone. This document details the results of measurement of the processing gain of a DCT FFF phone.

Reference Documents

This section lists documents that are referenced within or are materially relevant to this document.

Code of Federal Regulations, Title 47, Chapter 1, Part 15 Radio Frequency Devices (FCC)

Definitions

FCC	Federal Communications Commission
SNR	Signal to Noise Ratio
JSR	Jammer to Signal Ratio
CW	Continuous wave (jammer)
HS	Handset
BS	Basestation
DBPSK	Differential Binary Phase Shift Keying

Table 1: Definitions and Abbreviations

3.7.2 An Overview of the FCC Method for measuring Processing Gain

Two methods are specified for measuring processing gain by the FCC in 15.247 (e). The first method simply involves calculating the signal to ratio noise (SNR) with the spreading code switched on with the SNR when the spreading code is switched off. The difference between the two is the processing gain. The SNR is measured at the demodulated output of the receiver. In principle this an acceptable method to measure the processing gain of any direct sequence spread spectrum communication system, however, it does not take into consideration that the non-spread spectrum portion of the system may operate under the assumption that the signal being transmitted is a spread spectrum signal and when the spreading code is switched off the system may fail to operate or operate at greatly reduced efficiency, In either case the measurement of processing gain will be meaningless.

The second method specified by the FCC to measure processing gain is detailed in 15.247 (e)(1). This involves transmitting a CW jammer in the RF passband of the system and measuring the jammer to signal ratio (JSR) required to achieve a certain bit error rate. The choice of the actual value of the bit error rate is left up to the tester. The jammer is stepped in 50 kHz increments across the entire passband and in each case the JSR to achieve the desired bit error rate is measured. The JSR is measured at the RF input to the system under test. The lowest 20% of the JSR data (in dB) is discarded. The processing gain can then be calculated as follows:-

$$G_p = \left(\frac{S}{N} \right)_{theory} + \left(\frac{J}{S} \right)_{measured} + L_{system}$$

$$\left(\frac{S}{N} \right)_{theory} \quad \left(\frac{J}{S} \right)_{measured}$$

where G_p is the processing gain, the SNR is that theoretically predicted for the system under the test to achieve the desired bit error rate, the JSR is the lowest value (in dB) in the remaining data set and L_{sys} adjusts for non-ideal system losses. L_{sys} can not be greater than 2 dB.

3.7.3 Processing Gain Measurement Results

The following parameters were used in the test setup.

HS Tx power (dBm)	-4.3	
BS LNA gain (dB)	0	
Test system losses (signal) (dB)	-14.55	-4.05 dB (system), -3 dB (signal combiner), -7.5 dB (2 cables)
Test system losses (jammer) (dB)	-5.6	-3 dB (signal combiner), -2.6 dB (2cables)

Table 2: Test Setup Parameters

The following measurement results were taken at the basestation. The desired bit error rate was set at 10^{-3} .

Jammer Frequency (MHz)	BER (BS)	Received jammer power (dBm)	Received signal power (dBm)	Jammer/Signal ratio (dB)
903.60	9.95×10^{-4}	-15.2	-17.1	1.9
904.80	1.25×10^{-3}	-14.9	-16.9	2.0
906.00	9.6×10^{-4}	-15.0	-17.3	2.3
907.20	9.6×10^{-4}	-14.5	-16.8	2.3
908.40	1.23×10^{-3}	-14.9	-17.4	2.5
909.60	9.8×10^{-4}	-15.3	-17.2	1.9
910.80	1.13×10^{-3}	-14.7	-16.9	2.2
912.00	9.23×10^{-4}	-14.8	-16.6	1.8
913.20	1.12×10^{-3}	-14.9	-17.1	2.2
914.40	1.2×10^{-3}	-14.8	-16.9	2.1
915.60	9.89×10^{-4}	-15.0	-17.5	2.5
916.80	1.11×10^{-3}	-14.7	-16.9	2.2
918.00	1.21×10^{-3}	-15.2	-16.9	1.7
919.20	1.08×10^{-3}	-14.9	-17.0	2.1
920.40	9.87×10^{-4}	-15.1	-17.3	2.2
921.60	1.8×10^{-3}	-15.3	-17.6	2.3
922.80	9.87×10^{-4}	-15.1	-17.6	2.5
924.00	1.54×10^{-3}	-15.3	-17.0	1.7
925.20	1.65×10^{-3}	-15.3	-17.3	2.0
926.40	9.0×10^{-4}	-15.6	-17.4	1.8

Table 3: Test Results

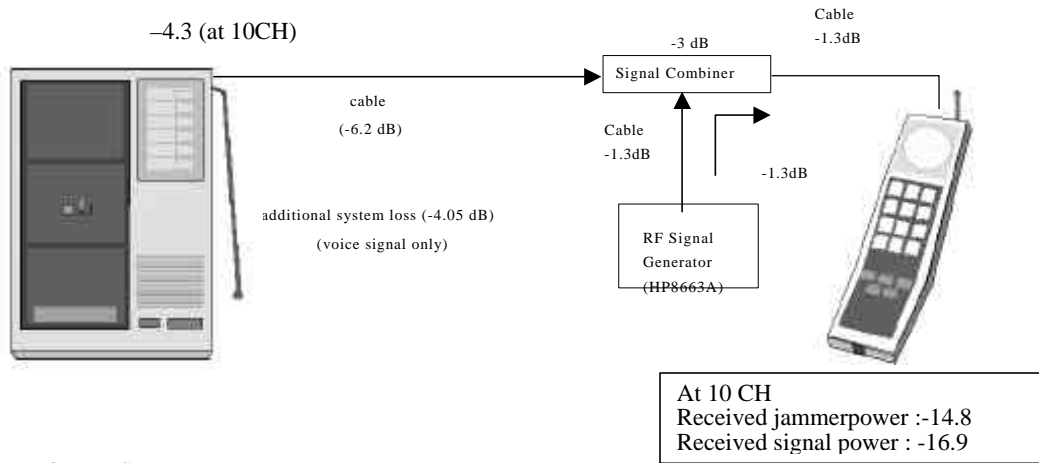

Figure 1: Test Setup

For DBPSK at 10^{-3} bit error rate the required SNR is 8.0 dB. Using the results above and the data in the table below the processing gain is calculated to be 12.1 dB.

required SNR (dB)	8.0
system losses (dB)	2.0
J/S ratio at 80% point (dB)	2.1
FCC Processing gain (dB)	12.1

Table 4: Processing Gain Calculation data

3.7.4 Conclusions

The result measured for processing gain of 12.1 dB is close to the actual processing gain due to a 12 chip spreading code of

$$10 \cdot \log_{10}(12) = 10.8 \text{ dB}$$

4 - CONDUCTED EMISSIONS TEST DATA

4.1 Measurement Uncertainty

All measurements involve certain levels of uncertainties, especially in field of EMC. The factors contributing to uncertainties are spectrum analyzer, cable loss, and LISN.

Based on NIS 81, The Treatment of Uncertainty in EMC Measurements, the best estimate of the uncertainty of any conducted emissions measurement at BACL is ± 2.4 dB.

4.2 EUT Setup

The measurement was performed at the **Open Area Test Site**, using the same setup per ANSI C63.4 - 1992 measurement procedure. The specification used was with FCC Class B limits.

4.3 Spectrum Analyzer Setup

The spectrum analyzer was set with the following configurations during the conduction test:

Start Frequency 450 kHz
 Stop Frequency 30 MHz
 Sweep Speed Auto
 IF Bandwidth 100 kHz
 Video Bandwidth 100 kHz
 Quasi-Peak Adapter Bandwidth 9 kHz
 Quasi-Peak Adapter Mode..... Normal

4.4 Test Procedure

During the conducted emission test, the power cord of the host system was connected to the auxiliary outlet of the first LISN.

Maximizing procedure was performed on the six (6) highest emissions of each modes tested to ensure EUT is compliant with all installation combination.

All data was recorded in the peak detection mode. Quasi-peak readings were only performed when an emission was found to be marginal (less than -4 dBµV). Quasi-peak readings are distinguished with a "Qp".

4.5 Summary of Test Results

According to the data in section 3.6, the EUT complied with the FCC Conducted margin for a Class B device and these test results is deemed satisfactory evidence of compliance with ICES-003 of the Canadian Interference-Causing Equipment Regulations, with the *worst* margin reading of:

-7.3 dBµV at 17.320 MHz in the **Neutral** mode power supply.

4.6 Conducted Emissions Test Data

4.6.1 Test Data, 0.45 - 30 MHz.

LINE CONDUCTED EMISSIONS				FCC CLASS B	
Frequency	Amplitude	Detector	Phase	Limit	Margin
MHz	dBµV	Qp/Ave/Peak	Line/Neutral	dBµV	dB
17.320	40.7	QP	Neutral	48	-7.3
17.680	41.0	QP	Line	48	-7.0
10.760	39.4	QP	Line	48	-8.6
9.430	39.0	QP	Neutral	48	-9.0
9.140	38.0	QP	Line	48	-10.0
7.390	37.4	QP	Neutral	48	-10.6

4.7 Plot of Conducted Emissions Test Data

Plot(s) of Conducted Emissions Test Data is presented in the following Appendix of this report as reference.

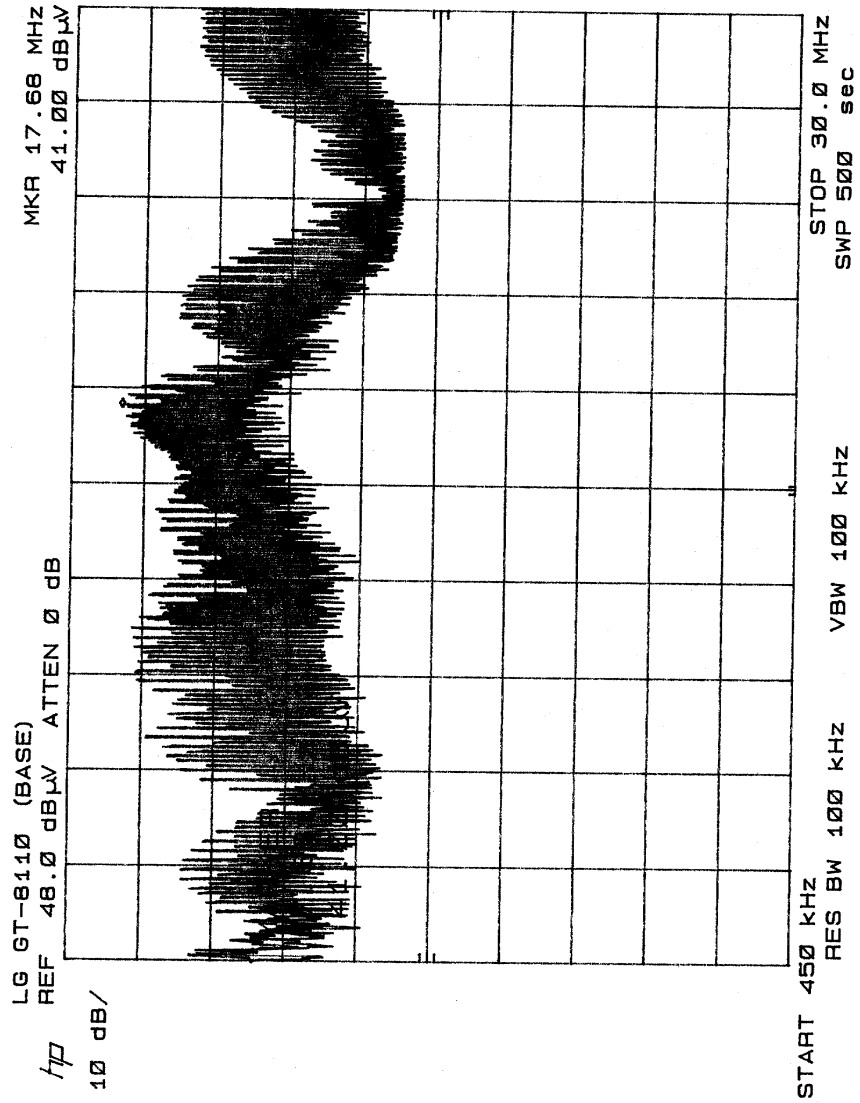

Appendix A – AGENT AUTHORIZATION LETTER



LG Kangseo B/D 36, Munjae-Dong, 6-Ga,
Youngdungpo-Gu, Seoul, 150-096, Korea
Youngdungpo P.O Box101, Seoul, Korea
Telephone : 82-2-2630-3651~2
Fax : 82-2-2630-3669

Exhibit B

AUTHORITY TO ACT AS AGENT TO THE FEDERAL COMMUNICATIONS COMMISSION

Date : February 21, 2000

Federal Communications Commission
Authorization and Evaluation Division
Equipment Authorization Branch
7435 Oakland Mills Road
Columbia, MD 21046 U.S.A.

Dear Sir:

We, the undersigned, hereby authorize Bay Area Compliance Laboratory Corp. to act on our behalf in all matters relating to applications for approval of Telecommunication apparatus, including the signing of all documents relating to this matters.

Any and all acts carried out by Bay Area Compliance Laboratory Corp., on our behalf shall have the same effect as acts of our own.

I further appoint Bay Area Compliance Laboratory Corp., to act as agent in preparation of this application for registration of LG Information & Communications, Ltd., Model GT-8110 as Exhibit C under Part 68 of the Rules and Regulations of the Federal Communications Commission.

I certify that the exhibits properly describe the device or system for which registration is sought, that Exhibit G represents the policies of the applicant which will be followed for all units manufactured and distributed under the provisions of Part 68, that the labels described in Exhibit H will be affixed to each unit, and that the information described in Exhibit J will be provided with each unit manufactured or distributed by the applicant. We also certify that no party to the applications authorized hereunder is subject to benefits, including FCC benefits, Pursuant to Section 5301 of the Anti-Drug Abuse Act of 1988, 21 USC 853(a).

Sincerely yours,

A handwritten signature in black ink, appearing to read 'D.S. Kim', is written over a horizontal line.

D.S.KIM / Quality Engineering Dept.
LG Information & Communications, Ltd.