



LE4000/LE4000E

LTE Wireless Alarm Communicator

Installation Manual

V5.X

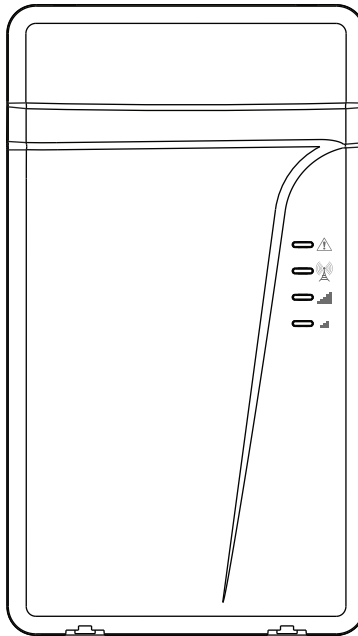

Warning: This manual contains information on limitations regarding product use and function and information on the limitations as to liability of the manufacturer. The entire manual should be carefully read.

Table of Contents

Section 1: Introduction	5
1.1 Features	5
1.2 Technical specifications	5
Section 2: Identification of parts	7
Section 3: Installing the LE4000/LE4000E	8
Section 4: Connecting the LE4000/LE4000E	11
Section 5: Status LEDs	12
5.1 Operating modes	12
5.2 Normal mode	12
5.3 Service mode	13
Section 6: Operating principles	14
6.1 Simulated landline mode	14
6.2 Panel transmission monitoring (PTM)	14
6.3 Wireless communications sequence	14
6.4 Inputs	15
6.5 Outputs	15
6.5.1 Activating the outputs	15
6.6 Reporting codes	15
6.7 Swinger shutdown	16
6.8 Hardware default	16
6.9 Communicator reset/update	17
6.10 Low power radio shutdown	17
6.11 SMS command and control	17
6.11.1 Arming/disarming the security panel	18
6.11.2 Remote control of the PGM	18
6.12 Phone number call direction	19
Section 7: Troubleshooting guide	20
Section 8: LE4000/LE4000E wiring diagrams	24

Safety information

The equipment is fixed, wall-mounted and shall be installed in the position specified in these instructions. The equipment enclosure must be fully assembled and closed, with all the necessary screws/tabs and secured to a wall before operation. Internal wiring must be routed in a manner that prevents:

- Excessive strain on wire and on terminal connections
- Loosening of terminal; connections
- Damage of conductor insulation

WARNING: Never install this equipment during a lightning storm!

Instruct the end-user to:

- Not attempt to service this product. Opening or removing covers may expose the user to dangerous voltages or other risks. Any servicing shall be referred to trained service persons only.
- Use authorized accessories only with this equipment.
- Do not dispose of the battery in fire or water. Disposing of the battery in a fire will cause rupture and explosion.
- Do not dispose of the waste battery as unsorted municipal waste. Consult your local regulations and /or laws regarding recycling with regard to this lead-acid battery. Doing so will help protect the environment. Some of the materials that are found within the battery could become toxic if not disposed of properly and may affect the environment.

This equipment, LE4000/LE4000E, is fixed and shall be installed by skilled person only; skilled persons are persons who have training or experience in the equipment technology, particularly the various energies and energy magnitudes used in the equipment. Skilled persons are expected to use their training and experience to recognize energy sources capable of causing pain or injury and to take action for protection from injury. Skilled persons are persons who have training or experience in the equipment technology, particularly the various energies and energy magnitudes used in the equipment. Skilled persons are expected to use their training and experience to recognize energy sources capable of causing pain or injury and to take action for protection from injuries.

It shall be installed and used within an environment that provides the pollution degree max 2, over voltages category II, in non-hazardous, indoor locations only. This manual shall be used with the Installation Manual of the relevant alarm control panel. All instructions specified within that manual must be observed.

Approvals

For UL Residential Fire and Burglary installations, the LE4000/LE4000E is listed as a sole means of communication or as a back up when used in conjunction with a POTS line (dialer). For UL Residential Fire installations, the LE4000/LE4000E must be connected to a UL-listed power supply with a minimum of 24 hours standby power or powered using the ADP 1310(W)-NAU and a 2200mAh battery.

For UL Commercial Burglary installations, the LE4000/LE4000E is listed as a sole means of communication (supervision window of 200s required at monitoring station) or as a back-up when used in conjunction with a POTS line (dialer).

The LE4000/LE4000E shall be powered from any compatible listed control unit or compatible listed power supply that complies with the ratings specified. The power supply shall be listed for burglary applications and provide a minimum of 4 hours standby power capabilities. An example of a suitable listed compatible control unit is the DSC Model PC1864 with an AUX output rated 11.1 - 12.6Vdc. An example of a suitable Listed power supply is DSC Model PC5204 with an AUX output rated 11.6 - 12.6Vdc.

For ULC Commercial Burglary installations the LE4000/LE4000E is listed as a passive communication system with communication line security level P1 when used as single communication path or P2 when used as a back up in conjunction with a POTS line (dialer). The LE4000/LE4000E is also listed for Active line security levels A1-A4 (90 seconds heartbeat enabled and supervision window of 180s required at monitoring station receiver and encryption must be enabled). For ULC Commercial Burg installations, the LE4000/LE4000E must be connected to a ULC-listed power supply with a minimum of 24 hours standby power or powered using the ADP 1310(W)-NAU and a 2200mAh battery. The LE4000/LE4000E can be used in commercial burglary applications up to Security Level IV.

For ULC Residential Fire and Burglary installations the LE4000/LE4000E is listed as a sole means of communication or as a back up when used in conjunction with a POTS line (dialer). For ULC Residential Fire

installations, the LE4000/LE4000E must be connected to a ULC-listed power supply with a minimum of 24 hours standby power or powered using the ADP 1310(W)-NAU and a 2200mAh battery.

Notes for using private, corporate and high speed data networks: Network access and domain access policies shall be set to restrict unauthorized network access, and “spoofing” or “denial of service” attacks. Select internet service providers that have redundant servers/systems, back-up power, routers with firewalls enabled and methods to identify and protect against “denial of service” attacks (i.e., “spoofing”).

Section 1: Introduction

The LE4000/LE4000E is a cellular communicator that sends alarm system information to a Sur-Gard System I-IP, II, III, IV or 5 receiver through an LTE or 3G wireless network. This cellular communicator can be used with UL/ULC Listed compatible control units, as indicated in the manufacturer's installation instructions.

The performance of the LE4000/LE4000E depends greatly on cellular network coverage. Therefore, it should not be mounted without first performing placement tests to determine the best location for reception (minimum of one blue/green LED ON). Optional antenna kits – LTE-8ANT (8ft/2.4m), LTE-15ANT (15ft/4.6m), LTE-25ANT (25ft/7.6m) and LTE-50ANT (50ft/15.2m) are available.

Note: The LE4000/LE4000E is designed to work with the Contact ID communication format as described in the SIA DC-05 standard, as well as the SIA communications format as described in the SIA DC-03 standard. Before completing the field installation of the alarm monitoring system please ensure communication with the supervising central station is successful by sending several events and getting confirmation that they have been received.

1.1 Features

- Penta-Band LTE; Dual-band UMTS (BII/V)
LTE Radio: Band 2, Band 4, Band 5, Band 12, Band 13, Band 66
- Advanced carrier selection
- Cellular signal indicator
- LTE /3G/ internet communication with Sur-Gard SG-System I-IP / II / III / IV / 5
- Compatible with 4-digit or 10-digit Contact ID communication format as described in SIA DC-05 Standard and the SIA DC-03 standard for 300 baud. Example of suitable compatible alarm panels:
DSC models HS2128, HS2064, HS2032, HS2016, PC1864, PC1832, PC1616, PC4020.
- Panel transmission monitoring for up to four phone numbers
- Simulates landline
- Switches automatically to the 3G or LTE network in the event of a landline trouble (e.g., line down)
- DLS support for status, firmware updates and remote debug enable
- Remote firmware upgrade
- Remote diagnostics
- Case and wall tamper
- Panel format detection
- 2 programmable inputs
- 2 programmable outputs

1.2 Technical specifications

The input voltage to the LE4000/LE4000E can be drawn from the UL/ULC Listed control panel or provided by an external UL/ULC listed power supply (with battery back-up) rated for the application (external power-limited source)

Table 1-1 Technical specifications

Power supply rating	
Input voltage class:	Class 2, power limited
Compatible external power adapters (2-prong):	DSC ADP1310(W)-NAU (US) / ADP1310(W)-NA (Canada) NOTE: For UL/ULC listed installations, the input rating for the external power adapter is 120V _{AC} /60Hz/0.4A.
Input voltage/input current (nominal):	13.8V _{DC} /700mA (when supplied by compatible external power adapter) 9-14V _{DC} /500mA (use listed, compatible control panel or power supply)
Average current:	40mA*
Peak current (no battery):	180mA*

Peak current (with battery):	350mA* * Plus any current draw from LE4000/LE4000E + ve terminal
Battery:	NiMH, rated 7.2V, 2.2Ah
Battery charging voltage (maximum):	9.1Vdc
Battery charging current:	160mA
Battery standby time:	24 hours NOTE: Battery must be replaced every 3-5 years.
LE4000 Cellular	
3G	Bands B2, B5
LTE	Bands B2, B4, B5, B12, B13 (see Table 1-2 : Band frequencies)
Antenna gain	2.0 dBi
LE4000E Cellular	
LTE	Bands B2, B4/B66, B12 (see Table 1-2 : Band frequencies)
Antenna gain	refer to table on page 27
Environmental specifications	
Operating temperature:	0°C-49°C (32°F-120°F)
Humidity:	93% RH maximum (non-condensing)
Mechanical specifications	
Dimensions (mm):	125mm (W) x 220mm (H) x 31mm (D)
Dimensions (inches):	4.9" x 8.7" x 1.2"
Weight (without battery):	400g / 1.2oz
Simulated Telco loop specifications	
On-hook voltage:	12Vdc
Off-hook current:	24mA
Loop current:	25mA
Loop resistance:	600 Ohms

Table 1-2 Band frequencies

Band	Transmit band (Tx)	Receive band (Rx)
LTE B2	1850 – 1910 MHz	1930 – 1990 MHz
LTE B4	1710 – 1755 MHz	2110 – 2155 MHz
LTE B5	824 – 849 MHz	869 – 894 MHz
LTE B12	698 – 716 MHz	728 – 746 MHz
LTE B13	777 – 787 MHz	746 – 756 MHz
LTE B66	1710 – 1780 MHz	2210 – 2200 MHz
UMTS B2	1850 – 1910 MHz	1930 – 1990 MHz
UMTS B5	824 – 840 MHz	869 – 894 MHz

Section 2: Identification of parts

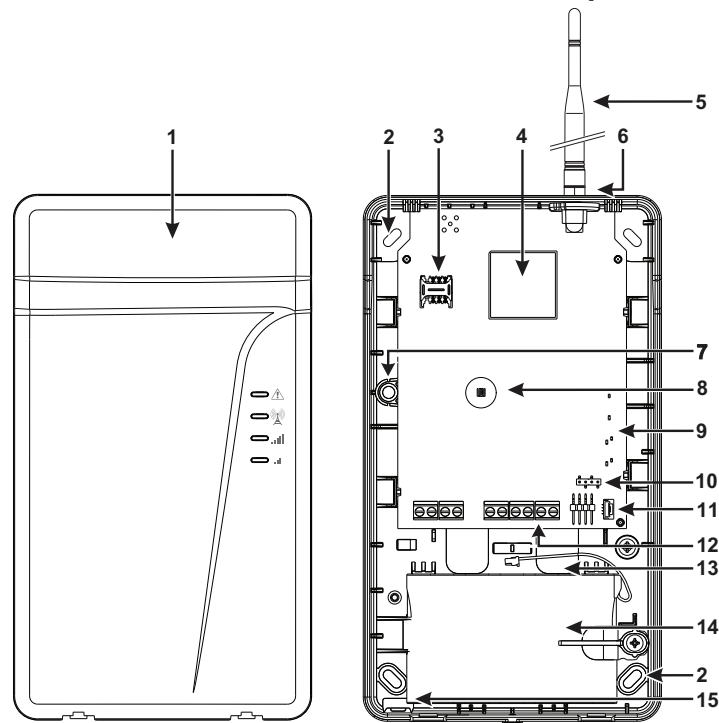

1	Plastic casing
2	Anchor screw holes (3mm)
3	SIM card holder
4	LTE radio module
5	LTE external antenna*
6	Antenna mounting hardware
7	Wall tamper switch
8	Cover tamper switch
9	Status LEDs (see "Status LEDs" on page 12)
10	PC-Link connector
11	Battery connector
12	Terminal blocks
13	Cable entry
14	7.2V - 2.2Ah battery (optional)
15	Cable run knockout
* Use only DSC provided antenna.	

Section 3: Installing the LE4000/LE4000E

C24 communications enrollment

The LE4000/LE4000E requires enrollment with C24 Communications to operate. For more information, please visit www.connect24.com, contact C24 Communications customer service at 1-888-251-7458 (US) / 1-888-955-5583 (Canada) or contact the central station to inquire if they are a C24 Communications Master Reseller.

Note: Enrollment with C24 Communications should be performed before turning on the LE4000/LE4000E unit.

Before inserting or removing the SIM card, please ensure the unit is turned off.

Step 1 - Initializing the LE4000/LE4000E with C24 communications

The LE4000/LE4000E can be initialized with C24 Communications by:

web - www.connect24.com

mobile - m.connect24.com

To complete enrollment, a C24 profile, installer ID/PIN (or web credentials) and the 20-digit SIM number are required.





Note: The SIM activation process with the cellular carrier typically takes between five and ten minutes to complete.

Step 2 - Determining the best signal location

1. Remove the front cover by inserting a screwdriver into each of the slots at the bottom of the enclosure and pushing down.
2. Apply power (DC and/or battery). The LE4000/LE4000E is now in Placement Test mode.

Step 2a – SIM card is activated





The red LED will be on solid, the blue LED will be off and the signal strength LEDs will display the average signal strength. In this state, the LE4000/LE4000E is registered to the cellular network.

 Red	 Blue	 Blue/Green (Top)	 Blue/Green (Bottom)
ON	OFF	-	-

If the signal strength is too low (bottom signal LED off or flashing), the LE4000/LE4000E will move to **Step 3** and scan for carriers with sufficient signal strength and attach to the carrier. If the LE4000/LE4000E is connected to a carrier with sufficient signal strength (minimum of bottom signal strength LED on solid), it will move to **Step 4**.

Step 2b – SIM card is not activated

The red LED will flash, the blue LED will be off and the signal strength LEDs will display the average signal strength.





 Red	 Blue	 Blue/Green (Top)	 Blue/Green (Bottom)
FLASHING	OFF	-	-

In this state, the LE4000/LE4000E is unable to register to the cellular network because it is inactive. The signal strength indicated is from **any** nearby cell tower (including cellular towers belonging to non-roaming partners) and does **not** necessarily reflect the signal strength of the intended network. The LE4000/LE4000E will remain in this state until the SIM is activated. Once the SIM is activated, the LE4000/LE4000E will move to **Step 2a**.

Step 3 – Carrier scanning due to insufficient signal strength

The LE4000/LE4000E will scan the surrounding cellular network and connect to the carrier to provide a signal strength of at least 7 CSQ. When this action is being performed, all four LEDs will activate to show a scanning sequence. The LEDs will cycle from top to bottom and then bottom to top. This cycle will continue until the LE4000/LE4000E is connected to a carrier with a signal strength above 7 CSQ (minimum of bottom signal strength LED on solid). This process can take several minutes.

The carrier scanning sequence repeats until complete.

 Red	 Blue	 Blue/Green (Top)	 Blue/Green (Bottom)
FLASH ON	OFF	OFF	OFF
OFF	FLASH ON	OFF	OFF
OFF	OFF	FLASH ON	OFF
OFF	OFF	OFF	FLASH ON
OFF	OFF	FLASH ON	OFF
OFF	FLASH ON	OFF	OFF
FLASH ON	OFF	OFF	OFF

Once this is completed, the LE4000/LE4000E will move to **Step 4**.

Step 4 - Acquire C24 communications programming

The red LED will be on solid and the blue LED will flash. The flashing of the blue LED indicates that the LE4000/LE4000E has requested programming from C24 Communications and is waiting for a response.

 Red	 Blue	 Blue/Green (Top)	 Blue/Green (Bottom)
ON	FLASHING	-	-





Once remote programming is completed, the blue LED will switch to solid and the LE4000/LE4000E will move to **Step 5**.

Step 5 – Receiver initialization

The red LED and the blue LED are both solid and the signal strength LEDs are off.

 Red	 Blue	 Blue/Green (Top)	 Blue/Green (Bottom)
ON	ON	OFF	OFF

When the LE4000/LE4000E sends a request to communicate with the central station, the top signal strength LED will begin flashing.

 Red	 Blue	 Blue/Green (Top)	 Blue/Green (Bottom)
ON	ON	FLASHING	OFF

When the central station communicates back with the LE4000/LE4000E, the top signal strength LED will turn on solid.

 Red	 Blue	 Blue/Green (Top)	 Blue/Green (Bottom)
ON	ON	ON	OFF

When the LE4000/LE4000E sends a request to communicate with the next central station, the bottom signal strength LED will begin flashing.

 Red	 Blue	 Blue/Green (Top)	 Blue/Green (Bottom)
ON	ON	ON	FLASHING

When a signal is received back from the central station, The bottom signal strength LED turns on solid.

 Red	 Blue	 Blue/Green (Top)	 Blue/Green (Bottom)
ON	ON	ON	ON

If at least one of the central stations did not respond back to the communicator, the signal strength LED corresponding to that central station will turn off. Once the initialization sequence is complete, the LE4000/LE4000E will move on to steady state operation.

Step 6 - Mounting the LE4000/LE4000E

Note: If using an LE4000/LE4000E trim plate, snap the LE4000/LE4000E back plate onto the trim plate before mounting to the wall. For flush mounting or using with an extension antenna, remove the provided breakaway from the trim plate prior to mounting.

1. Using the mounting holes on the LE4000/LE4000E backplate, mark the four screw locations. Drill the anchor screw holes.
NOTE: Check for cable conduits and water pipes before drilling.
2. Inspect the mounting surface. Ensure that the surface is flat and will hold the wall tamper closed when mounted. Using anchor screws (not provided), mount the cabinet to the wall.
3. Run the cables through the cable entry [13] or through the cabinet cable run knockout [15].
4. Complete the connections on the terminal blocks [12].
5. Reattach the front cover [1] securely to the cabinet.

Note: Refer to the wiring diagram at the end of this manual.

Section 4: Connecting the LE4000/LE4000E

TIP (1) / RNG (2) External telephone line - If the LE4000/LE4000E is being used as a back-up communicator, these terminals must be connected directly to the incoming telephone line.

T1 (3) / R1 (4) Internal telephone line - These terminals must be connected to the TIP and RING of the control panel.

Zone 1 (5) and Zone 2 (7) programmable inputs - These terminals can be set up to trigger events. Refer to 'Inputs' for details.

PGM1 (6), PGM2 (8) programmable open-collector outputs - These outputs can be activated by programmed events. Refer to 'Activating the Outputs' for details. The maximum current sink of each output must not exceed 50mA.

DC in + (9), DC in - (10) device power supply - These terminals must be connected to a rated power supply.

Once the connections are completed, connect the battery, [11] in Parts diagram, to a 7.2V, 2.2Ah battery.

Battery - Loosen the screw on the movable retaining clip and rotate counterclockwise until it is pointing at the bottom of the unit. If removing an existing battery unclip the battery connector from the PCB and lift battery out.

CAUTION: When removing the battery, ensure you depress the locking tab before attempting to remove the battery connector from the PCB. Failure to do so may result in damage to the connector and/or battery.

Insert new battery with the label side up and connect to PCB. Rotate the movable retaining clip clockwise until horizontal with the bottom of the unit and tighten the screw with screwdriver.

When disposing of batteries, follow the instructions and precautions printed on the batteries, and contact your municipal offices for information on the disposal of used batteries.

Section 5: Status LEDs





5.1 Operating modes

The LE4000/LE4000E features two distinct operating modes: Normal Mode and Service Mode. The unit will be in Normal Mode when the cover tamper is in a restored state. If a cover tamper is present, the unit will be in Service Mode.

5.2 Normal mode

The LE4000/LE4000E interface has four status LEDs. The following describes the status LEDs when the communicator is in normal operating mode (cover and wall tampers both in a restored state).



Table 4-1 Status LEDs

<p>Red</p> 	<p>This LED indicates trouble conditions. On (solid): Trouble Requiring Service 1 Flash: Wireless Network Trouble 2 Flashes: Battery Trouble 3 Flashes: Input Power Trouble</p>
<p>Blue</p> 	<p>This LED indicates cellular radio activity. When this LED is on (solid), a phone line trouble condition exists. This LED turns on when the interface switches to the wireless network (due to a landline trouble condition). This LED will also flash once when the LE4000/LE4000E transmits a signal and twice it receives a kiss-off from the central station. NOTE: If the LE4000/LE4000E is programmed to be the primary communicator, the blue LED remains off, but still flashes during the signal transmission as described above.</p>
<p>Blue/Green (Top)</p> 	<p>This LED indicates signal strength and network technology. If the LE4000/LE4000E is operating in over an LTE channel, the LED is blue. If the LE4000/LE4000E is operating over a 3G channel, the LED is GREEN.</p>
<p>Blue/Green (Bottom)</p> 	<p>Blue / Green (Top) - This LED indicates signal strength and network technology. If the LE4000/LE4000E is operating on an LTE channel, the LED is blue. If the LE4000/LE4000E is operating on a 3G channel, the LED is Green. If this LED is off and the Red LED is on, the wireless network service is unavailable (NO SERVICE). This LED flashes when wireless network reception is poor. If this LED is on, the LE4000/LE4000E is able to communicate with the LTE or 3G network.</p>

5.3 Service mode

To view detailed trouble information on the status LEDs, place the LE4000/LE4000E in Service mode by removing the front cover. When in Service mode, the status LEDs indicate troubles as follows.

Table 4-2 LED troubles

Number of flashes		Troubles
 RED	 BLUE	
1	OFF	Wireless network trouble - unable to connect to cellular network
2	OFF	Battery trouble - battery with low voltage output
3	OFF	Input power trouble
1	Flashing	Insufficient signal strength - poor location
2	Flashing	Not used
3	Flashing	C24 communication configuration trouble
1	ON	Radio/SIM trouble - radio or SIM unresponsive
2	ON	Receiver not available trouble
3	ON	Supervision trouble
4	ON	Case or wall tamper is open
OFF	-	No trouble

Section 6: Operating principles

6.1 Simulated landline mode

The simulated landline provides the alarm control panel (with dialer interface) with a back up line in the event of PSTN line trouble.

Note: The LE4000/LE4000E must be programmed as a back-up communicator for Simulated Landline Mode to operate.

If the voltage on the landline terminals (TIP/RNG) drops below 2.8V for a period of between 10 seconds and 45 seconds - depending on the alarm control panel connected to the T1/R1 terminals- the LE4000/LE4000E switches the connected telephone device to the cellular network. After waiting between 30 and 40 seconds, it checks the landline for one of the following:

- If the landline has been restored, the LE4000/LE4000E switches the connected device back to the landline, OR
- If the landline is still down, the LE4000/LE4000E continues the simulation until the landline is restored. The LE4000/LE4000E will not switch during ongoing calls.

Note: When the landline is down, the LE4000/LE4000E provides a dial tone to any device connected to T1 and R1, including any telephones on the premises. The phones on the premises will not, however, be able to dial out over the LE4000/LE4000E.

6.2 Panel transmission monitoring (PTM)

The LE4000/LE4000E can also monitor the panel's attempt to communicate with the central station. If it determines that the panel is having difficulty, it switches the line to the cellular network. This feature is only active when the LE4000/LE4000E is configured as a back up communicator. This feature is in addition to the regular line voltage detection.

The LE4000/LE4000E monitors the phone line for four consecutive failed attempts within a 12-minute window. A failed attempt is assumed to have occurred when a line seizure takes place during dialing (either the alarm panel or the customer telephone), but no 1400Hz tone (Contact ID kiss-off) is sent from the receiver.

Once the conditions for a failed attempt are met, the LE4000/LE4000E connects the panel to the cellular network to communicate the events. When the LE4000/LE4000E switches the line it stays in this mode until the panel hangs up. On the next event the LE4000/LE4000E restarts the error detection sequence before switching.

The LE4000/LE4000E performs this sequence on any phone number that is detected on the line. Specific central station phone numbers can be programmed into the LE4000/LE4000E if desired. The phone number programmed in the LE4000/LE4000E must match the number dialed by the panel exactly. Up to four, 20-digit numbers can be added to your profile at Connect 24. If programmed, the LE4000/LE4000E will only look for a Contact ID kiss-off after these numbers are dialed. A Telephone Line Monitoring trouble (PGM output activation and/or reporting code if applicable) is also activated and/or transmitted when the PTM is activated. A restoral is sent at the end of the call.

6.3 Wireless communications sequence

When an alarm is triggered:

- The control panel goes off-hook.
- The LE4000/LE4000E asserts a dial tone.
- The Control panel dials the number of the central station. Ensure that the alarm panel inserts a minimum one second pause, or has Dial Tone Search enabled before dialing the number.
- The LE4000/LE4000E detects the DTMF dialing and stops dial tone.

Note: The LE4000/LE4000E is unable to decode pulse dialing.

If the panel is programmed for Contact ID format:

- The LE4000/LE4000E sends the required Contact ID dual-tone handshake to the panel.
- After receiving the handshake, the control panel transmits an alarm message in Contact ID format.

- The LE4000/LE4000E decodes and transforms the Contact ID digits into an IP packet and sends it to the central station receiver over the cellular network.
- The central station receiver acknowledges the alarm and sends a command to the LE4000/LE4000E to generate the corresponding 1400Hz Kiss-off signal for a minimum of 800 milliseconds.

After the LE4000/LE4000E generates a Kiss-off signal, it sends the next alarm or, if no further alarms need to be sent, the control panel goes on-hook.

6.4 Inputs

The LE4000/LE4000E has four inputs that can be used to trigger specific communications. These events transmit using the Contact ID or SIA format with Inputs 1-4 reporting as [991] to [994] respectively.

Default settings are:

INPUT 1- BURGLARY ZONE

INPUT 2 - SUPERVISORY ALARM

These inputs are normally open and activate when a short condition is detected between the terminal and the COM. Refer to the wiring diagram at the back of this manual.

6.5 Outputs

The LE4000/LE4000E has two programmable outputs to activate in response to the associated events. Refer to the LE4000/LE4000E Wiring Diagram at the back of this manual for more information.

6.5.1 Activating the outputs

The LE4000/LE4000E has two open collector outputs capable of a maximum of 50mA. Internal events on the LE4000/LE4000E can trigger the outputs to turn on an LED or activate an input on the host panel. The default settings are as follows.

OUTPUT 1 Wireless Module or Network Trouble - Output is normally high and will switch to ground when the LE4000/LE4000E can not communicate with the LTE or 3G network.

OUTPUT 2 General Module Trouble - Output is normally low and will switch to high when a Wireless Network trouble, Power Supply/Battery trouble, and/or a Failure to Communicate (FTC) trouble is detected.

Note: PGM2 must be connected to the control panel as shown in "LE4000/LE4000E wiring diagrams" on page 24. Program the control panel input Zone/Point as 24hr 'Supervisory' with keypad-only notification when activated. Output 2 on the LE4000/LE4000E must be set as 'Active High'.

Note: Once an output has been activated automatically, it will not restore its state until all the causes of activation are cleared.

6.6 Reporting codes

Table 5-1 LE4000/LE4000E reporting codes

Reporting codes	CID	SIA	Programmable	Comments
Zone 1 Activation	E130 991	FA 991	YES	Delayed 24 Hour Fire *
Zone 1 Restoral	R130 991	FH 991	YES	Delayed 24 Hour Fire Restore *
Zone 2 Activation	E300 992	PA 992	YES	Panic Alarm *
Zone 2 Restoral	R300 992	PH 992	YES	Panic Alarm Restore*
PSTN Line Down	E351 000	LT 000	FIXED	Telco 1 Fault
PSTN Line Restoral	R351 000	LR 000	FIXED	Telco 1 Fault Restore
Input Loss	E337 000	YP 000	FIXED	Power Supply Trouble

Reporting codes	CID	SIA	Programmable	Comments
Input Restoral	R337 000	YQ 000	FIXED	Power Supply Trouble Restore
Low Battery Alert	E338 000	YT 000	FIXED	Transmitter Battery Trouble
Low Battery Restoral	R338 000	YR 000	FIXED	Transmitter Battery Restore
Periodic Test	E603 XXX	RP XXX	FIXED	Test Transmission <Receiver Path>
Periodic Test with Trouble	E608 XXX	RY XXX	FIXED	Test Transmission <Receiver Path>
Radio Activation	R552 000	RS 000	FIXED	Remote Programming Successful
Internal Buffer Full	E624 000	JL 000	FIXED	
FTC Restoral	R354 000	YK 000	FIXED	Communications Restored
Firmware Update Successful	R901 000	LS 000	FIXED	
Firmware Update Fail	E902 000	LU 000	FIXED	
Firmware Update Begin	E901 000	LB 000	FIXED	
System Tamper	E145 000	ES 000	FIXED	Expansion Module Tamper
System Tamper Restore	R145 000	EJ 000	FIXED	Expansion Module Tamper Restore

* C24 Communications default value

6.7 Swinger shutdown

To prevent "runaway" signals to the central station, the LE4000/LE4000E is equipped with Swinger Shutdown which limits certain trouble events to a maximum of four reports every 24 hours. At midnight, the condition restores and the counter is reset. Swinger Shutdown applies to the following trouble conditions:

- System Tamper/Restore
- Low Battery Trouble/Restore
- TLM Trouble/Restore
- Input Power Trouble/Restore
- FTC Restore
- Zone 1 and 2 input alarm / restore

6.8 Hardware default

A hardware default is required in order to update the unit with the latest configuration from C24 Communications. To perform the hardware default, follow these steps:

- The device was originally programmed incorrectly.
- The unit was installed at a different location and then relocated to a new site.
- A SIM card is being swapped.

To perform the hardware default, follow these steps:

1. Power down the unit and remove all connections to Zone1, Zone 2, PGM1 and PGM2. **Note:** When removing the battery, depress the locking tab before attempting to detach the battery connector from the PCB. Failure to do so may result in damage to the connector and/or battery.
2. Connect a wire between Z1 (terminal 5) and PGM1 (terminal 6).
3. Wait for 20 seconds and then completely power down the unit.
4. Disconnect the wire between the Zone and PGM terminals.

Note: If the unit has previously received programming from C24 Communications, a hardware default is required to initiate the download of the latest configuration. Failure to do so results in the unit transmitting with the previously programmed configuration. A hardware default must be performed when the SIM card is swapped.

6.9 Communicator reset/update





The device firmware can be updated over Cellular or PC-Link:

Table 5-2 Firmware update begins

 RED	 BLUE	 Blue/Green (Top)	 Blue/Green (Bottom)
ON	ON	ON	ON

- When the firmware update begins, all LEDs are ON.

Table 5-3 Firmware update process

 RED	 BLUE	 Blue/Green (Top)	 Blue/Green (Bottom)
FLASH ON	OFF	OFF	OFF
OFF	FLASH ON	OFF	OFF
OFF	OFF	FLASH ON	OFF
OFF	OFF	OFF	FLASH ON
FLASH ON	OFF	OFF	OFF
OFF	FLASH ON	OFF	OFF
OFF	OFF	FLASH ON	OFF
OFF	OFF	OFF	FLASH ON

- During the firmware update process, the LEDs cycle individually in a chaser pattern (different from the Advanced Carrier Selection pattern).
- The unit automatically restarts after a successful update.

Note: Several resets take place during a single Firmware update session.

Note: The unit re-requests programming after a firmware update; the version number is updated and viewable via C24 Communications.

Note: Unit must not be powered down while a firmware update is in progress.

Note: LE4000/LE4000E will not process remote firmware update requests while the following troubles are present.

- Input Power Trouble
- Low Battery Trouble

6.10 Low power radio shutdown

When the battery voltage reaches the low battery threshold of 6V, the LE4000/LE4000E turns off the radio to prevent unnecessary network registrations. In this state, no events are communicated.

Radio shutdown is indicated by the LEDs as follows:

- Red LED indicates low battery trouble.
- Two RRSI LEDs blinking on/off together indicates the radio is not ready.

6.11 SMS command and control

To enable SMS control of the security panel, do the following.

Note: UL/ULC has not investigated this functionality and it shall not be used for UL/ULC certified installations.

6.11.1 Arming/disarming the security panel

1. Set a PGM output to Remote Arming in C24 Communications.
2. Ensure this PGM output is connected to a relay to their security panel zone.
3. Set up the zone on the security panel as Momentary or Maintained arming.
 - For Momentary key switching, configure the Communicator PGM with a time field of 05. In this configuration, both arm and disarm generate the pulse.
 - For Maintained key arming, configure the Communicator PGM with a time field of 00.
4. Optionally, the communicator can detect panel arm state by configuring a panel PGM output to detect arm state, then connecting that output through a relay to a communicator zone also configured to follow panel arm state.

6.11.2 Remote control of the PGM

1. Set one or both PGM outputs to Remote Control PGM configuration. A PGM can be latched or timed:
 - Setting the PGM timer to 00 causes the PGM to be latched. The PGM will not turn off unless the turn off command is received.
 - Setting the PGM timer to a value between 1 and 255 seconds causes the PGM to be timed. The PGM activates for the programmed duration.
2. Via C24 Communications, program the phone number and access code used for SMS command and control.
 - Up to 6 different phone numbers can be programmed to perform SMS command and control.
 - The password can be 4 to 8 alphanumeric characters and is not case sensitive.

The SMS command and control can be sent in the following format:

For arming/disarming the security panel

Arm <access code>, example Arm 12345678

For activating/deactivating a specific PGM

Activate <PGM #> <access code>, Activate 1 12345678

The following SMS command and control operations are available.

Table 5-4 Arming

Language	Command label (not case sensitive)
English	Arm
French	Armement
Spanish	Armado

Table 5-5 Disarming

Language	Command label (not case sensitive)
English	Disarm
French	Desarmement
Spanish	Desarmado

Table 5-6 Activate PGM

Language	Command label (not case sensitive)
English	Activate
French	Activation
Spanish	Activar

Table 5-7 Deactivate PGM

Language	Command label (not case sensitive)
English	Deactivate
French	Desactivation
Spanish	Desactivar

Table 5-8 Status Request

Language	Command label (not case sensitive)
English	Status Request
French	Etat D�emand�e
Spanish	Peticion de Estado

Invalid command is sent when no zones are programmed to read security arm status.

Table 5-9 Help

Language	Command label (not case sensitive)
English	Help
French	Aide
Spanish	Ayuda

Help displays all available commands for the selected language.

6.12 Phone number call direction

The user has the ability to program the PTM phone numbers to receiver group 1 or 2. The number programmed in the communicator must also be programmed as the panel phone number. When the communicator detects the phone number, it communicates to the receivers of the corresponding group.

Note: If no PTM phone number is programmed, all panel calls go to Receiver Group 1.

Section 7: Troubleshooting guide

Powering up the LE4000/LE4000E – when powering up the LE4000/LE4000E, always connect the battery (if used) first before connecting primary DC power from the control panel or transformer.

Wiring primary – R-1/T-1 of LE4000/LE4000E to RING/TIP of control panel, DC power from control panel or DC transformer to DC input, backup battery.

Wiring backup – Incoming line to RING/TIP on LE4000/LE4000E, R-1/T-1 of LE4000/LE4000E to RING/TIP of control panel, R-1/T-1 of control panel to house phones, DC power from control panel or DC transformer to DC input, backup battery.

Testing communications – when the LE4000/LE4000E transmits a signal for the control panel, or for an internal transmission, the BLUE light will flash one time when the signal is transmitted and two times when it gets a kiss-off.

SIM – the SIM should be activated at least 24 hours prior to installation. The LE4000/LE4000E will show signal strength with an inactive SIM, however it will display the signal strength of any available wireless network. The SIM must be active to ensure the signal strength displayed is that of the wireless network provider for which the SIM belongs to.

Panel programming – the control panel should be programmed to communicate Contact ID or SIA exactly the same way it would be programmed to communicate Contact ID or SIA over the telephone line.

Table 6-1 Blue/Green LED status

Blue/Green LED status	What it means:	CSQ values	Signal strength status
Both Signal Strength LEDs ON	Excellent signal strength	14+	Unit can be installed in the current mounting location.
Top LED FLASHING with bottom LED ON	Excellent signal strength	11-13	Unit can be installed in the current mounting location.
Bottom LED ON	Excellent signal strength	7-10	Unit can be installed in the current mounting location.
Bottom LED FLASHING	Poor signal strength	5-6 (no trouble) 1-4 (with trouble)	<ul style="list-style-type: none"> Ensure the antenna cable is plugged securely into the radio connector. If the SIM is active, connect a battery to the unit and test various locations for good/excellent signal strength. Connect an antenna extension kit (LTE-8ANT, LTE-15ANT, LTE-25ANT, LTE-50ANT).
Both LEDs OFF	No signal strength	0	<ul style="list-style-type: none"> If the red LED is also flashing, refer to the RED LED chart. Verify SIM card is activated. Ensure the antenna cable is plugged securely into the radio connector. If the SIM is active, connect a battery to the unit and test various locations for good/excellent signal strength. Connect an antenna extension kit (LTE-8ANT, LTE-15ANT, LTE-25ANT, LTE-50ANT).
Both LEDs FLASHING ON/OFF together	Signal strength is invalid	N/A	Radio is in process of network registration.
Both LEDs ALTERNATING	Radio reset sequence	N/A	Radio is performing a Reset. If the issue persists, please verify the SIM card is inserted correctly.

Table 6-2 Blue LED status

Blue LED status (normal mode)	What it means: wireless communicator status/communication indicator
Blue LED ON	When used as a backup communicator, the blue LED is ON when a phone line is not connected to the LE4000/LE4000E TIP and RING, or the line voltage goes below 2.8Vdc.
Blue LED OFF	A good phone line (more than 2.8 VDC detected across the LE4000/LE4000E TIP and RING terminals) is connected to the LE4000/LE4000E.
Blue LED FLASHING	The blue LED will flash one time when the LE4000/LE4000E transmits a signal and two times when a kiss-off is received.

Note: The Blue LED is always OFF when the LE4000/LE4000E is used as the primary communicator.

Table 6-3 Red/Blue LED troubles

Number of flashes		Trouble type	Trouble notes
Red	Blue		
ON	ON	No Signal Strength	<ul style="list-style-type: none"> Verify SIM card is activated. Ensure the antenna cable is plugged securely into the radio connector. If the SIM is active, connect a battery to the unit and test various locations for good/excellent signal strength. Connect an antenna extension kit (LTE-8ANT, LTE-15ANT, LTE-25ANT, LTE-50ANT).
1	OFF	Wireless Network Trouble	<ul style="list-style-type: none"> Ensure the SIM card has been activated. The antenna cable should be plugged securely into the radio connector. Ensure there is good signal strength (at least one green light ON). Verify the installation area is not experiencing a network outage.
2	OFF	Battery Trouble	<ul style="list-style-type: none"> If a battery is not used in the installation, ensure that the "Internal Battery Connected" is not selected in C24 Communications. If a battery is used in the installation, verify the battery is connected properly Measure the battery under load and verify it is charged to at least 7.2VDC. If not, wait at least 1 hour for the battery to charge. Remove the battery and measure the voltage; the voltage should be at least 7.2VDC. Verify the input DC supply is rated at 13.8VDC @ 180mA minimum. Replace battery
3	OFF	Input Power Trouble	<ul style="list-style-type: none"> Ensure the power source connected to the LE4000/LE4000E is providing 13.8VDC @ 180mA.
1	FLASH	Insufficient Signal Strength	<ul style="list-style-type: none"> Ensure the antenna cable is plugged securely into the radio connector. If the SIM is active, connect a battery to the unit and test various locations for good/excellent signal strength. Connect an antenna extension kit (LTE-8ANT, LTE-15ANT, LTE-25ANT, LTE-50ANT)
2	FLASH	Not Used	
3	FLASH	C24 Communications Configurations Trouble	<ul style="list-style-type: none"> Ensure the SIM card is activated and correctly initialized through C24 Communications.
1	ON	Radio/SIM Trouble	<ul style="list-style-type: none"> Ensure the SIM Card is inserted correctly and firmly. Ensure the antenna cable is plugged securely into the radio connector.

Number of flashes		Trouble type	Trouble notes
Red	Blue		
2	ON	Receiver Not Available Trouble	<ul style="list-style-type: none"> Contact the monitoring station to verify that the LE4000/LE4000E programming is correct (port, IP address, DNIS). Contact your central station to verify they are not experiencing any receiver issues.
3	ON	Supervision Trouble	<ul style="list-style-type: none"> Contact your central station to verify they are not experiencing any receiver issues.
4	ON	Tamper Trouble	<ul style="list-style-type: none"> Ensure the front cover is secured and the case tamper is closed.

The Red light flashes to indicate various trouble conditions outlined previously. If multiple trouble conditions are present, the red LED flashes according to the highest priority trouble. For example, if both a LE4000/LE4000E wireless network trouble (one flash) and a low battery trouble (two flashes) are present; the red LED flashes one time. Once the LE4000/LE4000E wireless network trouble condition is corrected, the red LED begins flashing two times to indicate the low battery trouble.

Table 6-4 General troubles

General troubles with your system	
The control panel is displaying a telephone line trouble condition	<ul style="list-style-type: none"> Ensure T1 and R1 of the LE4000/LE4000E are wired to the TIP and RING terminals of the control panel. If the LE4000/LE4000E is being used as the primary communicator, the blue light will always be OFF. If the LE4000/LE4000E red light is FLASHING, refer to the troubleshooting chart in this guide.
The control panel displays a communication trouble condition	<ul style="list-style-type: none"> Ensure the panel is programmed for Contact ID or SIA. Ensure the control panel does not indicate a TLM trouble condition. If the LE4000/LE4000E red light is FLASHING, refer to the troubleshooting chart in this guide.
No signals are received at the central station but no trouble condition is displayed	<ul style="list-style-type: none"> Ensure the control panel has a central station phone number programmed. Ensure the control panel has the correct account number programmed. Verify the reporting codes are programmed or the auto Contact ID/SIA option is enabled. Ensure the control panel communicator is enabled. Connect a handset to T1 and R1 of the LE4000/LE4000E in monitor mode to verify the control panel is trying to communicate.
Not receiving internal signals generated directly from the LE4000/LE4000E	<ul style="list-style-type: none"> Ensure the LE4000/LE4000E was initialized with the correct account number. This can be checked by logging into the C24 Communications website. Ensure no trouble conditions are present.
The phone line is seized when the LE4000/LE4000E is connected	<ul style="list-style-type: none"> Verify correct phone line wiring. Ensure the Ringer Equivalency Number (REN) is not being exceeded on the line.

Table 6-5 General information

General information	
Removing/Connecting the antenna	<ul style="list-style-type: none"> To remove the antenna from the LE4000/LE4000E, turn the antenna counter-clockwise to unscrew the antenna from the connector. To install the antenna, turn the antenna clockwise to attach it to the antenna connector.

General information	
Enrolling a LE4000/LE4000E	<ul style="list-style-type: none"> The LE4000/LE4000E can also be enrolled using the C24 Communications website (www.connect24.com) or the C24 Communications mobile site (m.connect24.com).
SIM card activation period	<ul style="list-style-type: none"> SIM card activation can take up to 24 hours. However, activation typically takes less than an hour.
Checking SIM status	<ul style="list-style-type: none"> Go to www.connect24.com and login. A search can be performed for a specific account and its current status. SIM status can also be checked through the GVRU.
Critical Shutdown on LE4000/LE4000E backup battery (with no DC input applied)	<ul style="list-style-type: none"> If the LE4000/LE4000E backup battery is used and is below 6VDC, the unit will go into critical shutdown. The critical shutdown state is indicated by the red LED flashing, followed by the blue and two green lights flashing. The LEDs continue to flash in this sequence until the battery is charged above 6.5VDC.
Swinger Shutdown for LE4000/LE4000E Troubles	<ul style="list-style-type: none"> Trouble events can send a maximum of 4 troubles and restorals per day. Swinger Shutdown only affects signal transmissions, not the functionality of the LE4000/LE4000E LEDs or PGM outputs. Swinger shutdown is reset at midnight or upon a full power cycle of the LE4000/LE4000E.

Note: Test this product at least once a year.

Section 8: LE4000/LE4000E wiring diagrams

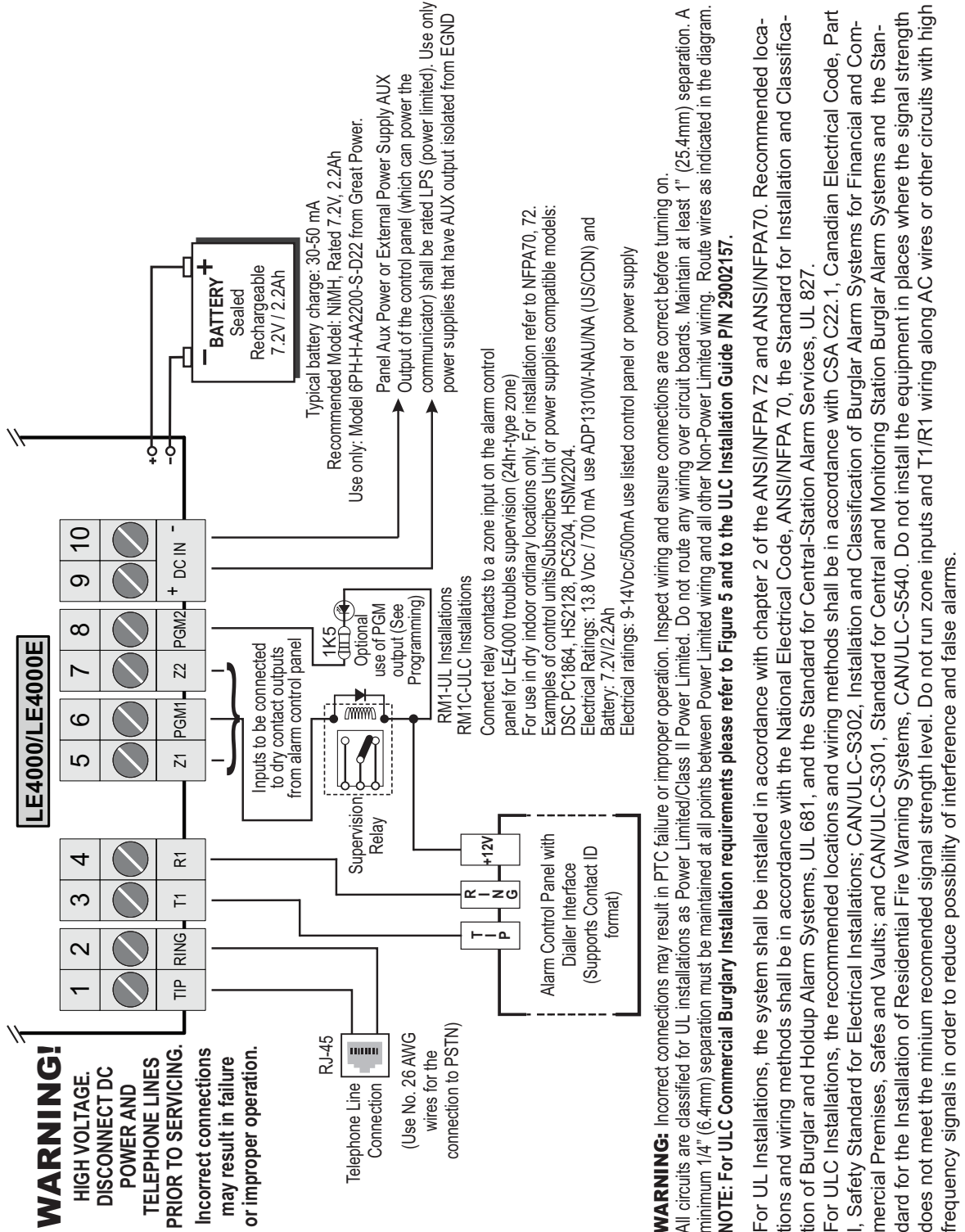

Figure 8-1 LE4000/LE4000E wiring diagram

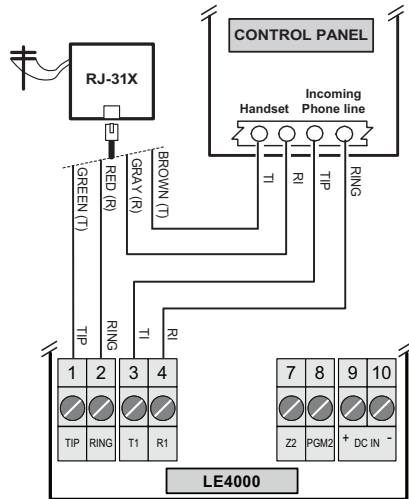
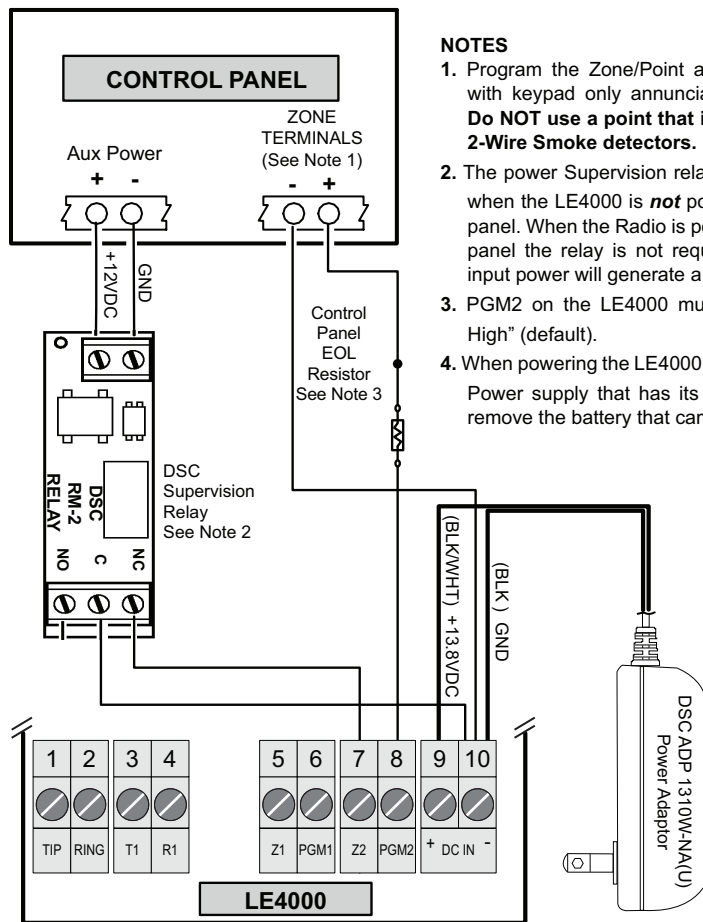

Figure 8-2 Telephone connection



NOTES

1. Program the Zone/Point as "Supervisory" type with keypad only annunciation when in Alarm. **Do NOT use a point that is normally used for 2-Wire Smoke detectors.**
2. The power Supervision relay, **RM-2** is only used when the LE4000 is **not** powered by the control panel. When the Radio is powered by the control panel the relay is not required since a loss of input power will generate a signal to the CMC.
3. PGM2 on the LE4000 must be set as "Active High" (default).
4. When powering the LE4000 Radio by an Auxiliary Power supply that has its own backup battery, remove the battery that came with the radio.

Figure 8-3 Power supply and supervision

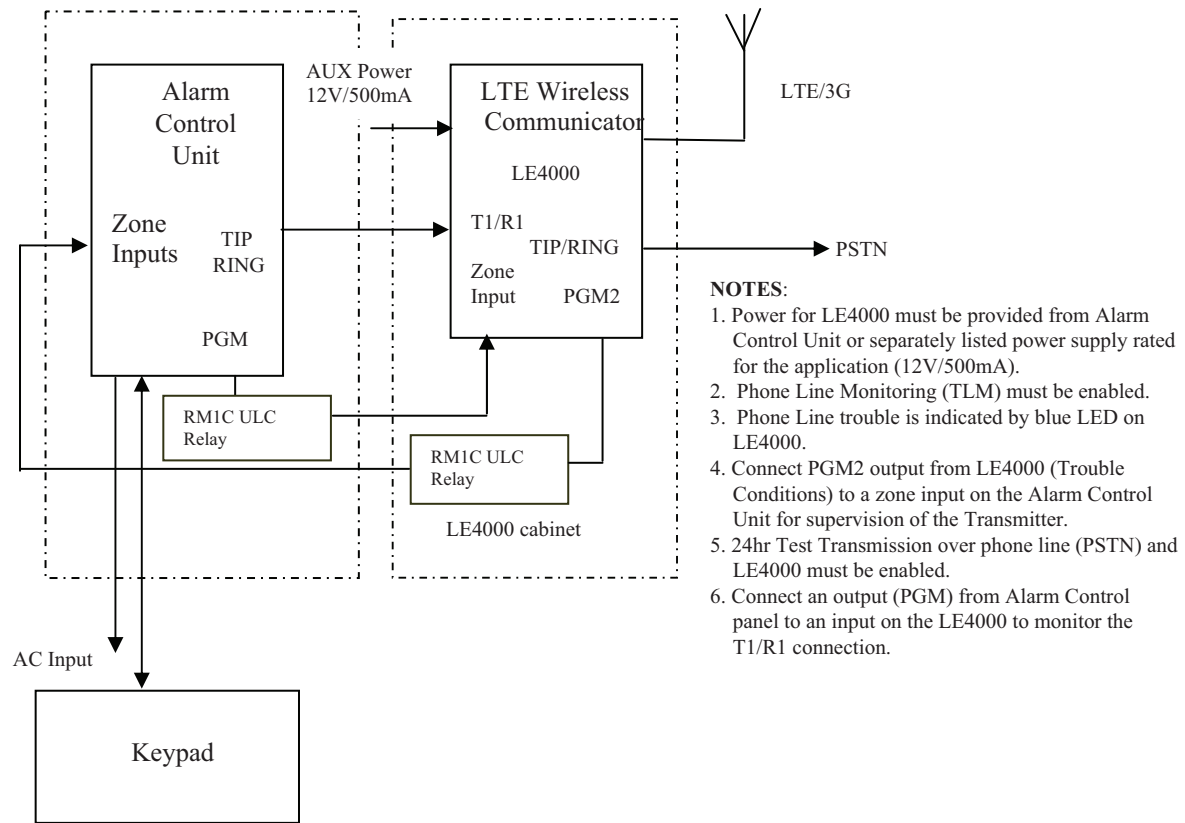

Figure 8-4 Alarm control unit and LTE/3G transmitter

Regulatory Information

MODIFICATION STATEMENT

Digital Security Controls has not approved any changes or modifications to this device by the user. Any changes or modifications could void the user's authority to operate the equipment.

Digital Security Controls n'approuve aucune modification apportée à l'appareil par l'utilisateur, quelle qu'en soit la nature. Tout changement ou modification peuvent annuler le droit d'utilisation de l'appareil par l'utilisateur.

INTERFERENCE STATEMENT

This device complies with Part 15 of the FCC Rules and ISED Canada licence-exempt RSS standard(s). Operation is subject to the following two conditions: (1) this device may not cause interference, and (2) this device must accept any interference, including interference that may cause undesired operation of the device.

Le présent appareil est conforme aux CNR d'ISED Canada applicables aux appareils radio exempts de licence. L'exploitation est autorisée aux deux conditions suivantes : (1) l'appareil ne doit pas produire de brouillage, et (2) l'utilisateur de l'appareil doit accepter tout brouillage radioélectrique subi, même si le brouillage est susceptible d'en compromettre le fonctionnement.

WIRELESS NOTICE

This equipment complies with FCC and ISED Canada radiation exposure limits set forth for an uncontrolled environment. The antenna should be installed and operated with minimum distance of 20 cm between the radiator and your body. This transmitter must not be co-located or operating in conjunction with any other antenna or transmitter.

Cet appareil est conforme aux limites d'exposition aux rayonnements de la ISED Canada pour un environnement non contrôlé. L'antenne doit être installée de façon à garder une distance minimale de 20 centimètres entre la source de rayonnements et votre corps. L'émetteur ne doit pas être colocalisé ni fonctionner conjointement avec à autre antenne ou autre émetteur.

Antenna gain must be below/Gain de l'antenne doit être ci-dessous:

Frequency Band/Bande de fréquence	LE4000(E)
GSM850 / FDD V	2.50 dBi
PCS1900 / FCC II	5.20 dBi
LTE B2	5.20 dBi
LTE B4/B66	6.20 dBi
LTE B5	2.50 dBi
LTE B12	1.00 dBi
LTE B13	2.20 dBi

FCC CLASS B DIGITAL DEVICE NOTICE

This equipment has been tested and found to comply with the limits for a Class B digital device, pursuant to part 15 of the FCC Rules. These limits are designed to provide reasonable protection against harmful interference in a residential installation. This equipment generates uses and can radiate radio frequency energy and, if not installed and used in accordance with the instructions, may cause harmful interference to radio communications. However, there is no guarantee that interference will not occur in a particular installation. If this equipment does cause harmful interference to radio or television reception, which can be determined by turning the equipment off and on, the user is encouraged to try to correct the interference by one or more of the following measures:

- Reorient or relocate the receiving antenna.
- Increase the separation between the equipment and receiver.
- Connect the equipment into an outlet on a circuit different from that to which the receiver is connected.
- Consult the dealer or an experienced radio/TV technician for help.

Model LE4000	FCC ID:F5317LE4000	Product Identifier US: F5317MO00ALE4000
Model LE4000E	FCC ID: F5321LE4000E	Product Identifier US: F5317MO00ALE4000
REN: 0.0A		
USOC Jack: RJ-31X		

WARNING: To satisfy FCC RF exposure requirements for mobile transmitting devices, a separation distance of 20cm or more must be maintained between the antenna of this device and persons during device operation.

Telephone Connection Requirements

A plug and jack used to connect this equipment to the premises wiring and telephone network must comply with the applicable FCC Part 68 rules and requirements adopted by the ACTA. A compliant telephone cord and modular plug is provided with this product. It is designed to be connected to a compatible modular jack that is also compliant. See installation instructions for details.

Ringer Equivalence Number (REN)

The REN is used to determine the number of devices that may be connected to a telephone line. Excessive RENs on a telephone line may result in the devices not ringing in response to an incoming call. In most but not all areas, the sum of RENs should not exceed five (5.0). To be certain of the number of devices that may be connected to a line, as determined by the total RENs, contact the local Telephone Company. For products approved after July 23, 2001, the REN for this product is part of the product identifier that has the format: US: AAAEQ##TXXXX. The digits represented by ## are the REN without a decimal point (e.g., 03 is a REN of 0.3). For earlier products, the REN is separately shown on the label.

Incidence of Harm

If this equipment LE4000/LE4000E causes harm to the telephone network, the telephone company will notify you in advance that temporary discontinuance of service may be required. But if advance notice is not practical, the Telephone Company will notify the customer as soon as possible. Also, you will be advised of your right to file a complaint with the FCC if you believe it is necessary.

Changes in Telephone Company Equipment or Facilities

The Telephone Company may make changes in its facilities, equipment, operations or procedures that could affect the operation of the equipment. If this happens the Telephone Company will provide advance notice in order for you to make necessary modifications to maintain uninterrupted service.

Equipment Maintenance Facility

If trouble is experienced with this equipment for repair or warranty information, please contact the facility indicated below. If the equipment is causing harm to the telephone network, the Telephone Company may request that you disconnect the equipment until the problem is solved. This equipment is of a type that is not intended to be repaired by the end user.

DSC c/o APL Logistics, 757 Douglas Hill Rd., Lithia Springs, GA 30122

Additional Information

Connection to party line service is subject to state tariffs. Contact the state public utility commission, public service commission or corporation commission for information. Alarm dialling equipment must be able to seize the telephone line and place a call in an emergency situation. It must be able to do this even if other equipment (telephone, answering system, computer modem, etc.) already has the telephone line in use. To do so, alarm dialling equipment must be connected to a properly installed RJ-31X jack that is electrically in series with and ahead of all other equipment attached to the same telephone line. Proper installation is depicted in the figure below. If you have any questions concerning these instructions, you should consult your telephone company or a qualified installer about installing the RJ-31X jack and alarm dialling equipment for you.

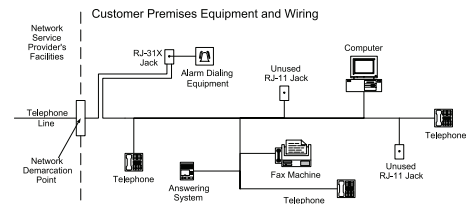

Industrial, Scientific and Economic Development (ISED)

This Equipment meets the applicable Industrial, Scientific and Economic Development (ISED) Canada Terminal Equipment Technical Specifications. This is confirmed by the registration number. The abbreviation, IC, before the registration number signifies that registration was performed based on a Declaration of Conformity indicating that ISED Canada technical specifications were met. It does not imply that that ISED Canada approved the equipment. The Ringer Equivalence Number (REN) for this terminal equipment is 0.0. The REN assigned to each terminal equipment provides an indication of the maximum number of terminals allowed to be connected to a telephone interface. The termination on an interface may consist of any combination of devices subject only to the requirement that the sum of the Ringer Equivalence Numbers of all devices does not exceed 5.

Model LE4000	IC:160A-LE4000
Model LE4000E	IC:160A-LE4000E

Cet équipement est conforme aux spécifications techniques applicables aux équipements terminaux d'ISED Canada. Ceci est confirmé par le numéro d'enregistrement. L'abréviation IC précédant le numéro d'enregistrement signifie que l'enregistrement a été effectué sur la base de la Déclaration de conformité indiquant que le produit est conforme aux spécifications techniques d'ISED Canada. Ceci n'implique pas que le produit ait été approuvé par ISED Canada.

Le nombre équivalent de sonneries (REN) de cet appareil terminal est 0.0. Le REN attribué à chaque équipement terminal fournit une indication sur le nombre maximum de terminaux pouvant être connectés sur une interface téléphonique. La terminaison sur une interface peut constituer en n'importe quelle combinaison d'appareils, à la condition seulement que la somme des Nombres équivalents de sonneries de tous les appareils ne soit pas supérieure à 5.

CAN ICES-3 (B) / NMB-3 (B)

The term "IC:" before the radio certification number only signifies that ISED Canada technical specifications were met.

NIST Validation of encryption algorithm AES128 (certificate No. 5011 available at NIST website).

EULA

IMPORTANT - READ CAREFULLY: DSC Software purchased with or without Products and Components is copyrighted and is purchased under the following license terms:

This End-User License Agreement (“EULA”) is a legal agreement between You (the company, individual or entity who acquired the Software and any related Hardware) and Digital Security Controls, a division of Tyco Safety Products Canada Ltd. (“DSC”), the manufacturer of the integrated security systems and the developer of the software and any related products or components (“HARDWARE”) which You acquired.

If the DSC software product (“SOFTWARE PRODUCT” or “SOFTWARE”) is intended to be accompanied by HARDWARE, and is NOT accompanied by new HARDWARE, You may not use, copy or install the SOFTWARE PRODUCT. The SOFTWARE PRODUCT includes computer software, and may include associated media, printed materials, and “online” or electronic documentation.

Any software provided along with the SOFTWARE PRODUCT that is associated with a separate end-user license agreement is licensed to You under the terms of that license agreement.

By installing, copying, downloading, storing, accessing or otherwise using the SOFTWARE PRODUCT, You agree unconditionally to be bound by the terms of this EULA, even if this EULA is deemed to be a modification of any previous arrangement or contract. If You do not agree to the terms of this EULA, DSC is unwilling to license the SOFTWARE PRODUCT to You, and You have no right to use it.

SOFTWARE PRODUCT LICENSE

The SOFTWARE PRODUCT is protected by copyright laws and international copyright treaties, as well as other intellectual property laws and treaties. The SOFTWARE PRODUCT is licensed, not sold.

1. GRANT OF LICENSE This EULA grants You the following rights:

Software Installation and Use - For each license You acquire, You may have only one copy of the SOFTWARE PRODUCT installed.

Storage/Network Use - The SOFTWARE PRODUCT may not be installed, accessed, displayed, run, shared or used concurrently on or from different computers, including a workstation, terminal or other digital electronic device (“Device”). In other words, if You have several workstations, You will have to acquire a license for each workstation where the SOFTWARE will be used.

Backup Copy - You may make back-up copies of the SOFTWARE PRODUCT, but You may only have one copy per license installed at any given time. You may use the back-up copy solely for archival purposes. Except as expressly provided in this EULA, You may not otherwise make copies of the SOFTWARE PRODUCT, including the printed materials accompanying the SOFTWARE.

2. DESCRIPTION OF OTHER RIGHTS AND LIMITATIONS

Limitations on Reverse Engineering, Decompilation and Disassembly - You may not reverse engineer, decompile, or disassemble the SOFTWARE PRODUCT, except and only to the extent that such activity is expressly permitted by applicable law notwithstanding this limitation. You may not make any changes or modifications to the Software, without the written permission of an officer of DSC. You may not remove any proprietary notices, marks or labels from the Software Product. You shall institute reasonable measures to ensure compliance with the terms and conditions of this EULA.

Separation of Components - The SOFTWARE PRODUCT is licensed as a single product. Its component parts may not be separated for use on more than one HARDWARE unit.

Single INTEGRATED PRODUCT - If You acquired this SOFTWARE with HARDWARE, then the SOFTWARE PRODUCT is licensed with the HARDWARE as a single integrated product. In this case, the SOFTWARE PRODUCT may only be used with the HARDWARE as set forth in this EULA.

Rental - You may not rent, lease or lend the SOFTWARE PRODUCT. You may not make it available to others or post it on a server or web site.

Software Product Transfer - You may transfer all of Your rights under this EULA only as part of a permanent sale or transfer of the HARDWARE, provided You retain no copies, You transfer all of the SOFTWARE PRODUCT (including all component parts, the media and printed materials, any upgrades and this EULA), and provided the recipient agrees to the terms of this EULA. If the SOFTWARE PRODUCT is an upgrade, any transfer must also include all prior versions of the SOFTWARE PRODUCT.

Termination - Without prejudice to any other rights, DSC may terminate this EULA if You fail to comply with the terms and conditions of this EULA. In such event, You must destroy all copies of the SOFTWARE PRODUCT and all of its component parts.

Trademarks - This EULA does not grant You any rights in connection with any trademarks or service marks of DSC or its suppliers.

3. COPYRIGHT

All title and intellectual property rights in and to the SOFTWARE PRODUCT (including but not limited to any images, photographs, and text incorporated into the SOFTWARE PRODUCT), the accompanying printed materials, and any copies of the SOFTWARE PRODUCT, are owned by DSC or its suppliers. You may not copy the printed materials accompanying the SOFTWARE PRODUCT. All title and intellectual property rights in and to the content which may be accessed through use of the SOFTWARE PRODUCT are the property of the respective content owner and may be protected by applicable copyright or other intellectual property laws and treaties. This EULA grants You no rights to use such content. All rights not expressly granted under this EULA are reserved by DSC and its suppliers.

EXPORT RESTRICTIONS - You agree that You will not export or re-export the SOFTWARE PRODUCT to any country, person, or entity subject to Canadian export restrictions.

CHOICE OF LAW - This Software License Agreement is governed by the laws of the Province of Ontario, Canada.

ARBITRATION - All disputes arising in connection with this Agreement shall be determined by final and binding arbitration in accordance with the Arbitration Act, and the parties agree to be bound by the arbitrator’s decision. The place of arbitration shall be Toronto, Canada, and the language of the arbitration shall be English.

LIMITED WARRANTY

NO WARRANTY - DSC PROVIDES THE SOFTWARE “AS IS” WITHOUT WARRANTY. DSC DOES NOT WARRANT THAT THE SOFTWARE WILL MEET YOUR REQUIREMENTS OR THAT OPERATION OF THE SOFTWARE WILL BE UNINTERRUPTED OR ERROR-FREE.

CHANGES IN OPERATING ENVIRONMENT - DSC shall not be responsible for problems caused by changes in the operating characteristics of the HARDWARE, or for problems in the interaction of the SOFTWARE PRODUCT with non-DSC-SOFTWARE or HARDWARE PRODUCTS.

LIMITATION OF LIABILITY; WARRANTY REFLECTS ALLOCATION OF RISK - IN ANY EVENT, IF ANY STATUTE IMPLIES WARRANTIES OR CONDITIONS NOT STATED IN THIS LICENSE AGREEMENT, DSC’S ENTIRE LIABILITY UNDER ANY PROVISION OF THIS LICENSE AGREEMENT SHALL BE LIMITED TO THE GREATER OF THE AMOUNT ACTUALLY PAID BY YOU TO LICENSE THE SOFTWARE PRODUCT AND FIVE CANADIAN DOLLARS (CAD\$5.00). BECAUSE SOME JURISDICTIONS DO NOT ALLOW THE EXCLUSION OR LIMITATION OF LIABILITY FOR CONSEQUENTIAL OR INCIDENTAL DAMAGES, THE ABOVE LIMITATION MAY NOT APPLY TO YOU.

DISCLAIMER OF WARRANTIES - THIS WARRANTY CONTAINS THE ENTIRE WARRANTY AND SHALL BE IN LIEU OF ANY AND ALL OTHER WARRANTIES, WHETHER EXPRESSED OR IMPLIED (INCLUDING ALL IMPLIED WARRANTIES OF MERCHANTABILITY OR FITNESS FOR A PARTICULAR PURPOSE) AND OF ALL OTHER OBLIGATIONS OR LIABILITIES ON THE PART OF DSC. DSC MAKES NO OTHER WARRANTIES. DSC NEITHER ASSUMES NOR AUTHORIZES ANY OTHER PERSON PURPORTING TO ACT ON ITS BEHALF TO MODIFY OR TO CHANGE THIS WARRANTY, NOR TO ASSUME FOR IT ANY OTHER WARRANTY OR LIABILITY CONCERNING THIS SOFTWARE PRODUCT.

EXCLUSIVE REMEDY AND LIMITATION OF WARRANTY - UNDER NO CIRCUMSTANCES SHALL DSC BE LIABLE FOR ANY SPECIAL, INCIDENTAL, CONSEQUENTIAL OR INDIRECT DAMAGES BASED UPON BREACH OF WARRANTY, BREACH OF CONTRACT, NEGLIGENCE, STRICT LIABILITY, OR ANY OTHER LEGAL THEORY. SUCH DAMAGES INCLUDE, BUT ARE NOT LIMITED TO, LOSS OF PROFITS, LOSS OF THE SOFTWARE PRODUCT OR ANY ASSOCIATED EQUIPMENT, COST OF CAPITAL, COST OF SUBSTITUTE OR REPLACEMENT EQUIPMENT, FACILITIES OR SERVICES, DOWN TIME, PURCHASERS TIME, THE CLAIMS OF THIRD PARTIES, INCLUDING CUSTOMERS, AND INJURY TO PROPERTY.

DSC recommends that the entire system be completely tested on a regular basis. However, despite frequent testing, and due to, but not limited to, criminal tampering or electrical disruption, it is possible for this SOFTWARE PRODUCT to fail to perform as expected.

Warranty

Digital Security Controls warrants the original purchaser that for a period of twelve months from the date of purchase, the product shall be free of defects in materials and workmanship under normal use. During the warranty period, Digital Security Controls shall, at its option, repair or replace any defective product upon return of the product to its factory, at no charge for labour and materials. Any replacement and/or repaired parts are warranted for the remainder of the original warranty or ninety (90) days, whichever is longer. The original purchaser must promptly notify Digital Security Controls in writing that there is defect in material or workmanship, such written notice to be received in all events prior to expiration of the warranty period. There is absolutely no warranty on software and all software products are sold as a user license under the terms of the software license agreement included with the product. The Customer assumes all responsibility for the proper selection, installation, operation and maintenance of any products purchased from DSC. Custom products are only warranted to the extent that they do not function upon delivery. In such cases, DSC can replace or credit at its option.

International Warranty

The warranty for international customers is the same as for any customer within Canada and the United States, with the exception that Digital Security Controls shall not be responsible for any customs fees, taxes, or VAT that may be due.

Warranty Procedure

To obtain service under this warranty, please return the item(s) in question to the point of purchase. All authorized distributors and dealers have a warranty program. Anyone returning goods to Digital Security Controls must first obtain an authorization number. Digital Security Controls will not accept any shipment whatsoever for which prior authorization has not been obtained.

Conditions to Void Warranty

This warranty applies only to defects in parts and workmanship relating to normal use. It does not cover:

- damage incurred in shipping or handling;
- damage caused by disaster such as fire, flood, wind, earthquake or lightning;
- damage due to causes beyond the control of Digital Security Controls such as excessive voltage, mechanical shock or water damage;
- damage caused by unauthorized attachment, alterations, modifications or foreign objects;
- damage caused by peripherals (unless such peripherals were supplied by Digital Security Controls);
- defects caused by failure to provide a suitable installation environment for the products;
- damage caused by use of the products for purposes other than those for which it was designed;
- damage from improper maintenance;
- damage arising out of any other abuse, mishandling or improper application of the products.

Items Not Covered by Warranty

In addition to the items which void the Warranty, the following items shall not be covered by Warranty: (i) freight cost to the repair centre; (ii) products which are not identified with DSC's product label and lot number or serial number; (iii) products disassembled or repaired in such a manner as to adversely affect performance or prevent adequate inspection or testing to verify any warranty claim. Access cards or tags returned for replacement under warranty will be credited or replaced at DSC's option. Products not covered by this warranty, or otherwise out of warranty due to age, misuse, or damage shall be evaluated, and a repair estimate shall be provided. No repair work will be performed until a valid purchase order is received from the Customer and a Return Merchandise Authorisation number (RMA) is issued by DSC's Customer Service.

Digital Security Controls's liability for failure to repair the product under this warranty after a reasonable number of attempts will be limited to a replacement of the product, as the exclusive remedy for breach of warranty. Under no circumstances shall Digital Security Controls be liable for any special, incidental, or consequential damages based upon breach of warranty, breach of contract, negligence, strict liability, or any other legal theory. Such damages include, but are not limited to, loss of profits, loss of the product or any associated equipment, cost of capital, cost of substitute or replacement equipment, facilities or services, down time, purchaser's time, the claims of third parties, including customers, and injury to property. The laws of some jurisdictions limit or do not allow the disclaimer of consequential damages. If the laws of such a jurisdiction apply to any claim by or against DSC, the limitations and disclaimers contained here shall be to the greatest extent permitted by law. Some states do not allow the exclusion or limitation of incidental or consequential damages, so that the above may not apply to you.

Disclaimer of Warranties

This warranty contains the entire warranty and shall be in lieu of any and all other warranties, whether expressed or implied (including all implied warranties of merchantability or fitness for a particular purpose) And of all other obligations or liabilities on the part of Digital Security Controls Digital Security Controls neither assumes responsibility for, nor authorizes any other person purporting to act on its behalf to modify or to change this warranty, nor to assume for it any other warranty or liability concerning this product.

This disclaimer of warranties and limited warranty are governed by the laws of the province of Ontario, Canada.

Digital Security Controls recommends that the entire system be completely tested on a regular basis. However, despite frequent testing, and due to, but not limited to, criminal tampering or electrical disruption, it is possible for this product to fail to perform as expected.

Installer's Lockout

Any products returned to DSC which have the Installer's Lockout option enabled and exhibit no other problems will be subject to a service charge.

Out of Warranty Repairs

Digital Security Controls will at its option repair or replace out-of-warranty products which are returned to its factory according to the following conditions. Anyone returning goods to Digital Security Controls must first obtain an authorization number. Digital Security Controls will not accept any shipment whatsoever for which prior authorization has not been obtained.

Products which Digital Security Controls determines to be repairable will be repaired and returned. A set fee which Digital Security Controls has predetermined and which may be revised from time to time, will be charged for each unit repaired.

Products which Digital Security Controls determines not to be repairable will be replaced by the nearest equivalent product available at that time. The current market price of the replacement product will be charged for each replacement unit.

© 2021 Johnson Controls. All rights reserved.
Tech Support: 1-800-387-3630 (Canada & U.S.) or 905-760-3000
www.dsc.com

The trademarks, logos, and service marks displayed on this document are registered in the United States [or other countries]. Any misuse of the trademarks is strictly prohibited and Tyco will aggressively enforce its intellectual property rights to the fullest extent of the law, including pursuit of criminal prosecution wherever necessary. All trademarks not owned by Tyco are the property of their respective owners, and are used with permission or allowed under applicable laws. Product offerings and specifications are subject to change without notice. Actual products may vary from photos. Not all products include all features.

Availability varies by region; contact your sales representative.

29010077R003