



Test report no. : 83518/10

Item tested : RTX3088 Handset

Type of equipment : Isochronous UPCS Device

FCC ID : ELIRTX3088-1

Client : RTX America Inc.

FCC Part 15, subpart D
Isochronous UPCS Device
1920 - 1930 MHz

Industry Canada RSS-213, Issue 2
2 GHz Licence-exempt Personal
Communications Service Devices
(LE-PCS)

7 May 2007

Authorized by : 
Egil Hauger
Technical Verificator



CONTENTS

1	GENERAL INFORMATION	3
1.1	Testhouse Info	3
1.2	Client Information.....	3
1.3	Manufacturer (if other than client)	3
2	TEST INFORMATION	4
2.1	Tested Item.....	4
2.2	Test Environment.....	5
2.3	Test Period	5
2.4	Test Engineers.....	5
2.5	Test Equipment.....	5
2.6	Other Comments	5
3	TEST REPORT SUMMARY	6
3.1	General.....	6
3.2	Test Summary	7
4	TEST RESULTS.....	8
4.1	Power Line Conducted Emissions	8
4.2	Coordination with fixed microwave.....	13
4.3	Digital Modulation Techniques.....	13
4.4	Labelling Requirements	13
4.5	Antenna Requirement	14
4.6	Channel Frequencies.....	14
4.7	Automatic Discontinuation of Transmission	15
4.8	Peak Power Output.....	16
4.9	Emission Bandwidth <i>B</i>	19
4.10	Power Spectral Density.....	22
4.11	In-Band Unwanted Emissions, Conducted.....	25
4.12	Out-of-band Emissions, Conducted	27
4.13	Carrier Frequency Stability	31
4.14	Frame Repetition Stability.....	32
4.15	Frame Period and Jitter	32
4.16	Monitoring Threshold, Least Interfered Channel.....	35
4.17	Threshold Monitoring Bandwidth	37
4.18	Reaction Time and Monitoring Interval	38
4.19	Time and Spectrum Window Access Procedure	40
4.20	Acknowledgements and Transmission Duration	41
4.21	Dual Access Criteria Check	43
4.22	Alternative Monitoring Interval	43
4.23	Duty Cycle Correction Factor Calculation	47
4.24	Spurious Emissions (Radiated).....	48
4.25	Receiver Spurious Emissions	59
5	TEST SETUPS	60
5.1	Frequency Measurements	60
5.2	Timing Measurements	60
5.3	Conducted Emission Test.....	60
5.4	Radiated Emissions Test	61
5.5	Power Line Conducted Emissions Test	61
5.6	Monitoring Tests	62
6	TEST EQUIPMENT USED	63

1 GENERAL INFORMATION

1.1 Testhouse Info

Name : Nemko Comlab
Address : Gåsevikveien 8, Box 96
N-2027 Kjeller, NORWAY
Telephone : +47 64 84 57 00
Fax : +47 64 84 57 05
E-mail: comlab@nemko.com
FCC test firm
registration # : 994405
IC OATS
registration # : 4443
Total Number
of Pages: 63

1.2 Client Information

Name : RTX America Inc.
Address : 2099 Gateway Place, Suite 310, San Jose, 95110 California, USA

Contact:

Name : Curtis Schmidek
E-mail : curtis.schmidek@rtxamerica.com

1.3 Manufacturer (if other than client)

Name : RTX Products
Address : Stroemmen 6, 9400 Noerresundby, Denmark

Contact:

Name : Klaus Ahlbeck
E-mail : kal@rtx.dk

2 Test Information

2.1 Tested Item

Name :	RTX
FCC ID :	ELIRTX3088-1
Industry Canada ID :	4979A-RTX3088
Model/version :	RTX3088.1 RTX3089.1 Webt@Iker 6000
Serial number :	/
Hardware identity and/or version:	V6rC
Software identity and/or version :	V109
Frequency Range :	1921.536 – 1928.448 MHz
Number of Channels :	5 RF Channels, 5x12 = 60 TDMA Duplex Channels
Type of Modulation :	GFSK
User Frequency Adjustment :	None
Rated Output Power :	90 mW Peak Power
Type of Power Supply :	Batteries (2x1.2V NiMH rechargeable AAA size cells)
Antenna Connector :	None
Antenna Diversity Supported :	No
Number of Antennas :	1
Desktop Charger :	External charger: RTX3088.3 AC Adaptor: Salom Model: SSW-1254US

Description of Tested Device(s)

The tested equipment is a cordless DECT 6.0 handset which complies with ETSI EN 300 175. The frequencies have been reprogrammed, the output power reduced and the software updated to comply with the FCC requirements to an Isochronous UPCS device after FCC Part 15D.

The EUT is an initiating device as described in ANSI C63.17 and is designed to operate together with a DECT fixed part (i.e. a base station), which is then the responding device.

When used together with the RTX3088.2 DECT 6.0 Base, this equipment can be used to make PSTN as well as Skype calls.

Exposure Evaluation

The EUT is a portable device and is designed to be held to ear or worn in a belt clip when used. A test reports with the measured SAR values for both configurations are submitted with the application.

The EUT is exempted from RF Exposure Evaluation to Industry Canada SAR requirements since the output power is below the limit in RSS-102 Issue 2, clause 2.5.1 for General Public Use.

2.2 Test Environment

Temperature: 21 – 23 °C

Relative humidity: 20 – 40 %

Normal test voltage: 2.5 V DC

The EUT were powered from the supplied NiMH batteries during all tests.

The values are the limit registered during the test period.

2.3 Test Period

Item received date: 2007-04-02

Test period : from 2007-04-02 to 2007-05-07

2.4 Test Engineers

Frode Sveinsen / Tore Løvlien

2.5 Test Equipment

See list of test equipment in clause 6.

2.6 Other Comments

The Monitoring and Time and Spectrum Window Access tests were performed with Test Set-Up 6 (Ref. clause 5). A clock signal from the companion device was used to synchronize the Pulse Pattern Generator and the Spectrum Analyzer to the start of the DECT time window. The EUT was limited by administrative commands to operate on only two frequency carriers. For the tests where the EUT was required to operate on only one frequency carrier, one carrier was blocked by applying a CW interfering signal from RF Generator 3. The Pulse Pattern Generator was used to apply time synchronized interference to time windows where this was required.

Since the EUT was programmed to operate on only two RF carriers, it was only necessary with two RF generators for the monitoring tests, however a third generator was applied for the tests that required specific time slots to be blocked.

All tests except the Radiated Spurious Emissions, Radiated Power and the Power line conducted emissions tests were performed in conducted mode with a temporary antenna connector.

The Radiated Emissions tests were performed with all ports populated and operating.

Radiated tests below 1 GHz were performed with the handset in the charger and charging, in speakerphone mode.

3 TEST REPORT SUMMARY

3.1 General

Manufacturer: RTX Products
Model No.: See clause 2.1
Serial No.: /

All measurements are traceable to national standards.

The tests were conducted on a sample of the equipment for the purpose of demonstrating compliance with FCC CFR47 Part 15, paragraph 15.323 for Isochronous UPCS Devices and Industry Canada RSS-213 Issue 2.

The test methods have been in accordance with ANSI C63.17-2006 where applicable.

Radiated tests were conducted in accordance with ANSI C63.4-2003. Radiated emissions are made in a 10m semi-anechoic chamber. A description of the test facility is on file with the FCC and Industry Canada.

- | | |
|---|---|
| <input checked="" type="checkbox"/> New Submission | <input checked="" type="checkbox"/> Production Unit |
| <input type="checkbox"/> Class II Permissive Change | <input type="checkbox"/> Pre-production Unit |
| PUE Equipment Code | <input type="checkbox"/> Family Listing |

THIS TEST REPORT RELATES ONLY TO THE ITEM(S) AND CONFIGURATIONS TESTED.

Deviations from, additions to, or exclusions from the test specifications are described in "Summary of Test Data".



TEST REPORT NO: 83518/10

TESTED BY : 
Frode Sveinsen, Chief Engineer

DATE: 7 May 2007

Nemko Group authorizes the above named company to reproduce this report provided it is reproduced in its entirety and for use by the company's employees only. Any reproduction of parts of this report requires approval in writing from Nemko Group.

Any use which a third party makes of this report, or any reliance on or decisions to be made based on it, are the responsibility of such third parties. Nemko Group accepts no responsibility for damages suffered by any third party as a result of decisions made or actions based on this report.

3.2 Test Summary

Name of test	FCC CFR 47 Paragraph #	IC RSS-213 Paragraph #	Verdict
Coordination with fixed microwave	15.307(b)	N/A	Complies
Digital Modulation Techniques	15.319(b)	6.1	Complies
Labeling requirements	15.19(a)(3)	RSS-GEN 5.2	Complies
Antenna Requirement	15.317, 15.203	4.1(e)	Complies
Power Line Conducted Emission	15.107(a) 15.207(a)	6.3 RSS-GEN 7.2.2	Complies
Emission Bandwidth	15.323(a)	6.4	Complies
In-band emissions	15.323(d)	6.7.2	Complies
Out-of-band emissions	15.323(d)	6.7.1	Complies
Peak transmit Power	15.319(c), 15.31(e)	6.5	Complies
Power Spectral Density	15.319(d)	4.3.2.1	Complies
Automatic discontinuation of transmission	15.319(f)	4.3.4(a)	Complies
Carrier frequency stability	15.323(f)	6.2	Complies
Frame repetition stability	15.323(e)	4.3.4(c)	Complies
Frame period and jitter	15.323(e)	4.3.4(c)	Complies
Monitoring threshold, Least interfered channel	15.323(c)(2);(5); (9)	4.3.4(b)	Complies
Monitoring of intended transmit window and maximum reaction time	15.323(c)(1)	4.3.4	Complies
Threshold monitoring bandwidth	15.323(c)(7)	4.3.4	Complies
Reaction time and monitoring interval	15.323(c)(1);(5); (7)	4.3.4	Complies
Access criteria test interval	15.323(c)(4);(6)	4.3.4	N/A ¹
Access Criteria functional test	15.323(c)(4);(6)	4.3.4	N/A ¹
Acknowledgements	15.323(c)(4)	4.3.4	Complies
Transmission duration	15.323(c)(3)	4.3.4	Complies
Dual access criteria	15.323(c)(10)	4.3.4	Complies
Alterative monitoring interval	15.323(c)(10);(11)	4.3.4	N/A ²
Spurious Emissions (Antenna Conducted)	15.323(d)	6.7.1	Complies ³
Spurious Emissions (Radiated)	15.319(g) 15.109(a) 15.209(a)	4.3.3 RSS-GEN 7.2.3	Complies
Receiver Spurious Emissions	N/A	6.8	Complies

¹ Only applies for equipment that transmits unacknowledged control and signaling information

² The client declares that the tested equipment does not implement this provision

³ The tested equipment has integrated antennas only

4 TEST RESULTS

4.1 Power Line Conducted Emissions

Para. No.: 15.207 (a)

Test Performed By: Jan Eriksen	Date of Test: 17 April 2007
--------------------------------	-----------------------------

Measurement procedure: ANSI C63.4-2003 using 50 μ H/50 ohms LISN.

Test Results: Complies

Measurement Data: See attached graphs, (Peak detector)

Highest measured value (L1 and N):

Frequency	Detector	Measured value	Limit	Margin
MHz	Peak/QP/AV	dB μ V	dB μ V	dB
0.2645	QP	34.6	61.3	26.7
	AV	30.8	51.3	20.5
0.743	QP	38.0	56	14.7
	AV	33.5	46	9.2
0.862	QP	39.5	56	12.0
	AV	33.9	46	7.6
0.874	QP	39.6	56	11.8
	AV	32.6	46	8.8

NEMKO COMLAB

17. Apr 07 15:00

Peak

Operator: jge
 Comment: Skype DECT handset in charger stdby
 RTX Telecom
 ANSI C63.4-2003 phase N
 Skype Call Active

Scan Settings (1 Range)

Frequencies				Receiver Settings			
Start	Stop	Step	IF BW	Detector	M-Time	Atten	Preamp OpRge
150k	30M	4.5k	9k	PK	50ms	AUTO LN	OFF 60dB

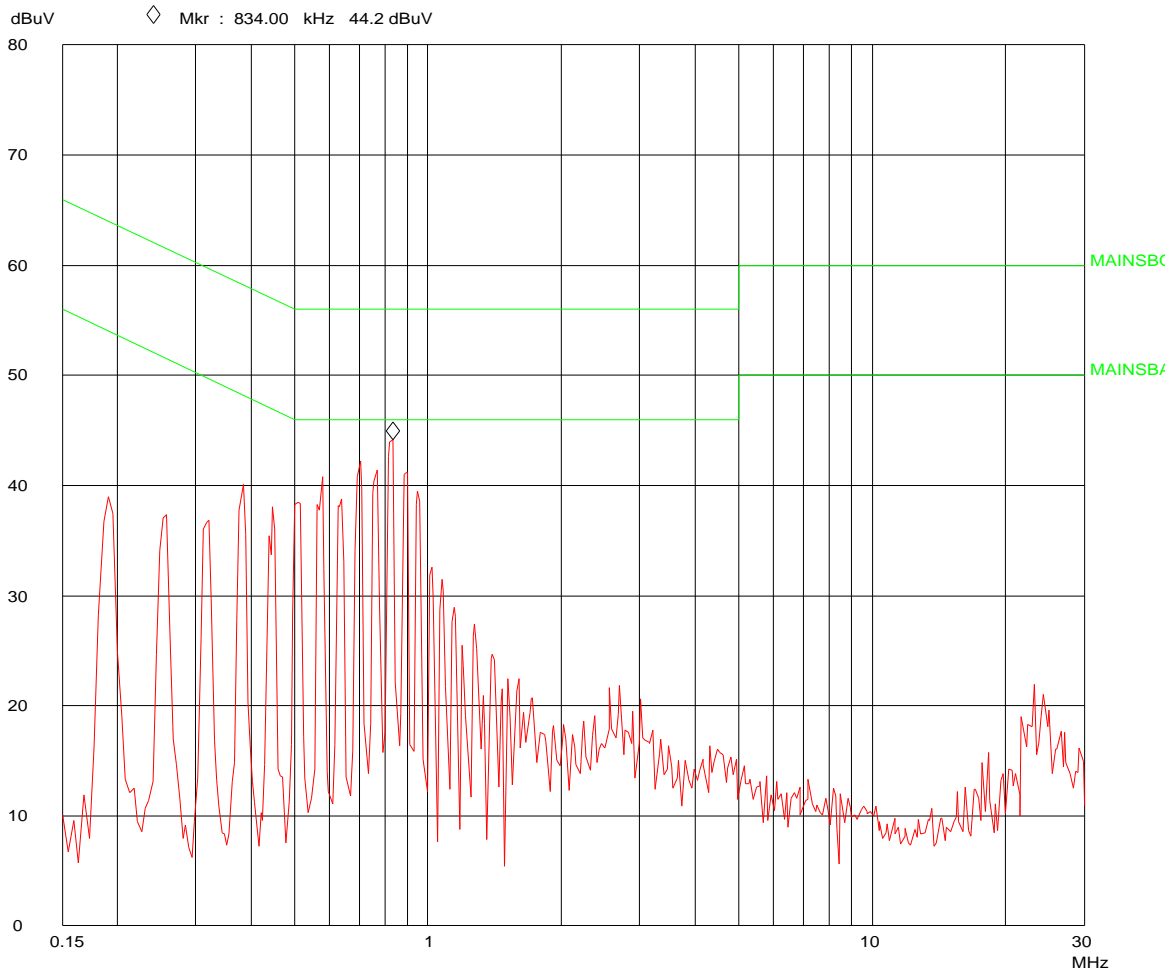

Phase N, Charging, Standby

NEMKO COMLAB

17. Apr 07 15:13

Peak

Operator: jge
 Comment: Skype DECT handset in charger stdby
 RTX Telecom
 ANSI C63.4-2003 phase L1
 Skype Call Active

Scan Settings (1 Range)

Frequencies			Receiver Settings					
Start	Stop	Step	IF BW	Detector	M-Time	Atten	Preamp	OpRge
150k	30M	4.5k	9k	PK	50ms	AUTO	LN OFF	60dB

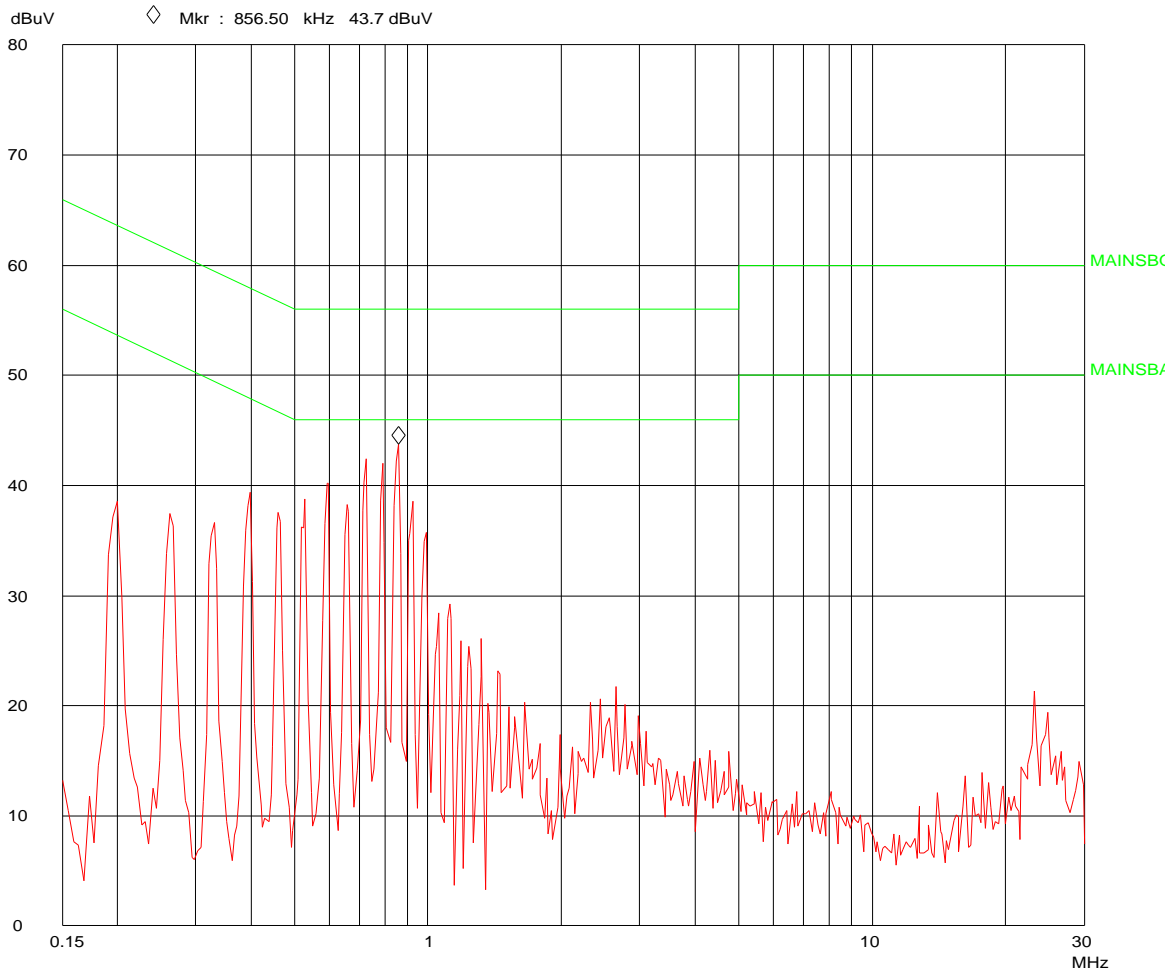

Phase L1, Charging, Standby

NEMKO COMLAB

17. Apr 07 15:38

Peak

Operator: jge
 Comment: Skype DECT handset in charger operate
 RTX Telecom
 ANSI C63.4-2003 phase N
 Skype Call Active

Scan Settings (1 Range)

Frequencies				Receiver Settings			
Start	Stop	Step	IF BW	Detector	M-Time	Atten	Preamp OpRge
150k	30M	4.5k	9k	PK	50ms	AUTO LN	OFF 60dB

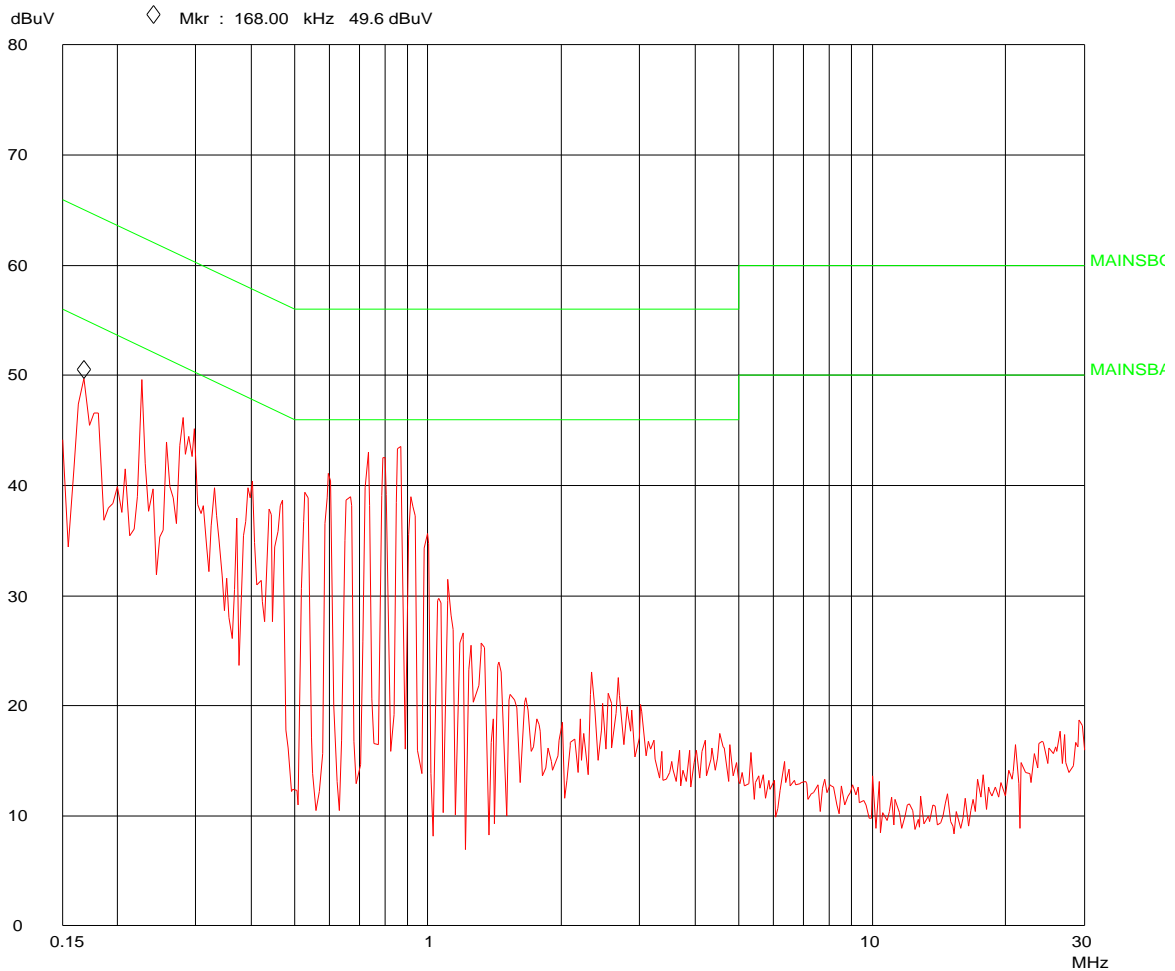

Phase N, Charging, Speaker Mode

NEMKO COMLAB

17. Apr 07 15:26

Peak

Operator: jge
 Comment: Skype DECT handset in charger operate
 RTX Telecom
 ANSI C63.4-2003 phase L1
 Skype Call Active

Scan Settings (1 Range)

Frequencies			Receiver Settings					
Start	Stop	Step	IF BW	Detector	M-Time	Atten	Preamp	OpRge
150k	30M	4.5k	9k	PK	50ms	AUTO	LN	OFF 60dB

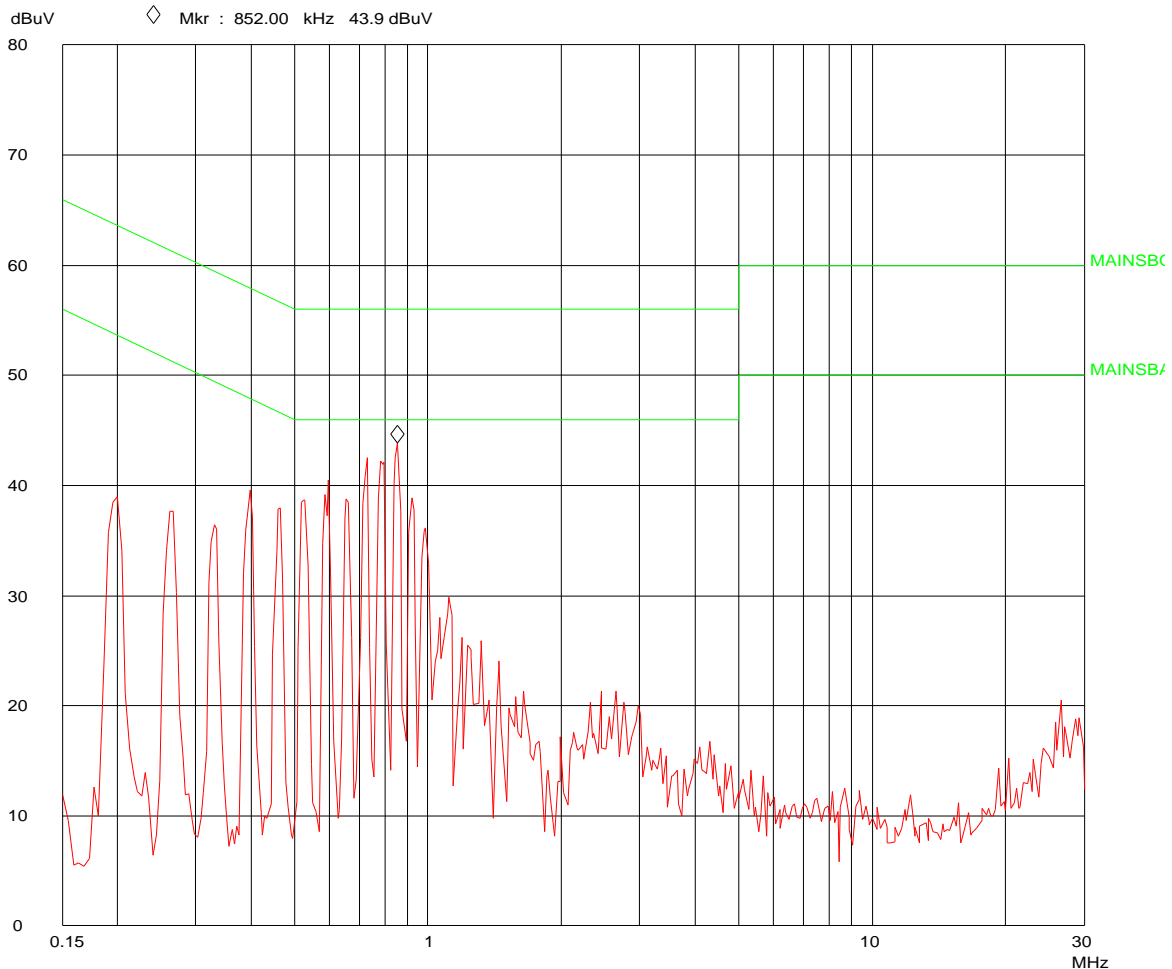

Phase L1, Charging, Speaker Mode

4.2 Coordination with fixed microwave

The affidavit from UTAM, Inc. is included in the documentation supplied by the applicant:

Yes

No

Requirement, FCC 15.307 (b):

Each application for certification of equipment operating under the provisions of this Subpart must be accompanied by an affidavit from UTAM, Inc. certifying that the applicant is a participating member of UTAM, Inc. In the event a grantee fails to fulfill the obligations attendant to participation in UTAM, Inc., the Commission may invoke administrative sanctions as necessary to preclude continued marketing and installation of devices covered by the grant of certification, including but not limited to revoking certification.

4.3 Digital Modulation Techniques

The tested equipment is based on DECT technology described in the ETSI standard EN 300175, the only difference is that the channel allocation is modified to operate in the 1920-1930 MHz band.

The EUT used Multi Carrier / Time Division Multiple Access / Time Division Duplex and Digital GFSK modulation.

For further details see the operational description provided by the applicant.

Requirement, FCC 15.319(b):

All transmissions must use only digital modulation techniques.

4.4 Labeling Requirements

See separate documents showing the label design and the placement of the label on the EUT.

Requirements FCC 15.19

The FCC Identifier shall be displayed on the label, and the device(s) shall bear the following statement in a conspicuous location on the device or in the user manual if the device is too small:

This device complies with Part 15 of the FCC Rules. Operation is subject to the following two conditions: (1) this device may not cause harmful interference, and (2) this device must accept any interference received, including interference that may cause undesired operation.

The label itself shall be of a permanent type, not a paper label, and shall last the lifetime of the equipment.

4.5 Antenna Requirement

Does the EUT have detachable antenna?

Yes No

If detachable, is the antenna connector non-standard?

Yes No

The tested equipment has only integral antennas. The conducted tests were performed on a sample with a temporary antenna connector.

Requirement: FCC 15.203, 15.204, 15.317.

4.6 Channel Frequencies

UPCS CHANNEL	FREQUENCY (MHz)
Upper Band Edge	1930.000
0 (Highest)	1928.448
1	1926.720
2	1924.992
3	1923.264
4 (Lowest)	1921.536
Lower Band Edge	1920.000

Requirement: FCC 15.303 (d), (g)

Within 1920 -1930 MHz band for isochronous devices.

4.7 Automatic Discontinuation of Transmission

The EUT transmits Control and Signaling Information?	<input type="checkbox"/> YES	<input checked="" type="checkbox"/> NO
TYPE OF EUT :	<input checked="" type="checkbox"/> INITIATING DEVICE	<input type="checkbox"/> RESPONDING DEVICE

The following tests simulate the reaction of the EUT in case of either absence of information to transmit or operational failure after a connection with the companion device is established.

Number	Test	EUT Reaction	Verdict
1	Power removed from the EUT	C	Pass
2	EUT Switch Off	C	Pass
3	Hook-On by Companion Device	NA	Pass
4	Hook-On by EUT	C	Pass
5	Power Removed from Companion Device	A	Pass
6	Companion Device Switch Off	NA	Pass

- A - Connection breakdown, Cease of all transmissions
- B - Connection breakdown, EUT transmits control and signaling information
- C - Connection breakdown, Companion Device transmits control and signaling information
- NA - Not Applicable (the Companion Device does not have an on/off switch and can not perform Hook-On)

Requirements, FCC 15.319(f)

The device shall automatically discontinue transmission in case of either absence of information to transmit or operational failure. These provisions are not intended to preclude transmission of control and signaling information or use of repetitive codes used by certain digital technologies to complete frame or burst intervals.

4.8 Peak Power Output

Test Method:

ANSI C63.17, clause 6.1.2.

Test Results: Complies

Measurement Data:

Maximum Conducted Output Power

Channel No.	Frequency (MHz)	Maximum Conducted Output Power (dBm)	Maximum Radiated Output Power (dBm)	Maximum Antenna Gain (dBi)
4	1921.536	19.6	20.7	+1.1
0	1928.448	19.6	20.0	+0.4

The EIRP is calculated from measured field strength by the formula in DA00-705.

The EUT was rotated in 3 planes for the Antenna Gain test.

Limit:

Conducted: $100 \mu\text{W} \times \text{SQRT}(B) = 120 \text{ mW} = 20.8 \text{ dBm}$, where B is measured Emission Bandwidth in Hz

The antenna gain is below 3 dBi, no reduction in transmit power is necessary.

Requirements, FCC 15.319(c)(f)

Peak transmit power shall not exceed 100 microwatts multiplied by the square root of the emission bandwidth in hertz.

The peak transmit power shall be reduced by the amount in decibels that the maximum directional gain of the antenna exceeds 3 dBi.

Conducted Peak Output Power

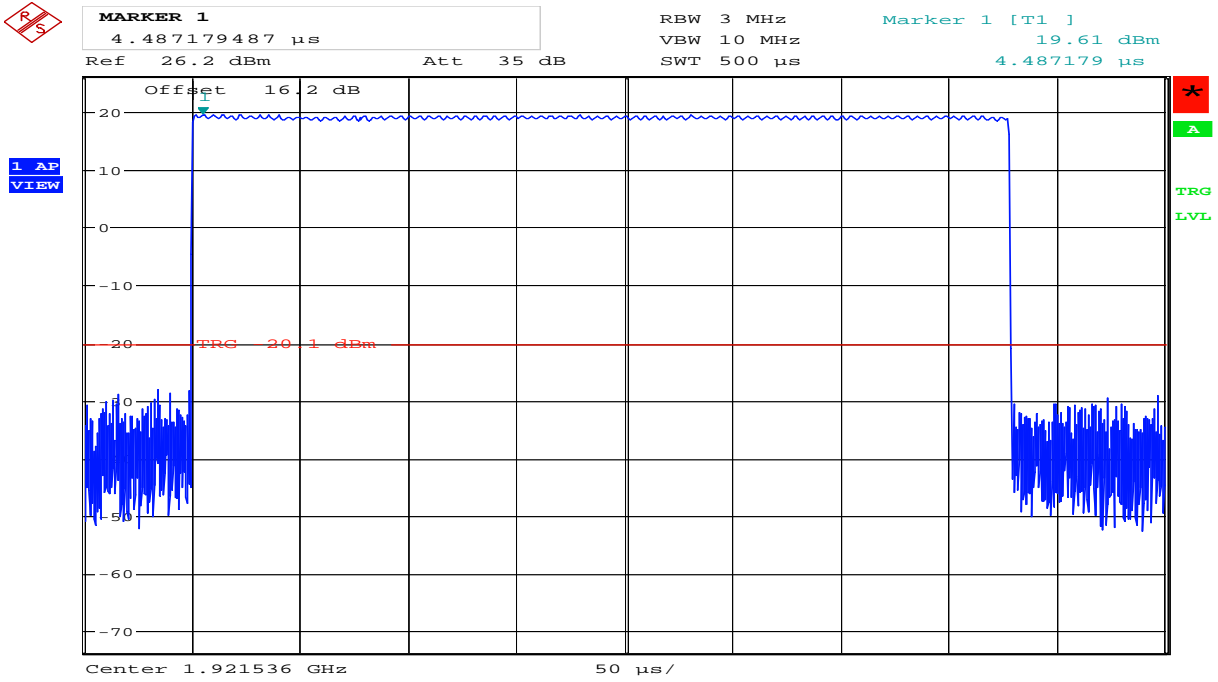

Date: 3.APR.2007 12:42:33

Lower Channel

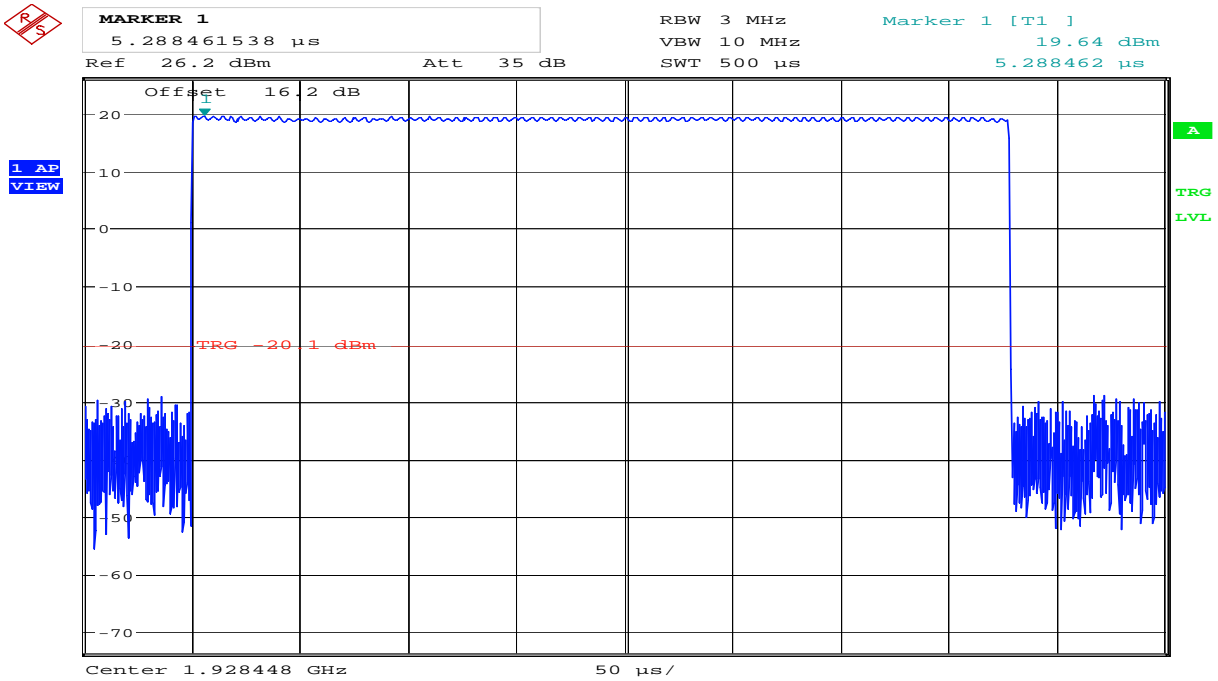

Date: 3.APR.2007 12:39:05

Upper Channel

Radiated Peak Output Power

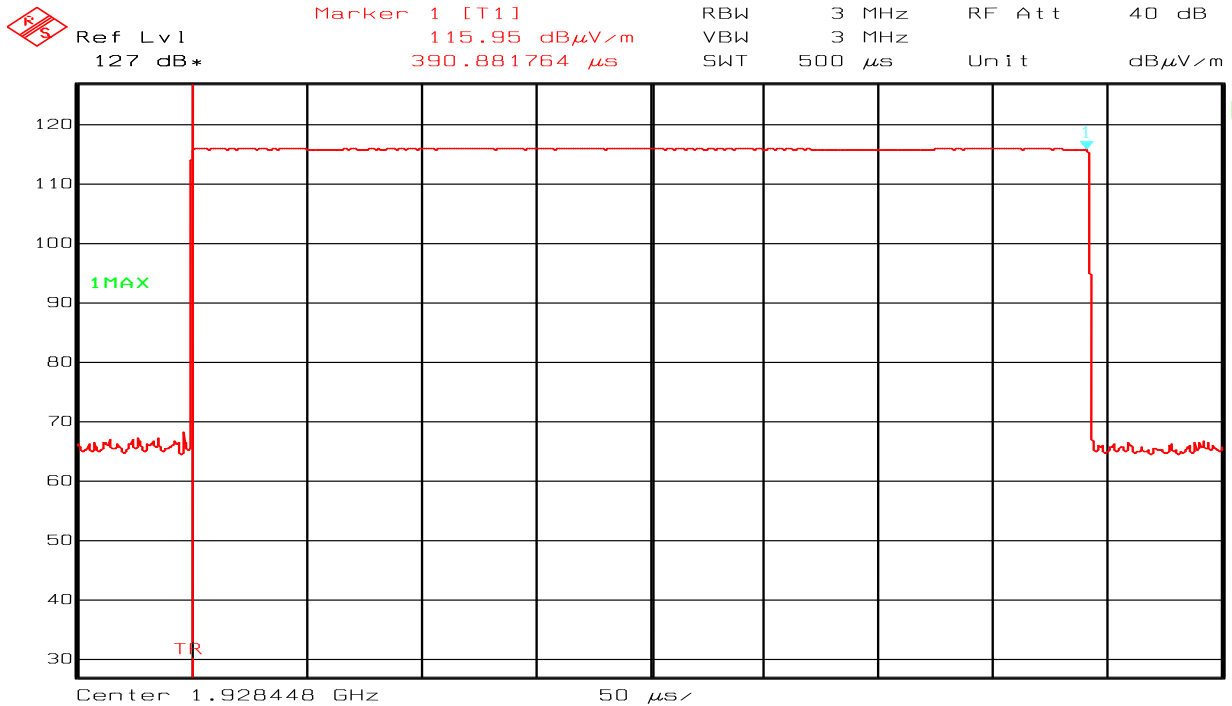

Date: 11.APR.2007 16:19:27

Lower Channel (Max: EUT H, VP)

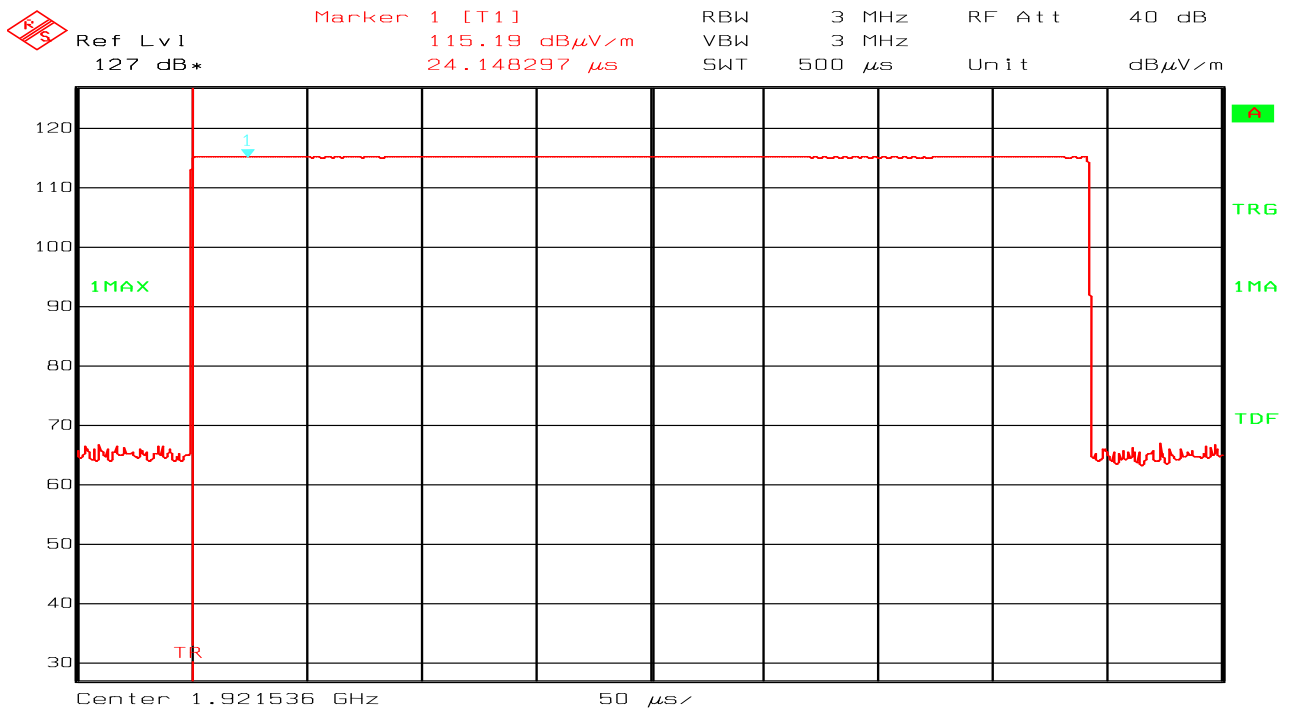

Date: 11.APR.2007 16:39:01

Upper Channel (Max: EUT H, HP)

4.9 Emission Bandwidth *B*

Test Method:

ANSI C63.17, clause 6.1.3.

Test Results: Complies

Measurement Data:

Channel No.	Frequency (MHz)	26 dB Bandwidth <i>B</i> (kHz)
4	1921.536	1442
0	1928.448	1522

Channel No.	Frequency (MHz)	20 dB Bandwidth (kHz)
2	1924.992	1346

Channel No.	Frequency (MHz)	6 dB Bandwidth (kHz)
4	1921.536	N/A
0	1928.448	N/A

Channel No.	Frequency (MHz)	12 dB Bandwidth (kHz)
4	1921.536	N/A
0	1928.448	N/A

Requirements, FCC 15.323(a)

The 26 dB Bandwidth *B* shall be larger than 50 kHz and less than 2.5 MHz.

Requirements, RSS-213 Issue 2, clause 6.4

The 20 dB Bandwidth shall be larger than 50 kHz and less than 2.5 MHz.

No requirements for 6 and 12 dB Bandwidth, these values are only used for testing Monitoring Bandwidth if the Simple Compliance test fails (ANSI C63.17, clause 7.4).

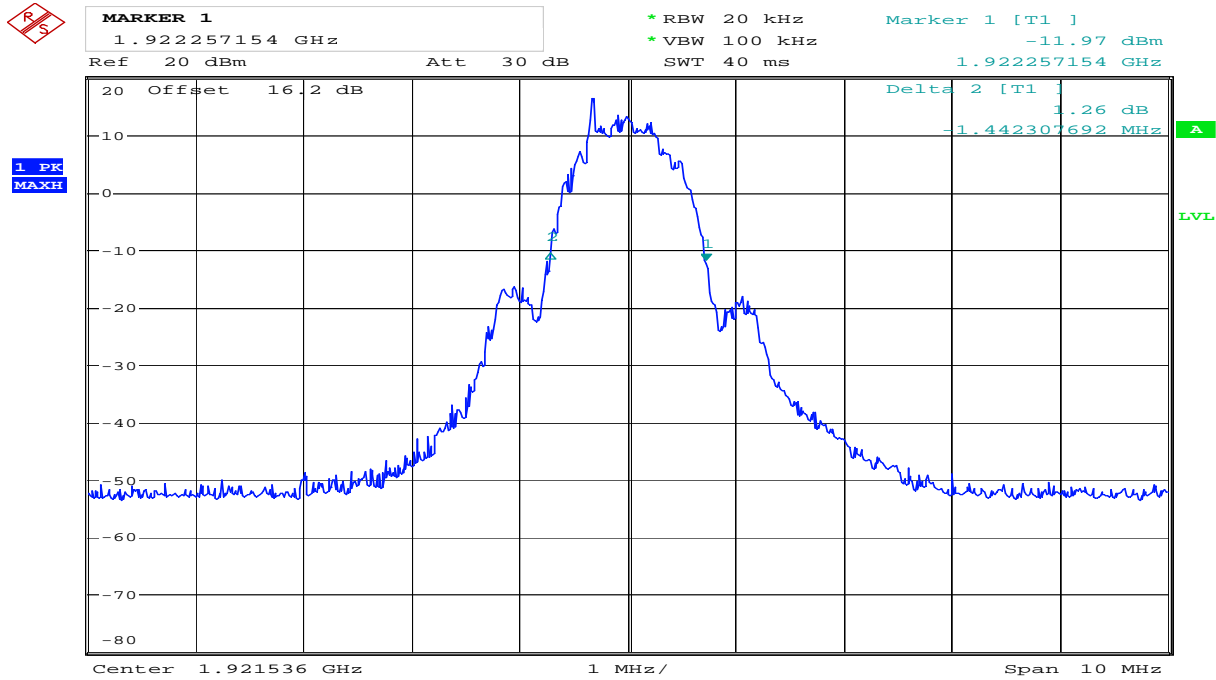

Date: 3.APR.2007 13:05:48

Emission Bandwidth B, Lower Channel

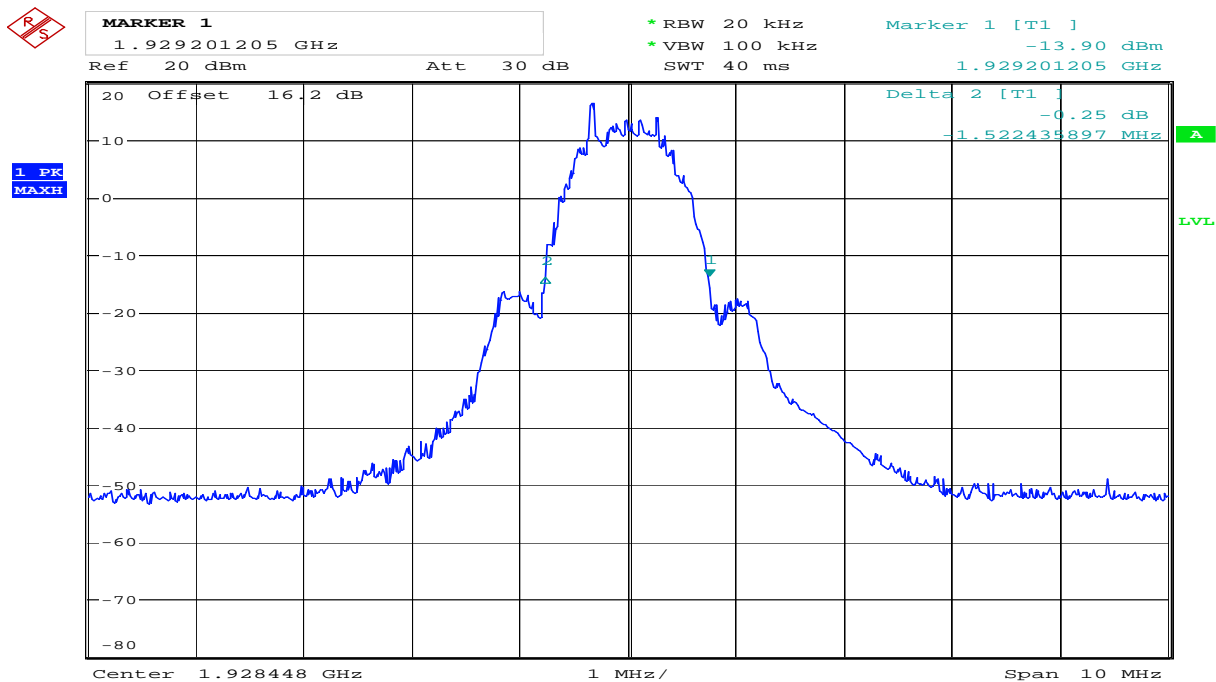

Date: 3.APR.2007 13:12:01

Emission Bandwidth B, Upper Channel



MARKER 1
 1.925665077 GHz
 Ref 20 dBm * Att 15 dB * RBW 20 kHz Marker 1 [T1]
 * VBW 100 kHz -7.48 dBm
 SWT 40 ms 1.925665077 GHz

1 PK
 MAXH

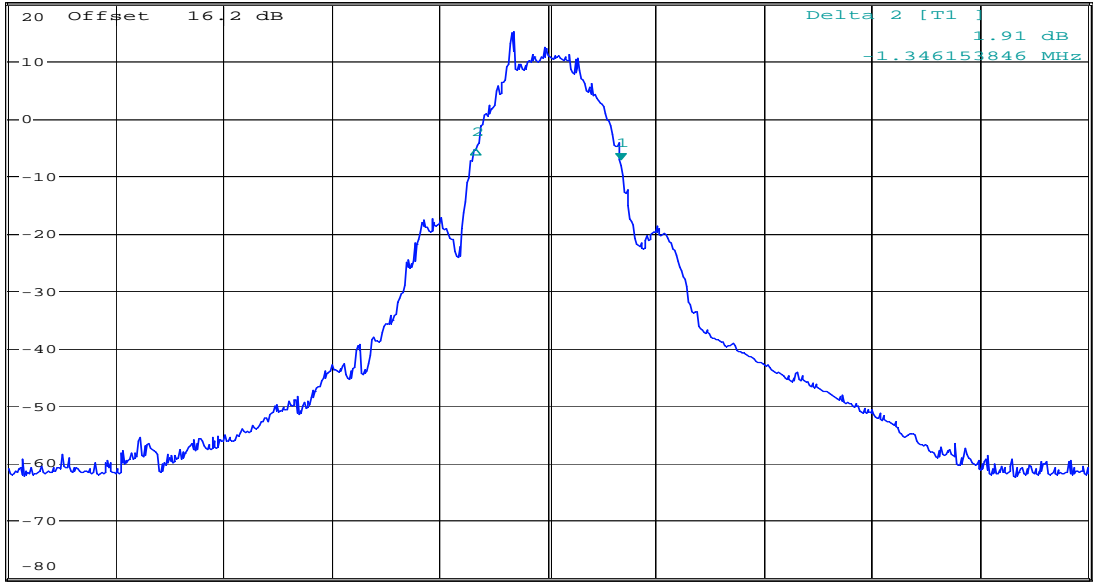

Date: 7.MAY.2007 14:17:51

20dB Bandwidth, Middle Channel

4.10 Power Spectral Density

Test Method:

ANSI C63.17, clause 6.1.5.

Test Results: Complies

Measurement Data:

Channel No.	Frequency (MHz)	Power Spectral Density (dBm)
4	1921.536	-0.6
0	1928.448	-3.9

Averaged over 1000 sweeps.

Requirements, FCC 15.319(d)

The Power Spectral Density shall be less than 3 mW (4.77 dBm) when averaged over minimum 100 sweeps.

Power Spectral Density

Lower Channel:

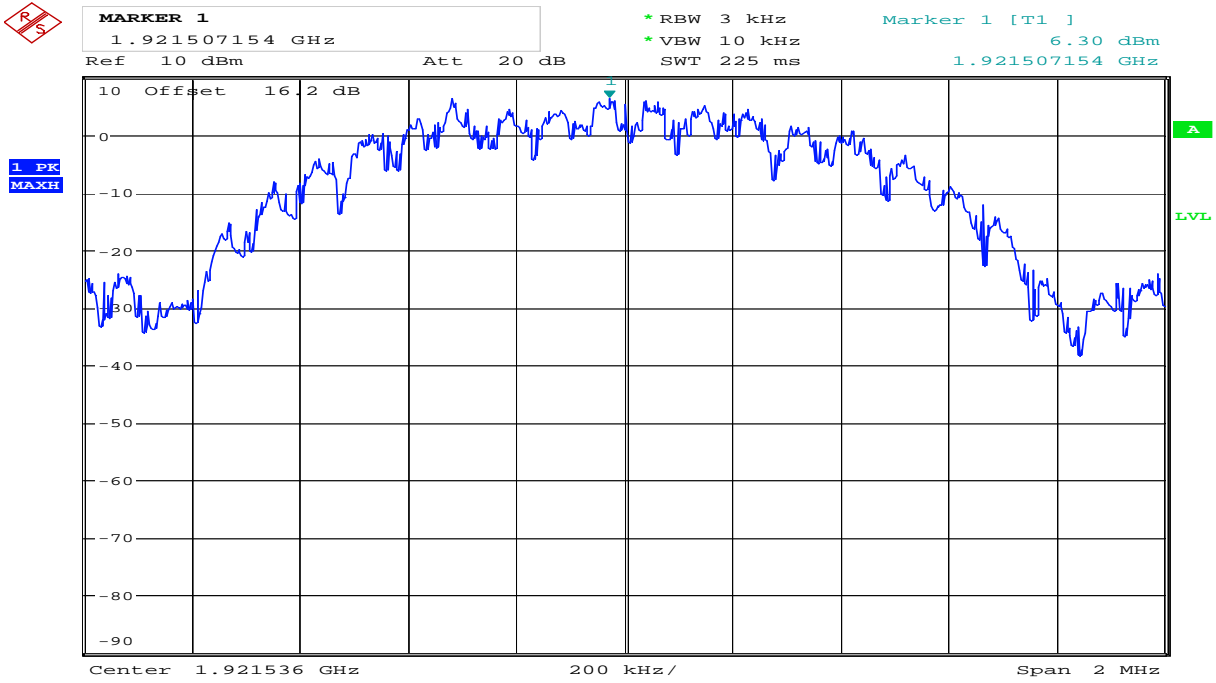

Date: 3.APR.2007 13:34:59

Overview

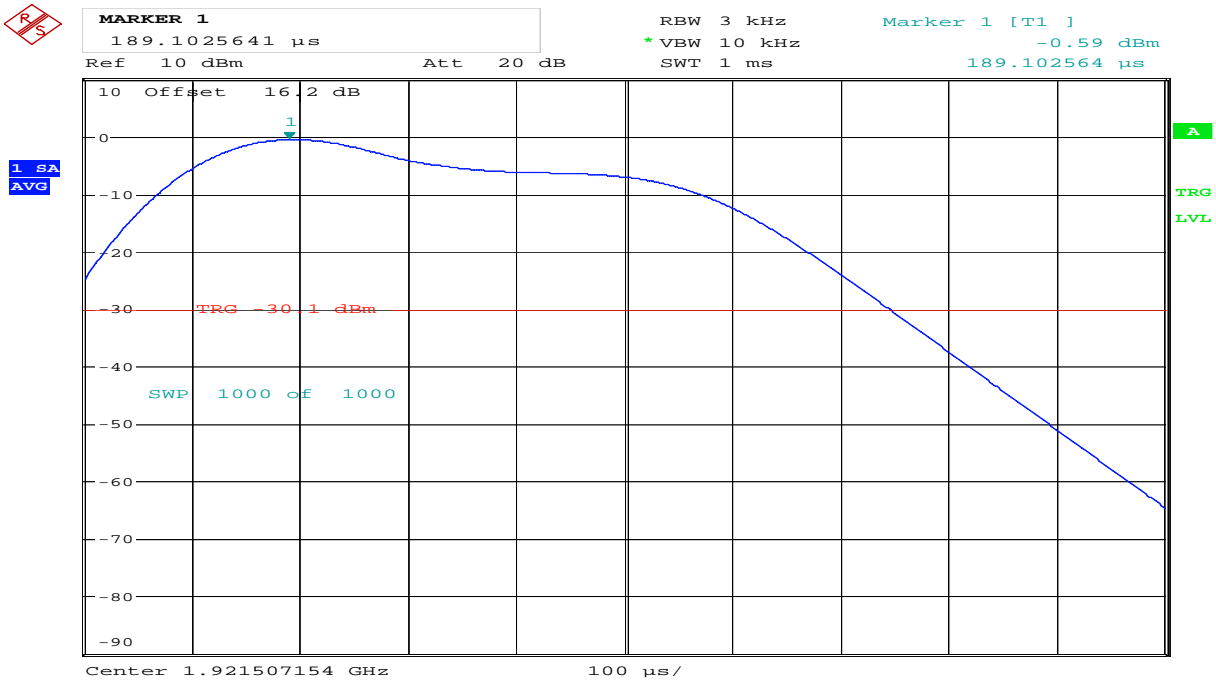

Date: 3.APR.2007 13:36:17

Averaged, 1000 Sweeps, Sample Detector

Power Spectral Density

Upper Channel:

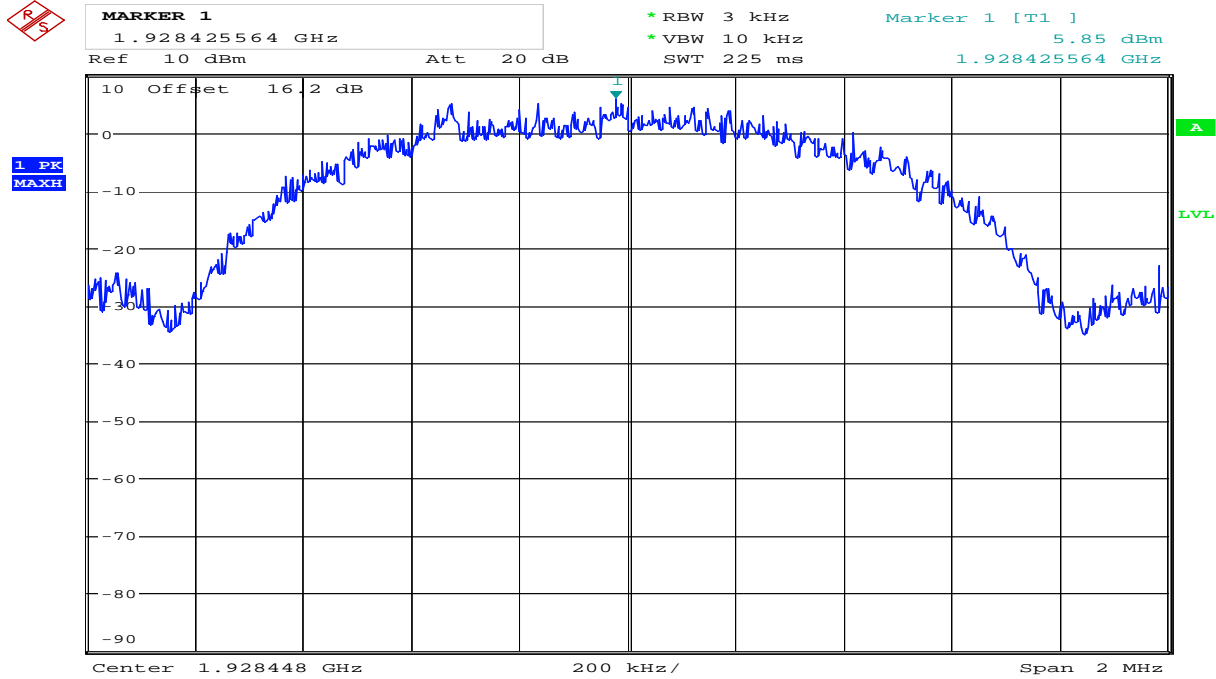

Date: 3.APR.2007 13:15:57

Overview

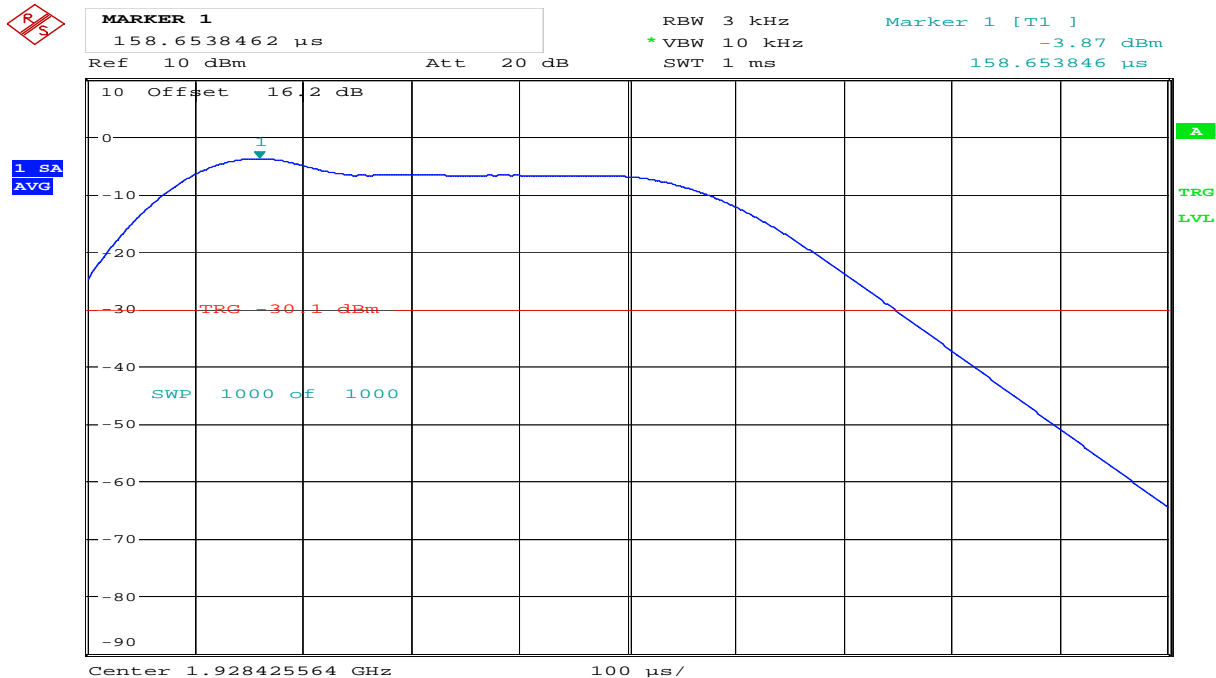

Date: 3.APR.2007 13:22:47

Averaged, 1000 Sweeps, Sample Detector

4.11 In-Band Unwanted Emissions, Conducted

Test Method:

ANSI C63.17, clause 6.1.6.1.

Test Results: Complies

Measurement Data:

See plots.

Requirements, FCC 15.323(d):

$B < f \leq 2B$: less than or equal to 30 dB below max. permitted peak power level

$2B < f \leq 3B$: less than or equal to 50 dB below max. permitted peak power level

$3B < f \leq$ UPCS Band Edge : less than or equal to 60 dB below max. permitted peak power level

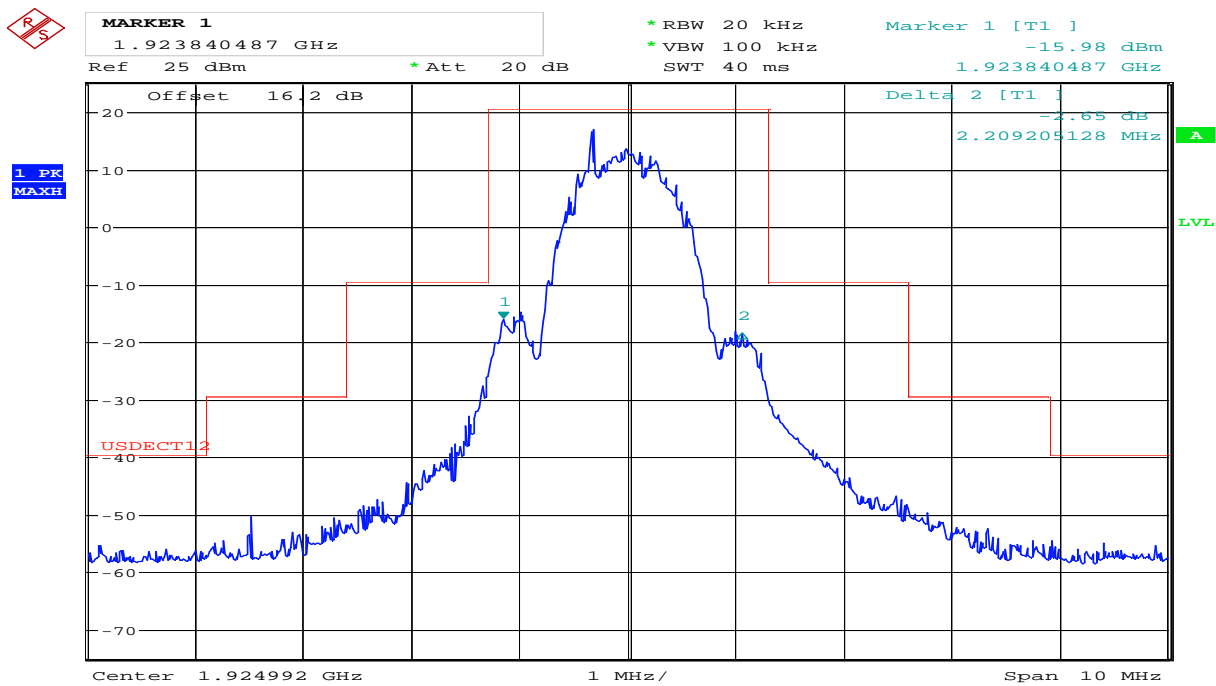

Date: 3.APR.2007 13:43:15

Middle Channel

In-Band Unwanted Emissions, Conducted

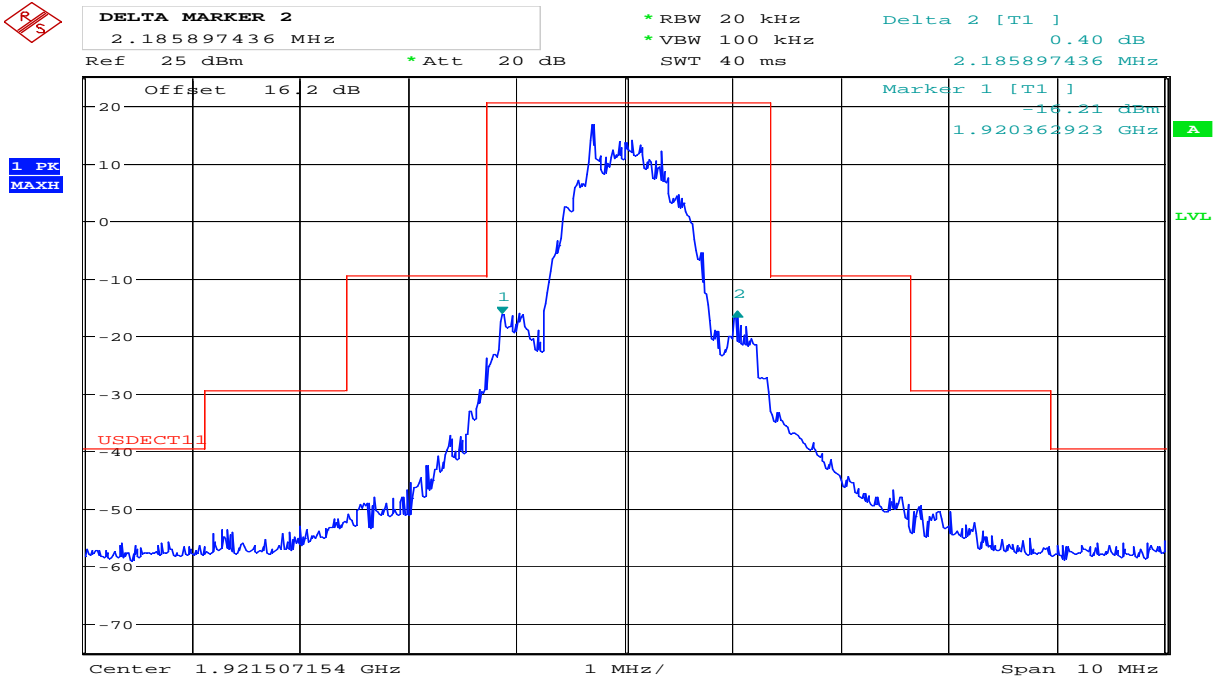

Date: 3.APR.2007 13:40:27

Lower Channel

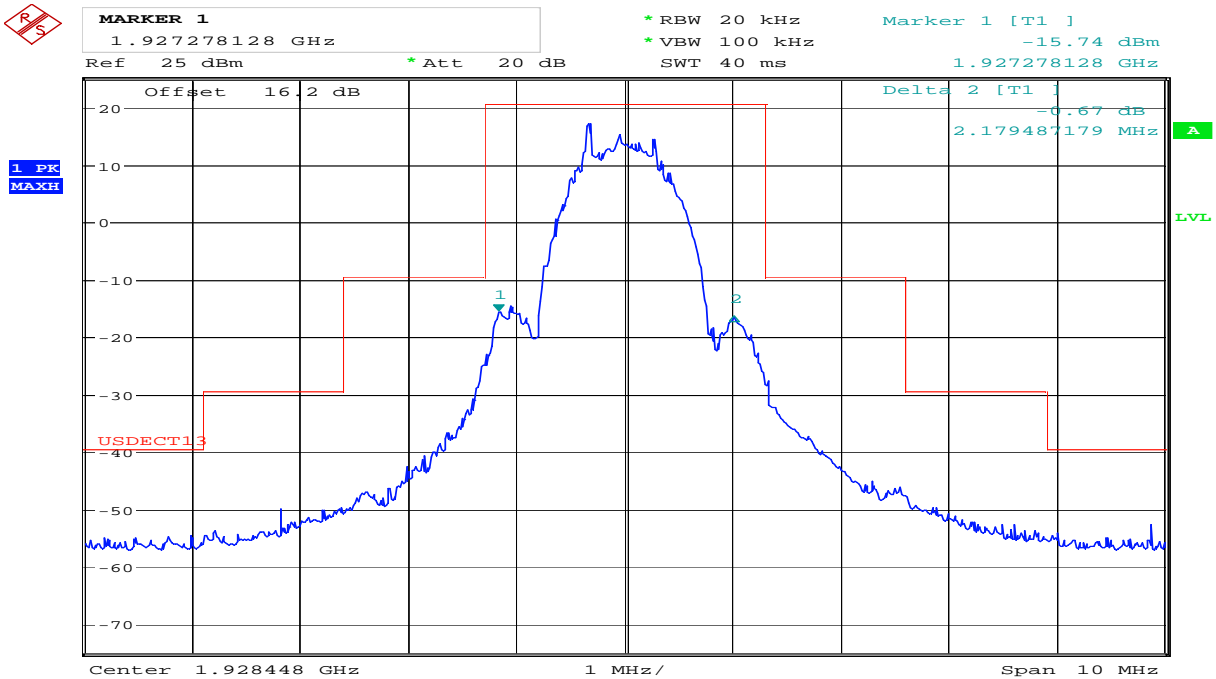

Date: 3.APR.2007 13:56:17

Upper Channel

4.12 Out-of-band Emissions, Conducted

Test Method:

ANSI C63.17, clause 6.1.6.2.

Test Results: Complies

Measurement Data:

See plots.

Requirements, FCC 15.323(d):

$f \leq 1.25\text{MHz}$ outside UPCS band :	$\leq -9.5\text{dBm}$
$1.25\text{MHz} \leq f \leq 2.5\text{MHz}$ outside UPCS band :	$\leq -29.5 \text{ dBm}$
$f \geq 2.5\text{MHz}$ outside UPCS band :	$\leq -39.5 \text{ dBm}$

Out-of-Band Emissions, Conducted

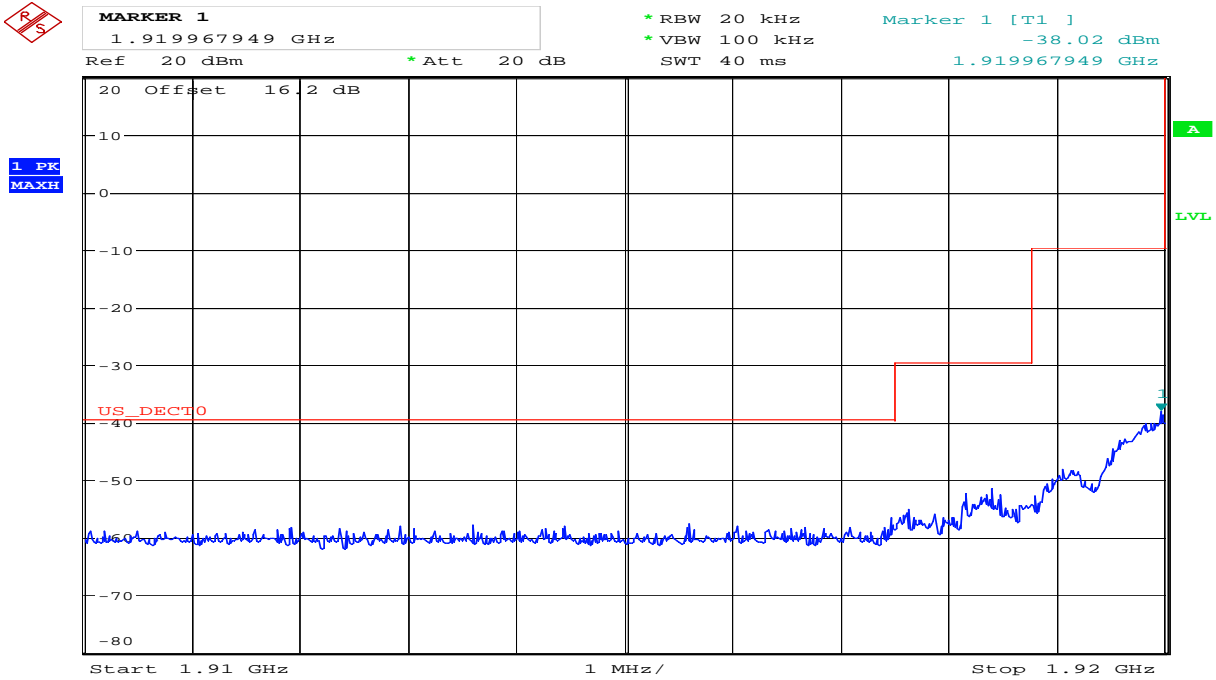

Date: 3.APR.2007 17:01:15

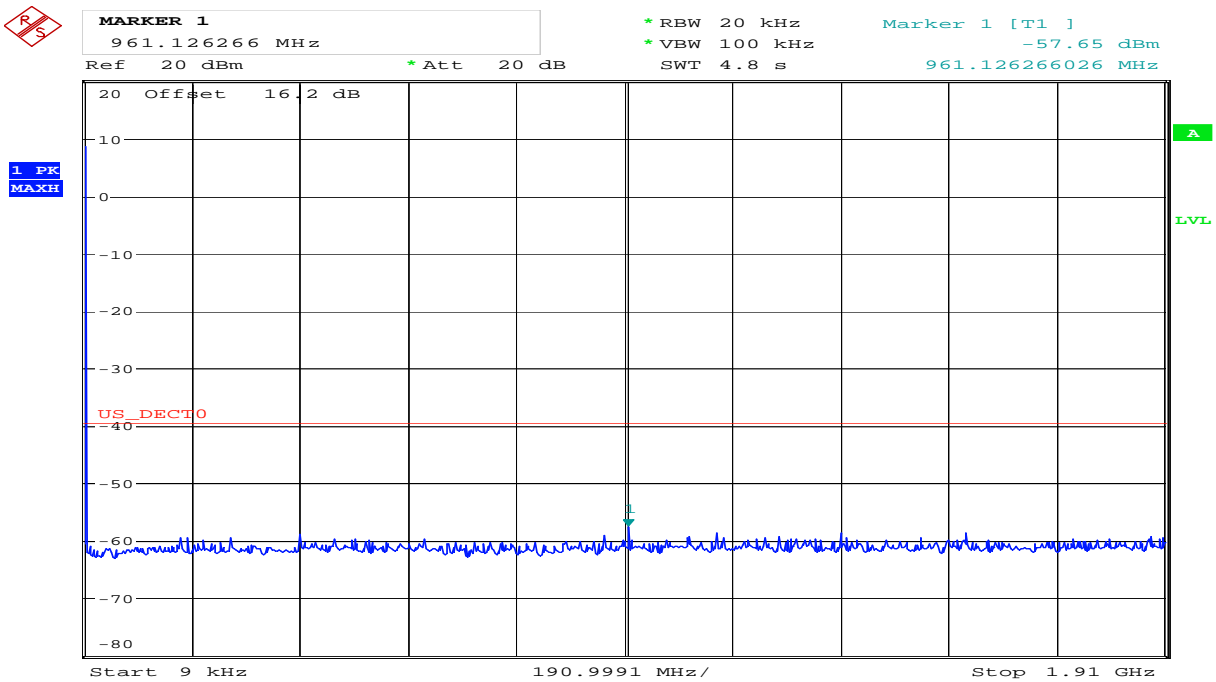

Date: 3.APR.2007 17:02:43

Lower Channel

Out-of-Band Emissions, Conducted

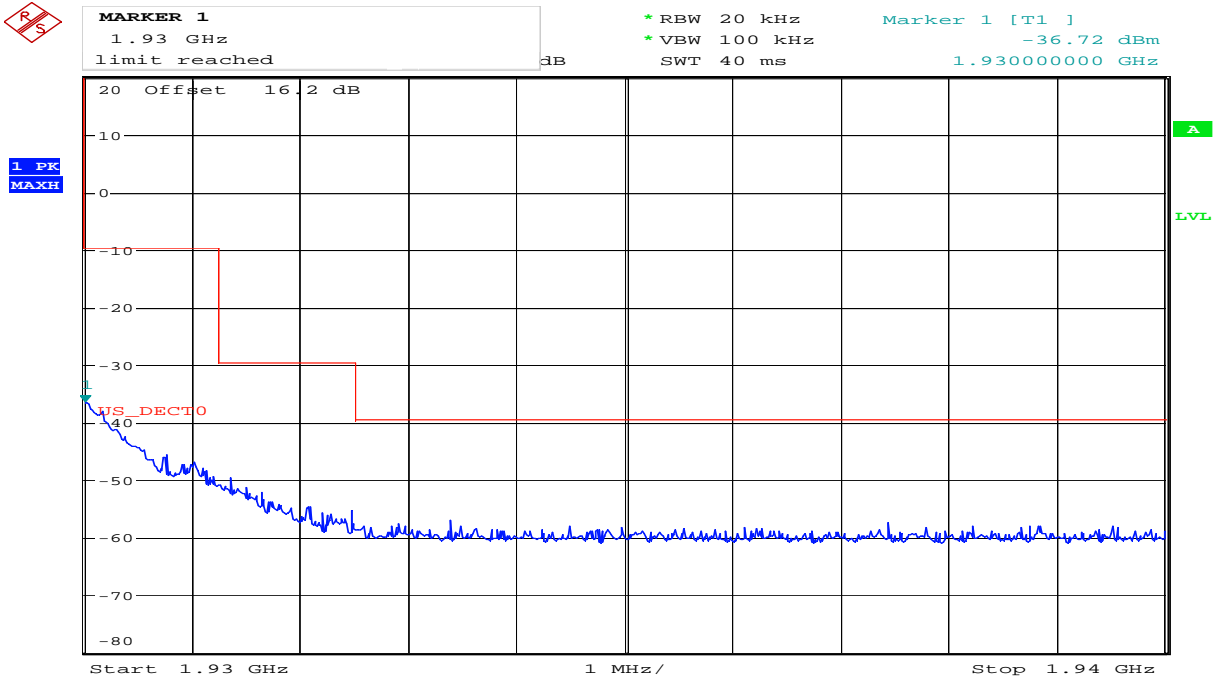

Date: 3.APR.2007 16:52:18

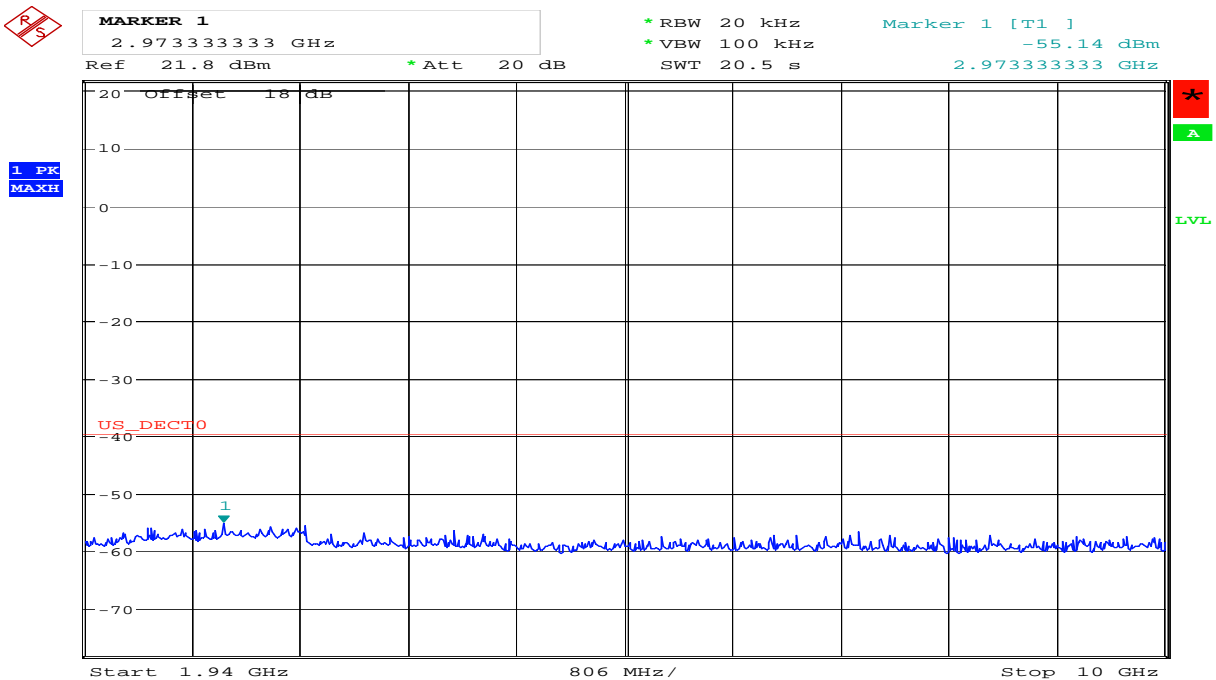

Date: 3.APR.2007 17:13:01

Upper Channel

Out-of-Band Emissions, Conducted

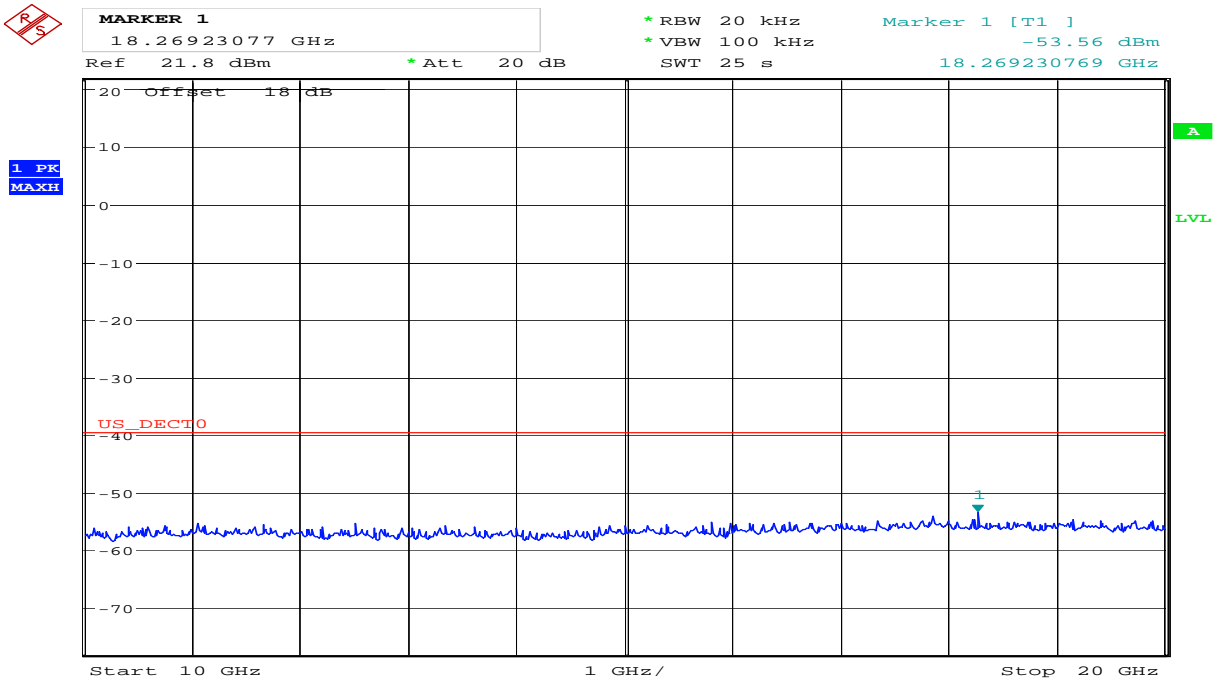

Date: 3.APR.2007 17:17:06

Upper Channel

4.13 Carrier Frequency Stability

Test Method:

ANSI C63.17, clause 6.2.1.

Test Results: Complies

Measurement Data:

The Carrier frequency stability is measured directly with a Frequency Domain Analyzer in histogram mode. Frequency Deviation in ppm is calculated.

Frequency Stability over 1 hour of operation at Nominal Temperature

Voltage	Nominal Carrier Frequency (MHz)	Pk-Pk Difference (kHz)	Deviation (ppm)	Limit
V _{nom}	1924.992	35.2	9.1	±10 ppm

$$\text{Deviation ppm} = ((\text{Pk-Pk difference} / 2) / \text{Mean}) \times 10^6$$

Frequency Stability over Power Supply Voltage at Nominal Temperature

Voltage	Measured Carrier Frequency (MHz)	Difference (kHz)	Deviation (ppm)	Limit
V _{nom}	N/A	0	0	±10 ppm
85% of V _{nom}	N/A	N/A	N/A	
115% of V _{nom}	N/A	N/A	N/A	

$$\text{Deviation ppm} = ((\text{Mean} - \text{Measured Frequency}) / \text{Mean}) \times 10^6$$

This test does not apply for EUT that is powered from batteries.

Frequency Stability over Temperature

Temperature	Measured Carrier Frequency (MHz)	Difference (kHz)	Deviation (ppm)	Limit
T = +20 °C	1924.930467	Ref.	Ref.	±10 ppm
T = -20 °C	1924.925519	5.1	2.6	
T = +50 °C	1924.934140	3.7	1.9	

$$\text{Deviation ppm} = ((\text{Mean} - \text{Measured Frequency}) / \text{Mean}) \times 10^6$$

4.14 Frame Repetition Stability

Test Method:

ANSI C63.17, clause 6.2.2.

Test Results: Complies

Measurement Data:

The envelope of the RF signal from the EUT is detected with a Crystal Detector and the mean and standard deviation of the frame repetition frequency is then gated over 100 frames and measured with a Frequency Domain Analyzer. The frame repetition stability is 3 times the standard deviation.

Carrier Frequency (MHz)	Mean (Hz)	Standard Deviation (Hz)	Frame Repetition Stability (ppm)
1924.992	100.000018	0.000000759	0.023

Limit:

Frame Repetition Stability	±10 ppm (TDMA)
----------------------------	----------------

Ref. FCC 15.323(e), ANSI C63.17, clause 6.2.2

4.15 Frame Period and Jitter

Test Method:

ANSI C63.17, clause 6.2.3.

Test Results: Complies

Measurement Data:

Carrier Frequency (MHz)	Frame Period (ms)	Max Jitter (µs)	3xStandard Deviation of Jitter (µs)
1924.992	9.9999987	0.249	0.070

Max Jitter = (1/ (Frame period + Pk-Pk/2)) - (1/Frame Period), when Pk-Pk and Frame Period are in Hz

Limit:

Frame Period	20 or 10 ms
Max Jitter	25 µs
3 times St.Dev of Jitter	12.5 µs

Ref. FCC 15.323(e), ANSI C63.17, clause 6.2.3

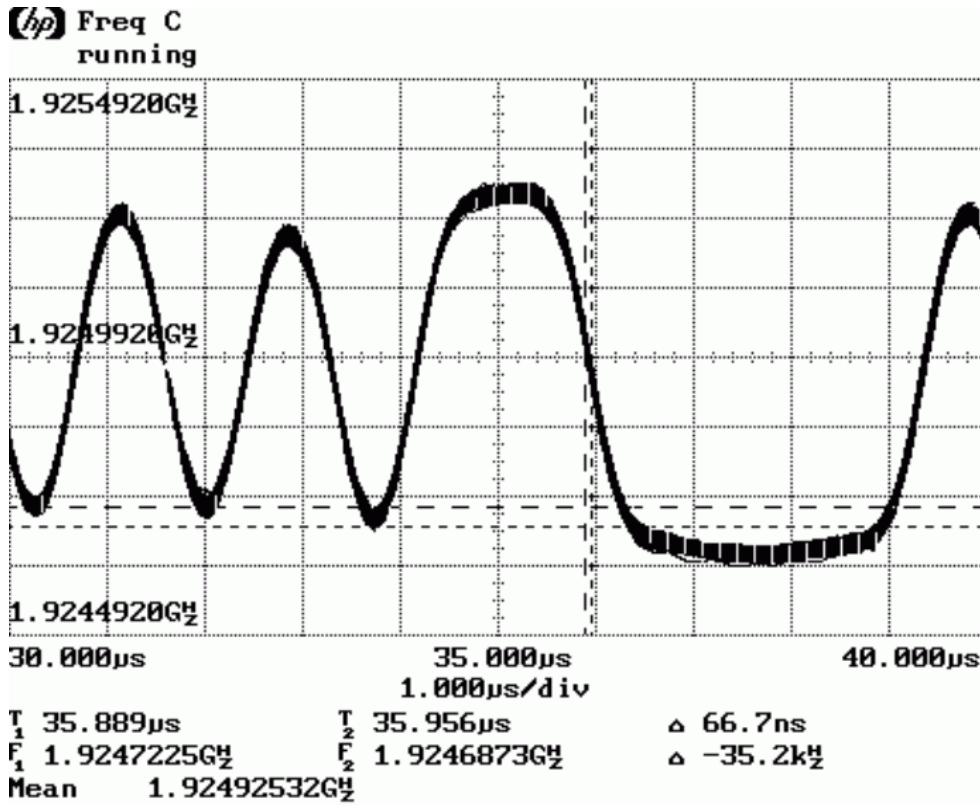

Long Term Carrier Frequency Stability

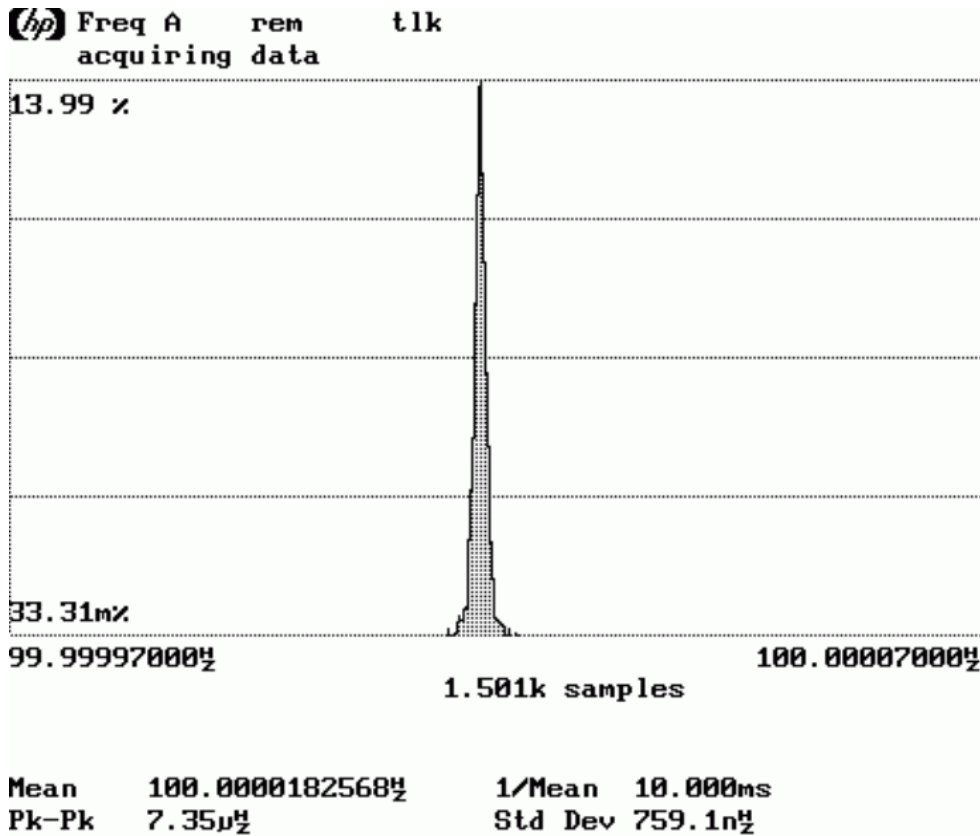

Frame Repetition Stability, Gated over 100 Frames

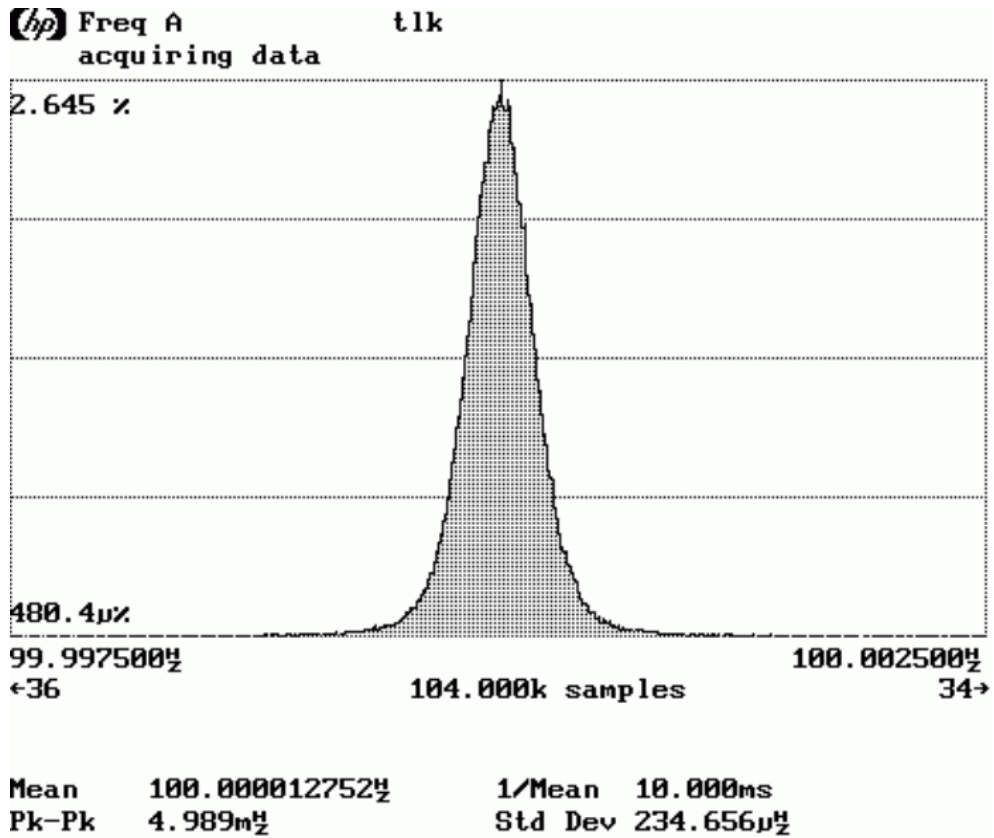

Frame Period and Jitter

4.16 Monitoring Threshold, Least Interfered Channel

Monitoring Threshold Limits:

Lower Threshold:

$$T_L = 15 \log B - 184 + 30 - P_{EUT} \quad (\text{dBm})$$

Upper Threshold:

$$T_U = 15 \log B - 184 + 50 - P_{EUT} \quad (\text{dBm})$$

B is measured Emission Bandwidth in Hz
 P_{EUT} is measured Transmitter Power in dBm

Calculated values:

Lower Threshold	-81.2 dBm
Upper Threshold	-61.2 dBm

The upper Threshold is applicable for systems which have defined a minimum of 40 duplex system access channels.

Measurement Procedure:

The Upper or Lower Threshold is found by the procedure defined in ANSI C63.17, clause 7.3.1 or 7.3.2.

Least Interfered Channel	
Lower Threshold	N/A
Upper Threshold	-61.7 dBm

Least Interfered Channel (LIC) Procedure Test, FCC 15.323(b), (c)(2) and (c)(5)

ANSI C63.17 clause 7.3.3 ref.	Observation	Verdict
b) $f_1 T_L + 13$ dB, f_2 at $T_L + 6$ dB	Transmission always on f_2	Pass
c) $f_1 T_L + 6$ dB, f_2 at $T_L + 13$ dB	Transmission always on f_1	Pass
d) $f_1 T_L + 7$ dB, f_2 at T_L	Transmission always on f_2	Pass
e) $f_1 T_L$, f_2 at $T_L + 7$ dB	Transmission always on f_1	Pass

Selected Channel Confirmation, FCC 15.323(c)(1) and (5)

ANSI C63.17 clause 7.3.4	Observation	Verdict
b) Shall not transmit on f_1	EUT transmits on f_2	Pass
d) Shall not transmit on f_2	EUT transmits on f_1	Pass

Limits:

Lower Threshold + 6 dB margin	-75.2 dBm
Upper Threshold + 6 dB margin	-55.2 dBm

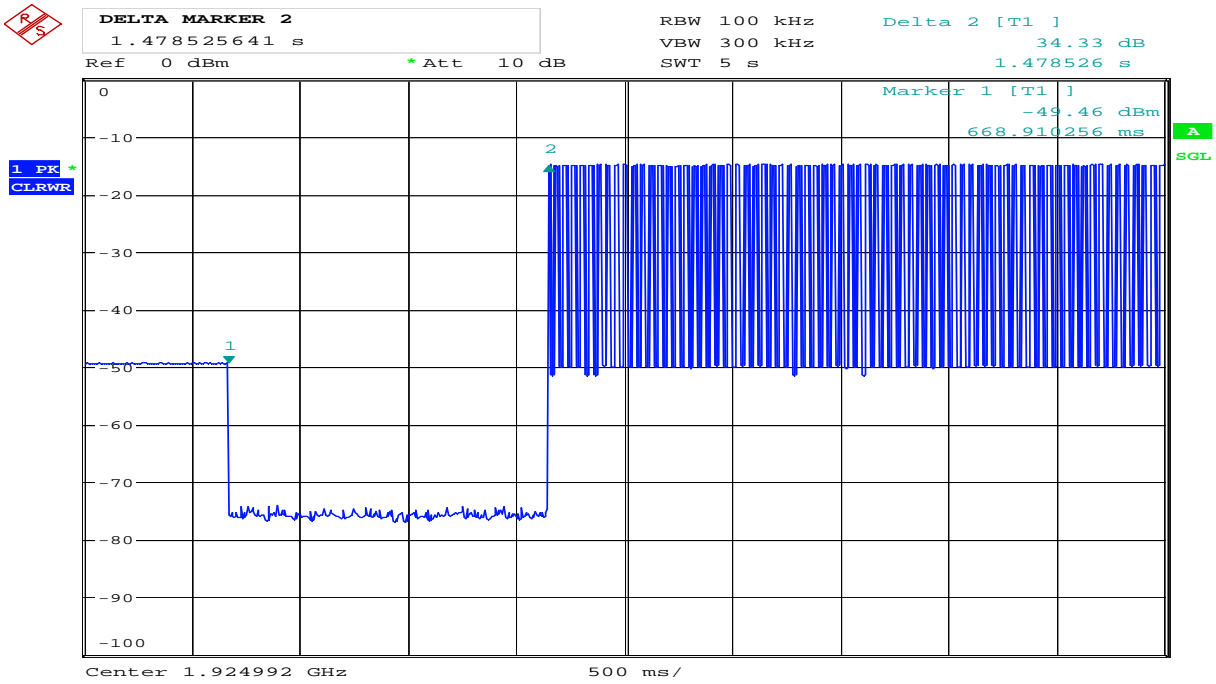

Date: 10.APR.2007 17:02:25

7.3.4 Selected Channel Confirmation, Connection 1.5s After Interferer Removed

4.17 Threshold Monitoring Bandwidth

This test is only required if a dedicated monitoring receiver is used. However, if the test is not carried out the manufacturer shall declare and provide proper evidence that the monitoring is made through the radio receiver used for communication.

Measurement Procedure:

Simple Compliance Test, ANSI C63.17, clause 7.4.1

More Detailed Test, ANSI C63.17, clause 7.4.2

The test is passed if **either** the Simple Compliance Test or the More Detailed test is passed.

During this test the spectrum analyzer is observed visually to see if the EUT transmits or not.

Test Results:

Test performed	Observation	Verdict
Simple Compliance test, at $\pm 30\%$ of B	No transmissions	Pass
More Detailed Test, at -6 dB points	N/A	N/A
More Detailed Test, at -12 dB points	N/A	N/A

The more detailed test must be pass at both the -6 and -12 dB points if the Simple Compliance test fails.

Comment: The tested EUT uses the same receiver for monitoring and communication, this test is therefore not required. However the test has been performed nonetheless and the test is passed.

Limits, FCC 15.323(c)(7):

The monitoring system bandwidth must be equal to or greater than the emission bandwidth of the intended transmission.

4.18 Reaction Time and Monitoring Interval

Measurement Procedure

ANSI C63.17, clause 7.5

Test results:

By administrative commands and out-of-operating region interference, the EUT is restricted to operate on a single carrier frequency. Time-synchronized pulsed interference is then applied on the carrier at pulsed level T_U+U_M or T_L+U_M , as appropriate.

The pulses are synchronized with the EUT timeslots and applied centered within all timeslots.

Pulse Width, ref. to ANSI C63.17 clause 7.5	Observation	Verdict
c) $>$ largest of 50 μ s and $50 \cdot \text{SQRT}(1.25/B)$	No connection	Pass
d) $>$ largest of 35 μ s and $35 \cdot \text{SQRT}(1.25/B)$, and with interference level raised 6 dB	No connection	Pass

Comment: Since B is larger than 1.25 MHz the test was performed with pulse lengths of 50 μ s and 35 μ s.

Limits, FCC 15.323(c)(1), (5) and (7)

The maximum reaction time must be less than $50 \cdot \text{SQRT}(1.25/\text{emission bandwidth in MHz})$ microseconds for signals at the applicable threshold level but shall not be required to be less than 50 microseconds.

If a signal is detected that is 6 dB or more above the applicable threshold level, the maximum reaction time shall be $35 \cdot \text{SQRT}(1.25/\text{emission bandwidth in MHz})$ microseconds but shall not be required to be less than 35 microseconds.

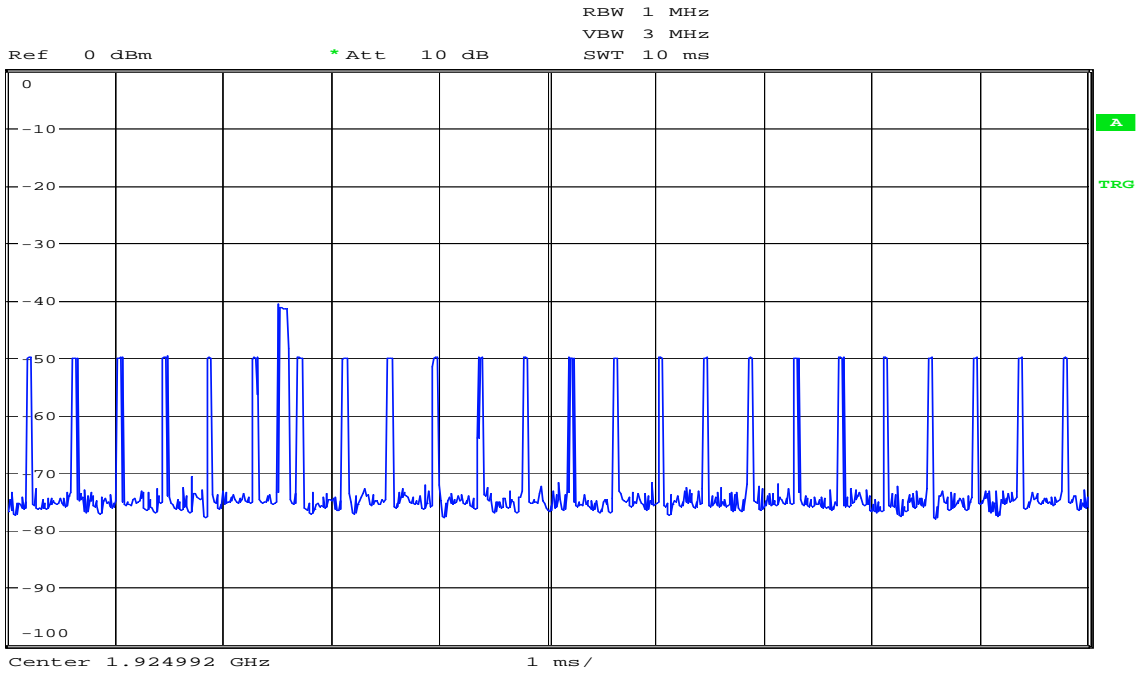

Date: 10.APR.2007 17:46:49

7.5c) Reaction Time, 50µs Pulses

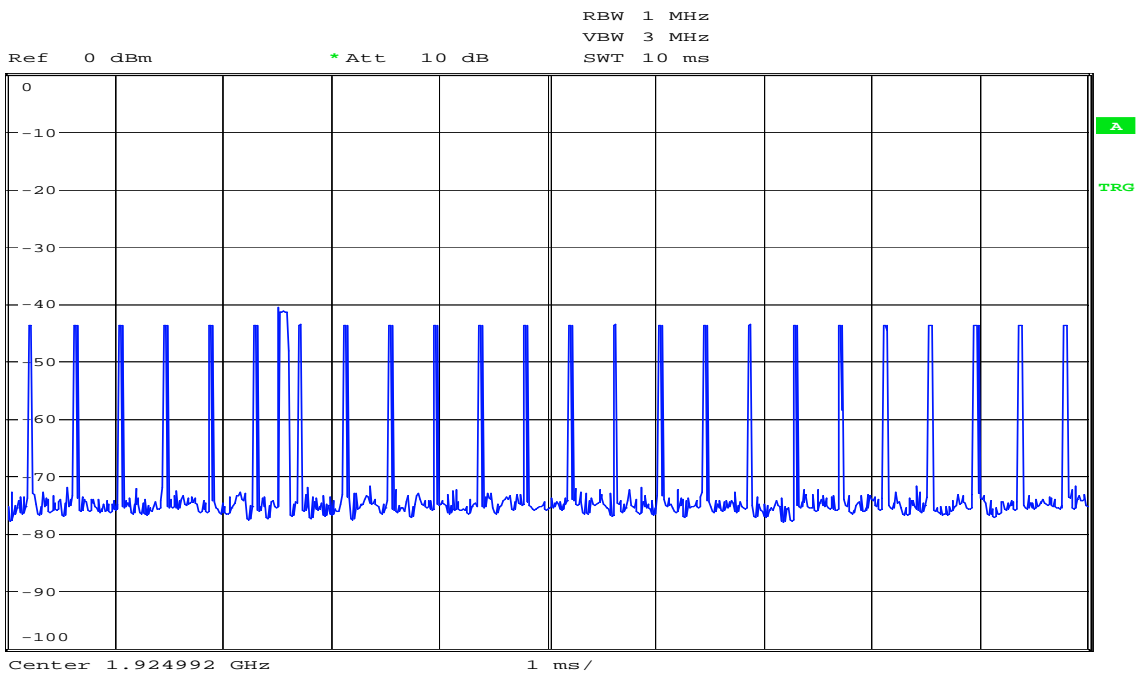

Date: 10.APR.2007 17:46:37

7.5d) Reaction Time, 35µs Pulses

4.19 Time and Spectrum Window Access Procedure

This requirement is only for EUTs which transmit unacknowledged control and signaling information.

Measurement Procedure:

Timing for EUTs using control and signaling channel type transmissions: ANSI C63.17, clause 8.1

Test results:

Access Criteria, ref. to ANSI C63.17 clause 8.1.1	Observation	Verdict
b) Check that the EUT transmits on the interference free time-slot	N/A	N/A
b) The EUT must terminate or pause in its repetitive transmission of the control and signaling channel on the open channel to repeat the access criteria not less frequently than every 30 s	N/A	N/A

If FCC 15.323(c)(6) option, **If Random Waiting Interval is NOT implemented**

Access Criteria, ref. to ANSI C63.17 clause 8.1.2	Observation	Verdict
b) Check that the EUT changes to an interference-free slot when interference is introduced on the time slot in use	N/A	N/A

If FCC 15.323(c)(6) option, **Only if Random Waiting Interval is implemented**

Access Criteria, ref. to ANSI C63.17 clause 8.1.3	Observation	Verdict
b-d) Check that the EUT uses random waiting interval before continuing transmission on an interfered time slot	N/A	N/A

Comment: The tested EUT does not transmit unacknowledged control and signaling information.

Limits:

FCC 15.323(c)(4):

Once access to specific combined time and spectrum windows is obtained an acknowledgement from a system participant must be received by the initiating transmitter within one second or transmission must cease. Periodic acknowledgements must be received at least every 30 seconds or transmission must cease. Channels used exclusively for control and signaling information may transmit continuously for 30 seconds without receiving an acknowledgement, at which time the access criteria must be repeated.

FCC 15.323(c)(6):

If the selected combined time and spectrum windows are unavailable, the device may either monitor and select different windows or seek to use the same windows after waiting an amount of time, randomly chosen from a uniform random distribution between 10 and 150 milliseconds, commencing when the channel becomes available

4.20 Acknowledgements and Transmission Duration

Measurement Procedure:

Acknowledgements: ANSI C63.17, clause 8.2.1

Transmission Duration: ANSI C63.17, clause 8.2.2

During the test **Initial transmission without acknowledgements** the signal from the EUT to the companion device is blocked by circulators in addition to the tunable attenuator.

The test **Transmission time after loss of acknowledgements** is performed by cutting-off the signal from the companion device by a RF switch and measuring the time until the EUT stops transmitting.

The **Transmission Duration** test is performed by monitoring the slot in use and measuring the time until the EUT changes to a different slot.

Test Results:

Acknowledgements

Test ref. to ANSI C63.17 clause 8.2.1	Observation	Verdict
a) Initial transmission without acknowledgements	0.35 s	Pass
c) Transmission time after loss of acknowledgements	5 s	Pass

Transmission Duration

Test ref. to ANSI C63.17 clause 8.2.2	Observation	Verdict
b) Transmission duration on same time and frequency window	10 minutes	Pass

Comment: Transmission duration on same time and frequency window is tested by monitoring the system slot with a computer.

Limits, FCC 15.323(c)(3) and (4)

Occupation of the same combined time and spectrum windows by a device or group of cooperating devices continuously over a period of time longer than 8 hours is not permitted without repeating the access criteria.

Once access to specific combined time and spectrum windows is obtained an acknowledgement from a system participant must be received by the initiating transmitter within one second or transmission must cease.

Periodic acknowledgements must be received at least every 30 seconds or transmission must cease. Channels used exclusively for control and signaling information may transmit continuously for 30 seconds without receiving an acknowledgement, at which time the access criteria must be repeated.

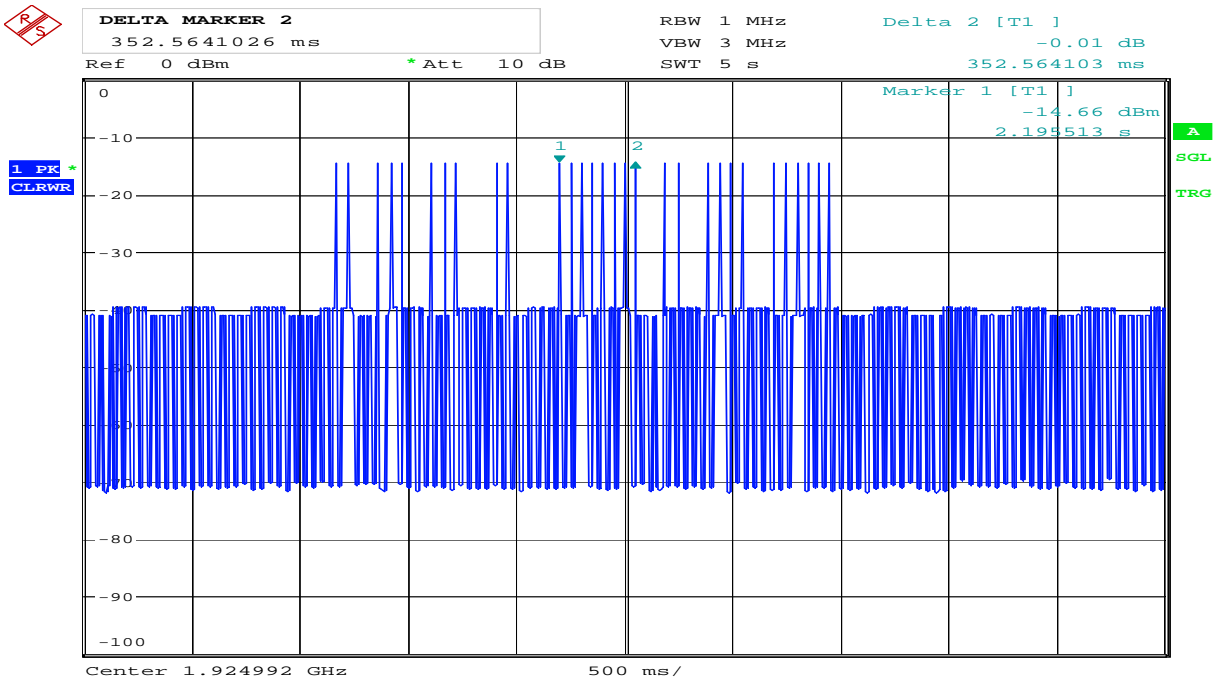

Date: 10.APR.2007 18:21:15

8.2.1a) Initial Transmission Time Without Acknowledgements

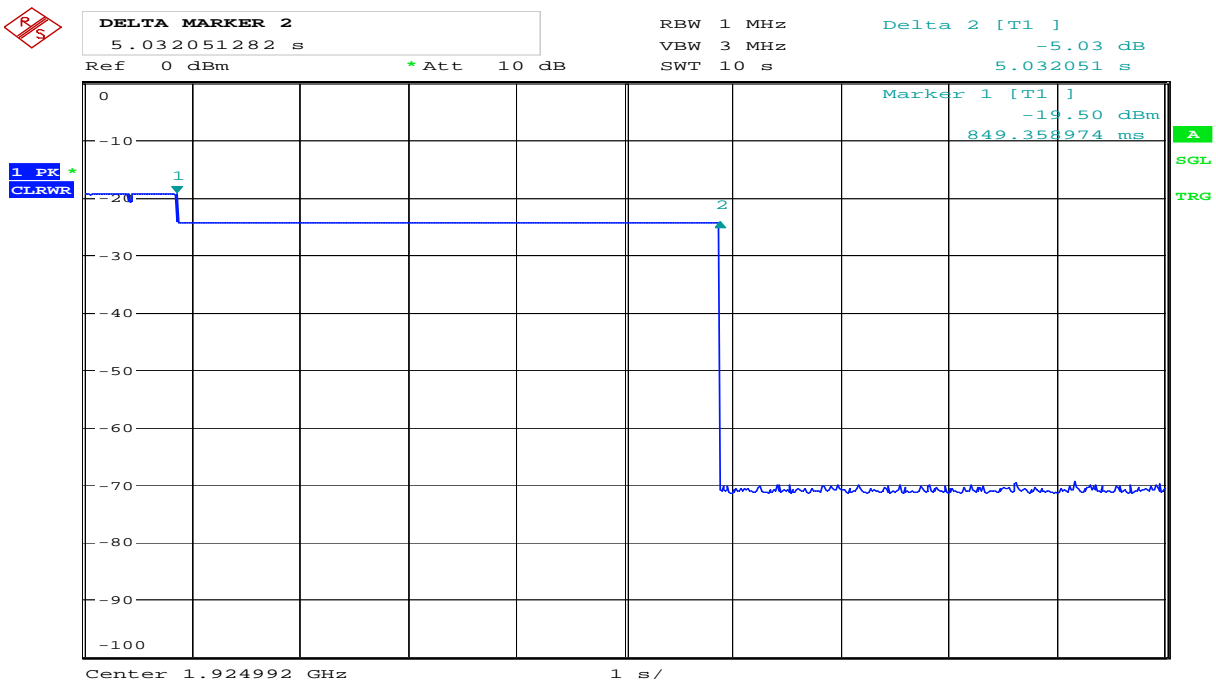

Date: 10.APR.2007 18:13:00

8.2.1c) Transmission Time After Losing Acknowledgements

4.21 Dual Access Criteria Check

Measurement Procedure:

EUTs that does not implement the Upper Threshold: ANSI C63.17, clause 8.3.1

EUTs that implement the Upper Threshold: ANSI C63.17, clause 8.3.2

This test is required for equipment that uses the access criteria in FCC 15.323(c)(10).

Test Results:

EUTs that Implements the Upper Threshold:

Test ref. to ANSI C63.17 clause 8.3.2	Observation	Verdict
b) EUT is restricted to a single carrier f_c for TDMA systems. The Test is Pass if EUT can transmit	EUT can transmit	Pass
c) d) Transmission on interference-free receive time/spectrum window	EUT transmits on interference free receive slot	Pass
e) f) Transmission on interference-free transmit time/spectrum window	EUT transmits on interference free transmit slot	Pass
g) Transmission not possible on any time/spectrum window	No connection possible	Pass

Comment: See plots.

Limits, FCC 15.323(c)(10)

An initiating device may attempt to establish a duplex connection by monitoring both its intended transmit and receive time and spectrum windows. If both the intended transmit and receive time and spectrum windows meet the access criteria, then the initiating device can initiate a transmission in the intended transmit time and spectrum window. If the power detected by the responding device can be decoded as a duplex connection signal from the initiating device, then the responding device may immediately begin transmitting on the receive time and spectrum window monitored by the initiating device.

4.22 Alternative Monitoring Interval

Test procedure described in ANSI C63.17 clause 8.4.

This test is required if the EUT implements the provisions of FCC 15.323(c)(11).

Test result:

Not Tested. The tested EUT does not implement this provision. See manufacturers' declaration.

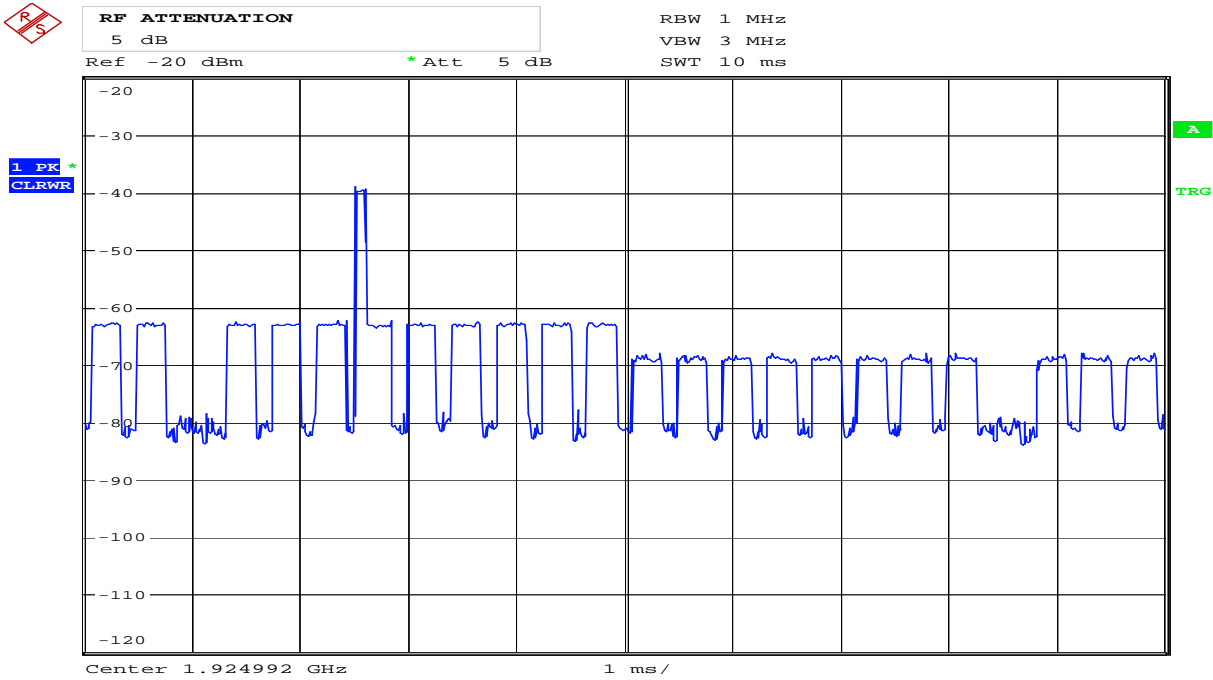

Date: 10.APR.2007 17:59:14

8.3.2c) EUT Transmits on Interference Free RECEIVE Slot, BEFORE

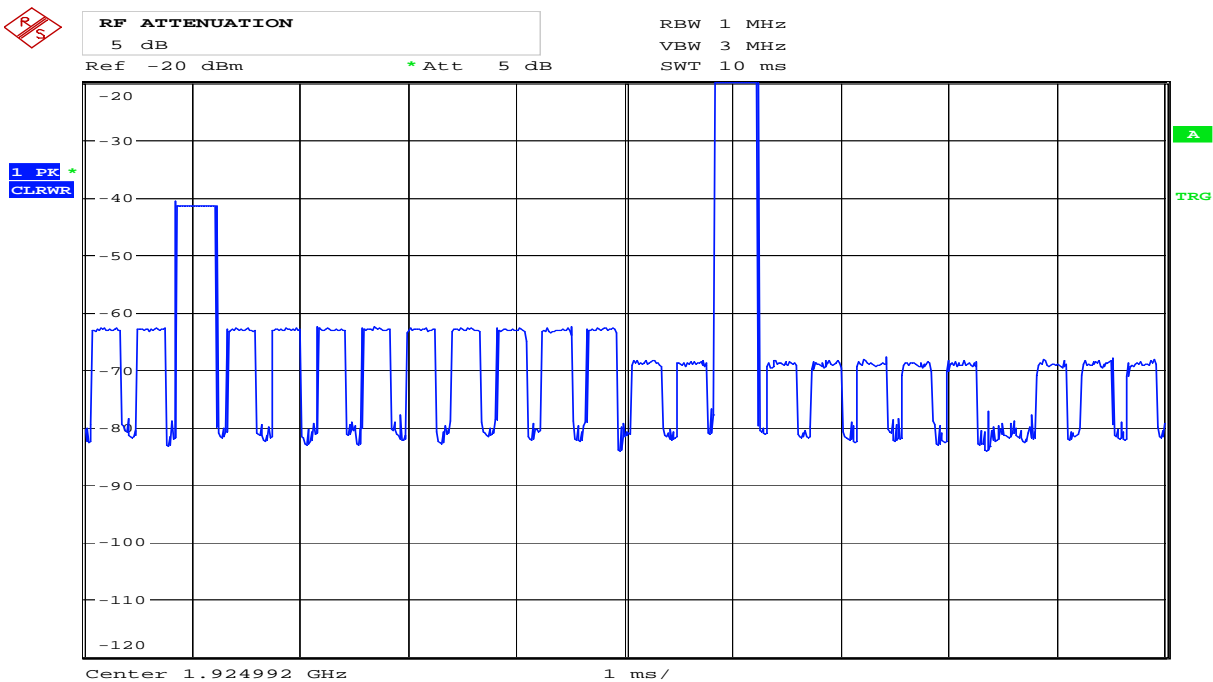

Date: 10.APR.2007 17:59:23

8.3.2c) EUT Transmits on Interference Free RECEIVE Slot, AFTER

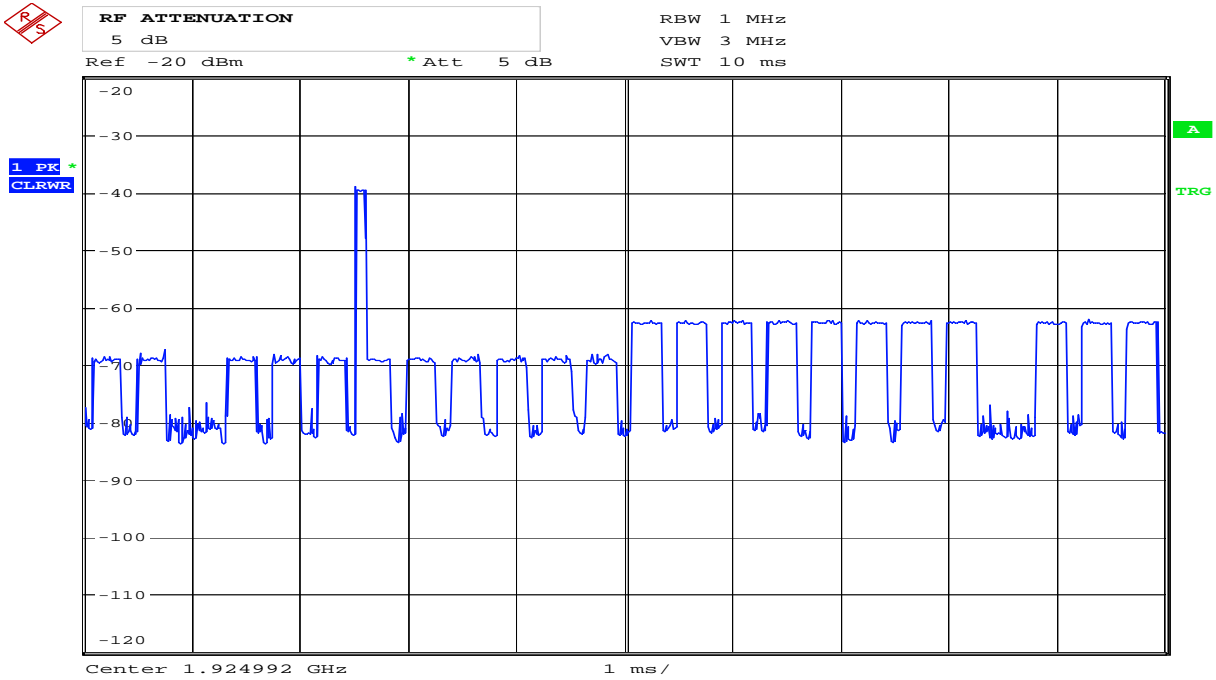

Date: 10.APR.2007 17:57:37

8.3.2e) EUT Transmits on Interference Free TRANSMIT Slot, BEFORE

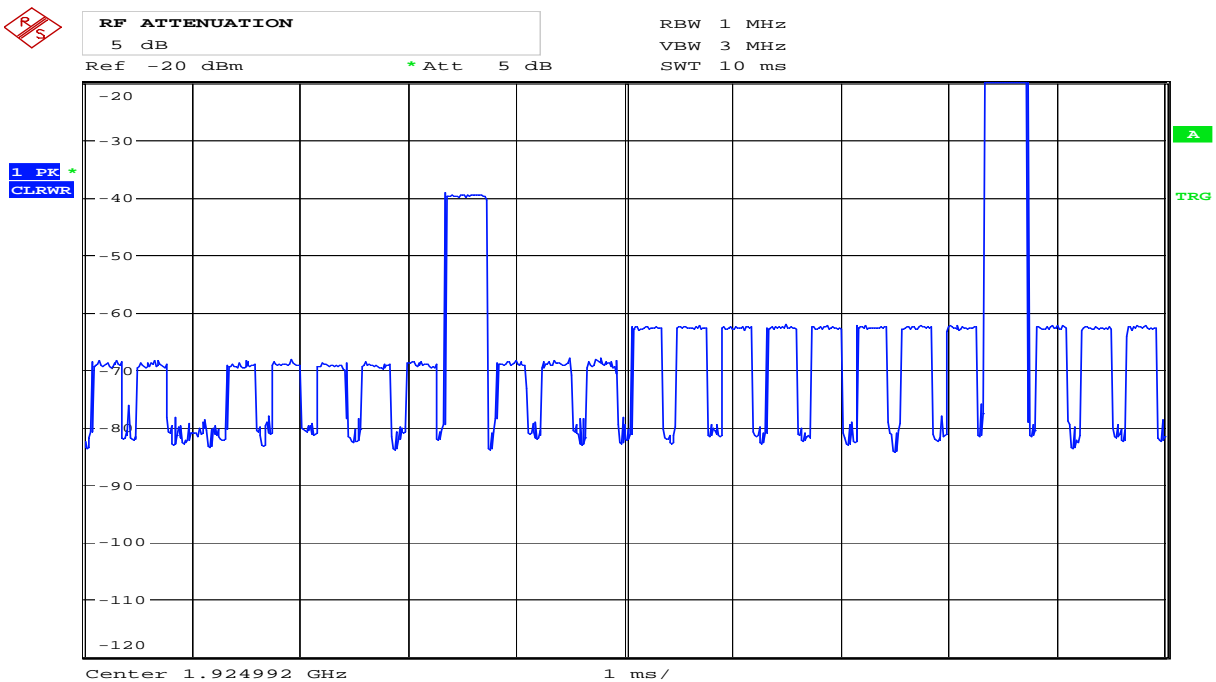

Date: 10.APR.2007 17:57:47

8.3.2e) EUT Transmits on Interference Free TRANSMIT Slot, AFTER



RF ATTENUATION
5 dB
Ref -20 dBm * Att 5 dB

RBW 1 MHz
VBW 3 MHz
SWT 10 ms

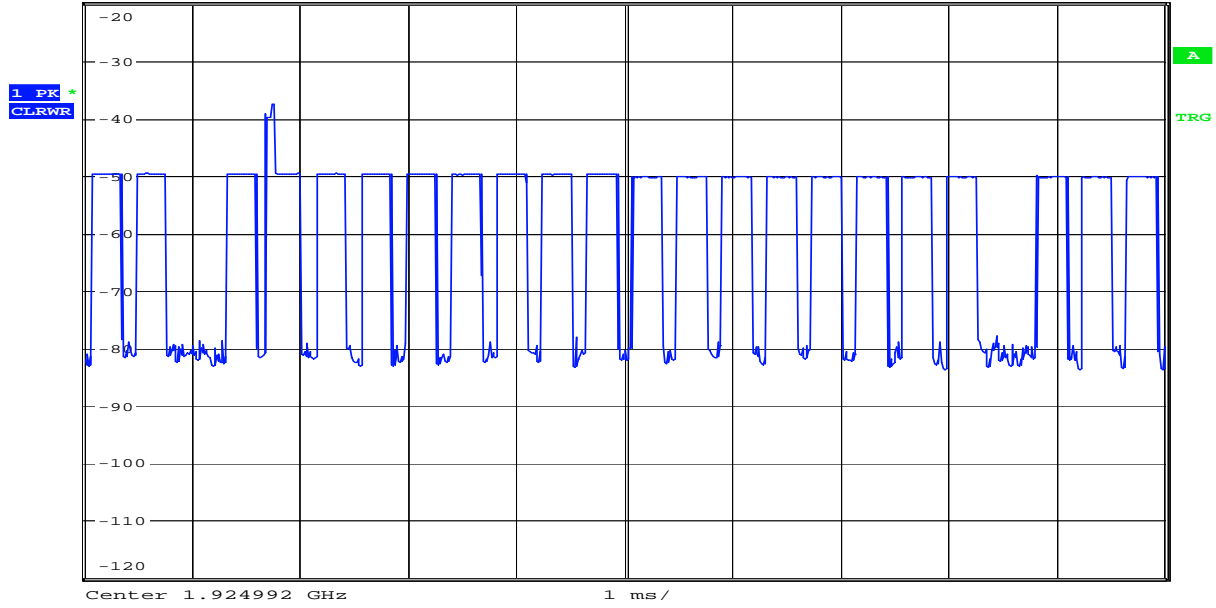

Date: 10.APR.2007 18:00:25

8.3.2g) No Connection

4.23 Duty Cycle Correction Factor Calculation

The tested EUT is a DECT handset that transmits one single timeslot per 10ms DECT system frame.

Frame length: 10ms
 Slot length: 0.393ms

Calculation of DC Correction Factor:
 $-20 \log(\text{slot length} / \text{Frame length}) = -20 \log(0.3942/10) = 28.1 \text{ dB}$

Duty Cycle Correction Factor : 20.0 dB

Max allowed Duty Cycle Correction Factor is 20 dB

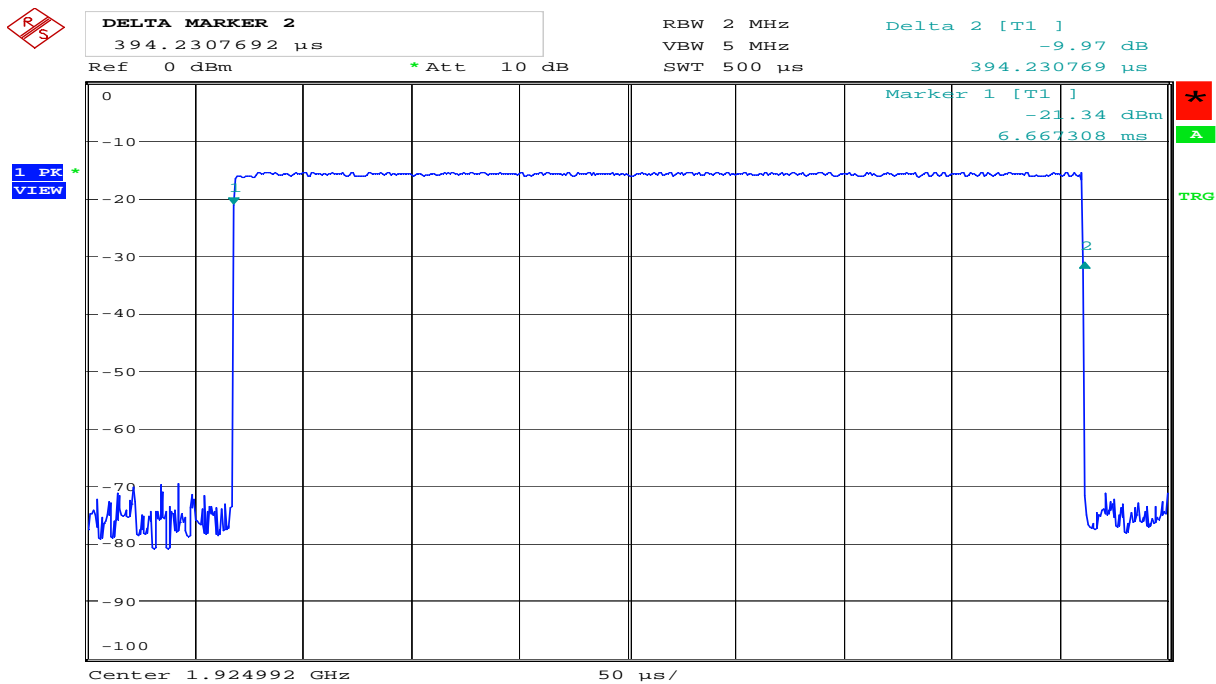

Date: 12.APR.2007 17:02:57

Slot length

4.24 Spurious Emissions (Radiated)

Measurement Procedure:

FCC 15.209

Test Results:

Radiated emissions 150 kHz-30 MHz.

Transmitter active, with charger

Measuring distance 10m, measured with Peak detector.

No component detected, see attached graph.

Limit is converted to 10m using 40 dB/decade according to 15.31 (f) (2).

Measured with transmitter active in charger, Skype Mode

Radiated Emissions 30 - 1000 MHz.

Detector: Quasi-Peak

Measuring distance 3m.

The EUT were rotated 360 degrees and the antenna height varied between 1m and 4m on all found frequencies.

Measured with transmitter active in charger, Skype Mode

Frequency MHz	RF channel	Distance correction factor dB	Field strength, 3 m dBµV/m	Limit dBµV/m	Margin dB
39.500	/	0	20.5	40	19.5
43.800	/	0	22.0	40	18.0
60.200	/	0	38.5	40	1.5
114.050	/	0	26.0	43.5	17.5
134.800	/	0	27.0	43.5	16.5
165.900	/	0	30.5	43.5	13.0
228.100	/	0	28.0	46	18.0
300.000	/	0	41.0	46	5.0
500	/	0	38.0	46	8.0
600	/	0	35.0	46	11.0
700	/	0	34.0	46	12.0
847.1	/	0	35.0	46	11.0
853.4	/	0	35.5	46	10.5

Radiated Emissions 1 - 20 GHz

Detector: Peak

Measuring distance: 1.0 – 12.0 GHz: 3m
 12.0 – 20.0 GHz: 1m

The EUT was rotated in 3 planes and emissions were checked on highest and lowest channel.

Transmitter active

Frequency	RF Channel	Distance Correction factor	Field Strength, Peak, 3 m	Duty Cycle Correction factor	Limit Average Detector	Limit Peak Detector	Margin
GHz	00 / 04	dB	dB μ V/m	dB	dB μ V/m	dB μ V/m	dB
1 - 12	00/04	0	< 60	20	54	74	>14
12 - 20	00/04	9.5	< 60	20	54	74	>14
13.45*	00/04	9.5	56.0	20	54	74	18.0

Field Strength above includes Distance Correction Factor.
 No Spurious Emissions except harmonics, were detected.
 The maximum levels and margins above include the harmonics.

*The harmonic at 13.45 GHz is not in a restricted band and is reported for information only.

Nemko Comlab
 Peak

11. Apr 07 11:10

EUT: UPCS Base and Handset
 Manuf: RTX
 Op Cond: 1m VP
 Operator: FS
 Test Spec: FCC 15.209, 3m
 Comment: Skype DECT

Scan Settings (1 Range)

Frequencies			Receiver Settings					
Start	Stop	Step	IF BW	Detector	M-Time	Atten	Preamp	OpRge
30M	200M	50k	120k	PK	50ms	AUTO	LN ON	60dB

Transducer No.	Start	Stop	Name
11	30M	200M	3104C

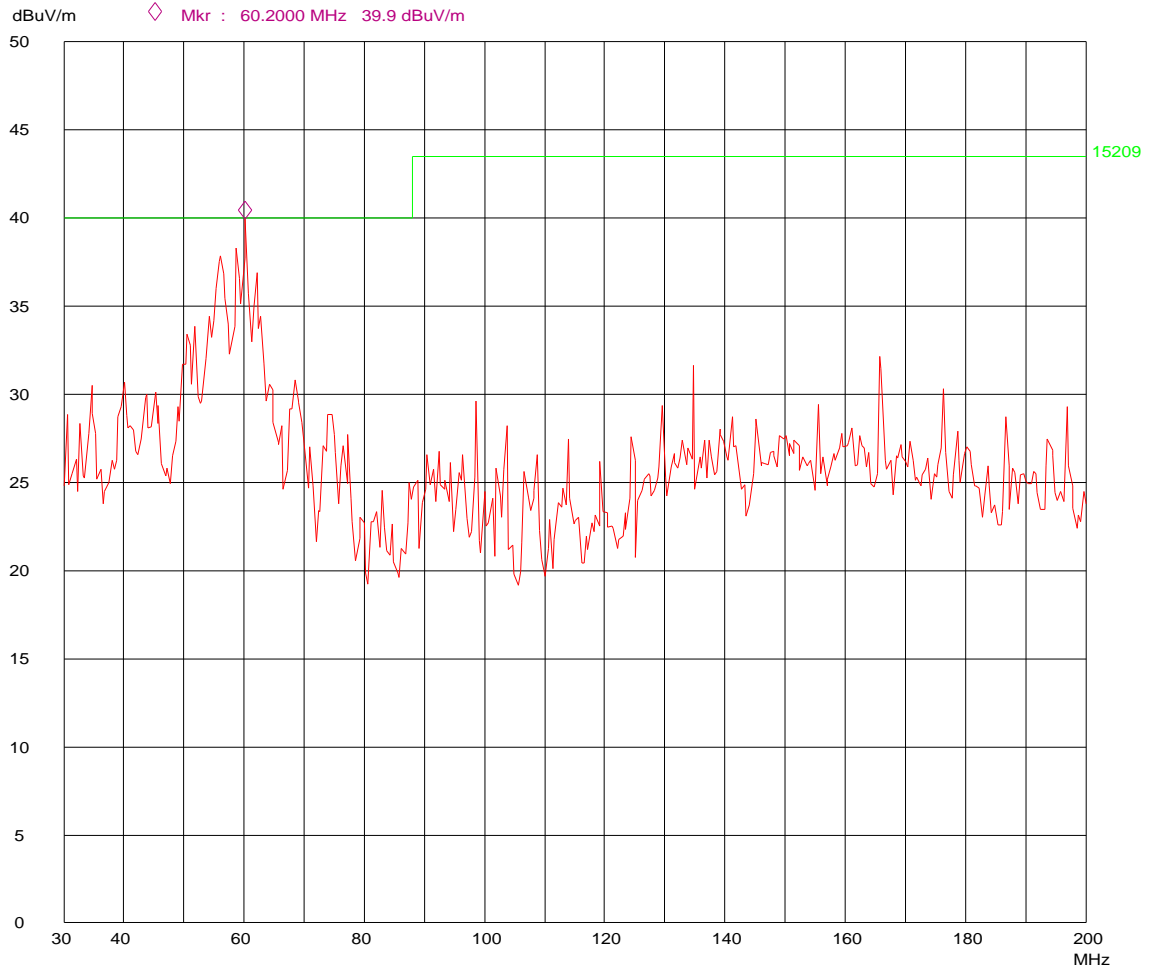

Spurious Emissions 30 – 200 MHz, Peak Detector, Vertical Polarization

Nemko Comlab
 Peak

11. Apr 07 11:26

EUT: UPCS Base and Handset
 Manuf: RTX
 Op Cond: 2m HP
 Operator: FS
 Test Spec: FCC 15.209, 3m
 Comment: Skype DECT

Scan Settings (1 Range)

Frequencies				Receiver Settings			
Start	Stop	Step	IF BW	Detector	M-Time	Atten	Preamp OpRge
30M	200M	50k	120k	PK	50ms	AUTO LN ON	60dB

Transducer No.	Start	Stop	Name
11	30M	200M	3104C

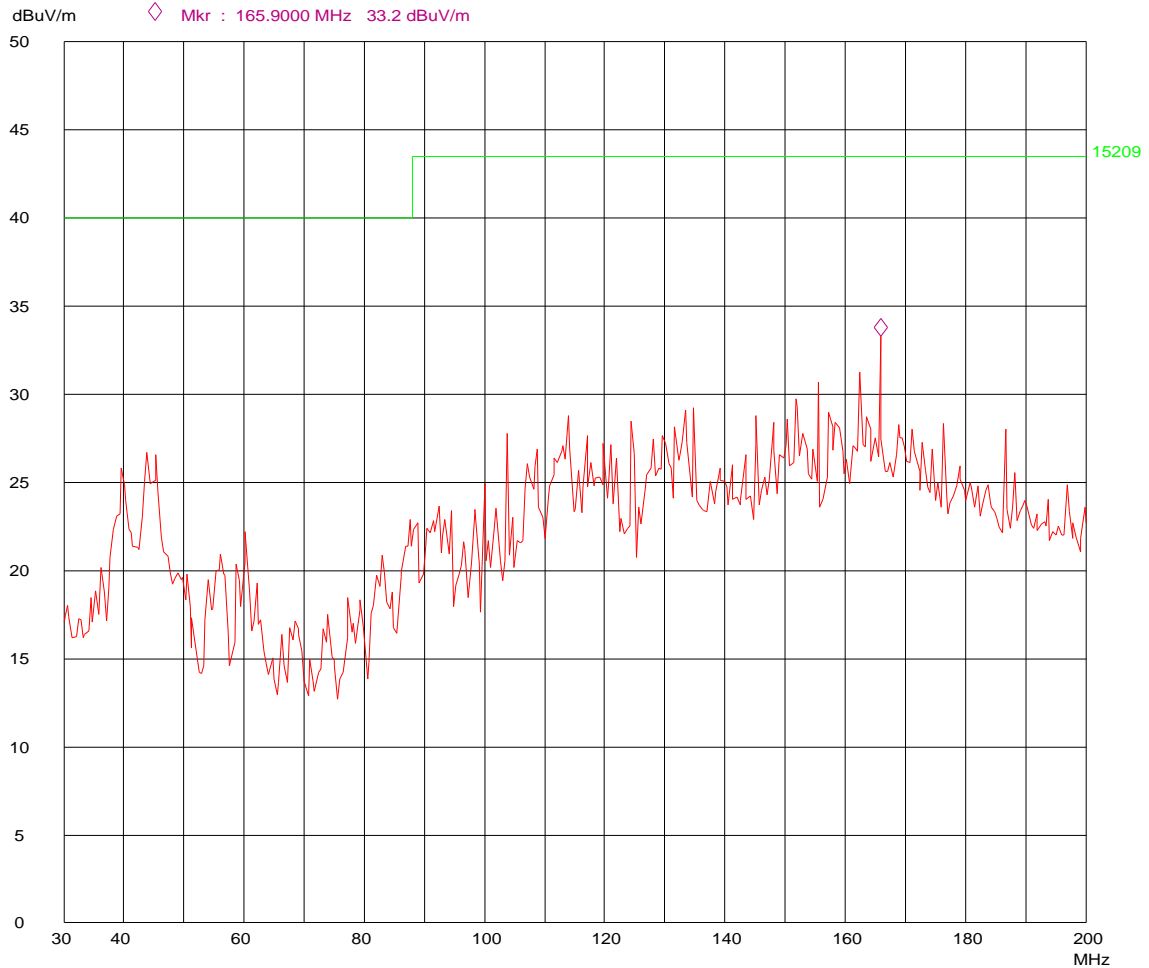

Spurious Emissions 30 – 200 MHz, Peak Detector, Horizontal Polarization

Nemko Comlab
 Peak

11. Apr 07 09:54

EUT: UPCS Base and Handset
 Manuf: RTX
 Op Cond: 1m VP
 Operator: FS
 Test Spec: FCC 15.209, 3m
 Comment: Skype DECT

Scan Settings (1 Range)

Frequencies				Receiver Settings			
Start	Stop	Step	IF BW	Detector	M-Time	Atten	Preamp OpRge
200M	1000M	50k	120k	PK	50ms	AUTO LN ON	60dB

Transducer No.	Start	Stop	Name
21	200M	1000M	HL223

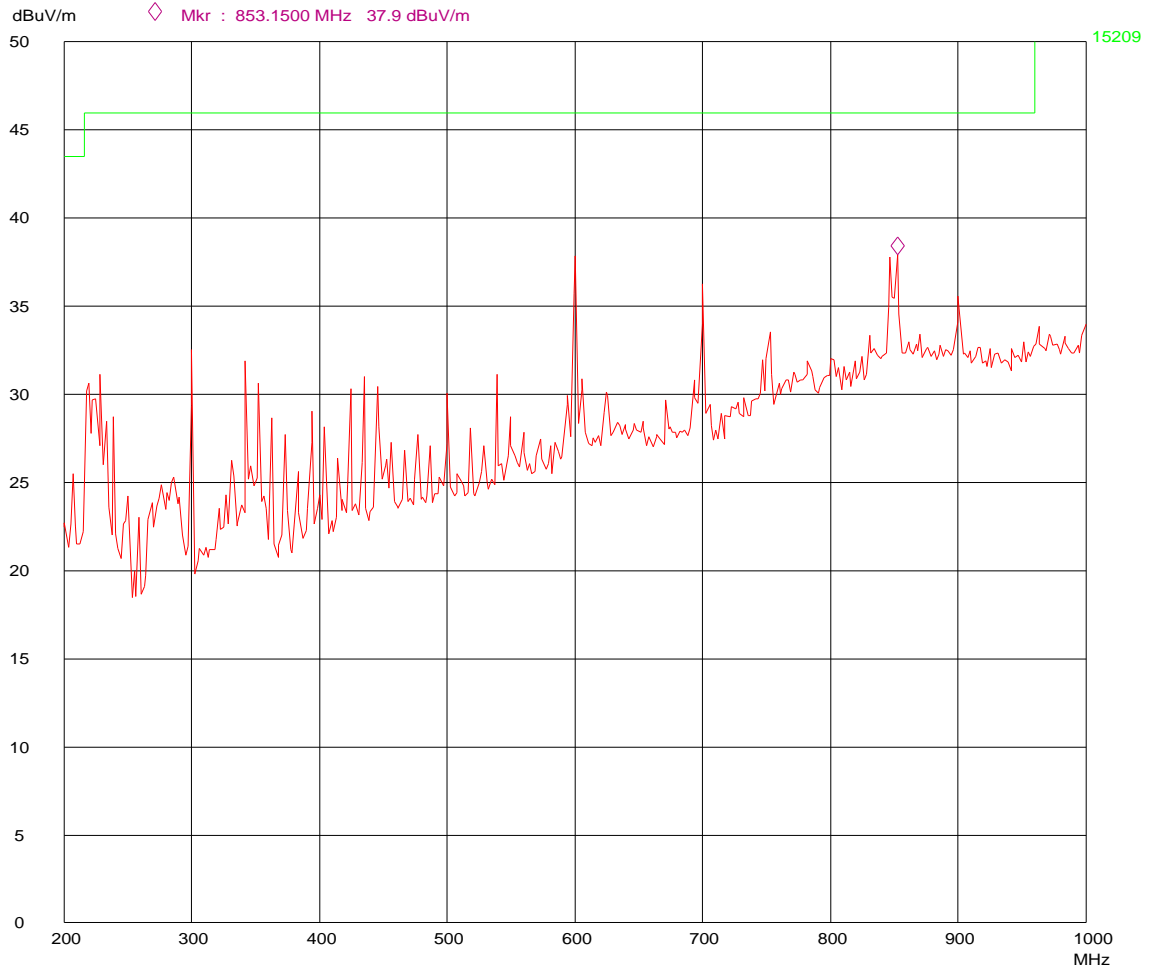

Spurious Emissions 200 - 1000 MHz, Peak Detector, Vertical Polarization

Nemko Comlab
Peak

11. Apr 07 10:26

EUT: UPCS Base and Handset
 Manuf: RTX
 Op Cond: 2m HP
 Operator: FS
 Test Spec: FCC 15.209, 3m
 Comment: Skype DECT

Scan Settings (1 Range)

Frequencies				Receiver Settings			
Start	Stop	Step	IF BW	Detector	M-Time	Atten	Preamp OpRge
200M	1000M	50k	120k	PK	50ms	AUTO LN	ON 60dB

Transducer No.	Start	Stop	Name
21	200M	1000M	HL223

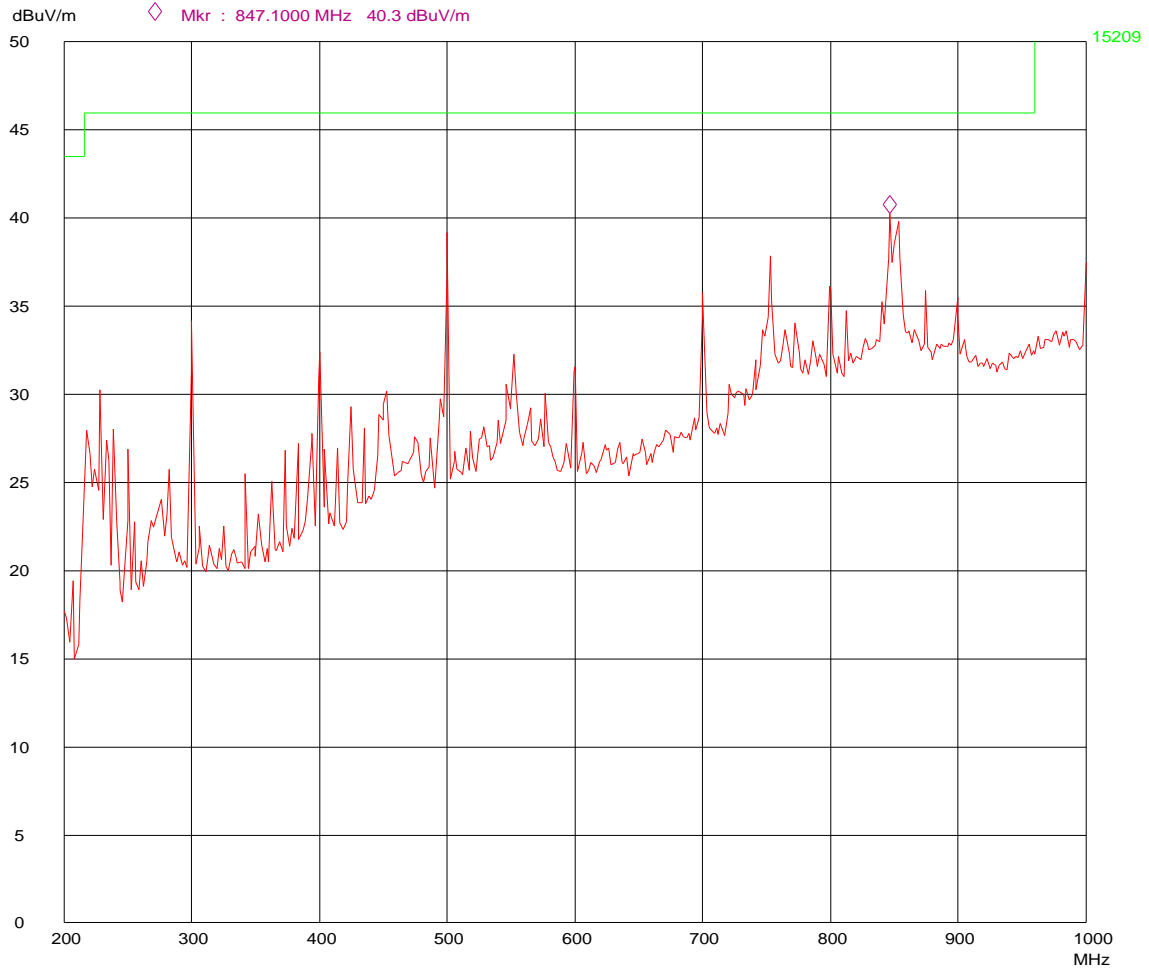

Spurious Emissions 200 - 1000 MHz, Peak Detector, Horizontal Polarization

NEMKO COMLAB

16. Apr 07 15:50

Peak

Operator: FS
 Comment: Skype DECT Base and Handset
 RTX Telecom
 FCC 15.209, 10m
 Skype Call Active, Handset in Charger

Scan Settings (1 Range)

Frequencies			Receiver Settings					
Start	Stop	Step	IF BW	Detector	M-Time	Atten	Preamp	OpRge
150k	30M	4.5k	9k	PK	50ms	AUTO	LN OFF	60dB

Transducer No.	Start	Stop	Name
13	10k	30M	HFH2Z2

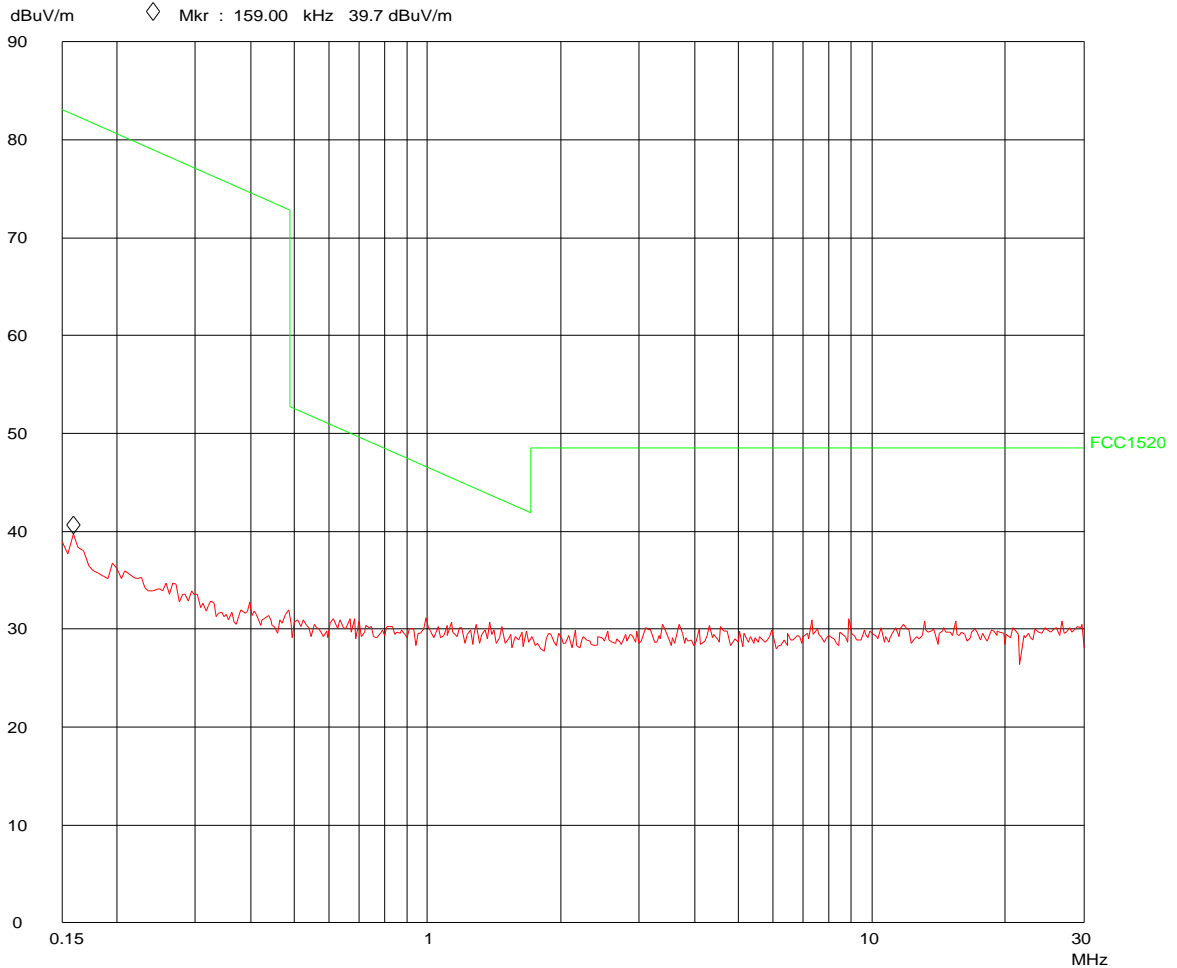

Spurious Emissions 0.15 - 30 MHz, Peak Detector



Ref Lvl 97 dB*
 Marker 1 [T1] 55.60 dB μ V/m
 8.18036072 GHz
 RBW 1 MHz RF Att 0 dB
 VBW 1 MHz
 SWT 32 ms Unit dB μ V/m

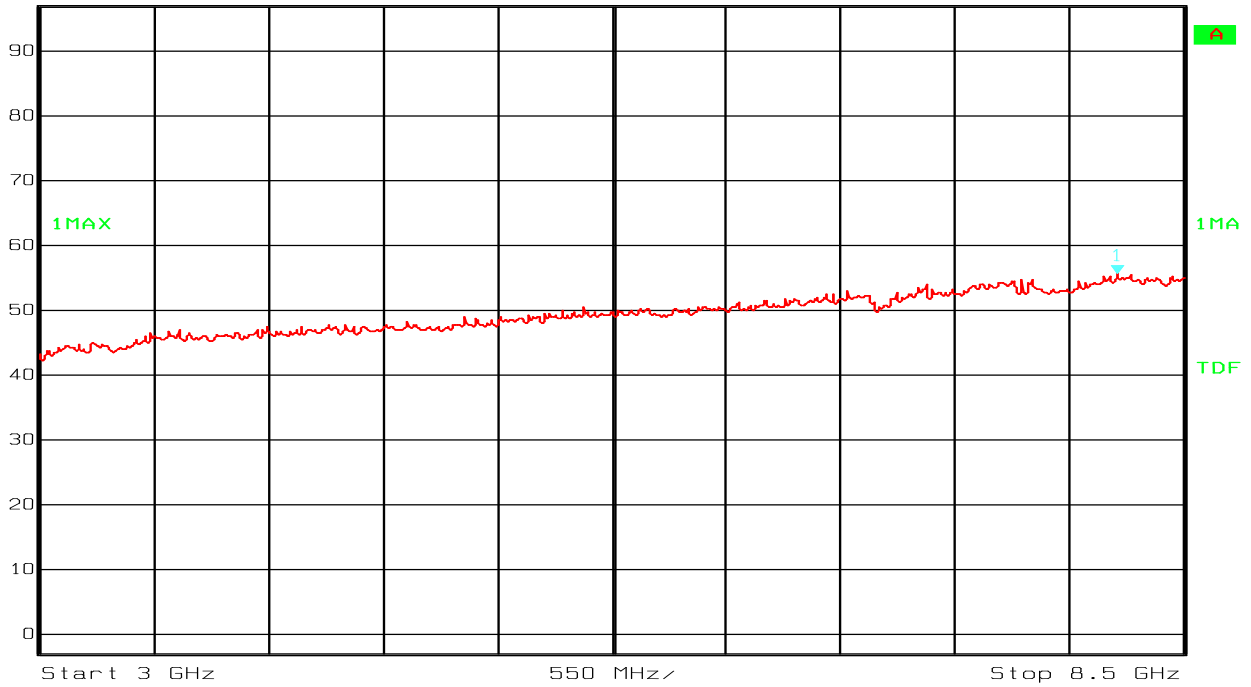

Date: 11.APR.2007 16:05:41

Spurious Emissions 3 – 8.5 GHz (Max: EUT V, HP)



Ref Lvl 97 dB*
 Marker 1 [T1] 56.27 dB μ V/m
 11.73346693 GHz
 RBW 1 MHz RF Att 0 dB
 VBW 1 MHz
 SWT 20 ms Unit dB μ V/m

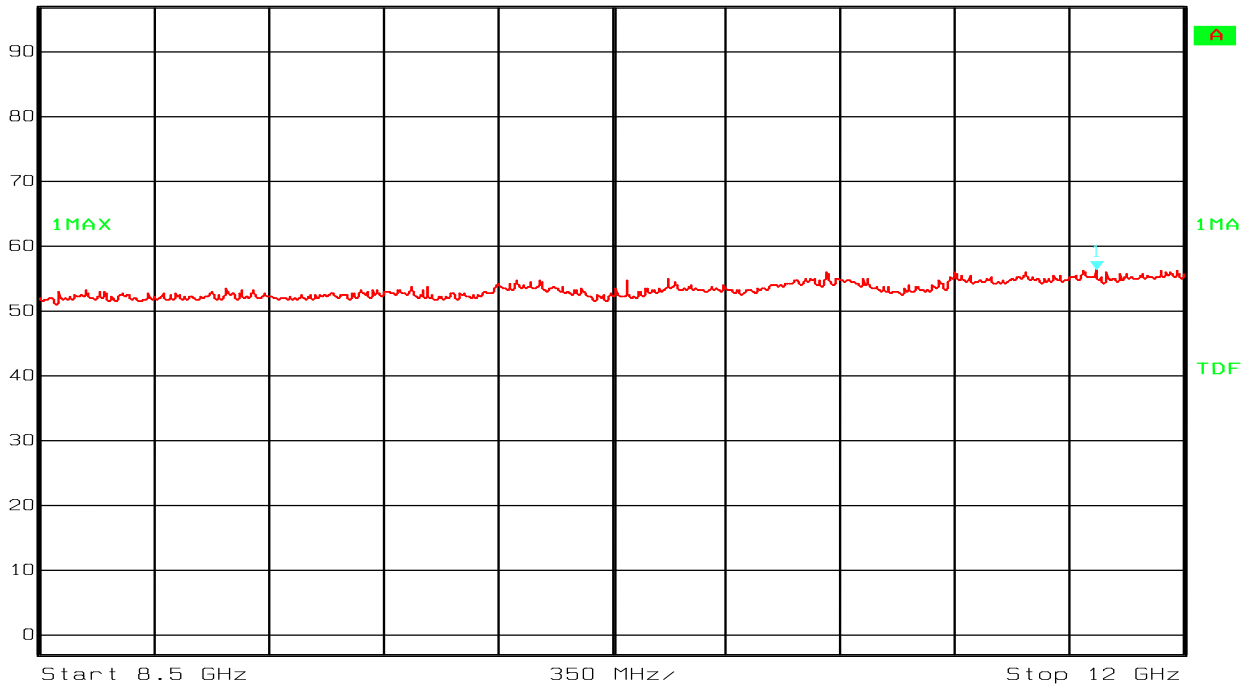

Date: 11.APR.2007 15:52:52

Spurious Emissions 8.5 – 12 GHz (Max: EUT V, HP)

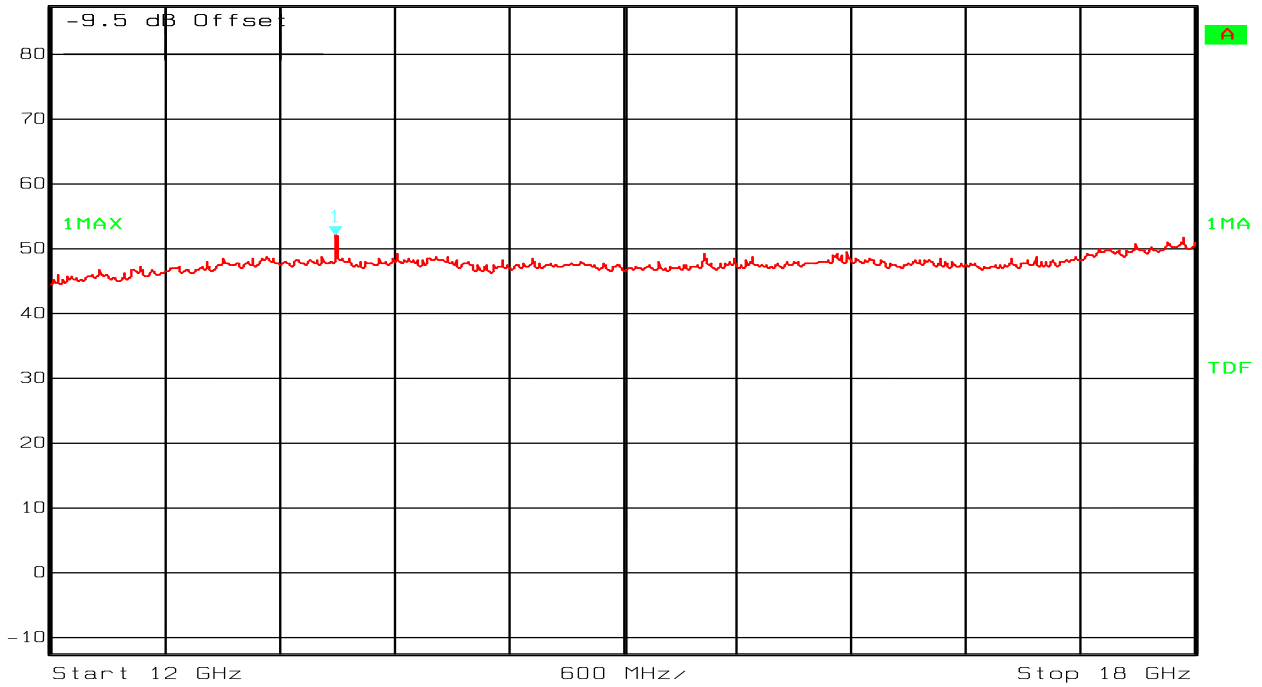

 Ref Lvl 87.5 dB*
 Marker 1 [T1] 52.13 dB μ V/m
 13.49098196 GHz
 RBW 1 MHz
 VBW 1 MHz
 SWT 34 ms
 RF Att 0 dB
 Unit dB μ V/m



Date: 11.APR.2007 15:26:12

Spurious Emissions 12 – 18 GHz (Max: EUT V, HP)

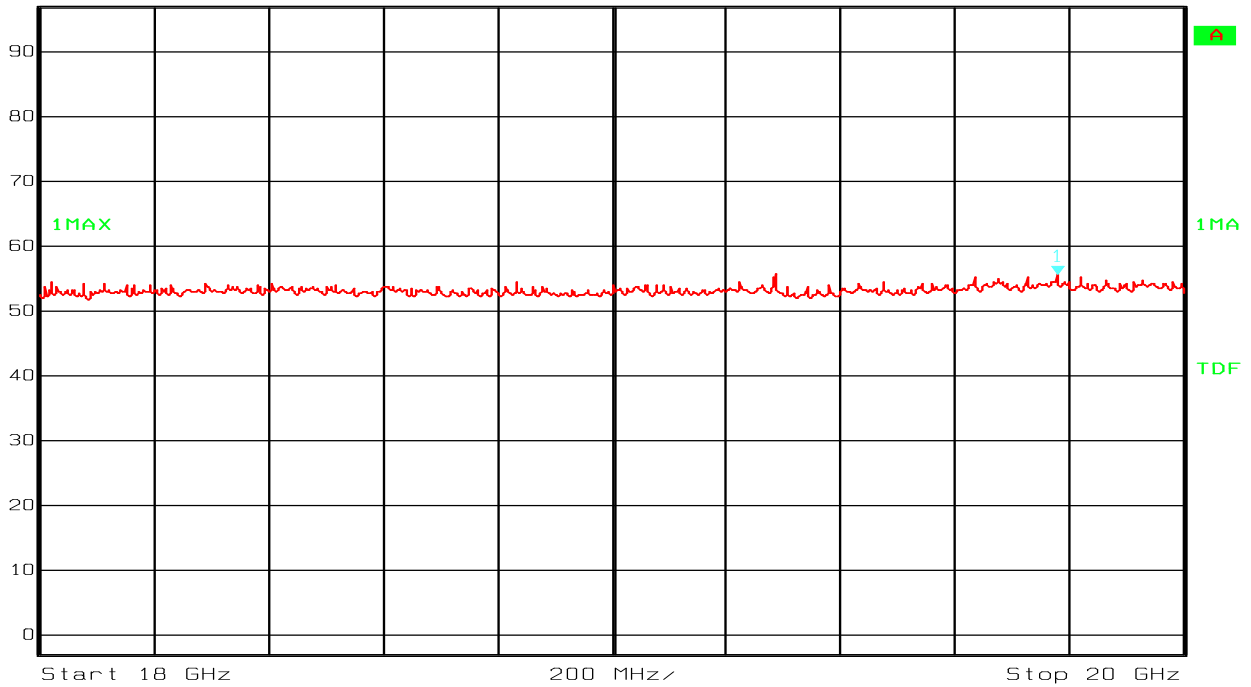
 Ref Lvl 97 dB*
 Marker 1 [T1] 55.64 dB μ V/m
 19.77955912 GHz
 RBW 1 MHz
 VBW 1 MHz
 SWT 11.5 ms
 RF Att 10 dB
 Unit dB μ V/m



Date: 16.APR.2007 15:31:10

Spurious Emissions 18 – 20 GHz (Max: EUT V, VP)



Ref Lvl 87.5 dB* Marker 1 [T1] RBW 1 MHz RF Att 0 dB
 55.95 dB μ V/m VBW 1 MHz
 13.50090180 GHz SWT 5 ms Unit dB μ V/m

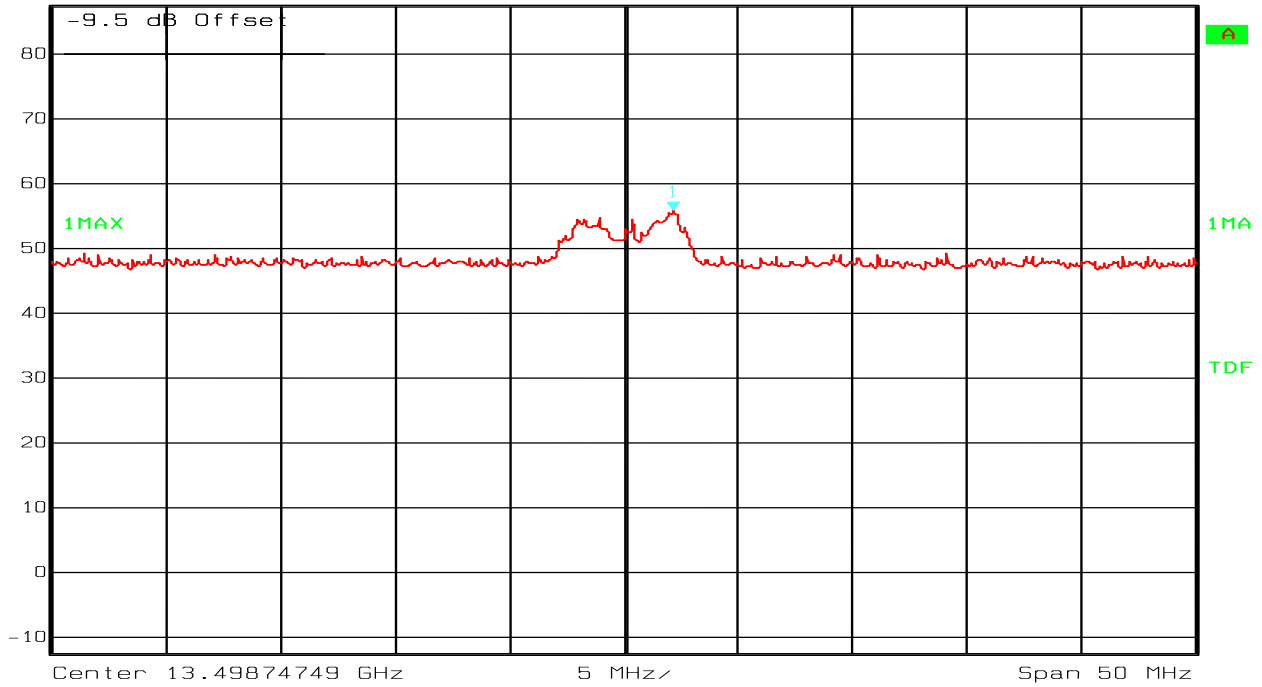

Date: 11.APR.2007 15:33:12

Spurious Emissions, 7th Harmonic 13.5GHz (Max: EUT V, HP)

4.25 Receiver Spurious Emissions

Measurement Procedure:

Industry Canada RSS-213 paragraph 6.8 and RSS-GEN paragraphs 4.8 and 6.

Test results:

The Receiver Spurious Emissions are covered by paragraph 4.23 Spurious Emissions Radiated. No separate Spurious Emissions which could be related to the receiver were detected during the radiated test.

5 Test Setups

5.1 Frequency Measurements



Test equipment included: 5, 30

Test Set-up 1

This setup is used for measuring Carrier frequency stability at normal and extreme temperatures.

The EUT was in loopback-mode and was controlled with the CMD60 for this test. The modulation pattern was set to 01010101...

5.2 Timing Measurements

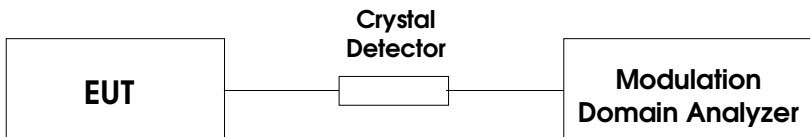

Test equipment included: 5, 7, 30

Test Set-up 2

This setup is used for measuring Frame repetition stability, Frame period and Jitter.

The EUT was in loopback-mode and was controlled with the CMD60 for this test. The modulation pattern was set to 01010101...

5.3 Conducted Emission Test

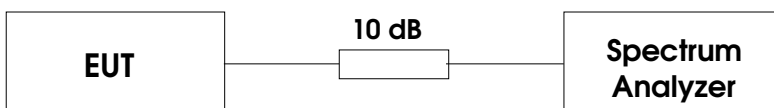

Test equipment included: 1, 13, 29, 30

Test Set-up 3

This setup is used for all conducted emission tests.

The EUT was in loopback-mode and was controlled with the CMD60 for this test. The modulation pattern was set to Pseudo-Random bit sequence to simulate normal speech.

5.4 Radiated Emissions Test

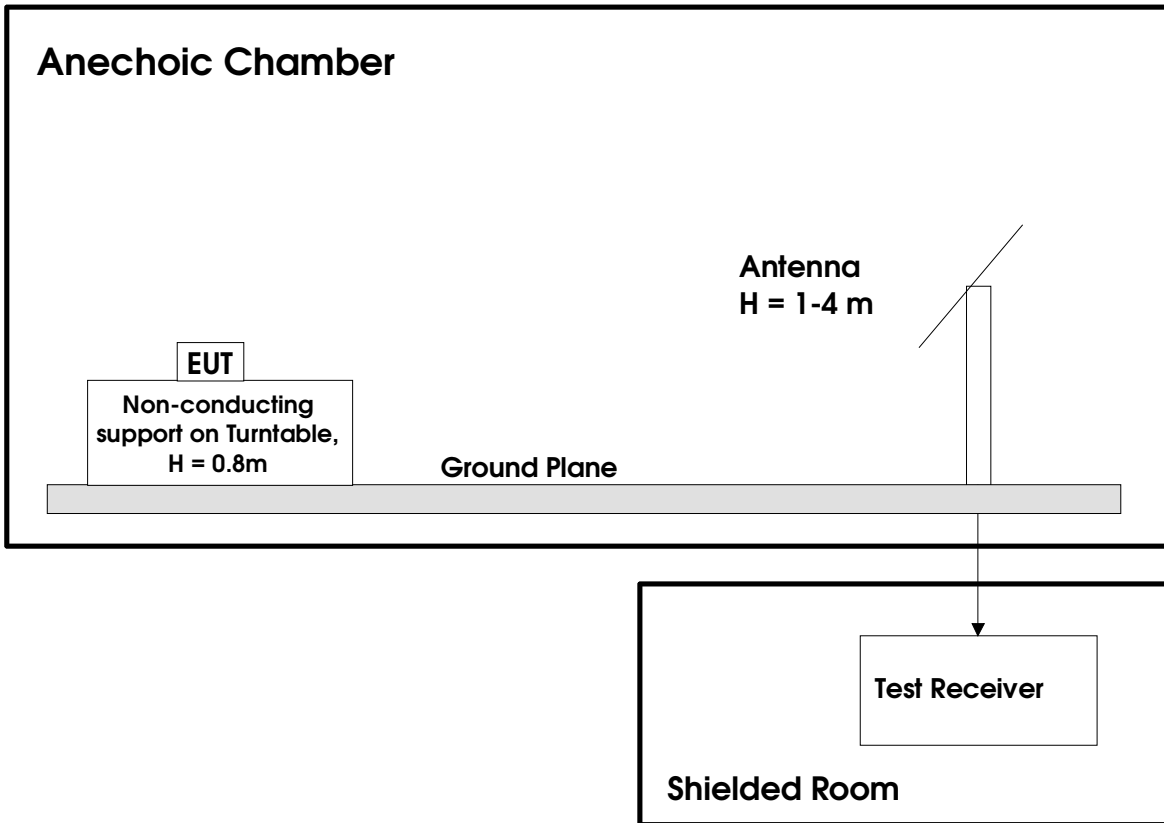

Test equipment: 1, 8, 9, 10, 11, 20, 21, 22, 23, 24, 25, 26

Test Set-Up 4

This test setup is used for all radiated emissions tests. For frequencies below 30 MHz the measuring distance is 10 m, for all other frequencies it is 3m or 1m. Emissions above 1 GHz were measured with a Spectrum Analyzer and Horn Antenna and with the preamplifier after the antenna. For measurements above 18 GHz the test receiver is moved inside the anechoic chamber and located next to the antenna to minimize the cable loss.

5.5 Power Line Conducted Emissions Test

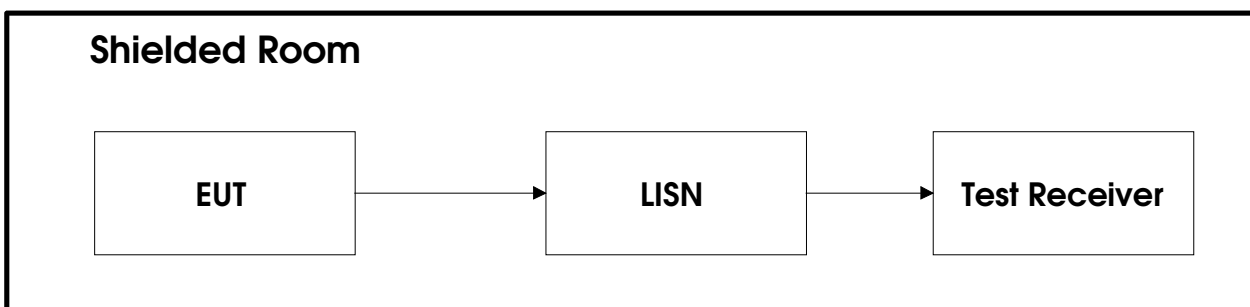

Test equipment: 12, 27, 28

Test Set-Up 5

5.6 Monitoring Tests

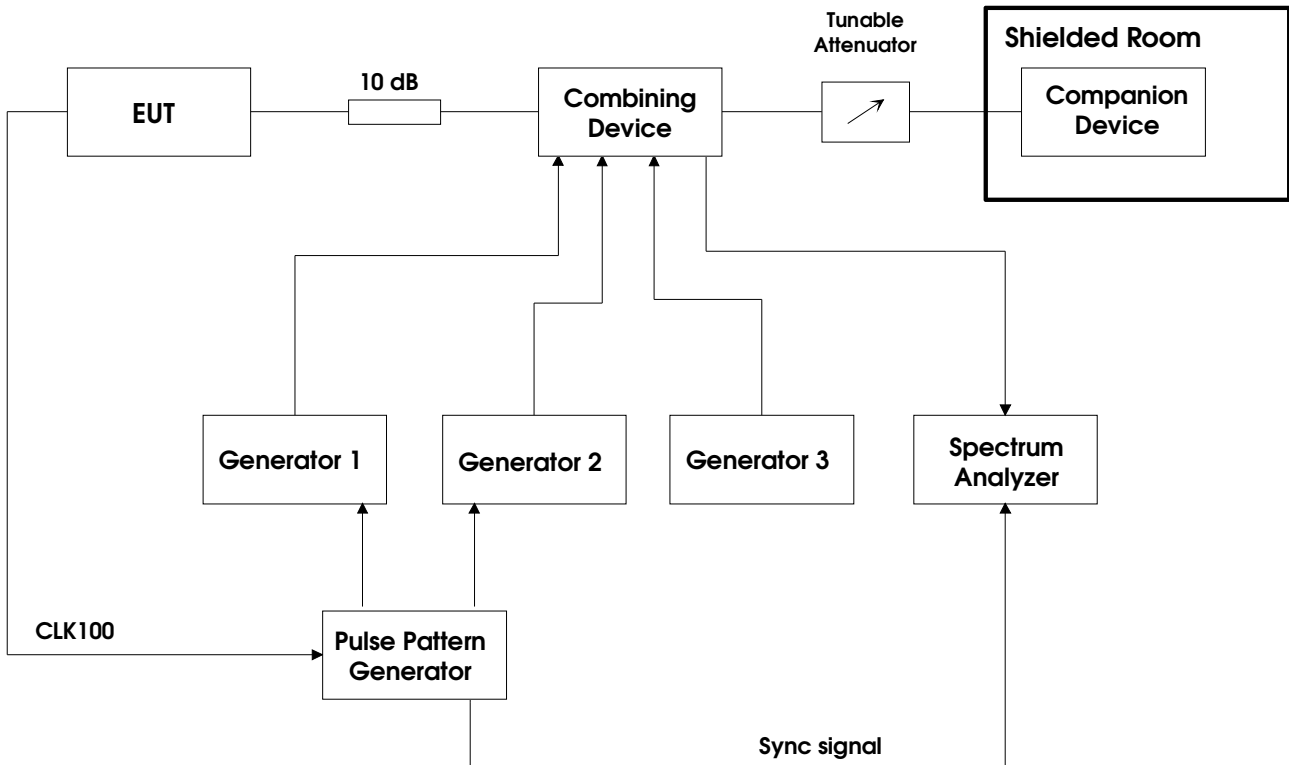

Test equipment: 1, 2, 3, 4, 6, 13, 14, 15, 16, 17, 18, 19, 29

Test Set-Up 6

This test setup is used for all Monitoring and Time and Spectrum Access Procedure tests. The path loss from the signal generators to the EUT is measured with a power meter before the testing is started.

The CLK100 is used to synchronize the Pulse-/ Pattern generator to the start of the DECT frame, this signal always comes from the base station. If the EUT is a DECT Portable Part (i.e. a handset) the CLK100 signal will come from the Companion Device.

The sync signal to the Spectrum Analyzer is the CLK100 signal that is regenerated in the Pulse-/ Pattern Generator, this is used to synchronize the Spectrum Analyzer to the DECT frame when in zero span. The Pulse-/ Pattern Generator is used for tests that require time synchronized pulses or blocking of specific time slots.

6 Test Equipment Used

To facilitate inclusion on each page of the test equipment used for related tests, each item of test equipment and ancillaries are identified (numbered) by the Testhouse.

No.	Instrument/ancillary	Type of instrument/ancillary	Manufacturer	Ref. no.
1	FSEK30	Spectrum Analyzer	Rohde & Schwarz	LR 1337
2	SME03	Signal generator	Rohde & Schwarz	LR 1238
3	SMP04	Signal generator	Rohde & Schwarz	LR 1336
4	SMHU52	Signal generator	Rohde & Schwarz	LR 1240
5	53310A	Modulation Domain Analyzer	Hewlett Packard	LR 1483
6	81104A	Pulse-/ Pattern Generator	Agilent	LR 1502
7	8470B	Crystal Detector	Hewlett Packard	LR 1207
8	8449B	Preamplifier	Hewlett Packard	LR 1322
9	4HC3000/18000	High-pass filter	Trilithic	S.No.: 9849045
10	ESVS30	Measuring Receiver	Rohde & Schwarz	LR 1101
11	ESN	Measuring Receiver	Rohde & Schwarz	LR 1237
12	ESAI	Measuring Receiver	Rohde & Schwarz	LR 1090
13	6810.17B	Attenuator	Narda	LR1212
14	745-69	Step Attenuator	Narda	LR 1442
15	WE 1506A	Power Splitter	Weinchel	LR 244
16	WE 1506A	Power Splitter	Weinchel	LR 245
17	H-9	Hybrid	Anzac	LR 86
18	H-9	Hybrid	Anzac	LR 257
19	S212DS	RF Switch	Narda	LR 1244
20	3115	Horn Antenna	EMCO	LR 1226
21	PM7320-X	Horn Antenna	Sivers Lab	LR 102
22	DBF-520-20	Horn Antenna	Systron Donner	LR 100
23	638	Horn Antenna	Narda	LR 1480
24	DB 3104C	Biconical Antenna	EMCO	LR
25	HL223	Log-period Antenna	Rohde & Schwarz	LR
26	HFH2-Z2	Loop Antenna	Rohde & Schwarz	LR 285
27	ESH3-Z5	Two Line V-Network	Rohde & Schwarz	LR 1076
28	80S	Signal Generator	Powertron	LT 502
29	FSU26	Spectrum Analyzer	Rohde & Schwarz	LR 1504
30	CMD60	DECT tester	Rohde & Schwarz	