

Intermec Technologies Corporation

Model: 1000CP01C

Evaluated to the following SAR Specifications:

FCC 2.1093: 2011
Health Safety Code 6:2009

Report No. INMC0683

Report Prepared By



www.nwemc.com
1-888-EMI-CERT

© 2011 Northwest EMC, Inc

SAR Evaluation Report

Certificate of Evaluation
Last Date of Test: February 20, 2011
Intermec Technologies Corporation
Model: 1000CP01C

Applicable Standards			
Test Description	Specification	Test Method	Pass/Fail
SAR Evaluation	FCC 2.1093:2011	FCC OET 65C:2001	Pass
		IEEE Std 1528:2003	
		FCC KDB 447498 D01 v04	
		FCC KDB 941225 D01 v02	
	FCC KDB 648474 D01 v01r05	Pass	
Health Safety Code 6:2009	RSS-102, Issue 4:2010		

Highest SAR Values				
Frequency Band	Head 1g (W/kg)	Body 1g (W/kg)	Limit 1g (W/kg)	Exposure Environment
Cellular	0.482	0.505	1.6	General Population Uncontrolled
PCS	0.379	1.100		

Modifications made to the product
 See the Modifications section of this report

Test Facility

The measurement facility used to collect the data is located at:

Northwest EMC, Inc.
 22975 NW Evergreen Parkway, Suite 400
 Hillsboro, OR 97124

Phone: (503) 844-4066 Fax: 844-3826

Approved By:

 Don Facteau, IS Manager



NVLAP Lab Code: 200630-0

This report must not be used to claim product certification, approval, or endorsement by NVLAP, NIST, or any agency of the federal government of the United States of America.

Product compliance is the responsibility of the client, therefore the tests and equipment modes of operation represented in this report were agreed upon by the client, prior to testing. This Report may only be duplicated in its entirety. The results of this test pertain only to the sample(s) tested. The specific description is noted in each of the individual sections of the test report supporting this certificate of test.

Revision Number	Description	Date	Page Number
00	None		

Barometric Pressure

The recorded barometric pressure has been normalized to sea level.



Accreditations and Authorizations

FCC

Accredited by NVLAP for performance of FCC radio, digital, and ISM device testing. Our Open Area Test Sites, certification chambers, and conducted measurement facilities have been fully described in reports filed with the FCC and accepted by the FCC in letters maintained in our files. Northwest EMC has been accredited by ANSI to ISO / IEC Guide 65 as a product certifier. We have been designated by the FCC as a Telecommunications Certification Body (TCB). This allows Northwest EMC to certify transmitters to FCC specifications in accordance with 47 CFR 2.960 and 2.962.

NVLAP

Northwest EMC, Inc. is accredited under the National Voluntary Laboratory Accreditation Program (NVLAP) for satisfactory compliance with the requirements of ISO/IEC 17025 for Testing Laboratories. NVLAP is administered by the National Institute of Standards and Technology (NIST), an agency of the U.S. Commerce Department. The NVLAP accreditation encompasses Electromagnetic Compatibility Testing in accordance with the European Union EMC Directive 2004/108/EC, and ANSI C63.4. Additionally, Northwest EMC is accredited by NVLAP to perform radio testing in accordance with the European Union R&TTE Directive 1999/5/EEC, the requirements of FCC, and the RSS radio standards for Industry Canada.

Industry Canada

Accredited by NVLAP for performance of Industry Canada RSS and ICES testing. Our Open Area Test Sites and certification chambers comply with RSS-Gen, Issue 2 and have been filed with Industry Canada and accepted. Northwest EMC has been accredited by ANSI to ISO / IEC Guide 65 as a product certifier. We have been designated by NIST and recognized by Industry Canada as a Certification Body (CB) per the APEC Mutual Recognition Arrangement (MRA). This allows Northwest EMC to certify transmitters to Industry Canada technical requirements. (*Site Filing Numbers - Hillsboro: 2834D-1, 2834D-2, Sultan: 2834C-1, Irvine: 2834B-1, 2834B-2, Brooklyn Park: 2834E-1*)

CAB

Designated by NIST and validated by the European Commission as a Conformity Assessment Body (CAB) to conduct tests and approve products to the EMC directive and transmitters to the R&TTE directive, as described in the U.S. - EU Mutual Recognition Agreement.

Australia/New Zealand

The National Association of Testing Authorities (NATA), Australia has been appointed by the ACA as an accreditation body to accredit test laboratories and competent bodies for EMC standards. Accredited test reports or assessments by competent bodies must carry the NATA logo. Test reports made by an overseas laboratory that has been accredited for the relevant standards by an overseas accreditation body that has a Mutual Recognition Agreement (MRA) with NATA are also accepted as technical grounds for product conformity. The report should be endorsed with the respective logo of the accreditation body (NVLAP).



Accreditations and Authorizations

VCCI

Accepted as an Associate Member to the VCCI, Acceptance No. 564. Conducted and radiated measurement facilities have been registered in accordance with Regulations for Voluntary Control Measures, Article 8. (*Registration Numbers. - Hillsboro: C-1071, R-1025, G-84, C-2687, T-1658, and R-2318, Irvine: R-1943, G-85, C-2766, and T-1659, Sultan: R-871, G-83, C-1784, and T-1511, Brooklyn Park: R-3125, G-86, G-141, C-3464, and T-1634.*)

BSMI

Northwest EMC has been designated by NIST and validated by C-Taipei (BSMI) as a CAB to conduct tests as described in the APEC Mutual Recognition Agreement (US0017).

GOST

Northwest EMC, Inc. has been assessed and accredited by the Russian Certification bodies Certinform VNIINMASH, CERTINFO, SAMTES, and Federal CHEC, to perform EMC and Hygienic testing for Information Technology Products. As a result of their laboratory assessment, they will accept test results from Northwest EMC, Inc. for product certification

KCC

Northwest EMC, Inc is a CAB designated by MRA partners and recognized by Korea. (*Assigned Lab Numbers: Hillsboro: US0017, Irvine: US0158, Sultan: US0157, Brooklyn Park: US0175*)

VIETNAM

Vietnam MIC has approved Northwest EMC as an accredited test lab. Per Decision No. 194/QD-QLCL (dated December 15, 2009), Northwest EMC test reports can be used for Vietnam approval submissions.

SCOPE

For details on the Scopes of our Accreditations, please visit:

<http://www.nwemc.com/accreditations/>



Northwest EMC Locations



Oregon
Labs EV01-EV12
22975 NW Evergreen Pkwy
Suite 400
Hillsboro, OR 97124
(503) 844-4066

California
Labs OC01-OC13
41 Tesla
Irvine, CA 92618
(949) 861-8918

Minnesota
Labs MN01-MN08
9349 W Broadway Ave.
Brooklyn Park,
MN 55445
(763) 425-2281

Washington
Labs SU01-SU07
14128 339th Ave. SE
Sultan, WA 98294
(360) 793-8675

New York
Labs WA01-WA04
4939 Jordan Rd.
Elbridge, NY 13060
(315) 685-0796

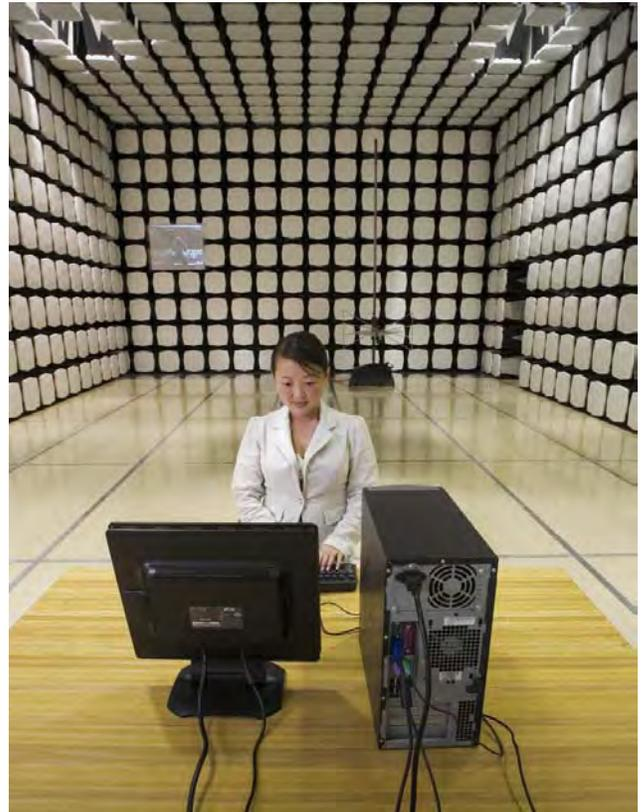
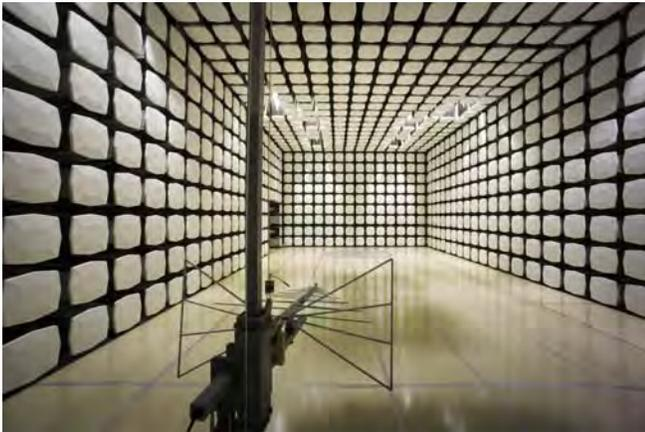

Party Requesting the Test

Company Name:	Intermec Technologies Corporation
Address:	6001 36 th Avenue West
City, State, Zip:	Everett, WA 98203-1264
Test Requested By:	Wayne Rieger
Model:	1000CP01C
First Date of Test:	February 8, 2011
Last Date of Test:	February 20, 2011
Receipt Date of Samples:	February 7, 2011
Equipment Design Stage:	Production
Equipment Condition:	No Damage

Information Provided by the Party Requesting the Test

Functional Description of the EUT (Equipment Under Test)

The EUT is a handheld computer containing two radio modules, the Intermec Model RC12 and the Sierra Wireless MC5728V, each with their own integral antenna.

The Intermec Model RC12 radio module is an 802.11a/b/g/n – Bluetooth radio. It is not capable of 40 MHz channel operation. The 802.11a/b/g/n and Bluetooth radios share the same antenna, but cannot transmit simultaneously. The frequency range of the 802.11a/b/g/n radio:

- 2412 – 2462 MHz
- 5180 – 5320 MHz
- 5500 – 5700 MHz
- 5745 – 5825 MHz

The frequency range of the Bluetooth radio:

- 2402 – 2480 MHz

The Sierra Wireless MC5728V radio module is a CDMA (EVDO Rev A) radio. Its frequency range:

- 824.7 – 848.31 MHz
- 1851.25 – 1908.8 MHz

The closest spacing between the CDMA antenna and 802.11a/b/g/n antenna is 3.7cm. The 802.11a/b/g/n antenna is on the right side of the handheld computer and the CDMA antenna is on the left side.

In normal operation, the EUT can be held in the hand, or next to the head like a cellular handset, or worn on the body. The only Intermec approved accessory for body worn operation is a holster that contains metal. The EUT can only fit in the holster with the top end of the unit pointing down. The holster cup can be attached to the holster belt with either the keypad facing the user, or the side facing the user. In no case can the back of the EUT face the user.

An optional snap-on audio accessory is available. It connects to the bottom end of the unit and provides a standard audio jack for connection of a VR10 headset.

The EUT is powered by a lithium-ion battery, Model 1000AB01.

Overview of the SAR Evaluation**Objective**

To demonstrate compliance with the SAR requirements of FCC 2.1093 and Canada's Health Safety Code 6.

Scope

The 802.11a/b/g/n – Bluetooth radio was evaluated under a separate SAR evaluation report.

Regarding the CDMA radio:

KDB 648474 D01 is the FCC's Policy for SAR evaluation of handsets with multiple transmitters and antennas. It states:

“Routine SAR evaluation with respect to Section 2.1093 of the rules is required for licensed transmitter to show compliance,”

The SAR evaluation documented in this report is for the CDMA portion of the EUT.

CONFIGURATION 1**EUT**

Description	Manufacturer	Model/Part Number	Serial Number
Handheld Computer	Intermec Technologies	1000CP01C	24411047064

Peripherals in test setup boundary

Description	Manufacturer	Model/Part Number	Serial Number
Battery	Intermec Technologies	1000AB01	16961001722
Battery	Intermec Technologies	1000AB01	16961001720
Battery	Intermec Technologies	1000AB01	19691001924
Headset	Intermec Technologies	VR10	A351000021
Standard Audio Snap-On	Intermec Technologies	225-771-001	N/A
Holster Cup	Intermec Technologies	X11183-V1-R1	N/A
Y-Belt	Intermec Technologies	X11148-V2	N/A

Equipment modifications					
Item	Date	Test	Modification	Note	Disposition of EUT
1	2/8/2011	SAR Evaluation	Tested as delivered to Test Station.	No EMI suppression devices were added or modified during this test.	EUT remained at Northwest EMC following the test.
2	2/20/2010	SAR Evaluation	Tested as delivered to Test Station.	No EMI suppression devices were added or modified during this test.	Scheduled testing was completed.

Per FCC KDB 941225, the conducted output power was measured at the low, middle and high channels in each band. An Agilent 8960 test set, Model E5515C, was used to control the EUT. The following applications were installed on the test set: CDMA200 Mobile Test Rev B.17.08, and EVDO Term Test Rev A.12.08. This provided all the necessary tools to operate the EUT in the prescribed manner without any difficulties or equipment limitations.

Per KDB 648474, among the channels required for normal testing, SAR must be measured on the highest conducted output channel (highlighted in the following pages). When the SAR measured on the highest output channel is < 0.8 W/kg, SAR evaluation for the other required channels is unnecessary.

1XRTT

Per FCC KDB 941225, measurements for 1XRTT were made according to the procedures in section 4.4.5.2 of 3GPP2C.S0011/TIA-98-E. Results for steps 3, 4, and 10 of the power measurement procedure are tabulated on the following pages. SO55 was measured with power control bits in "All Up" condition; TDSO/SO32 was measured with power control bits in the "Bits Hold" condition.

The Agilent 8960 test set was configured as follows:

- Cell Info > Cell Parameters > System ID (SID) > 16420
 - Network ID (NID) > 65535
- Protocol Rev > 6 (IS-2000-0)
- Radio Config (RC) > See attached data sheet
- FCH Service Option (SO) Setup > See attached data sheet
- Traffic Data Rate > Full (9.6kbps)
- TDSO SCH Info > F-SCH Parameters > F-SCH Data Rate > 153.6 kbps
 - R-SCH Parameters > R-SCH Data Rate > 153.6 kbps
- Rvs Power Ctrl > Active bits (SO32)
- Rvs Power Ctrl > All Up bits (Maximum TxPout) (SO55)
- Call Params
 - Cell Power > set to -104 dBm/1.23 MHz (SO55)
 - Cell Power > Start at -86 dBm/1.23 MHz , then decrease until max power is reached (SO32)

EVDO Rev 0

Per FCC KDB 941225, measurements for EVDO Rev 0 were made according to the procedures in section 3.1.2.3.4 of 3GPP2 C.S0033-0/TIA-866. The results are tabulated on the following pages.

The Agilent 8960 test set was configured as follows:

RTAP Settings

- Call Control:
 - Generator Info > Channel Data Info > Termination Parameters > Max Forward Packet Duration > 16 Slots
- Call Params:
 - Cell Power > Set to -105.5 dBm/1.23 MHz
 - Application Config > Enhanced Test Application Protocol > RTAP
 - RTAP Rate > 153.6 kbps
 - Protocol Rel > 0 (1xEV-DO)
- Rvs Power Ctrl > All Up bits (Maximum TxPout)

FTAP Settings

Call Control:
Generator Info > Channel Data Info > Termination Parameters > Max Forward Packet Duration > 16 Slots

Call Params:
Cell Power > Set to -105.5 dBm/1.23 MHz
Application Config > Enhanced Test Application Protocol > FTAP
FTAP Rate > 307.2 kbps (2 slot, QPSK)
Protocol Rel > 0 (1xEV-DO)
Rvs Power Ctrl > All Up bits (Maximum TxPout)

EVDO Rev A

For EVDO Rev A mode, measurements were made according to the procedures in section 4.3.4 of 3GPP2 C.S0033-A. The results are tabulated on the following pages.

The Agilent 8960 test set was configured as follows:

RETAP Settings

Call Params:
Cell Power > Set to -60 dBm/1.23 MHz
Protocol Rev > A (1xEV-DO-A)
Application Config > Enhanced Test Application Protocol > RETAP
R-Data Pkt Size > 4096
Protocol Subtype Config > Release A Physical Layer Subtype > Subtype 2

Call Control:
PL Subtype 2 Access Channel MAC Subtype > Default (Subtype 0):
Generator Info > Channel Data Info > Termination Parameters > Max Forward Packet Duration > 16 Slots
ACK R-Data After > Subpacket 0 (All ACK)
Rvs Power Ctrl > All Up bits (Maximum TxPout)

FETAP Settings

Call Params:
Cell Power > Set to -60 dBm/1.23 MHz
Protocol Rev > A (1xEV-DO-A)
Application Config > Enhanced Test Application Protocol > FETAP
F-Traffic Format > 4 (1024, 2, 128) Canonical (307.2k, QPSK)
Protocol Subtype Config > Release A Physical Layer Subtype > Subtype 2

Call Control:
PL Subtype 2 Access Channel MAC Subtype > Default (Subtype 0):
Generator Info > Channel Data Info > Termination Parameters > Max Forward Packet Duration > 16 Slots
ACK R-Data After > Subpacket 0 (All ACK)
Rvs Power Ctrl > All Up bits (Maximum TxPout)

EUT: 1000CP01C		Work Order: INMC0683
Serial Number: 24411047064		Date: 02/08/11
Customer: Intermec Technologies Corporation		Temperature: 24.2
Attendees: None		Humidity: 37%
Project:		Barometric Pres.: 1031.6
Tested by: Rod Peloquin	EUT Power	Battery
Job Site: EV08		
TEST SPECIFICATIONS		
FCC 2.1093:2011		Test Method
		FCC OET 65C:2001
COMMENTS		
Conducted output power		
DEVIATIONS FROM TEST STANDARD		
None		
Configuration #	1	<i>Rod Peloquin</i> Signature

CDMA 1XRTT

Band	Channel	Frequency (MHz)	Radio Configuration (RC)	Service Option (SO)	Conducted Power (Average)		
					dBm	W	
Cellular	1013	824.7	RC3 (Fwd3, Rvs3)	SO55 (Loopback)	23.94	0.248	
				SO32 (FCH+SCH)	23.99	0.251	
				SO32(FCH)	23.88	0.244	
	384	836.52	RC3 (Fwd3, Rvs3)	RC1(Fwd1, Rvs1)	SO55 (Loopback)	23.94	0.248
				SO55 (Loopback)	24.05	0.254	
				SO32 (FCH+SCH)	22.92	0.196	
	777	848.31	RC3 (Fwd3, Rvs3)	SO32(FCH)	23.63	0.231	
				RC1(Fwd1, Rvs1)	SO55 (Loopback)	24.09	0.256
				SO55 (Loopback)	23.80	0.240	
SO32 (FCH+SCH)				23.75	0.237		
SO32(FCH)				23.46	0.222		
RC1(Fwd1, Rvs1)				SO55 (Loopback)	23.86	0.243	
PCS	25	1851.25	RC3 (Fwd3, Rvs3)	SO55 (Loopback)	24.34	0.272	
				SO32 (FCH+SCH)	23.68	0.233	
				SO32(FCH)	23.76	0.238	
	600	1880	RC3 (Fwd3, Rvs3)	RC1(Fwd1, Rvs1)	SO55 (Loopback)	24.20	0.263
				SO55 (Loopback)	24.38	0.274	
				SO32 (FCH+SCH)	24.10	0.257	
	1175	1908.75	RC3 (Fwd3, Rvs3)	SO32(FCH)	24.30	0.269	
				RC1(Fwd1, Rvs1)	SO55 (Loopback)	24.37	0.274
				SO55 (Loopback)	24.35	0.272	
SO32 (FCH+SCH)				23.94	0.248		
SO32(FCH)				23.80	0.240		
RC1(Fwd1, Rvs1)				SO55 (Loopback)	24.17	0.261	

EUT: 1000CP01C		Work Order: INMC0683
Serial Number: 24411047064		Date: 02/08/11
Customer: Intermec Technologies Corporation		Temperature: 24.2
Attendees: None		Humidity: 37%
Project:		Barometric Pres.: 1031.6
Tested by: Rod Peloquin	EUT Power	Battery
Job Site: EV08		
TEST SPECIFICATIONS		
FCC 2.1093:2011		Test Method
		FCC OET 65C:2001
COMMENTS		
Conducted output power		
DEVIATIONS FROM TEST STANDARD		
None		
Configuration #	1	<i>Rod Peloquin</i> Signature

EVDO Rev 0

Band	Channel	Frequency (MHz)	FTAP Rate (kbps)	RTAP Rate (kbps)	Conducted Power (Average)	
					dBm	W
Cellular	1013	824.70	307.2 (2 slot, QPSK)	153.6	24.05	0.254
	384	836.52			24.08	0.256
	777	848.31			23.94	0.247
PCS	25	1851.25			24.28	0.268
	600	1880.00			24.27	0.267
	1175	1908.75			24.2	0.263

EVDO Rev A

Band	Channel	Frequency (MHz)	FETAP-Traffic Format (kbps)	RETAP-Data Payload Size	Conducted Power (Average)	
					dBm	W
Cellular	1013	824.70	307.2 (QPSK/ACK channel is transmitted at all the slots)	4096	24.05	0.254
	384	836.52			24.14	0.259
	777	848.31			24.08	0.255
PCS	25	1851.25			24.2	0.262
	600	1880.00			24.39	0.274
	1175	1908.75			24.2	0.262

Characterization of tissue-equivalent liquid dielectric properties

Per IEEE 1528: 2003, Section 5.2.2, the permittivity and conductivity of the tissue material should be measured at least within 24 hours of any full-compliance test. The measured values must be within +/- 5% of the target values. The temperature variation in the liquid during SAR measurements must be within +/- 2 degrees C of that recorded when the dielectric properties were measured.

The dielectric parameters of the tissue-equivalent liquids were measured prior to testing using the HP85070E dielectric probe kit. The dielectric measurements were made at 50 MHz intervals. The attached data sheets show that the dielectric parameters of the liquid were within the required 5% tolerances.

Target values of dielectric parameters

Per FCC OET 65C, Appendix C:

“The head tissue dielectric parameters recommended by the IEEE SCC-34/SC-2 in P1528 have been incorporated in the following table. These head parameters are derived from planar layer models simulating the highest expected SAR for the dielectric properties and tissue thickness variations in a human head. Other head and body tissue parameters that have not been specified in P1528 are derived from the tissue dielectric parameters computed from the 4-Cole-Cole equations and extrapolated according to the head parameters specified in P1528.”

Target Frequency (MHz)	Head		Body	
	ϵ_r	σ (S/m)	ϵ_r	σ (S/m)
150	52.3	0.76	61.9	0.80
300	45.3	0.87	58.2	0.92
450	43.5	0.87	56.7	0.94
835	41.5	0.90	55.2	0.97
900	41.5	0.97	55.0	1.05
915	41.5	0.98	55.0	1.06
1450	40.5	1.20	54.0	1.30
1610	40.3	1.29	53.8	1.40
1800 – 2000	40.0	1.40	53.3	1.52
2450	39.2	1.80	52.7	1.95
3000	38.5	2.40	52.0	2.73
5800	35.3	5.27	48.2	6.00

(ϵ_r = relative permittivity, σ = conductivity and $\rho = 1000 \text{ kg/m}^3$)

Composition of Ingredients for Liquid Tissue Phantoms

Northwest EMC uses tissue-equivalent liquids prepared by SPEAG and confirmed by them to be within +/- 5% from the target values. Their recipes are based upon the following formulations as found in FCC OET 65C, Appendix C:

“The following tissue formulations are provided for reference only as some of the parameters have not been thoroughly verified. The composition of ingredients may be modified accordingly to achieve the desired target tissue parameters required for routine SAR evaluation.”

Ingredients (% by weight)	Frequency (MHz)									
	450		835		915		1900		2450	
Tissue Type	Head	Body	Head	Body	Head	Body	Head	Body	Head	Body
Water	38.56	51.16	41.45	52.4	41.05	56.0	54.9	40.4	62.7	73.2
Salt (NaCl)	3.95	1.49	1.45	1.4	1.35	0.76	0.18	0.5	0.5	0.04
Sugar	56.32	46.78	56.0	45.0	56.5	41.76	0.0	58.0	0.0	0.0
HEC	0.98	0.52	1.0	1.0	1.0	1.21	0.0	1.0	0.0	0.0
Bactericide	0.19	0.05	0.1	0.1	0.1	0.27	0.0	0.1	0.0	0.0
Triton X-100	0.0	0.0	0.0	0.0	0.0	0.0	0.0	0.0	36.8	0.0
DGBE	0.0	0.0	0.0	0.0	0.0	0.0	44.92	0.0	0.0	26.7
Dielectric Constant	43.42	58.0	42.54	56.1	42.0	56.8	39.9	54.0	39.8	52.5
Conductivity (S/m)	0.85	0.83	0.91	0.95	1.0	1.07	1.42	1.45	1.88	1.78

Salt: 99⁺% Pure Sodium Chloride

Sugar: 98⁺% Pure Sucrose

Water: De-ionized, 16 M Ω ⁺ resistivity

HEC: Hydroxyethyl Cellulose

DGBE: 99⁺% Di(ethylene glycol) butyl ether, [2-(2-butoxyethoxy)ethanol]

Triton X-100 (ultra pure): Polyethylene glycol mono [4-(1,1, 3, 3-tetramethylbutyl)phenyl]ether

NORTHWEST EMC		Tissue - Equivalent Liquid		SAR 2011.02.21	
EUT:	HSL900	Work Order:	NMC0683		
Serial Number:	SAS	Date:	2/9/11		
Customer:	Intermec	Temperature (°C):	24.5		
Attendees:	none	Humidity:	40.8		
Project:		Barometric Pres. (mb):	1032.1		
Tested by:	Jennifer Herrett	Job Site:	EV08		
TEST SPECIFICATIONS		Test Method			
FCC 2.1093: 2011		FCC OET 65C: 2001			
COMMENTS					
None					
DEVIATIONS FROM TEST STANDARD					
None					
Configuration #	None	Signature <i>Jennifer Herrett</i>			
Tissue: Head			Liquid Temperature (°C): 22		

Frequency (GHz)	Actual Values		Target Values		Deviation (%)	
	Relative Permittivity	Conductivity	Relative Permittivity	Conductivity	Relative Permittivity	Conductivity
835	42.057	0.884	41.500	0.900	-1.34	1.80
700.0	43.8	0.758				
705.0	43.7	0.763				
710.0	43.6	0.768				
715.0	43.6	0.772				
720.0	43.5	0.777				
725.0	43.4	0.782				
730.0	43.4	0.786				
735.0	43.3	0.791				
740.0	43.2	0.795				
745.0	43.2	0.800				
750.0	43.1	0.804				
755.0	43.0	0.809				
760.0	43.0	0.813				
765.0	42.9	0.818				
770.0	42.9	0.823				
775.0	42.8	0.828				
780.0	42.7	0.832				
785.0	42.7	0.837				
790.0	42.6	0.842				
795.0	42.5	0.847				
800.0	42.5	0.851				
805.0	42.4	0.856				
810.0	42.4	0.861				
815.0	42.3	0.866				
820.0	42.2	0.870				
825.0	42.2	0.874				
830.0	42.1	0.880				
835.0	42.1	0.884				
840.0	42.0	0.889				
845.0	41.9	0.893				
850.0	41.9	0.898				
855.0	41.8	0.903				
860.0	41.8	0.908				
865.0	41.7	0.912				
870.0	41.6	0.917				
875.0	41.6	0.922				
880.0	41.5	0.926				
885.0	41.5	0.931				
890.0	41.4	0.936				
895.0	41.3	0.940				
900.0	41.3	0.945				
905.0	41.2	0.949				
910.0	41.2	0.955				
915.0	41.1	0.959				
920.0	41.0	0.964				
925.0	41.0	0.968				
930.0	40.9	0.974				
935.0	40.9	0.978				
940.0	40.8	0.983				
945.0	40.8	0.987				
950.0	40.7	0.992				
955.0	40.7	0.997				
960.0	40.6	1.001				
965.0	40.6	1.006				
970.0	40.5	1.011				
975.0	40.5	1.015				
980.0	40.4	1.020				
985.0	40.4	1.025				
990.0	40.3	1.029				
995.0	40.2	1.034				
1000.0	40.2	1.039				
1005.0	40.1	1.043				
1010.0	40.1	1.048				
1015.0	40.0	1.052				
1020.0	40.0	1.057				
1025.0	39.9	1.061				
1030.0	39.9	1.066				
1035.0	39.8	1.070				
1040.0	39.8	1.075				
1045.0	39.7	1.079				
1050.0	39.7	1.084				
1055.0	39.6	1.089				
1060.0	39.6	1.093				
1065.0	39.5	1.097				
1070.0	39.5	1.102				
1075.0	39.4	1.106				
1080.0	39.4	1.111				
1085.0	39.3	1.115				
1090.0	39.3	1.120				
1095.0	39.2	1.124				
1100.0	39.2	1.128				
1105.0	39.1	1.133				
1110.0	39.1	1.136				
1115.0	39.1	1.141				
1120.0	39.0	1.145				
1125.0	39.0	1.149				
1130.0	38.9	1.154				
1135.0	38.9	1.158				
1140.0	38.9	1.163				
1145.0	38.8	1.168				
1150.0	38.8	1.173				
1155.0	38.8	1.178				
1160.0	38.7	1.184				
1165.0	38.7	1.189				
1170.0	38.6	1.194				
1175.0	38.6	1.199				
1180.0	38.5	1.204				
1185.0	38.5	1.209				
1190.0	38.4	1.214				
1195.0	38.4	1.219				
1200.0	38.3	1.224				

NORTHWEST EMC		Tissue - Equivalent Liquid		SAR 2011.02.21	
EUT:	HSL900	Work Order:	INMC0683		
Serial Number:	SAS	Date:	2/10/11		
Customer:	Intermec	Temperature (°C):	25.2		
Attendees:	none	Humidity:	31.5		
Project:		Barometric Pres. (mb):	1025.6		
Tested by:	Jennifer Herrett	Job Site:	EV08		
TEST SPECIFICATIONS		Test Method			
FCC 2.1093: 2011		FCC OET 65C: 2001			
COMMENTS					
None					
DEVIATIONS FROM TEST STANDARD					
None					
Configuration #	None	Signature <i>Jennifer Herrett</i>			
Tissue: Head			Liquid Temperature (°C): 21.7		

Frequency (GHz)	Actual Values		Target Values		Deviation (%)	
	Relative Permittivity	Conductivity	Relative Permittivity	Conductivity	Relative Permittivity	Conductivity
835	40.259	0.892	41.500	0.900	2.99	0.94

700.0	42.0	0.768
705.0	42.0	0.773
710.0	41.9	0.778
715.0	41.8	0.782
720.0	41.7	0.787
725.0	41.7	0.791
730.0	41.6	0.796
735.0	41.5	0.801
740.0	41.5	0.806
745.0	41.4	0.810
750.0	41.3	0.815
755.0	41.3	0.820
760.0	41.2	0.824
765.0	41.1	0.828
770.0	41.1	0.833
775.0	41.0	0.837
780.0	41.0	0.842
785.0	40.9	0.847
790.0	40.8	0.851
795.0	40.8	0.856
800.0	40.7	0.860
805.0	40.7	0.865
810.0	40.6	0.869
815.0	40.5	0.874
820.0	40.5	0.878
825.0	40.4	0.883
830.0	40.3	0.887
835.0	40.3	0.892
840.0	40.2	0.896
845.0	40.1	0.900
850.0	40.1	0.905
855.0	40.0	0.909
860.0	39.9	0.914
865.0	39.9	0.919
870.0	39.8	0.924
875.0	39.7	0.929
880.0	39.7	0.933
885.0	39.6	0.938
890.0	39.6	0.942
895.0	39.5	0.947
900.0	39.5	0.951
905.0	39.4	0.956
910.0	39.3	0.961
915.0	39.3	0.965
920.0	39.2	0.970
925.0	39.2	0.974
930.0	39.1	0.979
935.0	39.1	0.983
940.0	39.0	0.988
945.0	39.0	0.992
950.0	38.9	0.996
955.0	38.9	1.001
960.0	38.8	1.005
965.0	38.7	1.010
970.0	38.7	1.014
975.0	38.6	1.018
980.0	38.6	1.023
985.0	38.5	1.027
990.0	38.5	1.031
995.0	38.4	1.035
1000.0	38.4	1.040
1005.0	38.3	1.045
1010.0	38.2	1.049
1015.0	38.2	1.054
1020.0	38.1	1.058
1025.0	38.1	1.063
1030.0	38.0	1.067
1035.0	38.0	1.072
1040.0	37.9	1.076
1045.0	37.9	1.081
1050.0	37.8	1.085
1055.0	37.8	1.089
1060.0	37.7	1.094
1065.0	37.7	1.098
1070.0	37.6	1.103
1075.0	37.6	1.107
1080.0	37.5	1.111
1085.0	37.5	1.116
1090.0	37.5	1.120
1095.0	37.4	1.124
1100.0	37.4	1.129
1105.0	37.3	1.133
1110.0	37.3	1.138
1115.0	37.2	1.142
1120.0	37.2	1.147
1125.0	37.1	1.152
1130.0	37.1	1.156
1135.0	37.1	1.160
1140.0	37.0	1.165
1145.0	37.0	1.169
1150.0	36.9	1.174
1155.0	36.9	1.178
1160.0	36.8	1.182
1165.0	36.8	1.187
1170.0	36.7	1.192
1175.0	36.7	1.196
1180.0	36.6	1.201
1185.0	36.6	1.205
1190.0	36.5	1.209
1195.0	36.5	1.214
1200.0	36.4	1.218

NORTHWEST		EMC		Tissue - Equivalent Liquid		SAR 2011.02.21	
EUT: HSL900				Work Order: INMC0683			
Serial Number: SAS				Date: 2/11/11			
Customer: Intermec				Temperature (°C): 21.7			
Attendees: none				Humidity: 38.8			
Project:				Barometric Pres. (mb): 1021.7			
Tested by: Jennifer Herrett				Job Site: EV08			
TEST SPECIFICATIONS				Test Method			
FCC 2.1093: 2011				FCC OET 65C: 2001			
COMMENTS							
None							
DEVIATIONS FROM TEST STANDARD							
None							
Configuration #	None			Signature <i>Jennifer Herrett</i>			
Tissue: Head				Liquid Temperature (°C): 20.3			

Frequency (GHz)	Actual Values		Target Values		Deviation (%)	
	Relative Permittivity	Conductivity	Relative Permittivity	Conductivity	Relative Permittivity	Conductivity
835	41.700	0.884	41.500	0.900	-0.48	1.75
700.0	43.5	0.759				
705.0	43.4	0.763				
710.0	43.3	0.768				
715.0	43.2	0.773				
720.0	43.2	0.777				
725.0	43.1	0.782				
730.0	43.0	0.786				
735.0	43.0	0.792				
740.0	42.9	0.796				
745.0	42.8	0.801				
750.0	42.8	0.805				
755.0	42.7	0.810				
760.0	42.6	0.814				
765.0	42.6	0.819				
770.0	42.5	0.823				
775.0	42.5	0.828				
780.0	42.4	0.833				
785.0	42.3	0.838				
790.0	42.3	0.842				
795.0	42.2	0.846				
800.0	42.1	0.852				
805.0	42.1	0.856				
810.0	42.0	0.860				
815.0	41.9	0.865				
820.0	41.9	0.870				
825.0	41.8	0.875				
830.0	41.8	0.880				
835.0	41.7	0.884				
840.0	41.6	0.889				
845.0	41.6	0.894				
850.0	41.5	0.898				
855.0	41.4	0.903				
860.0	41.4	0.908				
865.0	41.3	0.912				
870.0	41.3	0.916				
875.0	41.2	0.921				
880.0	41.2	0.926				
885.0	41.1	0.930				
890.0	41.1	0.935				
895.0	41.0	0.940				
900.0	40.9	0.944				
905.0	40.9	0.949				
910.0	40.8	0.954				
915.0	40.8	0.959				
920.0	40.7	0.964				
925.0	40.7	0.969				
930.0	40.6	0.974				
935.0	40.6	0.979				
940.0	40.5	0.983				
945.0	40.4	0.988				
950.0	40.4	0.993				
955.0	40.3	0.998				
960.0	40.3	1.002				
965.0	40.2	1.007				
970.0	40.2	1.012				
975.0	40.1	1.017				
980.0	40.1	1.022				
985.0	40.0	1.026				
990.0	40.0	1.031				
995.0	39.9	1.036				
1000.0	39.9	1.040				
1005.0	39.8	1.044				
1010.0	39.7	1.049				
1015.0	39.7	1.054				
1020.0	39.6	1.059				
1025.0	39.6	1.063				
1030.0	39.5	1.068				
1035.0	39.5	1.073				
1040.0	39.4	1.077				
1045.0	39.4	1.081				
1050.0	39.3	1.086				
1055.0	39.3	1.091				
1060.0	39.2	1.095				
1065.0	39.2	1.100				
1070.0	39.1	1.105				
1075.0	39.1	1.110				
1080.0	39.0	1.114				
1085.0	39.0	1.119				
1090.0	38.9	1.123				
1095.0	38.9	1.128				
1100.0	38.8	1.132				
1105.0	38.8	1.138				
1110.0	38.7	1.142				
1115.0	38.7	1.146				
1120.0	38.6	1.151				
1125.0	38.6	1.156				
1130.0	38.6	1.160				
1135.0	38.5	1.165				
1140.0	38.5	1.170				
1145.0	38.4	1.175				
1150.0	38.4	1.179				
1155.0	38.3	1.184				
1160.0	38.3	1.188				
1165.0	38.2	1.193				
1170.0	38.2	1.198				
1175.0	38.1	1.202				
1180.0	38.1	1.207				
1185.0	38.0	1.211				
1190.0	38.0	1.215				
1195.0	37.9	1.220				
1200.0	37.9	1.224				

EMC**Tissue - Equivalent Liquid**

EUT:	HSL1900	Work Order:	INMC0683
Serial Number:	SAN	Date:	2/12/11
Customer:	Intermec	Temperature (°C):	23.3
Attendees:	none	Humidity:	35.9
Project:		Barometric Pres. (mb):	1011.8
Tested by:	Jennifer Herrett	Job Site:	EV08
TEST SPECIFICATIONS		Test Method	
FCC 2.1093: 2011		FCC OET 65C: 2001	
COMMENTS			
None			
DEVIATIONS FROM TEST STANDARD			
None			
Configuration #	None	Signature <i>Jennifer Herrett</i>	
Tissue: Head		Liquid Temperature (°C): 21.1	

Frequency (GHz)	Actual Values		Target Values		Deviation (%)	
	Relative Permittivity	Conductivity	Relative Permittivity	Conductivity	Relative Permittivity	Conductivity
1900	40.600	1.423	40.000	1.400	-1.50	-1.64

1600.0	41.9	1.115
1612.5	41.9	1.128
1625.0	41.8	1.139
1637.5	41.8	1.152
1650.0	41.7	1.164
1662.5	41.7	1.177
1675.0	41.6	1.190
1687.5	41.6	1.204
1700.0	41.5	1.217
1712.5	41.5	1.230
1725.0	41.4	1.244
1737.5	41.4	1.257
1750.0	41.3	1.270
1762.5	41.2	1.282
1775.0	41.2	1.295
1787.5	41.1	1.308
1800.0	41.1	1.321
1812.5	41.0	1.334
1825.0	40.9	1.347
1837.5	40.9	1.360
1850.0	40.8	1.373
1862.5	40.8	1.386
1875.0	40.7	1.398
1887.5	40.7	1.411
1900.0	40.6	1.423
1912.5	40.5	1.436
1925.0	40.5	1.449
1937.5	40.4	1.462
1950.0	40.4	1.474
1962.5	40.3	1.487
1975.0	40.3	1.501
1987.5	40.3	1.514
2000.0	40.2	1.528

EMC**Tissue - Equivalent Liquid**

EUT: MSL1900	Work Order: INMC0683
Serial Number: SAO	Date: 2/14/11
Customer: Intermec	Temperature (°C): 22.9
Attendees: none	Humidity: 36.7
Project:	Barometric Pres. (mb): 1008
Tested by: Jennifer Herrett	Job Site: EV08
TEST SPECIFICATIONS	
FCC 2.1093: 2011	Test Method: FCC OET 65C: 2001
COMMENTS	
None	
DEVIATIONS FROM TEST STANDARD	
None	
Configuration #	None
Signature <i>Jennifer Herrett</i>	
Tissue: Body	
Liquid Temperature (°C): 20.9	

Frequency (GHz)	Actual Values		Target Values		Deviation (%)	
	Relative Permittivity	Conductivity	Relative Permittivity	Conductivity	Relative Permittivity	Conductivity
1900	53.493	1.459	53.300	1.520	-0.36	4.04

1600.0	54.6	1.135
1612.5	54.5	1.148
1625.0	54.5	1.161
1637.5	54.5	1.175
1650.0	54.4	1.188
1662.5	54.4	1.202
1675.0	54.4	1.216
1687.5	54.4	1.229
1700.0	54.3	1.242
1712.5	54.3	1.254
1725.0	54.2	1.267
1737.5	54.2	1.280
1750.0	54.1	1.293
1762.5	54.0	1.307
1775.0	54.0	1.322
1787.5	53.9	1.337
1800.0	53.9	1.352
1812.5	53.8	1.367
1825.0	53.8	1.382
1837.5	53.8	1.395
1850.0	53.7	1.409
1862.5	53.7	1.421
1875.0	53.6	1.433
1887.5	53.6	1.445
1900.0	53.5	1.459
1912.5	53.4	1.472
1925.0	53.4	1.487
1937.5	53.3	1.503
1950.0	53.3	1.518
1962.5	53.3	1.533
1975.0	53.2	1.549
1987.5	53.2	1.562
2000.0	53.2	1.577

EMC**Tissue - Equivalent Liquid**

EUT:	HSL1900	Work Order:	INMC0683
Serial Number:	SAN	Date:	2/15/11
Customer:	Intermec	Temperature (°C):	23.5
Attendees:	none	Humidity:	38.5
Project:		Barometric Pres. (mb):	1002.9
Tested by:	Jennifer Herrett	Job Site:	EV08
TEST SPECIFICATIONS		Test Method	
FCC 2.1093: 2011		FCC OET 65C: 2001	
COMMENTS			
None			
DEVIATIONS FROM TEST STANDARD			
None			
Configuration #	None	Signature <i>Jennifer Herrett</i>	
Tissue: Head		Liquid Temperature (°C): 21.6	

Frequency (GHz)	Actual Values		Target Values		Deviation (%)	
	Relative Permittivity	Conductivity	Relative Permittivity	Conductivity	Relative Permittivity	Conductivity
1900	39.887	1.381	40.000	1.400	0.28	1.39
1600.0	41.2	1.082				
1612.5	41.2	1.095				
1625.0	41.1	1.107				
1637.5	41.0	1.119				
1650.0	41.0	1.132				
1662.5	41.0	1.145				
1675.0	40.9	1.158				
1687.5	40.9	1.171				
1700.0	40.9	1.183				
1712.5	40.8	1.195				
1725.0	40.7	1.206				
1737.5	40.7	1.217				
1750.0	40.6	1.230				
1762.5	40.5	1.242				
1775.0	40.4	1.256				
1787.5	40.4	1.269				
1800.0	40.3	1.283				
1812.5	40.3	1.296				
1825.0	40.2	1.310				
1837.5	40.2	1.322				
1850.0	40.1	1.335				
1862.5	40.1	1.346				
1875.0	40.0	1.357				
1887.5	40.0	1.368				
1900.0	39.9	1.381				
1912.5	39.8	1.393				
1925.0	39.8	1.406				
1937.5	39.7	1.420				
1950.0	39.6	1.433				
1962.5	39.6	1.447				
1975.0	39.6	1.461				
1987.5	39.5	1.474				
2000.0	39.5	1.486				

EMC

Tissue - Equivalent Liquid

EUT: MSL1900	Work Order: INMC0683
Serial Number: SAO	Date: 2/15/11
Customer: Intermec	Temperature (°C): 23.5
Attendees: none	Humidity: 38.5
Project:	Barometric Pres. (mb): 1002.9
Tested by: Jennifer Herrett	Job Site: EV08
TEST SPECIFICATIONS	
FCC 2.1093: 2011	Test Method: FCC OET 65C: 2001
COMMENTS	
None	
DEVIATIONS FROM TEST STANDARD	
None	
Configuration #	None
Signature <i>Jennifer Herrett</i>	
Tissue: Body	
Liquid Temperature (°C): 21.6	

Frequency (GHz)	Actual Values		Target Values		Deviation (%)	
	Relative Permittivity	Conductivity	Relative Permittivity	Conductivity	Relative Permittivity	Conductivity
1900	53.431	1.454	53.300	1.520	-0.25	4.33

1600.0	54.5	1.133
1612.5	54.4	1.146
1625.0	54.4	1.159
1637.5	54.3	1.173
1650.0	54.3	1.186
1662.5	54.3	1.200
1675.0	54.3	1.215
1687.5	54.3	1.228
1700.0	54.2	1.241
1712.5	54.2	1.253
1725.0	54.1	1.265
1737.5	54.1	1.278
1750.0	54.0	1.291
1762.5	54.0	1.305
1775.0	53.9	1.319
1787.5	53.8	1.334
1800.0	53.8	1.349
1812.5	53.8	1.363
1825.0	53.7	1.378
1837.5	53.7	1.391
1850.0	53.6	1.404
1862.5	53.6	1.417
1875.0	53.5	1.429
1887.5	53.5	1.441
1900.0	53.4	1.454
1912.5	53.4	1.468
1925.0	53.3	1.483
1937.5	53.3	1.497
1950.0	53.2	1.512
1962.5	53.2	1.527
1975.0	53.2	1.541
1987.5	53.2	1.556
2000.0	53.1	1.570

EMC**Tissue - Equivalent Liquid**

EUT: HSL1900	Work Order: INMC0683
Serial Number: SAN	Date: 2/16/11
Customer: Intermec	Temperature (°C): 23.5
Attendees: none	Humidity: 41.7
Project:	Barometric Pres. (mb): 1002.5
Tested by: Jennifer Herrett	Job Site: EV08
TEST SPECIFICATIONS	
FCC 2.1093: 2011	Test Method: FCC OET 65C: 2001
COMMENTS	
None	
DEVIATIONS FROM TEST STANDARD	
None	
Configuration #	None
Signature <i>Jennifer Herrett</i>	
Tissue: Head	
Liquid Temperature (°C): 20.7	

Frequency (GHz)	Actual Values		Target Values		Deviation (%)	
	Relative Permittivity	Conductivity	Relative Permittivity	Conductivity	Relative Permittivity	Conductivity
1900	39.880	1.382	40.000	1.400	0.30	1.27

1600.0	41.2	1.084
1612.5	41.2	1.096
1625.0	41.1	1.108
1637.5	41.0	1.121
1650.0	41.0	1.134
1662.5	41.0	1.147
1675.0	40.9	1.160
1687.5	40.9	1.173
1700.0	40.8	1.185
1712.5	40.8	1.197
1725.0	40.7	1.208
1737.5	40.7	1.220
1750.0	40.6	1.232
1762.5	40.5	1.245
1775.0	40.4	1.258
1787.5	40.4	1.271
1800.0	40.3	1.285
1812.5	40.3	1.299
1825.0	40.2	1.312
1837.5	40.2	1.325
1850.0	40.1	1.337
1862.5	40.1	1.348
1875.0	40.0	1.360
1887.5	39.9	1.371
1900.0	39.9	1.382
1912.5	39.8	1.395
1925.0	39.7	1.408
1937.5	39.7	1.422
1950.0	39.6	1.436
1962.5	39.6	1.449
1975.0	39.6	1.463
1987.5	39.5	1.476
2000.0	39.5	1.489

NORTHWEST EMC		Tissue - Equivalent Liquid		SAR 2011.02.21	
EUT:	HSL900	Work Order:	INMC0683		
Serial Number:	SAS	Date:	2/17/11		
Customer:	Intermec	Temperature (°C):	21.5		
Attendees:	none	Humidity:	37.3		
Project:		Barometric Pres. (mb):	1008.3		
Tested by:	Jennifer Herrett	Job Site:	EV08		
TEST SPECIFICATIONS		Test Method			
FCC 2.1093: 2011		FCC OET 65C: 2001			
COMMENTS					
None					
DEVIATIONS FROM TEST STANDARD					
None					
Configuration #	None	Signature <i>Jennifer Herrett</i>			
Tissue: Head			Liquid Temperature (°C): 21.4		

Frequency (GHz)	Actual Values		Target Values		Deviation (%)	
	Relative Permittivity	Conductivity	Relative Permittivity	Conductivity	Relative Permittivity	Conductivity
835	41.507	0.880	41.500	0.900	-0.02	2.25
700.0	43.2	0.754				
705.0	43.1	0.759				
710.0	43.1	0.763				
715.0	43.0	0.768				
720.0	42.9	0.773				
725.0	42.9	0.777				
730.0	42.8	0.782				
735.0	42.7	0.787				
740.0	42.7	0.792				
745.0	42.6	0.796				
750.0	42.5	0.801				
755.0	42.5	0.806				
760.0	42.4	0.810				
765.0	42.4	0.815				
770.0	42.3	0.820				
775.0	42.2	0.824				
780.0	42.2	0.829				
785.0	42.1	0.833				
790.0	42.0	0.838				
795.0	42.0	0.843				
800.0	41.9	0.847				
805.0	41.9	0.852				
810.0	41.8	0.857				
815.0	41.7	0.862				
820.0	41.7	0.866				
825.0	41.6	0.871				
830.0	41.6	0.875				
835.0	41.5	0.880				
840.0	41.5	0.884				
845.0	41.4	0.889				
850.0	41.3	0.893				
855.0	41.3	0.898				
860.0	41.2	0.903				
865.0	41.2	0.907				
870.0	41.1	0.912				
875.0	41.0	0.917				
880.0	41.0	0.922				
885.0	40.9	0.926				
890.0	40.9	0.931				
895.0	40.8	0.936				
900.0	40.8	0.940				
905.0	40.7	0.945				
910.0	40.6	0.950				
915.0	40.6	0.954				
920.0	40.5	0.959				
925.0	40.5	0.964				
930.0	40.4	0.969				
935.0	40.4	0.973				
940.0	40.3	0.978				
945.0	40.2	0.983				
950.0	40.2	0.987				
955.0	40.1	0.992				
960.0	40.1	0.996				
965.0	40.0	1.001				
970.0	40.0	1.006				
975.0	39.9	1.010				
980.0	39.9	1.015				
985.0	39.8	1.019				
990.0	39.8	1.024				
995.0	39.7	1.029				
1000.0	39.7	1.033				
1005.0	39.6	1.038				
1010.0	39.6	1.043				
1015.0	39.5	1.047				
1020.0	39.5	1.052				
1025.0	39.4	1.056				
1030.0	39.4	1.061				
1035.0	39.3	1.066				
1040.0	39.3	1.070				
1045.0	39.2	1.075				
1050.0	39.2	1.079				
1055.0	39.1	1.084				
1060.0	39.0	1.089				
1065.0	39.0	1.094				
1070.0	38.9	1.098				
1075.0	38.9	1.102				
1080.0	38.8	1.107				
1085.0	38.8	1.112				
1090.0	38.7	1.116				
1095.0	38.7	1.121				
1100.0	38.7	1.126				
1105.0	38.6	1.130				
1110.0	38.6	1.135				
1115.0	38.5	1.139				
1120.0	38.5	1.144				
1125.0	38.4	1.149				
1130.0	38.4	1.153				
1135.0	38.3	1.157				
1140.0	38.3	1.162				
1145.0	38.2	1.167				
1150.0	38.2	1.171				
1155.0	38.1	1.176				
1160.0	38.1	1.181				
1165.0	38.1	1.185				
1170.0	38.0	1.190				
1175.0	38.0	1.195				
1180.0	37.9	1.199				
1185.0	37.9	1.203				
1190.0	37.8	1.208				
1195.0	37.8	1.213				
1200.0	37.7	1.217				

NORTHWEST EMC		Tissue - Equivalent Liquid		SAR 2011.02.21	
EUT:	HSL900	Work Order:	INMC0683		
Serial Number:	SAS	Date:	2/18/11		
Customer:	Intermec	Temperature (°C):	22.5		
Attendees:	none	Humidity:	37.2		
Project:		Barometric Pres. (mb):	1013.4		
Tested by:	Jennifer Herrett	Job Site:	EV08		
TEST SPECIFICATIONS		Test Method			
FCC 2.1093: 2011		FCC OET 65C: 2001			
COMMENTS					
None					
DEVIATIONS FROM TEST STANDARD					
None					
Configuration #	None	Signature <i>Jennifer Herrett</i>			
Tissue: Head			Liquid Temperature (°C): 21		

Frequency (GHz)	Actual Values		Target Values		Deviation (%)	
	Relative Permittivity	Conductivity	Relative Permittivity	Conductivity	Relative Permittivity	Conductivity
835	41.121	0.873	41.500	0.900	0.91	2.95
700.0	42.8	0.751				
705.0	42.8	0.755				
710.0	42.7	0.759				
715.0	42.6	0.764				
720.0	42.6	0.768				
725.0	42.5	0.773				
730.0	42.4	0.777				
735.0	42.4	0.782				
740.0	42.3	0.787				
745.0	42.2	0.791				
750.0	42.2	0.796				
755.0	42.1	0.801				
760.0	42.0	0.805				
765.0	42.0	0.810				
770.0	41.9	0.814				
775.0	41.8	0.819				
780.0	41.8	0.823				
785.0	41.7	0.828				
790.0	41.6	0.832				
795.0	41.6	0.837				
800.0	41.5	0.841				
805.0	41.5	0.846				
810.0	41.4	0.850				
815.0	41.4	0.855				
820.0	41.3	0.859				
825.0	41.2	0.864				
830.0	41.2	0.869				
835.0	41.1	0.873				
840.0	41.1	0.878				
845.0	41.0	0.883				
850.0	40.9	0.888				
855.0	40.9	0.893				
860.0	40.8	0.897				
865.0	40.8	0.902				
870.0	40.7	0.907				
875.0	40.6	0.912				
880.0	40.6	0.916				
885.0	40.5	0.921				
890.0	40.5	0.926				
895.0	40.4	0.931				
900.0	40.3	0.935				
905.0	40.3	0.940				
910.0	40.2	0.944				
915.0	40.2	0.949				
920.0	40.1	0.953				
925.0	40.1	0.958				
930.0	40.0	0.962				
935.0	39.9	0.967				
940.0	39.9	0.971				
945.0	39.8	0.976				
950.0	39.8	0.981				
955.0	39.7	0.986				
960.0	39.7	0.990				
965.0	39.6	0.995				
970.0	39.6	0.999				
975.0	39.5	1.004				
980.0	39.5	1.008				
985.0	39.4	1.013				
990.0	39.4	1.018				
995.0	39.3	1.022				
1000.0	39.2	1.027				
1005.0	39.2	1.031				
1010.0	39.1	1.036				
1015.0	39.1	1.041				
1020.0	39.0	1.045				
1025.0	39.0	1.050				
1030.0	38.9	1.055				
1035.0	38.9	1.058				
1040.0	38.8	1.063				
1045.0	38.8	1.068				
1050.0	38.7	1.072				
1055.0	38.7	1.077				
1060.0	38.6	1.081				
1065.0	38.6	1.086				
1070.0	38.6	1.090				
1075.0	38.5	1.094				
1080.0	38.5	1.099				
1085.0	38.4	1.104				
1090.0	38.4	1.108				
1095.0	38.3	1.113				
1100.0	38.3	1.118				
1105.0	38.2	1.122				
1110.0	38.2	1.127				
1115.0	38.2	1.132				
1120.0	38.1	1.136				
1125.0	38.1	1.141				
1130.0	38.0	1.146				
1135.0	38.0	1.151				
1140.0	37.9	1.156				
1145.0	37.9	1.161				
1150.0	37.8	1.166				
1155.0	37.8	1.170				
1160.0	37.7	1.175				
1165.0	37.7	1.180				
1170.0	37.6	1.185				
1175.0	37.6	1.189				
1180.0	37.5	1.194				
1185.0	37.5	1.198				
1190.0	37.4	1.202				
1195.0	37.4	1.207				
1200.0	37.4	1.211				

NORTHWEST EMC		Tissue - Equivalent Liquid		SAR 2011.02.21	
EUT:	MSL900	Work Order:	INMC0683		
Serial Number:	SAT	Date:	2/19/11		
Customer:	Intermec	Temperature (°C):	22.5		
Attendees:	none	Humidity:	37.2		
Project:		Barometric Pres. (mb):	1013.4		
Tested by:	Jennifer Herrett	Job Site:	EV08		
TEST SPECIFICATIONS		Test Method			
FCC 2.1093: 2011		FCC OET 65C: 2001			
COMMENTS					
None					
DEVIATIONS FROM TEST STANDARD					
None					
Configuration #	None	Signature <i>Jennifer Herrett</i>			
Tissue: Body			Liquid Temperature (°C): 21		

Frequency (GHz)	Actual Values		Target Values		Deviation (%)	
	Relative Permittivity	Conductivity	Relative Permittivity	Conductivity	Relative Permittivity	Conductivity
835	55.797	0.999	55.200	0.970	-1.08	-2.96
700.0	57.1	0.874				
705.0	57.0	0.878				
710.0	57.0	0.882				
715.0	57.0	0.886				
720.0	56.9	0.890				
725.0	56.9	0.894				
730.0	56.8	0.898				
735.0	56.8	0.902				
740.0	56.7	0.906				
745.0	56.7	0.911				
750.0	56.6	0.915				
755.0	56.5	0.919				
760.0	56.5	0.923				
765.0	56.4	0.928				
770.0	56.4	0.932				
775.0	56.3	0.937				
780.0	56.3	0.941				
785.0	56.2	0.946				
790.0	56.1	0.951				
795.0	56.1	0.956				
800.0	56.0	0.961				
805.0	56.0	0.967				
810.0	56.0	0.972				
815.0	55.9	0.977				
820.0	55.9	0.982				
825.0	55.9	0.988				
830.0	55.8	0.993				
835.0	55.8	0.999				
840.0	55.8	1.004				
845.0	55.7	1.008				
850.0	55.7	1.014				
855.0	55.7	1.018				
860.0	55.6	1.023				
865.0	55.6	1.028				
870.0	55.6	1.033				
875.0	55.5	1.037				
880.0	55.5	1.042				
885.0	55.4	1.046				
890.0	55.4	1.051				
895.0	55.3	1.056				
900.0	55.3	1.060				
905.0	55.2	1.065				
910.0	55.2	1.069				
915.0	55.1	1.074				
920.0	55.1	1.078				
925.0	55.0	1.083				
930.0	55.0	1.087				
935.0	54.9	1.093				
940.0	54.8	1.098				
945.0	54.8	1.103				
950.0	54.8	1.108				
955.0	54.7	1.114				
960.0	54.7	1.119				
965.0	54.6	1.125				
970.0	54.6	1.129				
975.0	54.5	1.135				
980.0	54.5	1.140				
985.0	54.4	1.145				
990.0	54.4	1.151				
995.0	54.4	1.156				
1000.0	54.3	1.161				
1005.0	54.3	1.166				
1010.0	54.3	1.171				
1015.0	54.2	1.177				
1020.0	54.2	1.181				
1025.0	54.2	1.186				
1030.0	54.1	1.191				
1035.0	54.1	1.195				
1040.0	54.0	1.200				
1045.0	54.0	1.204				
1050.0	53.9	1.209				
1055.0	53.9	1.213				
1060.0	53.8	1.217				
1065.0	53.8	1.222				
1070.0	53.8	1.227				
1075.0	53.7	1.231				
1080.0	53.7	1.237				
1085.0	53.7	1.242				
1090.0	53.6	1.248				
1095.0	53.6	1.253				
1100.0	53.5	1.258				
1105.0	53.5	1.265				
1110.0	53.5	1.270				
1115.0	53.4	1.276				
1120.0	53.4	1.281				
1125.0	53.3	1.287				
1130.0	53.3	1.293				
1135.0	53.3	1.298				
1140.0	53.2	1.304				
1145.0	53.2	1.310				
1150.0	53.2	1.315				
1155.0	53.1	1.321				
1160.0	53.1	1.326				
1165.0	53.1	1.332				
1170.0	53.0	1.338				
1175.0	53.0	1.343				
1180.0	52.9	1.348				
1185.0	52.9	1.354				
1190.0	52.8	1.359				
1195.0	52.8	1.364				
1200.0	52.8	1.369				

NORTHWEST EMC		Tissue - Equivalent Liquid		SAR 2011.02.21	
EUT:	HSL900	Work Order:	INMC0683		
Serial Number:	SAS	Date:	2/19/11		
Customer:	Intermec	Temperature (°C):	22.5		
Attendees:	none	Humidity:	37.2		
Project:		Barometric Pres. (mb):	1013.4		
Tested by:	Jennifer Herrett	Job Site:	EV08		
TEST SPECIFICATIONS		Test Method			
FCC 2.1093: 2011		FCC OET 65C: 2001			
COMMENTS					
None					
DEVIATIONS FROM TEST STANDARD					
None					
Configuration #	None	Signature <i>Jennifer Herrett</i>			
Tissue: Head			Liquid Temperature (°C): 21		

Frequency (GHz)	Actual Values		Target Values		Deviation (%)	
	Relative Permittivity	Conductivity	Relative Permittivity	Conductivity	Relative Permittivity	Conductivity
835	41.031	0.873	41.500	0.900	1.13	2.95
700.0	42.8	0.751				
705.0	42.7	0.755				
710.0	42.7	0.759				
715.0	42.6	0.764				
720.0	42.5	0.768				
725.0	42.5	0.772				
730.0	42.4	0.776				
735.0	42.3	0.780				
740.0	42.3	0.784				
745.0	42.2	0.788				
750.0	42.1	0.792				
755.0	42.0	0.797				
760.0	42.0	0.801				
765.0	41.9	0.805				
770.0	41.8	0.810				
775.0	41.7	0.815				
780.0	41.7	0.819				
785.0	41.6	0.824				
790.0	41.5	0.829				
795.0	41.5	0.833				
800.0	41.4	0.838				
805.0	41.3	0.843				
810.0	41.3	0.848				
815.0	41.2	0.853				
820.0	41.2	0.859				
825.0	41.1	0.863				
830.0	41.1	0.868				
835.0	41.0	0.873				
840.0	41.0	0.879				
845.0	40.9	0.883				
850.0	40.9	0.888				
855.0	40.8	0.893				
860.0	40.8	0.897				
865.0	40.7	0.902				
870.0	40.7	0.906				
875.0	40.6	0.911				
880.0	40.6	0.915				
885.0	40.5	0.919				
890.0	40.5	0.924				
895.0	40.4	0.928				
900.0	40.3	0.932				
905.0	40.3	0.937				
910.0	40.2	0.941				
915.0	40.1	0.945				
920.0	40.1	0.949				
925.0	40.0	0.954				
930.0	39.9	0.958				
935.0	39.9	0.962				
940.0	39.8	0.967				
945.0	39.8	0.972				
950.0	39.7	0.976				
955.0	39.6	0.981				
960.0	39.6	0.986				
965.0	39.5	0.991				
970.0	39.5	0.996				
975.0	39.4	1.001				
980.0	39.4	1.005				
985.0	39.3	1.010				
990.0	39.3	1.015				
995.0	39.2	1.020				
1000.0	39.2	1.024				
1005.0	39.1	1.029				
1010.0	39.1	1.034				
1015.0	39.1	1.038				
1020.0	39.0	1.043				
1025.0	39.0	1.047				
1030.0	38.9	1.051				
1035.0	38.9	1.055				
1040.0	38.8	1.059				
1045.0	38.7	1.064				
1050.0	38.7	1.067				
1055.0	38.6	1.071				
1060.0	38.6	1.075				
1065.0	38.5	1.079				
1070.0	38.5	1.084				
1075.0	38.4	1.088				
1080.0	38.4	1.092				
1085.0	38.3	1.097				
1090.0	38.3	1.102				
1095.0	38.3	1.106				
1100.0	38.2	1.111				
1105.0	38.2	1.116				
1110.0	38.1	1.121				
1115.0	38.1	1.126				
1120.0	38.0	1.131				
1125.0	38.0	1.136				
1130.0	37.9	1.141				
1135.0	37.9	1.146				
1140.0	37.8	1.150				
1145.0	37.8	1.156				
1150.0	37.7	1.160				
1155.0	37.7	1.165				
1160.0	37.7	1.170				
1165.0	37.6	1.175				
1170.0	37.6	1.180				
1175.0	37.5	1.184				
1180.0	37.5	1.189				
1185.0	37.4	1.193				
1190.0	37.4	1.197				
1195.0	37.3	1.202				
1200.0	37.3	1.206				

NORTHWEST EMC		Tissue - Equivalent Liquid		SAR 2011.02.21	
EUT:	HSL900	Work Order:	INMC0683		
Serial Number:	SAS	Date:	2/21/11		
Customer:	Intermec	Temperature (°C):	22.3		
Attendees:	none	Humidity:	37.2		
Project:		Barometric Pres. (mb):	1013.4		
Tested by:	Jennifer Herrett	Job Site:	EV08		
TEST SPECIFICATIONS		Test Method			
FCC 2.1093: 2011		FCC OET 65C: 2001			
COMMENTS					
None					
DEVIATIONS FROM TEST STANDARD					
None					
Configuration #	None	Signature <i>Jennifer Herrett</i>			
Tissue: Head			Liquid Temperature (°C): 21		

Frequency (GHz)	Actual Values		Target Values		Deviation (%)	
	Relative Permittivity	Conductivity	Relative Permittivity	Conductivity	Relative Permittivity	Conductivity
835	42.725	0.905	41.500	0.900	-2.95	-0.53
700.0	44.5	0.777				
705.0	44.4	0.781				
710.0	44.3	0.786				
715.0	44.3	0.791				
720.0	44.2	0.795				
725.0	44.2	0.800				
730.0	44.1	0.804				
735.0	44.0	0.809				
740.0	43.9	0.813				
745.0	43.9	0.818				
750.0	43.8	0.822				
755.0	43.7	0.827				
760.0	43.7	0.831				
765.0	43.6	0.836				
770.0	43.5	0.840				
775.0	43.5	0.845				
780.0	43.4	0.850				
785.0	43.3	0.854				
790.0	43.2	0.859				
795.0	43.2	0.864				
800.0	43.1	0.869				
805.0	43.1	0.874				
810.0	43.0	0.879				
815.0	42.9	0.884				
820.0	42.9	0.889				
825.0	42.8	0.894				
830.0	42.8	0.899				
835.0	42.7	0.905				
840.0	42.7	0.910				
845.0	42.6	0.915				
850.0	42.6	0.920				
855.0	42.5	0.925				
860.0	42.5	0.930				
865.0	42.4	0.935				
870.0	42.4	0.940				
875.0	42.3	0.945				
880.0	42.3	0.949				
885.0	42.2	0.954				
890.0	42.1	0.959				
895.0	42.1	0.963				
900.0	42.0	0.968				
905.0	42.0	0.972				
910.0	41.9	0.977				
915.0	41.9	0.981				
920.0	41.8	0.986				
925.0	41.7	0.990				
930.0	41.7	0.995				
935.0	41.6	0.999				
940.0	41.6	1.004				
945.0	41.5	1.008				
950.0	41.5	1.013				
955.0	41.4	1.017				
960.0	41.3	1.022				
965.0	41.3	1.027				
970.0	41.2	1.032				
975.0	41.2	1.037				
980.0	41.1	1.041				
985.0	41.1	1.046				
990.0	41.0	1.051				
995.0	40.9	1.056				
1000.0	40.9	1.061				
1005.0	40.8	1.066				
1010.0	40.8	1.070				
1015.0	40.7	1.075				
1020.0	40.7	1.080				
1025.0	40.6	1.085				
1030.0	40.6	1.089				
1035.0	40.5	1.094				
1040.0	40.5	1.098				
1045.0	40.4	1.103				
1050.0	40.4	1.107				
1055.0	40.3	1.112				
1060.0	40.3	1.116				
1065.0	40.2	1.121				
1070.0	40.2	1.125				
1075.0	40.2	1.129				
1080.0	40.1	1.134				
1085.0	40.1	1.139				
1090.0	40.0	1.144				
1095.0	40.0	1.148				
1100.0	39.9	1.153				
1105.0	39.9	1.158				
1110.0	39.8	1.163				
1115.0	39.8	1.168				
1120.0	39.7	1.173				
1125.0	39.7	1.178				
1130.0	39.6	1.183				
1135.0	39.6	1.188				
1140.0	39.5	1.193				
1145.0	39.5	1.198				
1150.0	39.4	1.203				
1155.0	39.4	1.208				
1160.0	39.3	1.213				
1165.0	39.3	1.218				
1170.0	39.2	1.223				
1175.0	39.2	1.228				
1180.0	39.1	1.232				
1185.0	39.1	1.237				
1190.0	39.0	1.242				
1195.0	39.0	1.247				
1200.0	39.0	1.251				

NORTHWEST EMC		Tissue - Equivalent Liquid		SAR 2011.02.21	
EUT:	MSL900	Work Order:	INMC0683		
Serial Number:	SAT	Date:	2/21/11		
Customer:	Intermec	Temperature (°C):	22.3		
Attendees:	none	Humidity:	37.2		
Project:		Barometric Pres. (mb):	1013.4		
Tested by:	Jennifer Herrett	Job Site:	EV08		
TEST SPECIFICATIONS		Test Method			
FCC 2.1093: 2011		FCC OET 65C: 2001			
COMMENTS					
None					
DEVIATIONS FROM TEST STANDARD					
None					
Configuration #	None	Signature <i>Jennifer Herrett</i>			
Tissue: Body			Liquid Temperature (°C): 21		

Frequency (GHz)	Actual Values		Target Values		Deviation (%)	
	Relative Permittivity	Conductivity	Relative Permittivity	Conductivity	Relative Permittivity	Conductivity
835	55.544	1.000	55.200	0.970	-0.62	-3.13
700.0	56.8	0.874				
705.0	56.7	0.878				
710.0	56.7	0.883				
715.0	56.7	0.888				
720.0	56.6	0.892				
725.0	56.6	0.897				
730.0	56.5	0.901				
735.0	56.5	0.906				
740.0	56.4	0.910				
745.0	56.4	0.915				
750.0	56.3	0.920				
755.0	56.3	0.924				
760.0	56.2	0.928				
765.0	56.2	0.933				
770.0	56.1	0.938				
775.0	56.1	0.942				
780.0	56.0	0.947				
785.0	56.0	0.951				
790.0	55.9	0.956				
795.0	55.9	0.961				
800.0	55.8	0.965				
805.0	55.8	0.970				
810.0	55.7	0.975				
815.0	55.7	0.980				
820.0	55.7	0.985				
825.0	55.6	0.990				
830.0	55.6	0.995				
835.0	55.5	1.000				
840.0	55.5	1.006				
845.0	55.4	1.011				
850.0	55.4	1.017				
855.0	55.4	1.022				
860.0	55.3	1.027				
865.0	55.3	1.032				
870.0	55.2	1.038				
875.0	55.2	1.042				
880.0	55.2	1.047				
885.0	55.1	1.052				
890.0	55.1	1.058				
895.0	55.0	1.063				
900.0	55.0	1.067				
905.0	55.0	1.072				
910.0	54.9	1.077				
915.0	54.9	1.081				
920.0	54.8	1.086				
925.0	54.8	1.090				
930.0	54.7	1.095				
935.0	54.7	1.099				
940.0	54.6	1.104				
945.0	54.6	1.109				
950.0	54.6	1.113				
955.0	54.5	1.118				
960.0	54.5	1.123				
965.0	54.4	1.128				
970.0	54.4	1.133				
975.0	54.3	1.138				
980.0	54.3	1.143				
985.0	54.2	1.148				
990.0	54.2	1.153				
995.0	54.1	1.158				
1000.0	54.1	1.164				
1005.0	54.0	1.168				
1010.0	54.0	1.174				
1015.0	54.0	1.179				
1020.0	53.9	1.184				
1025.0	53.9	1.189				
1030.0	53.8	1.194				
1035.0	53.8	1.199				
1040.0	53.7	1.204				
1045.0	53.7	1.210				
1050.0	53.7	1.215				
1055.0	53.6	1.219				
1060.0	53.6	1.224				
1065.0	53.6	1.229				
1070.0	53.5	1.234				
1075.0	53.5	1.239				
1080.0	53.5	1.244				
1085.0	53.4	1.250				
1090.0	53.4	1.254				
1095.0	53.4	1.259				
1100.0	53.3	1.264				
1105.0	53.3	1.270				
1110.0	53.3	1.275				
1115.0	53.2	1.280				
1120.0	53.2	1.285				
1125.0	53.1	1.290				
1130.0	53.1	1.296				
1135.0	53.1	1.302				
1140.0	53.0	1.307				
1145.0	53.0	1.313				
1150.0	52.9	1.319				
1155.0	52.9	1.324				
1160.0	52.8	1.330				
1165.0	52.8	1.336				
1170.0	52.7	1.341				
1175.0	52.7	1.346				
1180.0	52.7	1.352				
1185.0	52.6	1.357				
1190.0	52.6	1.363				
1195.0	52.5	1.368				
1200.0	52.5	1.374				

Requirement

Per IEEE 1528, Section 8.2.1, "System checks are performed prior to compliance tests and the results must always be within $\pm 10\%$ of the target value corresponding to the test frequency, liquid, and the source used. The target values are 1 g or 10 g averaged SAR values measured on systems having current system validation and calibration status, and using the system check setup as shown in Figure 14. These target values should be determined using a standard source."

Test Description

Prior to testing every day, Northwest EMC used the system validation kit (calibrated reference dipole) to test whether the system was operating within its specifications. The validation was performed in the indicated bands by making SAR measurements of the reference dipole with the phantom filled with the tissue-equivalent liquid. First, a signal generator and power amplifier were used to produce a 100mW level as measured with a power meter at the antenna terminals of the dipole. Then, the reference dipole was positioned below the bottom of the phantom and centered with its axis parallel to the longest side of the phantom. A low loss and low relative permittivity spacer was used to establish the correct distance between the center axis of the reference dipole and the liquid.

For the reference dipoles, the spacing distance s is given by:

$$s = 15\text{mm}, \pm 0.2\text{mm for } 300\text{MHz} \leq f \leq 1000 \text{ MHz:}$$

$$s = 10\text{mm}, \pm 0.2\text{mm for } 1000\text{MHz} \leq f \leq 6000\text{MHz}$$

The measured 1 g and 10 g spatial average SAR values were normalized to a 1W dipole input power for comparison to the calibration data. The results are summarized in the attached table. The deviation is less than 10% in all cases, indicating that the system performance check was within tolerance.

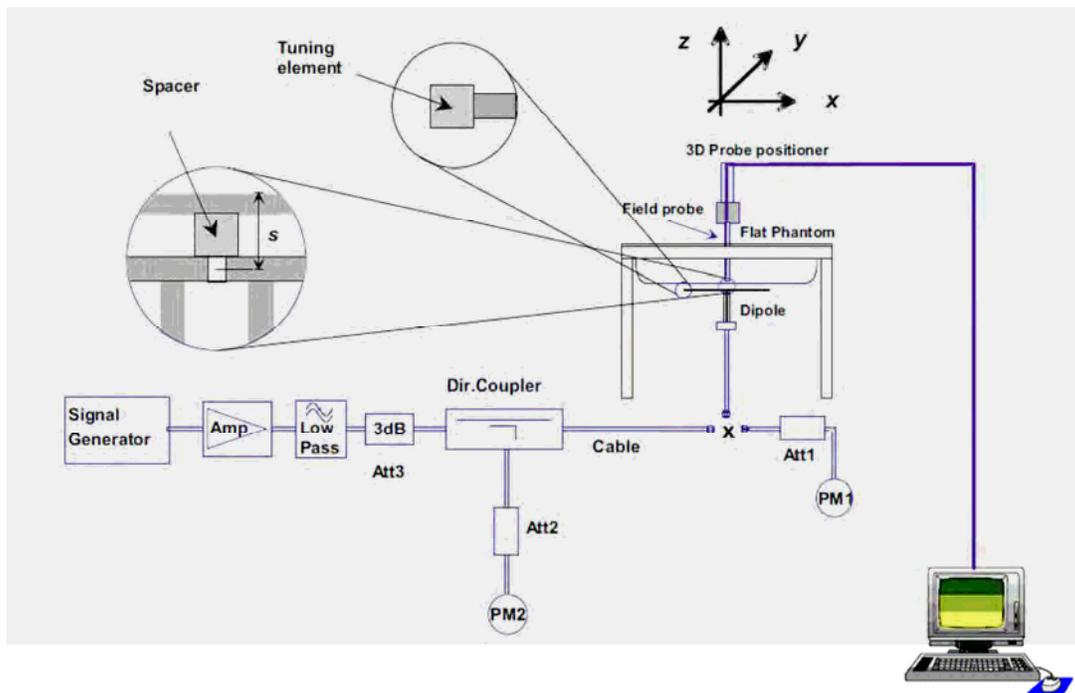

NORTHWEST		SAR TEST DATA		SAR 2011.02.07
EMC				
EUT:	1000CP01CO	Work Order:		INMC0683
Serial Number:	24411047084	Date:		See Data Sheets
Customer:	Intermec Technologies	Temperature:		See Data Sheets
Attendees:	None	Humidity:		See Data Sheets
Project:	INMC0570	Barometric Pres.:		See Data Sheets
Tested by:	Jennifer Herrett	Job Site:		EV08
TEST SPECIFICATIONS			Test Method	
FCC 2.1093:2011			FCC OET 65C:2001 IEEE Std 1528:2003 FCC KDB 447498 D01 v04 FCC KDB 941225 D01 v02 FCC KDB 648474 D01 V01r05	
Health Safety Code 6:2009			RSS-102, Issue 4:2010	
COMMENTS				
None				
DEVIATIONS FROM TEST STANDARD				
No Deviations				
Configuration #		Signature <i>Jennifer Herrett</i>		

Date	Liquid part number and frequency	Conducted Power into the Dipole (dBm)	Correction Factor	1g Measured	10g Measured	1g Normalized to 1W		10g Normalized to 1W		Target 1g (Normalized to 1W) - Get from Dipole cal cert	Target 10g (Normalized to 1W) - Get from Dipole cal cert	% difference 1g	% difference 10g	Comments
						1g	10g	1g	10g					
2/9/2011	HSL900 835MHz	20.0	10.0	0.967	0.641	9.67	6.41	9.64	6.29	9.64	6.29	0.31	1.91	
2/10/2011	HSL900 835MHz	20.0	10.0	1.000	0.664	10.00	6.64	9.64	6.29	9.64	6.29	3.73	5.56	
2/10/2011	MSL900 835MHz	20.0	10.0	0.909	0.604	9.09	6.04	9.93	6.51	9.93	6.51	-8.46	-7.22	
2/11/2011	HSL900 835MHz	20.0	10.0	0.959	0.636	9.59	6.36	9.64	6.29	9.64	6.29	-0.52	1.11	
2/12/2011	HSL1900 1900MHz	19.5	11.2	3.390	1.740	38.04	19.52	40.2	20.9	40.2	20.9	-5.38	-6.59	
2/14/2011	MSL1900 1900MHz	20.0	10.0	3.780	1.960	37.80	19.60	39.9	21	39.9	21	-5.26	-6.67	
2/15/2011	MSL1900 1900 MHz	20.0	10.0	4.190	2.180	41.90	21.80	39.9	21	39.9	21	5.01	3.81	
2/16/2011	HSL1900 1900MHz	20.0	10.0	4.050	2.090	40.50	20.90	40.2	20.9	40.2	20.9	0.75	0.00	
2/17/2011	HSL900 835MHz	20.0	10.0	0.986	0.655	9.86	6.55	9.64	6.29	9.64	6.29	2.28	4.13	
2/18/2011	MSL1900 1900MHz	20.0	10.0	4.240	2.200	42.40	22.00	39.9	21	39.9	21	6.27	4.76	
2/18/2011	HSL900 835MHz	20.0	10.0	0.988	0.655	9.88	6.55	9.64	6.29	9.64	6.29	2.49	4.13	
2/19/2011	MSL900 835MHz	20.0	10.0	1.000	0.660	10.00	6.60	9.93	6.51	9.93	6.51	0.70	1.38	
2/19/2011	HSL900 835MHz	20.0	10.0	0.957	0.634	9.57	6.34	9.64	6.29	9.64	6.29	-0.73	0.79	

EMC

SAR TEST DATA

Room Temperature (°C):	23.1	Humidity (%):	40.3	Test Date:	02/09/11
Liquid Temperature (°C):	21.4	Barometric Pressure (mb):	1034.8	Tested by:	Jennifer Herrett

HSL900 System Check_835MHz 2-9-11

DUT: Dipole 835 MHz D835V2; Type: D835V2; Serial: D835V2 - SN:4d108

Communication System: CW; Frequency: 835 MHz

Medium parameters used: $f = 835$ MHz; $\sigma = 0.884$ mho/m; $\epsilon = 42.057$; $\rho = 1000$ kg/m³, Medium parameters used: $\sigma = 0.883813$ mho/m; $\epsilon = 42.0572$; $\rho = 1000$ kg/m³

Phantom section: Flat Section

Measurement Standard: DASYS5 (IEEE/IEC/ANSI C63.19-2007)

DASYS5 Configuration:

Probe: ES3DV3 - SN3246; ConvF(6.04, 6.04, 6.04); Calibrated: 11/11/2010

Sensor-Surface: 4mm (Mechanical Surface Detection), Sensor-Surface: 0mm (Fix Surface), Sensor-Surface: 5mm (Mechanical Surface Detection)

Electronics: DAE4 Sn1237; Calibrated: 11/10/2010

Phantom: SAM with CRP; Type: SAM; Serial: 1598

Measurement SW: DASYS2, Version 52.6 (1); SEMCAD X Version 14.4.2 (2595)

System Check/System Check/Zoom Scan (7x7x7) (7x7x7)/Cube 0: Measurement grid: dx=5mm, dy=5mm, dz=5mm

Reference Value = 33.397 V/m; Power Drift = 0.07 dB

Peak SAR (extrapolated) = 1.380 W/kg

SAR(1 g) = 0.967 mW/g; SAR(10 g) = 0.641 mW/g

Maximum value of SAR (measured) = 1.048 mW/g

System Check/System Check/Z Scan (1x1x21): Measurement grid: dx=20mm, dy=20mm, dz=5mm

Maximum value of Total (measured) = 37.690 V/m

System Check/System Check/Area Scan (121x181x1): Measurement grid: dx=10mm, dy=10mm

Maximum value of SAR (interpolated) = 0.973 mW/g

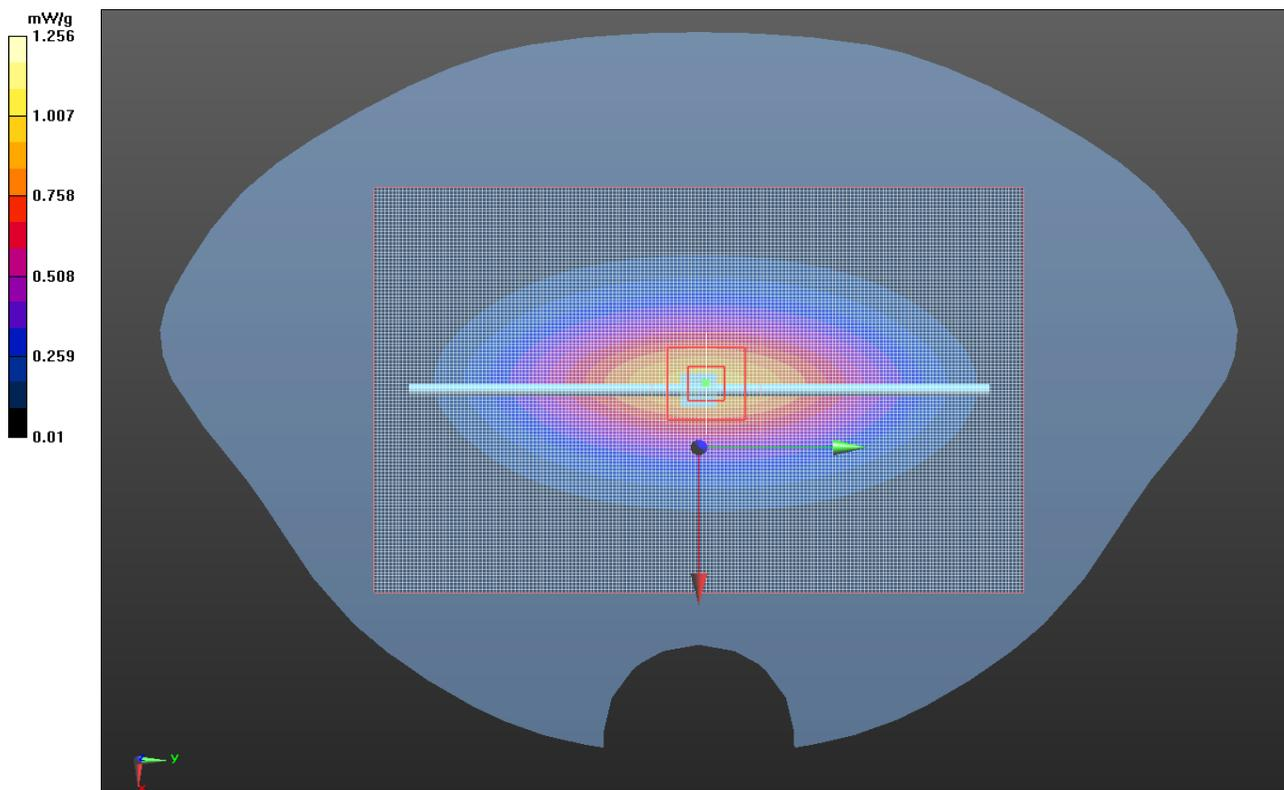

Room Temperature (°C):	23.7	Humidity (%):	32	Test Date:	02/10/11
Liquid Temperature (°C):	21.5	Barometric Pressure (mb):	1025.5	Tested by:	Jennifer Herrett

HSL900 System Check_835MHz 2-10-11

DUT: Dipole 835 MHz D835V2; Type: D835V2; Serial: D835V2 - SN:4d108

Communication System: CW; Frequency: 835 MHz

Medium parameters used: $f = 835$ MHz; $\sigma = 0.892$ mho/m; $\epsilon = 40.258$; $\rho = 1000$ kg/m³, Medium parameters used: $\sigma = 0.891561$ mho/m, $\epsilon = 40.2585$; $\rho = 1000$ kg/m³

Phantom section: Flat Section

Measurement Standard: DASYS5 (IEEE/IEC/ANSI C63.19-2007)

DASYS Configuration:

Probe: ES3DV3 - SN3246; ConvF(6.04, 6.04, 6.04); Calibrated: 11/11/2010

Sensor-Surface: 4mm (Mechanical Surface Detection), Sensor-Surface: 0mm (Fix Surface), Sensor-Surface: 5mm (Mechanical Surface Detection)

Electronics: DAE4 Sn1237; Calibrated: 11/10/2010

Phantom: SAM with CRP; Type: SAM; Serial: 1598

Measurement SW: DASYS2, Version 52.6 (1); SEMCAD X Version 14.4.2 (2595)

System Check/System Check/Zoom Scan (7x7x7) (7x7x7)/Cube 0: Measurement grid: dx=5mm, dy=5mm, dz=5mm

Reference Value = 33.423 V/m; Power Drift = 0.10 dB

Peak SAR (extrapolated) = 1.424 W/kg

SAR(1 g) = 1 mW/g; SAR(10 g) = 0.664 mW/g

Maximum value of SAR (measured) = 1.084 mW/g

System Check/System Check/Z Scan (1x1x21): Measurement grid: dx=20mm, dy=20mm, dz=5mm

Maximum value of Total (measured) = 38.282 V/m

System Check/System Check/Area Scan (121x181x1): Measurement grid: dx=10mm, dy=10mm

Maximum value of SAR (interpolated) = 1.002 mW/g

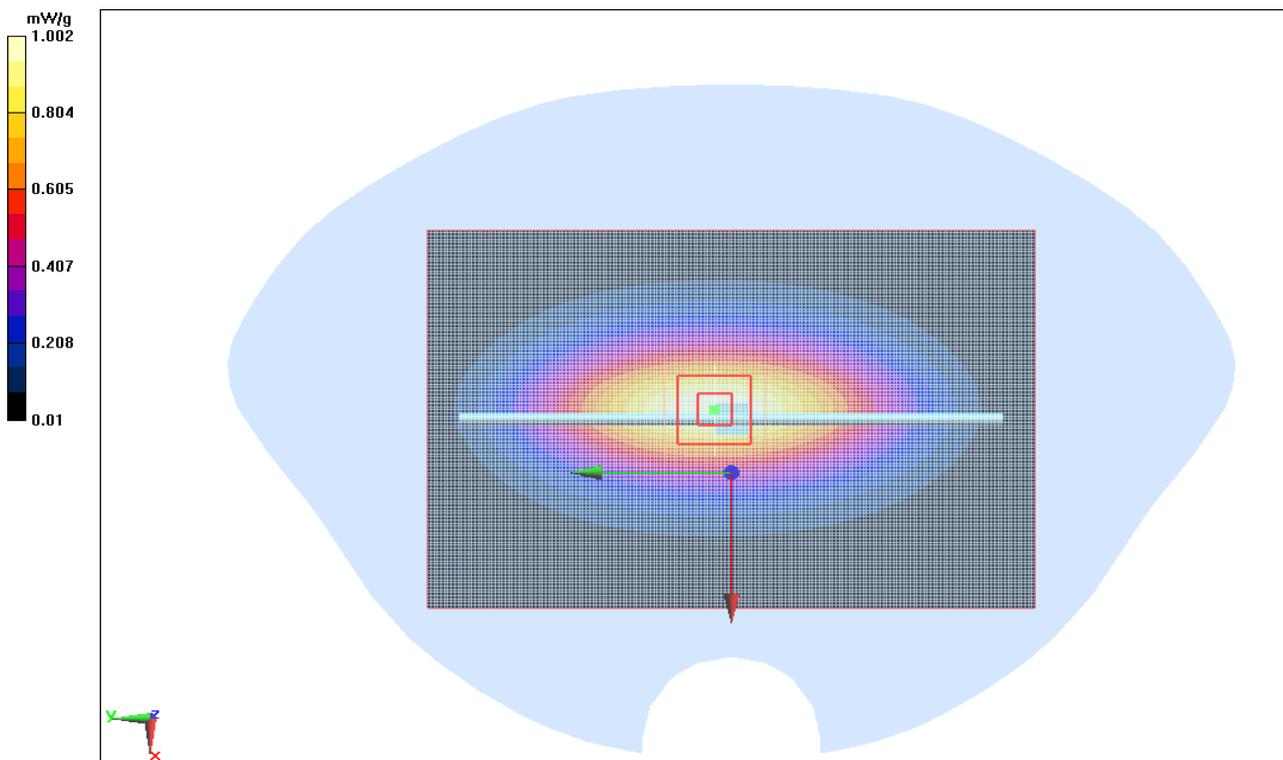

EMC

SAR TEST DATA

Room Temperature (°C):	24.6	Humidity (%):	40.7	Test Date:	02/10/11
Liquid Temperature (°C):	22	Barometric Pressure (mb):	1026	Tested by:	Jennifer Herrett

MSL900 System Check_835MHz 2-10-11

DUT: Dipole 835 MHz D835V2; Type: D835V2; Serial: D835V2 - SN:4d108

Communication System: CW; Frequency: 835 MHz

Medium parameters used: $f = 835$ MHz; $\sigma = 0.892$ mho/m; $\epsilon = 40.258$; $\rho = 1000$ kg/m³, Medium parameters used: $\sigma = 0.891561$ mho/m, $\epsilon = 40.2585$; $\rho = 1000$ kg/m³

Phantom section: Flat Section

Measurement Standard: DASYS (IEEE/IEC/ANSI C63.19-2007)

DASYS Configuration:

Probe: ES3DV3 - SN3246; ConvF(6.04, 6.04, 6.04); Calibrated: 11/11/2010

Sensor-Surface: 4mm (Mechanical Surface Detection), Sensor-Surface: 0mm (Fix Surface), Sensor-Surface: 5mm (Mechanical Surface Detection)

Electronics: DAE4 Sn1237; Calibrated: 11/10/2010

Phantom: ELI 4.0; Type: QDOVA001BA; Serial: xxxx

Measurement SW: DASYS2, Version 52.6 (1); SEMCAD X Version 14.4.2 (2595)

System Check/System Check/Zoom Scan (7x7x7) (7x7x7)/Cube 0: Measurement grid: dx=5mm, dy=5mm, dz=5mm

Reference Value = 32.965 V/m; Power Drift = -0.12 dB

Peak SAR (extrapolated) = 1.285 W/kg

SAR(1 g) = 0.909 mW/g; SAR(10 g) = 0.604 mW/g

Maximum value of SAR (measured) = 0.984 mW/g

System Check/System Check/Z Scan (1x1x21): Measurement grid: dx=20mm, dy=20mm, dz=5mm

Maximum value of Total (measured) = 35.838 V/m

System Check/System Check/Area Scan (121x181x1): Measurement grid: dx=10mm, dy=10mm

Maximum value of SAR (interpolated) = 0.918 mW/g

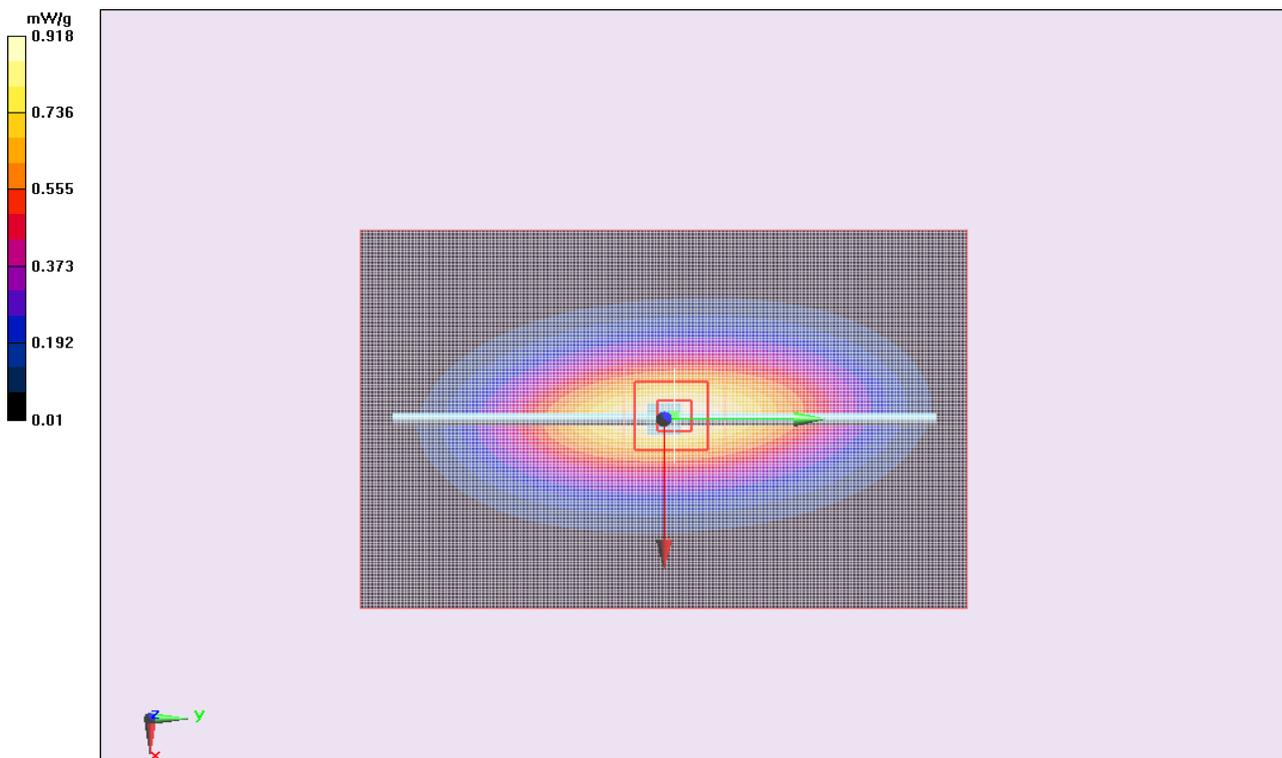

EMC

SAR TEST DATA

Room Temperature (°C):	21.8	Humidity (%):	36.4	Test Date:	02/11/11
Liquid Temperature (°C):	21.4	Barometric Pressure (mb):	1022.1	Tested by:	Jennifer Herrett

HSL900 System Check_835MHz 2-11-11

DUT: Dipole 835 MHz D835V2; Type: D835V2; Serial: D835V2 - SN:4d108

Communication System: CW; Frequency: 835 MHz

Medium parameters used: $f = 835$ MHz; $\sigma = 0.884$ mho/m; $\epsilon = 41.7$; $\rho = 1000$ kg/m³, Medium parameters used: $\sigma = 0.884189$ mho/m, $\epsilon = 41.7001$; $\rho = 1000$ kg/m³

Phantom section: Flat Section

Measurement Standard: DASYS (IEEE/IEC/ANSI C63.19-2007)

DASYS Configuration:

Probe: ES3DV3 - SN3246; ConvF(6.04, 6.04, 6.04); Calibrated: 11/11/2010

Sensor-Surface: 4mm (Mechanical Surface Detection), Sensor-Surface: 0mm (Fix Surface), Sensor-Surface: 5mm (Mechanical Surface Detection)

Electronics: DAE4 Sn1237; Calibrated: 11/10/2010

Phantom: SAM with CRP; Type: SAM; Serial: 1598

Measurement SW: DASYS2, Version 52.6 (1); SEMCAD X Version 14.4.2 (2595)

System Check/System Check/Zoom Scan (7x7x7) (7x7x7)/Cube 0: Measurement grid: dx=5mm, dy=5mm, dz=5mm

Reference Value = 33.659 V/m; Power Drift = -0.06 dB

Peak SAR (extrapolated) = 1.365 W/kg

SAR(1 g) = 0.959 mW/g; SAR(10 g) = 0.636 mW/g

Maximum value of SAR (measured) = 1.038 mW/g

System Check/System Check/Z Scan (1x1x21): Measurement grid: dx=20mm, dy=20mm, dz=5mm

Maximum value of Total (measured) = 37.443 V/m

System Check/System Check/Area Scan (121x181x1): Measurement grid: dx=10mm, dy=10mm

Maximum value of SAR (interpolated) = 0.966 mW/g

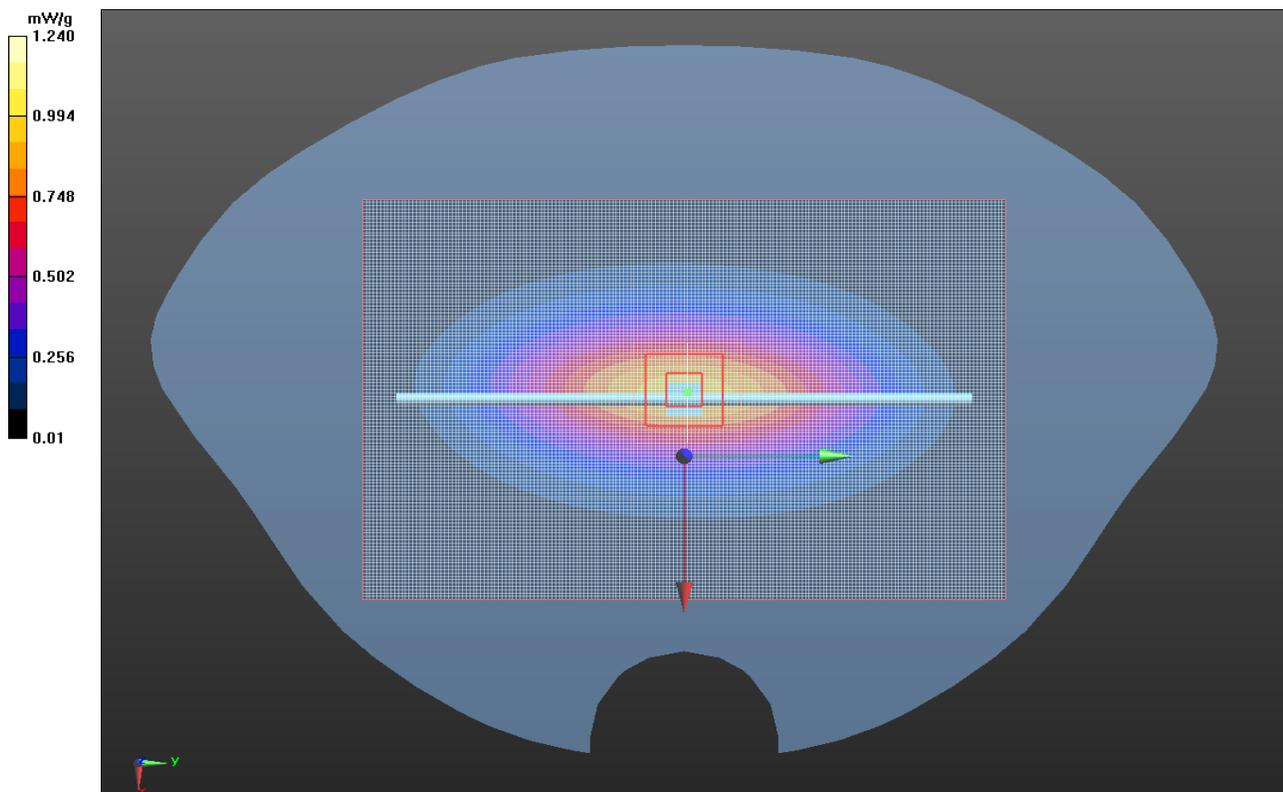

EMC

SAR TEST DATA

Room Temperature (°C):	23	Humidity (%):	38	Test Date:	02/12/11
Liquid Temperature (°C):	22	Barometric Pressure (mb):	1020	Tested by:	Jennifer Herrett

HSL1900 System Check

DUT: Dipole 1900 MHz D1900V2; Type: D1900V2; Serial: D1900V2 - SN:5d131

Communication System: CW; Frequency: 1900 MHz

Medium parameters used: $f = 1900$ MHz; $\sigma = 1.423$ mho/m; $\epsilon = 40.609$; $\rho = 1000$ kg/m³, Medium parameters used: $\sigma = 1.4232$ mho/m, $\epsilon = 40.6086$; $\rho = 1000$ kg/m³

Phantom section: Flat Section

Measurement Standard: DASYS5 (IEEE/IEC/ANSI C63.19-2007)

DASYS5 Configuration:

Probe: ES3DV3 - SN3246; ConvF(5.02, 5.02, 5.02); Calibrated: 11/11/2010

Sensor-Surface: 5mm (Mechanical Surface Detection), Sensor-Surface: 0mm (Fix Surface)

Electronics: DAE4 Sn1237; Calibrated: 11/10/2010

Phantom: SAM with CRP; Type: SAM; Serial: 1598

Measurement SW: DASYS2, Version 52.6 (1); SEMCAD X Version 14.4.2 (2595)

System Check/System Check/Zoom Scan (7x7x7) (7x7x7)/Cube 0: Measurement grid: dx=5mm, dy=5mm, dz=5mm

Reference Value = 47.454 V/m; Power Drift = 0.03 dB

Peak SAR (extrapolated) = 6.550 W/kg

SAR(1 g) = 3.39 mW/g; SAR(10 g) = 1.74 mW/g

Maximum value of SAR (measured) = 3.331 mW/g

System Check/System Check/Z Scan (1x1x21): Measurement grid: dx=20mm, dy=20mm, dz=5mm

Maximum value of Total (measured) = 58.478 V/m

System Check/System Check/Area Scan (101x121x1): Measurement grid: dx=10mm, dy=10mm

Maximum value of SAR (interpolated) = 3.375 mW/g

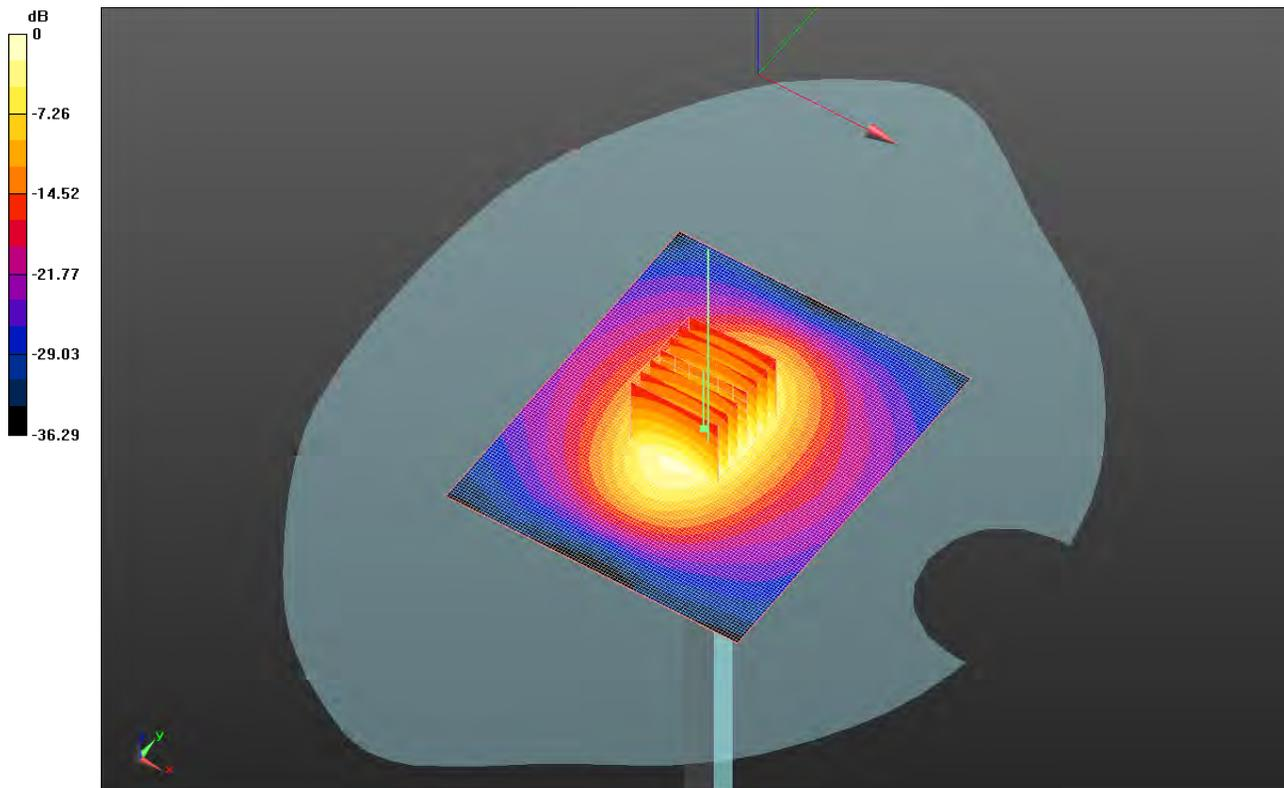

Room Temperature (°C):	22.1	Humidity (%):	44.2	Test Date:	02/14/11
Liquid Temperature (°C):	20.9	Barometric Pressure (mb):	1002.5	Tested by:	Jennifer Herrett

MSL1900 System Check 2-14-11

DUT: Dipole 1900 MHz D1900V2; Type: D1900V2; Serial: D1900V2 - SN:5d131

Communication System: CW; Frequency: 1900 MHz

Medium parameters used: $f = 1900$ MHz; $\sigma = 1.459$ mho/m; $\epsilon = 53.493$; $\rho = 1000$ kg/m³, Medium parameters used: $\sigma = 1.45856$ mho/m; $\epsilon = 53.4933$; $\rho = 1000$ kg/m³

Phantom section: Flat Section

Measurement Standard: DASYS5 (IEEE/IEC/ANSI C63.19-2007)

DASYS5 Configuration:

Probe: ES3DV3 - SN3246; ConvF(4.63, 4.63, 4.63); Calibrated: 11/11/2010

Sensor-Surface: 5mm (Mechanical Surface Detection), Sensor-Surface: 0mm (Fix Surface)

Electronics: DAE4 Sn1237; Calibrated: 11/10/2010

Phantom: ELI 4.0; Type: QDOVA001BA; Serial: 1096

Measurement SW: DASYS2, Version 52.6 (1); SEMCAD X Version 14.4.2 (2595)

System Check/System Check/Area Scan (101x121x1): Measurement grid: dx=10mm, dy=10mm

Maximum value of SAR (interpolated) = 3.801 mW/g

System Check/System Check/Zoom Scan (7x7x7) (7x7x7)/Cube 0: Measurement grid: dx=5mm, dy=5mm, dz=5mm

Reference Value = 50.793 V/m; Power Drift = 0.01 dB

Peak SAR (extrapolated) = 7.132 W/kg

SAR(1 g) = 3.78 mW/g; SAR(10 g) = 1.96 mW/g

Maximum value of SAR (measured) = 3.772 mW/g

System Check/System Check/Z Scan (1x1x21): Measurement grid: dx=20mm, dy=20mm, dz=5mm

Maximum value of Total (measured) = 58.206 V/m

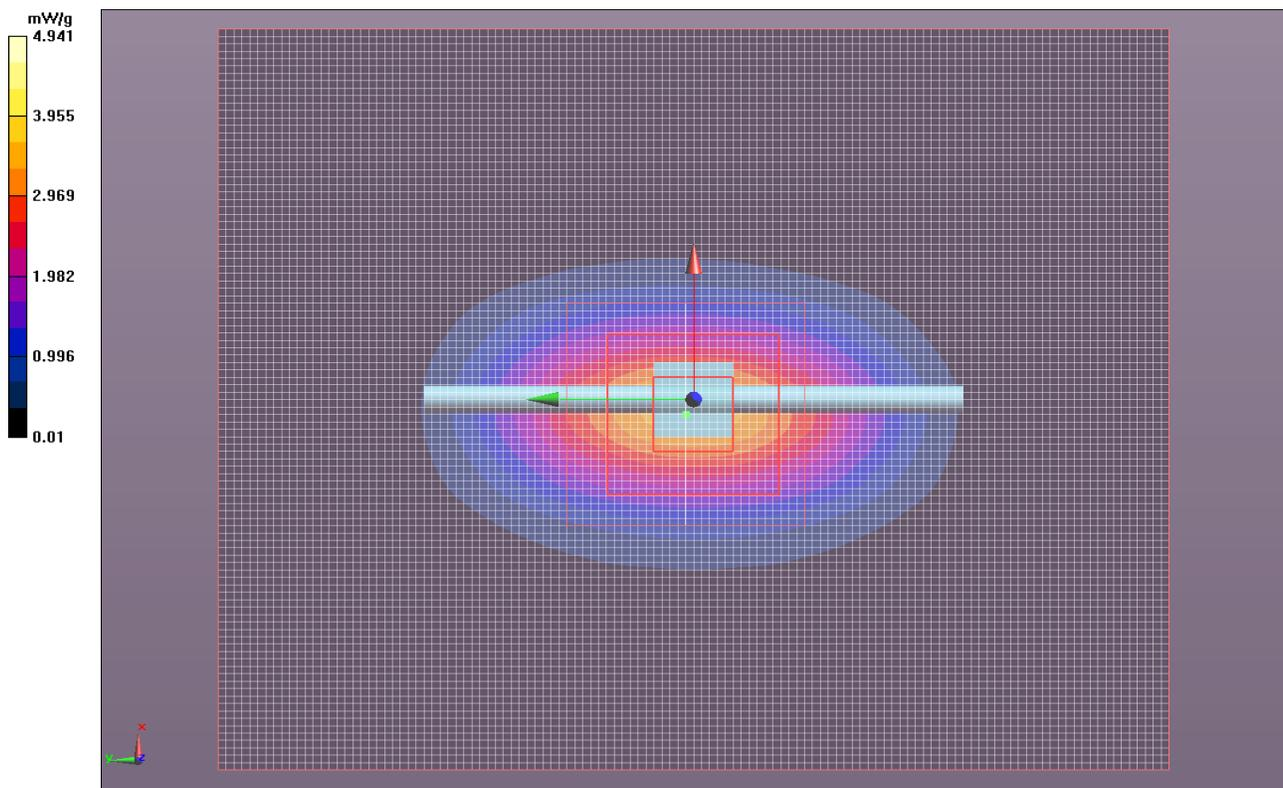

EMC

SAR TEST DATA

Room Temperature (°C):	23.7	Humidity (%):	39.6	Test Date:	02/15/11
Liquid Temperature (°C):	21.6	Barometric Pressure (mb):	1002	Tested by:	Jennifer Herrett

MSL1900 System Check_2-15-11

DUT: Dipole 1900 MHz D1900V2; Type: D1900V2; Serial: D1900V2 - SN:xxx

Communication System: CW; Frequency: 1900 MHz

Medium parameters used: $f = 1900$ MHz; $\sigma = 1.454$ mho/m; $\epsilon = 53.431$; $\rho = 1000$ kg/m³, Medium parameters used: $\sigma = 1.45416$ mho/m; $\epsilon = 53.4309$; $\rho = 1000$ kg/m³

Phantom section: Flat Section

Measurement Standard: DASYS5 (IEEE/IEC/ANSI C63.19-2007)

DASYS5 Configuration:

Probe: ES3DV3 - SN3246; ConvF(4.63, 4.63, 4.63); Calibrated: 11/11/2010

Sensor-Surface: 5mm (Mechanical Surface Detection), Sensor-Surface: 0mm (Fix Surface)

Electronics: DAE4 Sn1237; Calibrated: 11/10/2010

Phantom: ELI 4.0; Type: QDOVA001BA; Serial: xxxx

Measurement SW: DASYS2, Version 52.6 (1); SEMCAD X Version 14.4.2 (2595)

System Check/System Check/Area Scan (101x121x1): Measurement grid: dx=10mm, dy=10mm

Maximum value of SAR (interpolated) = 4.216 mW/g

System Check/System Check/Zoom Scan (7x7x7) (7x7x7)/Cube 0: Measurement grid: dx=5mm, dy=5mm, dz=5mm

Reference Value = 52.419 V/m; Power Drift = 0.01 dB

Peak SAR (extrapolated) = 7.896 W/kg

SAR(1 g) = 4.19 mW/g; SAR(10 g) = 2.18 mW/g

Maximum value of SAR (measured) = 4.181 mW/g

System Check/System Check/Z Scan (1x1x21): Measurement grid: dx=20mm, dy=20mm, dz=5mm

Maximum value of Total (measured) = 62.677 V/m

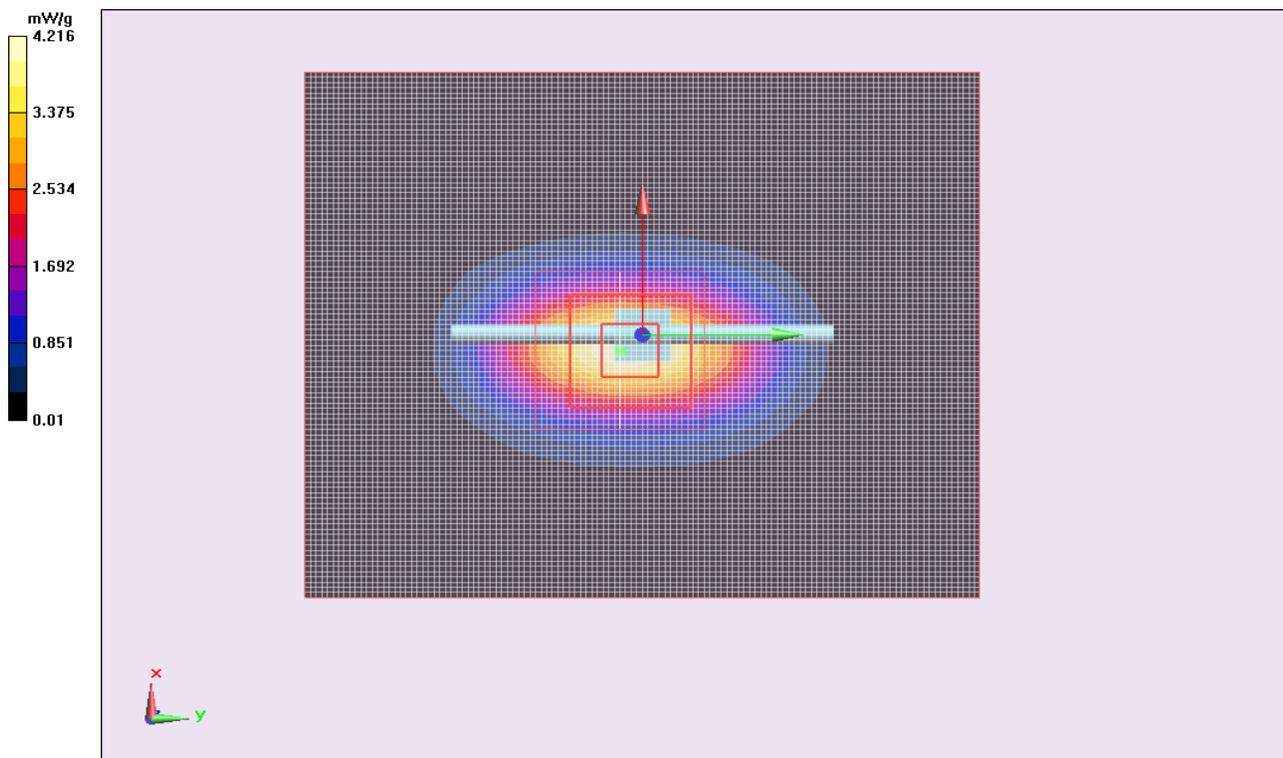

EMC

SAR TEST DATA

Room Temperature (°C):	24.4	Humidity (%):	40.6	Test Date:	02/16/11
Liquid Temperature (°C):	22.1	Barometric Pressure (mb):	1002	Tested by:	Jennifer Herrett

HSL1900 System Check_2-16-11

DUT: Dipole 1900 MHz D1900V2; Type: D1900V2; Serial: D1900V2 - SN:xxx

Communication System: CW; Frequency: 1900 MHz

Medium parameters used: $f = 1900$ MHz; $\sigma = 1.38$ mho/m; $\epsilon = 39.887$; $\rho = 1000$ kg/m³, Medium parameters used: $\sigma = 1.38048$ mho/m, $\epsilon = 39.8866$; $\rho = 1000$ kg/m³

Phantom section: Flat Section

Measurement Standard: DASYS (IEEE/IEC/ANSI C63.19-2007)

DASYS Configuration:

Probe: ES3DV3 - SN3246; ConvF(5.02, 5.02, 5.02); Calibrated: 11/11/2010

Sensor-Surface: 5mm (Mechanical Surface Detection); Sensor-Surface: 0mm (Fix Surface)

Electronics: DAE4 Sn1237; Calibrated: 11/10/2010

Phantom: SAM with CRP; Type: SAM; Serial: 1598

Measurement SW: DASYS2, Version 52.6 (1); SEMCAD X Version 14.4.2 (2595)

System Check/System Check/Area Scan (101x121x1): Measurement grid: dx=10mm, dy=10mm

Maximum value of SAR (interpolated) = 4.062 mW/g

System Check/System Check/Zoom Scan (7x7x7) (7x7x7)/Cube 0: Measurement grid: dx=5mm, dy=5mm, dz=5mm

Reference Value = 51.629 V/m; Power Drift = -0.04 dB

Peak SAR (extrapolated) = 7.811 W/kg

SAR(1 g) = 4.05 mW/g; SAR(10 g) = 2.09 mW/g

Maximum value of SAR (measured) = 4.017 mW/g

System Check/System Check/Z Scan (1x1x21): Measurement grid: dx=20mm, dy=20mm, dz=5mm

Maximum value of Total (measured) = 50.599 V/m

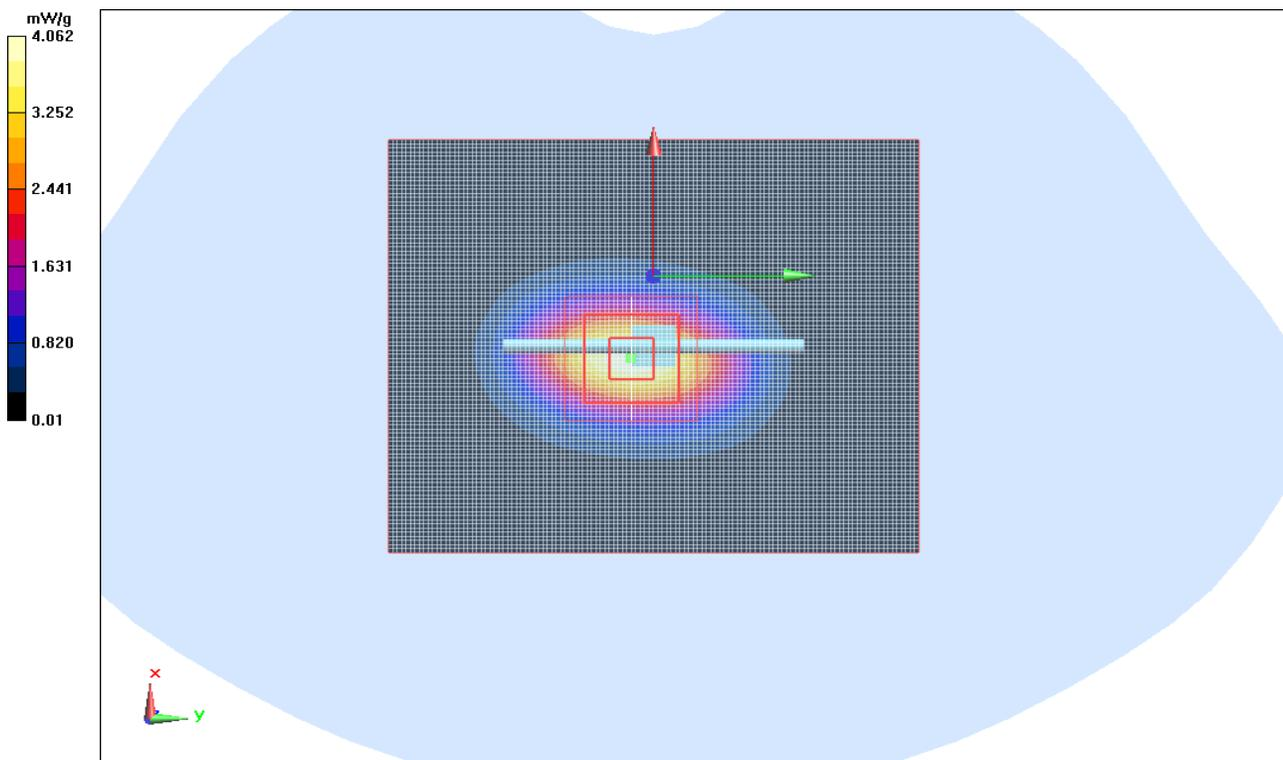

EMC

SAR TEST DATA

Room Temperature (°C):	22.3	Humidity (%):	34.6	Test Date:	02/17/11
Liquid Temperature (°C):	22.1	Barometric Pressure (mb):	1007.7	Tested by:	Jennifer Herrett

HSL900 System Check_835MHz 2-17-11

DUT: Dipole 835 MHz D835V2; Type: D835V2; Serial: D835V2 - SN:4d108

Communication System: CW; Frequency: 835 MHz

Medium parameters used: $f = 835$ MHz; $\sigma = 0.88$ mho/m; $\epsilon = 41.507$; $\rho = 1000$ kg/m³, Medium parameters used: $\sigma = 0.879697$ mho/m, $\epsilon = 41.5068$; $\rho = 1000$ kg/m³

Phantom section: Flat Section

Measurement Standard: DASYS (IEEE/IEC/ANSI C63.19-2007)

DASYS Configuration:

Probe: ES3DV3 - SN3246; ConvF(6.04, 6.04, 6.04); Calibrated: 11/11/2010

Sensor-Surface: 5mm (Mechanical Surface Detection), Sensor-Surface: 0mm (Fix Surface)

Electronics: DAE4 Sn1237; Calibrated: 11/10/2010

Phantom: SAM with CRP; Type: SAM; Serial: 1598

Measurement SW: DASYS2, Version 52.6 (1); SEMCAD X Version 14.4.2 (2595)

System Check/System Check/Zoom Scan (7x7x7) (7x7x7)/Cube 0: Measurement grid: dx=5mm, dy=5mm, dz=5mm

Reference Value = 33.988 V/m; Power Drift = -0.00052 dB

Peak SAR (extrapolated) = 1.413 W/kg

SAR(1 g) = 0.986 mW/g; SAR(10 g) = 0.655 mW/g

Maximum value of SAR (measured) = 0.992 mW/g

System Check/System Check/Area Scan (121x181x1): Measurement grid: dx=10mm, dy=10mm

Maximum value of SAR (interpolated) = 0.995 mW/g

System Check/System Check/Z Scan (1x1x21): Measurement grid: dx=20mm, dy=20mm, dz=5mm

Maximum value of Total (measured) = 36.861 V/m

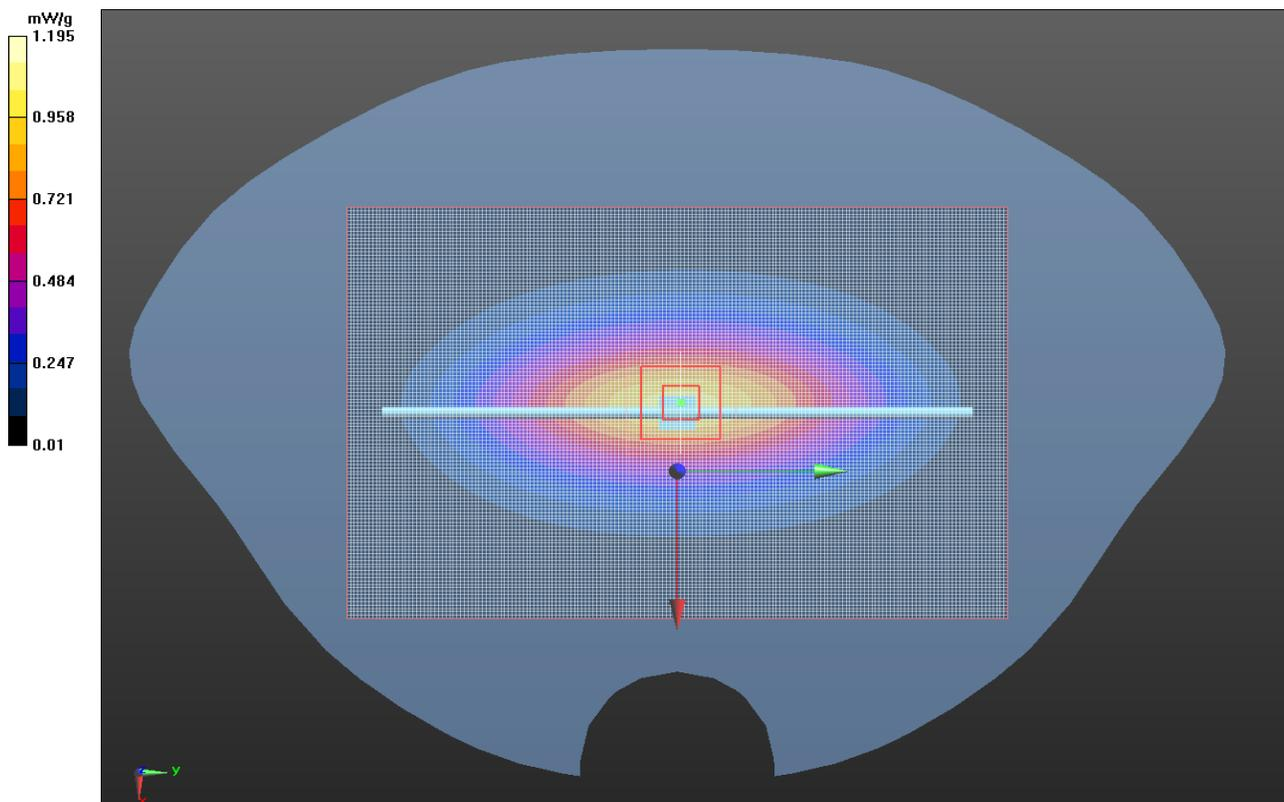

Room Temperature (°C):	22.3	Humidity (%):	35	Test Date:	02/18/11
Liquid Temperature (°C):	21.5	Barometric Pressure (mb):	1009.7	Tested by:	Jennifer Herrett

MSL1900 System Check 2-18-11

DUT: Dipole 1900 MHz D1900V2; Type: D1900V2; Serial: D1900V2 - SN:1040

Communication System: CW; Frequency: 1900 MHz

Medium parameters used: $f = 1900$ MHz; $\sigma = 1.507$ mho/m; $\epsilon = 53.398$; $\rho = 1000$ kg/m³, Medium parameters used: $\sigma = 1.50742$ mho/m, $\epsilon = 53.3981$; $\rho = 1000$ kg/m³

Phantom section: Flat Section

Measurement Standard: DASYS5 (IEEE/IEC/ANSI C63.19-2007)

DASYS5 Configuration:

Probe: ES3DV3 - SN3246; ConvF(4.63, 4.63, 4.63); Calibrated: 11/11/2010

Sensor-Surface: 5mm (Mechanical Surface Detection), Sensor-Surface: 0mm (Fix Surface)

Electronics: DAE4 Sn1237; Calibrated: 11/10/2010

Phantom: ELI 4.0; Type: QDOVA001BA; Serial: 1096

Measurement SW: DASYS2, Version 52.6 (1); SEMCAD X Version 14.4.2 (2595)

System Check/System Check/Area Scan (101x121x1): Measurement grid: dx=10mm, dy=10mm

Maximum value of SAR (interpolated) = 4.316 mW/g

System Check/System Check/Zoom Scan (7x7x7) (7x7x7)/Cube 0: Measurement grid: dx=5mm, dy=5mm, dz=5mm

Reference Value = 52.723 V/m; Power Drift = -0.06 dB

Peak SAR (extrapolated) = 8.023 W/kg

SAR(1 g) = 4.24 mW/g; SAR(10 g) = 2.2 mW/g

Maximum value of SAR (measured) = 4.232 mW/g

System Check/System Check/Z Scan (1x1x21): Measurement grid: dx=20mm, dy=20mm, dz=5mm

Maximum value of Total (measured) = 58.905 V/m

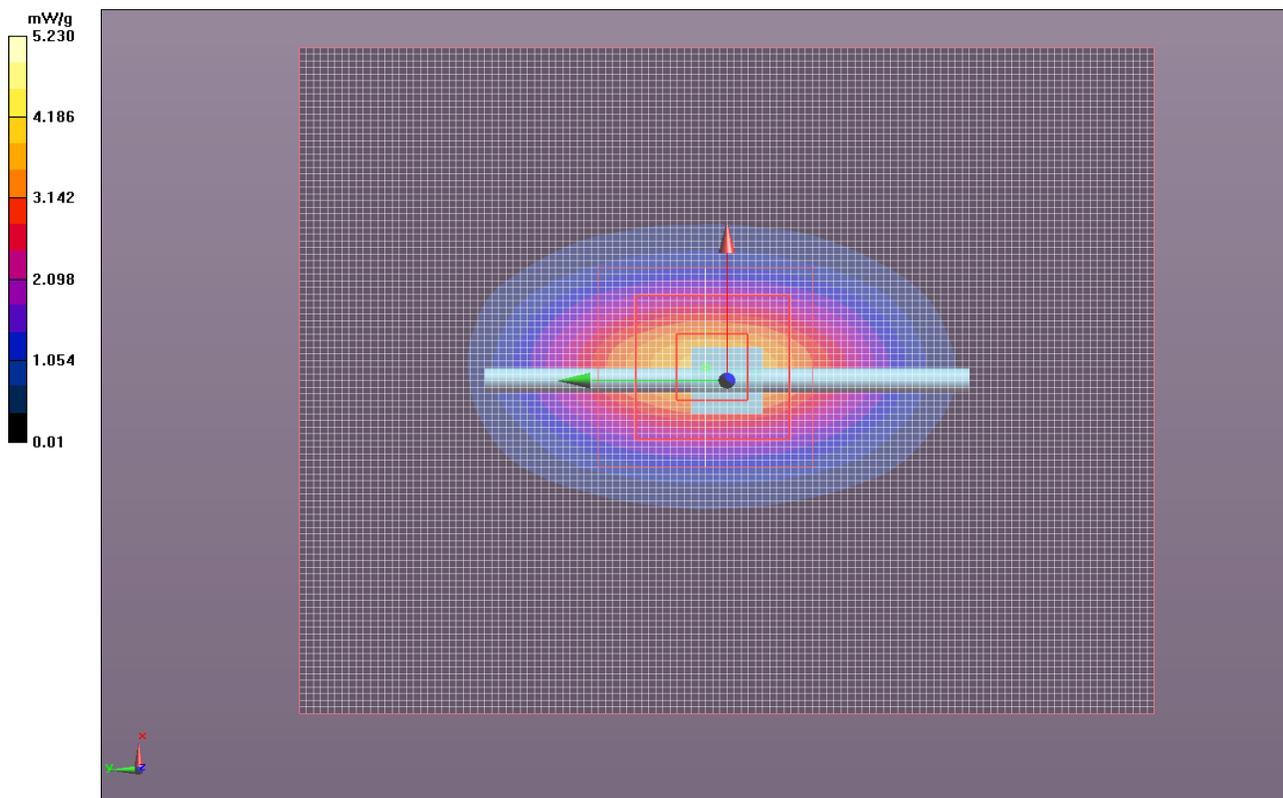

EMC

SAR TEST DATA

Room Temperature (°C):	22.7	Humidity (%):	36.6	Test Date:	02/18/11
Liquid Temperature (°C):	21.9	Barometric Pressure (mb):	1010.2	Tested by:	Jennifer Herrett

HSL900 System Check_835MHz 2-18-11

DUT: Dipole 835 MHz D835V2; Type: D835V2; Serial: D835V2 - SN:4d108

Communication System: CW; Frequency: 835 MHz

Medium parameters used: $f = 835$ MHz; $\sigma = 0.873$ mho/m; $\epsilon = 41.121$; $\rho = 1000$ kg/m³, Medium parameters used: $\sigma = 0.873463$ mho/m, $\epsilon = 41.1209$; $\rho = 1000$ kg/m³

Phantom section: Flat Section

Measurement Standard: DASYS5 (IEEE/IEC/ANSI C63.19-2007)

DASYS5 Configuration:

Probe: ES3DV3 - SN3246; ConvF(6.04, 6.04, 6.04); Calibrated: 11/11/2010

Sensor-Surface: 5mm (Mechanical Surface Detection), Sensor-Surface: 0mm (Fix Surface)

Electronics: DAE4 Sn1237; Calibrated: 11/10/2010

Phantom: SAM with CRP; Type: SAM; Serial: 1598

Measurement SW: DASYS2, Version 52.6 (1); SEMCAD X Version 14.4.2 (2595)

System Check/System Check/Zoom Scan (7x7x7) (7x7x7)/Cube 0: Measurement grid: dx=5mm, dy=5mm, dz=5mm

Reference Value = 34.953 V/m; Power Drift = -0.17 dB

Peak SAR (extrapolated) = 1.421 W/kg

SAR(1 g) = 0.988 mW/g; SAR(10 g) = 0.655 mW/g

Maximum value of SAR (measured) = 0.989 mW/g

System Check/System Check/Area Scan (121x181x1): Measurement grid: dx=10mm, dy=10mm

Maximum value of SAR (interpolated) = 0.998 mW/g

System Check/System Check/Z Scan (1x1x21): Measurement grid: dx=20mm, dy=20mm, dz=5mm

Maximum value of Total (measured) = 37.451 V/m

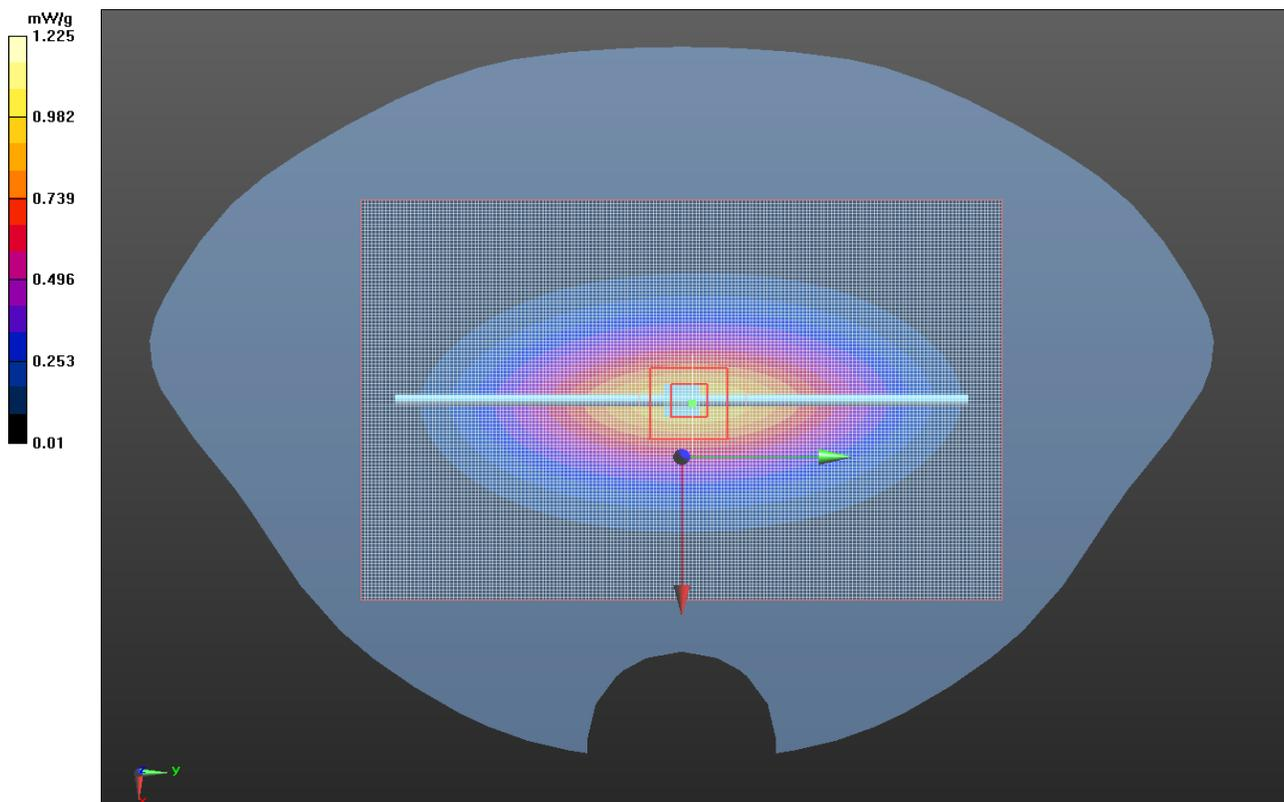

Room Temperature (°C):	23.2	Humidity (%):	34	Test Date:	02/19/11
Liquid Temperature (°C):	22.7	Barometric Pressure (mb):	1010.4	Tested by:	Jennifer Herrett

MSL900 System Check_835MHz 2-19-11

DUT: Dipole 835 MHz D835V2; Type: D835V2; Serial: D835V2 - SN:4d108x

Communication System: CW; Frequency: 835 MHz

Medium parameters used: $f = 835$ MHz; $\sigma = 0.999$ mho/m; $\epsilon = 55.797$; $\rho = 1000$ kg/m³, Medium parameters used: $\sigma = 0.998721$ mho/m, $\epsilon = 55.7969$; $\rho = 1000$ kg/m³

Phantom section: Flat Section

Measurement Standard: DASYS (IEEE/IEC/ANSI C63.19-2007)

DASYS Configuration:

Probe: ES3DV3 - SN3246; ConvF(6.1, 6.1, 6.1); Calibrated: 11/11/2010

Sensor-Surface: 5mm (Mechanical Surface Detection), Sensor-Surface: 0mm (Fix Surface)

Electronics: DAE4 Sn1237; Calibrated: 11/10/2010

Phantom: ELI 4.0; Type: QDOVA001BA; Serial: 1096

Measurement SW: DASYS2, Version 52.6 (1); SEMCAD X Version 14.4.2 (2595)

System Check/System Check/Area Scan (121x181x1): Measurement grid: dx=10mm, dy=10mm

Maximum value of SAR (interpolated) = 1.014 mW/g

System Check/System Check/Z Scan (1x1x21): Measurement grid: dx=20mm, dy=20mm, dz=5mm

Maximum value of Total (measured) = 32.943 V/m

System Check/System Check/Zoom Scan (7x7x7) (7x7x7)/Cube 0: Measurement grid: dx=5mm, dy=5mm, dz=5mm

Reference Value = 32.057 V/m; Power Drift = -0.08 dB

Peak SAR (extrapolated) = 1.462 W/kg

SAR(1 g) = 1 mW/g; SAR(10 g) = 0.660 mW/g

Maximum value of SAR (measured) = 1.004 mW/g

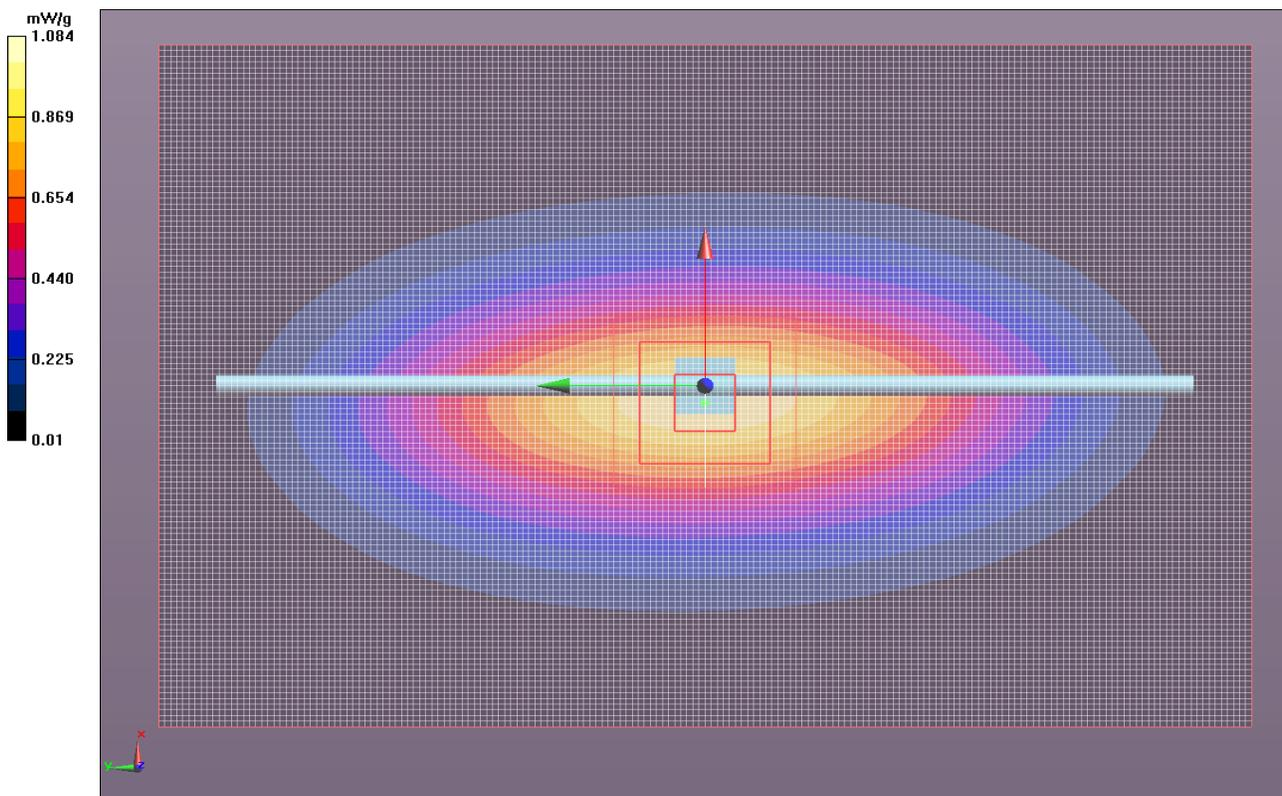

EMC

SAR TEST DATA

Room Temperature (°C):	23	Humidity (%):	34.5	Test Date:	02/19/11
Liquid Temperature (°C):	22.5	Barometric Pressure (mb):	1010	Tested by:	Jennifer Herrett

HSL900 System Check_835MHz 2-19-11

DUT: Dipole 835 MHz D835V2; Type: D835V2; Serial: D835V2 - SN:4d108

Communication System: CW; Frequency: 835 MHz

Medium parameters used: $f = 835$ MHz; $\sigma = 0.873$ mho/m; $\epsilon = 41.031$; $\rho = 1000$ kg/m³, Medium parameters used: $\sigma = 0.873417$ mho/m, $\epsilon = 41.0308$; $\rho = 1000$ kg/m³

Phantom section: Flat Section

Measurement Standard: DASYS5 (IEEE/IEC/ANSI C63.19-2007)

DASY5 Configuration:

Probe: ES3DV3 - SN3246; ConvF(6.04, 6.04, 6.04); Calibrated: 11/11/2010

Sensor-Surface: 5mm (Mechanical Surface Detection), Sensor-Surface: 0mm (Fix Surface)

Electronics: DAE4 Sn1237; Calibrated: 11/10/2010

Phantom: SAM with CRP; Type: SAM; Serial: 1598

Measurement SW: DASYS2, Version 52.6 (1); SEMCAD X Version 14.4.2 (2595)

System Check/System Check/Zoom Scan (7x7x7) (7x7x7)/Cube 0: Measurement grid: dx=5mm, dy=5mm, dz=5mm

Reference Value = 32.843 V/m; Power Drift = -0.03 dB

Peak SAR (extrapolated) = 1.366 W/kg

SAR(1 g) = 0.957 mW/g; SAR(10 g) = 0.634 mW/g

Maximum value of SAR (measured) = 0.963 mW/g

System Check/System Check/Area Scan (121x181x1): Measurement grid: dx=10mm, dy=10mm

Maximum value of SAR (interpolated) = 0.960 mW/g

System Check/System Check/Z Scan (1x1x21): Measurement grid: dx=20mm, dy=20mm, dz=5mm

Maximum value of Total (measured) = 35.519 V/m

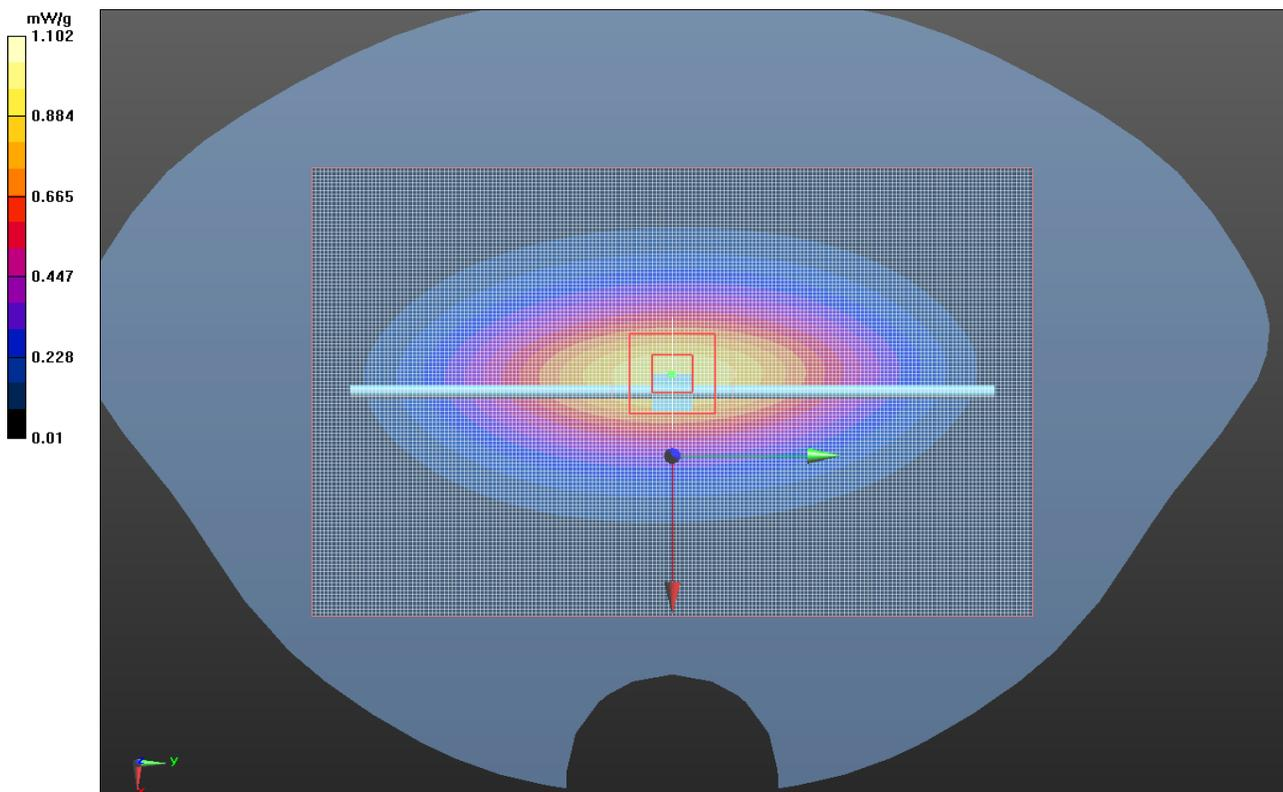

Test Configurations

In normal operation, the EUT can be held in the hand, or next to the head like a cellular handset, or worn on the body. The only Intermec approved accessory for body worn operation is a holster that contains metal. The EUT can only fit in the holster with the top end of the unit pointing down. The holster cup can be attached to the holster belt with either the keypad facing the user, or the side facing the user. In no case can the back of the EUT face the user. For body worn operation, the keypad side was tested. The holster provides 1.5 mm spacing from the keypad side to the flat phantom.

The CDMA antenna is on the left side of the EUT. The closest portion of the antenna is more than 5 cm from the right side of the unit. So for body worn operation, in addition to the keypad side, the left side was also tested. The holster provides 1.2 mm spacing from the left side to the flat phantom.

An optional snap-on audio accessory is available. It connects to the bottom end of the unit and provides a standard audio jack for connection of a VR10 headset. Measurements were made with and without the headset. Measured SAR increased slightly with the headset so all body configurations were tested with the headset.

The EUT is powered by a lithium-ion battery, Model 1000AB01. It was fully charged before each SAR evaluation.

Per KDB 648474, among the channels required for normal testing, SAR must be measured on the highest conducted output power channel in each band (see highlighted values in the Output Power section of this report). When the SAR measured on the highest output channel is < 0.8 W/kg, SAR evaluation for the other required channels is unnecessary.

All testing was performed with the EUT configured in a worst-case configuration and operating mode to produce the highest SAR levels. An Agilent 8960 test set, Model E5515C, was used to control the EUT. The following applications were installed on the test set: CDMA200 Mobile Test Rev B.17.08, and EVDO Term Test Rev A.12.08. This provided all the necessary tools to operate the EUT in the prescribed manner without any difficulties or equipment limitations.

Summary

The following tables summarize the measured SAR values.

SAR TEST DATA

EUT: 1000CP01C	Work Order: INMC0681
Serial Number: 24411047084	Date: See Data Sheets
Customer: Intermec Technologies	Temperature: See Data Sheets
Attendees: None	Humidity: See Data Sheets
Project: INMC0570	Barometric Pres.: See Data Sheets
Tested by: Jennifer Herrett	Job Site: EV08
TEST SPECIFICATIONS	
FCC 2.1093:2011	Test Method FCC OET 65C:2001 IEEE Std 1528:2003 FCC KDB 447498 D01 v04 FCC KDB 941225 D01 v02 FCC KDB 648474 D01 V01r05
Health Safety Code 6:2009	RSS-102, Issue 4:2010
COMMENTS	
None	
DEVIATIONS FROM TEST STANDARD	
No Deviations	
Configuration #	1
	Signature <i>Jennifer Herrett</i>

Test Configuration	Form	Transmit Frequency	Transmit Channel	Transmit Mode	Data Rate (kbps)	Side	EUT Position	Start Power (Conducted)	SAR Drift During Test (dB)	1g SAR Level	Test #	
Head	A1	836.52	384	RC3 (Fwd 3, Rvs 3) SO55 (Loopback)	9.6	Left	Cheek	24.05	0.06	0.248	1	
							Tilt	24.05	0.17	0.238	2	
						Right	Cheek	24.05	-0.08	0.419	3	
							Tilt	24.05	0.17	0.381	4	
		A1	836.52	384	EV-DO Rev. A	FETAP: 307.2 RETAP: 4096 payload	Left	Cheek	24.14	0.12	0.272	5
					Tilt			24.14	0.03	0.281	6	
		A1	836.52	384	EV-DO Rev. A		Right	Cheek	24.14	-0.19	0.482	7
								Tilt	24.14	0.07	0.475	8

EMC

SAR TEST DATA

Room Temperature (°C):	24.5	Humidity (%):	40.9	Test Date:	02/09/11
Liquid Temperature (°C):	22	Barometric Pressure (mb):	1032	Tested by:	Jennifer Herrett

Test 1

DUT: 1000CP01C; CN70; Type: Handheld Computer; Serial: 24411047084

Communication System: CW; Frequency: 836.52 MHz

Medium parameters used: $\sigma = 0.883813$ mho/m, $\epsilon_r = 42.0572$; $\rho = 1000$ kg/m³, Medium parameters used (interpolated): $f = 836.52$ MHz; $\sigma = 0.885$ mho/m; $\epsilon_r =$

Phantom section: Left Section

Measurement Standard: DASYS5 (IEEE/IEC/ANSI C63.19-2007)

DASY5 Configuration:

Probe: ES3DV3 - SN3246; ConvF(6.04, 6.04, 6.04); Calibrated: 11/11/2010

Sensor-Surface: 0mm (Fix Surface), Sensor-Surface: 3mm (Mechanical Surface Detection)

Electronics: DAE4 Sn1237; Calibrated: 11/10/2010

Phantom: SAM with CRP; Type: SAM; Serial: 1598

Measurement SW: DASYS2, Version 52.6 (1); SEMCAD X Version 14.4.2 (2595)

Head - Left/Cheek - Mid/Z Scan (1x1x21): Measurement grid: dx=20mm, dy=20mm, dz=5mm

Maximum value of Total (measured) = 14.934 V/m

Head - Left/Cheek - Mid/Reference scan (51x61x1): Measurement grid: dx=30mm, dy=30mm

[Info: Interpolated medium parameters used for SAR evaluation.](#)

Maximum value of SAR (interpolated) = 4.080 mW/g

Head - Left/Cheek - Mid/Area scan (71x71x1): Measurement grid: dx=15mm, dy=15mm

[Info: Interpolated medium parameters used for SAR evaluation.](#)

Maximum value of SAR (interpolated) = 0.282 mW/g

Head - Left/Cheek - Mid/Zoom Scan (8x7x7)/Cube 0: Measurement grid: dx=5mm, dy=5mm, dz=5mm

Reference Value = 14.489 V/m; Power Drift = 0.06 dB

Peak SAR (extrapolated) = 0.332 W/kg

SAR(1 g) = 0.248 mW/g; SAR(10 g) = 0.173 mW/g

[Info: Interpolated medium parameters used for SAR evaluation.](#)

Maximum value of SAR (measured) = 0.281 mW/g

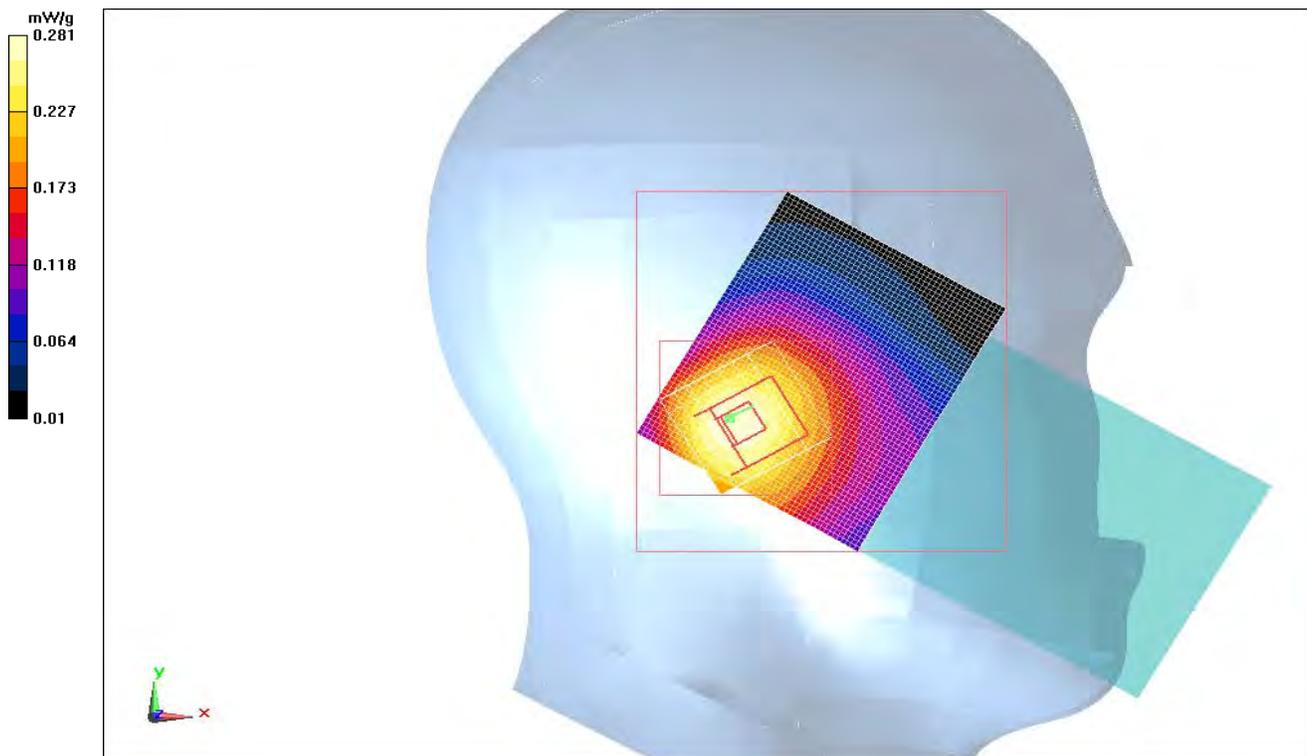

Room Temperature (°C):	24.7	Humidity (%):	31.1	Test Date:	02/09/11
Liquid Temperature (°C):	21.6	Barometric Pressure (mb):	1032	Tested by:	Jennifer Herrett

Test 2

DUT: 1000CP01C; CN70; Type: Handheld Computer; Serial: 24411047084

Communication System: CW; Frequency: 836.52 MHz

Medium parameters used (interpolated): $f = 836.52$ MHz; $\sigma = 0.885$ mho/m; $\epsilon_r = 42.038$; $\rho = 1000$ kg/m³, Medium parameters used: $\sigma = 0.883813$ mho/m, $\epsilon_r = 42.0572$; $\rho = 1000$ kg/m³

Phantom section: Left Section

Measurement Standard: DASYS (IEEE/IEC/ANSI C63.19-2007)

DASY5 Configuration:

Probe: ES3DV3 - SN3246; ConvF(6.04, 6.04, 6.04); Calibrated: 11/11/2010

Sensor-Surface: 3mm (Mechanical Surface Detection), Sensor-Surface: 0mm (Fix Surface)

Electronics: DAE4 Sn1237; Calibrated: 11/10/2010

Phantom: SAM with CRP; Type: SAM; Serial: 1598

Measurement SW: DASY52, Version 52.6 (1); SEMCAD X Version 14.4.2 (2595)

Head - Left/Tilt - Mid/Area scan (71x71x1): Measurement grid: dx=15mm, dy=15mm

[Info: Interpolated medium parameters used for SAR evaluation.](#)

Maximum value of SAR (interpolated) = 0.271 mW/g

Head - Left/Tilt - Mid/Z Scan (1x1x21): Measurement grid: dx=20mm, dy=20mm, dz=5mm

Maximum value of Total (measured) = 14.649 V/m

Head - Left/Tilt - Mid/Reference scan (51x61x1): Measurement grid: dx=30mm, dy=30mm

[Info: Interpolated medium parameters used for SAR evaluation.](#)

Maximum value of SAR (interpolated) = 4.468 mW/g

Head - Left/Tilt - Mid/Zoom Scan (7x7x7)/Cube 0: Measurement grid: dx=5mm, dy=5mm, dz=5mm

Reference Value = 15.787 V/m; Power Drift = 0.17 dB

Peak SAR (extrapolated) = 0.341 W/kg

SAR(1 g) = 0.238 mW/g; SAR(10 g) = 0.161 mW/g

[Info: Interpolated medium parameters used for SAR evaluation.](#)

Maximum value of SAR (measured) = 0.274 mW/g

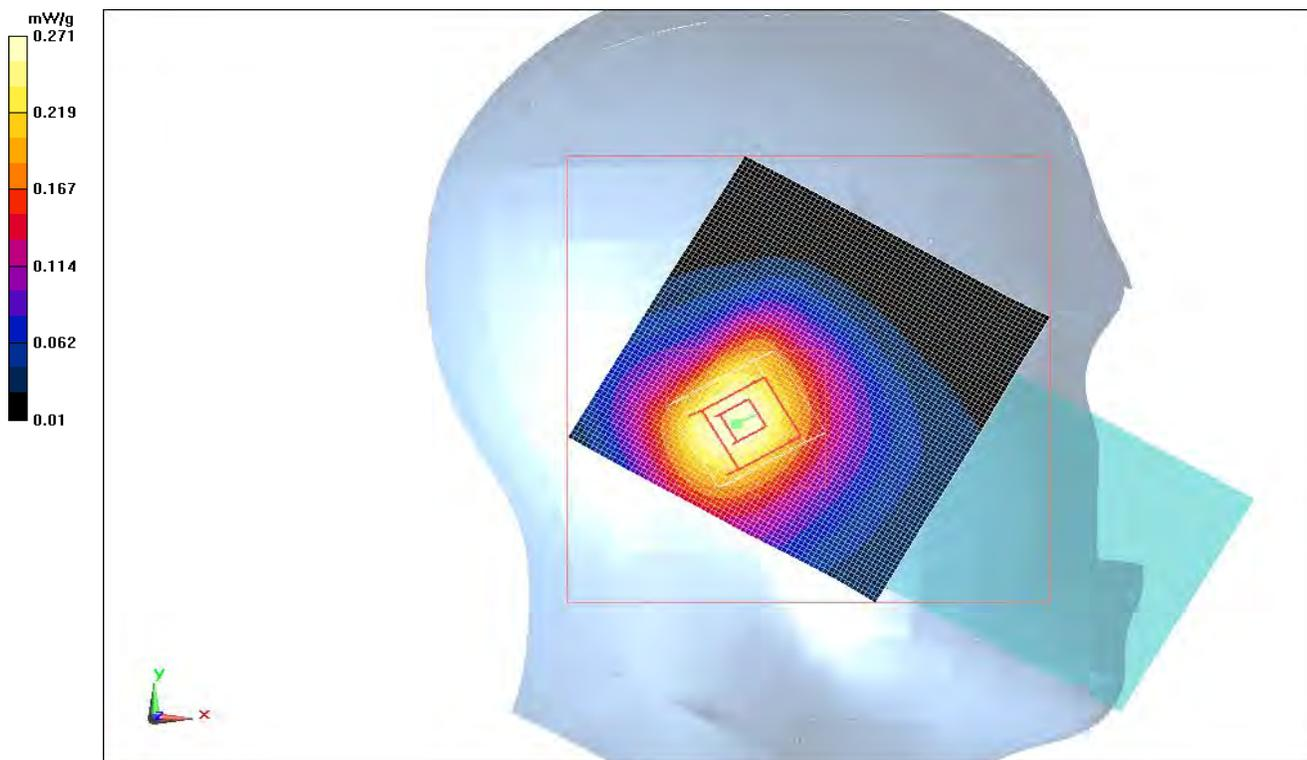

Room Temperature (°C):	21.7	Humidity (%):	37.8	Test Date:	02/09/11
Liquid Temperature (°C):	20.5	Barometric Pressure (mb):	1033	Tested by:	Jennifer Herrett

Test 3

DUT: 1000CP01C; CN70; Type: Handheld Computer; Serial: 24411047084

Communication System: CW; Frequency: 836.52 MHz

Medium parameters used: $\sigma = 0.883813$ mho/m, $\epsilon_r = 42.0572$; $\rho = 1000$ kg/m³, Medium parameters used (interpolated): $f = 836.52$ MHz; $\sigma = 0.885$ mho/m; $\epsilon_r = 42.038$; $\rho = 1000$ kg/m³

Phantom section: Right Section

Measurement Standard: DASYS (IEEE/IEC/ANSI C63.19-2007)

DASY5 Configuration:

Probe: ES3DV3 - SN3246; ConvF(6.04, 6.04, 6.04); Calibrated: 11/11/2010

Sensor-Surface: 0mm (Fix Surface), Sensor-Surface: 3mm (Mechanical Surface Detection)

Electronics: DAE4 Sn1237; Calibrated: 11/10/2010

Phantom: SAM with CRP; Type: SAM; Serial: 1598

Measurement SW: DASY52, Version 52.6 (1); SEMCAD X Version 14.4.2 (2595)

Head - Right/Cheek - Mid/Z Scan (1x1x21): Measurement grid: dx=20mm, dy=20mm, dz=5mm

Maximum value of Total (measured) = 19.677 V/m

Head - Right/Cheek - Mid/Reference scan (51x61x1): Measurement grid: dx=30mm, dy=30mm

[Info: Interpolated medium parameters used for SAR evaluation.](#)

Maximum value of SAR (interpolated) = 0.441 mW/g

Head - Right/Cheek - Mid/Area scan (71x71x1): Measurement grid: dx=15mm, dy=15mm

[Info: Interpolated medium parameters used for SAR evaluation.](#)

Maximum value of SAR (interpolated) = 0.486 mW/g

Head - Right/Cheek - Mid/Zoom Scan (7x7x7)/Cube 0: Measurement grid: dx=5mm, dy=5mm, dz=5mm

Reference Value = 17.034 V/m; Power Drift = -0.08 dB

Peak SAR (extrapolated) = 0.592 W/kg

SAR(1 g) = 0.419 mW/g; SAR(10 g) = 0.281 mW/g

[Info: Interpolated medium parameters used for SAR evaluation.](#)

Maximum value of SAR (measured) = 0.483 mW/g

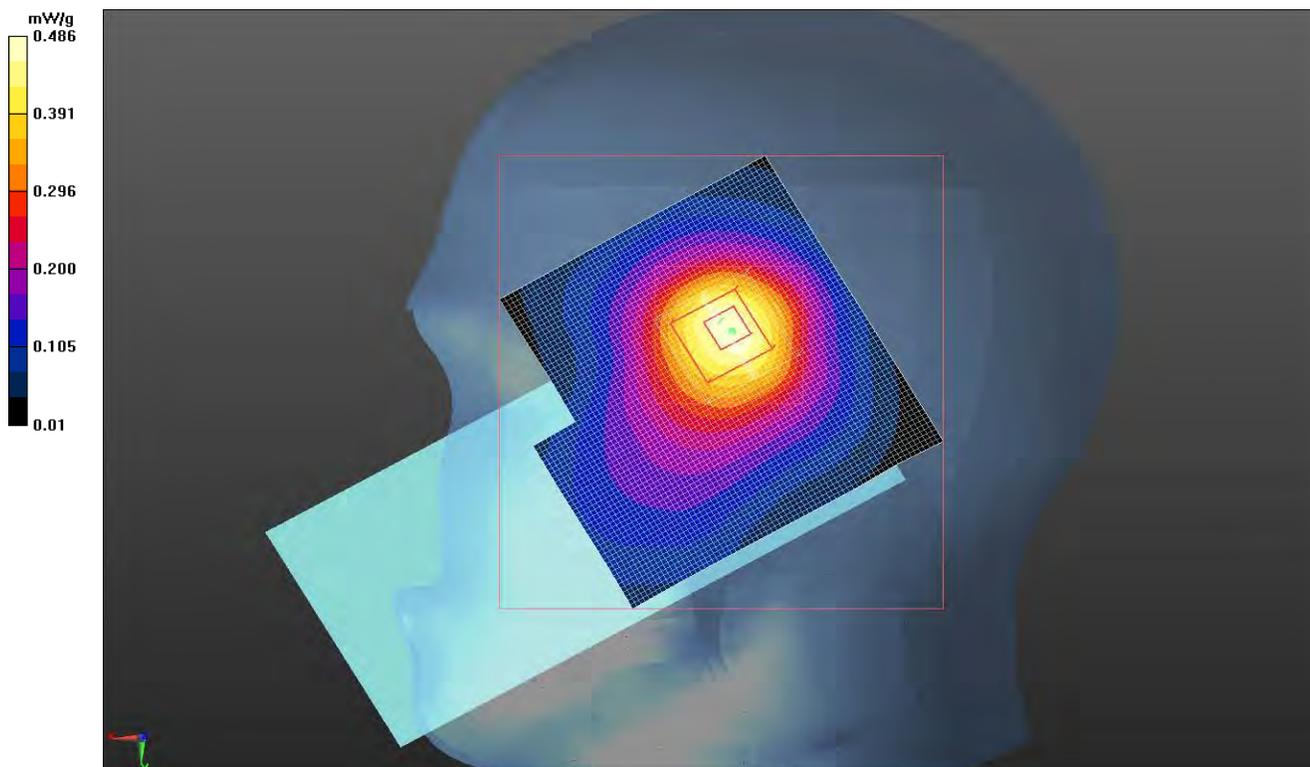

Room Temperature (°C):	23.9	Humidity (%):	42.4	Test Date:	02/11/11
Liquid Temperature (°C):	21	Barometric Pressure (mb):	1032	Tested by:	Jennifer Herrett

Test 4

DUT: 1000CP01C; CN70; Type: Handheld Computer; Serial: 24411047084

Communication System: CW; Frequency: 836.52 MHz

Medium parameters used (interpolated): $f = 836.52$ MHz; $\sigma = 0.885$ mho/m; $\epsilon = 42.038$; $\rho = 1000$ kg/m³, Medium parameters used: $\sigma = 0.883813$ mho/m, $\epsilon = 42.0572$; $\rho = 1000$ kg/m³

Phantom section: Right Section

Measurement Standard: DASYS (IEEE/IEC/ANSI C63.19-2007)

DASYS Configuration:

Probe: ES3DV3 - SN3246; ConvF(6.04, 6.04, 6.04); Calibrated: 11/11/2010

Sensor-Surface: 3mm (Mechanical Surface Detection), Sensor-Surface: 0mm (Fix Surface)

Electronics: DAE4 Sn1237; Calibrated: 11/10/2010

Phantom: SAM with CRP; Type: SAM; Serial: 1598

Measurement SW: DASYS2, Version 52.6 (1); SEMCAD X Version 14.4.2 (2595)

Head - Right/Tilt - Mid/Area scan (71x71x1): Measurement grid: dx=15mm, dy=15mm

[Info: Interpolated medium parameters used for SAR evaluation.](#)

Maximum value of SAR (interpolated) = 0.426 mW/g

Head - Right/Tilt - Mid/Z Scan (1x1x21): Measurement grid: dx=20mm, dy=20mm, dz=5mm

Maximum value of Total (measured) = 18.923 V/m

Head - Right/Tilt - Mid/Reference scan (51x61x1): Measurement grid: dx=30mm, dy=30mm

[Info: Interpolated medium parameters used for SAR evaluation.](#)

Maximum value of SAR (interpolated) = 2.587 mW/g

Head - Right/Tilt - Mid/Zoom Scan (7x7x7)/Cube 0: Measurement grid: dx=5mm, dy=5mm, dz=5mm

Reference Value = 19.131 V/m; Power Drift = 0.17 dB

Peak SAR (extrapolated) = 0.518 W/kg

SAR(1 g) = 0.381 mW/g; SAR(10 g) = 0.256 mW/g

[Info: Interpolated medium parameters used for SAR evaluation.](#)

Maximum value of SAR (measured) = 0.437 mW/g

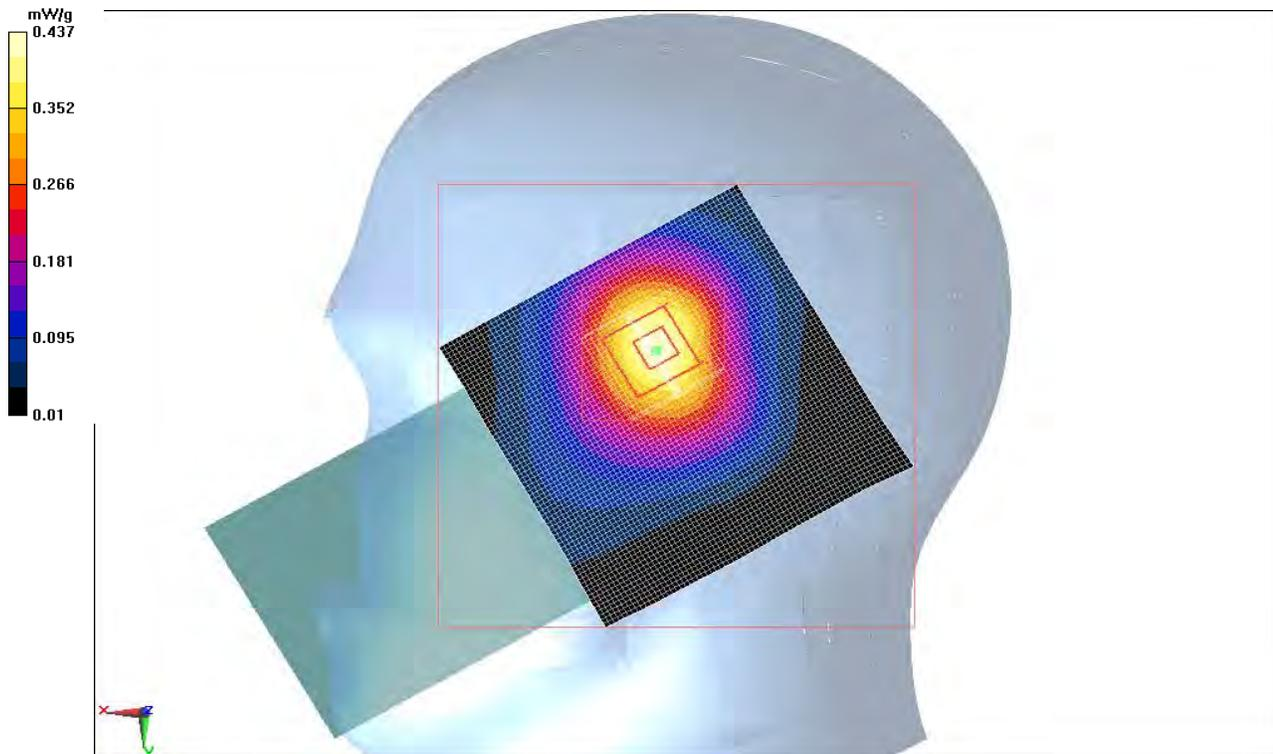

Room Temperature (°C):	21.7	Humidity (%):	38.8	Test Date:	02/10/11
Liquid Temperature (°C):	20.3	Barometric Pressure (mb):	1022	Tested by:	Jennifer Herrett

Test 5

DUT: 1000CP01C; CN70; Type: Handheld Computer; Serial: 24411047084

Communication System: CW; Frequency: 836.52 MHz

Medium parameters used: $\sigma = 0.884189$ mho/m, $\epsilon_r = 41.7001$; $\rho = 1000$ kg/m³, Medium parameters used (interpolated): $f = 836.52$ MHz; $\sigma = 0.886$ mho/m; $\epsilon_r = 41.681$; $\rho = 1000$ kg/m³

Phantom section: Left Section

Measurement Standard: DASYS (IEEE/IEC/ANSI C63.19-2007)

DASY5 Configuration:

Probe: ES3DV3 - SN3246; ConvF(6.04, 6.04, 6.04); Calibrated: 11/11/2010

Sensor-Surface: 0mm (Fix Surface), Sensor-Surface: 3mm (Mechanical Surface Detection)

Electronics: DAE4 Sn1237; Calibrated: 11/10/2010

Phantom: SAM with CRP; Type: SAM; Serial: 1598

Measurement SW: DASY52, Version 52.6 (1); SEMCAD X Version 14.4.2 (2595)

Head - Left/Cheek - Mid/Z Scan (1x1x21): Measurement grid: dx=20mm, dy=20mm, dz=5mm

Maximum value of Total (measured) = 15.753 V/m

Head - Left/Cheek - Mid/Reference scan (51x61x1): Measurement grid: dx=30mm, dy=30mm

[Info: Interpolated medium parameters used for SAR evaluation.](#)

Maximum value of SAR (interpolated) = 0.291 mW/g

Head - Left/Cheek - Mid/Area scan (71x71x1): Measurement grid: dx=15mm, dy=15mm

[Info: Interpolated medium parameters used for SAR evaluation.](#)

Maximum value of SAR (interpolated) = 0.302 mW/g

Head - Left/Cheek - Mid/Zoom Scan (7x7x7)/Cube 0: Measurement grid: dx=5mm, dy=5mm, dz=5mm

Reference Value = 18.852 V/m; Power Drift = 0.12 dB

Peak SAR (extrapolated) = 0.359 W/kg

SAR(1 g) = 0.272 mW/g; SAR(10 g) = 0.191 mW/g

[Info: Interpolated medium parameters used for SAR evaluation.](#)

Maximum value of SAR (measured) = 0.305 mW/g

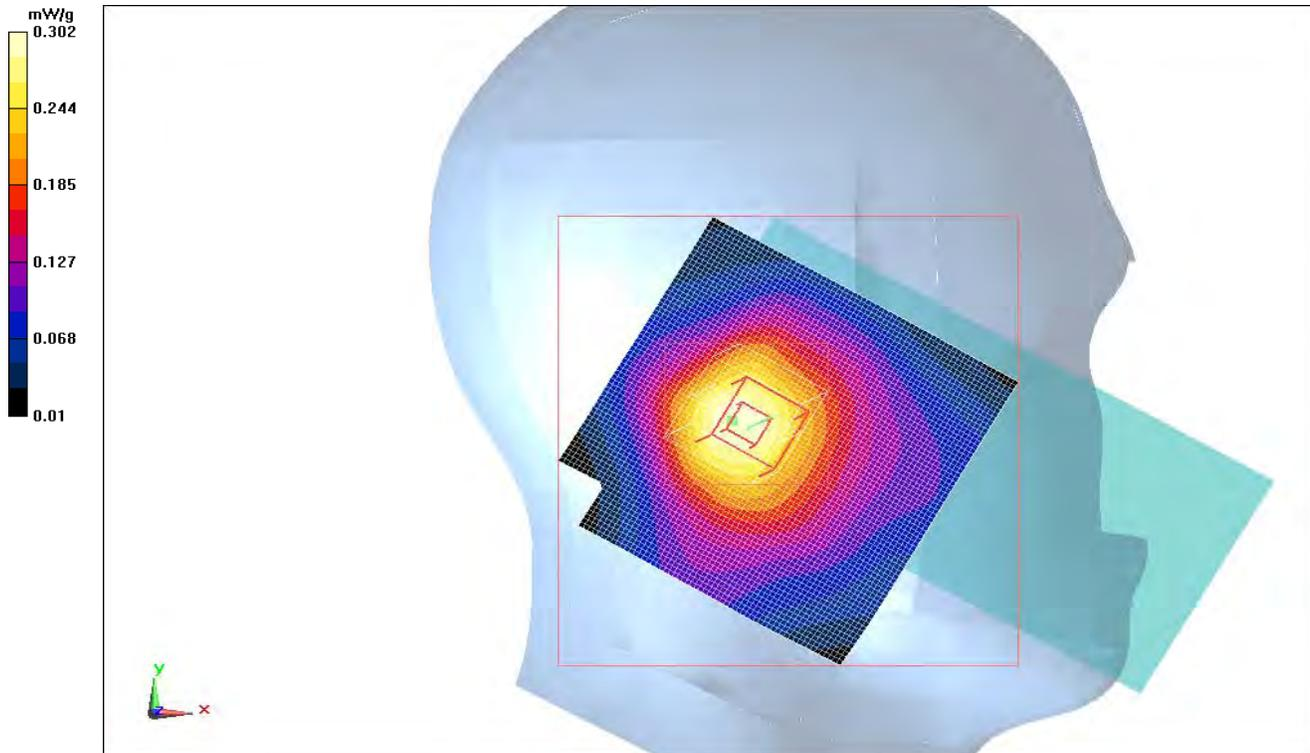

Room Temperature (°C):	22.7	Humidity (%):	41.2	Test Date:	02/11/11
Liquid Temperature (°C):	21.2	Barometric Pressure (mb):	1021	Tested by:	Jennifer Herrett

Test 6

DUT: 1000CP01C; CN70; Type: Handheld Computer; Serial: 24411047084

Communication System: CW; Frequency: 836.52 MHz

Medium parameters used (interpolated): $f = 836.52$ MHz; $\sigma = 0.886$ mho/m; $\epsilon_r = 41.681$; $\rho = 1000$ kg/m³, Medium parameters used: $\sigma = 0.884189$ mho/m, $\epsilon_r = 41.7001$; $\rho = 1000$ kg/m³

Phantom section: Left Section

Measurement Standard: DASYS (IEEE/IEC/ANSI C63.19-2007)

DASY5 Configuration:

Probe: ES3DV3 - SN3246; ConvF(6.04, 6.04, 6.04); Calibrated: 11/11/2010

Sensor-Surface: 3mm (Mechanical Surface Detection), Sensor-Surface: 0mm (Fix Surface)

Electronics: DAE4 Sn1237; Calibrated: 11/10/2010

Phantom: SAM with CRP; Type: SAM; Serial: 1598

Measurement SW: DASY52, Version 52.6 (1); SEMCAD X Version 14.4.2 (2595)

Head - Left/Tilt - Mid/Area scan (71x71x1): Measurement grid: dx=15mm, dy=15mm

[Info: Interpolated medium parameters used for SAR evaluation.](#)

Maximum value of SAR (interpolated) = 0.315 mW/g

Head - Left/Tilt - Mid/Z Scan (1x1x21): Measurement grid: dx=20mm, dy=20mm, dz=5mm

Maximum value of Total (measured) = 15.943 V/m

Head - Left/Tilt - Mid/Reference scan (51x61x1): Measurement grid: dx=30mm, dy=30mm

[Info: Interpolated medium parameters used for SAR evaluation.](#)

Maximum value of SAR (interpolated) = 0.336 mW/g

Head - Left/Tilt - Mid/Zoom Scan (7x7x7)/Cube 0: Measurement grid: dx=5mm, dy=5mm, dz=5mm

Reference Value = 19.946 V/m; Power Drift = 0.03 dB

Peak SAR (extrapolated) = 0.434 W/kg

SAR(1 g) = 0.281 mW/g; SAR(10 g) = 0.190 mW/g

[Info: Interpolated medium parameters used for SAR evaluation.](#)

Maximum value of SAR (measured) = 0.323 mW/g

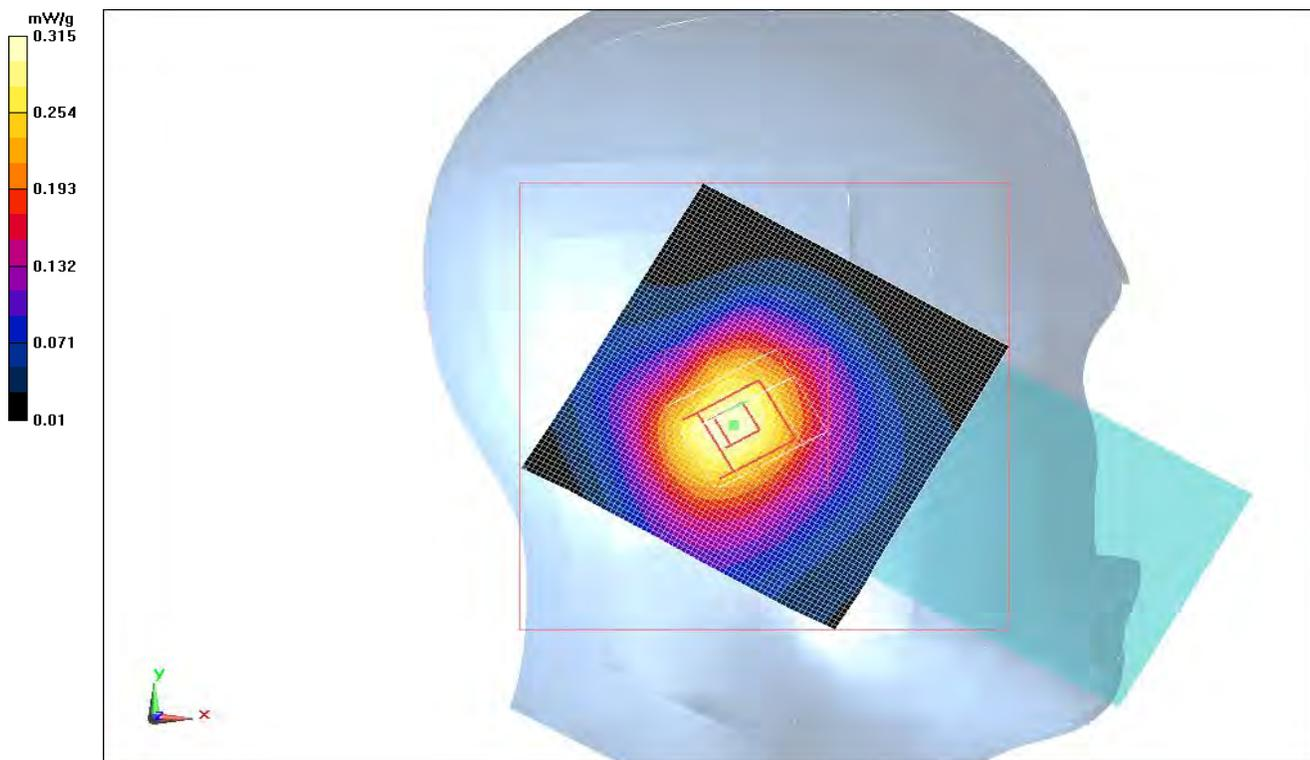

Room Temperature (°C):	25.2	Humidity (%):	31.5	Test Date:	02/10/11
Liquid Temperature (°C):	21.7	Barometric Pressure (mb):	1026	Tested by:	Jennifer Herrett

Test 7

DUT: 1000CP01C; CN70; Type: Handheld Computer; Serial: 24411047084

Communication System: CW; Frequency: 836.52 MHz

Medium parameters used: $\sigma = 0.884189$ mho/m, $\epsilon_r = 41.7001$; $\rho = 1000$ kg/m³, Medium parameters used (interpolated): $f = 836.52$ MHz; $\sigma = 0.886$ mho/m; $\epsilon_r = 41.681$; $\rho = 1000$ kg/m³

Phantom section: Right Section

Measurement Standard: DASYS (IEEE/IEC/ANSI C63.19-2007)

DASY5 Configuration:

Probe: ES3DV3 - SN3246; ConvF(6.04, 6.04, 6.04); Calibrated: 11/11/2010

Sensor-Surface: 0mm (Fix Surface), Sensor-Surface: 3mm (Mechanical Surface Detection)

Electronics: DAE4 Sn1237; Calibrated: 11/10/2010

Phantom: SAM with CRP; Type: SAM; Serial: 1598

Measurement SW: DASY52, Version 52.6 (1); SEMCAD X Version 14.4.2 (2595)

Head - Right/Cheek - Mid/Z Scan (1x1x21): Measurement grid: dx=20mm, dy=20mm, dz=5mm

Maximum value of Total (measured) = 21.154 V/m

Head - Right/Cheek - Mid/Reference scan (51x61x1): Measurement grid: dx=30mm, dy=30mm

[Info: Interpolated medium parameters used for SAR evaluation.](#)

Maximum value of SAR (interpolated) = 0.512 mW/g

Head - Right/Cheek - Mid/Area scan (71x71x1): Measurement grid: dx=15mm, dy=15mm

[Info: Interpolated medium parameters used for SAR evaluation.](#)

Maximum value of SAR (interpolated) = 0.562 mW/g

Head - Right/Cheek - Mid/Zoom Scan (7x7x7)/Cube 0: Measurement grid: dx=5mm, dy=5mm, dz=5mm

Reference Value = 25.893 V/m; Power Drift = -0.19 dB

Peak SAR (extrapolated) = 0.678 W/kg

SAR(1 g) = 0.482 mW/g; SAR(10 g) = 0.322 mW/g

[Info: Interpolated medium parameters used for SAR evaluation.](#)

Maximum value of SAR (measured) = 0.560 mW/g

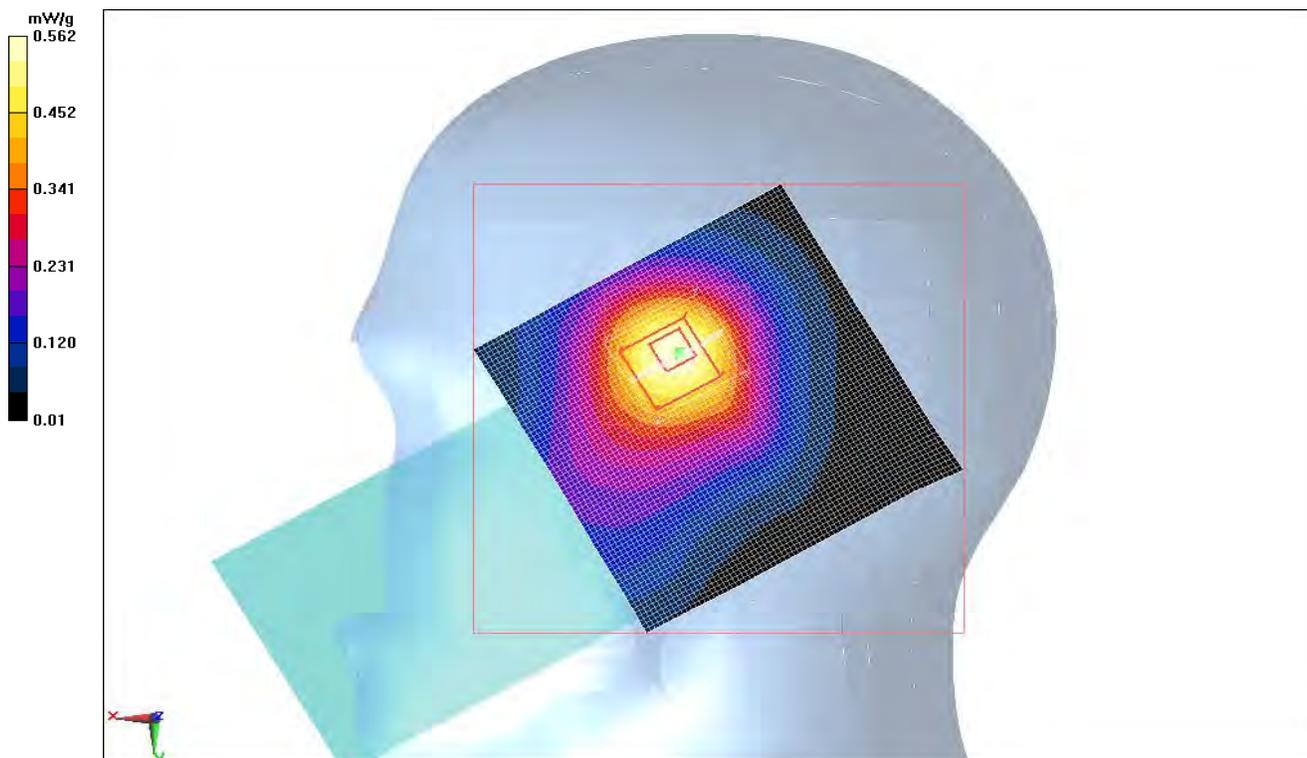

Room Temperature (°C):	22.3	Humidity (%):	38.8	Test Date:	02/10/11
Liquid Temperature (°C):	20.7	Barometric Pressure (mb):	1022	Tested by:	Jennifer Herrett

Test 4 RevA Cellular band Head-right

DUT: 1000CP01C; CN70; Type: Handheld Computer; Serial: 24411047084

Communication System: CW; Frequency: 836.52 MHz
 Medium parameters used (interpolated): $f = 836.52$ MHz; $\sigma = 0.886$ mho/m; $\epsilon_r = 41.681$; $\rho = 1000$ kg/m³
 Phantom section: Right Section
 Measurement Standard: DASYS5 (IEEE/IEC/ANSI C63.19-2007)

DASY5 Configuration:

Probe: ES3DV3 - SN3246; ConvF(6.04, 6.04, 6.04); Calibrated: 11/11/2010
 Sensor-Surface: 3mm (Mechanical Surface Detection)
 Electronics: DAE4 Sn1237; Calibrated: 11/10/2010
 Phantom: SAM with CRP; Type: SAM; Serial: 1598
 Measurement SW: DASYS2, Version 52.6 (1); SEMCAD X Version 14.4.2 (2595)

Head - Right/Tilt - Mid/Area scan (71x71x1): Measurement grid: dx=15mm, dy=15mm

[Info: Interpolated medium parameters used for SAR evaluation.](#)

Maximum value of SAR (interpolated) = 0.543 mW/g

Head - Right/Tilt - Mid/Reference scan (51x61x1): Measurement grid: dx=30mm, dy=30mm

[Info: Interpolated medium parameters used for SAR evaluation.](#)

Maximum value of SAR (interpolated) = 0.553 mW/g

Head - Right/Tilt - Mid/Zoom Scan (7x7x7)/Cube 0: Measurement grid: dx=5mm, dy=5mm, dz=5mm

Reference Value = 25.086 V/m; Power Drift = 0.07 dB

Peak SAR (extrapolated) = 0.685 W/kg

SAR(1 g) = 0.475 mW/g; SAR(10 g) = 0.322 mW/g

[Info: Interpolated medium parameters used for SAR evaluation.](#)

Maximum value of SAR (measured) = 0.541 mW/g

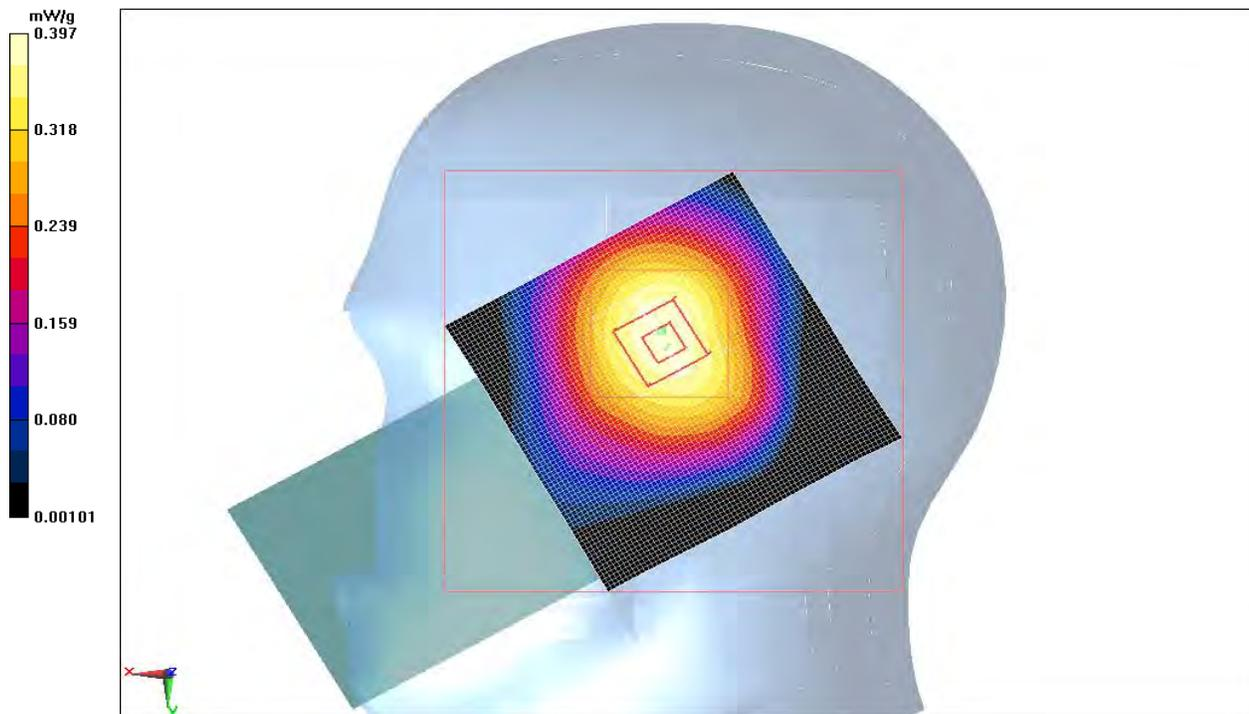

EMC

SAR TEST DATA

Room Temperature (°C):	25.2	Humidity (%):	31.5	Test Date:	02/10/11
Liquid Temperature (°C):	21.7	Barometric Pressure (mb):	1026	Tested by:	Jennifer Herrett

Test 7

DUT: 1000CP01C; CN70; Type: Handheld Computer; Serial: 24411047084

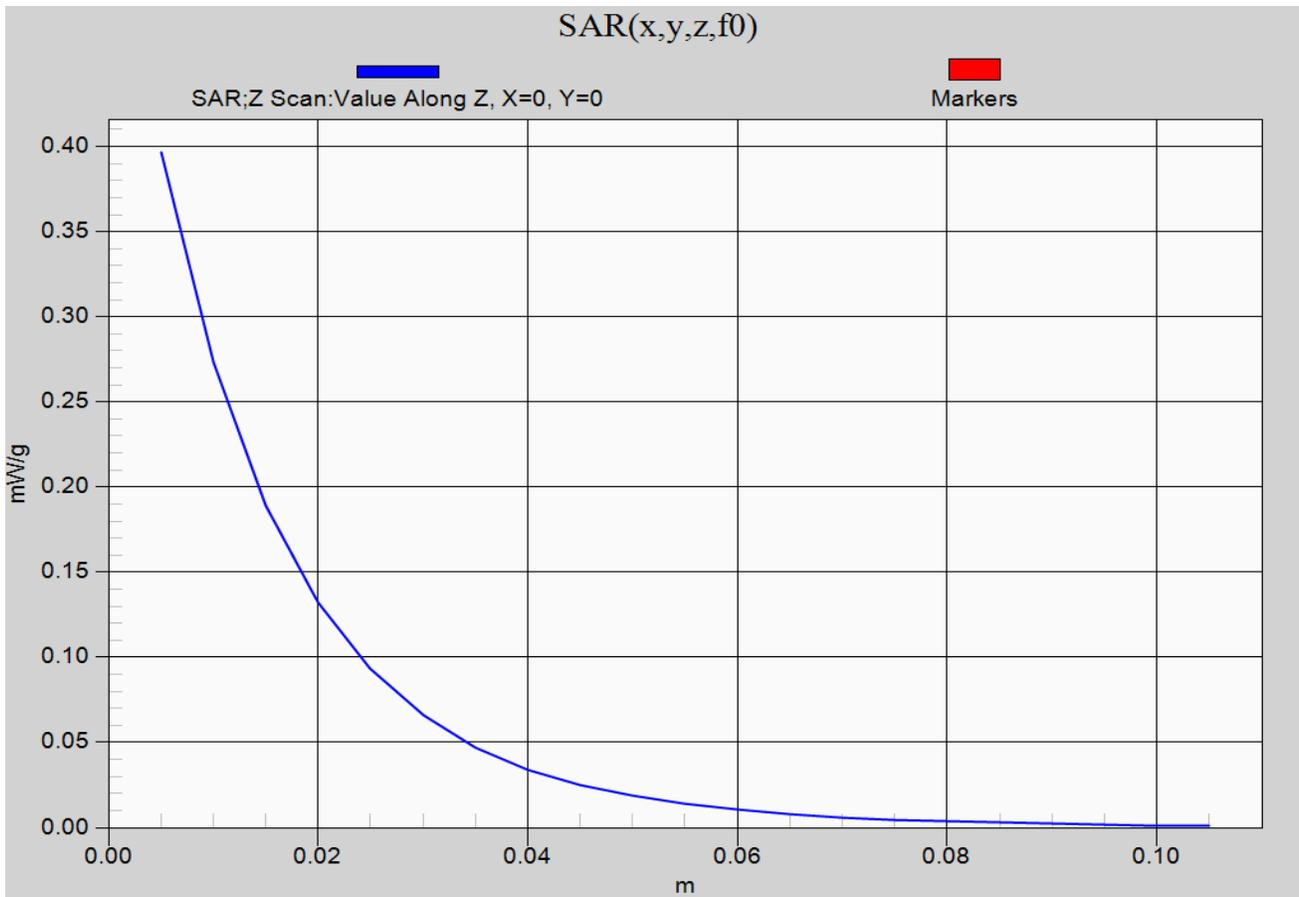

SAR TEST DATA

EMC

EUT: 1000CP01C	Work Order: INMC0683
Serial Number: 24411047084	Date: See Data Sheets
Customer: Intermec Technologies	Temperature: See Data Sheets
Attendees: None	Humidity: See Data Sheets
Project: INMC0570	Barometric Pres.: See Data Sheets
Tested by: Jennifer Herrett	Job Site: EV08

TEST SPECIFICATIONS	Test Method
FCC 2.1093:2011	FCC OET 65C:2001 IEEE Std 1528:2003 FCC KDB 447498 D01 v04 FCC KDB 941225 D01 v02 FCC KDB 648474 D01 V01r05

Health Safety Code 6:2009 RSS-102, Issue 4:2010

COMMENTS

None

DEVIATIONS FROM TEST STANDARD

No Deviations

Configuration #	1	Signature <i>Jennifer Herrett</i>
-----------------	---	-----------------------------------

Test Configuration	Form	Transmit Frequency	Transmit Channel	Transmit Mode	Data Rate (kbps)	Body Worn Accessory	Audio Accessory	EUT Position	Start Power (Conducted)	SAR Drift During Test (dB)	1g SAR Level	Test #
Body	A1	836.52	384	EV-DO Rev. 0	FTAP: 307.2 RTAP: 153.6	Holster	VR10 Headset	Right	24.05	0.04	0.080	1
				Front	24.05			0.16	0.205	2		
				Left	24.05			-0.07	0.505	3		
				EV-DO Rev. A	FETAP: 307.2 RETAP: 4096 Payload	Holster	VR10 Headset	Left	24.14	0.31	0.379	5

Room Temperature (°C):	22.8	Humidity (%):	41	Test Date:	02/11/11
Liquid Temperature (°C):	21.5	Barometric Pressure (mb):	1020	Tested by:	Jennifer Herrett

Test 1 RevA Cellular band Body a

DUT: 1000CP01C Handheld Computer; Type: CN70; Serial: 24411047084

Communication System: CW; Frequency: 835 MHz

Medium parameters used: $f = 835$ MHz; $\sigma = 1.004$ mho/m; $\epsilon_r = 56.247$; $\rho = 1000$ kg/m³, Medium parameters used: $\sigma = 1.0037$ mho/m, $\epsilon_r = 56.2474$; $\rho = 1000$ kg/m³

Phantom section: Flat Section

Measurement Standard: DASYS (IEEE/IEC/ANSI C63.19-2007)

DASY5 Configuration:

Probe: ES3DV3 - SN3246; ConvF(6.1, 6.1, 6.1); Calibrated: 11/11/2010

Sensor-Surface: 3mm (Mechanical Surface Detection), Sensor-Surface: 0mm (Fix Surface)

Electronics: DAE4 Sn1237; Calibrated: 11/10/2010

Phantom: ELI 4.0; Type: QDOVA001BA; Serial: xxxx

Measurement SW: DASY52, Version 52.6 (1); SEMCAD X Version 14.4.2 (2595)

Body/Body/Reference scan (31x61x1): Measurement grid: dx=30mm, dy=30mm

Maximum value of SAR (interpolated) = 0.095 mW/g

Body/Body/Area scan (51x111x1): Measurement grid: dx=15mm, dy=15mm

Maximum value of SAR (interpolated) = 0.085 mW/g

Body/Body/Zoom Scan (7x7x7)/Cube 0: Measurement grid: dx=5mm, dy=5mm, dz=5mm

Reference Value = 9.664 V/m; Power Drift = 0.04 dB

Peak SAR (extrapolated) = 0.102 W/kg

SAR(1 g) = 0.080 mW/g; SAR(10 g) = 0.059 mW/g

Maximum value of SAR (measured) = 0.089 mW/g

Body/Body/Z Scan (1x1x21): Measurement grid: dx=20mm, dy=20mm, dz=5mm

Maximum value of Total (measured) = 8.249 V/m

Body/Body/Zoom Scan 2 (7x8x7)/Cube 0: Measurement grid: dx=5mm, dy=5mm, dz=5mm

Reference Value = 9.664 V/m; Power Drift = 0.11 dB

Peak SAR (extrapolated) = 0.188 W/kg

SAR(1 g) = 0.070 mW/g; SAR(10 g) = 0.046 mW/g

Maximum value of SAR (measured) = 0.138 mW/g



Room Temperature (°C):	24.1	Humidity (%):	38	Test Date:	02/11/11
Liquid Temperature (°C):	22	Barometric Pressure (mb):	1020	Tested by:	Jennifer Herrett

Test 2 RevA Cellular band Body a

DUT: 1000CP01C Handheld Computer; Type: CN70; Serial: 24411047084

Communication System: CW; Frequency: 835 MHz

Medium parameters used: $f = 835$ MHz; $\sigma = 1.004$ mho/m; $\epsilon_r = 56.247$; $\rho = 1000$ kg/m³, Medium parameters used: $\sigma = 1.0037$ mho/m, $\epsilon_r = 56.2474$; $\rho = 1000$ kg/m³

Phantom section: Flat Section

Measurement Standard: DASYS5 (IEEE/IEC/ANSI C63.19-2007)

DASY5 Configuration:

Probe: ES3DV3 - SN3246; ConvF(6.1, 6.1, 6.1); Calibrated: 11/11/2010

Sensor-Surface: 3mm (Mechanical Surface Detection), Sensor-Surface: 0mm (Fix Surface)

Electronics: DAE4 Sn1237; Calibrated: 11/10/2010

Phantom: ELI 4.0; Type: QDOVA001BA; Serial: xxxx

Measurement SW: DASY52, Version 52.6 (1); SEMCAD X Version 14.4.2 (2595)

Body/Body/Reference scan (51x71x1): Measurement grid: dx=30mm, dy=30mm

Maximum value of SAR (interpolated) = 0.215 mW/g

Body/Body/Area scan (71x121x1): Measurement grid: dx=15mm, dy=15mm

Maximum value of SAR (interpolated) = 0.235 mW/g

Body/Body/Zoom Scan (7x7x7)/Cube 0: Measurement grid: dx=5mm, dy=5mm, dz=5mm

Reference Value = 15.407 V/m; Power Drift = 0.16 dB

Peak SAR (extrapolated) = 0.275 W/kg

SAR(1 g) = 0.205 mW/g; SAR(10 g) = 0.142 mW/g

Maximum value of SAR (measured) = 0.233 mW/g

Body/Body/Z Scan (1x1x21): Measurement grid: dx=20mm, dy=20mm, dz=5mm

Maximum value of Total (measured) = 13.025 V/m

Body/Body/Zoom Scan 2 (7x7x7)/Cube 0: Measurement grid: dx=5mm, dy=5mm, dz=5mm

Reference Value = 15.407 V/m; Power Drift = 0.04 dB

Peak SAR (extrapolated) = 0.232 W/kg

SAR(1 g) = 0.167 mW/g; SAR(10 g) = 0.114 mW/g

Maximum value of SAR (measured) = 0.193 mW/g

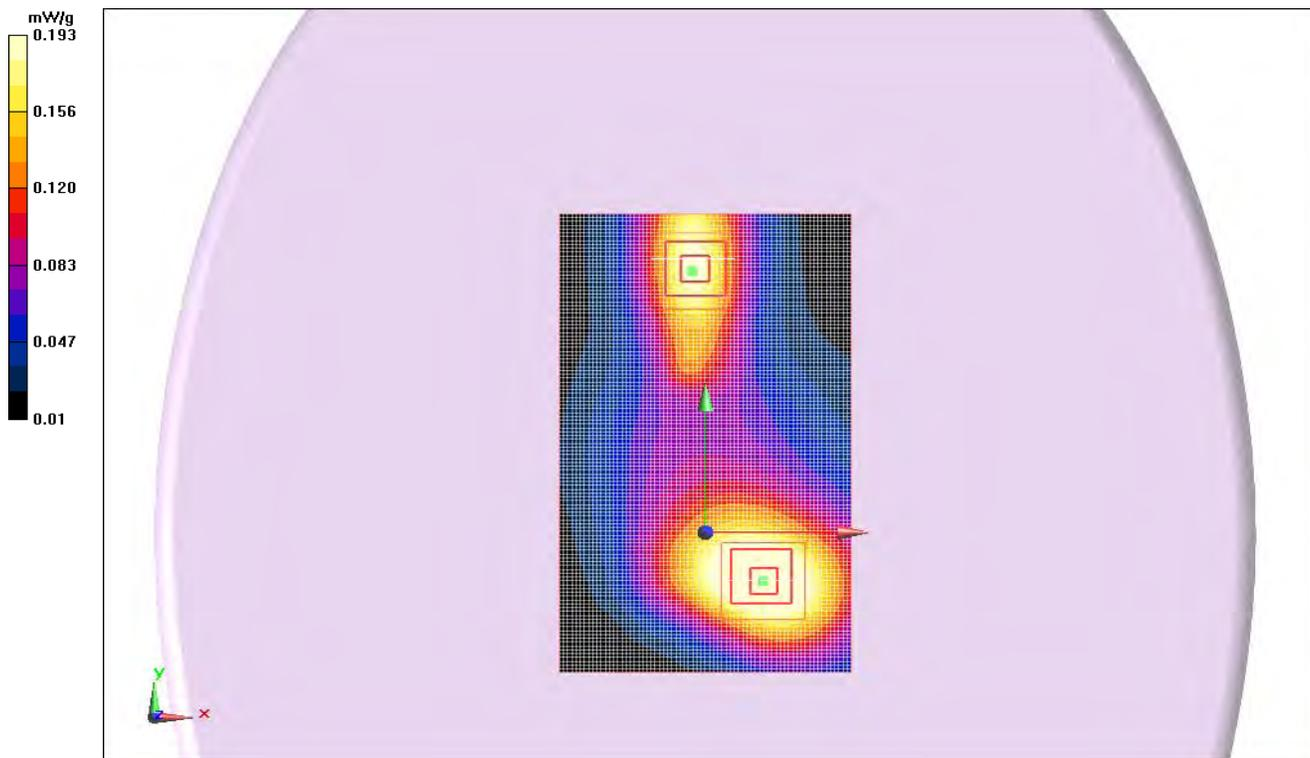

Room Temperature (°C):	23.2	Humidity (%):	42	Test Date:	02/11/11
Liquid Temperature (°C):	21.8	Barometric Pressure (mb):	1020	Tested by:	Jennifer Herrett

Test 3 RevA Cellular band Body a

DUT: 1000CP01C Handheld Computer; Type: CN70; Serial: 24411047084

Communication System: CW; Frequency: 835 MHz

Medium parameters used: $f = 835$ MHz; $\sigma = 1.004$ mho/m; $\epsilon_r = 56.247$; $\rho = 1000$ kg/m³, Medium parameters used: $\sigma = 1.0037$ mho/m, $\epsilon_r = 56.2474$; $\rho = 1000$ kg/m³

Phantom section: Flat Section

Measurement Standard: DASYS5 (IEEE/IEC/ANSI C63.19-2007)

DASY5 Configuration:

Probe: ES3DV3 - SN3246; ConvF(6.1, 6.1, 6.1); Calibrated: 11/11/2010

Sensor-Surface: 3mm (Mechanical Surface Detection), Sensor-Surface: 0mm (Fix Surface)

Electronics: DAE4 Sn1237; Calibrated: 11/10/2010

Phantom: ELI 4.0; Type: QDOVA001BA; Serial: xxxx

Measurement SW: DASY52, Version 52.6 (1); SEMCAD X Version 14.4.2 (2595)

Body/Body/Reference scan (31x61x1): Measurement grid: dx=30mm, dy=30mm

Maximum value of SAR (interpolated) = 0.512 mW/g

Body/Body/Area scan (71x91x1): Measurement grid: dx=15mm, dy=15mm

Maximum value of SAR (interpolated) = 0.562 mW/g

Body/Body/Zoom Scan (7x7x7)/Cube 0: Measurement grid: dx=5mm, dy=5mm, dz=5mm

Reference Value = 24.905 V/m; Power Drift = -0.07 dB

Peak SAR (extrapolated) = 0.789 W/kg

SAR(1 g) = 0.505 mW/g; SAR(10 g) = 0.312 mW/g

Maximum value of SAR (measured) = 0.605 mW/g

Body/Body/Z Scan (1x1x21): Measurement grid: dx=20mm, dy=20mm, dz=5mm

Maximum value of Total (measured) = 19.119 V/m

Body/Body/Zoom Scan 2 (9x12x7)/Cube 0: Measurement grid: dx=5mm, dy=5mm, dz=5mm

Reference Value = 24.905 V/m; Power Drift = -0.07 dB

Peak SAR (extrapolated) = 0.753 W/kg

SAR(1 g) = 0.488 mW/g; SAR(10 g) = 0.305 mW/g

Maximum value of SAR (measured) = 0.575 mW/g

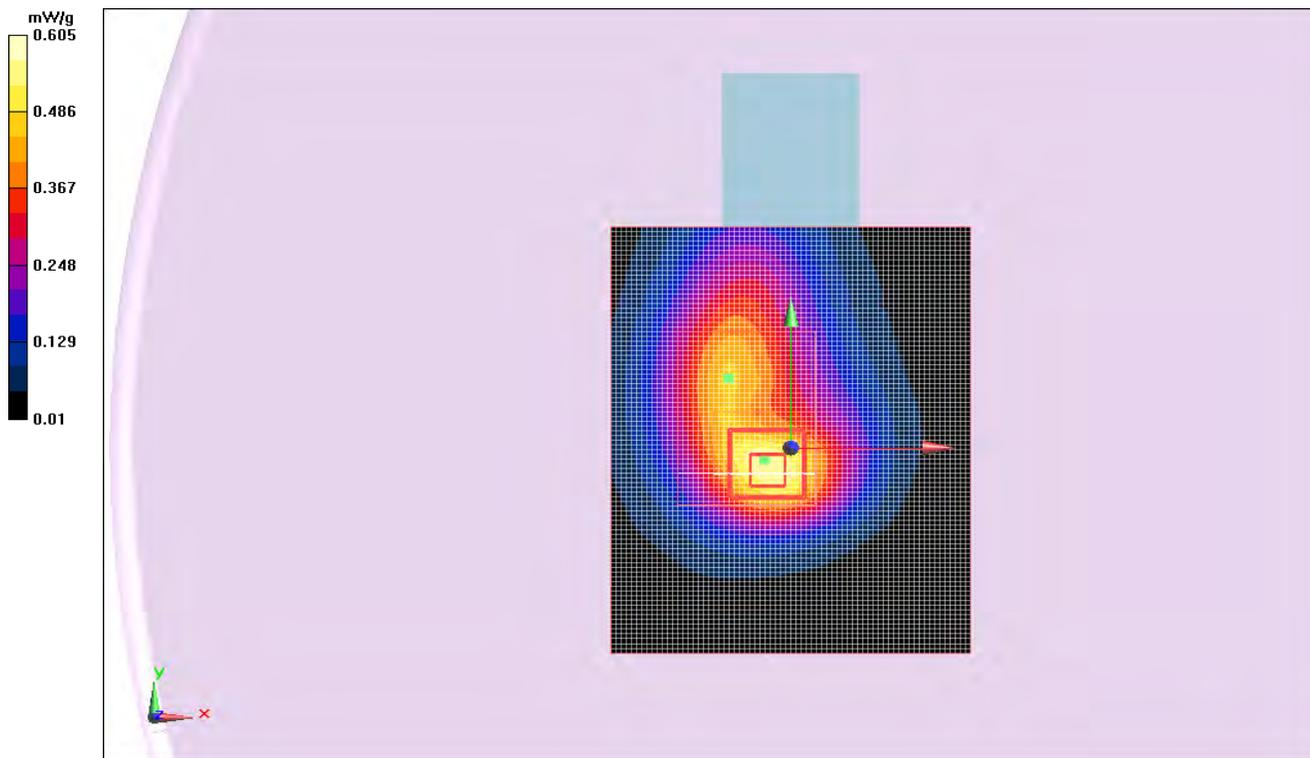

EMC

SAR TEST DATA

Room Temperature (°C):	22.3	Humidity (%):	37.3	Test Date:	02/12/11
Liquid Temperature (°C):	21.8	Barometric Pressure (mb):	1016	Tested by:	Jennifer Herrett

Test 5

DUT: 1000CP01C Handheld Computer; Type: CN70; Serial: 24411047084

Communication System: CW; Frequency: 835 MHz

Medium parameters used: $f = 835$ MHz; $\sigma = 0.999$ mho/m; $\epsilon_r = 55.797$; $\rho = 1000$ kg/m³, Medium parameters used: $\sigma = 0.998721$ mho/m, $\epsilon_r = 55.7969$; $\rho = 1000$ kg/m³

Phantom section: Flat Section

Measurement Standard: DASYS (IEEE/IEC/ANSI C63.19-2007)

DASY5 Configuration:

Probe: ES3DV3 - SN3246; ConvF(6.1, 6.1, 6.1); Calibrated: 11/11/2010

Sensor-Surface: 3mm (Mechanical Surface Detection), Sensor-Surface: 0mm (Fix Surface)

Electronics: DAE4 Sn1237; Calibrated: 11/10/2010

Phantom: ELI 4.0; Type: QDOVA001BA; Serial: 1096

Measurement SW: DASY52, Version 52.6 (1); SEMCAD X Version 14.4.2 (2595)

Body/Body/Reference scan (51x91x1): Measurement grid: dx=30mm, dy=30mm

Maximum value of SAR (interpolated) = 0.415 mW/g

Body/Body/Area scan (71x71x1): Measurement grid: dx=15mm, dy=15mm

Maximum value of SAR (interpolated) = 0.467 mW/g

Body/Body/Zoom Scan (7x7x7)/Cube 0: Measurement grid: dx=5mm, dy=5mm, dz=5mm

Reference Value = 21.674 V/m; Power Drift = -0.29 dB

Peak SAR (extrapolated) = 0.568 W/kg

SAR(1 g) = 0.379 mW/g; SAR(10 g) = 0.240 mW/g

Maximum value of SAR (measured) = 0.451 mW/g

Body/Body/Z Scan (1x1x21): Measurement grid: dx=20mm, dy=20mm, dz=5mm

Maximum value of Total (measured) = 17.097 V/m

Body/Body/Zoom Scan 2 (7x7x7)/Cube 0: Measurement grid: dx=5mm, dy=5mm, dz=5mm

Reference Value = 21.674 V/m; Power Drift = -0.31 dB

Peak SAR (extrapolated) = 0.482 W/kg

SAR(1 g) = 0.327 mW/g; SAR(10 g) = 0.221 mW/g

Maximum value of SAR (measured) = 0.384 mW/g

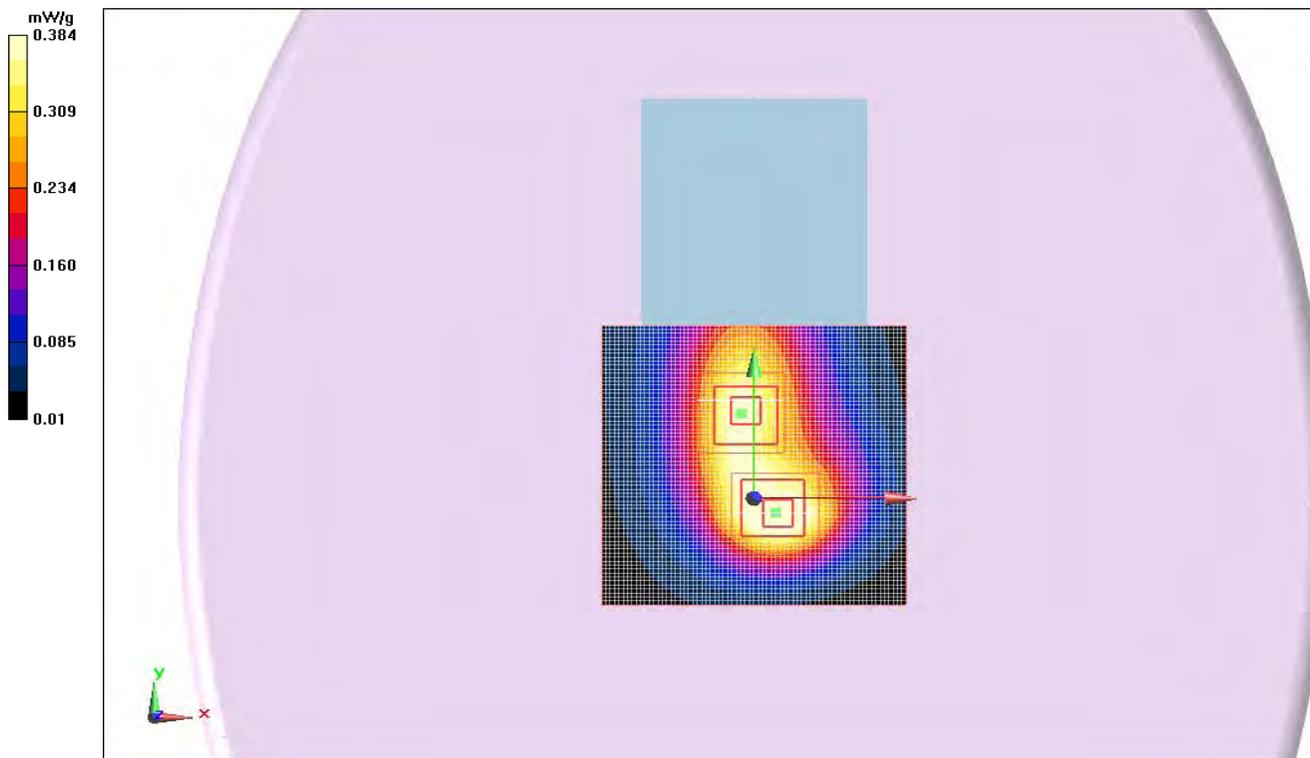

EMC

SAR TEST DATA

Room Temperature (°C):	23.2	Humidity (%):	42	Test Date:	02/11/11
Liquid Temperature (°C):	21.8	Barometric Pressure (mb):	1020	Tested by:	Jennifer Herrett

Test 3 RevA Cellular band Body a

DUT: 1000CP01C Handheld Computer; Type: CN70; Serial: 24411047084

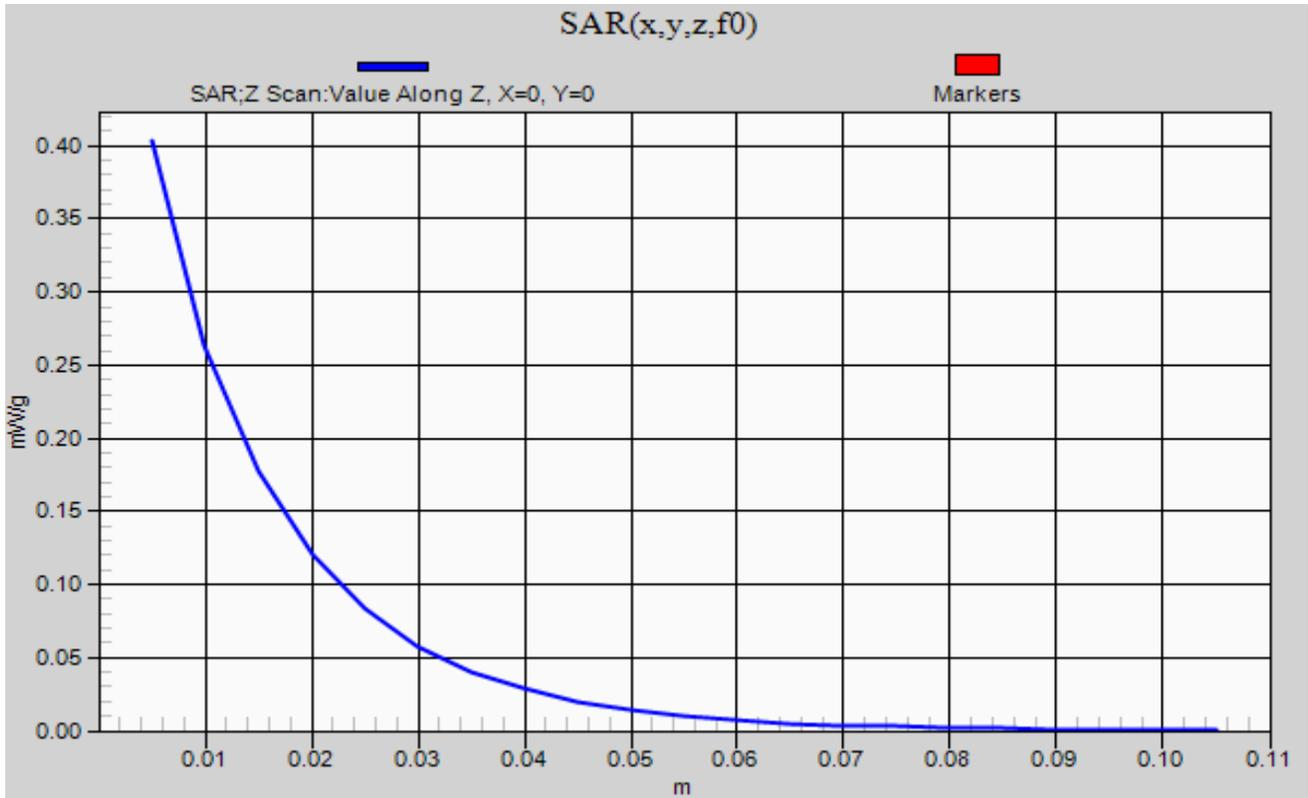

SAR TEST DATA

NORTHWEST SAR 2011.02.07

EMC

EUT: 1000CP01C	Work Order: INMC0683
Serial Number: 24411047084	Date: See Data Sheets
Customer: Intermec Technologies	Temperature: See Data Sheets
Attendees: None	Humidity: See Data Sheets
Project: INMC0570	Barometric Pres.: See Data Sheets
Tested by: Jennifer Herrett	Job Site: EV08

TEST SPECIFICATIONS	Test Method
FCC 2.1093:2011	FCC OET 65C:2001 IEEE Std 1528:2003 FCC KDB 447498 D01 v04 FCC KDB 941225 D01 v02 FCC KDB 648474 D01 V01r05
Health Safety Code 6:2009	RSS-102, Issue 4:2010

COMMENTS

None

DEVIATIONS FROM TEST STANDARD

No Deviations

Configuration #	1	Signature <i>Jennifer Herrett</i>
------------------------	---	-----------------------------------

Test Configuration	Form	Transmit Frequency	Transmit Channel	Transmit Mode	Data Rate (kbps)	Side	EUT Position	Start Power (Conducted)	SAR Drift During Test (dB)	1g SAR Level	Test #
Head	A1	1880	600	RC3 (Fwd 3, Rvs 3) SO55 (Loopback)	9.6	Left	Cheek	24.28	-0.44	0.197	17
							Tilt	24.28	0.07	0.174	18
	Right	Cheek	24.28	0.17		0.379	19				
		Tilt	24.28	0.04		0.251	20				
	A1	1880	600	EV-DO Rev. A	FETAP: 307.2 RETAP: 4096 payload	Left	Cheek	24.39	1.91	0.193	21
							Tilt	24.39	0.1	0.186	22
	Right	Cheek	24.39	1.45		0.333	23				
		Tilt	24.39	0.15		0.279	24				

Room Temperature (°C):	23.6	Humidity (%):	42.3	Test Date:	02/13/11
Liquid Temperature (°C):	21.1	Barometric Pressure (mb):	1016	Tested by:	Jennifer Herrett

Test 17

DUT: 1000CP01C Hand Held Computer; Type: CN70; Serial: 24411047084

Communication System: CW; Frequency: 1880 MHz

Medium parameters used: $\sigma = 1.47184$ mho/m, $\epsilon_r = 53.5958$; $\rho = 1000$ kg/m³, Medium parameters used: $f = 1900$ MHz; $\sigma = 1.472$ mho/m; $\epsilon_r = 53.596$; $\rho = 1000$ kg/m³

Phantom section: Left Section

Measurement Standard: DASYS (IEEE/IEC/ANSI C63.19-2007)

DASY5 Configuration:

Probe: ES3DV3 - SN3246; ConvF(4.63, 4.63, 4.63); Calibrated: 11/11/2010

Sensor-Surface: 0mm (Fix Surface), Sensor-Surface: 3mm (Mechanical Surface Detection)

Electronics: DAE4 Sn1237; Calibrated: 11/10/2010

Phantom: SAM with CRP; Type: SAM; Serial: 1598

Measurement SW: DASY52, Version 52.6 (1); SEMCAD X Version 14.4.2 (2595)

Head - Left/Cheek/Z Scan (1x1x21): Measurement grid: dx=20mm, dy=20mm, dz=5mm

Maximum value of Total (measured) = 9.740 V/m

Head - Left/Cheek/Zoom Scan 2 (7x7x7)/Cube 0: Measurement grid: dx=5mm, dy=5mm, dz=5mm

Reference Value = 3.062 V/m; Power Drift = -0.44 dB

Peak SAR (extrapolated) = 0.324 W/kg

SAR(1 g) = 0.197 mW/g; SAR(10 g) = 0.117 mW/g

Maximum value of SAR (measured) = 0.237 mW/g

Head - Left/Cheek/Zoom Scan (8x7x7)/Cube 0: Measurement grid: dx=5mm, dy=5mm, dz=5mm

Reference Value = 3.062 V/m; Power Drift = -0.17 dB

Peak SAR (extrapolated) = 0.361 W/kg

SAR(1 g) = 0.193 mW/g; SAR(10 g) = 0.120 mW/g

Maximum value of SAR (measured) = 0.246 mW/g

Head - Left/Cheek/Reference scan (31x61x1): Measurement grid: dx=30mm, dy=30mm

Maximum value of SAR (interpolated) = 0.832 mW/g

Head - Left/Cheek/Area scan (61x61x1): Measurement grid: dx=15mm, dy=15mm

Maximum value of SAR (interpolated) = 0.240 mW/g

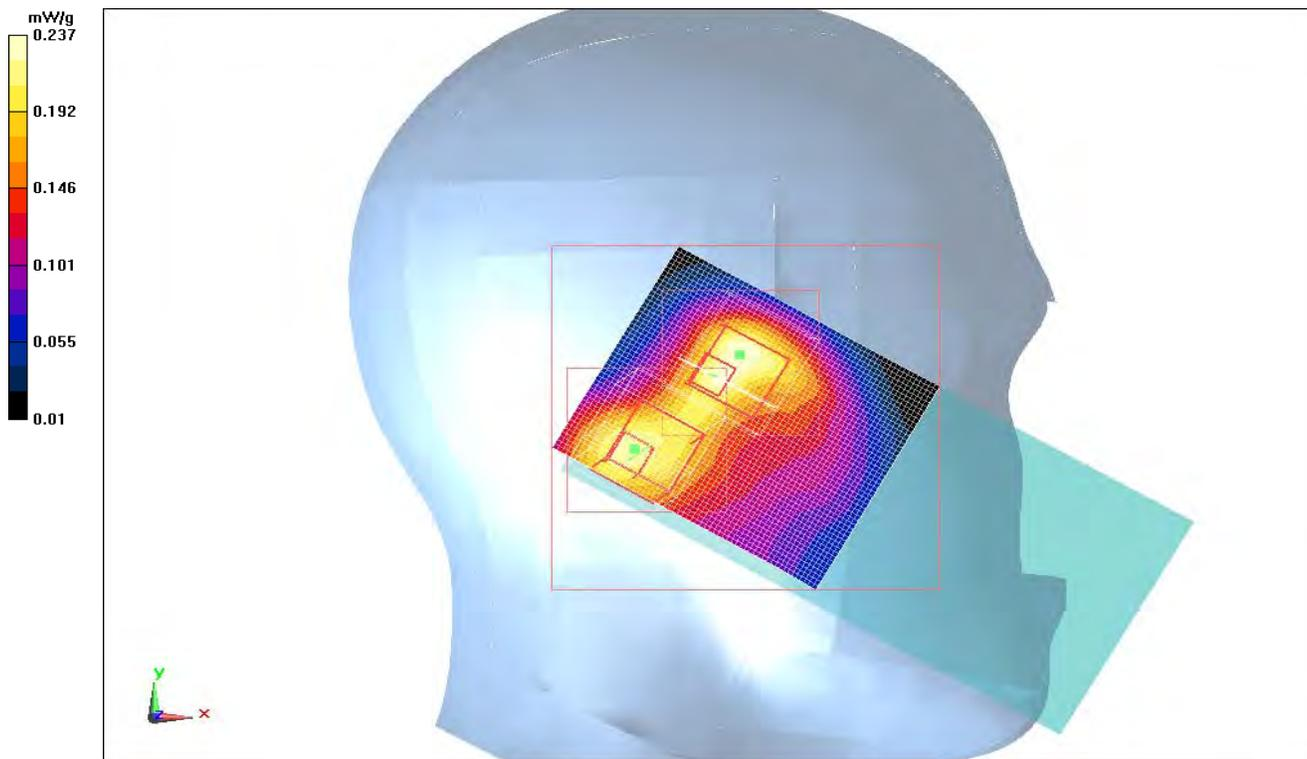

Room Temperature (°C):	23.4	Humidity (%):	43.3	Test Date:	02/13/11
Liquid Temperature (°C):	21.2	Barometric Pressure (mb):	1009	Tested by:	Jennifer Herrett

Test 18

DUT: 1000CP01C Hand Held Computer; Type: CN70; Serial: 24411047084

Communication System: CW; Frequency: 1880 MHz

Medium parameters used: $f = 1880$ MHz; $\sigma = 1.472$ mho/m; $\epsilon_r = 53.596$; $\rho = 1000$ kg/m³, Medium parameters used: $\sigma = 1.47184$ mho/m, $\epsilon_r = 53.5958$; $\rho = 1000$ kg/m³

Phantom section: Left Section

Measurement Standard: DASYS (IEEE/IEC/ANSI C63.19-2007)

DASY5 Configuration:

Probe: ES3DV3 - SN3246; ConvF(4.63, 4.63, 4.63); Calibrated: 11/11/2010

Sensor-Surface: 3mm (Mechanical Surface Detection), Sensor-Surface: 0mm (Fix Surface)

Electronics: DAE4 Sn1237; Calibrated: 11/10/2010

Phantom: SAM with CRP; Type: SAM; Serial: 1598

Measurement SW: DASY52, Version 52.6 (1); SEMCAD X Version 14.4.2 (2595)

Head - Left/Tilt/Zoom Scan (7x7x7)/Cube 0: Measurement grid: dx=5mm, dy=5mm, dz=5mm

Reference Value = 11.760 V/m; Power Drift = 0.07 dB

Peak SAR (extrapolated) = 0.306 W/kg

SAR(1 g) = 0.175 mW/g; SAR(10 g) = 0.099 mW/g

Maximum value of SAR (measured) = 0.213 mW/g

Head - Left/Tilt/Z Scan (1x1x21): Measurement grid: dx=20mm, dy=20mm, dz=5mm

Maximum value of Total (measured) = 9.283 V/m

Head - Left/Tilt/Zoom Scan 2 (7x7x7)/Cube 0: Measurement grid: dx=5mm, dy=5mm, dz=5mm

Reference Value = 11.760 V/m; Power Drift = 0.05 dB

Peak SAR (extrapolated) = 0.292 W/kg

SAR(1 g) = 0.174 mW/g; SAR(10 g) = 0.106 mW/g

Maximum value of SAR (measured) = 0.210 mW/g

Head - Left/Tilt/Reference scan (31x51x1): Measurement grid: dx=30mm, dy=30mm

Maximum value of SAR (interpolated) = 0.200 mW/g

Head - Left/Tilt/Area scan (61x61x1): Measurement grid: dx=15mm, dy=15mm

Maximum value of SAR (interpolated) = 0.207 mW/g

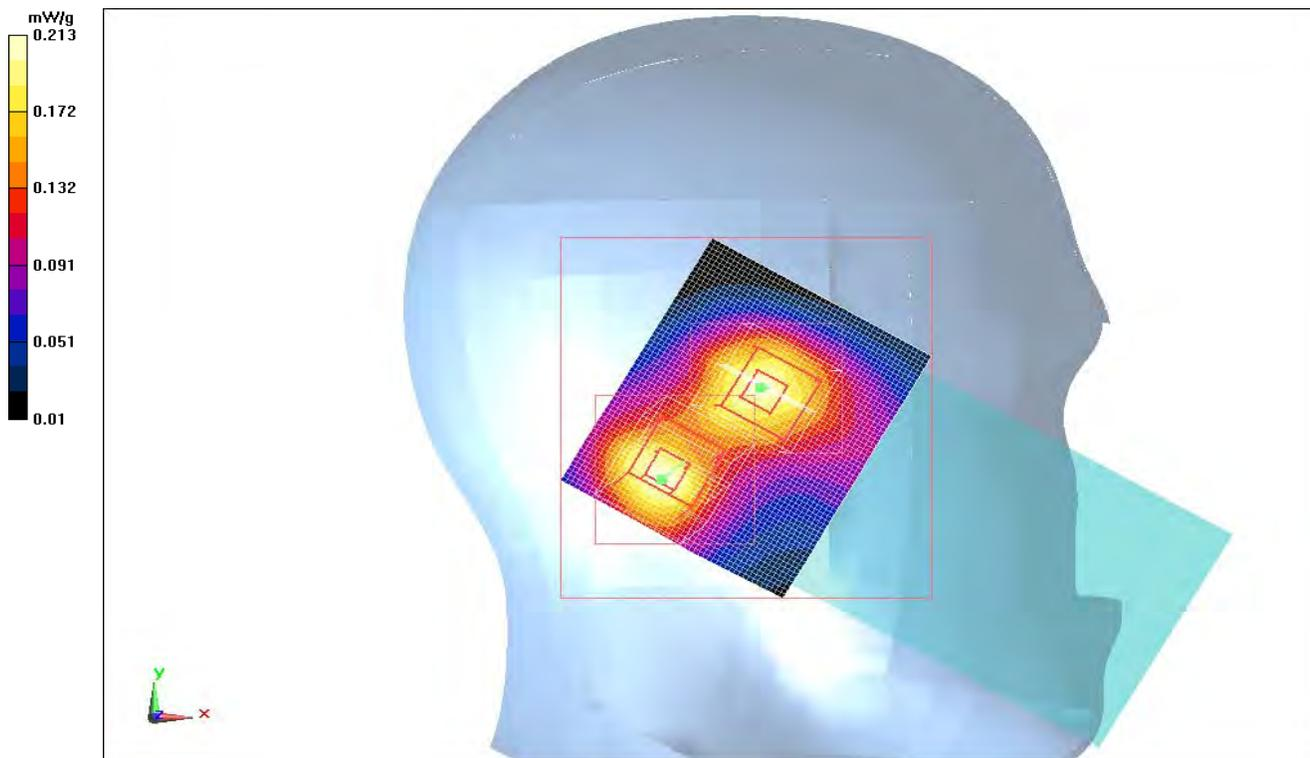

Room Temperature (°C):	23	42.6	40	Test Date:	02/13/11
Liquid Temperature (°C):	21.2	1009	1010	Tested by:	Jennifer Herrett

Test 19

DUT: 1000CP01C Hand Held Computer; Type: CN70; Serial: 24411047084

Communication System: CW; Frequency: 1880 MHz

Medium parameters used: $\sigma = 1.47184$ mho/m, $\epsilon_r = 53.5958$; $\rho = 1000$ kg/m³, Medium parameters used: $f = 1900$ MHz; $\sigma = 1.472$ mho/m; $\epsilon_r = 53.596$; $\rho = 1000$ kg/m³

Phantom section: Right Section

Measurement Standard: DASYS (IEEE/IEC/ANSI C63.19-2007)

DASY5 Configuration:

Probe: ES3DV3 - SN3246; ConvF(4.63, 4.63, 4.63); Calibrated: 11/11/2010

Sensor-Surface: 0mm (Fix Surface), Sensor-Surface: 3mm (Mechanical Surface Detection)

Electronics: DAE4 Sn1237; Calibrated: 11/10/2010

Phantom: SAM with CRP; Type: SAM; Serial: 1598

Measurement SW: DASY52, Version 52.6 (1); SEMCAD X Version 14.4.2 (2595)

Head - Right/Cheek/Z Scan (1x1x21): Measurement grid: dx=20mm, dy=20mm, dz=5mm

Maximum value of Total (measured) = 13.407 V/m

Head - Right/Cheek/Zoom Scan (7x7x7)/Cube 0: Measurement grid: dx=5mm, dy=5mm, dz=5mm

Reference Value = 2.538 V/m; Power Drift = 0.17 dB

Peak SAR (extrapolated) = 0.639 W/kg

SAR(1 g) = 0.379 mW/g; SAR(10 g) = 0.222 mW/g

Maximum value of SAR (measured) = 0.456 mW/g

Head - Right/Cheek/Reference scan (31x51x1): Measurement grid: dx=30mm, dy=30mm

Maximum value of SAR (interpolated) = 7.384 mW/g

Head - Right/Cheek/Area scan (81x71x1): Measurement grid: dx=15mm, dy=15mm

Maximum value of SAR (interpolated) = 0.441 mW/g

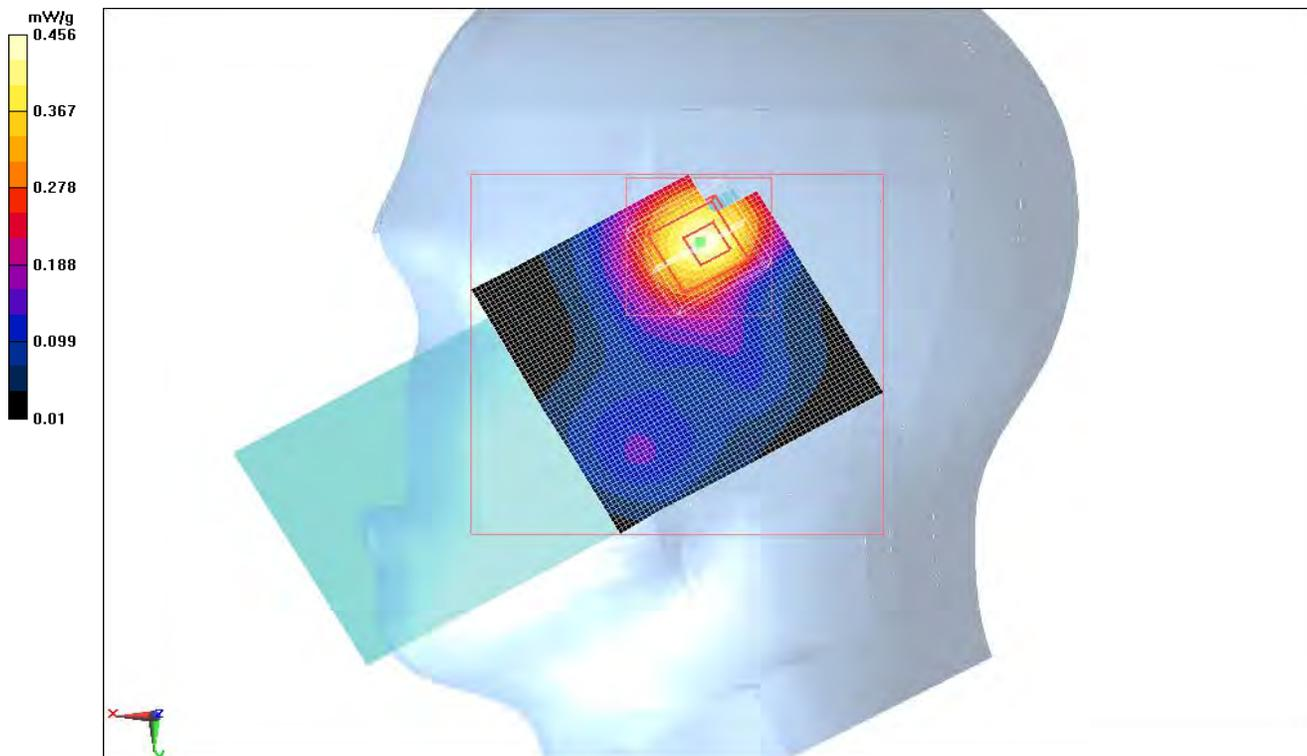

EMC

SAR TEST DATA

Room Temperature (°C):	22.9	Humidity (%):	43.1	Test Date:	02/13/11
Liquid Temperature (°C):	21.2	Barometric Pressure (mb):	1009	Tested by:	Jennifer Herrett

Test 20

DUT: 1000CP01C Hand Held Computer; Type: CN70; Serial: 24411047084

Communication System: CW; Frequency: 1880 MHz

Medium parameters used: $f = 1880$ MHz; $\sigma = 1.423$ mho/m; $\epsilon_r = 40.609$; $\rho = 1000$ kg/m³, Medium parameters used: $\sigma = 1.4232$ mho/m; $\epsilon_r = 40.6086$; $\rho = 1000$ kg/m³

Phantom section: Right Section

Measurement Standard: DASYS (IEEE/IEC/ANSI C63.19-2007)

DASY5 Configuration:

Probe: ES3DV3 - SN3246; ConvF(5.02, 5.02, 5.02); Calibrated: 11/11/2010

Sensor-Surface: 3mm (Mechanical Surface Detection), Sensor-Surface: 0mm (Fix Surface)

Electronics: DAE4 Sn1237; Calibrated: 11/10/2010

Phantom: SAM with CRP; Type: SAM; Serial: 1598

Measurement SW: DASY52, Version 52.6 (1); SEMCAD X Version 14.4.2 (2595)

Head - Right/Tilt/Zoom Scan (7x7x7)/Cube 0: Measurement grid: dx=5mm, dy=5mm, dz=5mm

Reference Value = 14.781 V/m; Power Drift = 0.04 dB

Peak SAR (extrapolated) = 0.418 W/kg

SAR(1 g) = 0.251 mW/g; SAR(10 g) = 0.148 mW/g

Maximum value of SAR (measured) = 0.300 mW/g

Head - Right/Tilt/Z Scan (1x1x21): Measurement grid: dx=20mm, dy=20mm, dz=5mm

Maximum value of Total (measured) = 11.349 V/m

Head - Right/Tilt/Reference scan (41x61x1): Measurement grid: dx=30mm, dy=30mm

Maximum value of SAR (interpolated) = 2.726 mW/g

Head - Right/Tilt/Area scan (61x81x1): Measurement grid: dx=15mm, dy=15mm

Maximum value of SAR (interpolated) = 0.310 mW/g

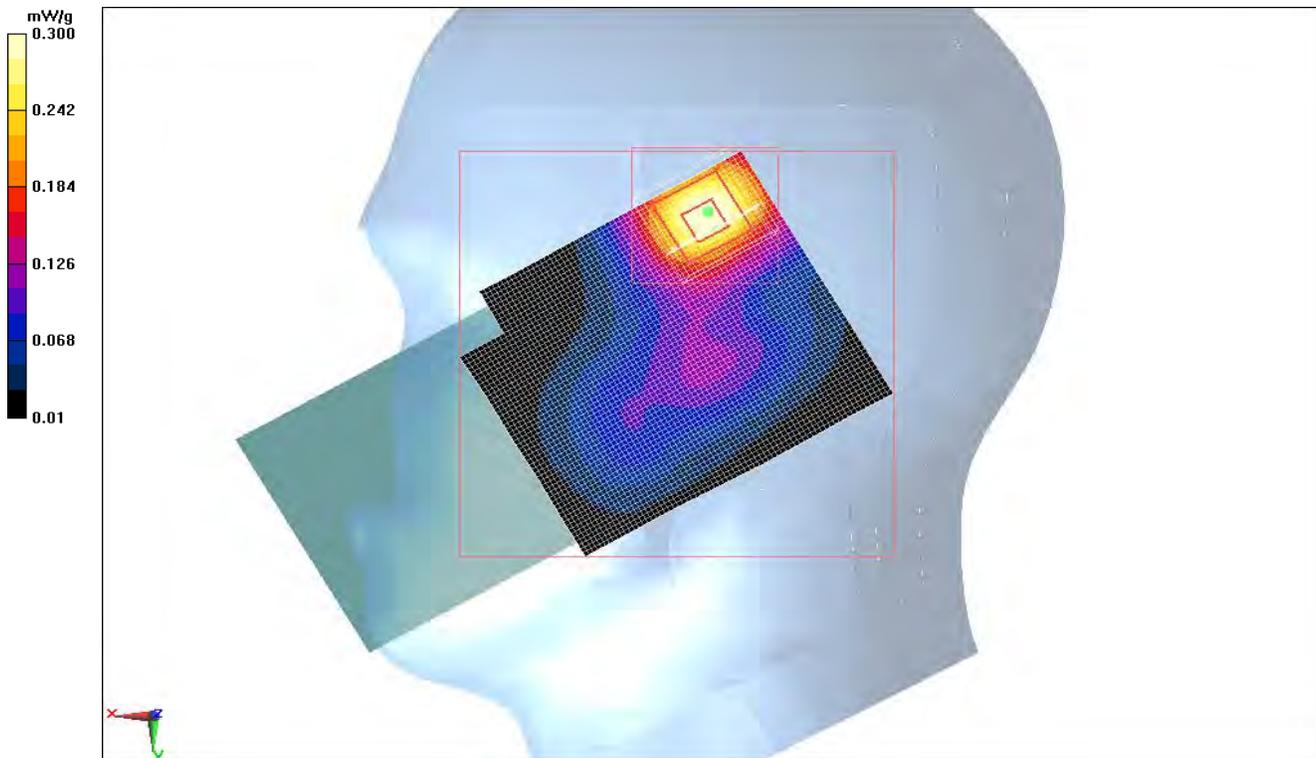

Room Temperature (°C):	23.3	Humidity (%):	35.9	Test Date:	02/12/11
Liquid Temperature (°C):	21.1	Barometric Pressure (mb):	1012	Tested by:	Jennifer Herrett

Test 21

DUT: 1000CP01C Hand Held Computer; Type: CN70; Serial: 24411047084

Communication System: CW; Frequency: 1880 MHz

Medium parameters used: $\sigma = 1.4232$ mho/m, $\epsilon_r = 40.6086$; $\rho = 1000$ kg/m³, Medium parameters used: $f = 1900$ MHz; $\sigma = 1.423$ mho/m; $\epsilon_r = 40.609$; $\rho = 1000$ kg/m³

Phantom section: Left Section

Measurement Standard: DASYS (IEEE/IEC/ANSI C63.19-2007)

DASY5 Configuration:

Probe: ES3DV3 - SN3246; ConvF(5.02, 5.02, 5.02); Calibrated: 11/11/2010

Sensor-Surface: 0mm (Fix Surface), Sensor-Surface: 3mm (Mechanical Surface Detection)

Electronics: DAE4 Sn1237; Calibrated: 11/10/2010

Phantom: SAM with CRP; Type: SAM; Serial: 1598

Measurement SW: DASY52, Version 52.6 (1); SEMCAD X Version 14.4.2 (2595)

Head - Left/Cheek/Z Scan (1x1x21): Measurement grid: dx=20mm, dy=20mm, dz=5mm

Maximum value of Total (measured) = 10.443 V/m

Head - Left/Cheek/Zoom Scan 2 (7x7x7)/Cube 0: Measurement grid: dx=5mm, dy=5mm, dz=5mm

Reference Value = 1.252 V/m; Power Drift = 1.50 dB

Peak SAR (extrapolated) = 0.282 W/kg

SAR(1 g) = 0.169 mW/g; SAR(10 g) = 0.105 mW/g

Maximum value of SAR (measured) = 0.205 mW/g

Head - Left/Cheek/Zoom Scan (7x7x7)/Cube 0: Measurement grid: dx=5mm, dy=5mm, dz=5mm

Reference Value = 1.252 V/m; Power Drift = 1.91 dB

Peak SAR (extrapolated) = 0.320 W/kg

SAR(1 g) = 0.193 mW/g; SAR(10 g) = 0.123 mW/g

Maximum value of SAR (measured) = 0.228 mW/g

Head - Left/Cheek/Reference scan (51x61x1): Measurement grid: dx=30mm, dy=30mm

Maximum value of SAR (interpolated) = 1.043 mW/g

Head - Left/Cheek/Area scan (61x61x1): Measurement grid: dx=15mm, dy=15mm

Maximum value of SAR (interpolated) = 0.237 mW/g

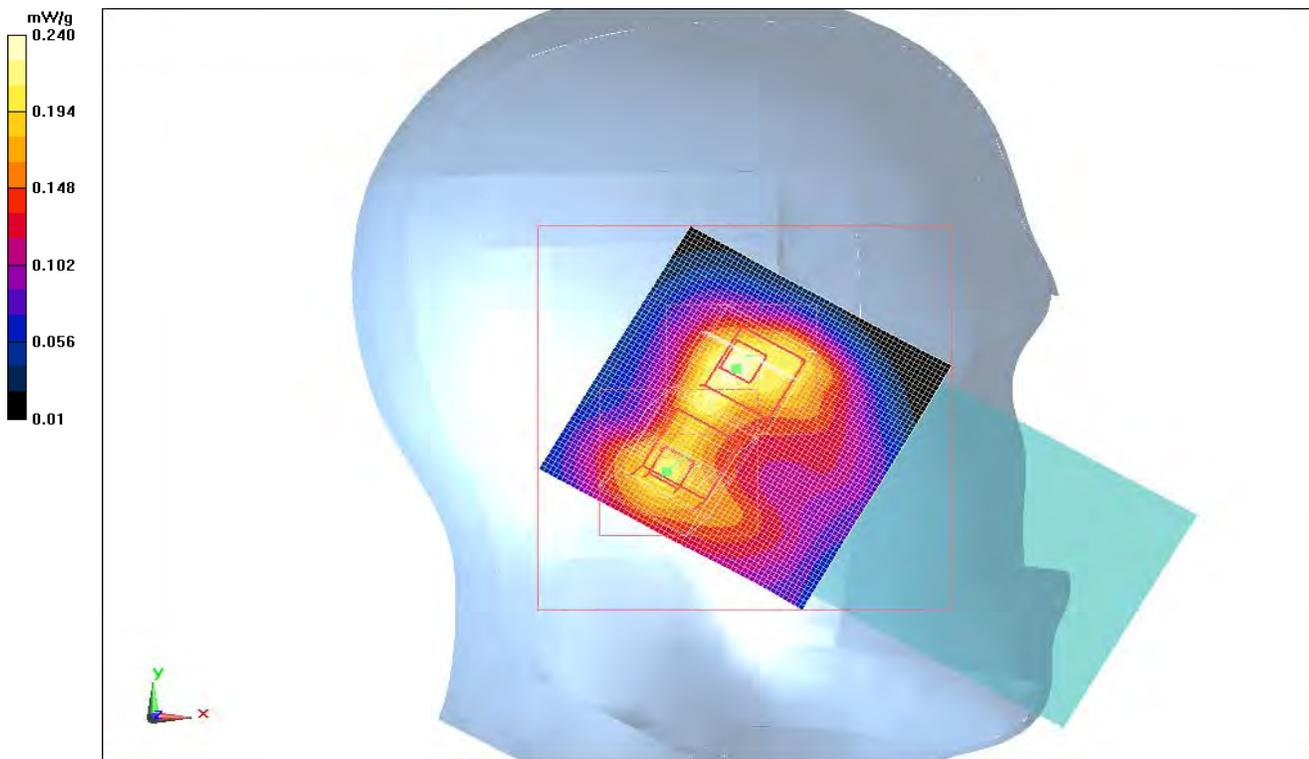

Room Temperature (°C):	23.4	Humidity (%):	39.4	Test Date:	02/12/11
Liquid Temperature (°C):	20.9	Barometric Pressure (mb):	1013	Tested by:	Jennifer Herrett

Test 22

DUT: 1000CP01C Hand Held Computer; Type: CN70; Serial: 24411047084

Communication System: CW; Frequency: 1880 MHz

Medium parameters used: $f = 1880$ MHz; $\sigma = 1.423$ mho/m; $\epsilon_r = 40.609$; $\rho = 1000$ kg/m³, Medium parameters used: $\sigma = 1.4232$ mho/m; $\epsilon_r = 40.6086$; $\rho = 1000$ kg/m³

Phantom section: Left Section

Measurement Standard: DASYS (IEEE/IEC/ANSI C63.19-2007)

DASY5 Configuration:

Probe: ES3DV3 - SN3246; ConvF(5.02, 5.02, 5.02); Calibrated: 11/11/2010

Sensor-Surface: 3mm (Mechanical Surface Detection), Sensor-Surface: 0mm (Fix Surface)

Electronics: DAE4 Sn1237; Calibrated: 11/10/2010

Phantom: SAM with CRP; Type: SAM; Serial: 1598

Measurement SW: DASY52, Version 52.6 (1); SEMCAD X Version 14.4.2 (2595)

Head - Left/Tilt/Zoom Scan (7x7x7)/Cube 0: Measurement grid: dx=5mm, dy=5mm, dz=5mm

Reference Value = 12.616 V/m; Power Drift = 0.10 dB

Peak SAR (extrapolated) = 0.320 W/kg

SAR(1 g) = 0.186 mW/g; SAR(10 g) = 0.112 mW/g

Maximum value of SAR (measured) = 0.226 mW/g

Head - Left/Tilt/Z Scan (1x1x21): Measurement grid: dx=20mm, dy=20mm, dz=5mm

Maximum value of Total (measured) = 9.608 V/m

Head - Left/Tilt/Zoom Scan 2 (7x7x7)/Cube 0: Measurement grid: dx=5mm, dy=5mm, dz=5mm

Reference Value = 12.616 V/m; Power Drift = 0.13 dB

Peak SAR (extrapolated) = 0.279 W/kg

SAR(1 g) = 0.158 mW/g; SAR(10 g) = 0.090 mW/g

Maximum value of SAR (measured) = 0.194 mW/g

Head - Left/Tilt/Reference scan (41x61x1): Measurement grid: dx=30mm, dy=30mm

Maximum value of SAR (interpolated) = 0.204 mW/g

Head - Left/Tilt/Area scan (61x61x1): Measurement grid: dx=15mm, dy=15mm

Maximum value of SAR (interpolated) = 0.235 mW/g

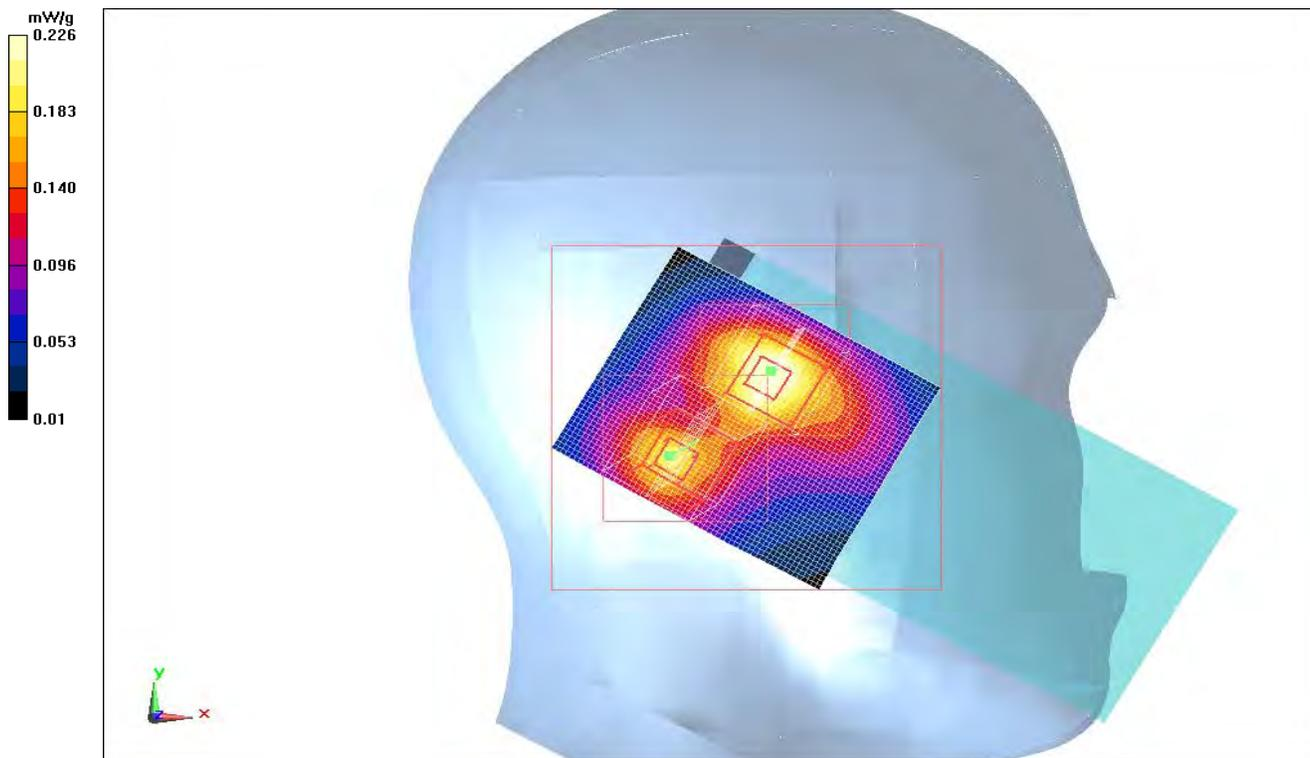

EMC

SAR TEST DATA

Room Temperature (°C):	23.5	Humidity (%):	34.9	Test Date:	02/12/11
Liquid Temperature (°C):	21	Barometric Pressure (mb):	1016	Tested by:	Jennifer Herrett

Test 23

DUT: 1000CP01C Hand Held Computer; Type: CN70; Serial: 24411047084

Communication System: CW; Frequency: 1880 MHz

Medium parameters used: $\sigma = 1.4232$ mho/m, $\epsilon_r = 40.6086$; $\rho = 1000$ kg/m³, Medium parameters used: $f = 1900$ MHz; $\sigma = 1.423$ mho/m; $\epsilon_r = 40.609$; $\rho = 1000$ kg/m³

Phantom section: Right Section

Measurement Standard: DASYS (IEEE/IEC/ANSI C63.19-2007)

DASY5 Configuration:

Probe: ES3DV3 - SN3246; ConvF(5.02, 5.02, 5.02); Calibrated: 11/11/2010

Sensor-Surface: 0mm (Fix Surface), Sensor-Surface: 3mm (Mechanical Surface Detection)

Electronics: DAE4 Sn1237; Calibrated: 11/10/2010

Phantom: SAM with CRP; Type: SAM; Serial: 1598

Measurement SW: DASY52, Version 52.6 (1); SEMCAD X Version 14.4.2 (2595)

Head - Right/Cheek/Z Scan (1x1x21): Measurement grid: dx=20mm, dy=20mm, dz=5mm

Maximum value of Total (measured) = 13.011 V/m

Head - Right/Cheek/Zoom Scan (7x7x7)/Cube 0: Measurement grid: dx=5mm, dy=5mm, dz=5mm

Reference Value = 1.531 V/m; Power Drift = 1.45 dB

Peak SAR (extrapolated) = 0.578 W/kg

SAR(1 g) = 0.333 mW/g; SAR(10 g) = 0.192 mW/g

Maximum value of SAR (measured) = 0.405 mW/g

Head - Right/Cheek/Reference scan (51x51x1): Measurement grid: dx=30mm, dy=30mm

Maximum value of SAR (interpolated) = 3.180 mW/g

Head - Right/Cheek/Area scan (81x71x1): Measurement grid: dx=15mm, dy=15mm

Maximum value of SAR (interpolated) = 0.404 mW/g

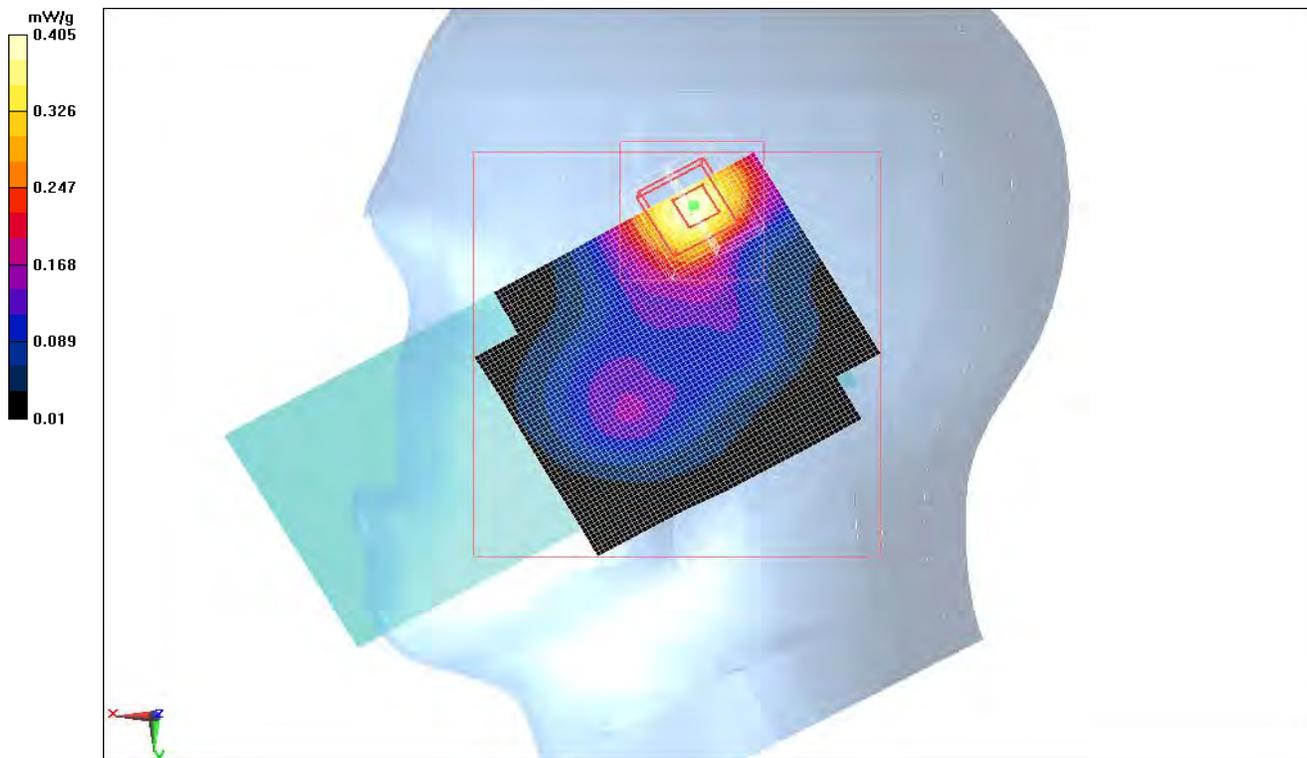

EMC

SAR TEST DATA

Room Temperature (°C):	23.3	Humidity (%):	38.5	Test Date:	02/12/11
Liquid Temperature (°C):	21.1	Barometric Pressure (mb):	1017	Tested by:	Jennifer Herrett

Test 24

DUT: 1000CP01C Hand Held Computer; Type: CN70; Serial: 24411047084

Communication System: CW; Frequency: 1880 MHz

Medium parameters used: $f = 1880$ MHz; $\sigma = 1.423$ mho/m; $\epsilon_r = 40.609$; $\rho = 1000$ kg/m³, Medium parameters used: $\sigma = 1.4232$ mho/m, $\epsilon_r = 40.6086$; $\rho = 1000$ kg/m³

Phantom section: Right Section

Measurement Standard: DASYS (IEEE/IEC/ANSI C63.19-2007)

DASY5 Configuration:

Probe: ES3DV3 - SN3246; ConvF(5.02, 5.02, 5.02); Calibrated: 11/11/2010

Sensor-Surface: 3mm (Mechanical Surface Detection), Sensor-Surface: 0mm (Fix Surface)

Electronics: DAE4 Sn1237; Calibrated: 11/10/2010

Phantom: SAM with CRP; Type: SAM; Serial: 1598

Measurement SW: DASY52, Version 52.6 (1); SEMCAD X Version 14.4.2 (2595)

Head - Right/Tilt/Zoom Scan (7x7x7)/Cube 0: Measurement grid: dx=5mm, dy=5mm, dz=5mm

Reference Value = 15.053 V/m; Power Drift = 0.15 dB

Peak SAR (extrapolated) = 0.487 W/kg

SAR(1 g) = 0.279 mW/g; SAR(10 g) = 0.161 mW/g

Maximum value of SAR (measured) = 0.339 mW/g

Head - Right/Tilt/Z Scan (1x1x21): Measurement grid: dx=20mm, dy=20mm, dz=5mm

Maximum value of Total (measured) = 12.023 V/m

Head - Right/Tilt/Reference scan (41x61x1): Measurement grid: dx=30mm, dy=30mm

Maximum value of SAR (interpolated) = 2.253 mW/g

Head - Right/Tilt/Area scan (61x61x1): Measurement grid: dx=15mm, dy=15mm

Maximum value of SAR (interpolated) = 0.341 mW/g

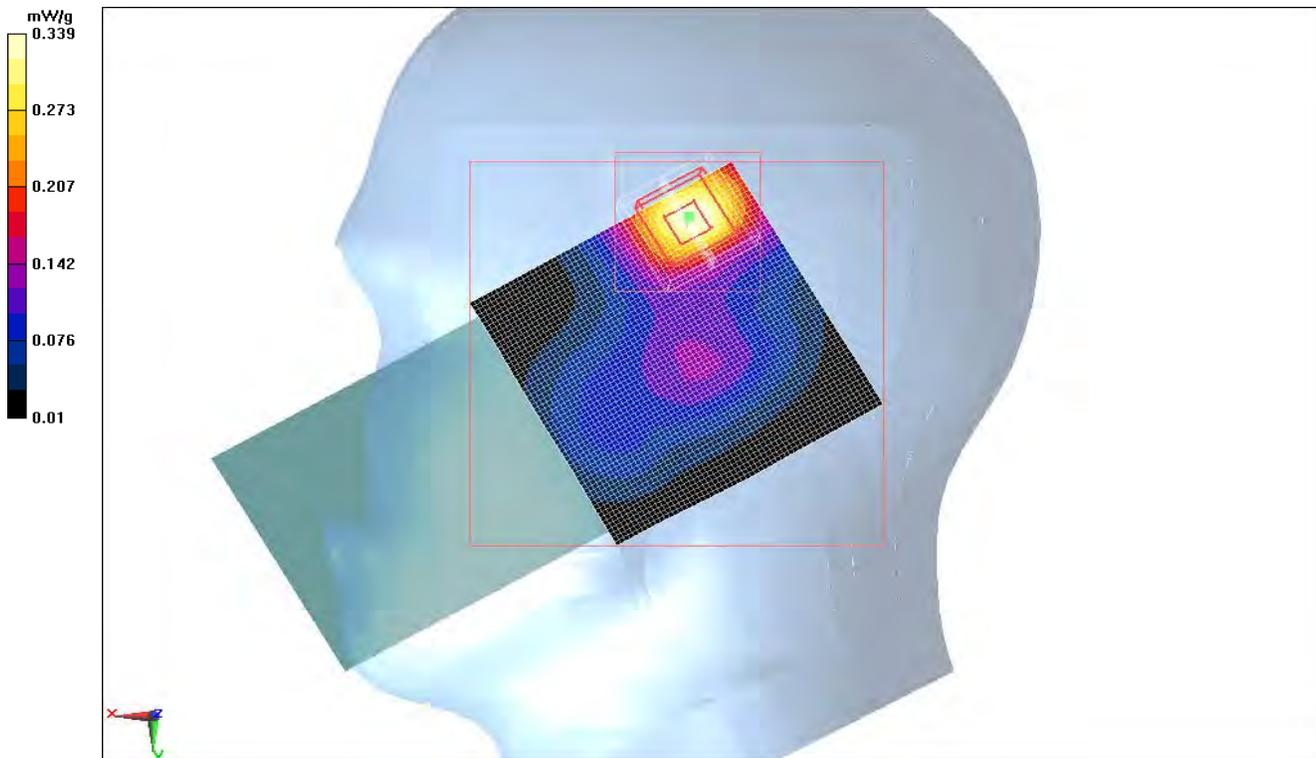

EMC

SAR TEST DATA

Room Temperature (°C):	23	42.6	40	Test Date:	02/13/11
Liquid Temperature (°C):	21.2	1009	1010	Tested by:	Jennifer Herrett

Test 19

DUT: 1000CP01C Hand Held Computer; Type: CN70; Serial: 24411047084

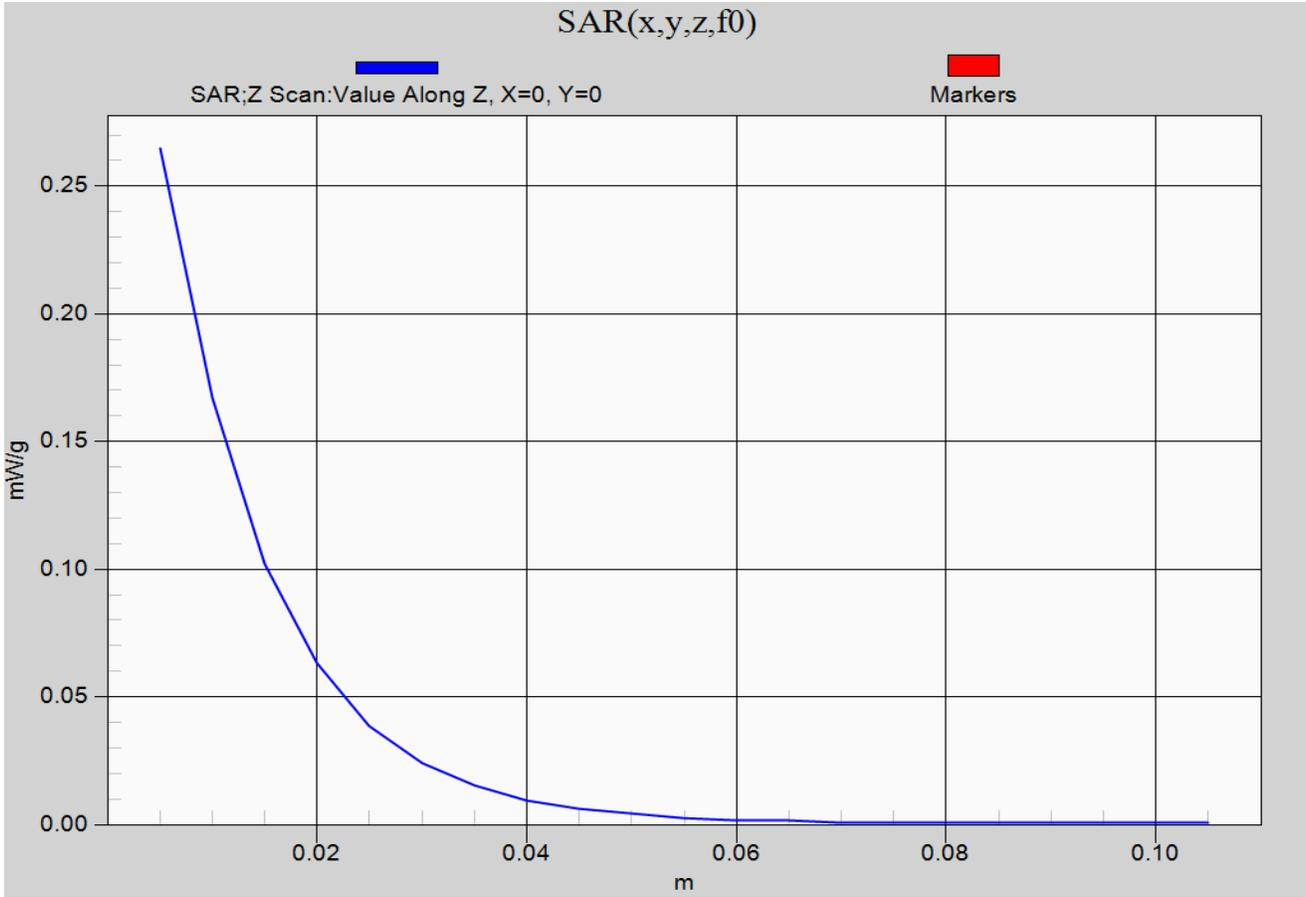

Room Temperature (°C):	22.5	Humidity (%):	43.8	Test Date:	02/13/11
Liquid Temperature (°C):	20.8	Barometric Pressure (mb):	1016	Tested by:	Jennifer Herrett

Test 14

DUT: 1000CP01C Hand Held Computer; Type: CN70; Serial: 24411047084

Communication System: CW; Frequency: 1851.25 MHz

Medium parameters used: $\sigma = 1.4232$ mho/m, $\epsilon_r = 40.6086$; $\rho = 1000$ kg/m³, Medium parameters used: $f = 1900$ MHz; $\sigma = 1.423$ mho/m; $\epsilon_r = 40.609$; $\rho = 1000$ kg/m³

Phantom section: Flat Section

Measurement Standard: DASYS (IEEE/IEC/ANSI C63.19-2007)

DASY5 Configuration:

Probe: ES3DV3 - SN3246; ConvF(5.02, 5.02, 5.02); Calibrated: 11/11/2010

Sensor-Surface: 0mm (Fix Surface), Sensor-Surface: 3mm (Mechanical Surface Detection)

Electronics: DAE4 Sn1237; Calibrated: 11/10/2010

Phantom: ELI 4.0; Type: QDOVA001BA; Serial: xxxx

Measurement SW: DASY52, Version 52.6 (1); SEMCAD X Version 14.4.2 (2595)

Body/Body/Z Scan (1x1x21): Measurement grid: dx=20mm, dy=20mm, dz=5mm

Maximum value of Total (measured) = 7.540 V/m

Body/Body/Zoom Scan 2 (14x15x7)/Cube 0: Measurement grid: dx=5mm, dy=5mm, dz=5mm

Reference Value = 9.524 V/m; Power Drift = -0.03 dB

Peak SAR (extrapolated) = 0.173 W/kg

SAR(1 g) = 0.109 mW/g; SAR(10 g) = 0.072 mW/g

Maximum value of SAR (measured) = 0.128 mW/g

Body/Body/Zoom Scan (7x9x7)/Cube 0: Measurement grid: dx=5mm, dy=5mm, dz=5mm

Reference Value = 9.524 V/m; Power Drift = -0.07 dB

Peak SAR (extrapolated) = 0.174 W/kg

SAR(1 g) = 0.110 mW/g; SAR(10 g) = 0.072 mW/g

Maximum value of SAR (measured) = 0.129 mW/g

Body/Body/Reference scan (41x71x1): Measurement grid: dx=30mm, dy=30mm

Maximum value of SAR (interpolated) = 0.130 mW/g

Body/Body/Area scan (61x71x1): Measurement grid: dx=15mm, dy=15mm

Maximum value of SAR (interpolated) = 0.125 mW/g

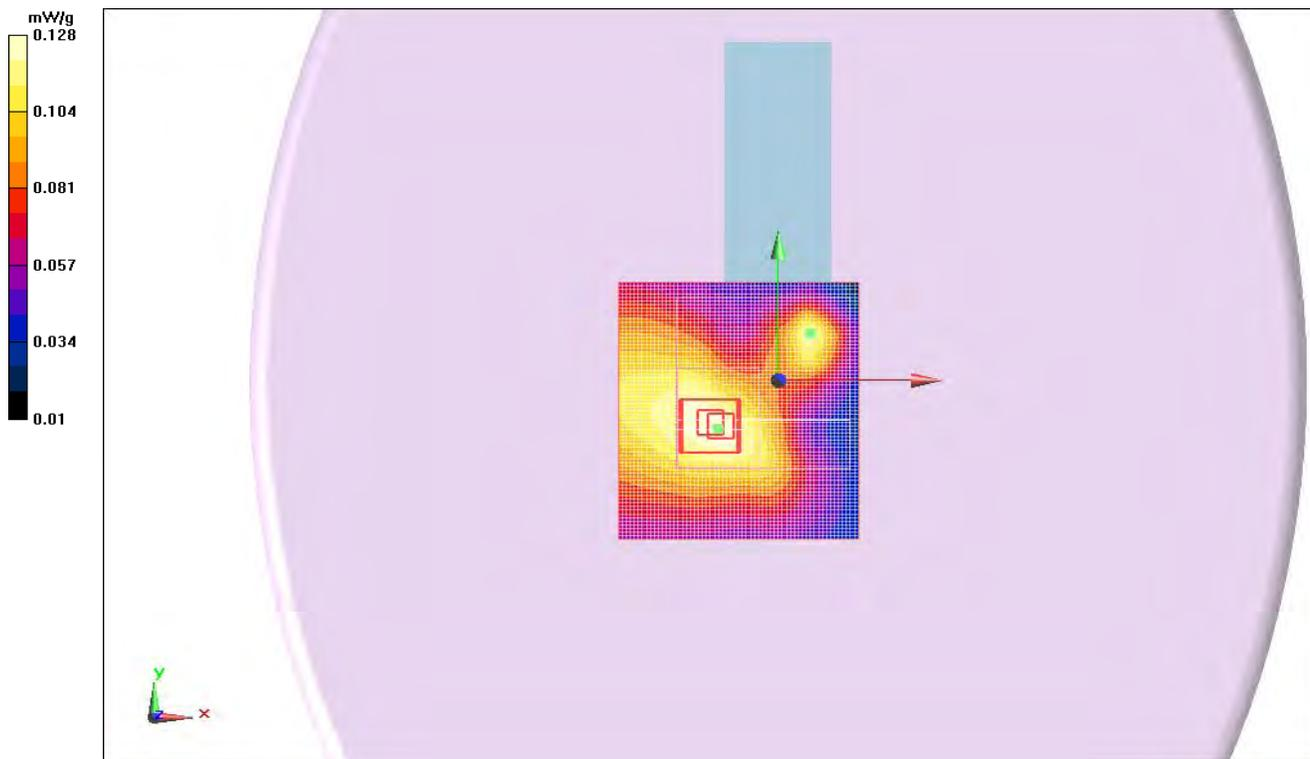

Room Temperature (°C):	23.1	Humidity (%):	43.5	Test Date:	02/13/11
Liquid Temperature (°C):	20.8	Barometric Pressure (mb):	1013	Tested by:	Jennifer Herrett

Test 15

DUT: 1000CP01C Hand Held Computer; Type: CN70; Serial: 24411047084

Communication System: CW; Frequency: 1851.25 MHz

Medium parameters used: $\sigma = 1.47184$ mho/m, $\epsilon_r = 53.5958$; $\rho = 1000$ kg/m³, Medium parameters used: $f = 1900$ MHz; $\sigma = 1.472$ mho/m; $\epsilon_r = 53.596$; $\rho = 1000$ kg/m³

Phantom section: Flat Section

Measurement Standard: DASYS (IEEE/IEC/ANSI C63.19-2007)

DASY5 Configuration:

Probe: ES3DV3 - SN3246; ConvF(4.63, 4.63, 4.63); Calibrated: 11/11/2010

Sensor-Surface: 0mm (Fix Surface), Sensor-Surface: 3mm (Mechanical Surface Detection)

Electronics: DAE4 Sn1237; Calibrated: 11/10/2010

Phantom: ELI 4.0; Type: QDOVA001BA; Serial: xxxx

Measurement SW: DASY52, Version 52.6 (1); SEMCAD X Version 14.4.2 (2595)

Body/Body/Z Scan (1x1x21): Measurement grid: dx=20mm, dy=20mm, dz=5mm

Maximum value of Total (measured) = 12.590 V/m

Body/Body/Zoom Scan (7x9x7)/Cube 0: Measurement grid: dx=5mm, dy=5mm, dz=5mm

Reference Value = 15.348 V/m; Power Drift = 0.04 dB

Peak SAR (extrapolated) = 0.494 W/kg

SAR(1 g) = 0.307 mW/g; SAR(10 g) = 0.189 mW/g

Maximum value of SAR (measured) = 0.362 mW/g

Body/Body/Reference scan (41x81x1): Measurement grid: dx=30mm, dy=30mm

Maximum value of SAR (interpolated) = 0.321 mW/g

Body/Body/Area scan (71x61x1): Measurement grid: dx=15mm, dy=15mm

Maximum value of SAR (interpolated) = 0.357 mW/g



Room Temperature (°C):	22.9	Humidity (%):	39.9	Test Date:	02/13/11
Liquid Temperature (°C):	20.8	Barometric Pressure (mb):	1017	Tested by:	Jennifer Herrett

Test 16

DUT: 1000CP01C Hand Held Computer; Type: CN70; Serial: 24411047084

Communication System: CW; Frequency: 1851.25 MHz

Medium parameters used: $\sigma = 1.47184$ mho/m, $\epsilon_r = 53.5958$; $\rho = 1000$ kg/m³, Medium parameters used: $f = 1900$ MHz; $\sigma = 1.472$ mho/m; $\epsilon_r = 53.596$; $\rho = 1000$ kg/m³

Phantom section: Flat Section

Measurement Standard: DASYS5 (IEEE/IEC/ANSI C63.19-2007)

DASY5 Configuration:

Probe: ES3DV3 - SN3246; ConvF(4.63, 4.63, 4.63); Calibrated: 11/11/2010

Sensor-Surface: 0mm (Fix Surface), Sensor-Surface: 3mm (Mechanical Surface Detection)

Electronics: DAE4 Sn1237; Calibrated: 11/10/2010

Phantom: ELI 4.0; Type: QDOVA001BA; Serial: xxxx

Measurement SW: DASY52, Version 52.6 (1); SEMCAD X Version 14.4.2 (2595)

Body/Body/Z Scan (1x1x21): Measurement grid: dx=20mm, dy=20mm, dz=5mm

Maximum value of Total (measured) = 23.777 V/m

Body/Body/Zoom Scan (7x9x7)/Cube 0: Measurement grid: dx=5mm, dy=5mm, dz=5mm

Reference Value = 30.428 V/m; Power Drift = 0.0085 dB

Peak SAR (extrapolated) = 1.780 W/kg

SAR(1 g) = 1.1 mW/g; SAR(10 g) = 0.678 mW/g

Maximum value of SAR (measured) = 1.310 mW/g

Body/Body/Reference scan (41x71x1): Measurement grid: dx=30mm, dy=30mm

Maximum value of SAR (interpolated) = 0.056 mW/g

Body/Body/Area scan (61x71x1): Measurement grid: dx=15mm, dy=15mm

Maximum value of SAR (interpolated) = 1.316 mW/g

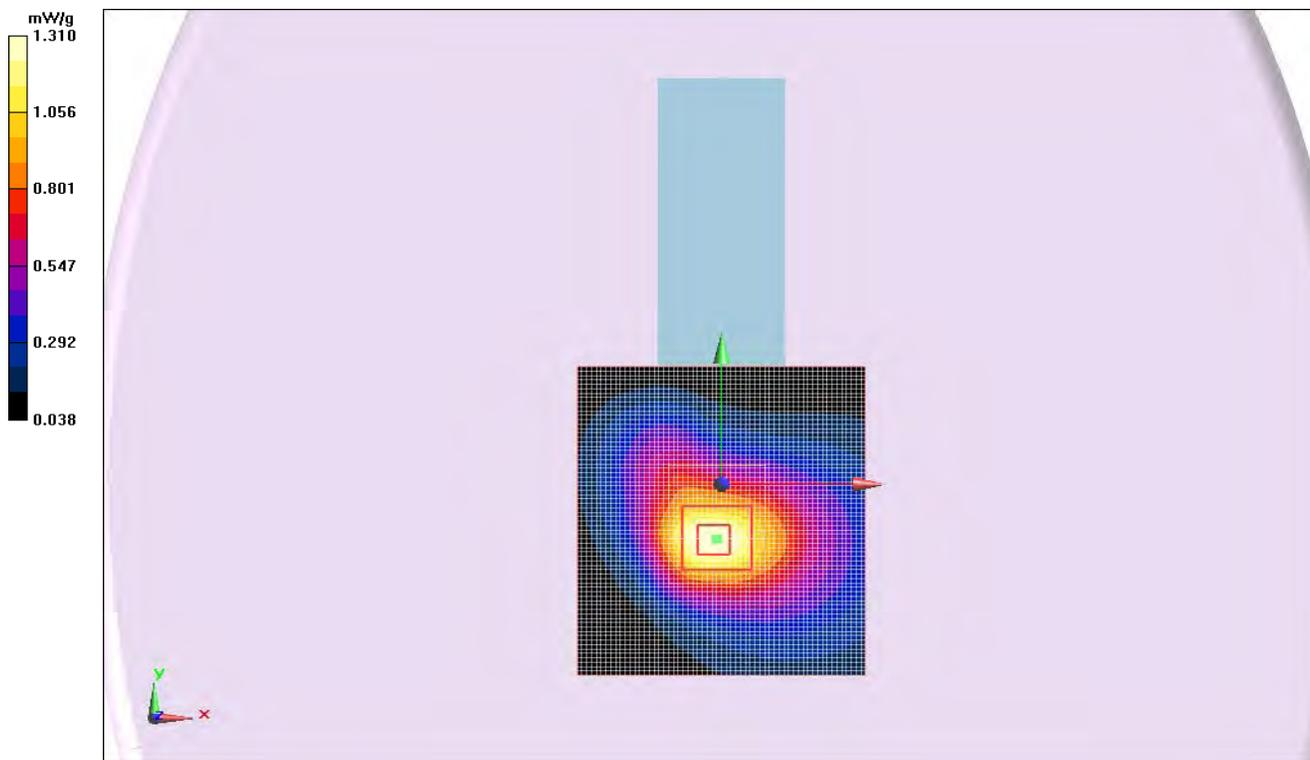

Room Temperature (°C):	22	Humidity (%):	37.3	Test Date:	02/13/11
Liquid Temperature (°C):	20.8	Barometric Pressure (mb):	1018	Tested by:	Jennifer Herrett

Test 18

DUT: 1000CP01C Hand Held Computer; Type: CN70; Serial: 24411047084

Communication System: CW; Frequency: 1880 MHz

Medium parameters used: $\sigma = 1.47184$ mho/m, $\epsilon_r = 53.5958$; $\rho = 1000$ kg/m³, Medium parameters used: $f = 1900$ MHz; $\sigma = 1.472$ mho/m; $\epsilon_r = 53.596$; $\rho = 1000$ kg/m³

Phantom section: Flat Section

Measurement Standard: DASYS5 (IEEE/IEC/ANSI C63.19-2007)

DASY5 Configuration:

Probe: ES3DV3 - SN3246; ConvF(4.63, 4.63, 4.63); Calibrated: 11/11/2010

Sensor-Surface: 0mm (Fix Surface), Sensor-Surface: 3mm (Mechanical Surface Detection)

Electronics: DAE4 Sn1237; Calibrated: 11/10/2010

Phantom: ELI 4.0; Type: QDOVA001BA; Serial: xxxx

Measurement SW: DASY52, Version 52.6 (1); SEMCAD X Version 14.4.2 (2595)

Body/Body/Z Scan (1x1x21): Measurement grid: dx=20mm, dy=20mm, dz=5mm

Maximum value of Total (measured) = 21.603 V/m

Body/Body/Zoom Scan (7x7x7)/Cube 0: Measurement grid: dx=5mm, dy=5mm, dz=5mm

Reference Value = 26.372 V/m; Power Drift = 0.03 dB

Peak SAR (extrapolated) = 1.488 W/kg

SAR(1 g) = 0.906 mW/g; SAR(10 g) = 0.548 mW/g

Maximum value of SAR (measured) = 1.091 mW/g

Body/Body/Reference scan (41x71x1): Measurement grid: dx=30mm, dy=30mm

Maximum value of SAR (interpolated) = 0.909 mW/g

Body/Body/Area scan (61x71x1): Measurement grid: dx=15mm, dy=15mm

Maximum value of SAR (interpolated) = 1.119 mW/g

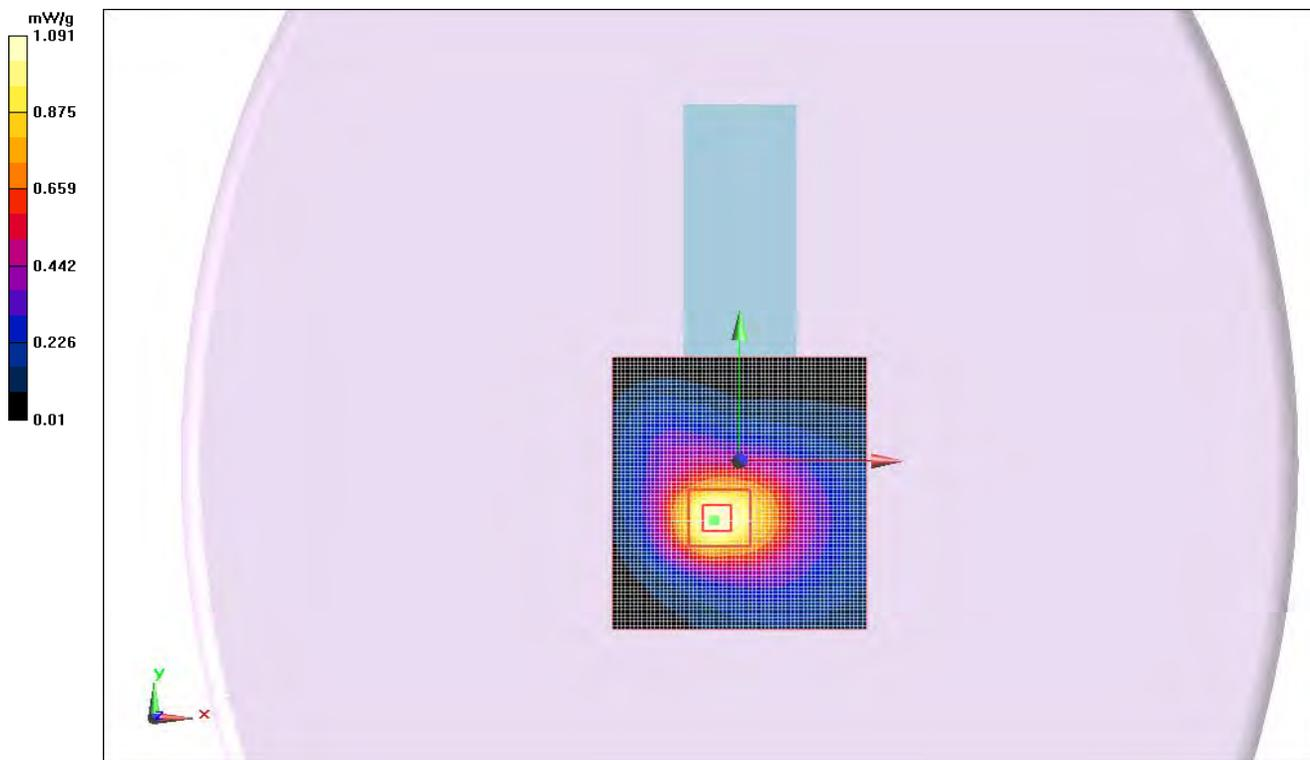

Room Temperature (°C):	23.3	Humidity (%):	35.2	Test Date:	02/17/11
Liquid Temperature (°C):	22.3	Barometric Pressure (mb):	1009	Tested by:	Jennifer Herrett

Test 32

DUT: 1000CP01C Hand Held Computer; Type: CN70; Serial: 24411047084

Communication System: CW; Frequency: 1880 MHz

Medium parameters used: $f = 1880$ MHz; $\sigma = 1.445$ mho/m; $\epsilon_r = 53.39$; $\rho = 1000$ kg/m³, Medium parameters used: $\sigma = 1.445$ mho/m, $\epsilon_r = 53.39$; $\rho = 1000$ kg/m³

Phantom section: Flat Section

Measurement Standard: DASYS (IEEE/IEC/ANSI C63.19-2007)

DASY5 Configuration:

Probe: ES3DV3 - SN3246; ConvF(4.63, 4.63, 4.63); Calibrated: 11/11/2010

Sensor-Surface: 3mm (Mechanical Surface Detection), Sensor-Surface: 0mm (Fix Surface)

Electronics: DAE4 Sn1237; Calibrated: 11/10/2010

Phantom: ELI 4.0; Type: QDOVA001BA; Serial: 1096

Measurement SW: DASY52, Version 52.6 (1); SEMCAD X Version 14.4.2 (2595)

Body/Body - Mid/Reference scan (51x81x1): Measurement grid: dx=30mm, dy=30mm

Maximum value of SAR (interpolated) = 0.174 mW/g

Body/Body - Mid/Area scan (71x71x1): Measurement grid: dx=15mm, dy=15mm

Maximum value of SAR (interpolated) = 0.178 mW/g

Body/Body - Mid/Zoom Scan (8x9x7)/Cube 0: Measurement grid: dx=5mm, dy=5mm, dz=5mm

Reference Value = 22.571 V/m; Power Drift = -0.07 dB

Peak SAR (extrapolated) = 1.133 W/kg

SAR(1 g) = 0.698 mW/g; SAR(10 g) = 0.427 mW/g

Maximum value of SAR (measured) = 0.829 mW/g

Body/Body - Mid/Z Scan (1x1x21): Measurement grid: dx=20mm, dy=20mm, dz=5mm

Maximum value of Total (measured) = 16.891 V/m

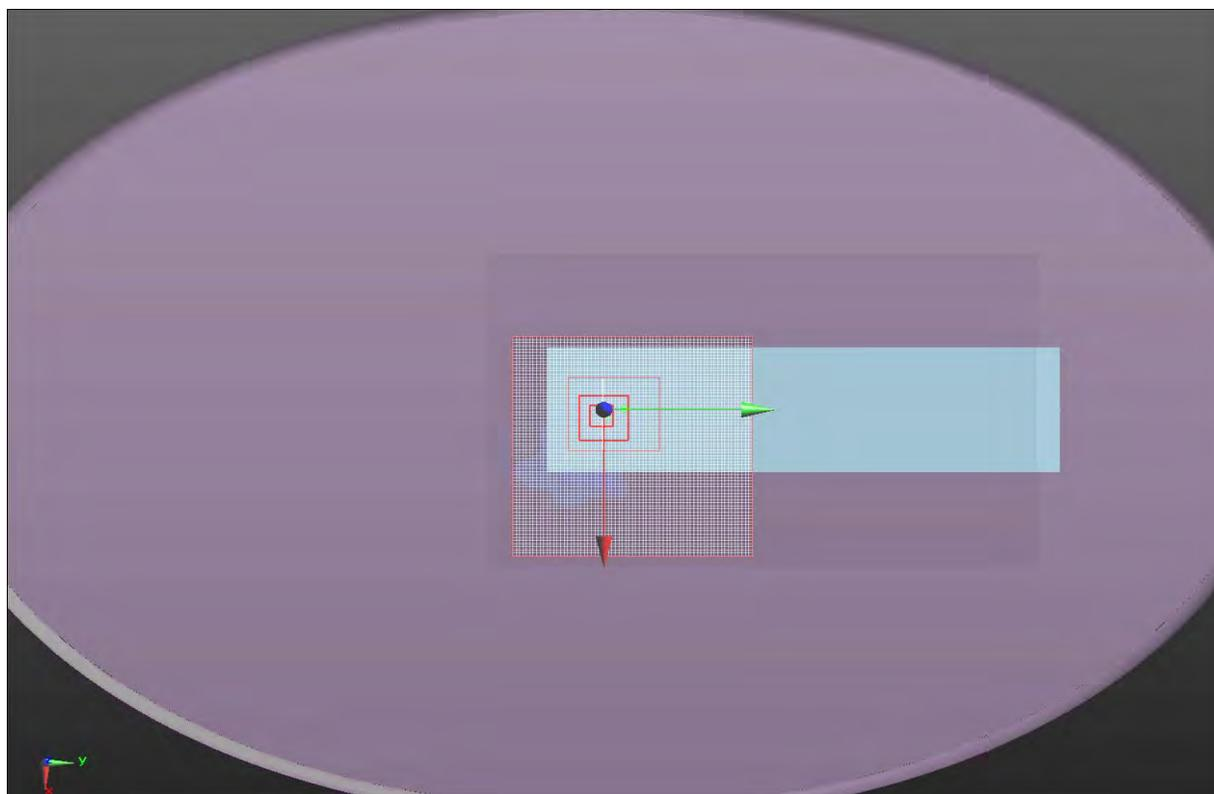
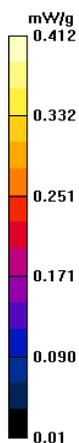

Room Temperature (°C):	21.6	Humidity (%):	35.2	Test Date:	02/17/11
Liquid Temperature (°C):	21.5	Barometric Pressure (mb):	1009	Tested by:	Jennifer Herrett

Test 33

DUT: 1000CP01C Hand Held Computer; Type: CN70; Serial: 24411047084

Communication System: CW; Frequency: 1908.75 MHz

Medium parameters used: $f = 1908.75$ MHz; $\sigma = 1.475$ mho/m; $\epsilon_r = 53.25$; $\rho = 1000$ kg/m³, Medium parameters used: $\sigma = 1.475$ mho/m; $\epsilon_r = 53.25$; $\rho = 1000$ kg/m³

Phantom section: Flat Section

Measurement Standard: DASYS (IEEE/IEC/ANSI C63.19-2007)

DASY5 Configuration:

Probe: ES3DV3 - SN3246; ConvF(4.63, 4.63, 4.63); Calibrated: 11/11/2010

Sensor-Surface: 3mm (Mechanical Surface Detection), Sensor-Surface: 0mm (Fix Surface)

Electronics: DAE4 Sn1237; Calibrated: 11/10/2010

Phantom: ELI 4.0; Type: QDOVA001BA; Serial: 1096

Measurement SW: DASYS2, Version 52.6 (1); SEMCAD X Version 14.4.2 (2595)

Body/Body - High/Reference scan (51x81x1): Measurement grid: dx=30mm, dy=30mm

Maximum value of SAR (interpolated) = 0.956 mW/g

Body/Body - High/Area scan (71x71x1): Measurement grid: dx=15mm, dy=15mm

Maximum value of SAR (interpolated) = 1.047 mW/g

Body/Body - High/Z Scan (1x1x21): Measurement grid: dx=20mm, dy=20mm, dz=5mm

Maximum value of Total (measured) = 20.230 V/m

Body/Body - High/Zoom Scan (8x7x7)/Cube 0: Measurement grid: dx=5mm, dy=5mm, dz=5mm

Reference Value = 26.332 V/m; Power Drift = -0.17 dB

Peak SAR (extrapolated) = 1.404 W/kg

SAR(1 g) = 0.853 mW/g; SAR(10 g) = 0.522 mW/g

Maximum value of SAR (measured) = 1.014 mW/g

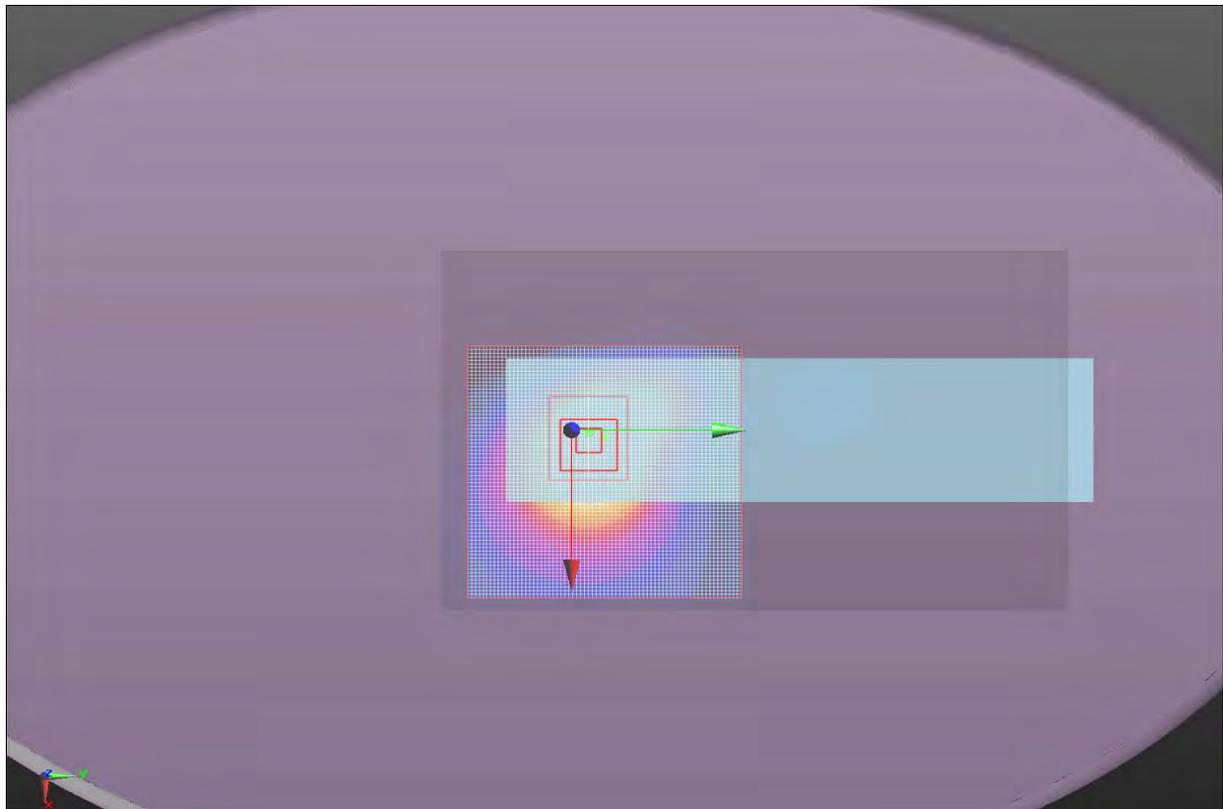
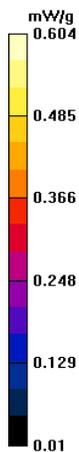

EMC

SAR TEST DATA

Room Temperature (°C):	22.9	Humidity (%):	39.9	Test Date:	02/13/11
Liquid Temperature (°C):	20.8	Barometric Pressure (mb):	1017	Tested by:	Jennifer Herrett

Test 16

DUT: 1000CP01C Hand Held Computer; Type: CN70; Serial: 24411047084

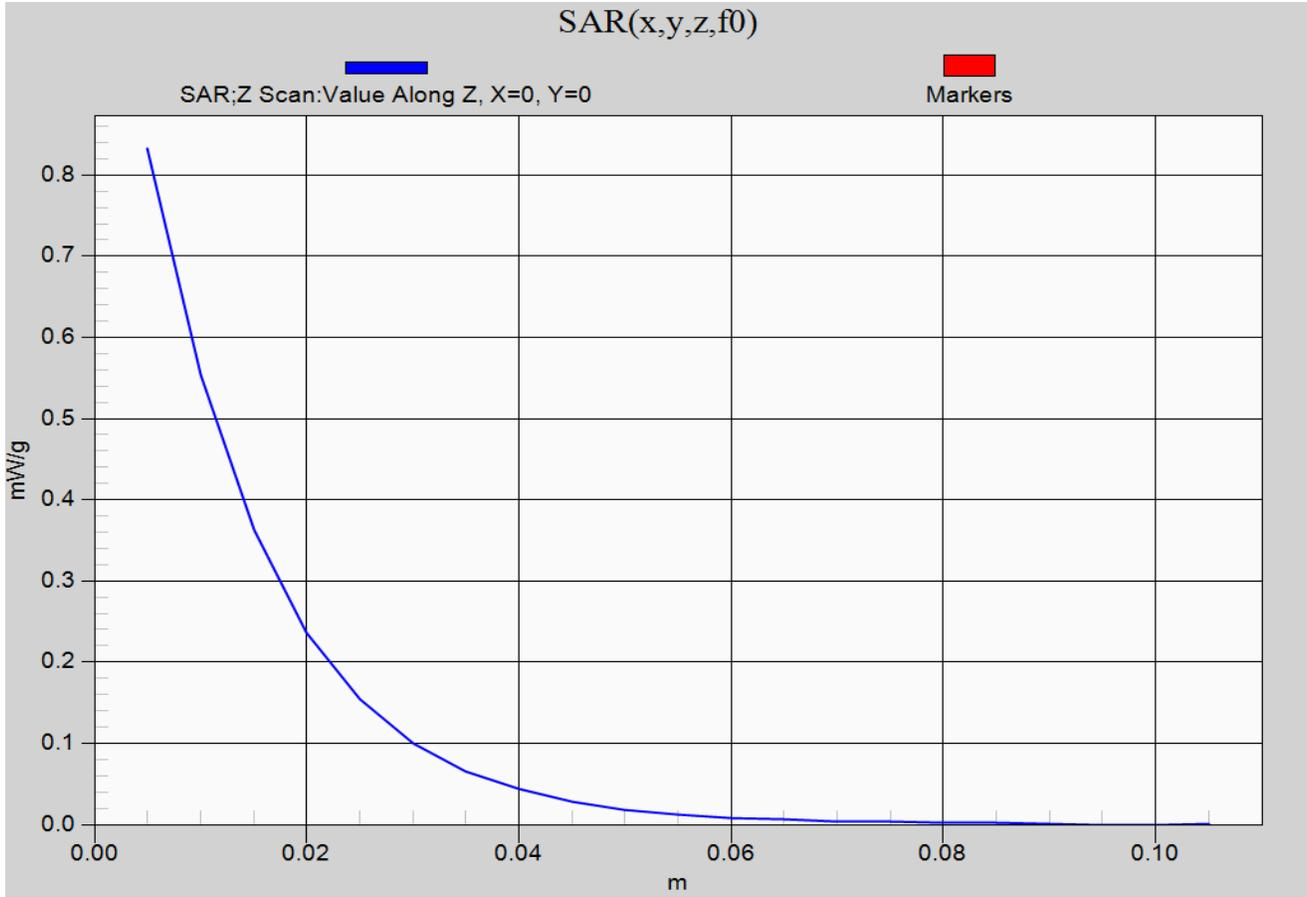

SAR Measurement System

Schmid & Partner Engineering AG, DASY52

Northwest EMC selected the leader in SAR evaluation systems to provide the measurement tools for this evaluation. SPEAG's DASY52 is the fastest and most accurate scanner on the market. It is fully compatible with all world-wide standards for transmitters operating at the ear or within 20cm of the body. It provides full compatibility with IEC 62209-1, IEC 62209-2, IEEE 1528 as well as national adaptations such as FCC OET-65c and Korean Std. MIC #2000-93

The DASY52 system for performing compliance tests consists of the following items:

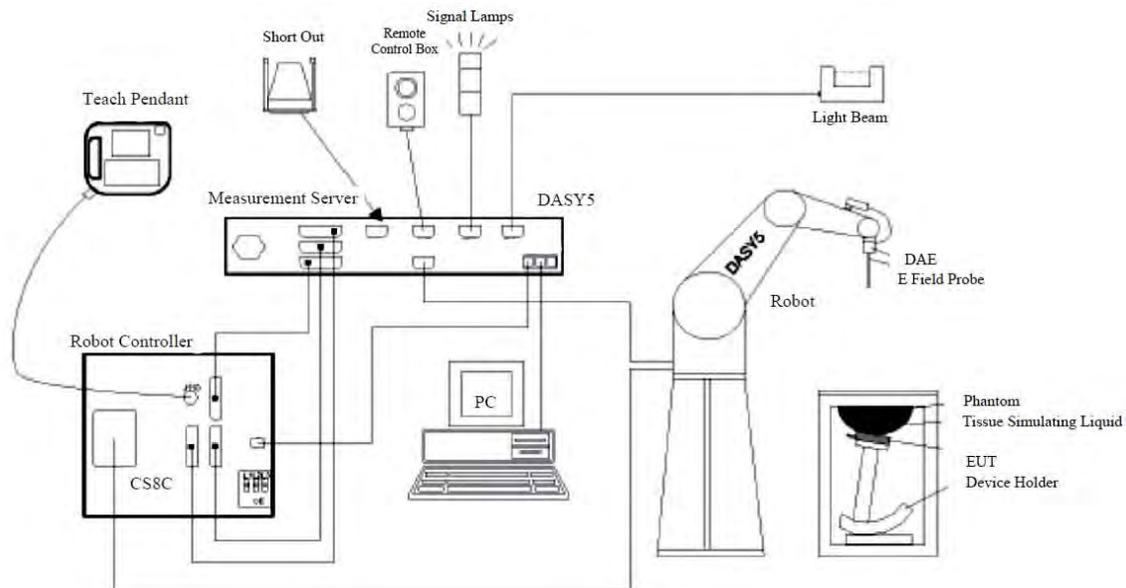

- A standard high precision 6-axis robot (Staubli TX=RX family) with controller, teach pendant and software. An arm extension for accommodating the data acquisition electronics (DAE).
- An isotropic field probe optimized and calibrated for the targeted measurement.
- A data acquisition electronics (DAE) which performs the signal amplification, signal multiplexing, AD-conversion, offset measurements, mechanical surface detection, collision detection, etc. The unit is battery powered with standard or rechargeable batteries. The signal is optically transmitted to the EOC.
- The Electro-optical converter (EOC) performs the conversion from optical to electrical signals for the digital communication to the DAE. To use optical surface detection, a special version of the EOC is required. The EOC signal is transmitted to the measurement server.
- The function of the measurement server is to perform the time critical tasks such as signal filtering, control of the robot operation and fast movement interrupts.
- The Light Beam used is for probe alignment. This improves the (absolute) accuracy of the probe positioning.
- A computer running WinXP and the DASY5 software.
- Remote control and teach pendant as well as additional circuitry for robot safety such as warning lamps, etc.
- The SAM twin phantom, oval flat phantom, device holder, tissue simulating liquids, and validation dipole kits.

Test Site

Northwest EMC, Lab EV08

The SAR measurement system is located in a semi-anechoic chamber. This provides an ambient free environment that also eliminates reflections.

The chamber is 12 ft wide by 16 ft long x 8 ft high. A dedicated HVAC unit provides +/- 1 degree C temperature control.

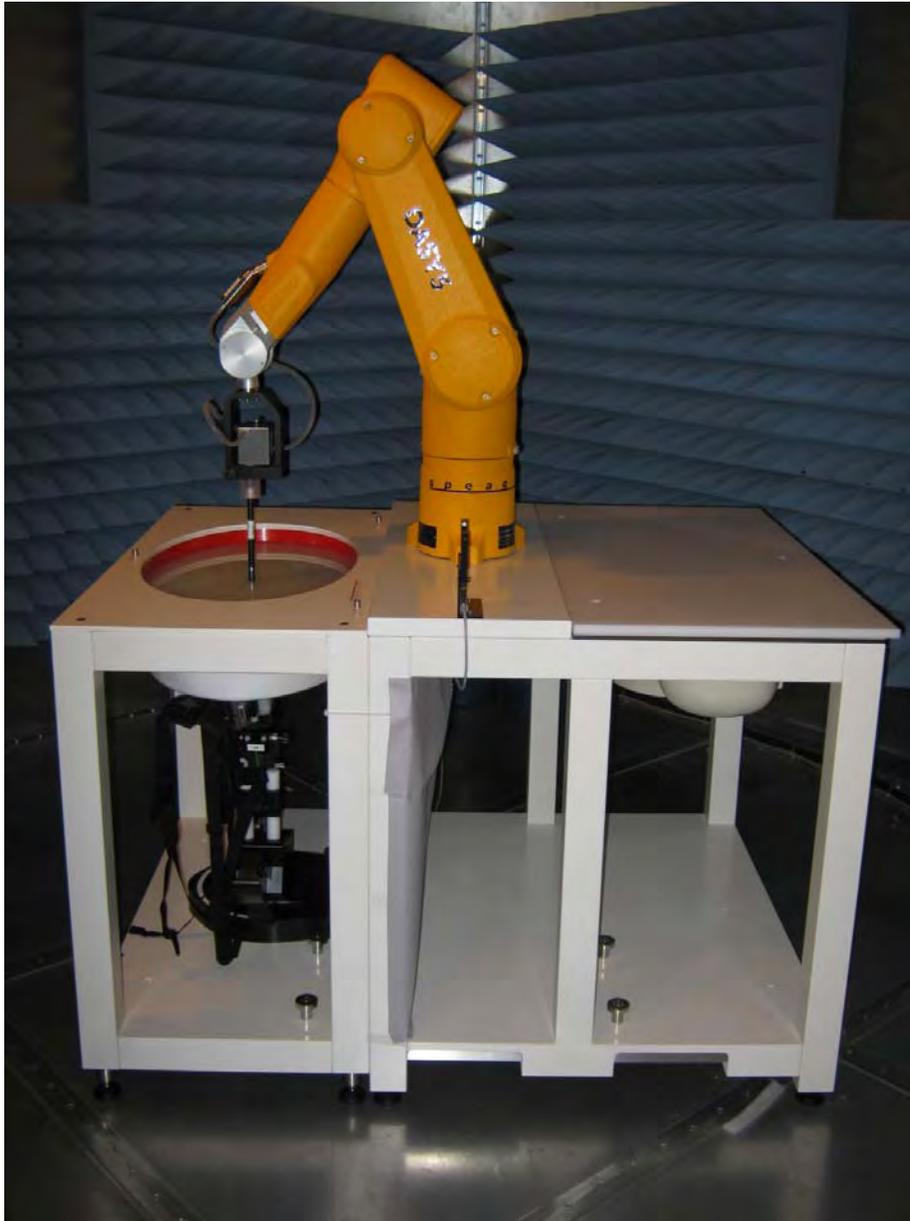

Test Equipment List

Description	Manufacturer	Model	ID	Last Cal.	Interval
SAR Measurement System	SPEAG	DASY52 SAR TX60L	SAA	see below	
Robot and power Supply	Staeubli	N/A	SAJ	NCR	0
DASY5 Measurement Server	Staeubli	DAYS5	SAK	NCR	0
Robot Controller	Staeubli	CS8C	SAI	11/11/2010	12
DASY5 Computer System	Hewlett Packard	N/A	SAX	NCR	0
DAE	SPEAG	SD 000 D04 EJ	SAH	11/11/2010	12
Light Beam Unit	SPEAG	SE UKS 030 AA	SAD	NCR	0
Phantom, 2mm Oval ELI4 (Body)	SPEAG	QD OVA 001 BB	SAC	NCR	0
Phantom, Twin SAM (Head)	SPEAG	QD 000 P40 CC	SAB	NCR	0
Device Holder	SPEAG	N/A	SAW	NCR	0
SAR Probe	SPEAG	ES3DV3	SAF	11/11/2010	12
Validation Dipole 835 MHz	SPEAG	D835V2	ADK	10/19/2010	12
Validation Dipole 1900 MHz	SPEAG	D1900V2	ADO	11/24/2010	12
Body Solution	SPEAG	MSL 900	SAT	Before the first test, then every 24 hours	
Head Solution	SPEAG	HSL 900	SAS		
Body Solution	SPEAG	MSL 1900	SAO		
Head Solution	SPEAG	HSL 1900	SAN		
Power Sensor	Gigatronics	80701A	SPL	1/7/2010	16
Power Meter	Gigatronics	8651A	SPM	1/7/2010	16
Network Analyzer	Agilent	N5230A	NAD	9/8/2010	13
Dielectric Probe Kit	Agilent	85070E	IPP	9/8/2010	13
RF Amplifier	Mini Circuits	ZHL-5W-2G-S+	TRZ	NCR	0
Wireless Test Set	Agilent Technologies	E5515C	R00011	NCR	0
Signal Generator	Agilent	E8257D	TGX	12/10/2008	27
Humidity Temperature Meter	Omegaette	HH311	DTX	10/4/2010	12
Spectrum Analyzer - reference only	Hewlett-Packard	8593E	AAN	NCR	0

Measurement Uncertainty Budget per IEEE 1528:2003

300 – 3000 MHz range

Uncertainty Component	Tolerance (+/- %)	Probability Distribution	Divisor	c_i (1g)	c_i (10g)	u_i (1g) (+/-%)	u_i (10g) (+/-%)	v_i
Measurement System								
Probe calibration (k=1)	5.5	normal	1	1	1	5.5	5.5	∞
Axial isotropy	4.7	rectangular	1.732	0.707	0.707	1.9	1.9	∞
Hemispherical isotropy	9.6	rectangular	1.732	0.707	0.707	3.9	3.9	∞
Boundary effect	1.0	rectangular	1.732	1	1	0.6	0.6	∞
Linearity	4.7	rectangular	1.732	1	1	2.7	2.7	∞
System detection limits	1.0	rectangular	1.732	1	1	0.6	0.6	∞
Readout electronics	0.3	normal	1	1	1	0.3	0.3	∞
Response time	0.8	rectangular	1.732	1	1	0.5	0.5	∞
Integration time	2.6	rectangular	1.732	1	1	1.5	1.5	∞
RF ambient conditions - noise	1.7	rectangular	1.732	1	1	1.0	1.0	∞
RF Ambient Reflections	0.0	rectangular	1.732	1	1	0.0	0.0	∞
Probe positioner mechanical tolerance	0.4	rectangular	1.732	1	1	0.2	0.2	∞
Probe positioner with respect to phantom shell	2.9	rectangular	1.732	1	1	1.7	1.7	∞
Extrapolation, interpolation, and integration algorithms for max. SAR evaluation	1.0	rectangular	1.732	1	1	0.6	0.6	∞
Test Sample Related								
Device Positioning	2.9	normal	1	1	1	2.9	2.9	145
Device Holder	3.6	normal	1	1	1	3.6	3.6	5
Power Drift	5.0	rectangular	1.732	1	1	2.9	2.9	∞
Phantom and tissue parameters								
Phantom Uncertainty - shell thickness tolerances	4.0	rectangular	1.732	1	1	2.3	2.3	∞
Liquid conductivity - deviation from target values	5.0	rectangular	1.732	0.64	0.43	1.8	1.2	∞
Liquid conductivity - measurement uncertainty	6.5	normal	1	0.64	0.43	4.2	2.8	∞
Liquid permittivity - deviation from target values	5.0	rectangular	1.732	0.6	0.49	1.7	1.4	∞
Liquid permittivity - measurement uncertainty	3.2	normal	1	0.6	0.49	1.9	1.6	∞
Combined Standard Uncertainty	RSS					11.2	10.6	387
Expanded Measurement Uncertainty (95% Confidence/	normal (k=2)					22.5	21.2	

Probe Calibration

Please see attached calibration data

SAF

Calibration Laboratory of
 Schmid & Partner
 Engineering AG
 Zeughausstrasse 43, 8004 Zurich, Switzerland



S Schweizerischer Kalibrierdienst
S Service suisse d'étalonnage
C Servizio svizzero di taratura
S Swiss Calibration Service

Accredited by the Swiss Accreditation Service (SAS)
 The Swiss Accreditation Service is one of the signatories to the EA
 Multilateral Agreement for the recognition of calibration certificates

Accreditation No.: **SCS 108**

Client **Northwest EMC**

Certificate No: **ES3-3246_Nov10**

CALIBRATION CERTIFICATE

Object **ES3DV3 - SN:3246**

Calibration procedure(s) **QA CAL-01.v6, QA CAL-12.v6, QA CAL-23.v3 and QA CAL-25.v2
 Calibration procedure for dosimetric E-field probes**

Calibration date **November 11, 2010**

This calibration certificate documents the traceability to national standards, which realize the physical units of measurements (SI).
 The measurements and the uncertainties with confidence probability are given on the following pages and are part of the certificate.

All calibrations have been conducted in the closed laboratory facility: environment temperature $(22 \pm 3)^\circ\text{C}$ and humidity $< 70\%$.

Calibration Equipment used (M&TE critical for calibration)

Primary Standards	ID #	Cal Date (Certificate No.)	Scheduled Calibration
Power meter E4419B	GB41293874	1-Apr-10 (No. 217-01136)	Apr-11
Power sensor E4412A	MY41495277	1-Apr-10 (No. 217-01136)	Apr-11
Power sensor E4412A	MY41498087	1-Apr-10 (No. 217-01136)	Apr-11
Reference 3 dB Attenuator	SN: S5054 (3c)	30-Mar-10 (No. 217-01159)	Mar-11
Reference 20 dB Attenuator	SN: S5086 (20b)	30-Mar-10 (No. 217-01161)	Mar-11
Reference 30 dB Attenuator	SN: S5129 (30b)	30-Mar-10 (No. 217-01160)	Mar-11
Reference Probe ES3DV2	SN: 3013	30-Dec-09 (No. ES3-3013_Dec09)	Dec-10
DAE4	SN: 660	20-Apr-10 (No. DAE4-660_Apr10)	Apr-11

Secondary Standards	ID #	Check Date (in house)	Scheduled Check
RF generator HP 8648C	US3642U01700	4-Aug-99 (in house check Oct-09)	In house check: Oct-11
Network Analyzer HP 8753E	US37390585	18-Oct-01 (in house check Oct-10)	In house check: Oct-11

Calibrated by: **Katja Pokovic** Name: **Katja Pokovic** Function: **Technical Manager**

Approved by: **Niels Kuster** Name: **Niels Kuster** Function: **Quality Manager**

Issued: November 11, 2010

This calibration certificate shall not be reproduced except in full without written approval of the laboratory.



Accredited by the Swiss Accreditation Service (SAS)
The Swiss Accreditation Service is one of the signatories to the EA
Multilateral Agreement for the recognition of calibration certificates

Accreditation No.: **SCS 108**

Glossary:

TSL	tissue simulating liquid
NORM _{x,y,z}	sensitivity in free space
ConvF	sensitivity in TSL / NORM _{x,y,z}
DCP	diode compression point
CF	crest factor (1/duty_cycle) of the RF signal
A, B, C	modulation dependent linearization parameters
Polarization φ	φ rotation around probe axis
Polarization ϑ	ϑ rotation around an axis that is in the plane normal to probe axis (at measurement center), i.e., $\vartheta = 0$ is normal to probe axis

Calibration is Performed According to the Following Standards:

- IEEE Std 1528-2003, "IEEE Recommended Practice for Determining the Peak Spatial-Averaged Specific Absorption Rate (SAR) in the Human Head from Wireless Communications Devices: Measurement Techniques", December 2003
- IEC 62209-1, "Procedure to measure the Specific Absorption Rate (SAR) for hand-held devices used in close proximity to the ear (frequency range of 300 MHz to 3 GHz)", February 2005

Methods Applied and Interpretation of Parameters:

- NORM_{x,y,z}**: Assessed for E-field polarization $\vartheta = 0$ ($f \leq 900$ MHz in TEM-cell; $f > 1800$ MHz: R22 waveguide). NORM_{x,y,z} are only intermediate values, i.e., the uncertainties of NORM_{x,y,z} does not effect the E²-field uncertainty inside TSL (see below ConvF).
- NORM(f)_{x,y,z}** = NORM_{x,y,z} * frequency_response (see Frequency Response Chart). This linearization is implemented in DASY4 software versions later than 4.2. The uncertainty of the frequency response is included in the stated uncertainty of ConvF.
- DCP_{x,y,z}**: DCP are numerical linearization parameters assessed based on the data of power sweep with CW signal (no uncertainty required). DCP does not depend on frequency nor media.
- A_{x,y,z}; B_{x,y,z}; C_{x,y,z}; VR_{x,y,z}**: A, B, C are numerical linearization parameters assessed based on the data of power sweep for specific modulation signal. The parameters do not depend on frequency nor media. VR is the maximum calibration range expressed in RMS voltage across the diode.
- ConvF and Boundary Effect Parameters**: Assessed in flat phantom using E-field (or Temperature Transfer Standard for $f \leq 800$ MHz) and inside waveguide using analytical field distributions based on power measurements for $f > 800$ MHz. The same setups are used for assessment of the parameters applied for boundary compensation (alpha, depth) of which typical uncertainty values are given. These parameters are used in DASY4 software to improve probe accuracy close to the boundary. The sensitivity in TSL corresponds to NORM_{x,y,z} * ConvF whereby the uncertainty corresponds to that given for ConvF. A frequency dependent ConvF is used in DASY version 4.4 and higher which allows extending the validity from ± 50 MHz to ± 100 MHz.
- Spherical isotropy (3D deviation from isotropy)**: in a field of low gradients realized using a flat phantom exposed by a patch antenna.
- Sensor Offset**: The sensor offset corresponds to the offset of virtual measurement center from the probe tip (on probe axis). No tolerance required.

Probe ES3DV3

SN:3246

Manufactured:	May 5, 2009
Calibrated:	November 11, 2010

Calibrated for DASY/EASY Systems

(Note: non-compatible with DASY2 system!)

DASY/EASY - Parameters of Probe: ES3DV3 SN:3246

Basic Calibration Parameters

	Sensor X	Sensor Y	Sensor Z	Unc (k=2)
Norm ($\mu\text{V}/(\text{V}/\text{m})^2$) ^A	1.20	1.23	1.35	± 10.1%
DCP (mV) ^B	104.0	99.5	96.8	

Modulation Calibration Parameters

UID	Communication System Name	PAR		A dB	B dBuV	C	VR mV	Unc ^E (k=2)
10000	CW	0.00	X	0.00	0.00	1.00	148.7	± 2.6 %
			Y	0.00	0.00	1.00	148.9	
			Z	0.00	0.00	1.00	115.9	
10021	GSM-FDD (TDMA, GMSK)	9.20	X	3.88	71.01	17.64	85.2	± 3.7 %
			Y	9.08	82.29	21.95	92.0	
			Z	10.21	84.31	22.94	99.0	

The reported uncertainty of measurement is stated as the standard uncertainty of measurement multiplied by the coverage factor k=2, which for a normal distribution corresponds to a coverage probability of approximately 95%.

^A The uncertainties of NormX,Y,Z do not affect the E²-field uncertainty inside TSL (see Pages 5 and 6).

^B Numerical linearization parameter: uncertainty not required.

^E Uncertainty is determined using the maximum deviation from linear response applying rectangular distribution and is expressed for the square of the field value.

DASY/EASY - Parameters of Probe: ES3DV3 SN:3246

Calibration Parameter Determined in Head Tissue Simulating Media

f [MHz]	Validity [MHz] ^c	Permittivity	Conductivity	ConvF X	ConvF Y	ConvF Z	Alpha	Depth Unc (k=2)
835	± 50 / ± 100	41.5 ± 5%	0.90 ± 5%	6.04	6.04	6.04	0.62	1.57 ± 11.0%
900	± 50 / ± 100	41.5 ± 5%	0.97 ± 5%	6.06	6.06	6.06	0.99	1.10 ± 11.0%
1750	± 50 / ± 100	40.1 ± 5%	1.37 ± 5%	5.21	5.21	5.21	0.72	0.90 ± 11.0%
1900	± 50 / ± 100	40.0 ± 5%	1.40 ± 5%	5.02	5.02	5.02	0.82	0.95 ± 11.0%

^c The validity of ± 100 MHz only applies for DASY v4.4 and higher (see Page 2). The uncertainty is the RSS of the ConvF uncertainty at calibration frequency and the uncertainty for the indicated frequency band.

DASY/EASY - Parameters of Probe: ES3DV3 SN:3246

Calibration Parameter Determined in Body Tissue Simulating Media

f [MHz]	Validity [MHz] ^c	Permittivity	Conductivity	ConvF X	ConvF Y	ConvF Z	Alpha	Depth Unc (k=2)
450	± 50 / ± 100	56.7 ± 5%	0.94 ± 5%	7.00	7.00	7.00	0.07	1.00 ± 13.3%
835	± 50 / ± 100	55.2 ± 5%	0.97 ± 5%	6.10	6.10	6.10	0.99	1.20 ± 11.0%
900	± 50 / ± 100	55.0 ± 5%	1.05 ± 5%	6.01	6.01	6.01	0.99	1.18 ± 11.0%
1750	± 50 / ± 100	53.4 ± 5%	1.49 ± 5%	4.85	4.85	4.85	0.98	0.95 ± 11.0%
1900	± 50 / ± 100	53.3 ± 5%	1.52 ± 5%	4.63	4.63	4.63	0.84	1.00 ± 11.0%

^c The validity of ± 100 MHz only applies for DASY v4 4 and higher (see Page 2). The uncertainty is the RSS of the ConvF uncertainty at calibration frequency and the uncertainty for the indicated frequency band

Frequency Response of E-Field

(TEM-Cell:ifi110 EXX, Waveguide: R22)

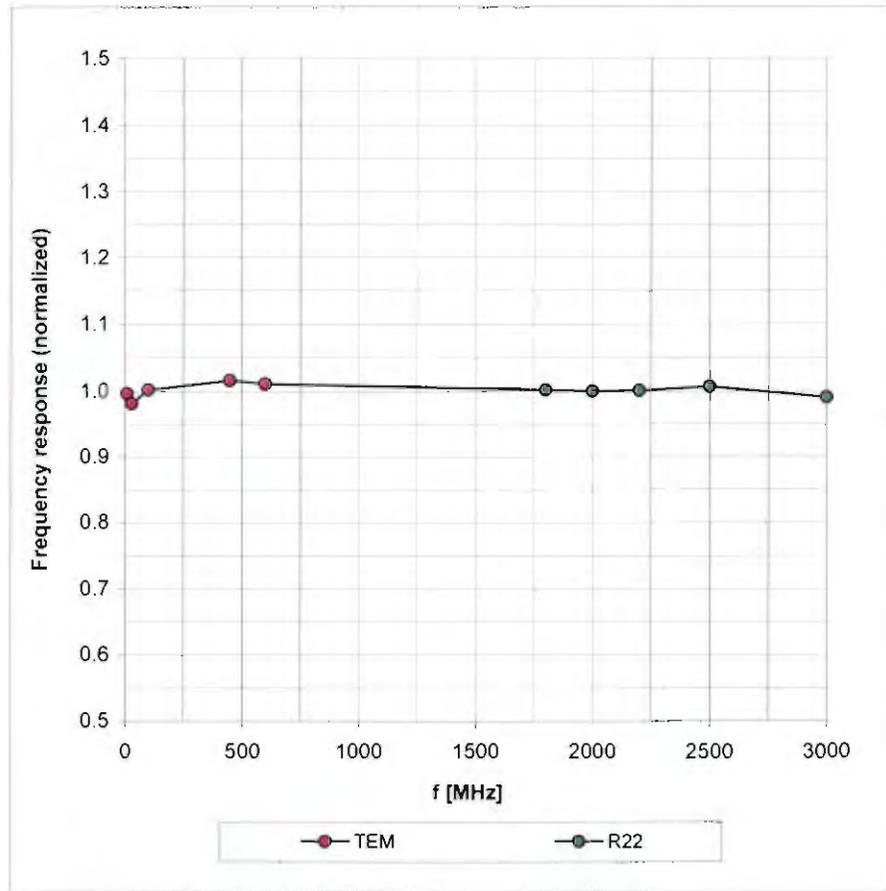

Uncertainty of Frequency Response of E-field: $\pm 6.3\%$ ($k=2$)

Receiving Pattern (ϕ), $\vartheta = 0^\circ$

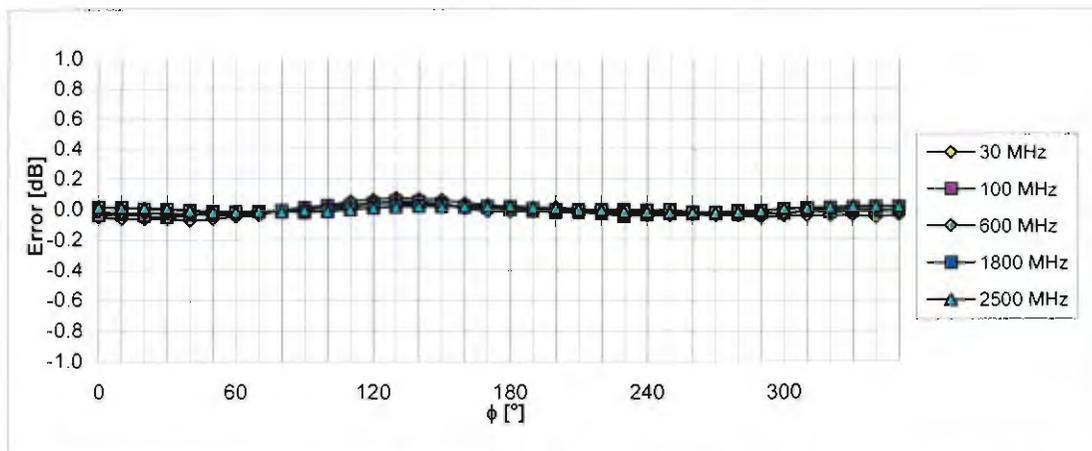
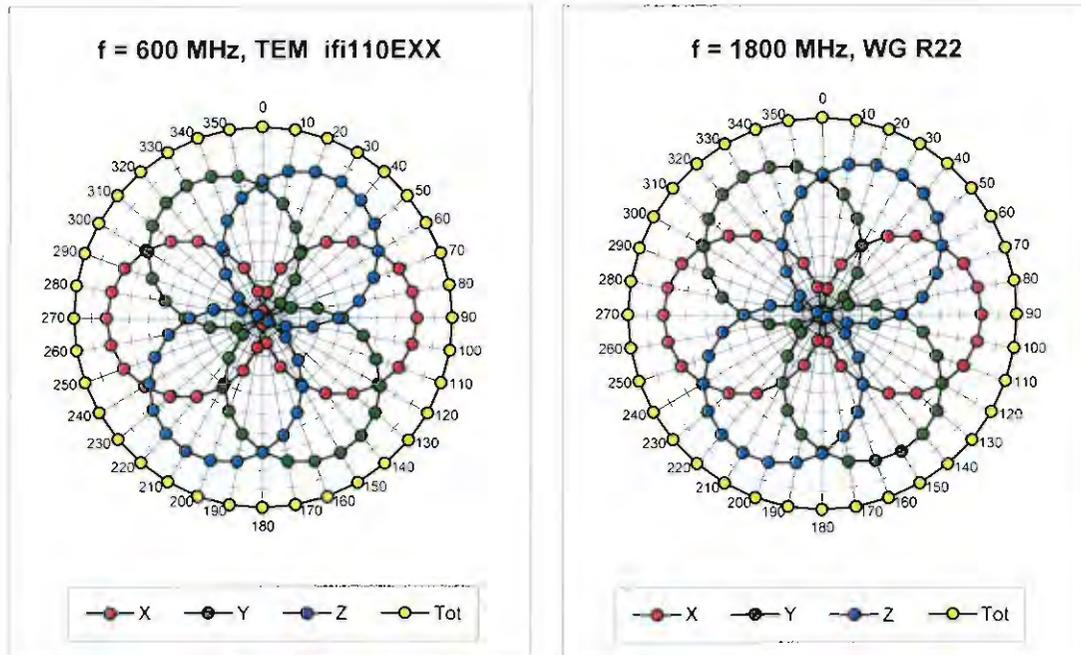

Uncertainty of Axial Isotropy Assessment: $\pm 0.5\%$ ($k=2$)

Dynamic Range $f(\text{SAR}_{\text{head}})$ (Waveguide R22, $f = 1800 \text{ MHz}$)

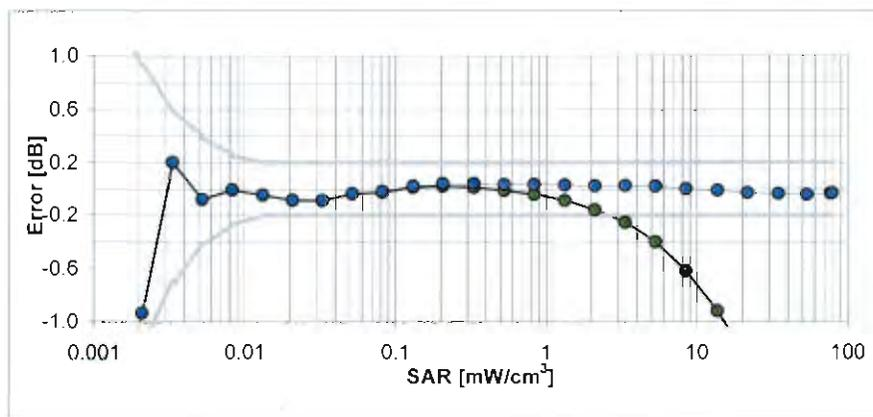
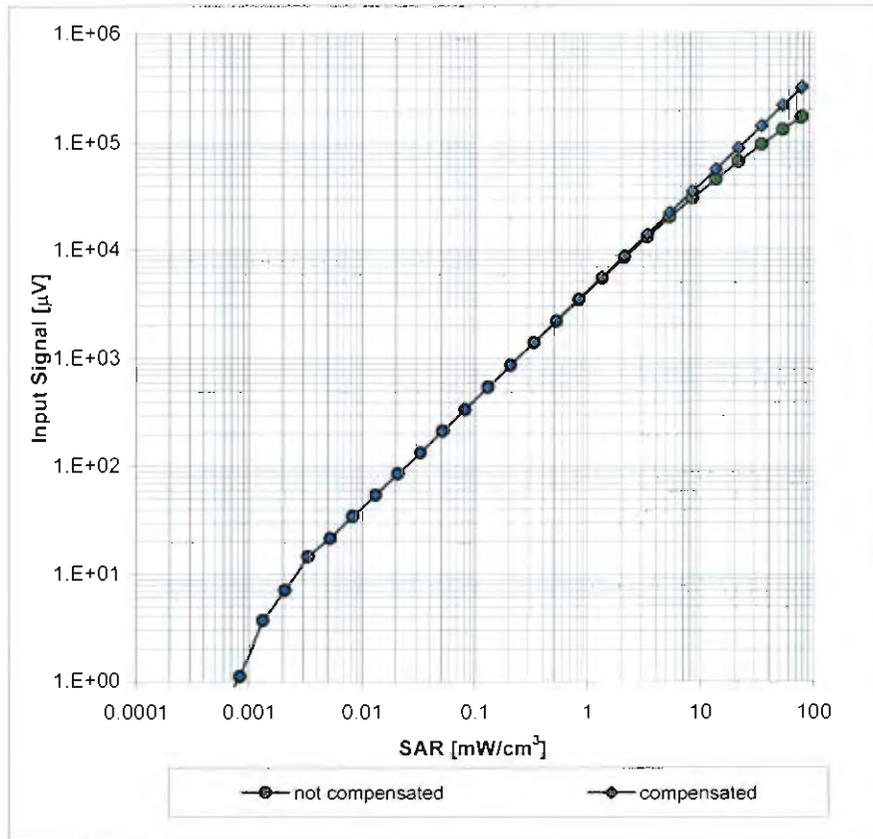

Uncertainty of Linearity Assessment: $\pm 0.6\%$ ($k=2$)

Conversion Factor Assessment

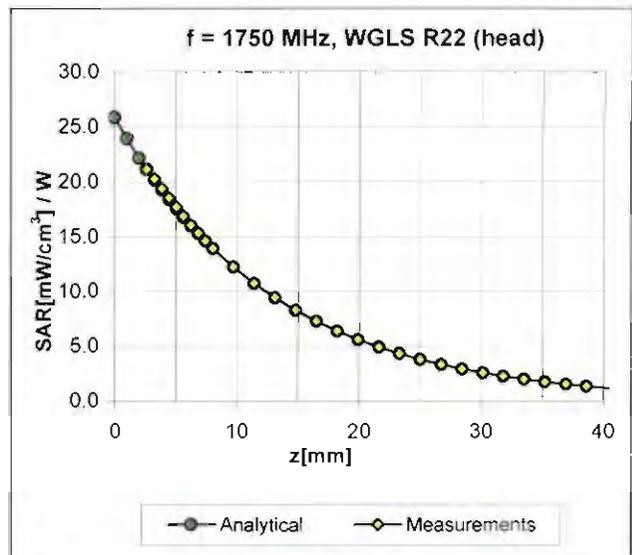
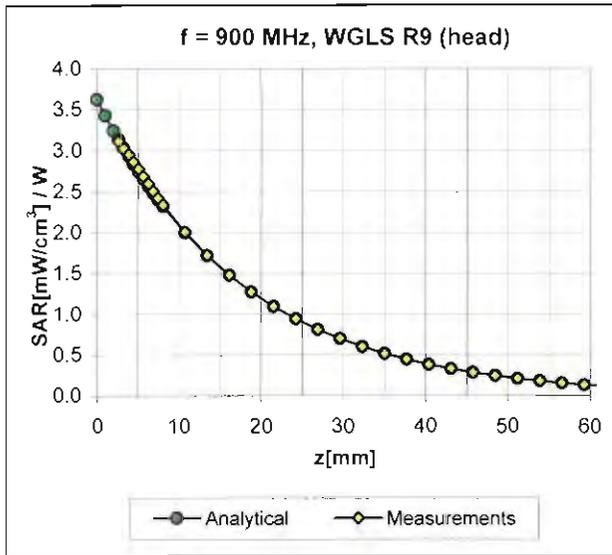

Deviation from Isotropy in HSL

Error (ϕ, θ), f = 900 MHz

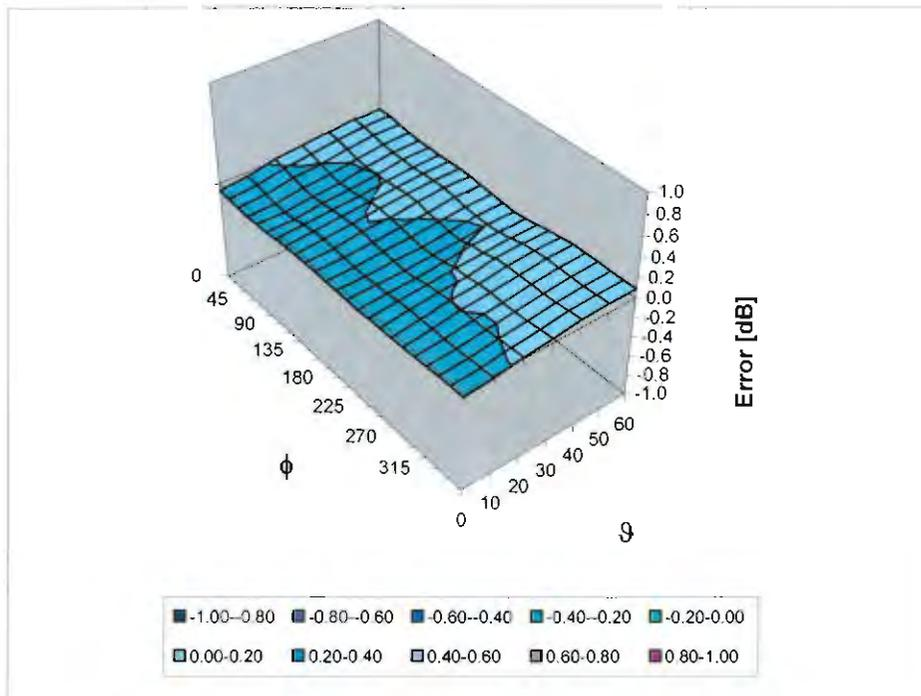

Uncertainty of Spherical Isotropy Assessment: $\pm 2.6\%$ (k=2)

Other Probe Parameters

Sensor Arrangement	Triangular
Connector Angle (°)	Not applicable
Mechanical Surface Detection Mode	enabled
Optical Surface Detection Mode	disabled
Probe Overall Length	337 mm
Probe Body Diameter	10 mm
Tip Length	10 mm
Tip Diameter	4.0 mm
Probe Tip to Sensor X Calibration Point	2 mm
Probe Tip to Sensor Y Calibration Point	2 mm
Probe Tip to Sensor Z Calibration Point	2 mm
Recommended Measurement Distance from Surface	3 mm

Dipole Calibration

Please see attached calibration data

Calibration Laboratory of Schmid & Partner Engineering AG
 Zeughausstrasse 43, 8004 Zurich, Switzerland



S Schweizerischer Kalibrierdienst
S Service suisse d'étalonnage
C Servizio svizzero di taratura
S Swiss Calibration Service

Accredited by the Swiss Accreditation Service (SAS)
 The Swiss Accreditation Service is one of the signatories to the EA
 Multilateral Agreement for the recognition of calibration certificates

Accreditation No.: **SCS 108**

Client **Northwest EMC**

Certificate No: **D835V2-4d108_Oct10**

CALIBRATION CERTIFICATE

Object **D835V2 - SN: 4d108**

Calibration procedure(s) **QA CAL-05.v7
 Calibration procedure for dipole validation kits**

Calibration date: **October 19, 2010**

This calibration certificate documents the traceability to national standards, which realize the physical units of measurements (SI).
 The measurements and the uncertainties with confidence probability are given on the following pages and are part of the certificate.

All calibrations have been conducted in the closed laboratory facility: environment temperature (22 ± 3)°C and humidity < 70%.

Calibration Equipment used (M&TE critical for calibration)

Primary Standards	ID #	Cal Date (Certificate No.)	Scheduled Calibration
Power meter EPM-442A	GB37480704	06-Oct-10 (No. 217-01266)	Oct-11
Power sensor HP 8481A	US37292783	06-Oct-10 (No. 217-01266)	Oct-11
Reference 20 dB Attenuator	SN: 5086 (20g)	30-Mar-10 (No. 217-01158)	Mar-11
Type-N mismatch combination	SN: 5047.2 / 06327	30-Mar-10 (No. 217-01162)	Mar-11
Reference Probe ES3DV3	SN: 3205	30-Apr-10 (No. ES3-3205_Apr10)	Apr-11
DAE4	SN: 601	10-Jun-10 (No. DAE4-601_Jun10)	Jun-11
Secondary Standards	ID #	Check Date (in house)	Scheduled Check
Power sensor HP 8481A	MY41092317	18-Oct-02 (in house check Oct-09)	In house check: Oct-11
RF generator R&S SMT-06	100005	4-Aug-99 (in house check Oct-09)	In house check: Oct-11
Network Analyzer HP 8753E	US37390585 S4206	18-Oct-01 (in house check Oct-10)	In house check: Oct-11

	Name	Function	Signature
Calibrated by:	Dimce Iliev	Laboratory Technician	
Approved by:	Katja Pokovic	Technical Manager	

Issued: October 19, 2010

This calibration certificate shall not be reproduced except in full without written approval of the laboratory.



Accredited by the Swiss Accreditation Service (SAS)
The Swiss Accreditation Service is one of the signatories to the EA
Multilateral Agreement for the recognition of calibration certificates

Accreditation No.: **SCS 108**

Glossary:

TSL	tissue simulating liquid
ConvF	sensitivity in TSL / NORM x,y,z
N/A	not applicable or not measured

Calibration is Performed According to the Following Standards:

- a) IEEE Std 1528-2003, "IEEE Recommended Practice for Determining the Peak Spatial-Averaged Specific Absorption Rate (SAR) in the Human Head from Wireless Communications Devices: Measurement Techniques", December 2003
- b) IEC 62209-1, "Procedure to measure the Specific Absorption Rate (SAR) for hand-held devices used in close proximity to the ear (frequency range of 300 MHz to 3 GHz)", February 2005
- c) Federal Communications Commission Office of Engineering & Technology (FCC OET), "Evaluating Compliance with FCC Guidelines for Human Exposure to Radiofrequency Electromagnetic Fields; Additional Information for Evaluating Compliance of Mobile and Portable Devices with FCC Limits for Human Exposure to Radiofrequency Emissions", Supplement C (Edition 01-01) to Bulletin 65

Additional Documentation:

- d) DASY4/5 System Handbook

Methods Applied and Interpretation of Parameters:

- *Measurement Conditions:* Further details are available from the Validation Report at the end of the certificate. All figures stated in the certificate are valid at the frequency indicated.
- *Antenna Parameters with TSL:* The dipole is mounted with the spacer to position its feed point exactly below the center marking of the flat phantom section, with the arms oriented parallel to the body axis.
- *Feed Point Impedance and Return Loss:* These parameters are measured with the dipole positioned under the liquid filled phantom. The impedance stated is transformed from the measurement at the SMA connector to the feed point. The Return Loss ensures low reflected power. No uncertainty required.
- *Electrical Delay:* One-way delay between the SMA connector and the antenna feed point. No uncertainty required.
- *SAR measured:* SAR measured at the stated antenna input power.
- *SAR normalized:* SAR as measured, normalized to an input power of 1 W at the antenna connector.
- *SAR for nominal TSL parameters:* The measured TSL parameters are used to calculate the nominal SAR result.

Measurement Conditions

DASY system configuration, as far as not given on page 1.

DASY Version	DASY5	V52.2
Extrapolation	Advanced Extrapolation	
Phantom	Modular Flat Phantom V4.9	
Distance Dipole Center - TSL	15 mm	with Spacer
Zoom Scan Resolution	dx, dy, dz = 5 mm	
Frequency	835 MHz ± 1 MHz	

Head TSL parameters

The following parameters and calculations were applied.

	Temperature	Permittivity	Conductivity
Nominal Head TSL parameters	22.0 °C	41.5	0.90 mho/m
Measured Head TSL parameters	(22.0 ± 0.2) °C	42.3 ± 6 %	0.90 mho/m ± 6 %
Head TSL temperature during test	(22.0 ± 0.2) °C	----	----

SAR result with Head TSL

SAR averaged over 1 cm ³ (1 g) of Head TSL	Condition	
SAR measured	250 mW input power	2.40 mW / g
SAR normalized	normalized to 1W	9.60 mW / g
SAR for nominal Head TSL parameters	normalized to 1W	9.64 mW / g ± 17.0 % (k=2)

SAR averaged over 10 cm ³ (10 g) of Head TSL	condition	
SAR measured	250 mW input power	1.57 mW / g
SAR normalized	normalized to 1W	6.28 mW / g
SAR for nominal Head TSL parameters	normalized to 1W	6.29 mW / g ± 16.5 % (k=2)

Body TSL parameters

The following parameters and calculations were applied.

	Temperature	Permittivity	Conductivity
Nominal Body TSL parameters	22.0 °C	55.2	0.97 mho/m
Measured Body TSL parameters	(22.0 ± 0.2) °C	54.4 ± 6 %	0.99 mho/m ± 6 %
Body TSL temperature during test	(21.8 ± 0.2) °C	----	----

SAR result with Body TSL

SAR averaged over 1 cm ³ (1 g) of Body TSL	Condition	
SAR measured	250 mW input power	2.53 mW / g
SAR normalized	normalized to 1W	10.1 mW / g
SAR for nominal Body TSL parameters	normalized to 1W	9.93 mW / g ± 17.0 % (k=2)

SAR averaged over 10 cm ³ (10 g) of Body TSL	condition	
SAR measured	250 mW input power	1.65 mW / g
SAR normalized	normalized to 1W	6.60 mW / g
SAR for nominal Body TSL parameters	normalized to 1W	6.51 mW / g ± 16.5 % (k=2)

Appendix

Antenna Parameters with Head TSL

Impedance, transformed to feed point	51.8 Ω - 3.2 j Ω
Return Loss	- 28.8 dB

Antenna Parameters with Body TSL

Impedance, transformed to feed point	48.0 Ω - 4.4 j Ω
Return Loss	- 26.2 dB

General Antenna Parameters and Design

Electrical Delay (one direction)	1.396 ns
----------------------------------	----------

After long term use with 100W radiated power, only a slight warming of the dipole near the feedpoint can be measured.

The dipole is made of standard semirigid coaxial cable. The center conductor of the feeding line is directly connected to the second arm of the dipole. The antenna is therefore short-circuited for DC-signals.

No excessive force must be applied to the dipole arms, because they might bend or the soldered connections near the feedpoint may be damaged.

Additional EUT Data

Manufactured by	SPEAG
Manufactured on	May 26, 2010

DASY5 Validation Report for Head TSL

Date/Time: 18.10.2010 12:32:33

Test Laboratory: SPEAG, Zurich, Switzerland

DUT: Dipole 835 MHz; Type: D835V2; Serial: D835V2 - SN:4d108

Communication System: CW; Frequency: 835 MHz; Duty Cycle: 1:1

Medium: HSL900

Medium parameters used: $f = 835$ MHz; $\sigma = 0.9$ mho/m; $\epsilon_r = 42.3$; $\rho = 1000$ kg/m³

Phantom section: Flat Section

Measurement Standard: DASY5 (IEEE/IEC/ANSI C63.19-2007)

DASY5 Configuration:

- Probe: ES3DV3 - SN3205; ConvF(6.03, 6.03, 6.03); Calibrated: 30.04.2010
- Sensor-Surface: 3mm (Mechanical Surface Detection)
- Electronics: DAE4 Sn601; Calibrated: 10.06.2010
- Phantom: Flat Phantom 4.9L; Type: QD000P49AA; Serial: 1001
- Measurement SW: DASY52, V52.2 Build 0, Version 52.2.0 (163)
- Postprocessing SW: SEMCAD X, V14.2 Build 2, Version 14.2.2 (1685)

Pin=250 mW /d=15mm, dist=3.0mm (ES-Probe)/Zoom Scan (7x7x7) /Cube 0: Measurement grid: dx=5mm, dy=5mm, dz=5mm

Reference Value = 57.1 V/m; Power Drift = 0.000575 dB

Peak SAR (extrapolated) = 3.61 W/kg

SAR(1 g) = 2.4 mW/g; SAR(10 g) = 1.57 mW/g

Maximum value of SAR (measured) = 2.77 mW/g

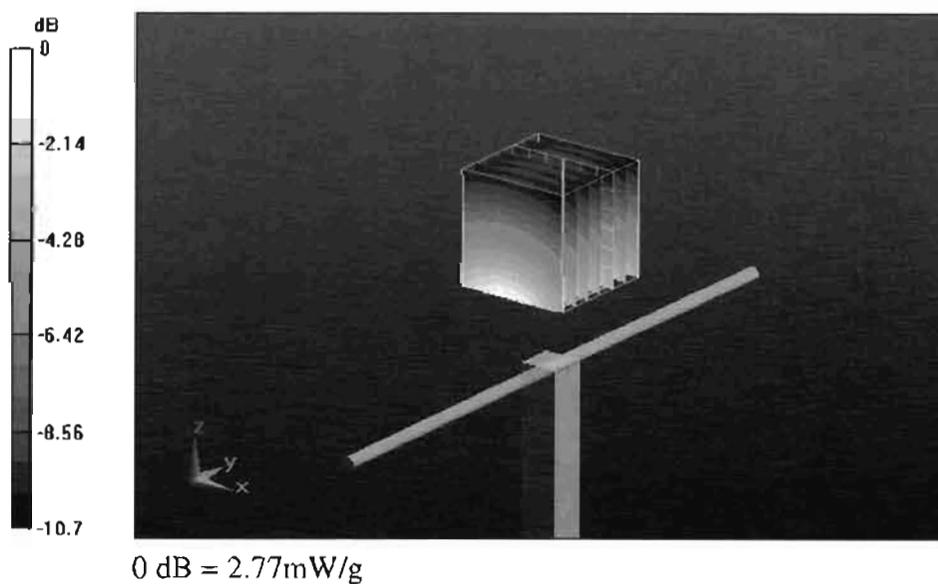

Impedance Measurement Plot for Head TSL

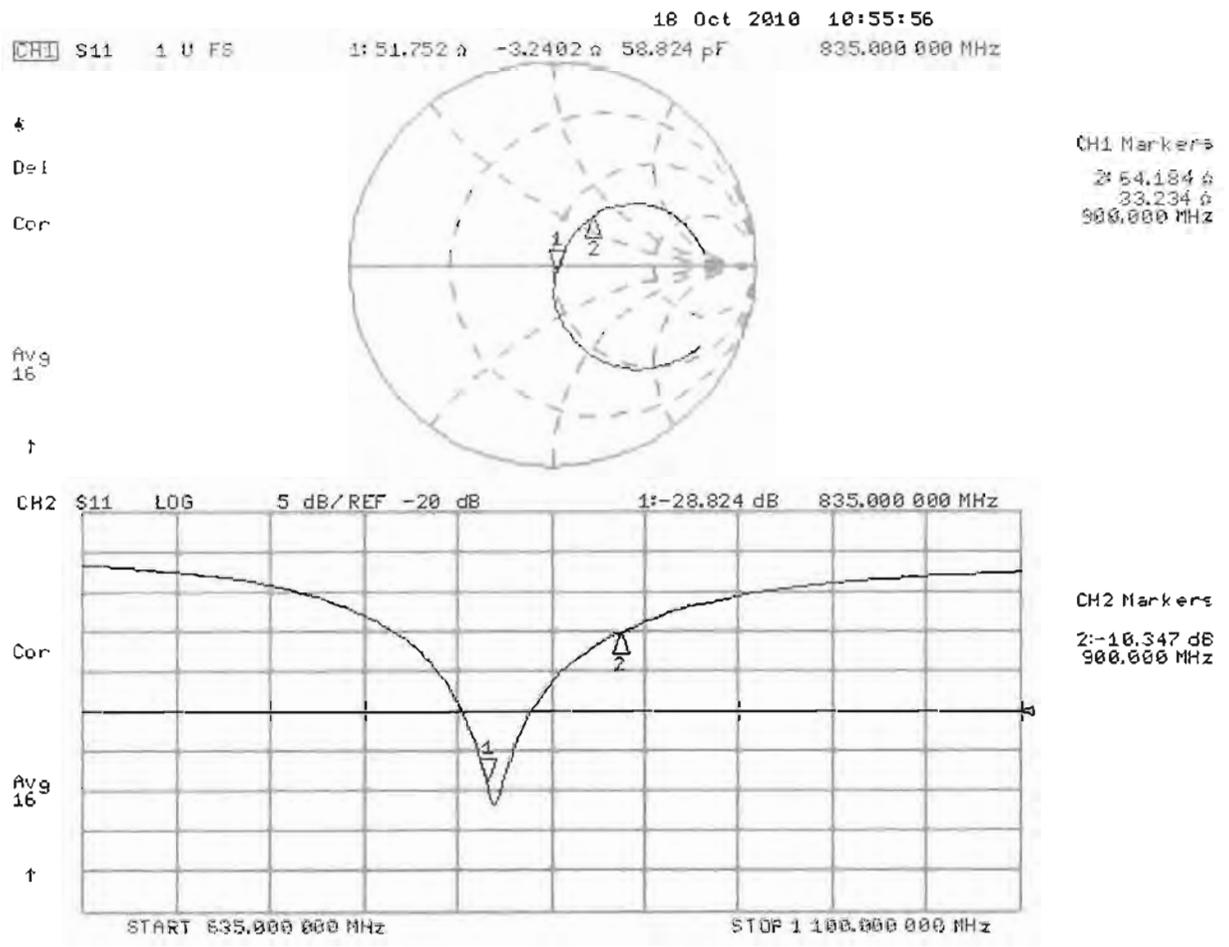

DASY5 Validation Report for Body

Date/Time: 19.10.2010 11:59:09

Test Laboratory: SPEAG, Zurich, Switzerland

DUT: Dipole 835 MHz; Type: D835V2; Serial: D835V2 - SN:4d108

Communication System: CW; Frequency: 835 MHz; Duty Cycle: 1:1

Medium: MSL900

Medium parameters used: $f = 835$ MHz; $\sigma = 0.99$ mho/m; $\epsilon_r = 54.4$; $\rho = 1000$ kg/m³

Phantom section: Flat Section

Measurement Standard: DASY5 (IEEE/IEC/ANSI C63.19-2007)

DASY5 Configuration:

- Probe: ES3DV3 - SN3205; ConvF(5.86, 5.86, 5.86); Calibrated: 30.04.2010
- Sensor-Surface: 3mm (Mechanical Surface Detection)
- Electronics: DAE4 Sn601; Calibrated: 10.06.2010
- Phantom: Flat Phantom 4.9L; Type: QD000P49AA; Serial: 1001
- Measurement SW: DASY52, V52.2 Build 0, Version 52.2.0 (163)
- Postprocessing SW: SEMCAD X, V14.2 Build 2, Version 14.2.2 (1685)

Pin=250 mW /d=15mm, dist=3.0mm (ES-Probe)/Zoom Scan (7x7x7) /Cube 0: Measurement grid: dx=5mm, dy=5mm, dz=5mm

Reference Value = 56.4 V/m; Power Drift = 0.0047 dB

Peak SAR (extrapolated) = 3.73 W/kg

SAR(1 g) = 2.53 mW/g; SAR(10 g) = 1.65 mW/g

Maximum value of SAR (measured) = 2.94 mW/g

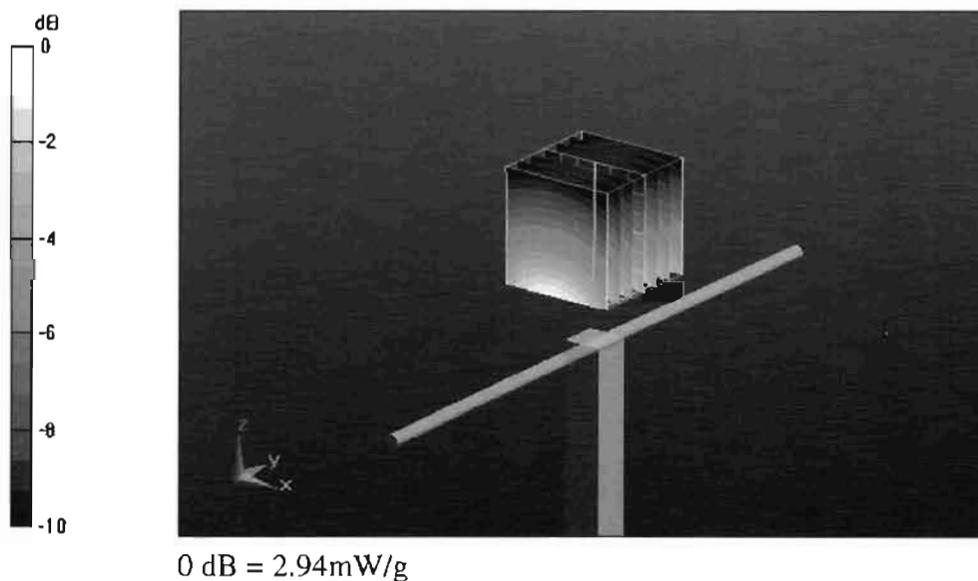

Impedance Measurement Plot for Body TSL

19 Oct 2010 09:56:43
CH1 S11 1 U FS 1: 48.027 Ω -4.3809 Ω 43.509 pF 835.000 000 MHz

*
De l
Cor
Avg
16
↑

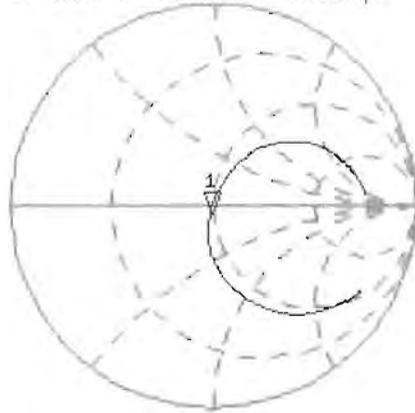

CH2 S11 LOG 5 dB/REF -20 dB 1: -26.208 dB 835.000 000 MHz

Cor
Avg
16
↑

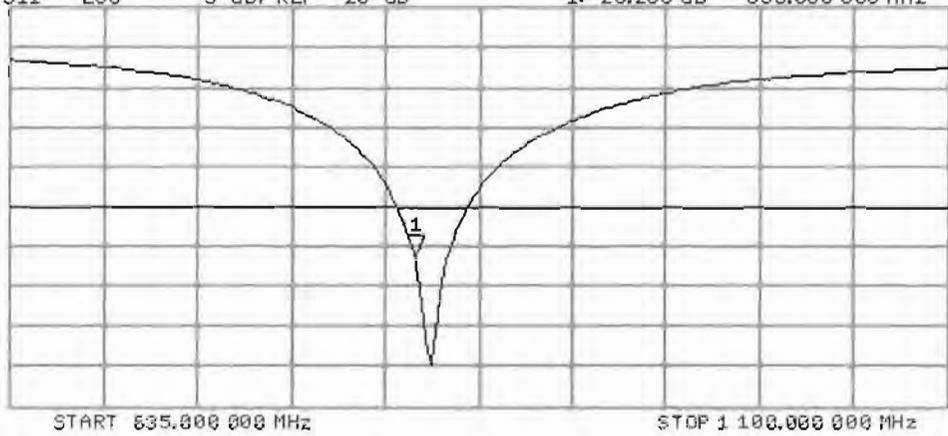

**Calibration Laboratory of
Schmid & Partner
Engineering AG**
Zeughausstrasse 43, 8004 Zurich, Switzerland



S Schweizerischer Kalibrierdienst
C Service suisse d'étalonnage
S Servizio svizzero di taratura
S Swiss Calibration Service

Accredited by the Swiss Accreditation Service (SAS)
The Swiss Accreditation Service is one of the signatories to the EA
Multilateral Agreement for the recognition of calibration certificates

Accreditation No.: **SCS 108**

Client **Northwest EMC**

Certificate No: **D1900V2-5d131_Nov10**

CALIBRATION CERTIFICATE

Object **D1900V2 - SN: 5d131**

Calibration procedure(s) **QA CAL-05.v7
Calibration procedure for dipole validation kits**

Calibration date: **November 24, 2010**

This calibration certificate documents the traceability to national standards, which realize the physical units of measurements (SI).
The measurements and the uncertainties with confidence probability are given on the following pages and are part of the certificate.

All calibrations have been conducted in the closed laboratory facility: environment temperature (22 ± 3)°C and humidity < 70%.

Calibration Equipment used (M&TE critical for calibration)

Primary Standards	ID #	Cal Date (Certificate No.)	Scheduled Calibration
Power meter EPM-442A	GB37480704	06-Oct-10 (No. 217-01266)	Oct-11
Power sensor HP 8481A	US37292783	06-Oct-10 (No. 217-01266)	Oct-11
Reference 20 dB Attenuator	SN: 5086 (20g)	30-Mar-10 (No. 217-01158)	Mar-11
Type-N mismatch combination	SN: 5047.2 / 06327	30-Mar-10 (No. 217-01162)	Mar-11
Reference Probe ES3DV3	SN: 3205	30-Apr-10 (No. ES3-3205_Apr10)	Apr-11
DAE4	SN: 601	10-Jun-10 (No. DAE4-601_Jun10)	Jun-11
Secondary Standards	ID #	Check Date (in house)	Scheduled Check
Power sensor HP 8481A	MY41092317	18-Oct-02 (in house check Oct-09)	In house check: Oct-11
RF generator R&S SMT-06	100005	4-Aug-99 (in house check Oct-09)	In house check: Oct-11
Network Analyzer HP 8753E	US37390585 S4206	18-Oct-01 (in house check Oct-10)	In house check: Oct-11

Calibrated by: **Name** Claudio Leubler **Function** Laboratory Technician

Signature

Approved by: **Name** Katja Pokovic **Function** Technical Manager

Issued: November 25, 2010



Accredited by the Swiss Accreditation Service (SAS)
The Swiss Accreditation Service is one of the signatories to the EA
Multilateral Agreement for the recognition of calibration certificates

Accreditation No.: **SCS 108**

Glossary:

TSL	tissue simulating liquid
ConvF	sensitivity in TSL / NORM x,y,z
N/A	not applicable or not measured

Calibration is Performed According to the Following Standards:

- IEEE Std 1528-2003, "IEEE Recommended Practice for Determining the Peak Spatial-Averaged Specific Absorption Rate (SAR) in the Human Head from Wireless Communications Devices: Measurement Techniques", December 2003
- IEC 62209-1, "Procedure to measure the Specific Absorption Rate (SAR) for hand-held devices used in close proximity to the ear (frequency range of 300 MHz to 3 GHz)", February 2005
- Federal Communications Commission Office of Engineering & Technology (FCC OET), "Evaluating Compliance with FCC Guidelines for Human Exposure to Radiofrequency Electromagnetic Fields; Additional Information for Evaluating Compliance of Mobile and Portable Devices with FCC Limits for Human Exposure to Radiofrequency Emissions", Supplement C (Edition 01-01) to Bulletin 65

Additional Documentation:

- DASY4/5 System Handbook

Methods Applied and Interpretation of Parameters:

- Measurement Conditions:** Further details are available from the Validation Report at the end of the certificate. All figures stated in the certificate are valid at the frequency indicated.
- Antenna Parameters with TSL:** The dipole is mounted with the spacer to position its feed point exactly below the center marking of the flat phantom section, with the arms oriented parallel to the body axis.
- Feed Point Impedance and Return Loss:** These parameters are measured with the dipole positioned under the liquid filled phantom. The impedance stated is transformed from the measurement at the SMA connector to the feed point. The Return Loss ensures low reflected power. No uncertainty required.
- Electrical Delay:** One-way delay between the SMA connector and the antenna feed point. No uncertainty required.
- SAR measured:** SAR measured at the stated antenna input power.
- SAR normalized:** SAR as measured, normalized to an input power of 1 W at the antenna connector.
- SAR for nominal TSL parameters:** The measured TSL parameters are used to calculate the nominal SAR result.

Measurement Conditions

DASY system configuration, as far as not given on page 1.

DASY Version	DASY5	V52.2
Extrapolation	Advanced Extrapolation	
Phantom	Modular Flat Phantom V5.0	
Distance Dipole Center - TSL	10 mm	with Spacer
Zoom Scan Resolution	dx, dy, dz = 5 mm	
Frequency	1900 MHz \pm 1 MHz	

Head TSL parameters

The following parameters and calculations were applied.

	Temperature	Permittivity	Conductivity
Nominal Head TSL parameters	22.0 °C	40.0	1.40 mho/m
Measured Head TSL parameters	(22.0 \pm 0.2) °C	39.3 \pm 6 %	1.40 mho/m \pm 6 %
Head TSL temperature during test	(22.0 \pm 0.2) °C	----	----

SAR result with Head TSL

SAR averaged over 1 cm ³ (1 g) of Head TSL	Condition	
SAR measured	250 mW input power	10.1 mW / g
SAR normalized	normalized to 1W	40.4 mW / g
SAR for nominal Head TSL parameters	normalized to 1W	40.2 mW / g \pm 17.0 % (k=2)

SAR averaged over 10 cm ³ (10 g) of Head TSL	condition	
SAR measured	250 mW input power	5.23 mW / g
SAR normalized	normalized to 1W	20.9 mW / g
SAR for nominal Head TSL parameters	normalized to 1W	20.9 mW / g \pm 16.5 % (k=2)

Body TSL parameters

The following parameters and calculations were applied.

	Temperature	Permittivity	Conductivity
Nominal Body TSL parameters	22.0 °C	53.3	1.52 mho/m
Measured Body TSL parameters	(22.0 ± 0.2) °C	52.8 ± 6 %	1.52 mho/m ± 6 %
Body TSL temperature during test	(22.0 ± 0.2) °C	----	----

SAR result with Body TSL

SAR averaged over 1 cm ³ (1 g) of Body TSL	Condition	
SAR measured	250 mW input power	10.0 mW / g
SAR normalized	normalized to 1W	40.0 mW / g
SAR for nominal Body TSL parameters	normalized to 1W	39.9 mW / g ± 17.0 % (k=2)

SAR averaged over 10 cm ³ (10 g) of Body TSL	condition	
SAR measured	250 mW input power	5.25 mW / g
SAR normalized	normalized to 1W	21.0 mW / g
SAR for nominal Body TSL parameters	normalized to 1W	21.0 mW / g ± 16.5 % (k=2)

Appendix

Antenna Parameters with Head TSL

Impedance, transformed to feed point	$52.7 \Omega + 6.5 j\Omega$
Return Loss	- 23.3 dB

Antenna Parameters with Body TSL

Impedance, transformed to feed point	$48.1 \Omega + 6.9 j\Omega$
Return Loss	- 22.8 dB

General Antenna Parameters and Design

Electrical Delay (one direction)	1.206 ns
----------------------------------	----------

After long term use with 100W radiated power, only a slight warming of the dipole near the feedpoint can be measured.

The dipole is made of standard semirigid coaxial cable. The center conductor of the feeding line is directly connected to the second arm of the dipole. The antenna is therefore short-circuited for DC-signals.

No excessive force must be applied to the dipole arms, because they might bend or the soldered connections near the feedpoint may be damaged.

Additional EUT Data

Manufactured by	SPEAG
Manufactured on	April 14, 2010

DASY5 Validation Report for Head TSL

Date/Time: 10.11.2010 16:31:30

Test Laboratory: SPEAG, Zurich, Switzerland

DUT: Dipole 1900 MHz; Type: D1900V2; Serial: D1900V2 - SN: 5d131

Communication System: CW; Frequency: 1900 MHz; Duty Cycle: 1:1

Medium: HSL U12 BB

Medium parameters used: $f = 1900$ MHz; $\sigma = 1.4$ mho/m; $\epsilon_r = 39.3$; $\rho = 1000$ kg/m³

Phantom section: Flat Section

Measurement Standard: DASY5 (IEEE/IEC/ANSI C63.19-2007)

DASY5 Configuration:

- Probe: ES3DV3 - SN3205; ConvF(5.09, 5.09, 5.09); Calibrated: 30.04.2010
- Sensor-Surface: 3mm (Mechanical Surface Detection)
- Electronics: DAE4 Sn601; Calibrated: 10.06.2010
- Phantom: Flat Phantom 5.0 (front); Type: QD000P50AA; Serial: 1001
- Measurement SW: DASY52, V52.2 Build 0, Version 52.2.0 (163)
- Postprocessing SW: SEMCAD X, V14.2 Build 2, Version 14.2.2 (1685)

Head/d=10mm, Pin=250 mW, dist=3.0mm (ES-Probe)/Zoom Scan (7x7x7) (7x7x7)/Cube 0:

Measurement grid: dx=5mm, dy=5mm, dz=5mm

Reference Value = 95.1 V/m; Power Drift = 0.064 dB

Peak SAR (extrapolated) = 18.4 W/kg

SAR(1 g) = 10.1 mW/g; SAR(10 g) = 5.23 mW/g

Maximum value of SAR (measured) = 12.6 mW/g

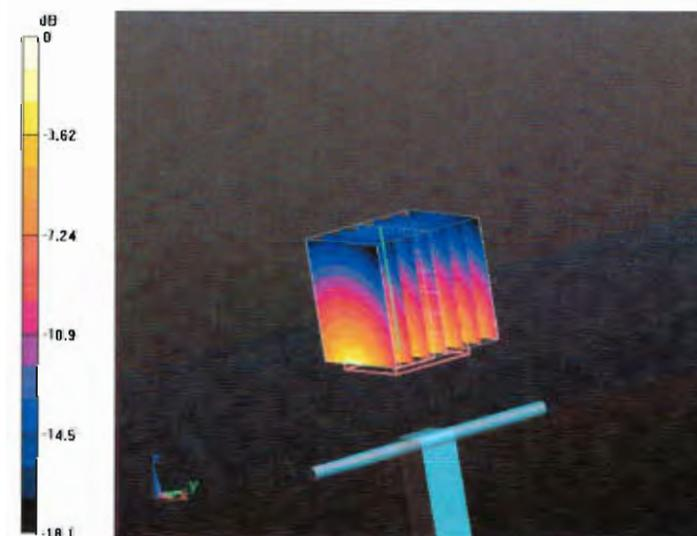

0 dB = 12.6mW/g

Impedance Measurement Plot for Head TSL

10 Nov 2010 13:03:53

CH1 S11 1 U FS 1: 52.686 Ω 6.4824 Ω 543.01 μH 1 900.000 000 MHz

De l

CA

Av g
16

↑

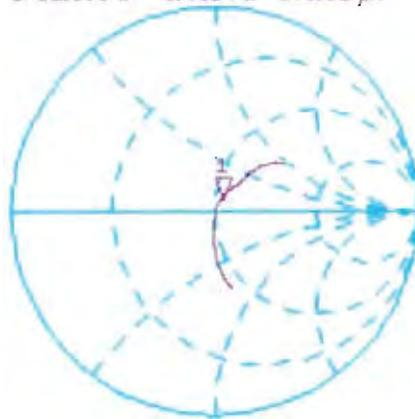

CH2 S11 LOG 5 dB/REF -20 dB 1: -23.325 dB 1 900.000 000 MHz

CA

Av g
16

↑

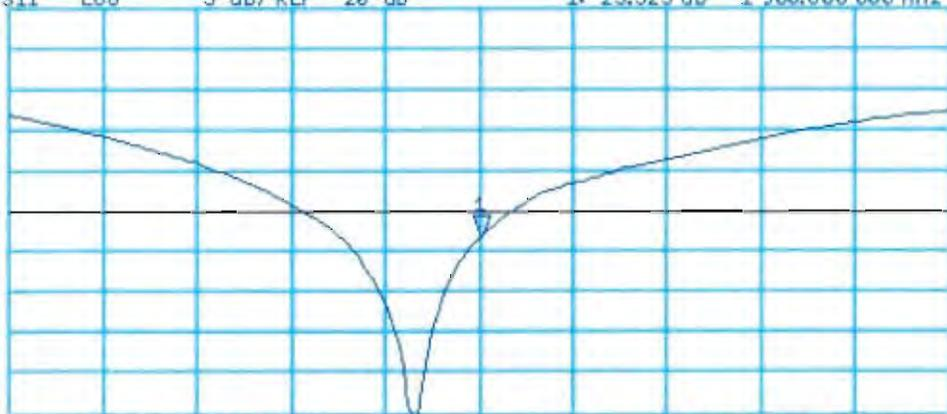

START 1 700.000 000 MHz

STOP 2 100.000 000 MHz

DASY5 Validation Report for Body

Date/Time: 24.11.2010 12:48:29

Test Laboratory: SPEAG, Zurich, Switzerland

DUT: Dipole 1900 MHz; Type: D1900V2; Serial: D1900V2 - SN:5d131

Communication System: CW; Frequency: 1900 MHz; Duty Cycle: 1:1

Medium: MSL U12 BB

Medium parameters used: $f = 1900$ MHz; $\sigma = 1.52$ mho/m; $\epsilon_r = 52.8$; $\rho = 1000$ kg/m³

Phantom section: Flat Section

Measurement Standard: DASY5 (IEEE/IEC/ANSI C63.19-2007)

DASY5 Configuration:

- Probe: ES3DV3 - SN3205; ConvF(4.59, 4.59, 4.59); Calibrated: 30.04.2010
- Sensor-Surface: 3mm (Mechanical Surface Detection)
- Electronics: DAE4 Sn601; Calibrated: 10.06.2010
- Phantom: Flat Phantom 5.0 (back); Type: QD000P50AA; Serial: 1002
- Measurement SW: DASY52, V52.2 Build 0, Version 52.2.0 (163)
- Postprocessing SW: SEMCAD X, V14.2 Build 2, Version 14.2.2 (1685)

Body/d=10mm, Pin=250 mW, dist=3.0mm (ES-Probe)/Zoom Scan (7x7x7) (7x7x7)/Cube 0:

Measurement grid: dx=5mm, dy=5mm, dz=5mm

Reference Value = 95.7 V/m; Power Drift = -0.00519 dB

Peak SAR (extrapolated) = 17.2 W/kg

SAR(1 g) = 10 mW/g; SAR(10 g) = 5.25 mW/g

Maximum value of SAR (measured) = 12.3 mW/g



0 dB = 12.3mW/g

Impedance Measurement Plot for Body TSL

24 Nov 2010 10:39:26

CH1 S11 1 U FS 3: 48.105 Ω 6.9102 Ω 578.83 μH 1 900.000 000 MHz

Del

Cor

Avg
16

↑

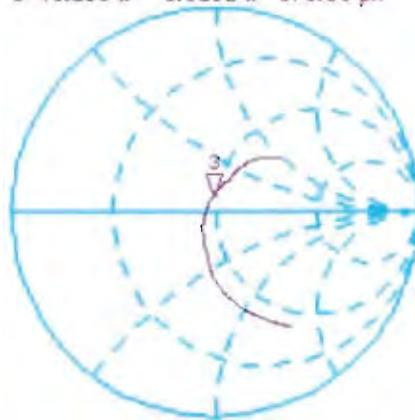

CH2 S11 LOG 5 dB/REF -20 dB 3:-22.750 dB 1 900.000 000 MHz

Cor

Avg
16

↑

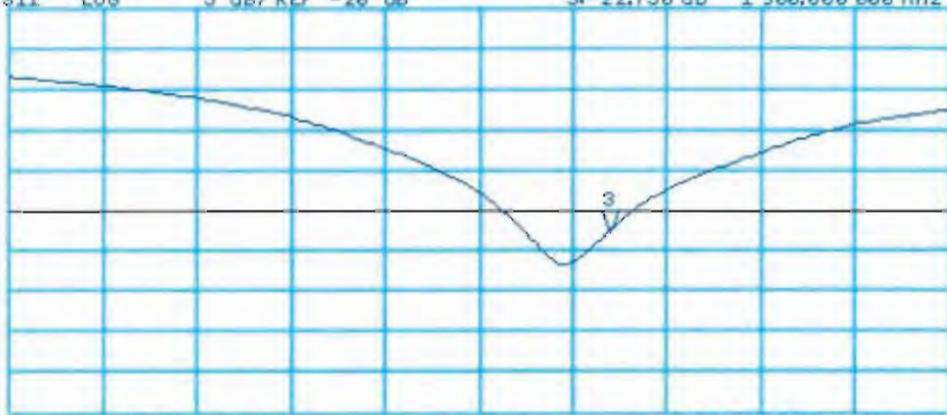

START 1 550.000 000 MHz

STOP 2 100.000 000 MHz