

FCC 47 CFR PART 15 SUBPART E

Product Type : Thin Client Terminal
Applicant : Dell Inc.
Address : One Dell Way, Round Rock, Texas USA 78682
Trade Name : Dell
Model Number : CSxyyyy(x and y= 0-9, A-Z, a-z or blank), CSx
Test Specification : FCC 47 CFR PART 15 SUBPART E: Oct., 2012
ANSI C63.10-2009
ANSI C63.4-2009
Application Purpose : Original
Receive Date : Jul. 09, 2013
Test Period : Jul. 23, 2013
Issue Date : Aug. 02, 2013

Issue by

A Test Lab Techno Corp.
No. 140-1, Changan Street, Bade City,
Taoyuan County 334, Taiwan R.O.C.
Tel : +86-3-2710188 / Fax : +86-3-2710190



Taiwan Accreditation Foundation accreditation number: 1330

Note: This report shall not be reproduced except in full, without the written approval of A Test Lab Techno Corp. This document may be altered or revised by A Test Lab Techno Corp. personnel only, and shall be noted in the revision section of the document. The client should not use it to claim product endorsement by TAF, or any government agencies. The test results in the report only apply to the tested sample.

Revision History

Rev.	Issue Date	Revisions	Revised By
00	Aug. 02, 2013	Initial Issue	

Verification of Compliance

Issued Date: 08/02/2013

Product Type : Thin Client Terminal
Applicant : Dell Inc.
Address : One Dell Way, Round Rock, Texas USA 78682
Trade Name : Dell
Model Number : CSxyyyy(x and y= 0-9, A-Z, a-z or blank), CSx
FCC ID : E2KCS1A13
EUT Rated Voltage : DC 5.0V, 0.5A
Test Voltage : 120 Vac / 60 Hz
Applicable Standard : FCC 47 CFR PART 15 SUBPART E: Oct., 2012
ANSI C63.10-2009
ANSI C63.4-2009
Test Result : Complied
Application Purpose : Original
Performing Lab. : A Test Lab Techno Corp.

No. 140-1, Changan Street, Bade City,
Taoyuan County 334, Taiwan R.O.C.
Tel : +86-3-2710188 / Fax : +86-3-2710190



Taiwan Accreditation Foundation accreditation number: 1330
<http://www.atl-lab.com.tw/e-index.htm>

A Test Lab Techno Corp. tested the above equipment in accordance with the requirements set forth in the above standards. All indications of Pass/Fail in this report are opinions expressed by A Test Lab Techno Corp. based on interpretations and/or observations of test results. Measurement Uncertainties were not taken into account and are published for informational purposes only. The test results show that the equipment tested is capable of demonstrating compliance with the requirements as documented in this report.

Approved By : 

Reviewed By

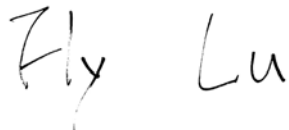
: 

(Manager)

(Murphy Wang)

(Testing Engineer)

(Fly Lu)

TABLE OF CONTENTS

1	EUT Description	5
2	Test Methodology	5
3	Dynamic Frequency Selection	6
	3.1. Limits	6
	3.2. Test and Measurement System	8
	3.3. Test Instruments	9
4	Test Methodology	10
	4.1. Mode of Operation.....	10
	4.2. EUT Exercise Software	10
	4.3. Configuration of Test System Details	11
	4.4. Test Site Environment	11
5	Results for 20 MHz Bandwidth	12
	5.1. Radar Waveforms and Traffic.....	12
	5.2. Channel Availability Check Time	20
	5.3. Overlapping Channel Tests	20
	5.4. Move and Closing Time	21
	5.5. Non-Occupancy Period	26
	5.6. Detection Bandwidth.....	27
	5.7. In-Service Monitoring	27
6	Results for 40 MHz Bandwidth	28
	6.1. Radar Waveforms and Traffic.....	28
	6.2. Channel Availability Check Time	36
	6.3. Overlapping Channel Tests	36
	6.4. Move and Closing Time	37
	6.5. Non-Occupancy Period	41
	6.6. Detection Bandwidth.....	42
	6.7. In-Service Monitoring	42

1 EUT Description

Product	Thin Client Terminal			
Trade Name	Dell			
Model No.	CSxyyyy(x and y= 0-9, A-Z, a-z or blank), CSx (Those model numbers differ from each other in selling regions.)			
Applicant	Dell Inc. One Dell Way, Round Rock, Texas USA 78682			
Manufacturer	Wyse Technology LLC 5455 Great America Parkway, Santa Clara, CA 95054			
FCC ID	E2KCS1A13			
Frequency Range	Band	Mode	Frequency Range (MHz)	Number of Channels
	UNII Band II	IEEE 802.11n (5GHz) 20 MHz	5260 - 5320	4 Channels
		IEEE 802.11n (5GHz) 40 MHz	5270 - 5310	2 Channels
	UNII Band III	IEEE 802.11n (5GHz) 20 MHz	5500 - 5700	11 Channels
IEEE 802.11n (5GHz) 40 MHz		5510 - 5670	5 Channels	
Type of Modulation	OFDM			
Equipment Type	Client (without DFS)			

2 Test Methodology

The tests documented in this report were performed in accordance with ANSI C63.10-2009, FCC CFR 47 Part 2, FCC CFR 47 Part 15, FCC 06-96, RSS-GEN Issue 3, and RSS-210 Issue 8.

3 Dynamic Frequency Selection

3.1. Limits

Industry Canada

IC RSS-210 is closely harmonized with FCC Part 15 DFS rules. The deviations are as follows:

RSS-210 Issue 8 A9.4 (b) (ii) Channel Availability Check Time:

Additional requirements for the band 5600-5650 MHz: Until further notice, devices subject to this Section shall not be capable of transmitting in the band 5600-5650 MHz, so that Environment Canada weather radars operating in this band are protected.

RSS-210 Issue 8 A9.4 (b) (iv) Channel closing time: the maximum channel closing time is 260 ms.

FCC

§ 15.407 (h) and FCC 06-96 APPENDIX "COMPLIANCE MEASUREMENT PROCEDURES FOR UNLICENSED-NATIONAL INFORMATION INFRASTRUCTURE DEVCIES OPERATING IN THE 5250-5350 MHz AND 5470-5725 MHz BANDS INCORPORATING DYNAMIC FREQUENCY SELECTION.

Table 1: Applicability of DFS Requirements Prior to Use of a Channel			
Requirement	Operational Mode		
	Master	Client (without DFS)	Client (with DFS)
Non-Occupancy Period	Yes	Not required	Yes
DFS Detection Threshold	Yes	Not required	Yes
Channel Availability Check Time	Yes	Not required	Not required
Uniform Spreading	Yes	Not required	Not required
U-NII Detection Bandwidth	Yes	Not required	Yes

Table 2: Applicability of DFS requirements during normal operation			
Requirement	Operational Mode		
	Master	Client (without DFS)	Client (with DFS)
DFS Detection Threshold	Yes	Not required	Yes
Channel Closing Transmission Time	Yes	Yes	Yes
Channel Move Time	Yes	Yes	Yes
U-NII Detection Bandwidth	Yes	Not required	Yes

Table 3: DFS Detection Thresholds for Master or Client Devices Incorporating DFS	
Maximum Transmit Power	Value (See Notes 1 and 2)
≥ 200 milliwatt	-64 dBm
< 200 milliwatt	-62 dBm
Note 1: This is the level at the input of the receiver assuming a 0 dBi receive antenna. Note 2: Throughout these test procedures an additional 1 dB has been added to the amplitude of the test transmission waveforms to account for variations in measurement equipment. This will ensure that the test signal is at or above the detection threshold level to trigger a DFS response.	

Table 4: DFS Response Requirement Values	
Parameter	Value
Non-occupancy period	Minimum 30 minutes
Channel Availability Check Time	60 seconds
Channel Move Time	10 seconds (See Note 1)
Channel Closing Transmission Time	200 milliseconds + an aggregate of 60 milliseconds over remaining 10 second period. (See Notes 1 and 2.)
U-NII Detection Bandwidth	Minimum 80% of the U-NII 99% transmission power bandwidth. (See Note 3)
<p>Note 1: The instant that the Channel Move Time and the Channel Closing Transmission Time begins is as follows:</p> <ul style="list-style-type: none"> ■ For the Short Pulse Radar Test Signals this instant is the end of the Burst. ■ For the Frequency Hopping radar Test Signal, this instant is the end of the last radar Burst generated. ■ For the Long Pulse Radar Test Signal this instant is the end of the 12 second period defining the Radar Waveform. <p>Note 2: The Channel Closing Transmission Time is comprised of 200 milliseconds starting at the beginning of the Channel Move Time plus any additional intermittent control signals required to facilitate a Channel move (an aggregate of 60 milliseconds) during the remainder of the 10 second period. The aggregate duration of control signals will not count quiet periods in between transmissions.</p> <p>Note 3: During the U-NII Detection Bandwidth detection test, radar type 1 is used and for each frequency step the minimum percentage of detection is 90 percent. Measurements are performed with no data traffic.</p>	

Table 5 –Short Pulse Radar Test Waveforms					
Radar Type	Pulse Width (µsec)	PRI (µsec)	Number of Pulses	Minimum Percentage of Successful Detection	Minimum Number of Trials
1	1	1428	18	60%	30
2	1-5	150-230	23-29	60%	30
3	6-10	200-500	16-18	60%	30
4	11-20	200-500	12-16	60%	30
Aggregate (Radar Types 1-4)				80%	120

Table 6 –Long Pulse Radar Test Waveform							
Radar Waveform	Pulse Width (µsec)	Chirp Width (MHz)	PRI (µsec)	Number of Pulses per Burst	Number of Bursts	Minimum Percentage of Successful Detection	Minimum Number of Trials
5	50-100	5-20	1000 - 2000	1-3	8-20	80%	30

Table 7 – Frequency Hopping Radar Test Signal							
Radar Waveform	Pulse Width (µsec)	PRI (µsec)	Pulses per Hop	Hopping Rate (kHz)	Hopping Sequence Length (msec)	Minimum Percentage of Successful Detection	Minimum Number of Trials
6	1	333	9	0.333	300	70%	30

3.2. Test and Measurement System

3.2.1. Setup for Master with injection at the Master

Example Conducted Setup where UUT is a Master and Radar Test Waveforms are injected into the Master

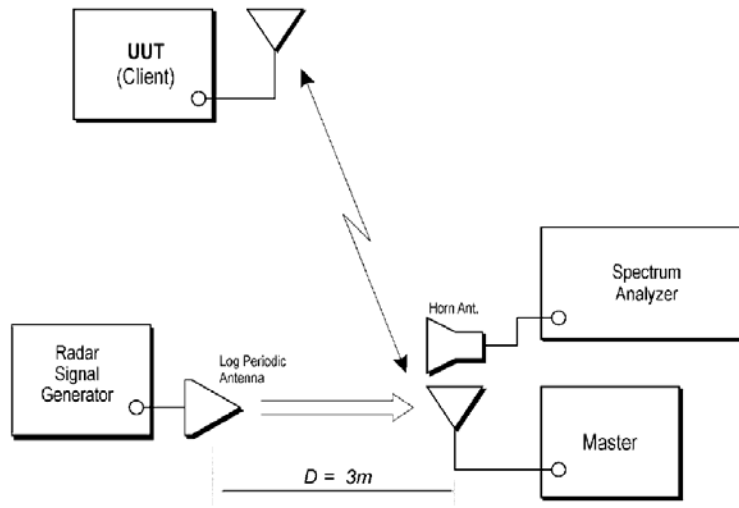

3.2.2. System Calibration

The short pulse and long pulse signal generating system utilizes the NTIA software. The Vector Signal Generator has been validated by the NTIA. The hopping signal generating system utilizes the A Test Lab Techno Corp. simulated hopping method and system, which has been validated by the DoD, FCC and NTIA. The software selects waveform parameters from within the bounds of the signal type on a random basis using uniform distribution.

The short pulse types 2, 3 and 4, and the long pulse type 5 parameters are randomized at run-time. The hopping type 6 pulse parameters are fixed while the hopping sequence is based on the August 2005 NTIA Hopping Frequency List. The initial starting point randomized at run-time and each subsequent starting point is incremented by 475. Each frequency in the 100-length segment is compared to the boundaries of the EUT Detection Bandwidth and the software creates a hopping burst pattern in accordance with Section 7.4.1.3 Method #2 Simulated Frequency Hopping Radar Waveform Generating Subsystem of FCC 06-96 APPENDIX. The frequency of the signal generator is incremented in 1 MHz steps from FL to FH for each successive trial. This incremental sequence is repeated as required to generate a minimum of 30 total trials and to maintain a uniform frequency distribution over the entire Detection Bandwidth.

The signal monitoring equipment consists of a spectrum analyzer. The aggregate ON time is calculated by multiplying the number of bins above a threshold during a particular observation period by the dwell time per bin, with the analyzer set to peak detection and max hold.

3.2.3. System Calibration

A 50-ohm load is connected in place of the spectrum analyzer, and the spectrum analyzer is connected to a horn antenna via a coaxial cable, with the reference level offset set to (horn antenna gain – coaxial cable loss). The signal generator is set to CW mode. The amplitude of the signal generator is adjusted to yield a level of -64 dBm as measured on the spectrum analyzer.

Without changing any of the instrument settings, the spectrum analyzer is reconnected to the Common port of the Spectrum Analyzer Combiner/Divider. The Reference Level Offset of the spectrum analyzer is adjusted so that the displayed amplitude of the signal is -64 dBm.

The spectrum analyzer displays the level of the signal generator as received at the antenna ports of the Master Device. The interference detection threshold may be varied from the calibrated value of -64 dBm and the spectrum analyzer will still indicate the level as received by the Master Device.

3.2.4. Adjustment of Displayed Traffic Level

A link is established between the Master and Slave and the distance between the units is adjusted as needed to provide a suitable received level at the Master and Slave devices. The video test file is streamed to generate WLAN traffic. The monitoring antenna is adjusted so that the WLAN traffic level, as displayed on the spectrum analyzer, is at lower amplitude than the radar detection threshold.

3.3. Test Instruments

Equipment	Manufacturer	Model Number	Serial Number	Cal. Date	Remark
Spectrum Analyzer	Agilent	E4408B	MY45107753	07/11/2013	(1)
Signal Generator	R&S	SMU200A	102598	01/30/2013	(1)
Test Site	ATL	TE02	TE02	N.C.R.	-----

Remark: ⁽¹⁾ Calibration period 1 year. ⁽²⁾ Calibration period 2 years.

Note: N.C.R. = No Calibration Request.

4 Test Methodology

4.1. Mode of Operation

Decision of Test ATL has verified the construction and function in typical operation. All the test modes were carried out with the EUT in normal operation, which was shown in this test report and defined as:

Test Mode
Mode 1: IEEE 802.11n 20MHz U-NII Band II Link Mode
Mode 2: IEEE 802.11n 20MHz U-NII Band III Link Mode
Mode 3: IEEE 802.11n 40MHz U-NII Band II Link Mode
Mode 4: IEEE 802.11n 40MHz U-NII Band III Link Mode

Software used to control the EUT for staying in continuous transmitting mode was programmed.

After verification, all tests were carried out with the worst case test modes as shown below except radiated spurious emission below 1GHz and power line conducted emissions below 30MHz, which worst case was in normal link mode only.

IEEE 802.11n 20MHz U-NII Band II mode:

Unless otherwise noted, all tests were performed with the radar burst at the channel center frequency of 5300 MHz.

IEEE 802.11n 20MHz U-NII Band III mode:

Unless otherwise noted, all tests were performed with the radar burst at the channel center frequency of 5500 MHz.

IEEE 802.11n 40MHz U-NII Band II mode:

Unless otherwise noted, all tests were performed with the radar burst at the channel center frequency of 5310 MHz.

IEEE 802.11n 40MHz U-NII Band III mode:

Unless otherwise noted, all tests were performed with the radar burst at the channel center frequency of 5510 MHz.

4.2. EUT Exercise Software

1.	Setup the EUT shown on 3.3.
2.	Turn on the power of all equipment.
3.	Turn on Wi-Fi function link to Notebook.
4.	EUT run test program.

4.3. Configuration of Test System Details

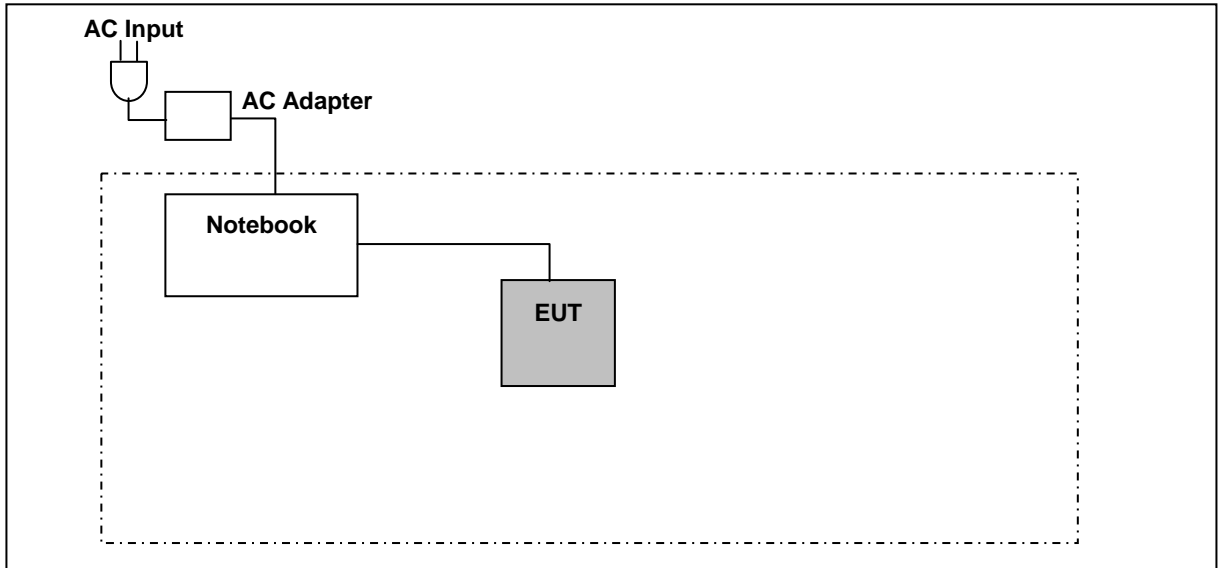

4.4. Test Site Environment

Items	Required (IEC 68-1)	Actual
Temperature (°C)	15-35	26
Humidity (%RH)	25-75	60
Barometric pressure (mbar)	860-1060	950

5 Results for 20 MHz Bandwidth

5.1. Radar Waveforms and Traffic

5.1.1. Results

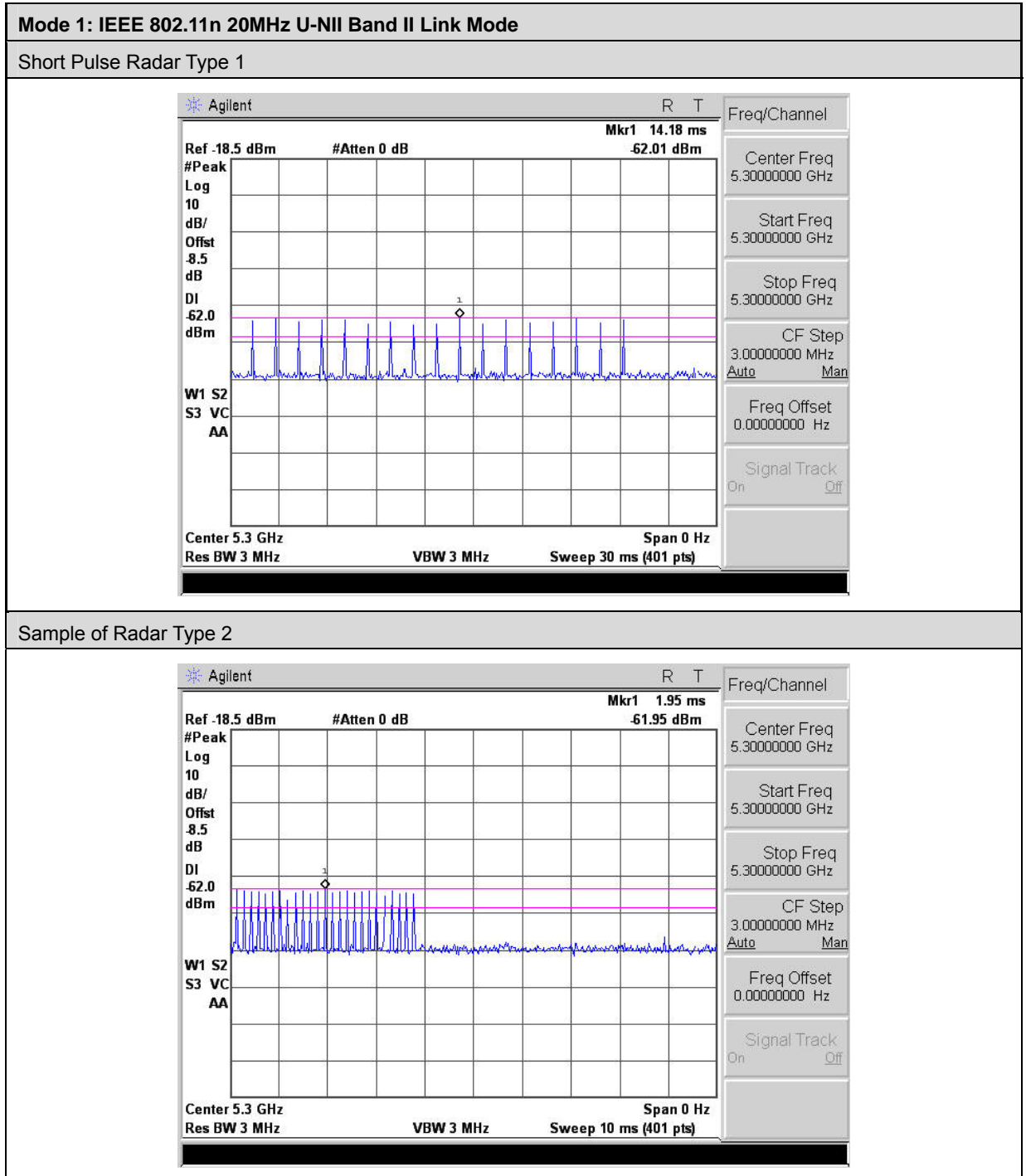

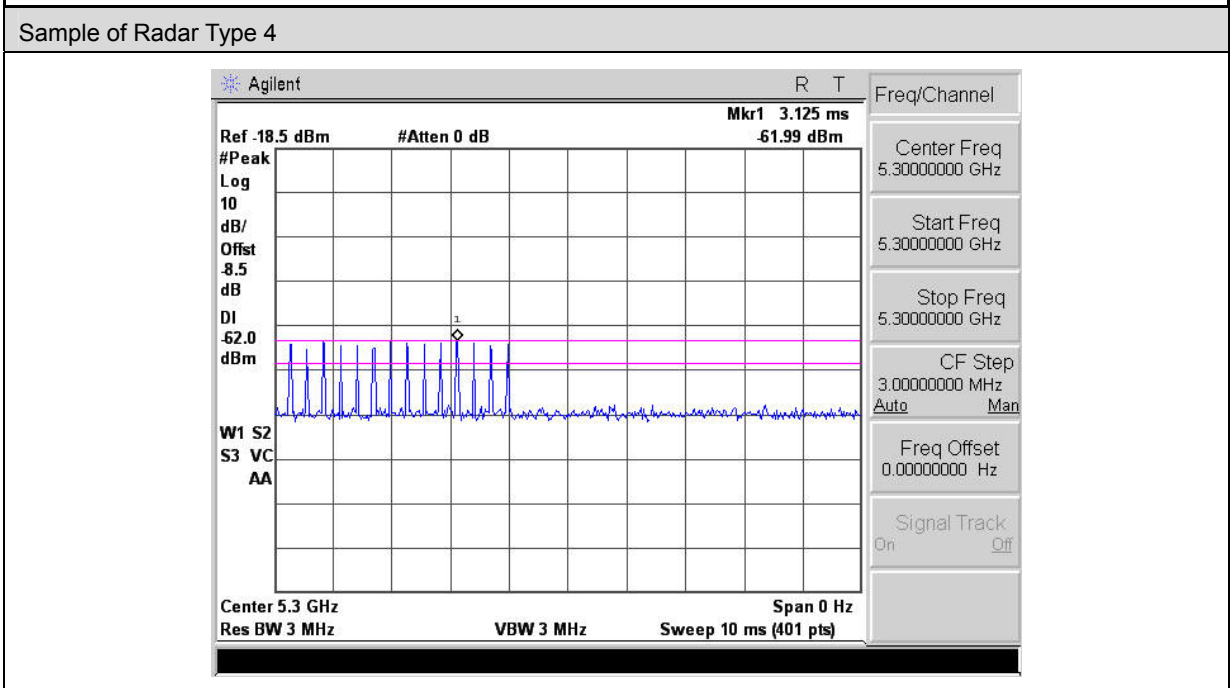
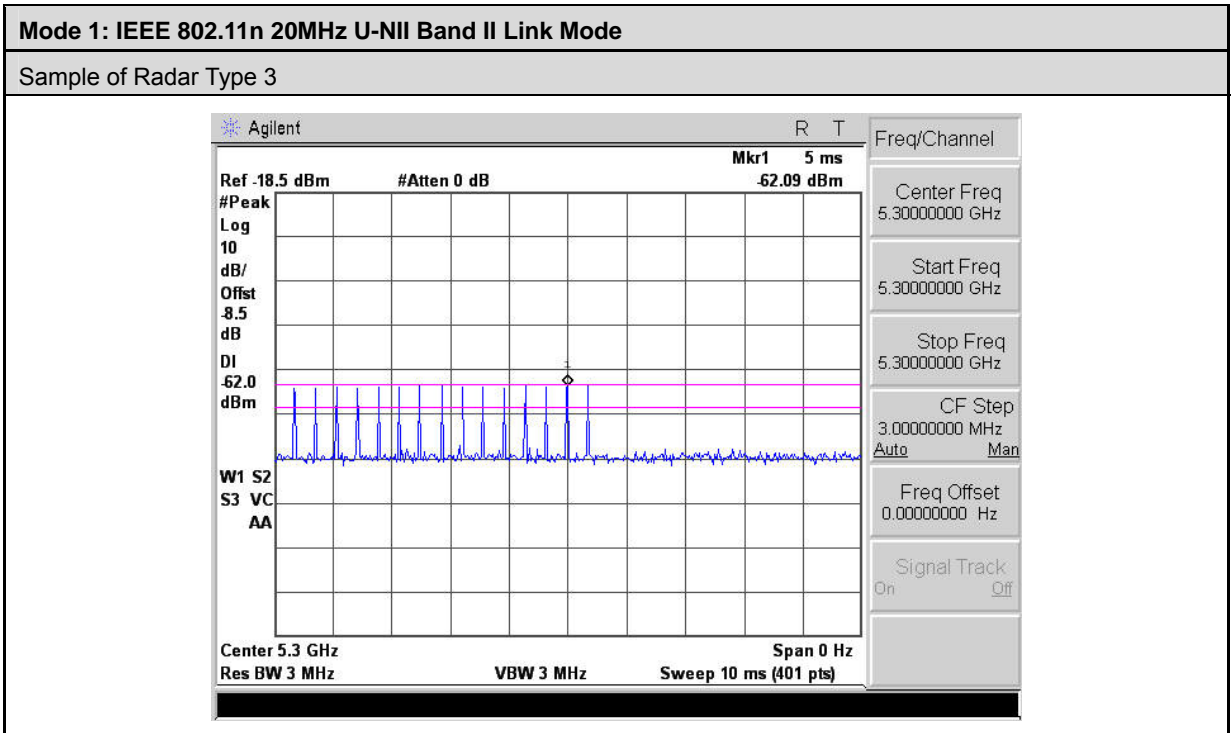

Mode 1: IEEE 802.11n 20MHz U-NII Band II Link Mode

Sample Of Single Burst of Radar Type 5

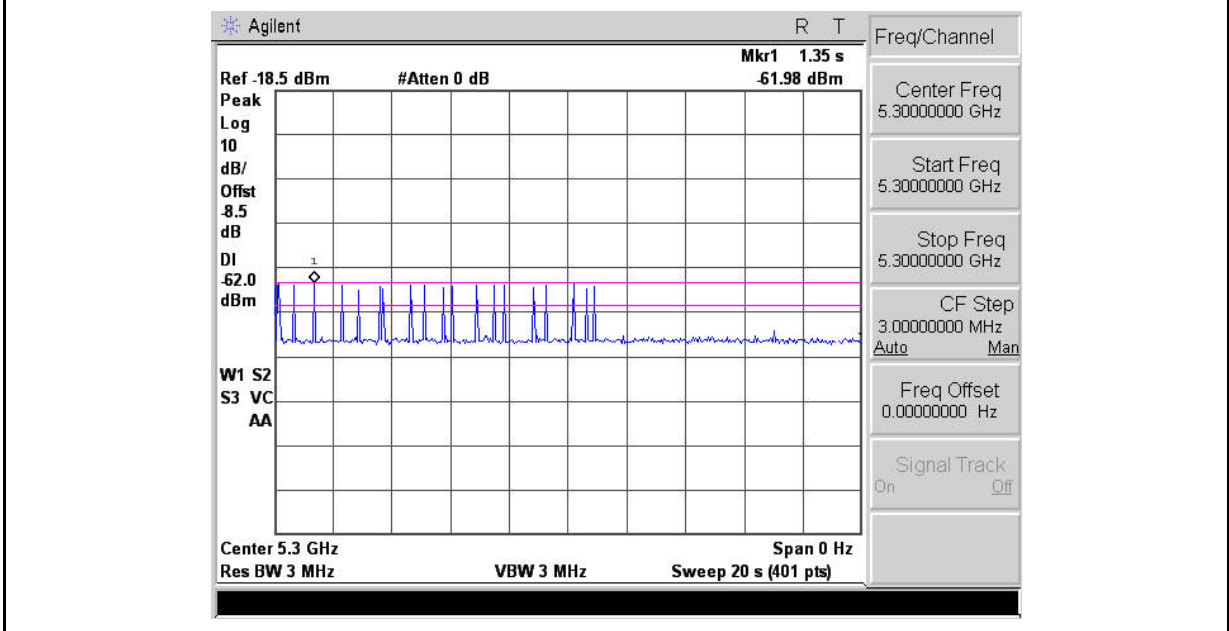

Single Burst of Radar Type 6

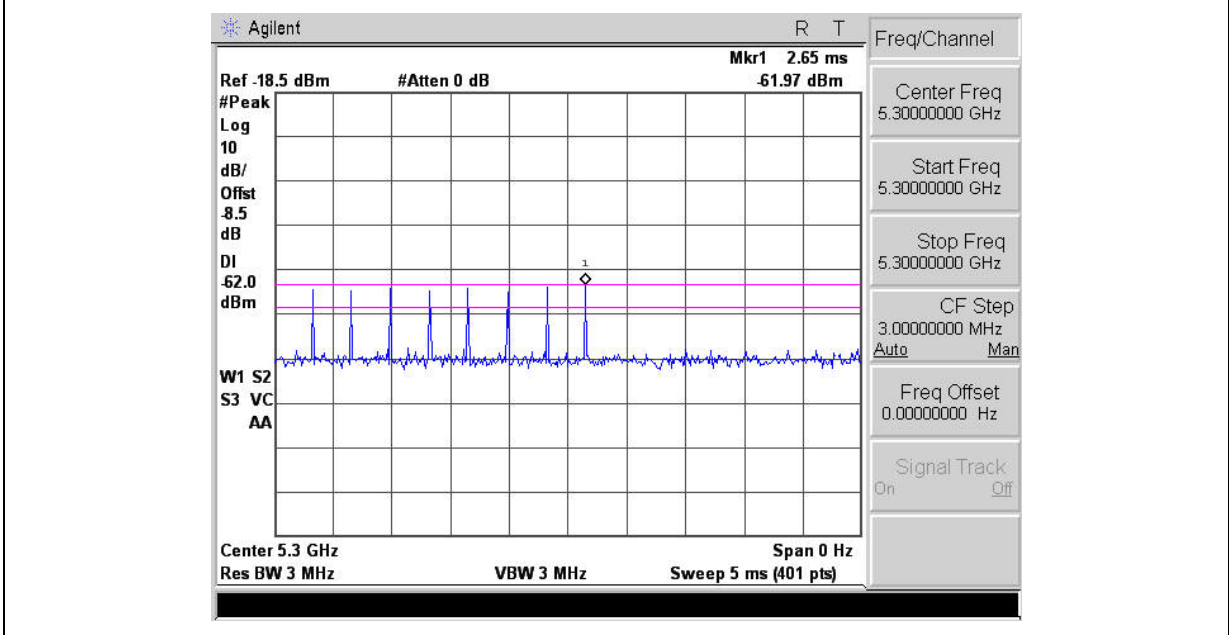

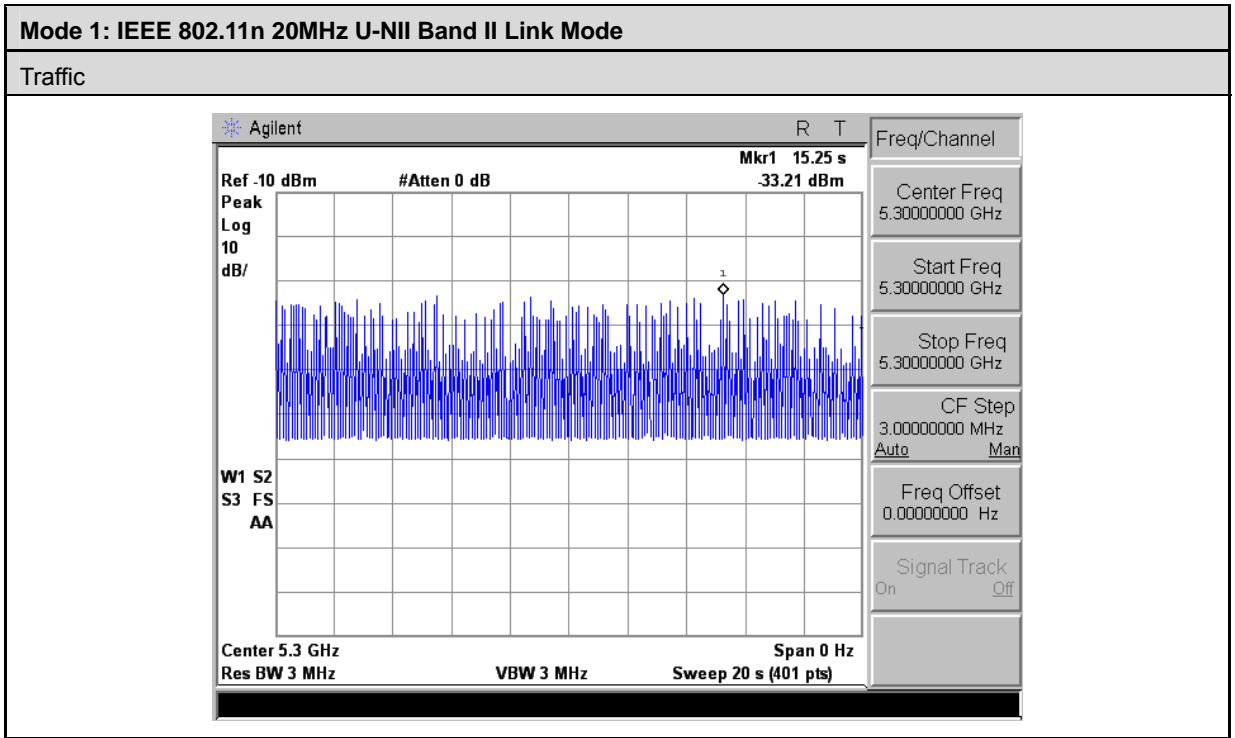

Mode 2: IEEE 802.11n 20MHz U-NII Band III Link Mode
Short Pulse Radar Type 1

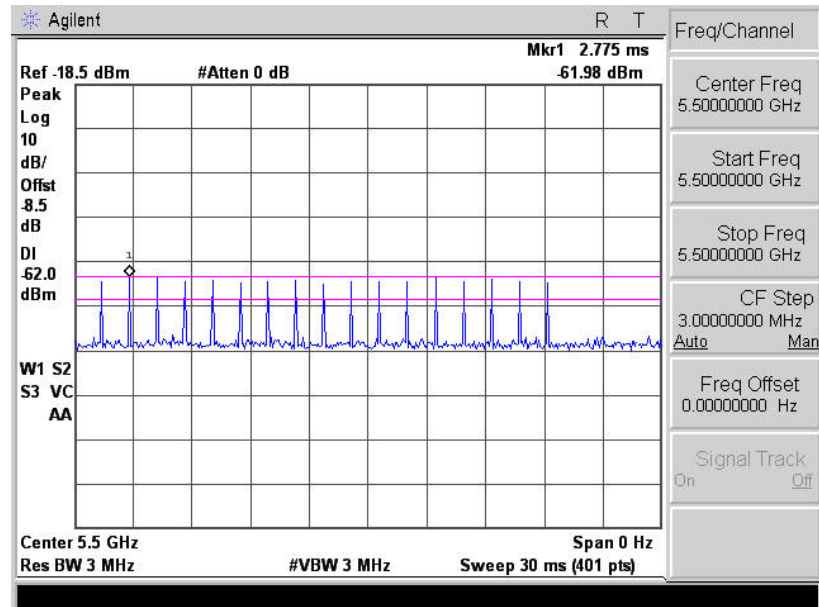

Sample of Radar Type 2

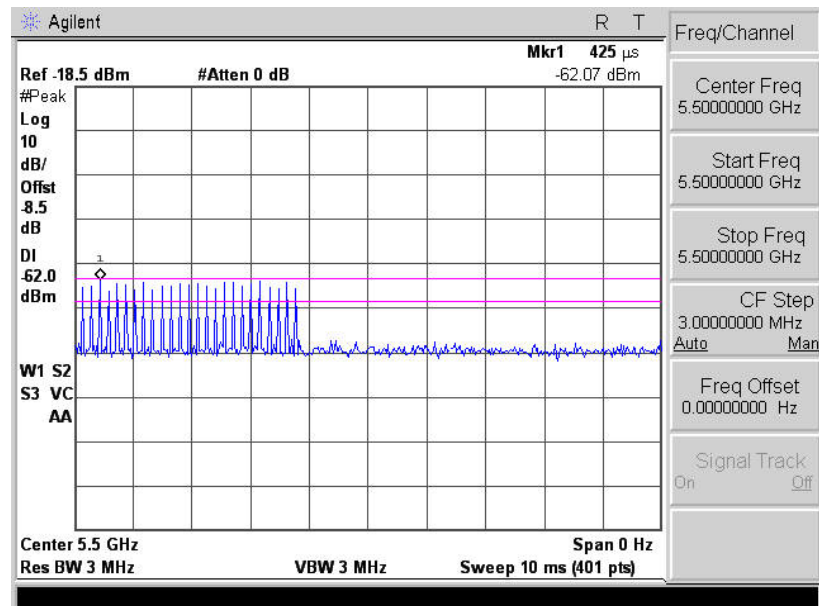

Mode 2: IEEE 802.11n 20MHz U-NII Band III Link Mode

Sample of Radar Type 3

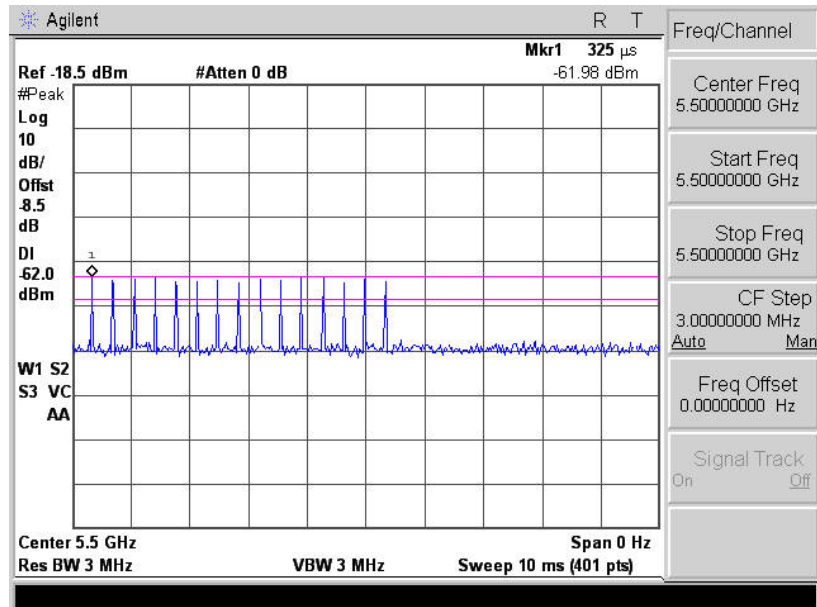

Sample of Radar Type 4

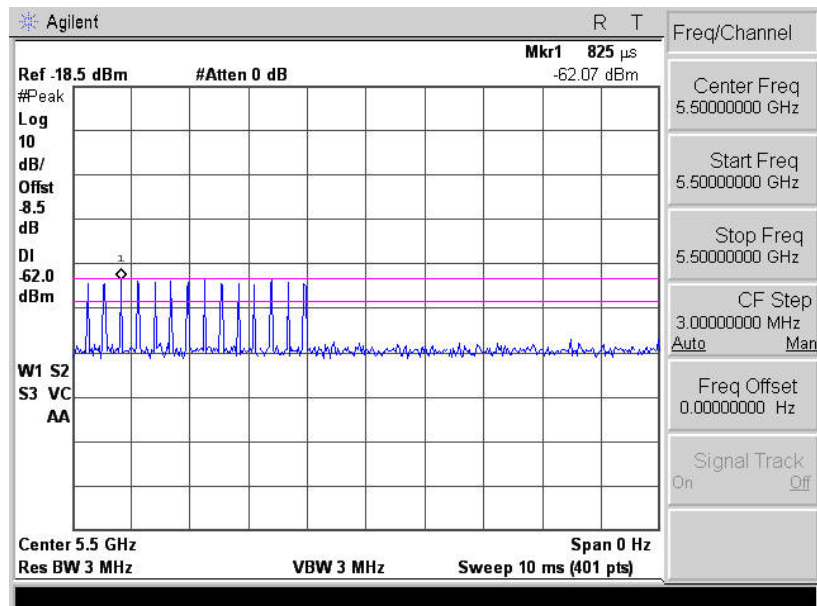

Mode 2: IEEE 802.11n 20MHz U-NII Band III Link Mode

Sample Of Single Burst of Radar Type 5

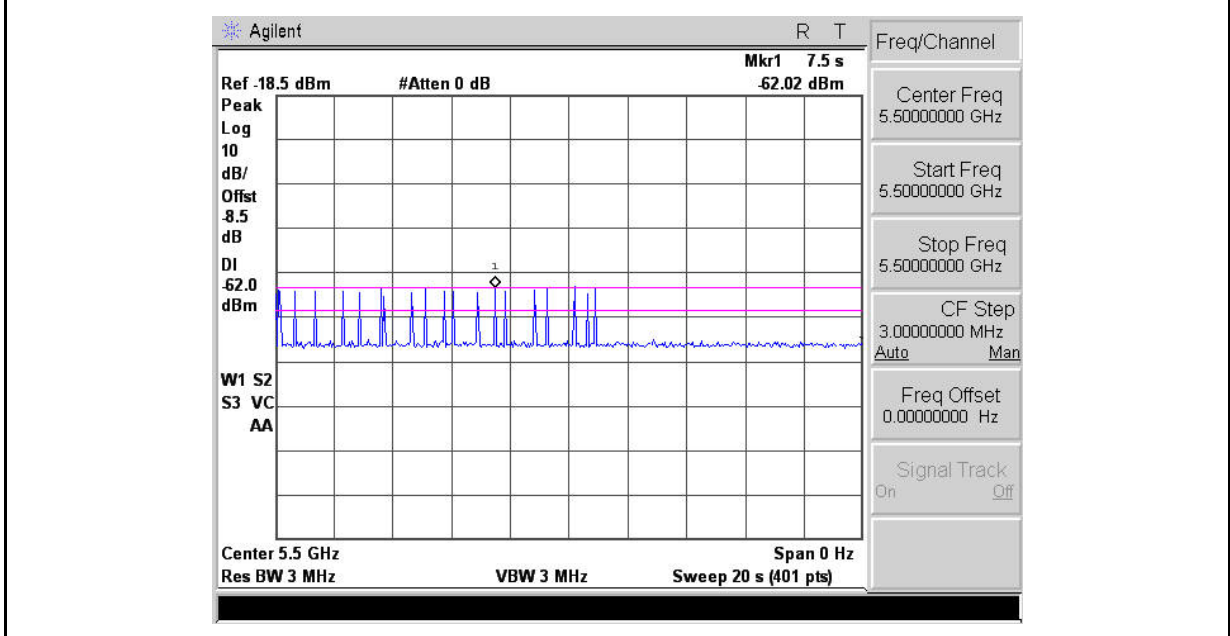

Single Burst of Radar Type 6

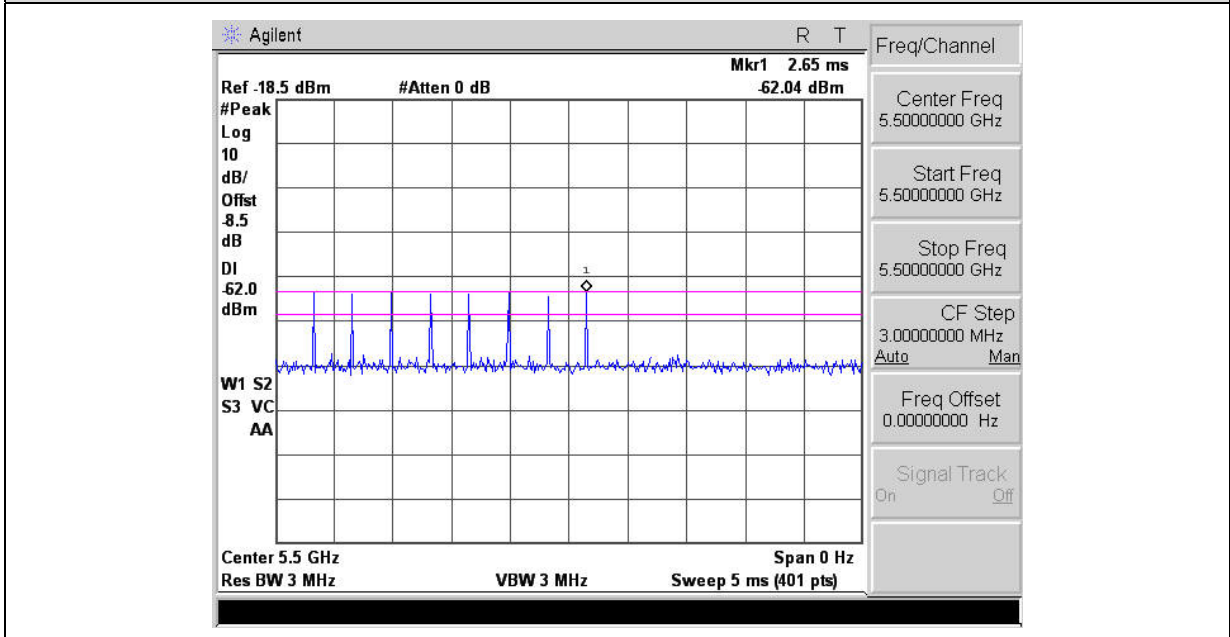

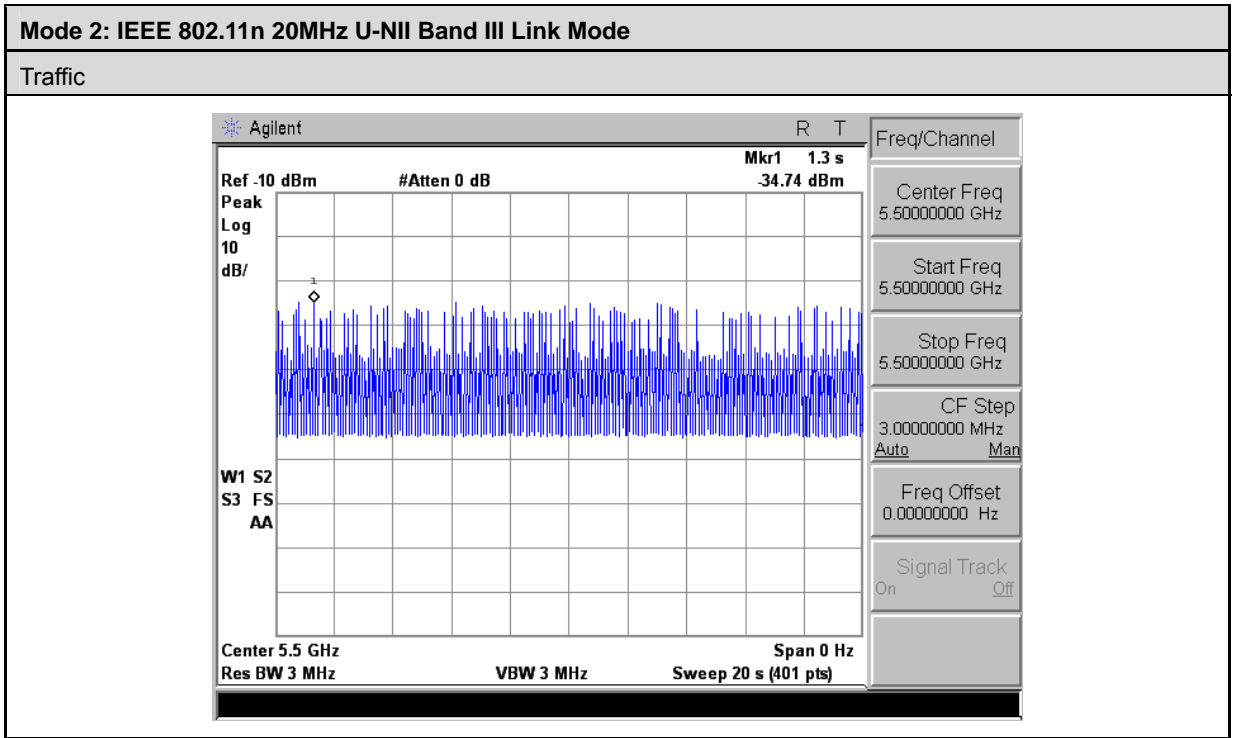

5.2. Channel Availability Check Time

5.2.1. Procedure to Determine Initial Power-Up Cycle Time

A link was established on channel then the EUT was rebooted. The time from the cessation of traffic to the re-initialization of traffic was measured as the time required for the EUT to complete the total power-up cycle. The time to complete the initial power-up period is 60 seconds less than this total power-up time.

5.2.2. Procedure for Timing Of Radar Burst

With a link established on channel, the EUT was rebooted. A radar signal was triggered within 0 to 6 seconds after the initial power-up period, and transmissions on the channel were monitored on the spectrum analyzer.

The Non-Occupancy list was cleared. With a link established on channel, the EUT was rebooted. A radar signal was triggered within 54 to 60 seconds after the initial power-up period, and transmissions on the channel were monitored on the spectrum analyzer.

5.2.3. Quantitative Results

These tests are not applicable.

5.3. Overlapping Channel Tests

These tests are not applicable.

5.4. Move and Closing Time

5.4.1. Reporting Notes

The reference marker is set at the end of last radar pulse.

The delta marker is set at the end of the last WLAN transmission following the radar pulse.

This delta is the channel move time.

The aggregate channel closing transmission time is calculated as follows:

Aggregate Transmission Time = (Number of analyzer bins showing transmission) * (dwell time per bin)

The observation period over which the FCC aggregate time is calculated begins at (Reference Marker + 200 msec) and ends no earlier than (Reference Marker + 10 sec).

5.4.2. Results

Mode 1: IEEE 802.11n 20MHz U-NII Band II

Agency	Channel Move Time (sec)	Limit (sec)
FCC	1.050	10

Agency	Aggregate Channel Closing Transmission Time (msec)	Limit (msec)
FCC	60	200

Mode 2: IEEE 802.11n 20MHz U-NII Band III

Agency	Channel Move Time (sec)	Limit (sec)
FCC	1.000	10

Agency	Aggregate Channel Closing Transmission Time (msec)	Limit (msec)
FCC	60	200

Mode 1: IEEE 802.11n 20MHz U-NII Band II Link Mode

Move Time

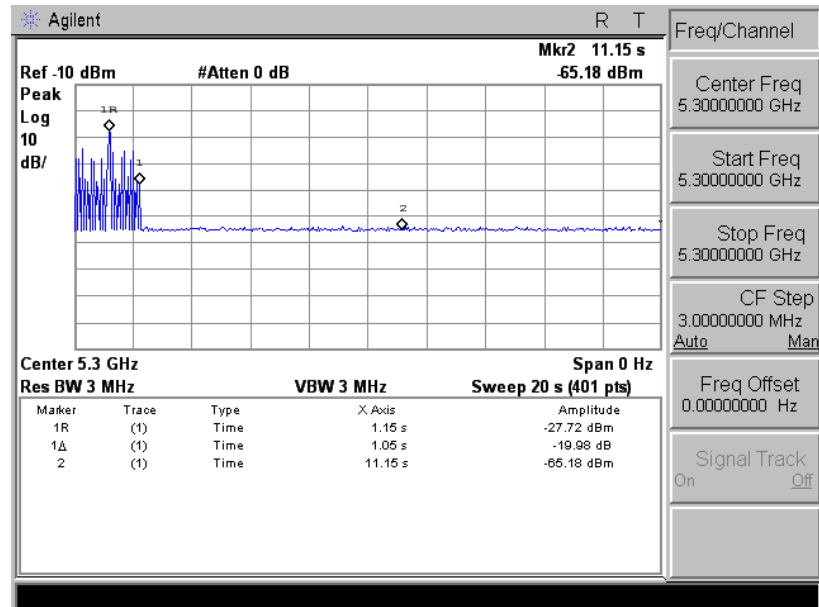

Channel Closing Time

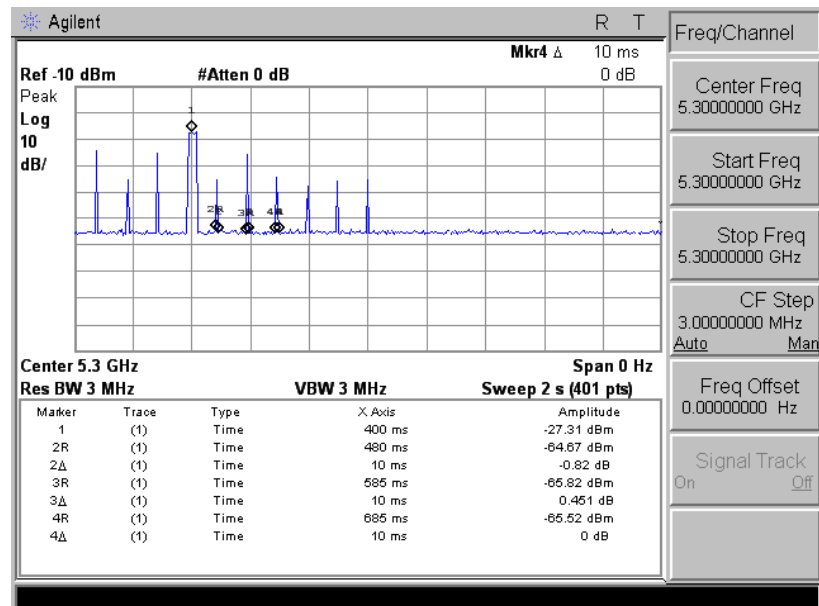

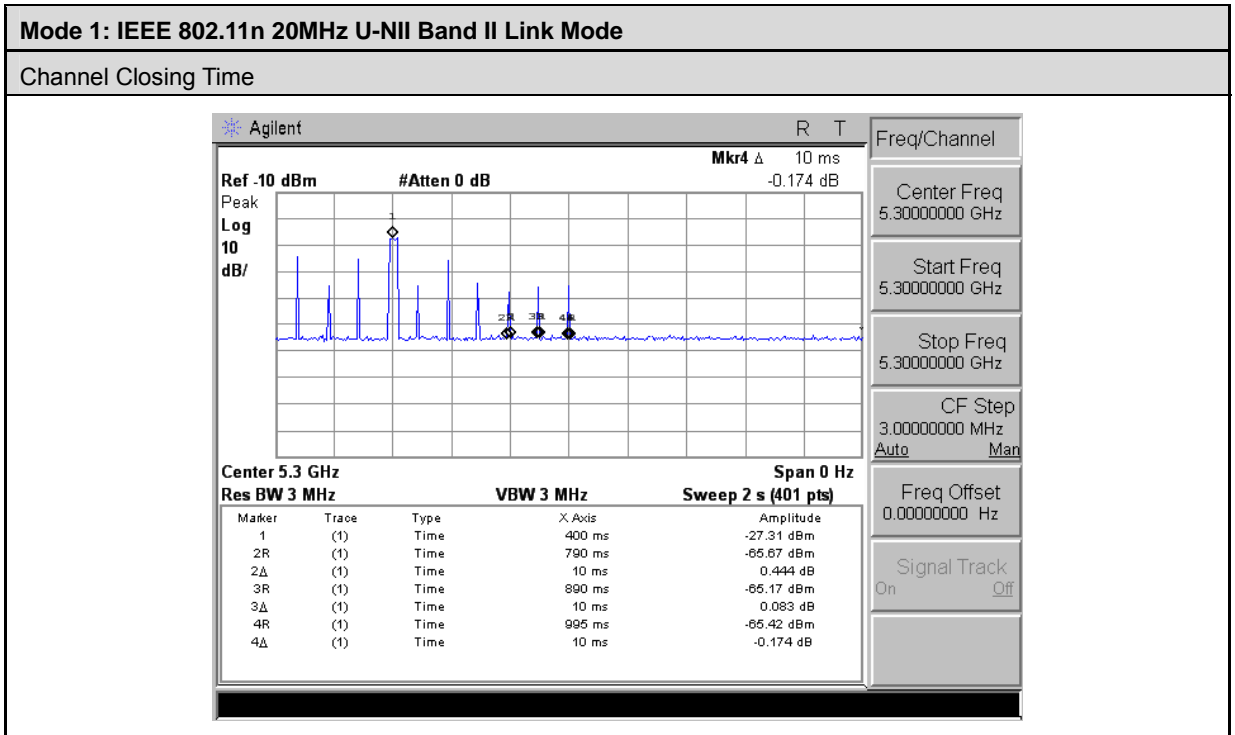

Mode 2: IEEE 802.11n 20MHz U-NII Band III Link Mode

Move Time

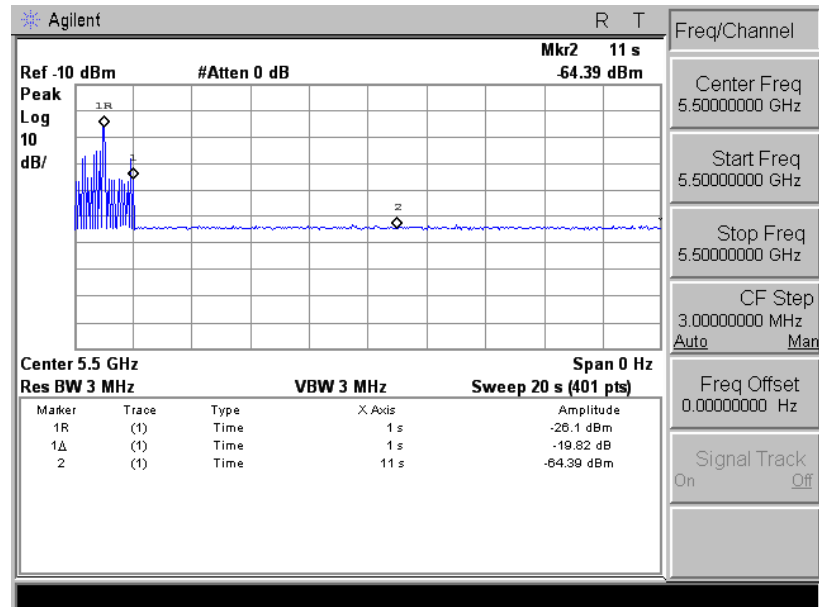

Channel Closing Time

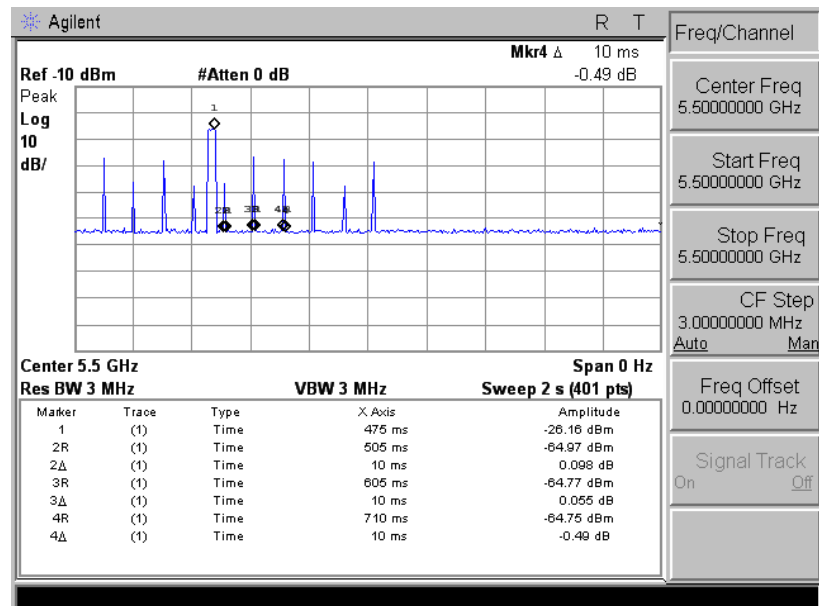

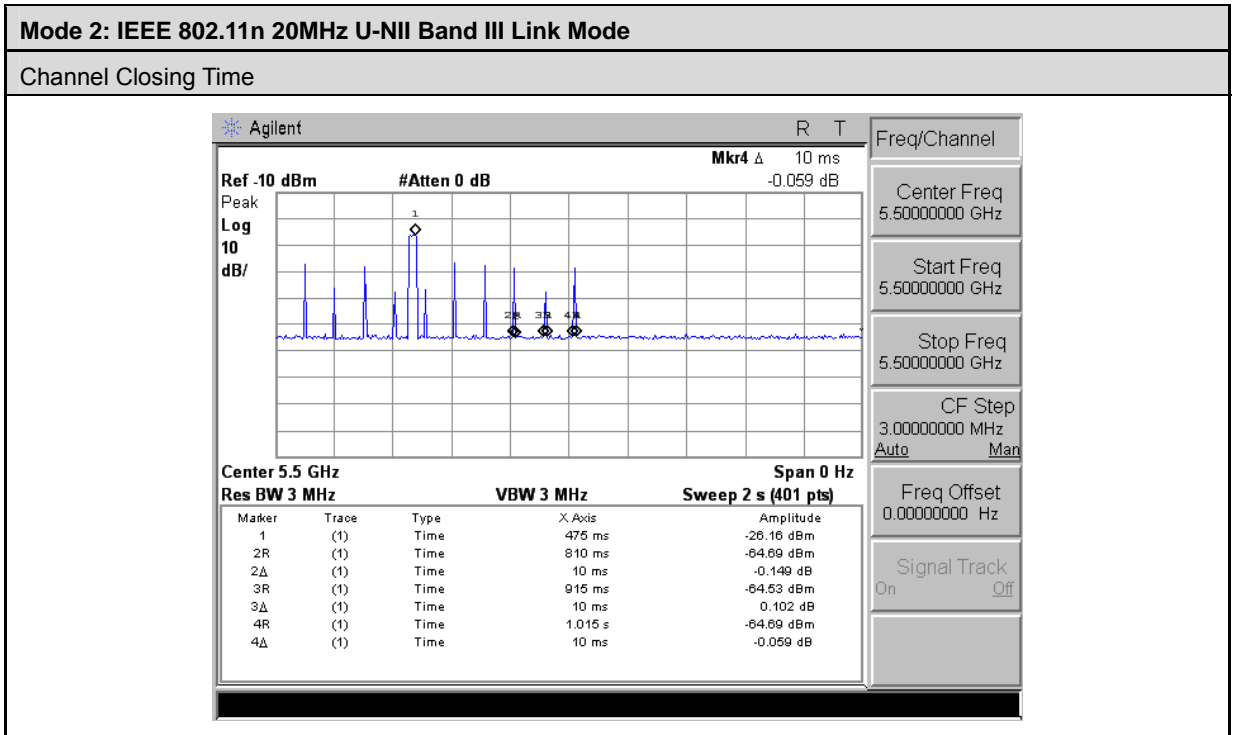

5.5. Non-Occupancy Period

5.5.1. Results

No EUT transmissions were observed on the test channel during the 30-minute observation time.

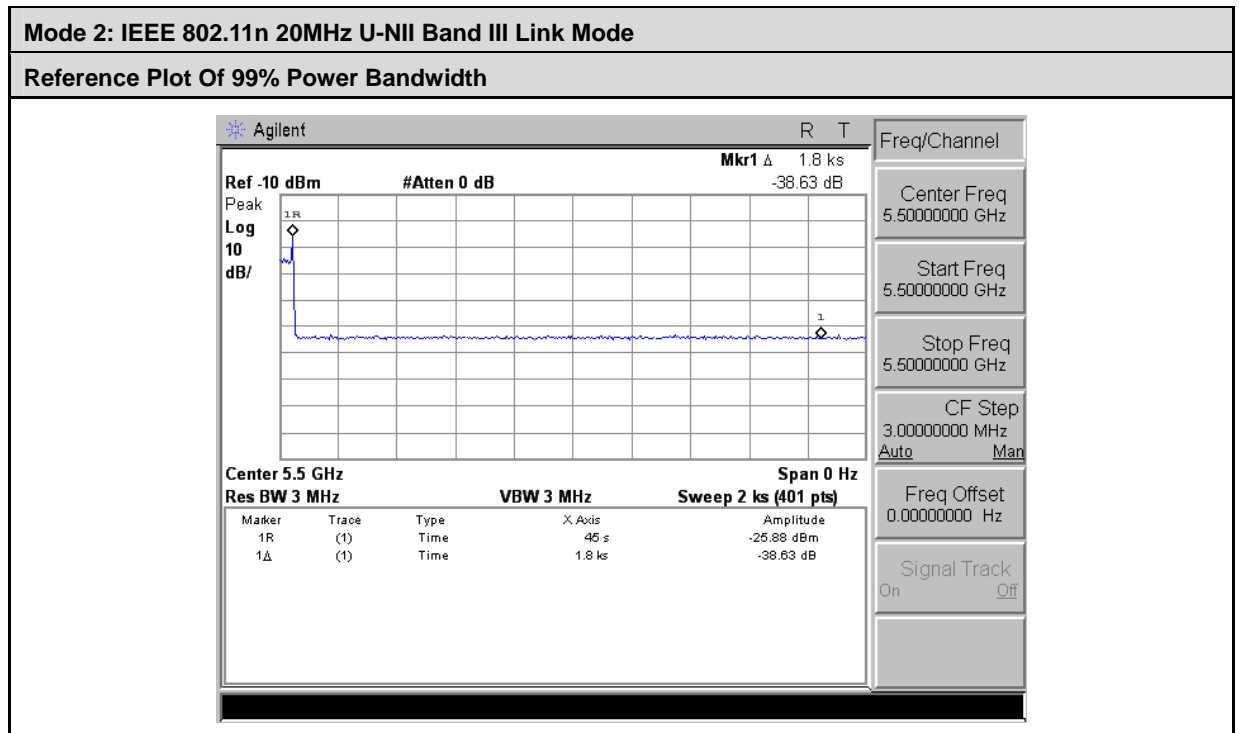
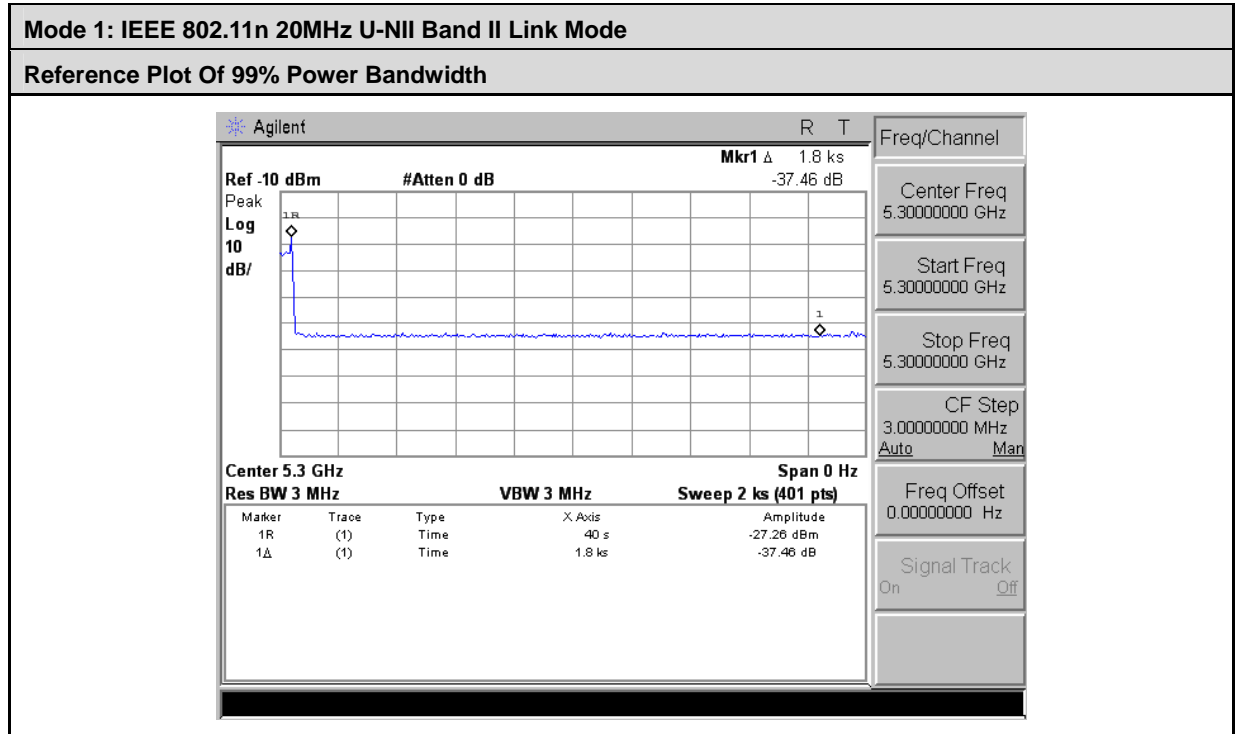

5.6. Detection Bandwidth

These tests are not applicable.

5.7. In-Service Monitoring

These tests are not applicable.

6 Results for 40 MHz Bandwidth

6.1. Radar Waveforms and Traffic

6.1.1. Results

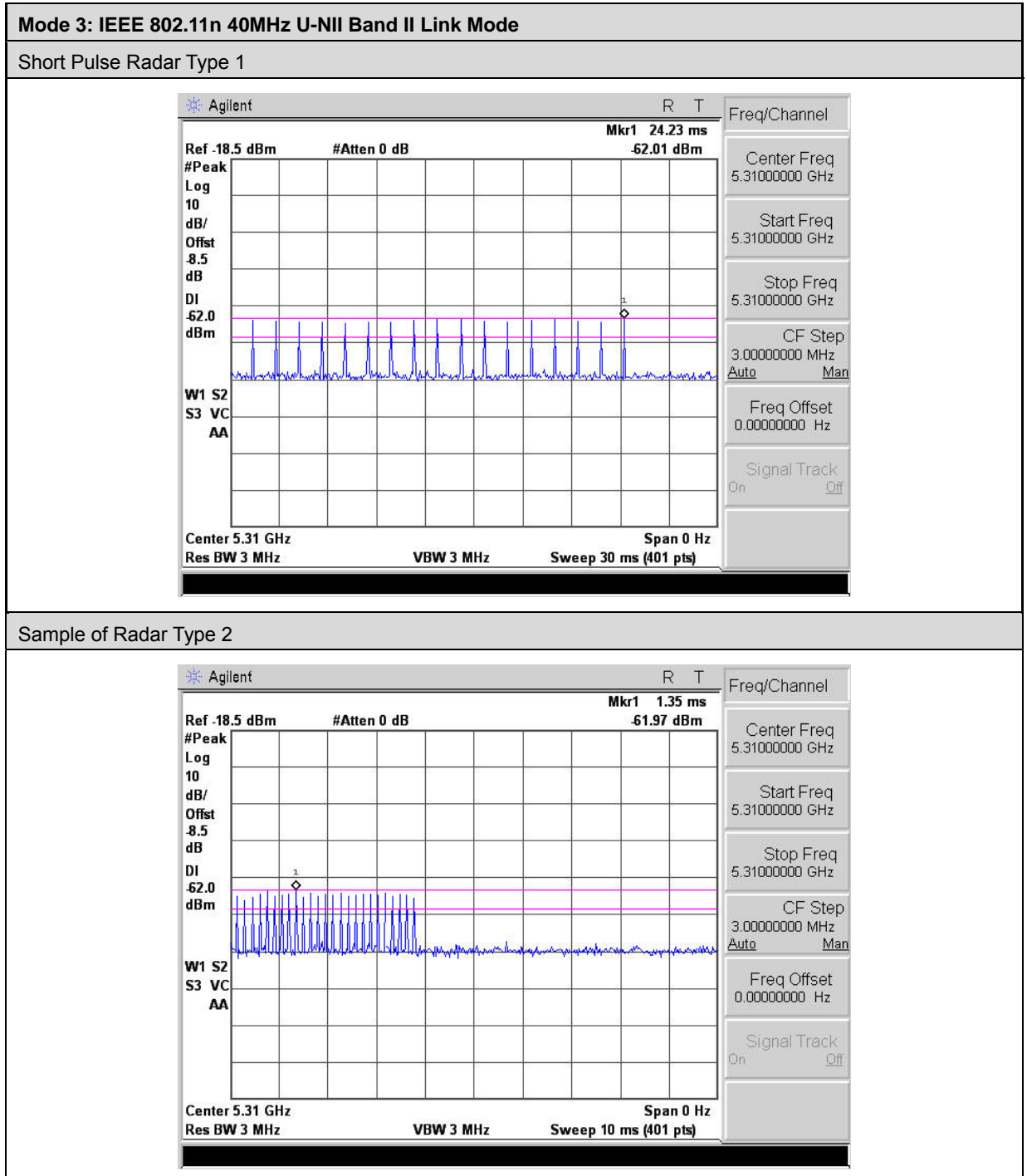

Mode 3: IEEE 802.11n 40MHz U-NII Band II Link Mode

Sample of Radar Type 3

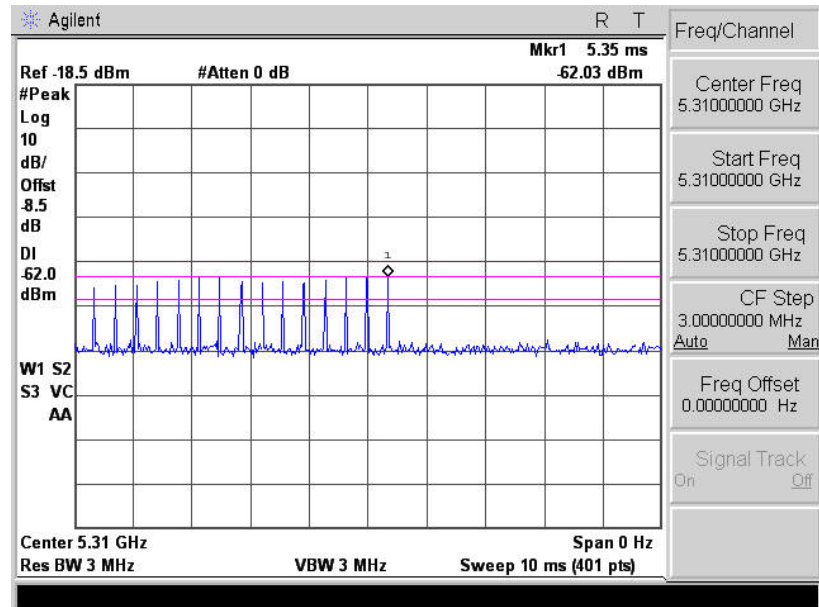

Sample of Radar Type 4

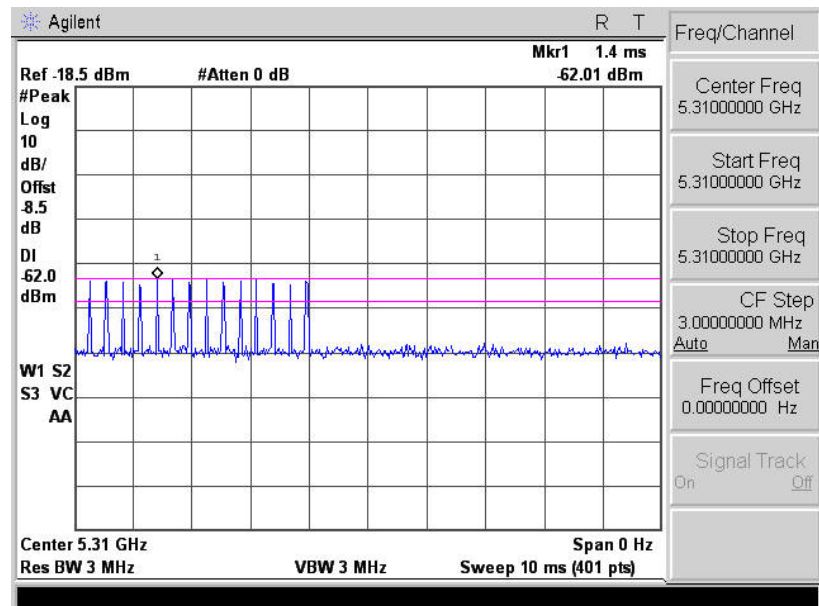

Mode 3: IEEE 802.11n 40MHz U-NII Band II Link Mode

Sample Of Single Burst of Radar Type 5

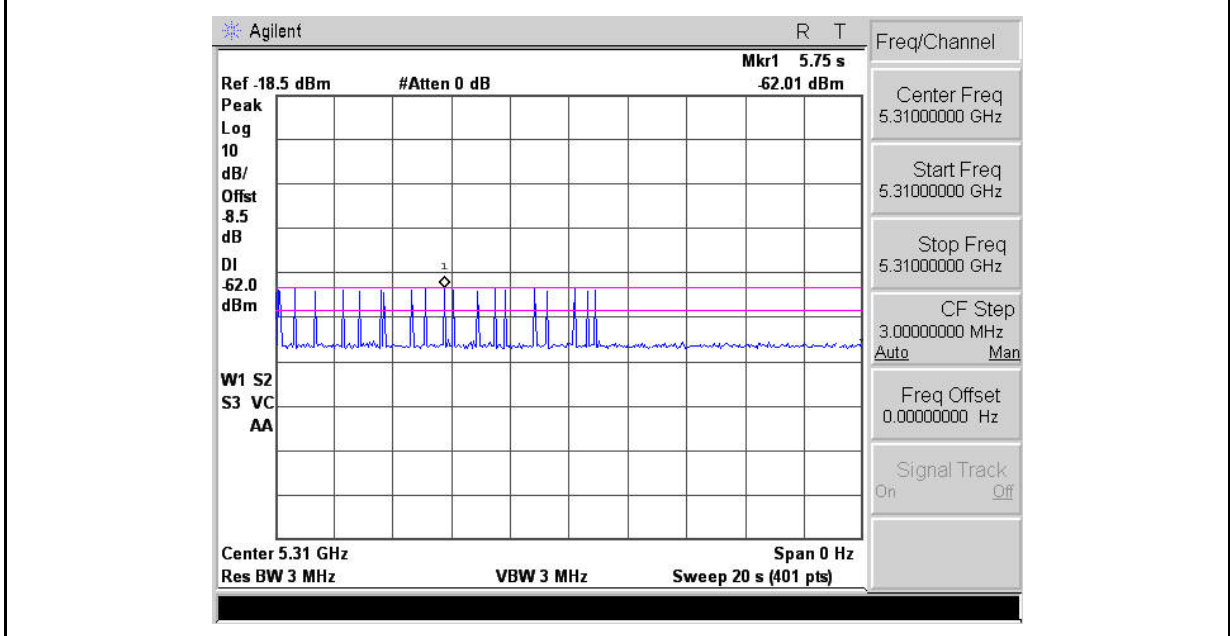

Single Burst of Radar Type 6

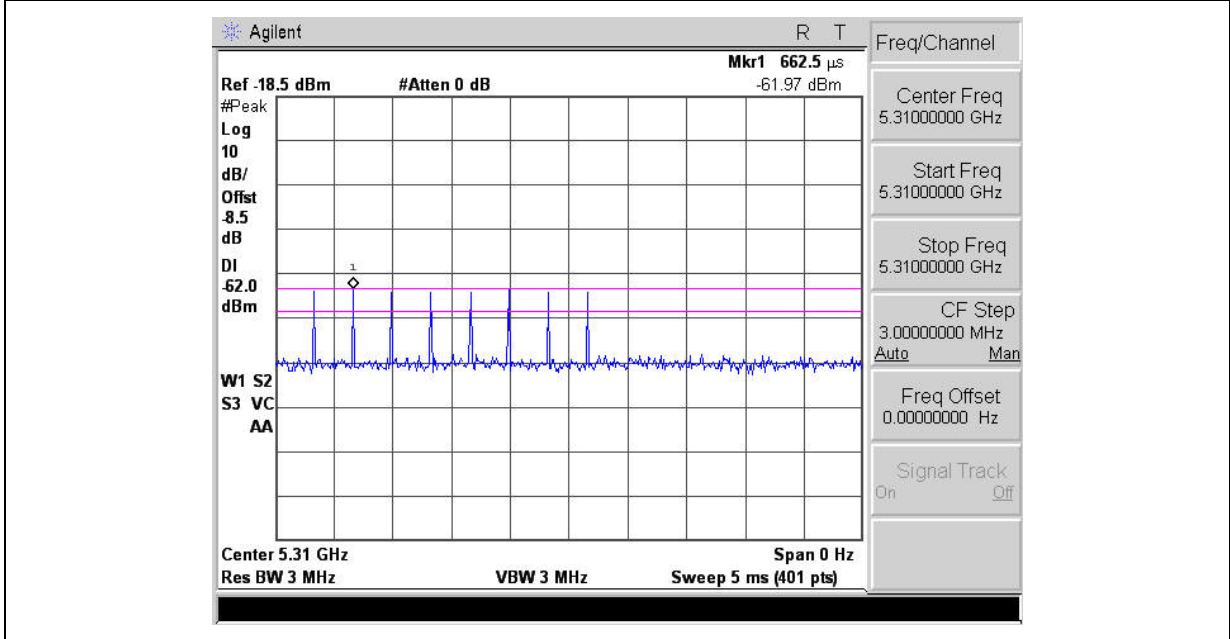

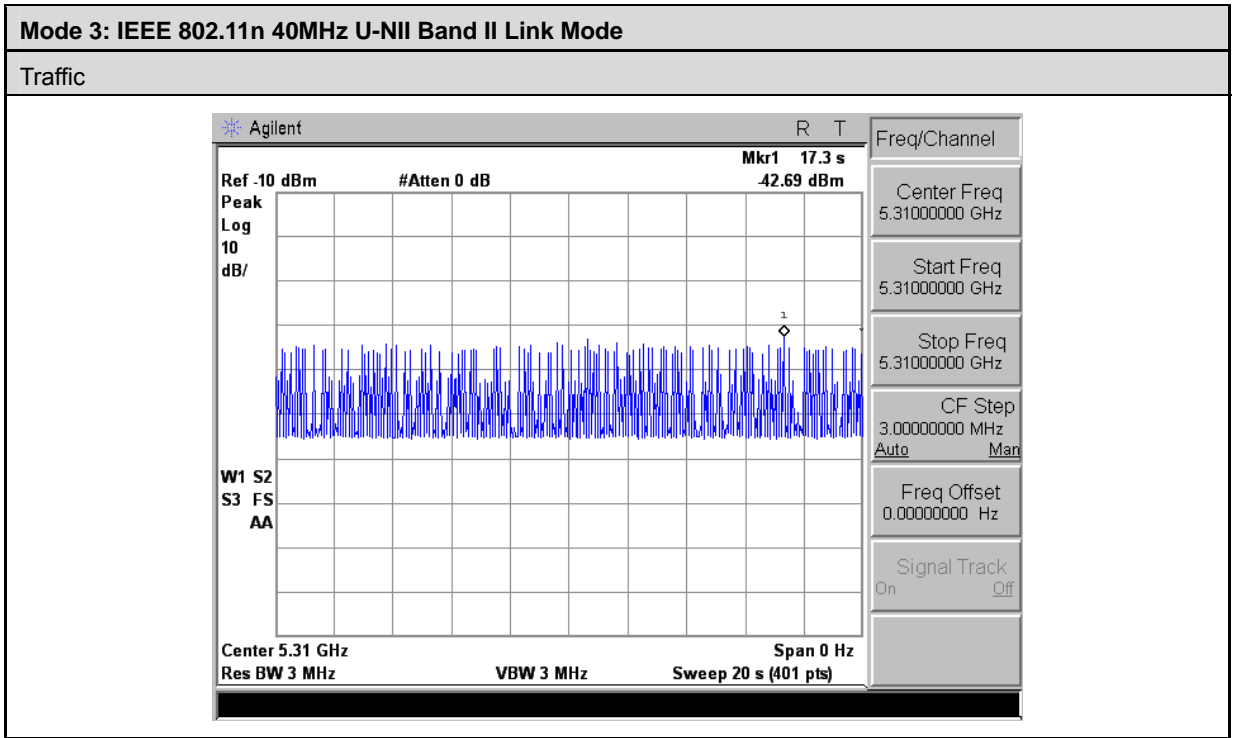

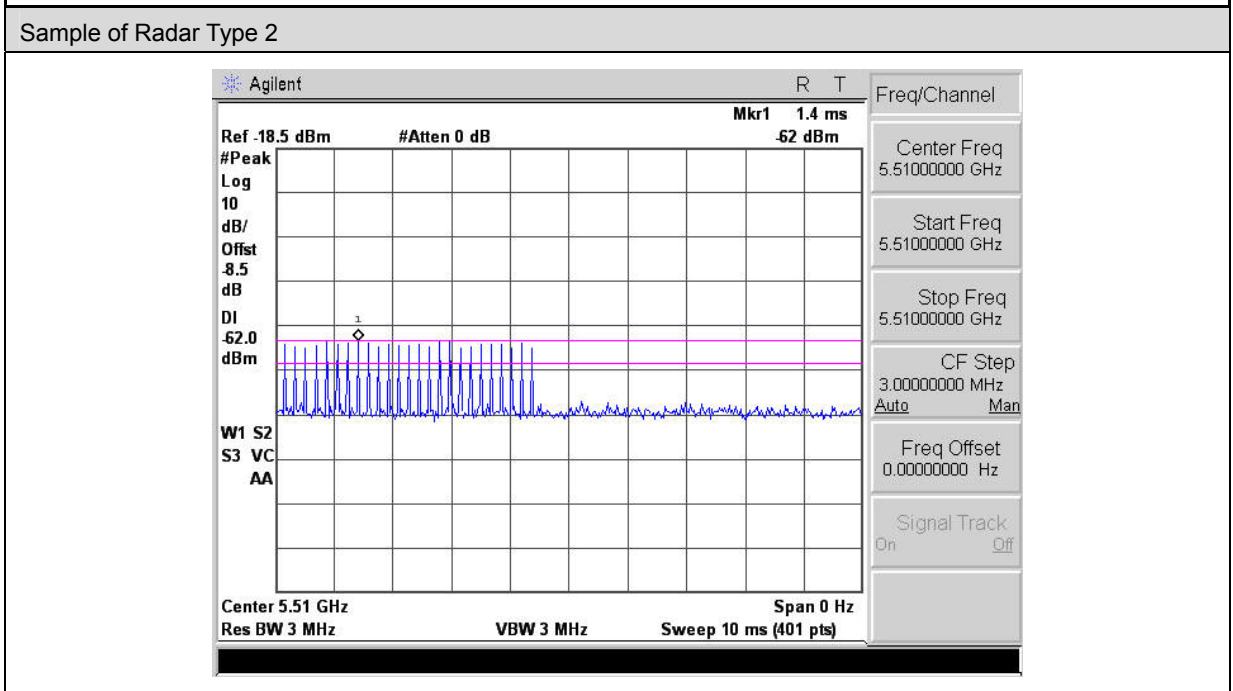
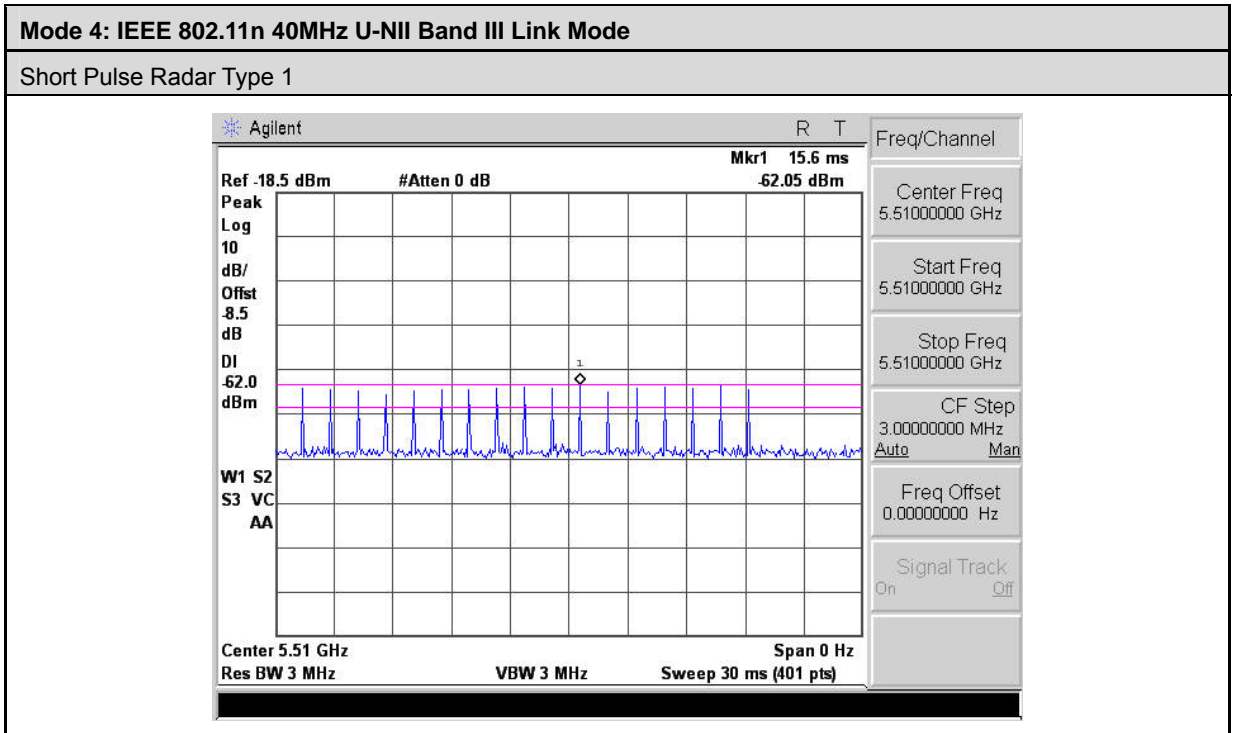

Mode 4: IEEE 802.11n 40MHz U-NII Band III Link Mode

Sample of Radar Type 3

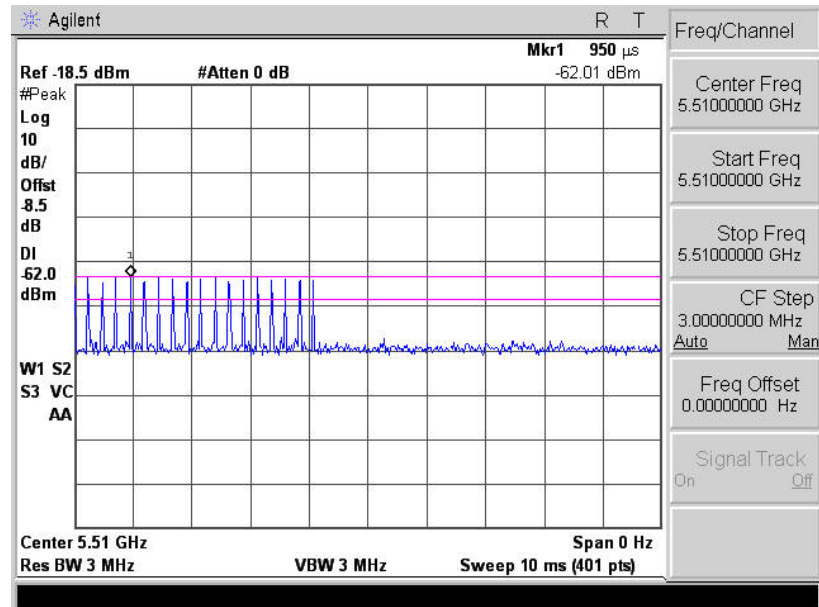

Sample of Radar Type 4

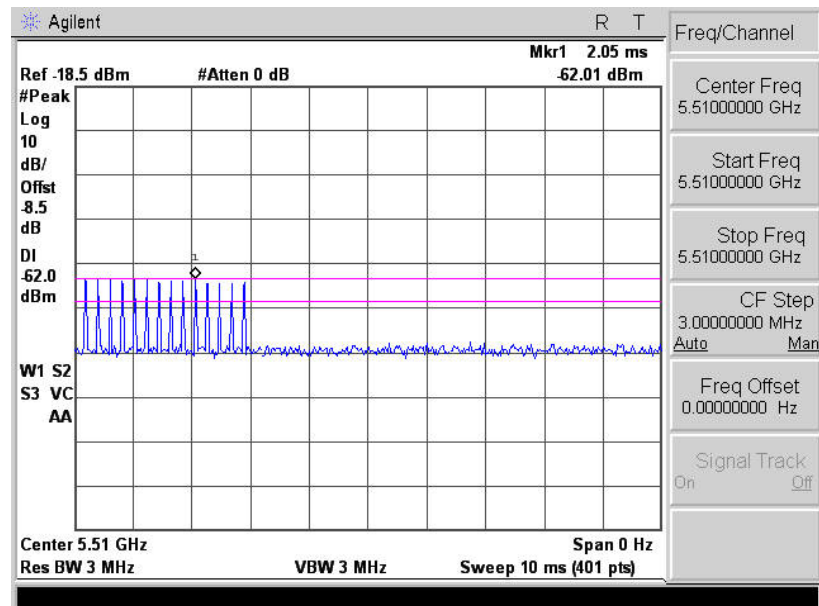

Mode 4: IEEE 802.11n 40MHz U-NII Band III Link Mode

Sample Of Single Burst of Radar Type 5

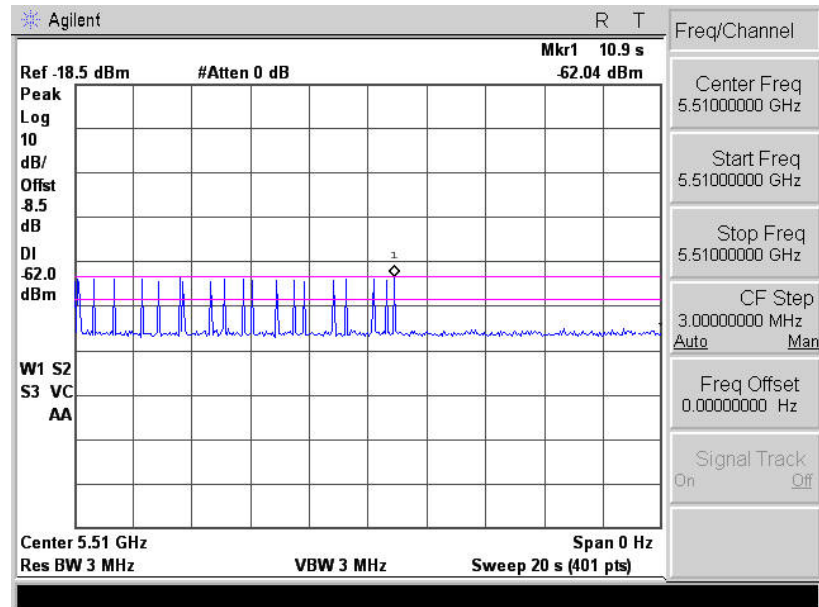

Single Burst of Radar Type 6

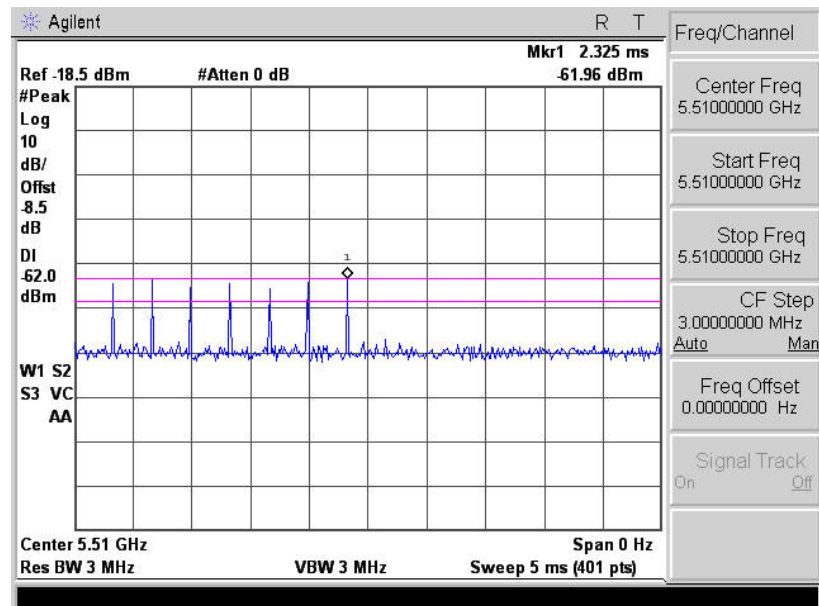

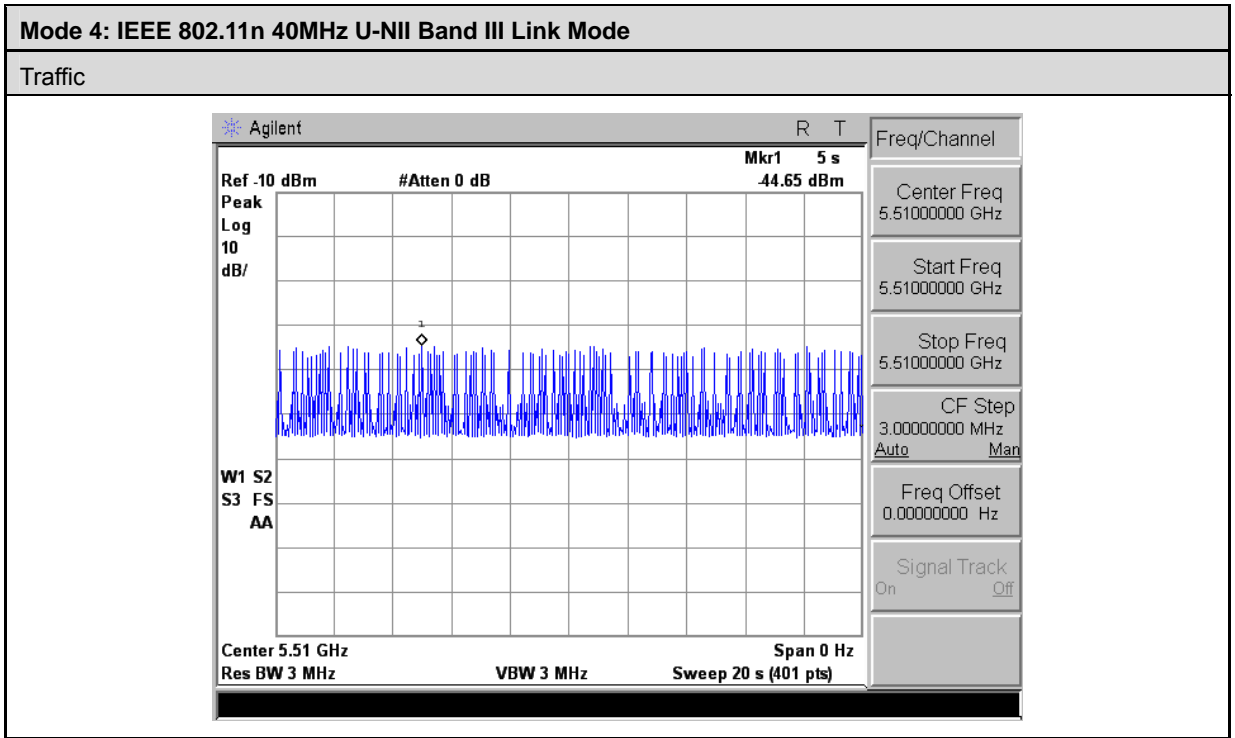

6.2. Channel Availability Check Time

6.2.1. Procedure to Determine Initial Power-Up Cycle Time

A link was established on channel then the EUT was rebooted. The time from the cessation of traffic to the re-initialization of traffic was measured as the time required for the EUT to complete the total power-up cycle. The time to complete the initial power-up period is 60 seconds less than this total power-up time.

6.2.2. Procedure for Timing Of Radar Burst

With a link established on channel, the EUT was rebooted. A radar signal was triggered within 0 to 6 seconds after the initial power-up period, and transmissions on the channel were monitored on the spectrum analyzer.

The Non-Occupancy list was cleared. With a link established on channel, the EUT was rebooted. A radar signal was triggered within 54 to 60 seconds after the initial power-up period, and transmissions on the channel were monitored on the spectrum analyzer.

6.2.3. Quantitative Results

These tests are not applicable.

6.3. Overlapping Channel Tests

These tests are not applicable.

6.4. Move and Closing Time

6.4.1. Reporting Notes

The reference marker is set at the end of last radar pulse.

The delta marker is set at the end of the last WLAN transmission following the radar pulse.

This delta is the channel move time.

The aggregate channel closing transmission time is calculated as follows:

Aggregate Transmission Time = (Number of analyzer bins showing transmission) * (dwell time per bin)

The observation period over which the FCC aggregate time is calculated begins at (Reference Marker + 200 msec) and ends no earlier than (Reference Marker + 10 sec).

6.4.2. Results

Mode 3: IEEE 802.11n 40MHz U-NII Band II

Agency	Channel Move Time (sec)	Limit (sec)
FCC	1.000	10

Agency	Aggregate Channel Closing Transmission Time (msec)	Limit (msec)
FCC	50	200

Mode 4: IEEE 802.11n 40MHz U-NII Band III

Agency	Channel Move Time (sec)	Limit (sec)
FCC	1.000	10

Agency	Aggregate Channel Closing Transmission Time (msec)	Limit (msec)
FCC	30	200

Mode 3: IEEE 802.11n 40MHz U-NII Band II Link Mode

Move Time

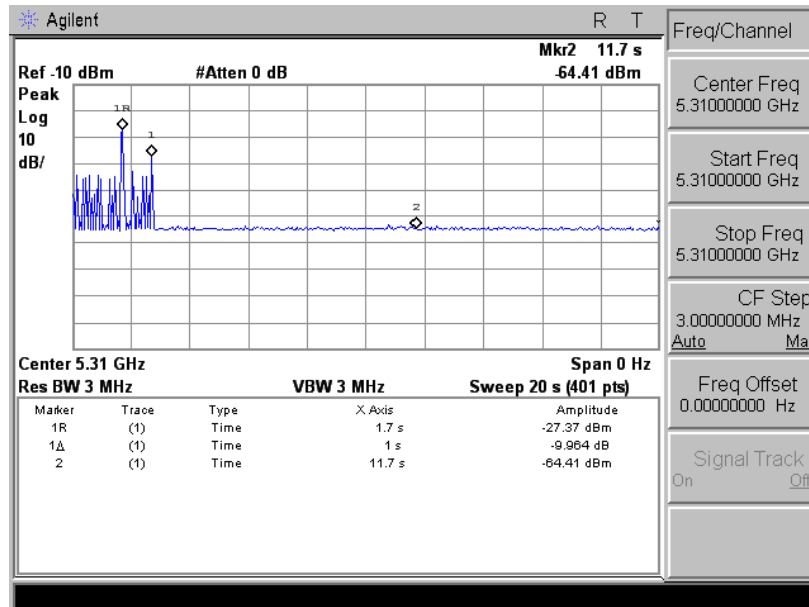

Channel Closing Time

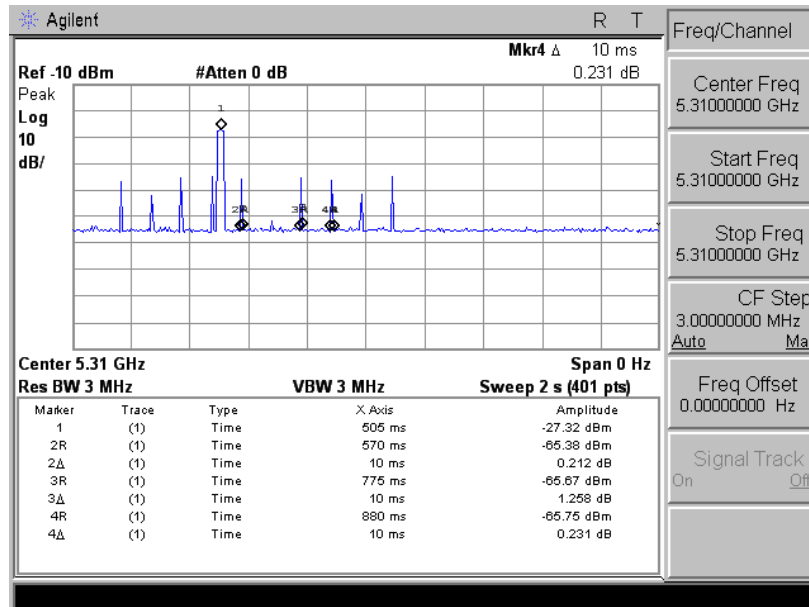

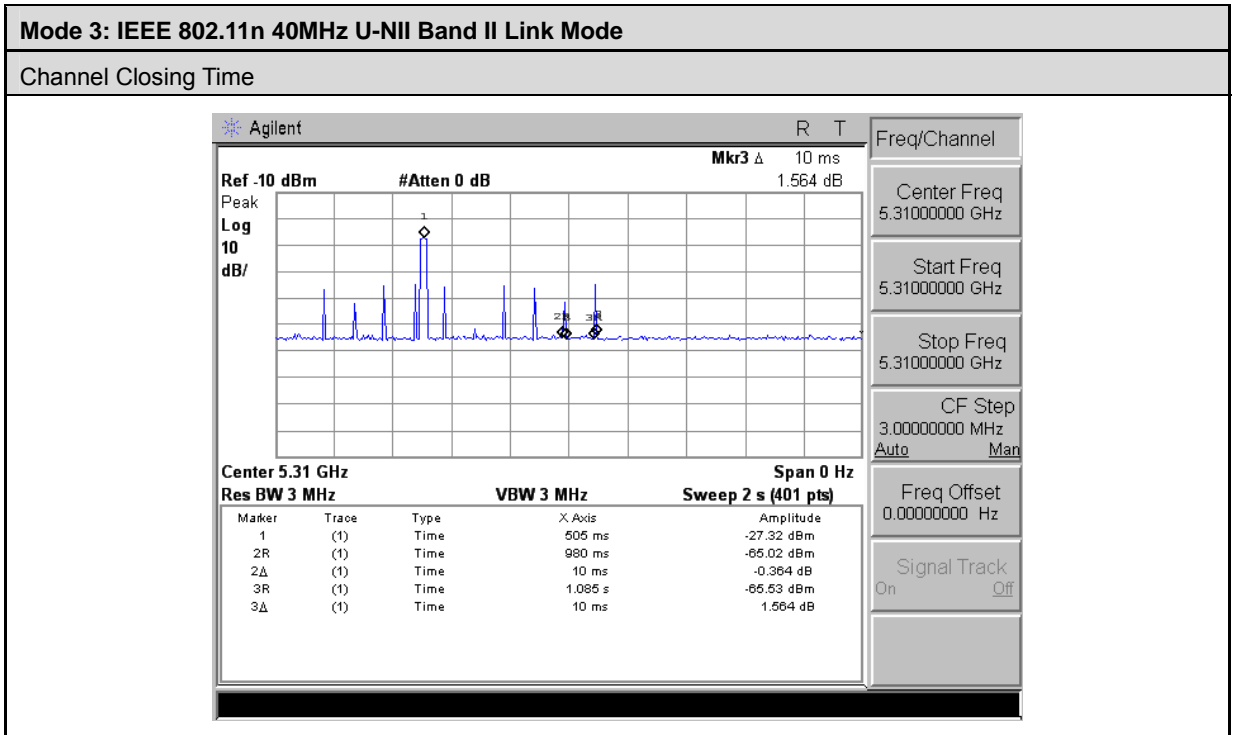

Mode 4: IEEE 802.11n 40MHz U-NII Band III Link Mode

Move Time

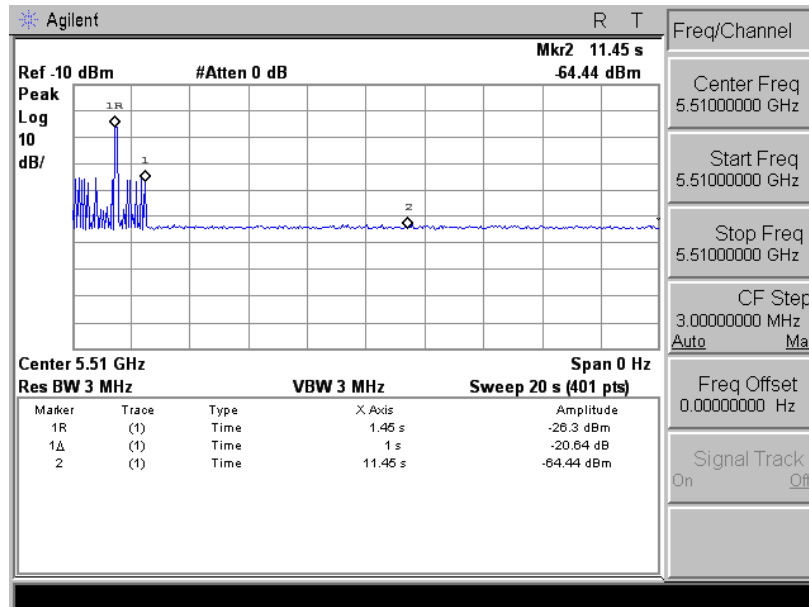

Channel Closing Time

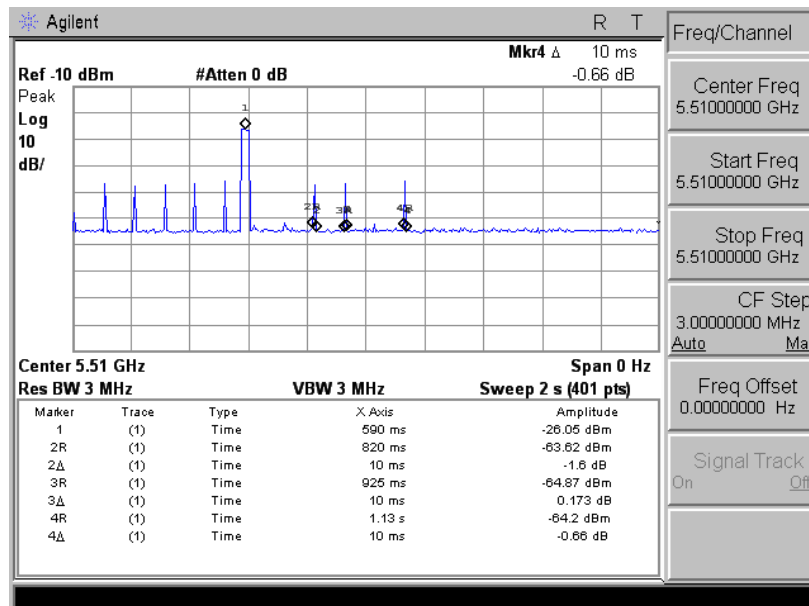

6.5. Non-Occupancy Period

6.5.1. Results

No EUT transmissions were observed on the test channel during the 30-minute observation time.

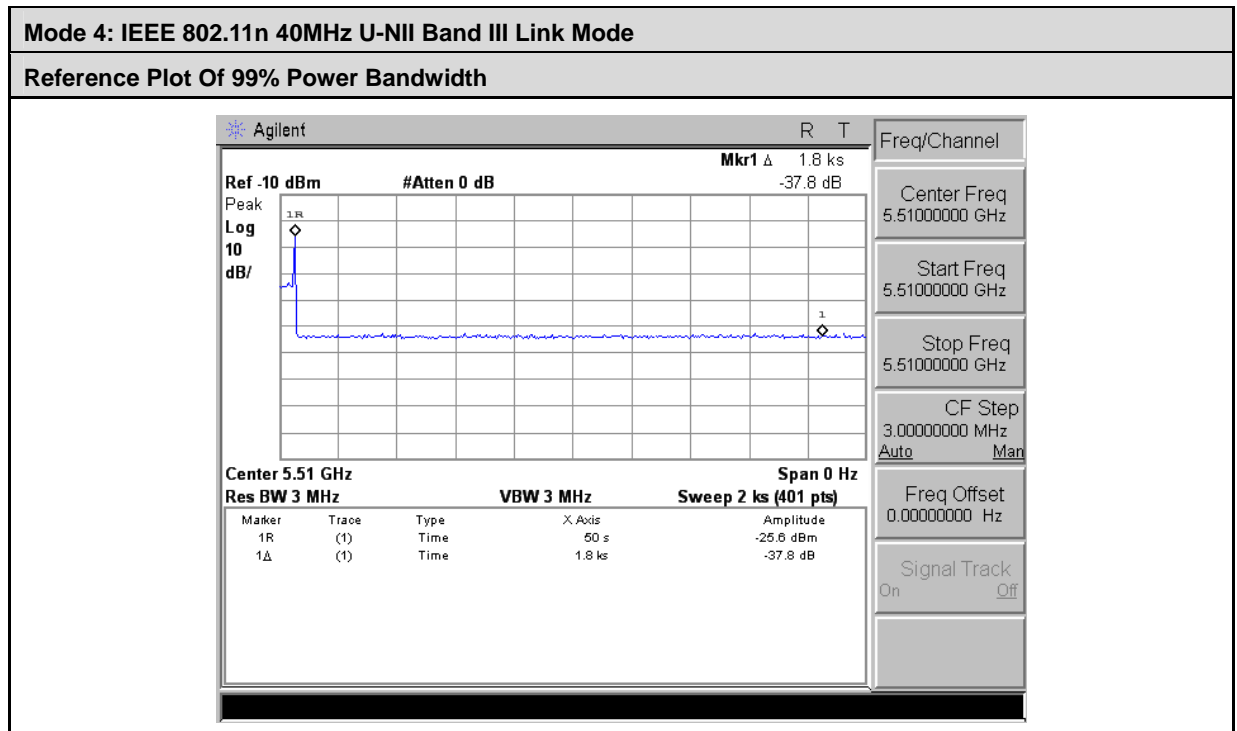
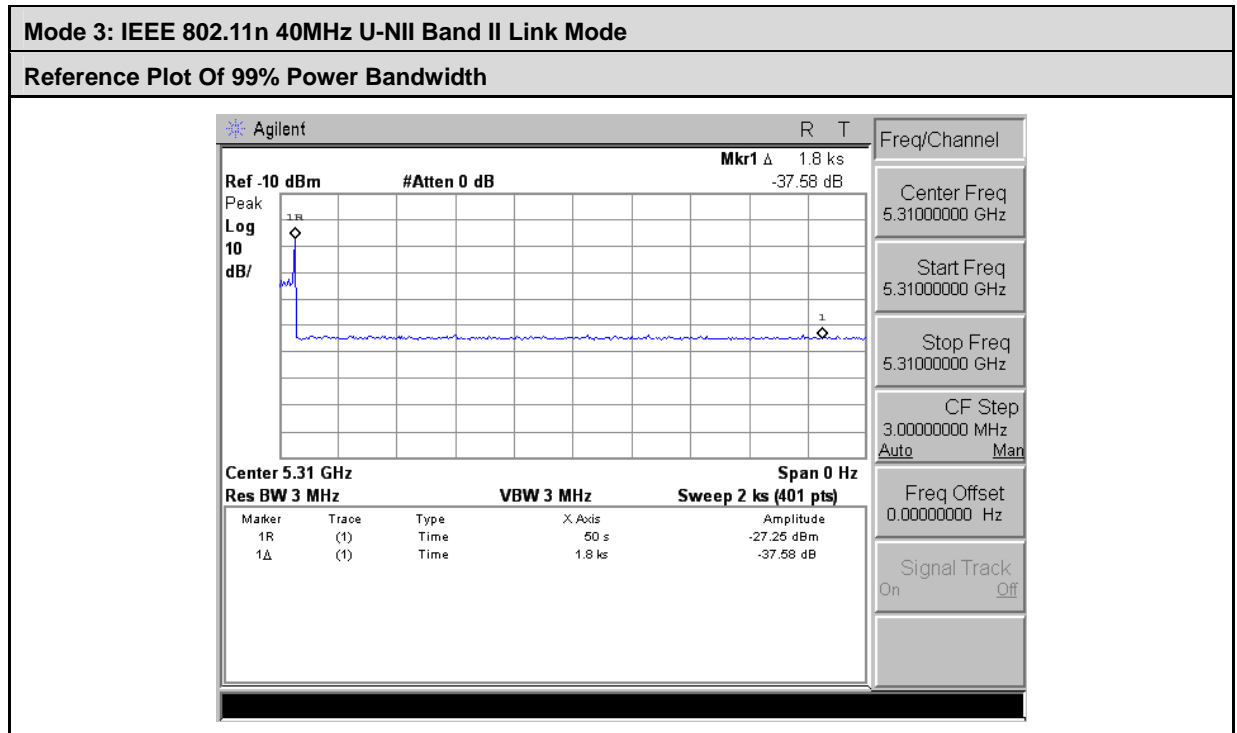

6.6. Detection Bandwidth

These tests are not applicable.

6.7. In-Service Monitoring

These tests are not applicable.