



**FCC 47 CFR PART 15 SUBPART C  
(Class II Permissive Change)**

**TEST REPORT**

**For**

**RFID 13.56MHz Wireless Module**

**Model: DWRFID1501**

**Trade Name: DELL**

*Issued to*

**Dell Inc.**

**One Dell Way Round Rock Texas 78682 United States**

*Issued by*

**Compliance Certification Services Inc.**

**No.11, Wugong 6th Rd., Wugu Dist.,  
New Taipei City 24891, Taiwan. (R.O.C.)**

**<http://www.ccsrf.com>**

**[service@ccsrf.com](mailto:service@ccsrf.com)**

**Issued Date: May 11, 2015**



**Testing Laboratory  
1309**

---

*Note: This report shall not be reproduced except in full, without the written approval of Compliance Certification Services Inc. This document may be altered or revised by Compliance Certification Services Inc. personnel only, and shall be noted in the revision section of the document.*



**Revision History**

Rev.	Issue Date	Revisions	Effect Page	Revised By
00	May 11, 2015	Initial Issue	ALL	Doris Chu



## TABLE OF CONTENTS

<b>1. TEST RESULT CERTIFICATION.....</b>	<b>4</b>
<b>2. EUT DESCRIPTION .....</b>	<b>5</b>
<b>3. TEST METHODOLOGY .....</b>	<b>6</b>
3.1 EUT CONFIGURATION .....	6
3.2 EUT EXERCISE .....	6
3.3 GENERAL TEST PROCEDURES .....	6
3.4 FCC PART 15.205 RESTRICTED BANDS OF OPERATIONS .....	7
3.5 DESCRIPTION OF TEST MODES .....	7
<b>4. INSTRUMENT CALIBRATION.....</b>	<b>8</b>
4.1 MEASURING INSTRUMENT CALIBRATION .....	8
4.2 MEASUREMENT EQUIPMENT USED .....	8
4.3 MEASUREMENT UNCERTAINTY .....	9
<b>5. FACILITIES AND ACCREDITATIONS .....</b>	<b>10</b>
5.1 FACILITIES .....	10
5.2 EQUIPMENT .....	10
5.3 TABLE OF ACCREDITATIONS AND LISTINGS .....	11
<b>6. SETUP OF EQUIPMENT UNDER TEST .....</b>	<b>12</b>
6.1 SETUP CONFIGURATION OF EUT .....	12
6.2 SUPPORT EQUIPMENT.....	12
<b>7. FCC PART 15.225 REQUIREMENTS.....</b>	<b>13</b>
7.1 20 DB BANDWIDTH .....	13
7.2 RADIATED EMISSIONS .....	15
7.3 FREQUENCY STABILITY .....	22
7.4 POWERLINE CONDUCTED EMISSIONS .....	25
<b>APPENDIX I PHOTOGRAPHS OF TEST SETUP .....</b>	<b>28</b>



# 1. TEST RESULT CERTIFICATION

**Applicant:** Dell Inc.  
 One Dell Way Round Rock Texas 78682 United States

**Equipment Under Test:** RFID 13.56MHz Wireless Module

**Trade Name:** DELL

**Model:** DWRFID1501

**Date of Test:** April 30 ~ May 4, 2015

APPLICABLE STANDARDS	
STANDARD	TEST RESULT
FCC 47 CFR Part 15 Subpart C	No non-compliance noted

### We hereby certify that:

The above equipment was tested by Compliance Certification Services Inc. The test data, data evaluation, test procedures, and equipment configurations shown in this report were made in accordance with the procedures given in ANSI C63.10: 2009 and the energy emitted by the sample tested as described in this report is in compliance with the requirements of FCC Rules Part 15.225.

The test results of this report relate only to the tested sample identified in this report.

Approved by:

Reviewed by:

---

Miller Lee  
 Manager  
 Compliance Certification Services Inc.

---

Angel Cheng  
 Section Manager  
 Compliance Certification Services Inc.



## 2. EUT DESCRIPTION

<b>Product</b>	RFID 13.56MHz Wireless Module
<b>Trade Name</b>	DELL
<b>Model Number</b>	DWRFID1501
<b>Model Difference</b>	N/A
<b>Received Date</b>	April 29, 2015
<b>Power Supply</b>	1. Vdc from Power Adapter DELL / DA65NM130 I/P: 100-240VAC, 50-60Hz, 1.7A O/P: 19.5VDC, 3.34A 2. Powered from battery 11.4V, 4130mAh
<b>Frequency Range</b>	13.56MHz
<b>Modulation Technique</b>	ASK
<b>Number of Channels</b>	1 Channel
<b>Antenna Designation</b>	WNC / 81EAA215.G29 Loop Antenna / Gain: 0 dBi
<b>Class II Permissive Change</b>	The product RFID 13.56MHz Wireless Module will be installed in the following models of notebooks/laptops: Model: P48F Product name: Notebook Computer / Brand name: DELL / Model: P48F

**Remark:**

1. The sample selected for test was engineering sample that approximated to production product and was provided by manufacturer.
2. This submittal(s) (test report) is intended for FCC ID: **E2K-DWRFID1501** filing to comply with Section 15.225 of the FCC Part 15, Subpart C Rules.



### **3. TEST METHODOLOGY**

The tests documented in this report were performed in accordance with ANSI C63.10: 2009 and FCC CFR 47 Part 15.207, 15.209 and 15.225.

#### **3.1 EUT CONFIGURATION**

The EUT configuration for testing is installed on RF field strength measurement to meet the Commissions requirement and operating in a manner that intends to maximize its emission characteristics in a continuous normal application.

#### **3.2 EUT EXERCISE**

The EUT was operated in the engineering mode to fix the TX frequency that was for the purpose of the measurements.

#### **3.3 GENERAL TEST PROCEDURES**

##### **Conducted Emissions**

The EUT is placed on the turntable, which is 0.8 m above ground plane. According to the requirements in ANSI C63.10: 2009. Conducted emissions from the EUT measured in the frequency range between 0.15 MHz and 30MHz using CISPR Quasi-peak and average detector modes.

##### **Radiated Emissions**

The EUT is placed on a turn table, which is 0.8 m above ground plane. The turntable shall rotate 360 degrees to determine the position of maximum emission level. EUT is set 3m away from the receiving antenna, which varied from 1m to 4m to find out the highest emission. And also, each emission was to be maximized by changing the polarization of receiving antenna both horizontal and vertical. In order to find out the maximum emissions, exploratory radiated emission measurements were made according to the requirements in ANSI C63.10: 2009.



### 3.4 FCC PART 15.205 RESTRICTED BANDS OF OPERATIONS

(a) Except as shown in paragraph (d) of this section, only spurious emissions are permitted in any of the frequency bands listed below:

MHz	MHz	MHz	GHz
0.090 - 0.110	16.42 - 16.423	399.9 - 410	4.5 - 5.15
<sup>1</sup> 0.495 - 0.505	16.69475 - 16.69525	608 - 614	5.35 - 5.46
2.1735 - 2.1905	16.80425 - 16.80475	960 - 1240	7.25 - 7.75
4.125 - 4.128	25.5 - 25.67	1300 - 1427	8.025 - 8.5
4.17725 - 4.17775	37.5 - 38.25	1435 - 1626.5	9.0 - 9.2
4.20725 - 4.20775	73 - 74.6	1645.5 - 1646.5	9.3 - 9.5
6.215 - 6.218	74.8 - 75.2	1660 - 1710	10.6 - 12.7
6.26775 - 6.26825	108 - 121.94	1718.8 - 1722.2	13.25 - 13.4
6.31175 - 6.31225	123 - 138	2200 - 2300	14.47 - 14.5
8.291 - 8.294	149.9 - 150.05	2310 - 2390	15.35 - 16.2
8.362 - 8.366	156.52475 -	2483.5 - 2500	17.7 - 21.4
8.37625 - 8.38675	156.52525	2655 - 2900	22.01 - 23.12
8.41425 - 8.41475	156.7 - 156.9	3260 - 3267	23.6 - 24.0
12.29 - 12.293	162.0125 - 167.17	3332 - 3339	31.2 - 31.8
12.51975 - 12.52025	167.72 - 173.2	3345.8 - 3358	36.43 - 36.5
12.57675 - 12.57725	240 - 285	3600 - 4400	( <sup>2</sup> )
13.36 - 13.41	322 - 335.4		

<sup>1</sup> Until February 1, 1999, this restricted band shall be 0.490-0.510 MHz.

<sup>2</sup> Above 38.6

(b) Except as provided in paragraphs (d) and (e), the field strength of emissions appearing within these frequency bands shall not exceed the limits shown in Section 15.209. At frequencies equal to or less than 1000 MHz, compliance with the limits in Section 15.209 shall be demonstrated using measurement instrumentation employing a CISPR quasi-peak detector. Above 1000 MHz, compliance with the emission limits in Section 15.209 shall be demonstrated based on the average value of the measured emissions. The provisions in Section 15.35 apply to these measurements.

### 3.5 DESCRIPTION OF TEST MODES

The EUT (model: DWRFID1501) had been tested under engineering test mode condition and the EUT staying in continuous transmitting mode.



## 4. INSTRUMENT CALIBRATION

### 4.1 MEASURING INSTRUMENT CALIBRATION

The measuring equipment, which was utilized in performing the tests documented herein, has been calibrated in accordance with the manufacturer's recommendations for utilizing calibration equipment, which is traceable to recognized national standards.

### 4.2 MEASUREMENT EQUIPMENT USED

#### Equipment Used for Emissions Measurement

*Remark: Each piece of equipment is scheduled for calibration once a year and Loop Antenna is scheduled for calibration once three years.*

Wugu 966 Chamber A				
Name of Equipment	Manufacturer	Model	Serial Number	Calibration Due
Spectrum Analyzer	Agilent	E4446A	US42510268	09/18/2015
EMI Test Receiver	R&S	ESCI	100064	05/30/2015
Loop Antenna	EMCO	6502	8905/2356	06/11/2015
Bilog Antenna	Sunol Sciences	JB3	A030105	08/19/2015
Horn Antenna	EMCO	3117	00055165	01/26/2016
Turn Table	CCS	CC-T-1F	N/A	N.C.R
Antenna Tower	CCS	CC-A-1F	N/A	N.C.R
Controller	CCS	CC-C-1F	N/A	N.C.R
Test S/W	EZ-EMC (CCS-3A1RE)			

Conducted Emissions Test Site				
Name of Equipment	Manufacturer	Model	Serial Number	Calibration Due
Spectrum Analyzer	Agilent	E4446A	US42510252	11/23/2015
Thermostatic/Hrgrosatic Chamber	TAICHY	MHG-150LF	930619	10/07/2015
AC Power Source	EXTECH	6205	1140845	N.C.R
DC Power Supply	ABM	8301HD	D011531	N.C.R
Power Meter	Anritsu	ML2495A	1012009	06/03/2015
Power Sensor	Anritsu	MA2411A	0917072	06/03/2015
Spectrum Analyzer	ROHDE&SCHWARZ	FSV40	101073	07/09/2015

Conducted Emission room # B				
Name of Equipment	Manufacturer	Model	Serial Number	Calibration Due
EMI Test Receiver	R&S	ESCI	101073	09/18/2015
LISN	R&S	ENV216	101054	05/18/2015
LISN	SCHWARZBECK	NSLK 8127	8127-541	11/25/2015
Capacitive Voltage Probe	FCC	F-CVP-1	100185	03/12/2016
Test S/W	CCS-3A1-CE			





### 4.3 MEASUREMENT UNCERTAINTY

PARAMETER	UNCERTAINTY
Powerline Conducted Emission	+/- 1.2575
3M Semi Anechoic Chamber / 30M~200M	+/- 4.0138
3M Semi Anechoic Chamber / 200M~1000M	+/- 3.9483
3M Semi Anechoic Chamber / 1G~8G	+/- 2.5975
3M Semi Anechoic Chamber / 8G~18G	+/- 2.6112
3M Semi Anechoic Chamber / 18G~26G	+/- 2.7389
3M Semi Anechoic Chamber / 26G~40G	+/- 2.9683

**Remark:** This uncertainty represents an expanded uncertainty expressed at approximately the 95% confidence level using a coverage factor of  $k=2$ .



## 5. FACILITIES AND ACCREDITATIONS

### 5.1 FACILITIES

All measurement facilities used to collect the measurement data are located at

No.199, Chunghsen Road, Hsintien City, Taipei Hsien, Taiwan, R.O.C.  
Tel: 886-2-2217-0894 / Fax: 886-2-2217-1029

No.11, Wugong 6th Rd., Wugu Dist., New Taipei City 24891, Taiwan. (R.O.C.)  
Tel: 886-2-2299-9720 / Fax: 886-2-2298-4045

No.81-1, Lane 210, Bade 2nd Rd., Lujhu Township, Taoyuan County 33841,  
TAIWAN, R.O.C.  
Tel: 886-3-324-0332 / Fax: 886-3-324-5235

The sites are constructed in conformance with the requirements of ANSI C63.7, ANSI C63.10:2009 and CISPR Publication 22.

### 5.2 EQUIPMENT

Radiated emissions are measured with one or more of the following types of linearly polarized antennas: tuned dipole, biconical, log periodic, bi-log, ridged waveguide, horn and/or Loop. Spectrum analyzers with pre-selectors and quasi-peak detectors are used to perform radiated measurements.



Conducted emissions are measured with Line Impedance Stabilization Networks and EMI Test Receivers.

Calibrated wideband preamplifiers, coaxial cables, and coaxial attenuators are also used for making measurements.

All receiving equipment conforms to CISPR Publication 16-1, "Radio Interference Measuring Apparatus and Measurement Methods."



### 5.3 TABLE OF ACCREDITATIONS AND LISTINGS

Country	Agency	Scope of Accreditation	Logo
USA	FCC	3M Semi Anechoic Chamber (FCC MRA: TW1309) to perform FCC Part 15 measurements	 FCC MRA: TW1309
Taiwan	TAF	LP0002, RTTE01, FCC Method-47 CFR Part 15 Subpart C, D, E, RSS-210, RSS-310 IDA TS SRD, AS/NZS 4268, AS/NZS 4771, TS 12.1 & 12.2, ETSI EN 300 440-1, ETSI EN 300 440-2, ETSI EN 300 328, ETSI EN 300 220-1, ETSI EN 300 220-2, ETSI EN 301 893, ETSI EN 301 489-1/3/7/17 FCC OET Bulletin 65 + Supplement C, EN 50360, EN 50361, EN 50371, RSS 102, EN 50383, EN 50385, EN 50392, IEC 62209, CNS 14958-1, CNS 14959 FCC Method -47 CFR Part 15 Subpart B IEC / EN 61000-3-2, IEC / EN 61000-3-3, IEC / EN 61000-4-2/3/4/5/6/8/11	
Canada	Industry Canada	3M Semi Anechoic Chamber (IC 2324G-1 / IC 2324G-2) to perform	 IC 2324G-1 IC 2324G-2

\* No part of this report may be used to claim or imply product endorsement by A2LA or any agency of the US Government.



## 6. SETUP OF EQUIPMENT UNDER TEST

### 6.1 SETUP CONFIGURATION OF EUT

See test photographs attached in Appendix I for the actual connections between EUT and support equipment.

### 6.2 SUPPORT EQUIPMENT

No.	Device Type	Brand	Model	Series No.	FCC ID	Data Cable	Power Cord
	N/A						

**Remark:**

- 1. All the equipment/cables were placed in the worst-case configuration to maximize the emission during the test.*
- 2. Grounding was established in accordance with the manufacturer's requirements and conditions for the intended use.*



## 7. FCC PART 15.225 REQUIREMENTS

### 7.1 20 DB BANDWIDTH

#### LIMIT

None; for reporting purposes only.

#### Test Configuration

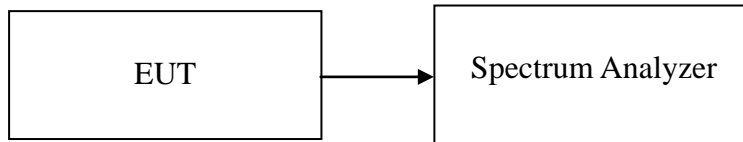

#### TEST PROCEDURE

1. Place the EUT on the table and set it in the transmitting mode.
2. Remove the antenna from the EUT and then connect a low loss RF cable from the antenna port to the spectrum analyzer.
3. Set the spectrum analyzer as RBW= 5.1kHz, VBW = 10kHz, Span = 500kHz, Sweep = auto.
4. Mark the peak frequency and 20dB (upper and lower) frequency.
5. Repeat until all the rest channels are investigated.

#### TEST RESULTS

*No non-compliance noted.*



### Test Plot

Agilent

R T

▲ Mkr2 8.7 kHz  
-0.08 dB

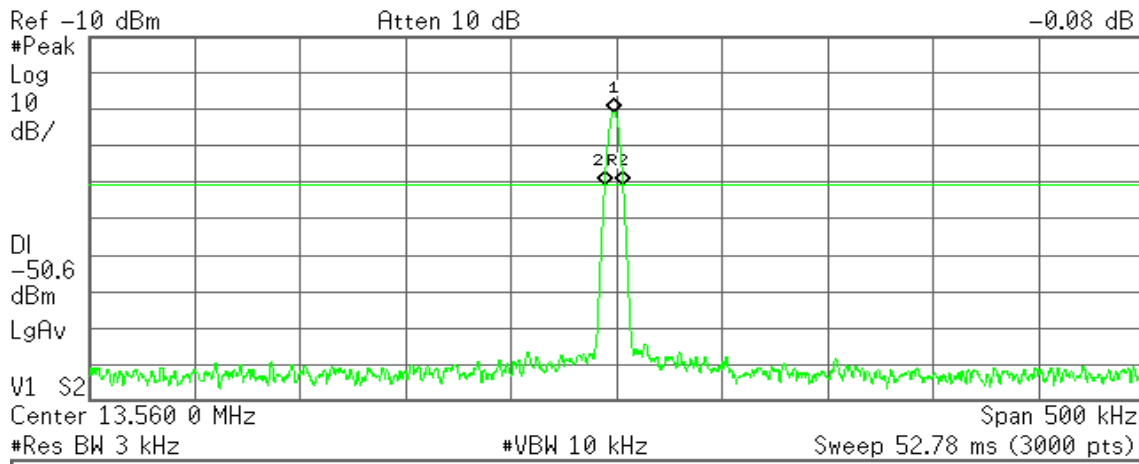

Marker	Trace	Type	X Axis	Amplitude
1	(1)	Freq	13.5587 MHz	-30.59 dBm
2R	(1)	Freq	13.5544 MHz	-50.78 dBm
2Δ	(1)	Freq	8.7 kHz	-0.08 dB



## 7.2 RADIATED EMISSIONS

### LIMIT

According to §15.225,

- (a) The field strength of any emissions within the band 13.553 – 13.567 MHz shall not exceed 15,848 microvolts / meter at 30 meters.
- (b) Within the bands 13.410 – 13.553 MHz and 13.567 -13.710 MHz, the field strength of any emissions shall not exceed 334 microvolts / meter at 30 meters.
- (c) Within the bands 13.110 – 13.410 MHz and 13.710 – 14.010 MHz the field strength of any emissions shall not exceed 106 microvolts / meter at 30 meters.
- (d) The field strength of any emissions appearing outside of the 13.110 – 14.010 MHz and shall not exceed the general radiated emission limits in §15.209.

According to §15.225, except as provided elsewhere in this Subpart, the emissions from an intentional radiator shall not exceed the field strength levels specified in the following table:

Frequency (MHz)	Field Strength ( $\mu\text{V/m}$ at meter)	Measurement Distance (meter)
0.009 – 0.490	2400 / F (kHz)	300
0.490 – 1.705	24000 / F (kHz)	30
1.705 – 30.0	30	30
30 - 88	100**	3
88-216	150**	3
216-960	200**	3
Above 960	500	3

\*\* Except as provided in paragraph (g), fundamental emissions from intentional radiators operating under this Section shall not be located in the frequency bands 54-72 MHz, 76-88 MHz, 174-216 MHz or 470-806 MHz. However, operation within these frequency bands is permitted under other sections of this Part, e.g., Sections 15.231 and 15.241.



### Test Configuration

#### 9kHz ~ 30MHz

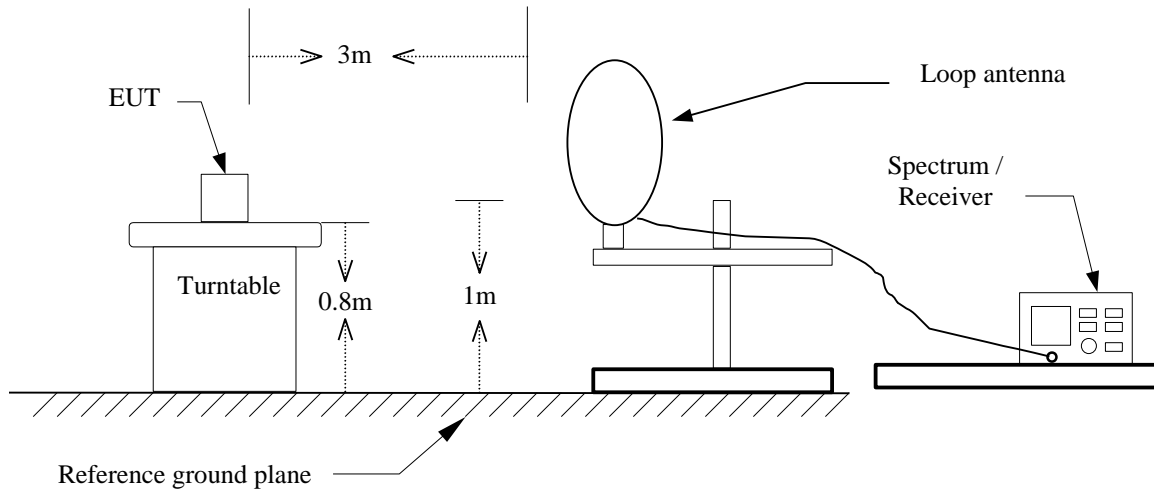

#### 30MHz ~ 1GHz

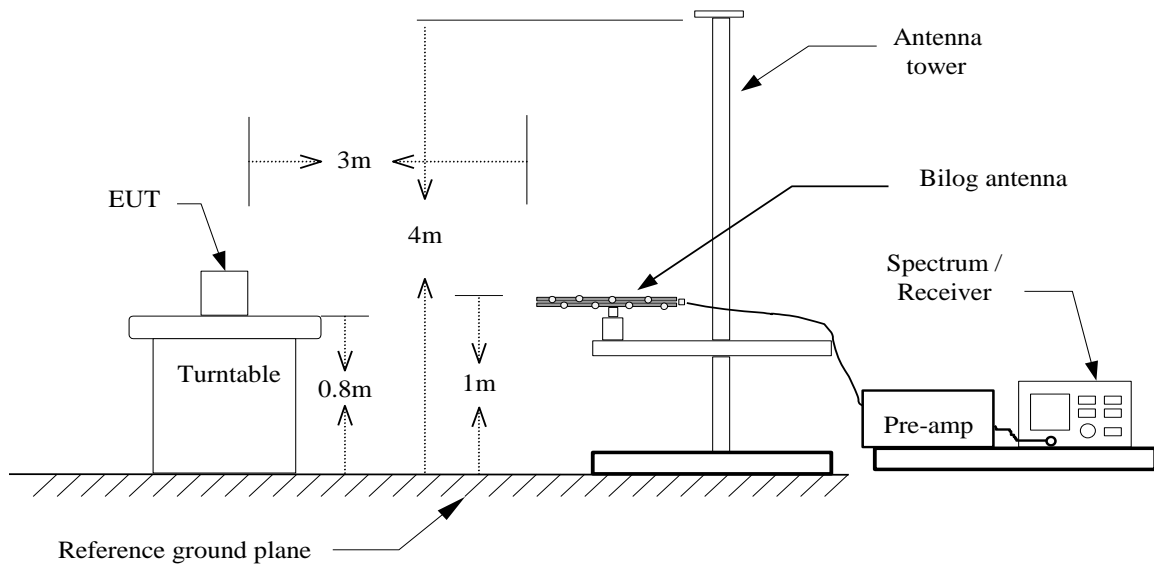





## **TEST PROCEDURE**

### **For 9kHz ~ 30MHz**

1. The EUT is placed on a turntable, which is 0.8m above ground plane.
2. The turntable shall be rotated for 360 degrees to determine the position of maximum emission level.
3. EUT is set 3m away from the receiving antenna, The center of the loop shall be 1 m above the ground then to find out the highest emissions.
4. Maximum procedure was performed on the six highest emissions to ensure EUT compliance.
5. Set the spectrum analyzer in the following setting as:  
RBW=10kHz / VBW=30kHz / Sweep=AUTO
6. Repeat above procedures until the measurements for all frequencies are complete.

### **For 30MHz ~ 1GHz**

1. The EUT is placed on a turntable, which is 0.8m above ground plane.
2. The turntable shall be rotated for 360 degrees to determine the position of maximum emission level.
3. EUT is set 3m away from the receiving antenna, which is varied from 1m to find out the highest emissions.
4. Maximum procedure was performed on the six highest emissions to ensure EUT compliance.
5. And also, each emission was to be maximized by changing the polarization of receiving antenna both horizontal and vertical.
6. Set the spectrum analyzer in the following setting as:  
RBW=100kHz / VBW=300kHz / Sweep=AUTO
7. Repeat above procedures until the measurements for all frequencies are complete.



**Operation Mode:** TX mode                      **Test Date:** April 30, 2015  
**Temperature:** 27°C                              **Tested by:** Andy Shi  
**Humidity:** 53 % RH                            **Polarity:** Ver. / Hor.

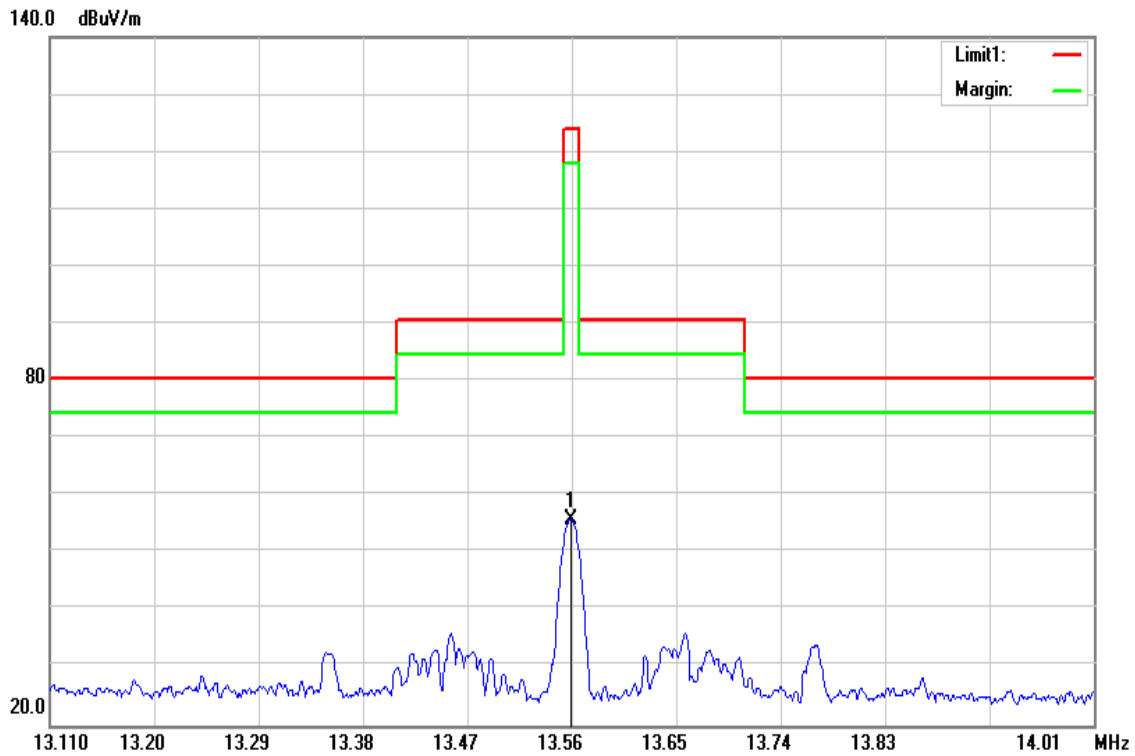

Frequency (MHz)	Reading (dBuV)	Correction Factor (dB/m)	Result (dBuV/m)	Limit 3m (dBuV/m)	Margin (dB)	Detector Mode (PK/QP/AVG)
13.5586	41.3	14.66	55.96	124	-68.04	PK

**Remark:**

1. Measuring frequencies from 9kHz to the 1GHz.
2. Radiated emissions measured were made with an instrument using peak/quasi-peak/average detector mode.
3. Measurements above show only up to 6 maximum emissions noted, or would be lesser, with " N/A " remark, if no specific emissions from the EUT are recorded (ie: margin>20dB from the applicable limit) and considered that's already beyond the background noise floor.
4. Margin (dB) = Result (dBuV/m) – Limit (dBuV/m).

**9kHz ~ 490kHz****Operation Mode:** TX mode**Test Date:** April 30, 2015**Temperature:** 27°C**Tested by:** Andy Shi**Humidity:** 53 % RH

Frequency (MHz)	Reading (dBuV)	Correction Factor (dB/m)	Result (dBuV/m)	Limit (dBuV/m)	Margin (dB)	Detector Mode (PK/QP/AVG)
0.2120	44.77	-17.26	27.51	113.86	-86.35	Peak
0.2663	44.85	-17.30	27.55	109.94	-82.39	Peak
0.3058	42.52	-17.31	25.21	107.09	-81.88	Peak
0.3491	41.42	-17.32	24.10	103.97	-79.87	Peak
0.3957	40.34	-17.33	23.01	100.60	-77.59	Peak
0.4212	39.86	-17.33	22.53	98.76	-76.23	Peak

**Remark:**

1. *Measuring frequencies from 9kHz to the 1GHz.*
2. *Radiated emissions measured were made with an instrument using peak/quasi-peak/average detector mode.*
3. *Measurements above show only up to 6 maximum emissions noted, or would be lesser, with " N/A " remark, if no specific emissions from the EUT are recorded (ie: margin>20dB from the applicable limit) and considered that's already beyond the background noise floor.*
4. *Margin (dB) = Result (dBuV/m) – Limit (dBuV/m).*



**30MHz ~ 1GHz****Operation Mode:** TX mode**Test Date:** April 30, 2015**Temperature:** 27°C**Tested by:** Andy Shi**Humidity:** 53 % RH

Frequency (MHz)	Reading (dBuV)	Correction Factor (dB/m)	Result (dBuV/m)	Limit 3m (dBuV/m)	Margin (dB)	Ant.Pol. (H/V)	Detector Mode (PK/QP/AVG)
59.1000	53.43	-23.85	29.58	40.00	-10.42	V	Peak
192.9600	45.91	-18.17	27.74	43.50	-15.76	V	Peak
340.4000	44.71	-15.42	29.29	46.00	-16.71	V	Peak
537.3100	31.96	-11.21	20.75	46.00	-25.25	V	Peak
743.9200	29.77	-7.99	21.78	46.00	-24.22	V	Peak
833.1600	38.17	-6.98	31.19	46.00	-14.81	V	Peak
57.1600	51.77	-23.64	28.13	40.00	-11.87	H	Peak
203.6300	52.45	-17.80	34.65	43.50	-8.85	H	Peak
328.7600	43.49	-15.71	27.78	46.00	-18.22	H	Peak
499.4800	35.07	-11.84	23.23	46.00	-22.77	H	Peak
675.0500	29.73	-9.05	20.68	46.00	-25.32	H	Peak
773.0200	32.99	-7.65	25.34	46.00	-20.66	H	Peak

**Remark:**

1. Measuring frequencies from 9kHz to the 1GHz.
2. Radiated emissions measured were made with an instrument using peak/quasi-peak/average detector mode.
3. Measurements above show only up to 6 maximum emissions noted, or would be lesser, with " N/A " remark, if no specific emissions from the EUT are recorded (ie: margin>20dB from the applicable limit) and considered that's already beyond the background noise floor.
4.  $Margin (dB) = Result (dBuV/m) - Limit (dBuV/m)$ .



## 7.3 FREQUENCY STABILITY

### LIMIT

According to §15.225(e), the frequency tolerance of the carrier signal shall be maintained within +/- 0.01% of the operating frequency over a temperature variation of -20 degrees to +50 degrees C at normal supply voltage, and for a variation in the primary supply voltage from 85% to 115% of the rated supply voltage at a temperature of 20 degrees C. For battery operated equipment, the equipment tests shall be performed using a new battery.

### Test Configuration

**Temperature and Voltage Measurement (under normal and extreme test conditions)**

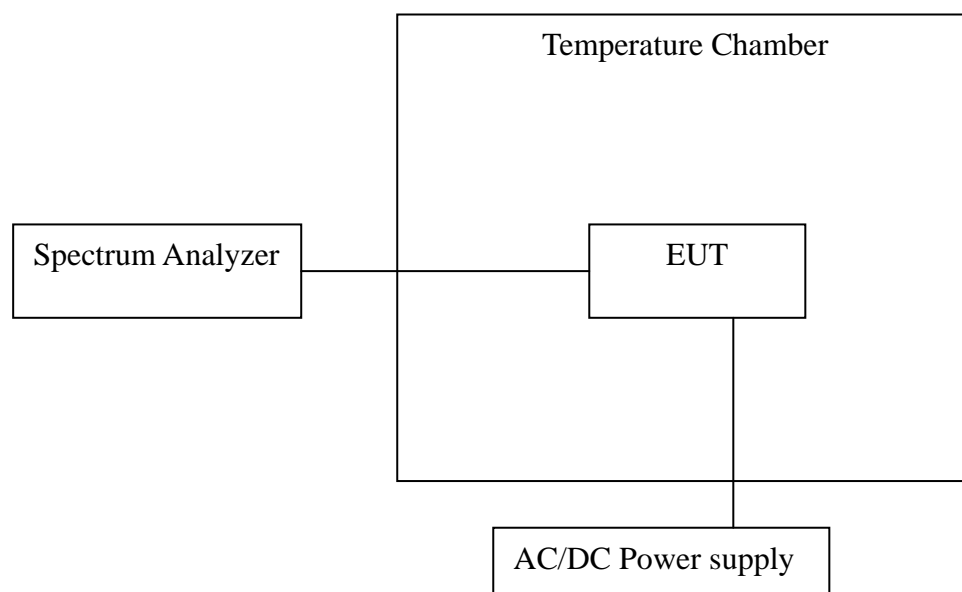

### TEST PROCEDURE

1. Turn the EUT off, and place it inside the environmental temperature chamber.
2. Set the temperature control on the chamber to the highest specified in the regulatory requirements for the type of device and allow the oscillator heater and the chamber temperature to stabilize.
3. Set the spectrum analyzer as RBW=1kHz, VBW = RBW, Span = 200kHz, Sweep = auto.
4. Turn the EUT on and record the operating frequency at startup and two, five, and ten minutes after the EUT is energized.
5. Switch off the EUT and Lower the chamber temperature by not more than 10 °C and allow the temperature inside the chamber to stabilize.
6. Mark the peak frequency and measure the frequency tolerance using frequency counter function.
7. Repeat step 4 through step 6 down to the lowest specified temperature.



### TEST RESULTS

No non-compliance noted.

#### Temperature Variations

Temperature (°C)	Voltage (V)	Measured Time (m)	Measured Frequency (MHz)	Delta Frequency (Hz)	Tolerance (%)	Limit (±%)	Margin (%)	Result (Pass/Fail)
50	120	start up	13.56004	40	0.00029	0.01	-0.00971	Pass
		2	13.56032	320	0.00236	0.01	-0.00764	Pass
		5	13.56054	540	0.00398	0.01	-0.00602	Pass
		10	13.56039	390	0.00288	0.01	-0.00712	Pass
40	120	start up	13.56003	30	0.00022	0.01	-0.00978	Pass
		2	13.56062	620	0.00457	0.01	-0.00543	Pass
		5	13.56017	170	0.00125	0.01	-0.00875	Pass
		10	13.56009	90	0.00066	0.01	-0.00934	Pass
30	120	start up	13.56019	190	0.00140	0.01	-0.00860	Pass
		2	13.56070	700	0.00516	0.01	-0.00484	Pass
		5	13.56057	570	0.00420	0.01	-0.00580	Pass
		10	13.56028	280	0.00206	0.01	-0.00794	Pass
20	120	start up	13.56067	670	0.00494	0.01	-0.00506	Pass
		2	13.56006	60	0.00044	0.01	-0.00956	Pass
		5	13.56034	340	0.00251	0.01	-0.00749	Pass
		10	13.56028	280	0.00206	0.01	-0.00794	Pass
10	120	start up	13.56061	610	0.00450	0.01	-0.00550	Pass
		2	13.56059	590	0.00435	0.01	-0.00565	Pass
		5	13.56035	350	0.00258	0.01	-0.00742	Pass
		10	13.56038	380	0.00280	0.01	-0.00720	Pass
0	120	start up	13.56028	280	0.00206	0.01	-0.00794	Pass
		2	13.56033	330	0.00243	0.01	-0.00757	Pass
		5	13.56008	80	0.00059	0.01	-0.00941	Pass
		10	13.56064	640	0.00472	0.01	-0.00528	Pass
-10	120	start up	13.56020	200	0.00147	0.01	-0.00853	Pass
		2	13.56010	100	0.00074	0.01	-0.00926	Pass
		5	13.56038	380	0.00280	0.01	-0.00720	Pass
		10	13.56024	240	0.00177	0.01	-0.00823	Pass
-20	120	start up	13.56025	250	0.00184	0.01	-0.00816	Pass
		2	13.56040	400	0.00295	0.01	-0.00705	Pass
		5	13.56025	250	0.00184	0.01	-0.00816	Pass
		10	13.56012	120	0.00088	0.01	-0.00912	Pass



**Voltage Variations**

<b>Temp. (°C)</b>	<b>Voltage (V)</b>	<b>Measured Frequency (MHz)</b>	<b>Delta Frequency (Hz)</b>	<b>Tolerance (%)</b>	<b>Limit (±%)</b>	<b>Margin (%)</b>	<b>Result (Pass/Fail)</b>
20	93.5	13.56008	80	0.00059	0.01	-0.00941	Pass
	110	13.56017	170	0.00125	0.01	-0.00875	Pass
	126.5	13.56067	670	0.00494	0.01	-0.00506	Pass





## 7.4 POWERLINE CONDUCTED EMISSIONS

### LIMIT

According to §15.207(a), except as shown in paragraphs (b) and (c) of this section, for an intentional radiator that is designed to be connected to the public utility (AC) power line, the radio frequency voltage that is conducted back onto the AC power line on any frequency or frequencies within the band 150 kHz to 30 MHz shall not exceed the limits in the following table, as measured using a 50  $\mu$ H/50 ohms line impedance stabilization network (LISN). Compliance with the provisions of this paragraph shall be based on the measurement of the radio frequency voltage between each power line and ground at the power terminal. The lower limit applies at the boundary between the frequency ranges.

Frequency Range (MHz)	Limits (dB $\mu$ V)	
	Quasi-peak	Average
0.15 to 0.50	66 to 56*	56 to 46*
0.50 to 5	56	46
5 to 30	60	50

\* Decreases with the logarithm of the frequency.

### TEST PROCEDURE

1. The EUT was placed on a table, which is 0.8m above ground plane.
2. Maximum procedure was performed on the six highest emissions to ensure EUT compliance.
3. Repeat above procedures until all frequency measured were complete.



**TEST RESULTS**

The initial step in collecting conducted data is a spectrum analyzer peak scan of the measurement range. Significant peaks are then marked as shown on the following data page, and these signals are then quasi-peaked.

<b>Operation Mode:</b>	Normal Link	<b>Test Date:</b>	May 4, 2015
<b>Temperature:</b>	26°C	<b>Tested by:</b>	David Shu
<b>Humidity:</b>	60% RH		

Freq. (MHz)	QP Reading (dBuV)	AV Reading (dBuV)	Corr. factor (dB)	QP Result (dBuV)	AV Result (dBuV)	QP Limit (dBuV)	AV Limit (dBuV)	QP Margin (dB)	AV Margin (dB)	Note
0.1573	48.97	26.51	0.19	49.16	26.70	65.61	55.61	-16.45	-28.91	L1
0.1976	39.23	29.95	0.19	39.42	30.14	63.71	53.71	-24.29	-23.57	L1
0.2971	37.63	29.73	0.19	37.82	29.92	60.32	50.32	-22.50	-20.40	L1
0.4083	41.58	33.63	0.20	41.78	33.83	57.68	47.68	-15.90	-13.85	L1
0.5671	33.95	21.90	0.20	34.15	22.10	56.00	46.00	-21.85	-23.90	L1
15.3883	22.96	17.31	0.75	23.71	18.06	60.00	50.00	-36.29	-31.94	L1
0.1573	49.05	28.65	0.19	49.24	28.84	65.61	55.61	-16.37	-26.77	L2
0.1660	46.87	25.17	0.19	47.06	25.36	65.16	55.16	-18.10	-29.80	L2
0.2020	39.06	30.63	0.19	39.25	30.82	63.53	53.53	-24.28	-22.71	L2
0.3820	40.01	29.77	0.20	40.21	29.97	58.24	48.24	-18.03	-18.27	L2
0.6180	36.07	26.52	0.20	36.27	26.72	56.00	46.00	-19.73	-19.28	L2
2.6940	31.97	20.46	0.16	32.13	20.62	56.00	46.00	-23.87	-25.38	L2

**Remark:**

- The measuring frequencies range between 0.15 MHz and 30 MHz.*
- The emissions measured in the frequency range between 0.15 MHz and 30MHz were made with an instrument using Quasi-peak detector and Average detector.*
- The IF bandwidth of SPA between 0.15MHz and 30MHz was 10kHz. The IF bandwidth of Test Receiver between 0.15MHz and 30MHz was 9kHz.*
- L1 = Line One (Live Line) / L2 = Line Two (Neutral Line)*
- "-" means Quasi-peak reading value also meets average limit and measurement with the average detector is unnecessary.*



### Test Plots

#### Conducted emissions (Line 1)

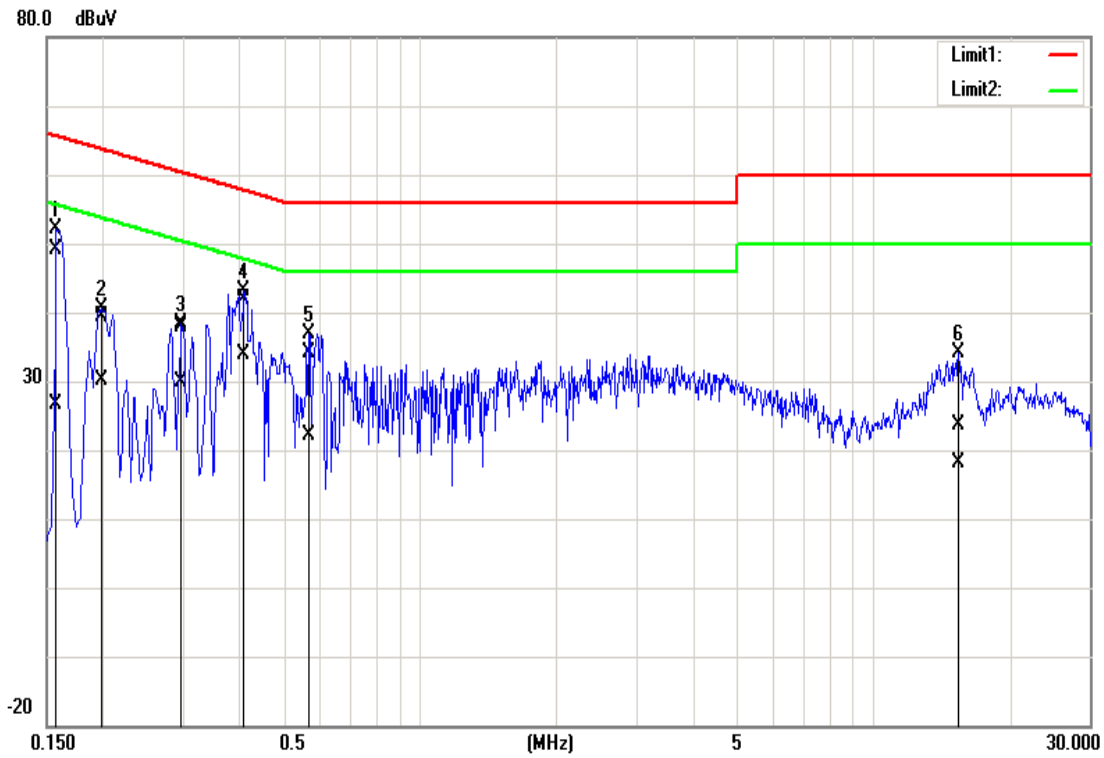

#### Conducted emissions (Line 2)

