



Universal Global Scientific Industrial Co., Ltd.

No. 141, Lane 351, Taiping Road, Sec. 1, Tsaotuen,

Nantou County 54261, Taiwan

TEL +886-49-221-2700

FAX +886-49-232-9561

HOOK-REV3.0 Module User's Manual



Universal Global Scientific Industrial Co., Ltd.
No. 141, Lane 351, Taiping Road, Sec. 1, Tsaotuen,
Nantou County 54261, Taiwan
TEL +886-49-221-2700
FAX +886-49-232-9561

The HOOK-REV3.0 module complies with the following features and standards:

Features	Description
WLAN Standards	IEEE 802 11b/g/n
Frequency Band	2.400 GHz – 2.484 GHz
Number of Sub Channels	CH1 to CH14
Modulation	DSSS, CCK, OFDM, BPSK, QPSK, 16QAM, 64QAM
Supported data rates	11b 1, 2, 5.5, 11 (Mbps)
	11g 6,9,12, 18,24 ,36, 48, 54 (Mbps)
	11n HT20 MCS0 (6.5Mbps) to MCS7 (65Mbps)

Power supply for the HOOK-REV3.0 module will be provided as below:

Symbol	Parameter	Min	Typ.	Max	Unit
VBAT	DC supply voltage for WiFi VBAT	3.2	3.6	4.2	V
BT-VBAT	DC supply voltage for BT VBAT	2.0	3.3	3.5	V
VIO	DC supply voltage for digital I/O	1.76	3.3	3.5	V
VDD_FEM	DC supply voltage for FEM	3.0	3.3	3.6	V

The HOOK-REV3.0 module has to withstand the operational requirements as listed in the table below.

Operating Temperature	-20° to 65° Celsius	
Relative Humidity Range	Max 85%	Non condensing, relative humidity

User Guide

WiFi User Mode

1. Power Supply set to 3.8V
2. Set up diagram as below:

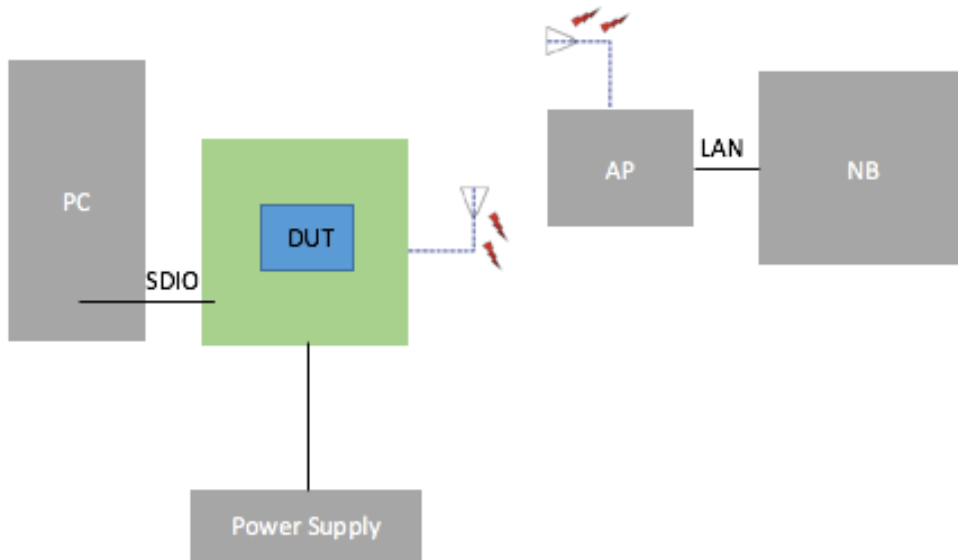

3. Power supply turn on and insert SDIO cable to PC
4. Open terminal (ctrl+alt+T) and enter command “dmesg” to confirm if the device is recognized.
5. If your device is recognized and please enter the commands by step as following:

- 1) sudo su
- 2) cd ..
- 3) cd ..
- 4) cd usr/local/custom/EMC/Kelly/HOOK
- 5) ls

```
bt_usr.sh      list_fw.sh    restartBluetool.sh  wifi_bringup.sh
cywdhd_4.2.ko  mybluetool   txrx_test
```

6. Enter command “sh list_fw.sh HOOK”.
It will show MFG & user mode FW and NVram as below:



```
root@ubuntu: /usr/local/custom/EMC/Kelly/HOOK
TO), (N/A, 2000 mBm), (0 s)
[ 120.992681] cfg80211: (5490000 KHz - 5730000 KHz @ 160000 KHz), (N/A, 2000
mBm), (0 s)
[ 120.992682] cfg80211: (5735000 KHz - 5835000 KHz @ 80000 KHz), (N/A, 2000 m
Bm), (N/A)
[ 120.992683] cfg80211: (57240000 KHz - 63720000 KHz @ 2160000 KHz), (N/A, 0
mBm), (N/A)
root@ubuntu: /usr/local/custom/EMC/Kelly/HOOK# sh list_fw.sh HOOK
Available wifi firmware

total 768
-rw-r--r-- 1 root root 378109 Aug 17 08:19 43430_7_45_45_39_PMU33_06222018.bin
-rw-r--r-- 1 root root 407656 Aug 17 08:19 bcm43438-7.46.58.11.bin

Available wifi nvram

total 2
-rw-r--r-- 1 root root 1175 Aug 9 13:55 bcm943430wlselgs_37_4Mhz_20171226.txt

Available bt firmware

ls: cannot access '/usr/local/cypress/hcdfile/HOOK/': No such file or directory
root@ubuntu: /usr/local/custom/EMC/Kelly/HOOK# modprobe cfg80211
root@ubuntu: /usr/local/custom/EMC/Kelly/HOOK#
```

```
root@ubuntu: /usr/local/custom/EMC/Kelly/HOOK
Available wifi firmware

total 768
-rw-r--r-- 1 root root 378109 Aug 17 08:19 43430_7_45_45_39_PMU33_06222018.bin mfg FW
-rw-r--r-- 1 root root 407656 Aug 17 08:19 bcm43438-7.46.58.11.bin user mode FW

Available wifi nvram

total 2
-rw-r--r-- 1 root root 1175 Aug 9 13:55 bcm943430wlselgs_37_4Mhz_20171226.txt NVram

Available bt firmware

ls: cannot access '/usr/local/cypress/hcdfile/HOOK/': No such file or directory
root@ubuntu: /usr/local/custom/EMC/Kelly/HOOK# modprobe cfg80211
root@ubuntu: /usr/local/custom/EMC/Kelly/HOOK# ls
bt_usr.sh      list_fw.sh  restartBluetool.sh  wifi_bringup.sh
cywdhd 4.2.ko  mybluetool  txrx_test
root@ubuntu: /usr/local/custom/EMC/Kelly/HOOK# sh wifi_bringup.sh bcm43438-7.46.5
8.11.bin bcm943430wlselgs_37_4Mhz_20171226.txt enable wifi user mode command
7.10 RC323.0
wl0: Oct 29 2017 20:18:39 version 7.46.58.11 (r674582 CY) FWID 01-5071ac4a es4.c
3.n4
root@ubuntu: /usr/local/custom/EMC/Kelly/HOOK#
```

7. Enter command “sh wifi_bringup.sh bcm43438-7.46.58.11.bin
bcm943430wlselgs_27_4Mhz_20171226.txt” to enable user mode.
* command rule is “sh wifi_bringup.sh + MFG/user mode FW name + NVram name”
8. Enter command “wl up” to bring up WiFi function.



```
root@ubuntu: /usr/local/custom/EMC/Kelly/HOOK
total 768
-rw-r--r-- 1 root root 378109 Aug 17 08:19 43430_7_45_45_39_PMU33_06222018.bin
-rw-r--r-- 1 root root 407656 Aug 17 08:19 bcm43438-7.46.58.11.bin

Available wifi nvram

total 2
-rw-r--r-- 1 root root 1175 Aug  9 13:55 bcm943430wlseigs_37_4Mhz_20171226.txt

Available bt firmware

ls: cannot access '/usr/local/cypress/hcdfile/HOOK/': No such file or directory
root@ubuntu: /usr/local/custom/EMC/Kelly/HOOK# modprobe cfg80211
root@ubuntu: /usr/local/custom/EMC/Kelly/HOOK# ls
bt_usr.sh      list_fw.sh    restartBluetool.sh  wifi_bringup.sh
cywdhd 4.2.ko  mybluetool  txrx_test
root@ubuntu: /usr/local/custom/EMC/Kelly/HOOK# sh wifi_bringup.sh bcm43438-7.46.5
8.11.bin bcm943430wlseigs_37_4Mhz_20171226.txt
7.10 RC323.0
wl0: Oct 29 2017 20:18:39 version 7.46.58.11 (r674582 CY) FWID 01-5071ac4a es4.c
3.n4
root@ubuntu: /usr/local/custom/EMC/Kelly/HOOK# wl up
root@ubuntu: /usr/local/custom/EMC/Kelly/HOOK#
```

- 9. You can enter command “ifconfig” or “iwconfig” to confirm if usi0 is shown on the available list.
- 10. Enter command “wl scan” and then enter command “wl scanresults”.

It will show every SSID which you just scanned.

```
root@ubuntu: /usr/local/custom/EMC/Kelly/HOOK
Interrupt:16 Memory:df100000-df120000

lo        Link encap:Local Loopback
          inet addr:127.0.0.1  Mask:255.0.0.0
          inet6 addr: ::1/128 Scope:Host
          UP LOOPBACK RUNNING MTU:65536 Metric:1
          RX packets:1956 errors:0 dropped:0 overruns:0 frame:0
          TX packets:1956 errors:0 dropped:0 overruns:0 carrier:0
          collisions:0 txqueuelen:0
          RX bytes:144976 (144.9 KB) TX bytes:144976 (144.9 KB)

root@ubuntu: /usr/local/custom/EMC/Kelly/HOOK# iwconfig
usi0      IEEE 802.11bg  ESSID:off/any
          Mode:Managed  Access Point: Not-Associated
          Retry short limit:7  RTS thr:off  Fragment thr:off
          Encryption key:off
          Power Management:on

enp0s31f6 no wireless extensions.

lo        no wireless extensions.

root@ubuntu: /usr/local/custom/EMC/Kelly/HOOK# wl scan
root@ubuntu: /usr/local/custom/EMC/Kelly/HOOK# wl scanresults
```

And you will see a lot of SSID names, please choose one you want to connect.



```
root@ubuntu: /usr/local/custom/EMC/Kelly/HOOK
root@ubuntu:/usr/local/custom/EMC/Kelly/HOOK# wl scan
root@ubuntu:/usr/local/custom/EMC/Kelly/HOOK# wl scanresults
SSID: "dlink-A360-2.4GHz"
Mode: Managed  RSSI: -41 dBm  SNR: 0 dB  noise: -98 dBm  Flags: RSSI on-c
hannel Channel: 11
BSSID: 1C:5F:2B:FA:A3:60  Capability: ESS ShortSlot RRM
Supported Rates: [ 1(b) 2(b) 5.5(b) 6 9 11(b) 12 18 24 36 48 54 ]
HT Capable:
  Chanspec: 2.4GHz channel 3 40MHz (0x1803)
  Primary channel: 1
  HT Capabilities: 40Mhz SGI20 SGI40
  Supported MCS : [ 0 1 2 3 4 5 6 7 8 9 10 11 12 13 14 15 16 17 18 19 20 2
1 22 23 32 ]
WPS: V2.0 Configured

SSID: "James"
Mode: Managed  RSSI: -85 dBm  SNR: 0 dB  noise: -98 dBm  Flags: RSSI on-c
hannel Channel: 1
BSSID: 62:F4:45:70:83:83  Capability: ESS WEP ShortSlot RRM
Supported Rates: [ 1(b) 2(b) 5.5(b) 6 9 11(b) 12 18 24 36 48 54 ]
RSN (WPA2):
  multicast cipher: AES-CCMP
  unicast ciphers(1): AES-CCMP
  AKM Suites(1): WPA2-PSK
```

11. If you want to connect to the AP and its SSID is dlink-A360-2.4GHz, please enter command “wl join dlink-A360-2.4GHz” to connect the AP.

```
root@ubuntu: /usr/local/custom/EMC/Kelly/HOOK
Mode: Managed  RSSI: -82 dBm  SNR: 0 dB  noise: -98 dBm  Flags: RSSI on-c
hannel Channel: 11
BSSID: A2:B0:3D:5E:4B:7A  Capability: ESS WEP ShortSlot RRM
Supported Rates: [ 1(b) 2(b) 5.5(b) 6 9 11(b) 12 18 24 36 48 54 ]
RSN (WPA2):
  multicast cipher: AES-CCMP
  unicast ciphers(1): AES-CCMP
  AKM Suites(1): WPA2-PSK
  Capabilities(0x000c): No Pre-Auth, Pairwise, 16 PTK Replay Ctrs1 GTK Rep
lay Ctr
HT Capable:
  Chanspec: 2.4GHz channel 11 20MHz (0x100b)
  Primary channel: 11
  HT Capabilities: SGI20
  Supported MCS : [ 0 1 2 3 4 5 6 7 8 9 10 11 12 13 14 15 ]

SSID: "LEO_11G2"
Mode: Managed  RSSI: -95 dBm  SNR: 0 dB  noise: -98 dBm  Flags: FromBcn R
SSI on-channel Channel: 11
BSSID: 00:15:70:CF:65:9B  Capability: ESS WEP ShortSlot
Supported Rates: [ 1(b) 2(b) 5.5(b) 6 9 11(b) 12 18 24 36 48 54 ]

root@ubuntu:/usr/local/custom/EMC/Kelly/HOOK#
root@ubuntu:/usr/local/custom/EMC/Kelly/HOOK# wl join dlink-A360-2.4GHz
```



12. Enter command “dhclient usi0” to have a fixed IP.

```
root@ubuntu: /usr/local/custom/EMC/Kelly/HOOK
Primary channel: 11
HT Capabilities: SGI20
Supported MCS : [ 0 1 2 3 4 5 6 7 8 9 10 11 12 13 14 15 ]

SSID: "LEO_11G2"
Mode: Managed   RSSI: -95 dBm   SNR: 0 dB   noise: -98 dBm   Flags: FromBcn R
SSI on-channel  Channel: 11
BSSID: 00:15:70:CF:65:9B   Capability: ESS WEP ShortSlot
Supported Rates: [ 1(b) 2(b) 5.5(b) 6 9 11(b) 12 18 24 36 48 54 ]

root@ubuntu:/usr/local/custom/EMC/Kelly/HOOK#
root@ubuntu:/usr/local/custom/EMC/Kelly/HOOK# wl join dlink-A360-2.4GHz
root@ubuntu:/usr/local/custom/EMC/Kelly/HOOK# iwconfig
usi0 IEEE 802.11bg  ESSID:off/any
Mode:Managed  Access Point: Not-Associated
Retry short limit:7  RTS thr:off  Fragment thr:off
Encryption key:off
Power Management:on

enp0s31f6  no wireless extensions.

lo         no wireless extensions.

root@ubuntu:/usr/local/custom/EMC/Kelly/HOOK# dhclient usi0
```

And enter command “iwconfig” to confirm if you have already connected successfully.

```
root@ubuntu: /usr/local/custom/EMC/Kelly/HOOK
TX packets:0 errors:0 dropped:0 overruns:0 carrier:0
collisions:0 txqueuelen:1000
RX bytes:0 (0.0 B) TX bytes:0 (0.0 B)
Interrupt:16 Memory:df100000-df120000

lo      Link encap:Local Loopback
inet addr:127.0.0.1  Mask:255.0.0.0
inet6 addr: ::1/128 Scope:Host
UP LOOPBACK RUNNING MTU:65536 Metric:1
RX packets:2773 errors:0 dropped:0 overruns:0 frame:0
TX packets:2773 errors:0 dropped:0 overruns:0 carrier:0
collisions:0 txqueuelen:0
RX bytes:205441 (205.4 KB) TX bytes:205441 (205.4 KB)

usi0    Link encap:Ethernet  HWaddr 00:90:4c:c5:12:38
IP inet addr:192.168.0.164 Bcast:192.168.0.255 Mask:255.255.255.0
inet6 addr: fe80::290:4cff:fec5:1238/64 Scope:Link
UP BROADCAST RUNNING MULTICAST MTU:1500 Metric:1
RX packets:140 errors:0 dropped:22 overruns:0 frame:0
TX packets:151 errors:0 dropped:0 overruns:0 carrier:0
collisions:0 txqueuelen:1000
RX bytes:10127 (10.1 KB) TX bytes:15185 (15.1 KB)

root@ubuntu:/usr/local/custom/EMC/Kelly/HOOK#
```



13. Please enter command “ping 192.168.0.1” to confirm if the connection between the device and AP is ready.

```
root@ubuntu: /usr/local/custom/EMC/Kelly/HOOK
inet6 addr: ::1/128 Scope:Host
UP LOOPBACK RUNNING MTU:65536 Metric:1
RX packets:2773 errors:0 dropped:0 overruns:0 frame:0
TX packets:2773 errors:0 dropped:0 overruns:0 carrier:0
collisions:0 txqueuelen:0
RX bytes:205441 (205.4 KB) TX bytes:205441 (205.4 KB)

usio0 Link encap:Ethernet HWaddr 00:90:4c:c5:12:38
inet addr:192.168.0.164 Bcast:192.168.0.255 Mask:255.255.255.0
inet6 addr: fe80::290:4cff:fec5:1238/64 Scope:Link
UP BROADCAST RUNNING MULTICAST MTU:1500 Metric:1
RX packets:140 errors:0 dropped:22 overruns:0 frame:0
TX packets:151 errors:0 dropped:0 overruns:0 carrier:0
collisions:0 txqueuelen:1000
RX bytes:10127 (10.1 KB) TX bytes:15185 (15.1 KB)

root@ubuntu: /usr/local/custom/EMC/Kelly/HOOK# ping 192.168.0.1
PING 192.168.0.1 (192.168.0.1) 56(84) bytes of data:
64 bytes from 192.168.0.1: icmp_seq=1 ttl=64 time=8.77 ms
64 bytes from 192.168.0.1: icmp_seq=2 ttl=64 time=9.45 ms
64 bytes from 192.168.0.1: icmp_seq=3 ttl=64 time=8.96 ms
64 bytes from 192.168.0.1: icmp_seq=4 ttl=64 time=11.3 ms
64 bytes from 192.168.0.1: icmp_seq=5 ttl=64 time=19.1 ms
```

14. Please enter command “iperf -c 192.168.0.11 -t 1000 -i 2”.
And on the other NB, please enter “iperf -s ” to start throughput testing.

```
root@ubuntu: /usr/local/custom/EMC/Kelly/HOOK
64 bytes from 192.168.0.1: icmp_seq=8 ttl=64 time=9.27 ms
64 bytes from 192.168.0.1: icmp_seq=9 ttl=64 time=7.21 ms
64 bytes from 192.168.0.1: icmp_seq=10 ttl=64 time=8.27 ms
64 bytes from 192.168.0.1: icmp_seq=11 ttl=64 time=9.77 ms
^C
--- 192.168.0.1 ping statistics ---
11 packets transmitted, 11 received, 0% packet loss, time 10014ms
rtt min/avg/max/mdev = 2.769/9.493/19.190/3.696 ms
root@ubuntu: /usr/local/custom/EMC/Kelly/HOOK# iperf -c 192.168.0.11 -t 100 -i 2

Client connecting to 192.168.0.11, TCP port 5001
TCP window size: 85.0 KByte (default)
-----
[ 3] local 192.168.0.164 port 48394 connected with 192.168.0.11 port 5001
[ ID] Interval          Transfer          Bandwidth
[ 3] 0.0- 2.0 sec      5.62 MBytes      23.6 Mbits/sec
[ 3] 2.0- 4.0 sec      5.00 MBytes      21.0 Mbits/sec
[ 3] 4.0- 6.0 sec      3.62 MBytes      15.2 Mbits/sec
[ 3] 6.0- 8.0 sec      2.25 MBytes      9.44 Mbits/sec
[ 3] 8.0-10.0 sec      4.62 MBytes      19.4 Mbits/sec
[ 3] 10.0-12.0 sec     5.62 MBytes      23.6 Mbits/sec
[ 3] 12.0-14.0 sec     5.50 MBytes      23.1 Mbits/sec
[ 3] 14.0-16.0 sec     5.62 MBytes      23.6 Mbits/sec
```

BT User Mode

1. Power supply set to 3.8V
2. Micro USB cable or UART cable are both available to control BT
3. Set up diagram as below:

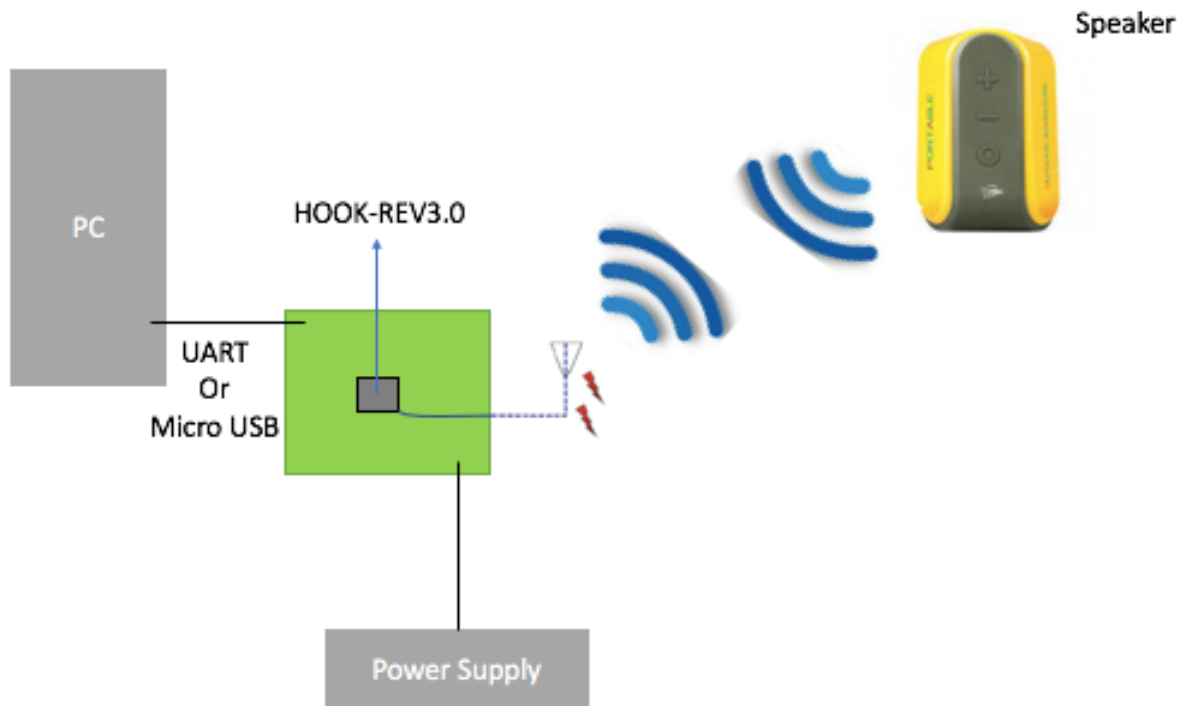

4. Power supply turn on and insert cable to PC
5. Open a terminal(T1) and enter the following command by step:
 - 1) Enter "sudo su"
 - 2) Enter command "dmesg" to confirm if the device is recognized



```
root@ubuntu: /home/ubuntu
[ 10.191935] input: HDA Intel PCH HDMI/DP,pcm=3 as /devices/pci0000:00/0000:00
:1f.3/sound/card0/input15
[ 10.191981] input: HDA Intel PCH HDMI/DP,pcm=7 as /devices/pci0000:00/0000:00
:1f.3/sound/card0/input16
[ 10.192028] input: HDA Intel PCH HDMI/DP,pcm=8 as /devices/pci0000:00/0000:00
:1f.3/sound/card0/input17
[ 10.345894] IPv6: ADDRCONF(NETDEV_UP): enp0s31f6: link is not ready
[ 10.550240] IPv6: ADDRCONF(NETDEV_UP): enp0s31f6: link is not ready
[ 186.613199] usb 1-6: new full-speed USB device number 5 using xhci_hcd
[ 186.747378] usb 1-6: New USB device found, idVendor=0403, idProduct=6001
[ 186.747385] usb 1-6: New USB device strings: Mfr=1, Product=2, SerialNumber=3
[ 186.747389] usb 1-6: Product: FT232R USB UART
[ 186.747392] usb 1-6: Manufacturer: FTDI
[ 186.747395] usb 1-6: SerialNumber: AH06P021
[ 187.771732] usbcore: registered new interface driver usbserial
[ 187.771753] usbcore: registered new interface driver usbserial_generic
[ 187.771772] usbserial: USB Serial support registered for generic
[ 187.777811] usbcore: registered new interface driver ftdi_sio
[ 187.777825] usbserial: USB Serial support registered for FTDI USB Serial Devi
ce
[ 187.777865] ftdi_sio 1-6:1.0: FTDI USB Serial Device converter detected
[ 187.777896] usb 1-6: Detected FT232RL
[ 187.778063] usb 1-6: FTDI USB Serial Device converter now attached to ttyUSB0
root@ubuntu: /home/ubuntu#
```

3) Enter command “hciattach -np /dev/ttyUSB0 any”

```
root@ubuntu: /home/ubuntu
[ 10.191981] input: HDA Intel PCH HDMI/DP,pcm=7 as /devices/pci0000:00/0000:00
:1f.3/sound/card0/input16
[ 10.192028] input: HDA Intel PCH HDMI/DP,pcm=8 as /devices/pci0000:00/0000:00
:1f.3/sound/card0/input17
[ 10.345894] IPv6: ADDRCONF(NETDEV_UP): enp0s31f6: link is not ready
[ 10.550240] IPv6: ADDRCONF(NETDEV_UP): enp0s31f6: link is not ready
[ 186.613199] usb 1-6: new full-speed USB device number 5 using xhci_hcd
[ 186.747378] usb 1-6: New USB device found, idVendor=0403, idProduct=6001
[ 186.747385] usb 1-6: New USB device strings: Mfr=1, Product=2, SerialNumber=3
[ 186.747389] usb 1-6: Product: FT232R USB UART
[ 186.747392] usb 1-6: Manufacturer: FTDI
[ 186.747395] usb 1-6: SerialNumber: AH06P021
[ 187.771732] usbcore: registered new interface driver usbserial
[ 187.771753] usbcore: registered new interface driver usbserial_generic
[ 187.771772] usbserial: USB Serial support registered for generic
[ 187.777811] usbcore: registered new interface driver ftdi_sio
[ 187.777825] usbserial: USB Serial support registered for FTDI USB Serial Devi
ce
[ 187.777865] ftdi_sio 1-6:1.0: FTDI USB Serial Device converter detected
[ 187.777896] usb 1-6: Detected FT232RL
[ 187.778063] usb 1-6: FTDI USB Serial Device converter now attached to ttyUSB0
root@ubuntu: /home/ubuntu# hciattach -np /dev/ttyUSB0 any
Device setup complete
```

6. Open a terminal(T2) and enter the following command by step:

- 1) Enter "sudo su"
- 2) Enter command "hcitool -i hci0 cmd 0x03 0x03"

```
root@ubuntu: /home/ubuntu
ubuntu@ubuntu:~$ sudo su
root@ubuntu:/home/ubuntu# hcitool -i hci0 cmd 0x03 0x03
< HCI Command: ogf 0x03, ocf 0x0003, plen 0
> HCI Event: 0x0e plen 4
  01 03 0C 00
root@ubuntu:/home/ubuntu#
```

- 3) Enter command "hcitool -i hci0 cmd 0x3f 0x18 0x00 0x00 0x00 0x08 0x07 0x00"

```
root@ubuntu: /home/ubuntu
ubuntu@ubuntu:~$ sudo su
root@ubuntu:/home/ubuntu# hcitool -i hci0 cmd 0x03 0x03
< HCI Command: ogf 0x03, ocf 0x0003, plen 0
> HCI Event: 0x0e plen 4
  01 03 0C 00
root@ubuntu:/home/ubuntu# hcitool -i hci0 cmd 0x3f 0x18 0x00 0x00 0x00 0x08 0x07 0x00
0x00
< HCI Command: ogf 0x3f, ocf 0x0018, plen 6
  00 00 00 08 07 00
> HCI Event: 0x0e plen 4
  01 18 FC 00
root@ubuntu:/home/ubuntu#
```

7. Go back to T1 and enter ctrl+c, then enter command “hciattach -np /dev/ttyUSB0 any 460800”

```
root@ubuntu: /home/ubuntu
[ 10.192028] input: HDA Intel PCH HDMI/DP,pcm=8 as /devices/pci0000:00/0000:00:1f.3/sound/card0/input17
[ 10.345894] IPv6: ADDRCONF(NETDEV_UP): enp0s31f6: link is not ready
[ 10.550240] IPv6: ADDRCONF(NETDEV_UP): enp0s31f6: link is not ready
[ 186.613199] usb 1-6: new full-speed USB device number 5 using xhci_hcd
[ 186.747378] usb 1-6: New USB device found, idVendor=0403, idProduct=6001
[ 186.747385] usb 1-6: New USB device strings: Mfr=1, Product=2, SerialNumber=3
[ 186.747389] usb 1-6: Product: FT232R USB UART
[ 186.747392] usb 1-6: Manufacturer: FTDI
[ 186.747395] usb 1-6: SerialNumber: AH06P021
[ 187.771732] usbcore: registered new interface driver usbserial
[ 187.771753] usbcore: registered new interface driver usbserial_generic
[ 187.771772] usbserial: USB Serial support registered for generic
[ 187.777811] usbcore: registered new interface driver ftdi_sio
[ 187.777825] usbserial: USB Serial support registered for FTDI USB Serial Device
[ 187.777865] ftdi_sio 1-6:1.0: FTDI USB Serial Device converter detected
[ 187.777896] usb 1-6: Detected FT232RL
[ 187.778063] usb 1-6: FTDI USB Serial Device converter now attached to ttyUSB0
root@ubuntu:/home/ubuntu# hciattach -np /dev/ttyUSB0 any
Device setup complete
^Croot@ubuntu:/home/ubuntu# hciattach -np /dev/ttyUSB0 any 460800
Device setup complete
```

8. On the left top corner : search your computer "bluetooth manager", after bluetooth manager window pops out, click “search”.



9. When the device you want to pair is shown on the list, then right click to perform “pair”.
After pair successfully, right click again and select “connect to audio sink”



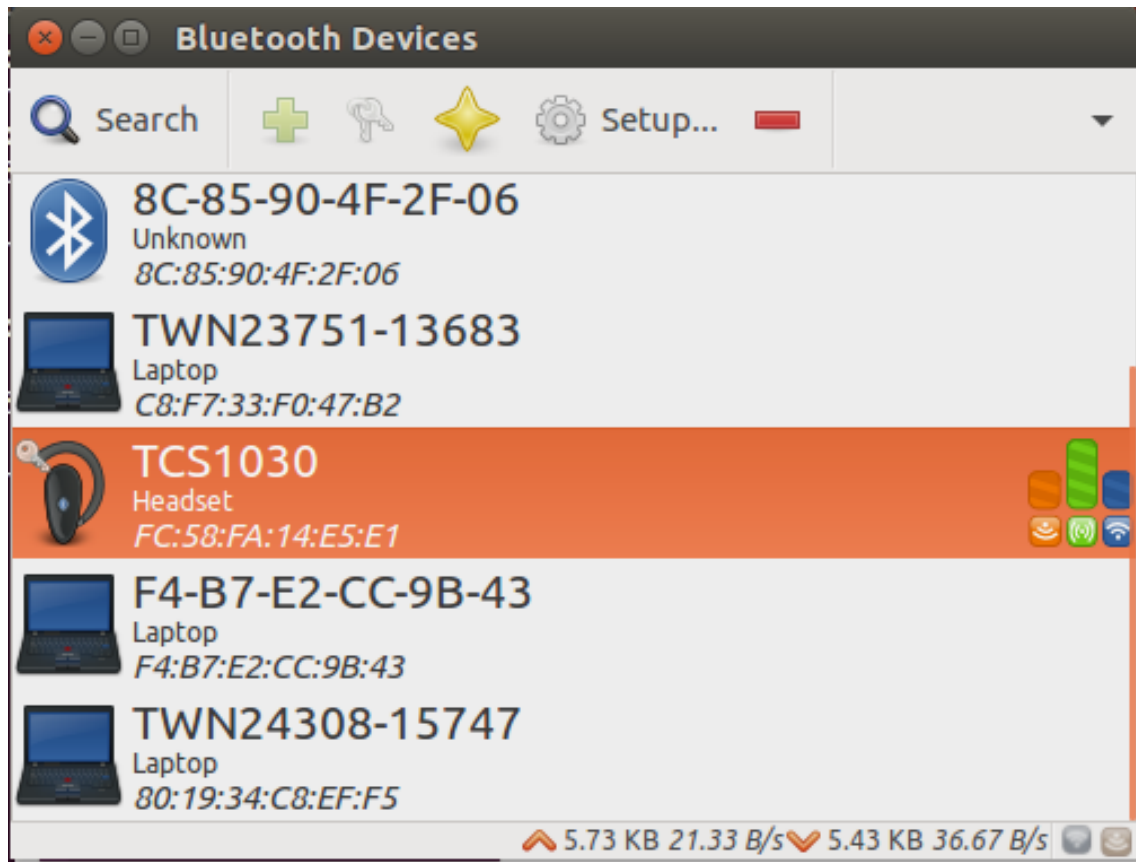

10. Open a terminal(T3) and enter the following command by step:

1) Enter command "pacmd stat",

→ You will see Default sink name is NOT the device you just paired

```
ubuntu@ubuntu: ~
ubuntu@ubuntu:~$ pacmd stat
Memory blocks currently allocated: 2, size: 391.0 KiB.
Memory blocks allocated during the whole lifetime: 889, size: 24.1 MiB.
Memory blocks imported from other processes: 0, size: 0 B.
Memory blocks exported to other processes: 0, size: 0 B.
Total sample cache size: 327.1 KiB.
Default sample spec: s16le 2ch 44100Hz
Default channel map: front-left,front-right
Default sink name: alsa_output.pci-0000_00_1f.3.analog-stereo
Default source name: alsa_input.pci-0000_00_1f.3.analog-stereo
Memory blocks of type POOL: 1 allocated/225 accumulated.
Memory blocks of type POOL_EXTERNAL: 0 allocated/0 accumulated.
Memory blocks of type APPENDED: 1 allocated/1 accumulated.
Memory blocks of type USER: 0 allocated/0 accumulated.
Memory blocks of type FIXED: 0 allocated/656 accumulated.
Memory blocks of type IMPORTED: 0 allocated/7 accumulated.
ubuntu@ubuntu:~$
```

2) Enter command “ pactl list sinks short” to confirm all the device

→ Please remember the device you just paired

```
ubuntu@ubuntu: ~
ubuntu@ubuntu:~$ pacmd stat
Memory blocks currently allocated: 2, size: 391.0 KiB.
Memory blocks allocated during the whole lifetime: 889, size: 24.1 MiB.
Memory blocks imported from other processes: 0, size: 0 B.
Memory blocks exported to other processes: 0, size: 0 B.
Total sample cache size: 327.1 KiB.
Default sample spec: s16le 2ch 44100Hz
Default channel map: front-left,front-right
Default sink name: alsa_output.pci-0000_00_1f.3.analog-stereo
Default source name: alsa_input.pci-0000_00_1f.3.analog-stereo
Memory blocks of type POOL: 1 allocated/225 accumulated.
Memory blocks of type POOL_EXTERNAL: 0 allocated/0 accumulated.
Memory blocks of type APPENDED: 1 allocated/1 accumulated.
Memory blocks of type USER: 0 allocated/0 accumulated.
Memory blocks of type FIXED: 0 allocated/656 accumulated.
Memory blocks of type IMPORTED: 0 allocated/7 accumulated.
ubuntu@ubuntu:~$ pactl list sinks short
0      alsa_output.pci-0000_00_1f.3.analog-stereo      module-alsa-card.c      s
16le 2ch 48000Hz          SUSPENDED
1      bluez_sink.FC_58_FA_14_E5_E1      module-bluez5-device.c  s16le 1ch 8000Hz
SUSPENDED
ubuntu@ubuntu:~$
```

This is the device you just paired and please remember this number

- 3) Enter command “pacmd set-default-sink 1” to select your device, then enter command “pacmd stat” to confirm again if Default sink name us your device you just paired.

```
ubuntu@ubuntu: ~  
Memory blocks of type IMPORTED: 0 allocated/7 accumulated.  
ubuntu@ubuntu:~$ pactl list sinks short  
0      alsa_output.pci-0000_00_1f.3.analog-stereo    module-alsa-card.c    s  
16le 2ch 48000Hz          SUSPENDED  
1      bluez_sink.FC_58_FA_14_E5_E1    module-bluez5-device.c s16le 1ch 8000Hz  
SUSPENDED  
ubuntu@ubuntu:~$ pacmd set-default-sink 1  
ubuntu@ubuntu:~$ pacmd stat  
Memory blocks currently allocated: 2, size: 391.0 KiB.  
Memory blocks allocated during the whole lifetime: 1193, size: 32.0 MiB.  
Memory blocks imported from other processes: 0, size: 0 B.  
Memory blocks exported to other processes: 0, size: 0 B.  
Total sample cache size: 327.1 KiB.  
Default sample spec: s16le 2ch 44100Hz  
Default channel map: front-left,front-right  
Default sink name: bluez_sink.FC_58_FA_14_E5_E1  
Default source name: alsa_input.pci-0000_00_1f.3.analog-stereo  
Memory blocks of type POOL: 1 allocated/305 accumulated.  
Memory blocks of type POOL_EXTERNAL: 0 allocated/0 accumulated.  
Memory blocks of type APPENDED: 1 allocated/1 accumulated.  
Memory blocks of type USER: 0 allocated/0 accumulated.  
Memory blocks of type FIXED: 0 allocated/880 accumulated.  
Memory blocks of type IMPORTED: 0 allocated/7 accumulated.  
ubuntu@ubuntu:~$
```

11. Copy your music file to Home directly. Please note the file format must be .wav

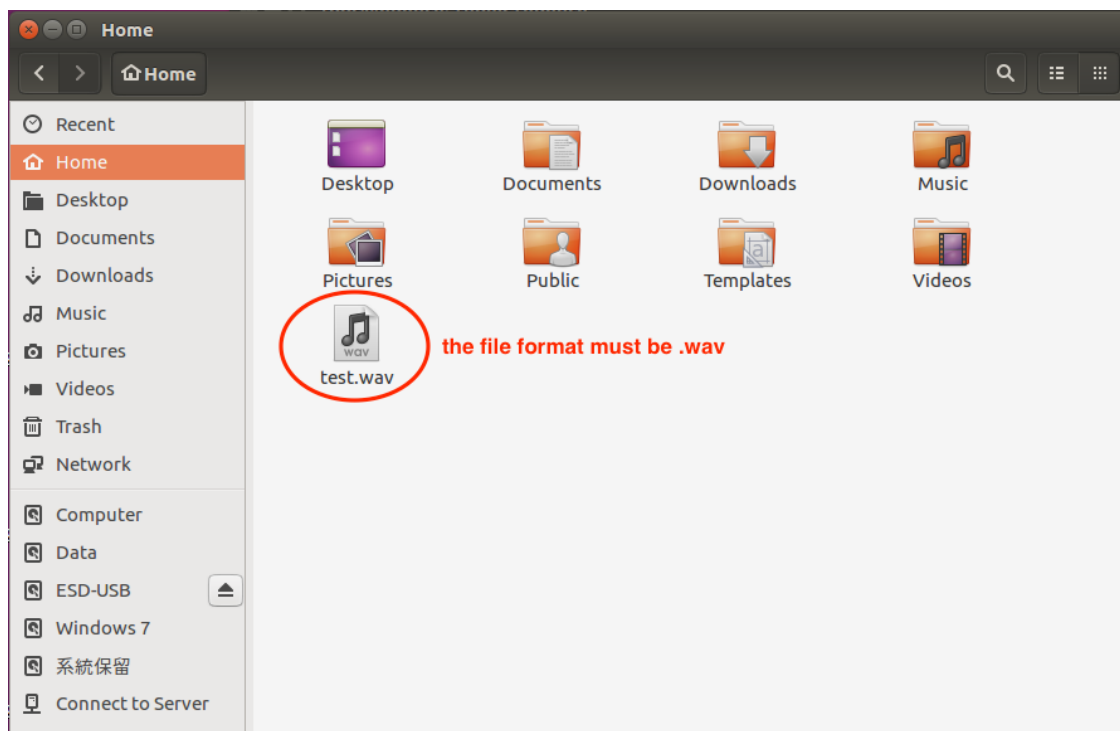



Universal Global Scientific Industrial Co., Ltd.
No. 141, Lane 351, Taiping Road, Sec. 1, Tsaotuen,
Nantou County 54261, Taiwan
TEL +886-49-221-2700
FAX +886-49-232-9561

12. Go T3 and play music, please enter command “aplay test.wav” and confirm sound settings as below:

```
ubuntu@ubuntu: ~  
Memory blocks of type IMPORTED: 0 allocated/7 accumulated.  
ubuntu@ubuntu:~$ pactl list sinks short  
0      alsa_output.pci-0000_00_1f.3.analog-stereo      module-alsa-card.c      s  
16le 2ch 48000Hz          SUSPENDED  
1      bluez_sink.FC_58_FA_14_E5_E1      module-bluetooth-device.c  s16le 1ch 8000Hz  
SUSPENDED  
ubuntu@ubuntu:~$ pacmd set-default-sink 1  
ubuntu@ubuntu:~$ pacmd stat  
Memory blocks currently allocated: 2, size: 391.0 KiB.  
Memory blocks allocated during the whole lifetime: 1193, size: 32.0 MiB.  
Memory blocks imported from other processes: 0, size: 0 B.  
Memory blocks exported to other processes: 0, size: 0 B.  
Total sample cache size: 327.1 KiB.  
Default sample spec: s16le 2ch 44100Hz  
Default channel map: front-left,front-right  
Default sink name: bluez_sink.FC_58_FA_14_E5_E1  
Default source name: alsa_input.pci-0000_00_1f.3.analog-stereo  
Memory blocks of type POOL: 1 allocated/305 accumulated.  
Memory blocks of type POOL_EXTERNAL: 0 allocated/0 accumulated.  
Memory blocks of type APPENDED: 1 allocated/1 accumulated.  
Memory blocks of type USER: 0 allocated/0 accumulated.  
Memory blocks of type FIXED: 0 allocated/880 accumulated.  
Memory blocks of type IMPORTED: 0 allocated/7 accumulated.  
ubuntu@ubuntu:~$ aplay test.wav
```

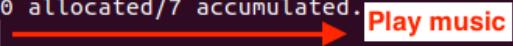

FCC ID: COFHOOKEV3**FCC Statement**

This device complies with Part 15 of the FCC Rules. Operation is subject to the following two conditions: (1) This device may not cause harmful interference, and (2) this device must accept any interference received, including interference that may cause undesired operation.

FCC Caution: Any changes or modifications not expressly approved by the party responsible for compliance could void the user's authority to operate this equipment.

This device and its antenna(s) must not be co-located or operating in conjunction with any other antenna or transmitter.

FCC Radiation Exposure Statement:

This equipment complies with FCC radiation exposure limits set forth for an uncontrolled environment. This equipment should be installed and operated with minimum distance **20cm** between the radiator & your body.

IC: 10293A-HOOKREV3**Canada/ISED Statement**

This device contains licence-exempt transmitter(s)/receiver(s) that comply with Innovation, Science and Economic Development Canada's licence-exempt RSS(s). Operation is subject to the following two conditions:

1. This device may not cause interference.
2. This device must accept any interference, including interference that may cause undesired operation of the device.

L'émetteur/récepteur exempt de licence contenu dans le présent appareil est conforme aux CNR d'Innovation, Sciences et Développement économique Canada applicables aux appareils radio exempts de licence. L'exploitation est autorisée aux deux conditions suivantes :

1. L'appareil ne doit pas produire de brouillage;
2. L'appareil doit accepter tout brouillage radioélectrique subi, même si le brouillage est susceptible d'en compromettre le fonctionnement.

The transmitter module may not be co-located with any other transmitter or antenna.
Le module émetteur peut ne pas être coïmplanté avec un autre émetteur ou antenne.

The Country Code Selection feature is disabled for products marketed in the US/Canada

For product available in the USA/Canada market, only channel 1~11 can be operated. Selection of other channels is not possible.

Pour les produits disponibles aux États-Unis / Canada du marché, seul le canal 1 à 11 peuvent être exploités. Sélection d'autres canaux n'est pas possible.

IC Radiation Exposure Statement:

This equipment complies with IC RSS-102 radiation exposure limits set forth for an uncontrolled environment. This equipment should be installed and operated with minimum distance **20cm** between the radiator & your body.

*Cet équipement est conforme aux limites d'exposition aux rayonnements IC établies pour un environnement non contrôlé. Cet équipement doit être installé et utilisé avec un minimum de **20cm** de distance entre la source de rayonnement et votre corps.*

This module is intended for OEM integrators under the following conditions:

FCC: This module is certified pursuant to two Part 15 rules sections (15.247).

Canada/ISED: This module is certified pursuant to RSS-247 rules sections.

This module has been approved to operate with the antenna types listed below, with the maximum permissible gain indicated, and must include 0.5 dB cable loss compensation.

FCC, ISED Antenna Information				
Technology	Frequency Band	Antenna Type	Model Number	Gain (dBi)
Wi-Fi	2400-2483.5MHz	MONOPOLE	ANT-2.4-CW-RAH	-2.4
BT				

The OEM integrator is still responsible for

1. ensuring that the end-user has no manual instructions to remove or install module
2. the FCC/ISED compliance requirement of the end product, which integrates this module.

Information on test modes and additional testing requirements

1. This module is restricted to integration into hosts for indoor use only.
2. This module has been approved under stand-alone configuration.
3. OEM integrator has be limited the operation channels in channel 1-11 for 2.4GHz band.
4. The separate approval is required for all other operating configurations, including portable configurations with respect to Part 2.1093 and different antenna configurations
5. The information on how to configure test modes for host product evaluation for different operational conditions for a stand-alone modular transmitter in a host, versus with multiple, simultaneously transmitting modules or other transmitters in a host can be found at KDB Publication 996369 D04.

Additional testing, Part 15 Subpart B disclaimer

Appropriate measurements (e.g. 15 B compliance) and if applicable additional equipment authorizations (e.g. SDoC) of the host product to be addressed by the integrator/manufacturer. This module is only FCC authorized for the specific rule parts 15.247 listed on the grant, and the host product manufacturer is responsible for compliance to any other FCC rules that apply to the host product as being Part 15 Subpart B compliant.

NCC Statement

1. 經型式認證合格之低功率射頻電機，非經許可，公司、商號或使用者均不得擅自變更頻率、加大功率或變更原設計之特性及功能。
2. 低功率射頻電機之使用不得影響飛航安全及干擾合法通信；經發現有干擾現象時，應立即停用，並改善至無干擾時方得繼續使用。前項合法通信，指依電信法規定作業之無線電通信。低功率射頻電機須忍受合法通信或工業、科學及醫療用電波輻射性電機設備之干擾。
3. 本模組於取得認證後將依規定於模組本體標示審驗合格標籤，並要求平台廠商於平台上標示「本產品內含射頻模組  CC XX xx LP yyy Z z」。
4. 「本公司於說明書中提供所有必要資訊以指導使用者/安裝者正確的安裝及操作」。

Label of the end product:

FCC:

The host product must be labeled in a visible area with the following " Contains FCC ID: COFHOOKREV3".

Canada/ISED:

The final end product must be labeled in a visible area with the following: "Contains IC: 10293A-HOOKREV3".

Taiwan/NCC

本模組於取得認證後將依規定於模組本體標示審驗合格標籤，並要求平台廠商於平台上標示「本產品內含射頻模組  CC XX xx LP yyy Z z」。

The user manual of the end product should include:

FCC:

Any changes or modifications not expressly approved by the party responsible for compliance could void the user's authority to operate this equipment.

The antenna(s) used for this transmitter must be installed to provide a separation distance of at least **20 cm** from all persons.

This device complies with Part 15 of the FCC Rules. Operation is subject to the following two conditions: (1) This device may not cause harmful interference, and (2) this device must accept any interference received, including interference that may cause undesired operation.

The antenna(s) used for this transmitter must not transmit simultaneously with any other antenna or transmitter.

Canada/ISED:

This device contains licence-exempt transmitter(s)/receiver(s) that comply with Innovation, Science and Economic Development Canada's licence-exempt RSS(s). Operation is subject to the following two conditions:

1. This device may not cause interference.
2. This device must accept any interference, including interference that may cause undesired operation of the device.

L'émetteur/récepteur exempt de licence contenu dans le présent appareil est conforme aux CNR d'Innovation, Sciences et Développement économique Canada applicables aux appareils radio exempts de licence. L'exploitation est autorisée aux deux conditions suivantes :

1. L'appareil ne doit pas produire de brouillage;
2. L'appareil doit accepter tout brouillage radioélectrique subi, même si le brouillage est susceptible d'en compromettre le fonctionnement.

This device is intended only for OEM integrators under the following conditions:

- 1) The antenna must be installed such that **20cm** is maintained between the antenna and users, and
- 2) The transmitter module may not be co-located with any other transmitter or antenna.

Cet appareil est conçu uniquement pour les intégrateurs OEM dans les conditions suivantes: (Pour utilisation de dispositif module)

- 1) L'antenne doit être installée de telle sorte qu'une distance de **20cm** est respectée entre l'antenne et les utilisateurs, et
- 2) Le module émetteur peut ne pas être coïmplanté avec un autre émetteur ou antenne.

Taiwan/NCC

1. 經型式認證合格之低功率射頻電機，非經許可，公司、商號或使用者均不得擅自變更頻率、加大功率或變更原設計之特性及功能。
2. 低功率射頻電機之使用不得影響飛航安全及干擾合法通信；經發現有干擾現象時，應立即停用，並改善至無干擾時方得繼續使用。前項合法通信，指依電信法規定作業之無線電通信。低功率射頻電機須忍受合法通信或工業、科學及醫療用電波輻射性電機設備之干擾。

Document No.		Rev.	1.2
Product No.	HOOK_REV3.0 EVB		
Project Code			
Model No.			

PCB Specification of EV Board For HOOK_REV3.0

SOURCE ORGANIZATION : USI/WP//RD

Kimi Chang

Prepared by :

Date : 2018-03-31

Checked by :

Date :

Approved by :

Date :

Concurrence :

Date :

Revision History				
Version No.	Revised Date	Revised by	Description	Notes
1.0	2017/06/29	Kimi Chang	Initial Release	
1.1	2017/11/03	Kimi Chang	Update layout	
1.3	2018/03/31	Kimi Chang	Update layout	

Wireless Product Business Unit / Hardware Development Division

1. Scope: This PCB SPEC is for **EV board of HOOK_REV3.0**. This document define the PCB (Printed Circuit Board) manufacturing SPEC. Due to this product are applied in wireless communication field, so all the SPEC defined in this document should be followed strictly in order to control the line impedance and parasitic effects. Any changes or modification must have written agreement of USI's engineer.
2. Gerber file : **GB_HOOK_EVB_V30_20180328_Lyly.zip**
3. PCB Thickness: 54.86mil+/- 10%
4. PCB size: Per Gerber
5. Four Layer PCB
6. PCB Material: FR4, , ϵ_r : 4.2 +/-0.2
7. Surface finish: ENIG
8. **RoHS and Halogen free compliant is necessary for all materials**
9. Layer Stack:
 - Layer 1: Component Top
 - Layer 2: GND layer
 - Layer 3: Inner layer traces/ power traces
 - Layer 4: Component Bottom

10. The PCB stack is as follows: (unit :mil)

The PCB stack is as follows: (unit :mil)	
Layer	Thickness
Solder Mask	0.7
L1	1.6
P.P	10.53
L2	0.6
Core	28
L3	0.6
PP	10.53
L4	1.6
Solder mask	0.7
Total	54.86

11. Trace width/clearance: 5mils / 5 mils

12. Via type : L1-L4 , PTH , minimum via : 10mil hole / 20mil ring

13. Impedance control is required for the following picture.

Please adjust the trace red to fit 50 ohm.

Please adjust the trace yellow to fit differential 90 ohm.

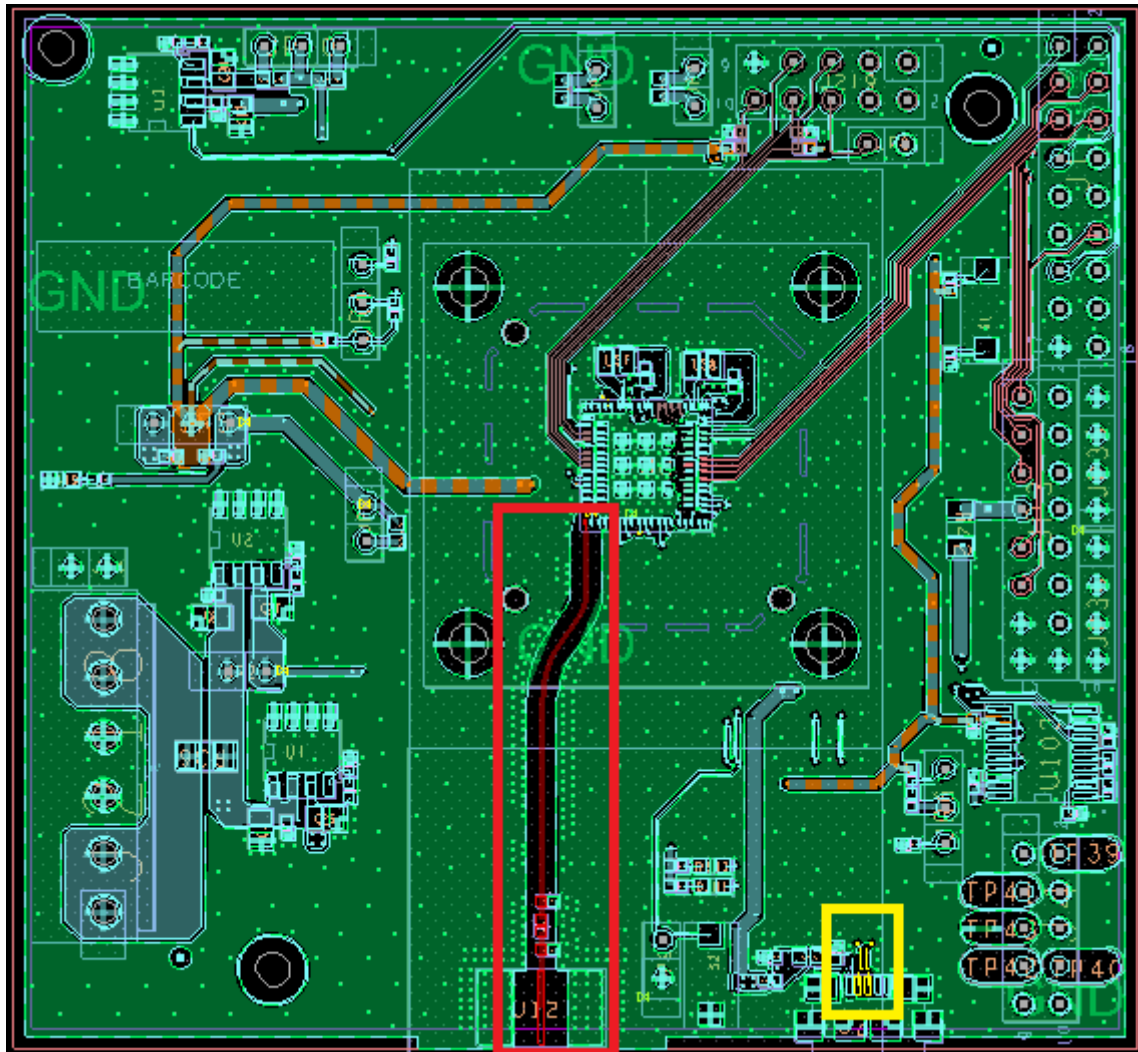

(50ohm trace: Marked in red, 1400mil length, 16mil width)

(90ohm trace: Marked in yellow)