

Intertek
731 Enterprise Drive
Lexington, KY 40510

Tel 859 226 1000
Fax 859 226 1040

www.intertek.com

Ademco Inc. TEST REPORT

SCOPE OF WORK

EMC TESTING – ADT7AIO2 HOME SECURITY PANEL

REPORT NUMBER

104517828LEX-002

ISSUE DATE

1/19/2020

PAGES

44

DOCUMENT CONTROL NUMBER

Non-Specific EMC Report Shell Rev. December 2017

© 2017 INTERTEK



EMC TEST REPORT
(FULL COMPLIANCE)

Report Number: 104517828LEX-002

Project Number: G104517828

Report Issue Date: 1/19/2020

Product Name: ADT7AIO2 Home Security Panel

Model(s) Tested: ADT7AIO2

Standards: Title 47 CFR Part 15.247

RSS-247 Issue 2

RSS-Gen Issue 5

Tested by:
Intertek Testing Services NA, Inc.
731 Enterprise Dr.
Lexington, KY 40510
USA

Client:
Ademco Inc.
2 Corporate Center Drive
Suite 100
Melville, NY 11747
USA

Report prepared by



Bryan Taylor, Team Leader

Report reviewed by



Brian Lackey, Staff Engineer

This report is for the exclusive use of Intertek's Client and is provided pursuant to the agreement between Intertek and its Client. Intertek's responsibility and liability are limited to the terms and conditions of the agreement. Intertek assumes no liability to any party, other than to the Client in accordance with the agreement, for any loss, expense or damage occasioned by the use of this report. Only the Client is authorized to copy or distribute this report and then only in its entirety. Any use of the Intertek name or one of its marks for the sale or advertisement of the tested material, product or service must first be approved in writing by Intertek. The observations and test results in this report are relevant only to the sample tested. This report by itself does not imply that the material, product, or service is or has ever been under an Intertek certification program.





Table of Contents

1 Introduction and Conclusion 4

2 Test Summary 4

3 Client Information 5

4 Description of Equipment under Test and Variant Models 6

5 System Setup and Method 7

6 Receiver Spurious Emissions 8

7 Transmitter Spurious Emissions 13

8 Output Power 21

9 Occupied Bandwidth 23

10 Power Spectral Density 34

11 Antenna Requirement 39

12 Conducted Emissions 40

13 Revision History 44



1 Introduction and Conclusion

The tests indicated in section 2.0 were performed on the product constructed as described in section 4.0. The remaining test sections are the verbatim text from the actual data sheets used during the investigation. These test sections include the test name, the specified test Method, a list of the actual Test Equipment Used, documentation Photos, Results and raw Data. No additions, deviations, or exclusions have been made from the standard(s) unless specifically noted.

Based on the results of our investigation, we have concluded the product tested **complies** with the requirements of the standard(s) indicated. The results obtained in this test report pertain only to the item(s) tested. Intertek does not make any claims of compliance for samples or variants which were not tested.

2 Test Summary

Section	Test full name	Result
6	Receiver Spurious Emissions (ANSI C63.4: 2014)	Pass
7	Transmitter Spurious Emissions (FCC Part 15.247(d), RSS-247 Issue 2 § 5.5)	Pass
8	Output Power (FCC Part 15.247(b)(3), RSS-247 Issue 2 § 5.4(d))	Pass
9	Occupied Bandwidth (FCC Part 15.247, RSS-247 Issue 2 § 5.2(a))	Pass
10	Power Spectral Density (FCC Part 15.247(e), RSS-247 Issue 2 § 5.2(b))	Pass
11	Antenna Requirement (FCC Part 15.203, RSS-Gen Issue 5 § 6.8)	Pass
12	Conducted Emissions (ANSI C63.4: 2014)	Pass



3 Client Information

This product was tested at the request of the following:

Client Information	
Client Name:	Ademco Inc.
Address:	2 Corporate Center Drive Suite 100 Melville, NY 11747 USA
Contact:	Divya Venkat
Email:	Divya.venkat@resideo.com
Manufacturer Information	
Manufacturer Name:	Ademco Inc.
Manufacturer Address:	2 Corporate Center Drive Suite 100 Melville, NY 11747 USA



4 Description of Equipment under Test and Variant Models

Equipment Under Test	
Product Name	ADT7AIO2 Home Security Panel
Model Number	ADT7AIO2
Supported Transmit Bands	Bluetooth Low Energy 2402 – 2480MHz
Receive Date	12/15/2020
Test Start Date	12/23/2020
Test End Date	12/31/2020
Device Received Condition	Good
Test Sample Type	Production
Rated Voltage	100 – 240VAC, 50/60Hz, 0.7A
Antenna	1.6dBi (this value was provided by client and may impact test results)
Description of Equipment Under Test (provided by client)	
The ADT7AIO2 Home Security Panel was a touch screen security panel with wireless connectivity.	

4.1 Variant Models:

No variant models were included with this evaluation.



5 System Setup and Method

5.1 Method:

Configuration as required by ANSI C63.4: 2014 and ANSI C63.10:2013

No.	Descriptions of EUT Exercising
1	Test commands were used to force the ADT7AIO2 Home Security Panel to transmit a Bluetooth Low Energy (BLE) signal or low, middle, or high channel.
2	Idle, not transmitting.

Cables					
ID	Description	Length (m)	Shielding	Ferrites	Termination
1	DC Power Cable	2m	None	None	AC/DC Power Adapter

Support Equipment			
Description	Manufacturer	Model Number	Serial Number
None			

5.2 EUT Block Diagram:

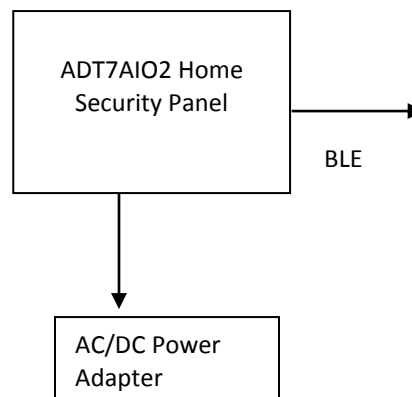



6 Receiver Spurious Emissions

6.1 Test Method

Tests are performed in accordance with ANSI C63.4: 2014

TEST SITE: 10m ALSE

Site Designation: 10m Chamber

Measurement Uncertainty

Measurement	Frequency Range	Expanded Uncertainty (k=2)	Ucisp
Radiated Emissions, 10m	30-1000 MHz	3.9dB	6.3 dB
Radiated Emissions, 3m	30-1000 MHz	4.0dB	6.3 dB
Radiated Emissions, 3m	1-6 GHz	4.7dB	5.2 dB
Radiated Emissions, 3m	6-15 GHz	4.7dB	5.5 dB
Radiated Emissions, 3m	15-18 GHz	4.7dB	5.5 dB
Radiated Emissions, 3m	18-40 GHz	4.7dB	5.5 dB

As shown in the table above our radiated emissions U_{lab} is less than the corresponding U_{CISPR} reference value in CISPR 16-4-2 Table 1, hence the compliance of the product is only based on the measured value, and no measurement uncertainty correction is required.



6.2 Sample Calculation

The field strength is calculated by adding the Antenna Factor and Cable Factor, and subtracting the Amplifier Gain (if any) from the measured reading. The basic equation with a sample calculation is as follows:

$$FS = RA + AF + CF - AG$$

Where

- FS = Field Strength in dB μ V/m
- RA = Receiver Amplitude (including preamplifier) in dB μ V
- CF = Cable Attenuation Factor in dB
- AF = Antenna Factor in dB
- AG = Amplifier Gain in dB

In the following table(s), the reading shown on the data table reflects the preamplifier gain. An example for the calculations in the following table is as follows.

Assume a receiver reading of 52.0 dB μ V is obtained. The antenna factor of 7.4 dB and cable factor of 1.6 dB is added. The amplifier gain of 29 dB is subtracted, giving a field strength of 32 dB μ V/m. This value in dB μ V/m was converted to its corresponding level in μ V/m.

RA = 52.0 dB μ V
AF = 7.4 dB/m
CF = 1.6 dB
AG = 29.0 dB
FS = 32 dB μ V/m

To convert from dB μ V to μ V or mV the following was used:

$$UF = 10^{(NF / 20)} \text{ where } UF = \text{Net Reading in } \mu\text{V}$$
$$NF = \text{Net Reading in dB}\mu\text{V}$$

Example:

$$FS = RA + AF + CF - AG = 52.0 + 7.4 + 1.6 - 29.0 = 32.0$$
$$UF = 10^{(32 \text{ dB}\mu\text{V} / 20)} = 39.8 \mu\text{V/m}$$



6.3 Test Equipment Used

Description	Asset	Manufacturer	Model	Cal Date	Cal Due
EMI Test Receiver	3900	Rohde & Schwarz	ESU40	10/5/2020	10/5/2021
Bilog Antenna (30MHz-1GHz)	7085	SunAR	JB6	9/4/2020	9/4/2021
Horn Antenna	4001	ETS	3117	1/16/2020	1/16/2021
System Controller	4096	ETS Lindgren	2090	Verify at Time of Use	Verify at Time of Use
System Controller	3957	Sunol Sciences	SC99V	Verify at Time of Use	Verify at Time of Use
3m Cable Antenna→Preamp	3074			12/21/2020	12/21/2021
3m Cable Preamplifier	3918	Rohde & Schwarz	TS-PR18	12/21/2020	12/21/2021
3m Cable Preamp→Chamber	2588			12/21/2020	12/21/2021
3m Cable Chamber→Control Room	2593			12/21/2020	12/21/2021
3m Cable Control Room→Receiver	2592			12/21/2020	12/21/2021

6.4 Software Utilized

Name	Manufacturer	Version
EMC32	Rohde & Schwarz	Version 9.15.02

6.5 Test Results

The sample tested was found to be **compliant**.

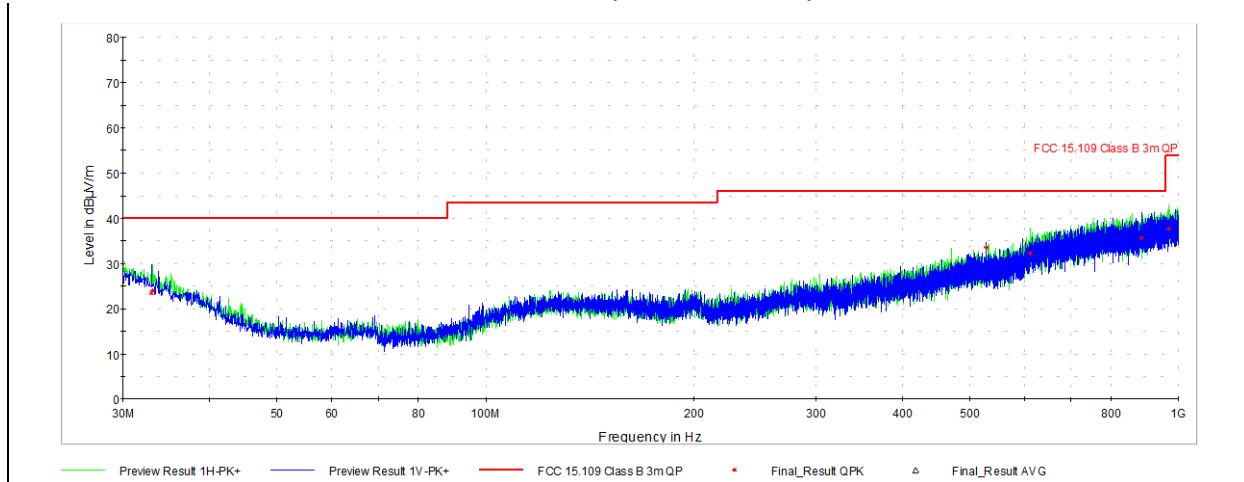
**6.6 Plots/Data: Radiated Emissions, 30MHz – 1GHz (Transmitters Idle)**

Frequency (MHz)	QuasiPeak (dBµV/m)	Limit (dBµV/m)	Margin (dB)	Bandwidth (kHz)	Height (cm)	Pol	Azimuth (deg)	Corr. (dB)
32.963889	23.41	40.00	16.59	120.000	104.3	V	331.0	25.3
33.125556	24.08	40.00	15.92	120.000	399.9	H	337.0	26.6
527.987222	33.49	46.02	12.53	120.000	105.2	V	182.0	29.8
611.083889	32.29	46.02	13.73	120.000	278.1	H	55.0	32.3
884.785556	35.61	46.02	10.41	120.000	294.4	V	304.0	35.9
969.445000	37.70	53.98	16.28	120.000	393.0	H	210.0	37.5

Test Personnel: Bryan Taylor
 Supervising/Reviewing Engineer: NA
 (Where Applicable) FCC Part 15B
 Product Standard: ICES-003 Issue 6
 Input Voltage: 120VAC / 60Hz
 Pretest Verification w / Ambient Signals or BB Source: Yes

Test Date: 12/22/2020
 Limit Applied: Class B
 Ambient Temperature: 26.3 °C
 Relative Humidity: 40.5 %
 Atmospheric Pressure: 985.3 mbar

Deviations, Additions, or Exclusions: None



6.7 Plots/Data: Radiated Emissions, 1GHz – 18GHz (Transmitters Idle)

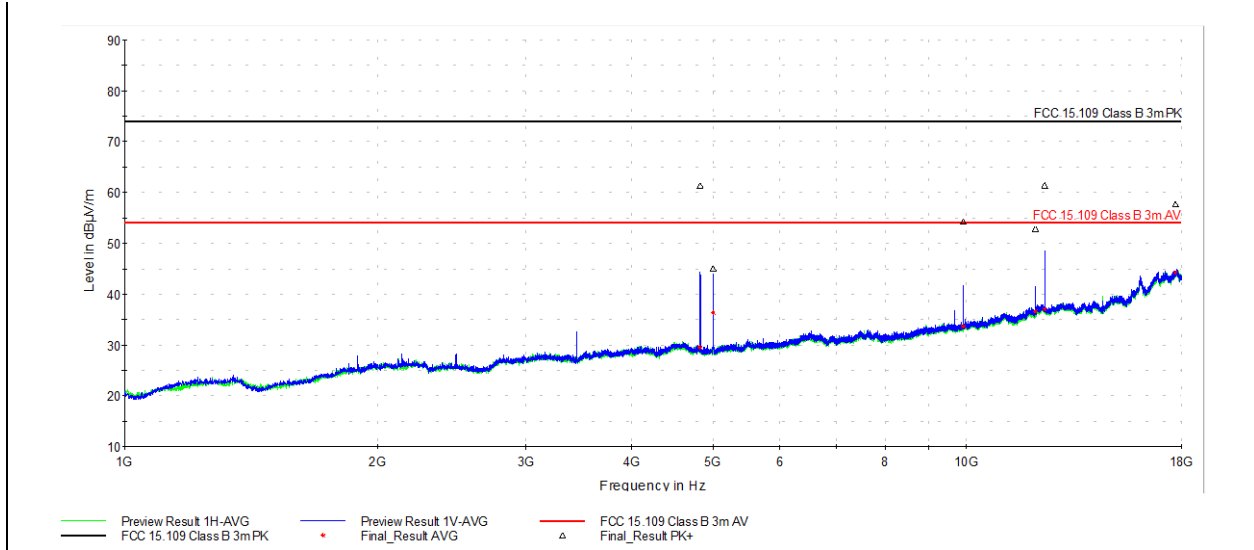

Frequency (MHz)	MaxPeak (dBµV/m)	Limit (dBµV/m)	Margin (dB)	Bandwidth (kHz)	Height (cm)	Pol	Azimuth (deg)	Corr. (dB)
4831.000000	61.34	73.98	12.64	1000.000	374.0	V	325.0	8.2
5000.000000	45.12	73.98	28.86	1000.000	192.0	V	193.0	8.3
9902.000000	54.35	73.98	19.63	1000.000	410.0	V	302.0	14.9
12077.500000	52.92	73.98	21.06	1000.000	279.0	V	78.0	17.9
12377.500000	61.46	73.98	12.52	1000.000	311.0	V	260.0	18.6
17698.000000	57.78	73.98	16.20	1000.000	410.0	H	292.0	26.2

Frequency (MHz)	Average (dBµV/m)	Limit (dBµV/m)	Margin (dB)	Bandwidth (kHz)	Height (cm)	Pol	Azimuth (deg)	Corr. (dB)
4831.000000	29.55	53.98	24.43	1000.000	374.0	V	325.0	8.2
5000.000000	36.30	53.98	17.68	1000.000	192.0	V	193.0	8.3
9902.000000	33.63	53.98	20.35	1000.000	410.0	V	302.0	14.9
12077.500000	36.56	53.98	17.42	1000.000	279.0	V	78.0	17.9
12377.500000	37.02	53.98	16.96	1000.000	311.0	V	260.0	18.6
17698.000000	44.24	53.98	9.74	1000.000	410.0	H	292.0	26.2

Test Personnel:	Bryan Taylor	Test Date:	12/22/2020
Supervising/Reviewing Engineer:	NA	Limit Applied:	Class B
(Where Applicable)	FCC Part 15B	Ambient Temperature:	26.3 °C
Product Standard:	ICES-003 Issue 6	Relative Humidity:	40.5 %
Input Voltage:	120VAC / 60Hz	Atmospheric Pressure:	985.3 mbar
Pretest Verification w / Ambient Signals or BB Source:	Yes		

Deviations, Additions, or Exclusions: None



7 Transmitter Spurious Emissions

7.1 Test Limits

FCC Part 15.247(d):

In any 100 kHz bandwidth outside the frequency band in which the spread spectrum or digitally modulated intentional radiator is operating, the radio frequency power that is produced by the intentional radiator shall be at least 20 dB below that in the 100 kHz bandwidth within the band that contains the highest level of the desired power, based on either an RF conducted or a radiated measurement, provided the transmitter demonstrates compliance with the peak conducted power limits. If the transmitter complies with the conducted power limits based on the use of RMS averaging over a time interval, as permitted under paragraph (b)(3) of this section, the attenuation required under this paragraph shall be 30 dB instead of 20 dB. Attenuation below the general limits specified in §15.209(a) is not required. In addition, radiated emissions which fall in the restricted bands, as defined in §15.205(a), must also comply with the radiated emission limits specified in §15.209(a) (see §15.205(c)).

RSS-247 Issue 2 § 5.5:

In any 100 kHz bandwidth outside the frequency band in which the spread spectrum or digitally modulated device is operating, the RF power that is produced shall be at least 20 dB below that in the 100 kHz bandwidth within the band that contains the highest level of the desired power, based on either an RF conducted or a radiated measurement, provided that the transmitter demonstrates compliance with the peak conducted power limits. If the transmitter complies with the conducted power limits based on the use of root-mean-square averaging over a time interval, as permitted under section 5.4(d), the attenuation required shall be 30 dB instead of 20 dB. Attenuation below the general field strength limits specified in RSS-Gen is not required.

7.2 Test Method

Tests are performed in accordance with ANSI C63.10:2013 § 11.12.1 Radiated emission measurements.



7.3 Test Equipment Used

Description	Asset	Manufacturer	Model	Cal Date	Cal Due
EMI Test Receiver	3900	Rohde & Schwarz	ESU40	10/5/2020	10/5/2021
Bilog Antenna (30MHz-1GHz)	7085	SunAR	JB6	9/4/2020	9/4/2021
Horn Antenna (18-40GHz)	3779	ETS	3116c	7/23/2020	7/23/2021
Horn Antenna	4001	ETS	3117	1/16/2020	1/16/2021
System Controller	4096	ETS Lindgren	2090	Verify at Time of Use	Verify at Time of Use
System Controller	3957	Sunol Sciences	SC99V	Verify at Time of Use	Verify at Time of Use
Preamplifier (18-40GHz)	3921	Rohde & Schwarz	TS-PR40	12/21/2020	12/21/2021
Coaxial Cable (40GHz)	7020			12/21/2020	12/21/2021
Coaxial Cable (40GHz)	7021			12/21/2020	12/21/2021
3m Cable Antenna→Preamp	3074			12/21/2020	12/21/2021
3m Cable Preamplifier	3918	Rohde & Schwarz	TS-PR18	12/21/2020	12/21/2021
3m Cable Preamp→Chamber	2588			12/21/2020	12/21/2021
3m Cable Chamber→Control Room	2593			12/21/2020	12/21/2021
3m Cable Control Room→Receiver	2592			12/21/2020	12/21/2021

7.4 Software Utilized

Name	Manufacturer	Version
EMC32	Rohde & Schwarz	Version 9.15.02

7.5 Test Results

The sample tested was found to be **compliant**. The data presented represents the worst case emissions with the device positioned in three orthogonal positions. All observed emissions outside of the band of operation were attenuated by at least 20dB. The frequency range from 18 – 26GHz was investigated at a 1m test distance and there were no observable spurious emissions detected.



7.6 Radiated Spurious Emissions (BLE, Low Band Edge)

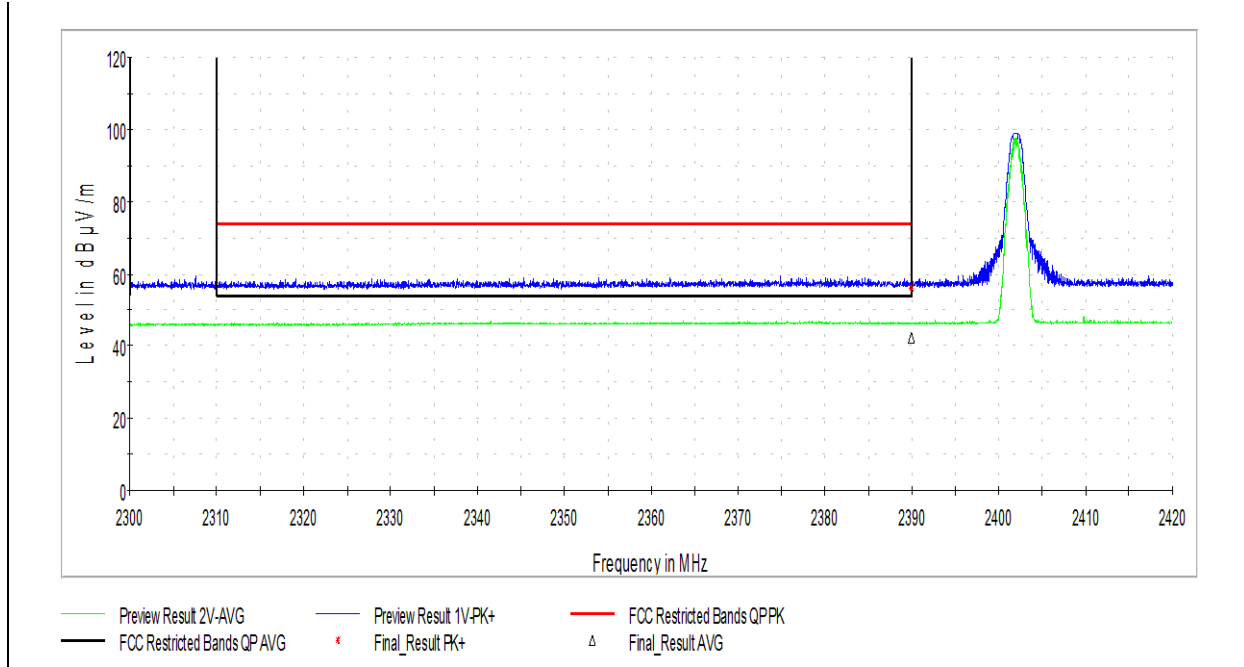

Frequency (MHz)	MaxPeak (dBµV/m)	Limit (dBµV/m)	Margin (dB)	Bandwidth (kHz)	Height (cm)	Pol	Azimuth (deg)	Corr. (dB)
2389.953846	56.01	73.98	17.97	1000.000	200.0	V	83.0	38.6

Frequency (MHz)	Average (dBµV/m)	Limit (dBµV/m)	Margin (dB)	Bandwidth (kHz)	Height (cm)	Pol	Azimuth (deg)	Corr. (dB)
2389.953846	42.35	53.98	11.63	1000.000	200.0	V	83.0	38.6

Test Personnel: Bryan Taylor
 Supervising/Reviewing Engineer: _____
 (Where Applicable) N/A
 Product Standard: FCC Part 15C, RSS-247
 Input Voltage: 120VC / 60Hz
 Pretest Verification w / Ambient Signals or BB Source: Yes

Test Date: 12/30/2020
 Limit Applied: 15.205 Restricted Bands
 Ambient Temperature: 24.3°C
 Relative Humidity: 52.8%
 Atmospheric Pressure: 987.3 mbar

Deviations, Additions, or Exclusions: None



7.7 Radiated Spurious Emissions (BLE, High Band Edge)

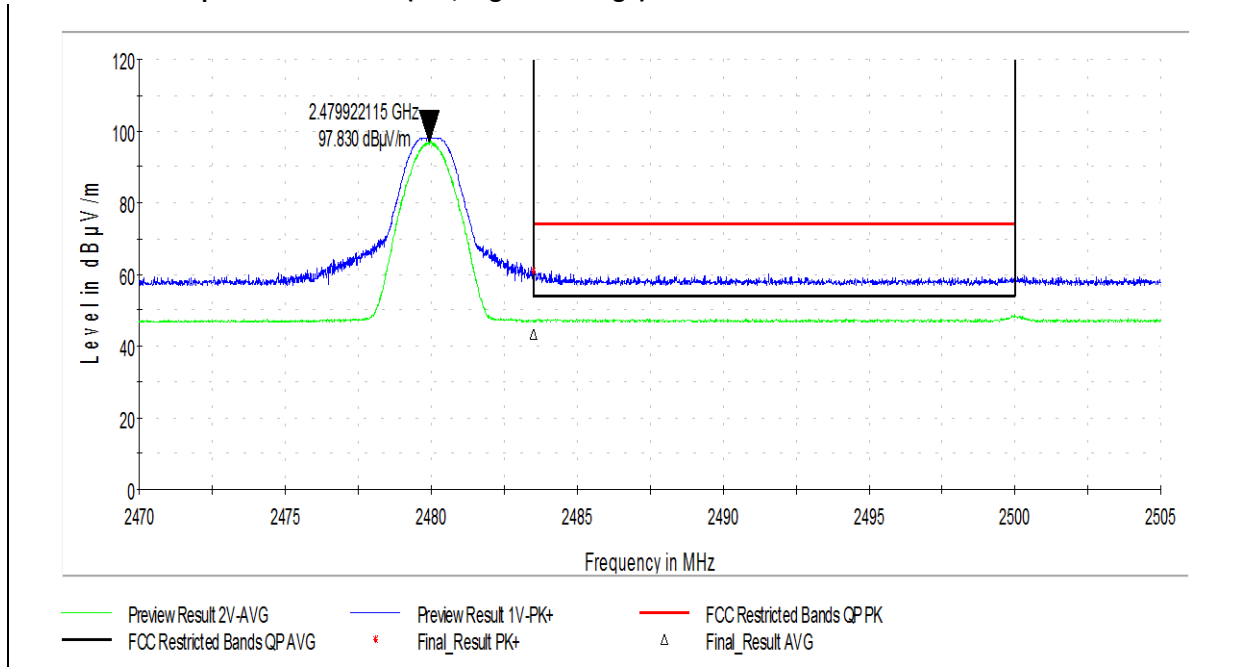

Frequency (MHz)	MaxPeak (dBµV/m)	Limit (dBµV/m)	Margin (dB)	Bandwidth (kHz)	Height (cm)	Pol	Azimuth (deg)	Corr. (dB)
2483.507692	61.05	73.98	12.93	1000.000	300.0	V	111.0	39.0

Frequency (MHz)	Average (dBµV/m)	Limit (dBµV/m)	Margin (dB)	Bandwidth (kHz)	Height (cm)	Pol	Azimuth (deg)	Corr. (dB)
2483.507692	43.55	53.98	10.43	1000.000	300.0	V	111.0	39.0

Test Personnel:	<u>Bryan Taylor</u>	Test Date:	<u>12/30/2020</u>
Supervising/Reviewing Engineer:	<u>(Where Applicable) N/A</u>	Limit Applied:	<u>15.205 Restricted Bands</u>
Product Standard:	<u>FCC Part 15C, RSS-247</u>	Ambient Temperature:	<u>24.3°C</u>
Input Voltage:	<u>120VC / 60Hz</u>	Relative Humidity:	<u>52.8%</u>
Pretest Verification w / Ambient Signals or BB Source:	<u>Yes</u>	Atmospheric Pressure:	<u>987.3 mbar</u>

Deviations, Additions, or Exclusions: None



7.8 Radiated Spurious Emissions (BLE, 30MHz – 1 GHz)

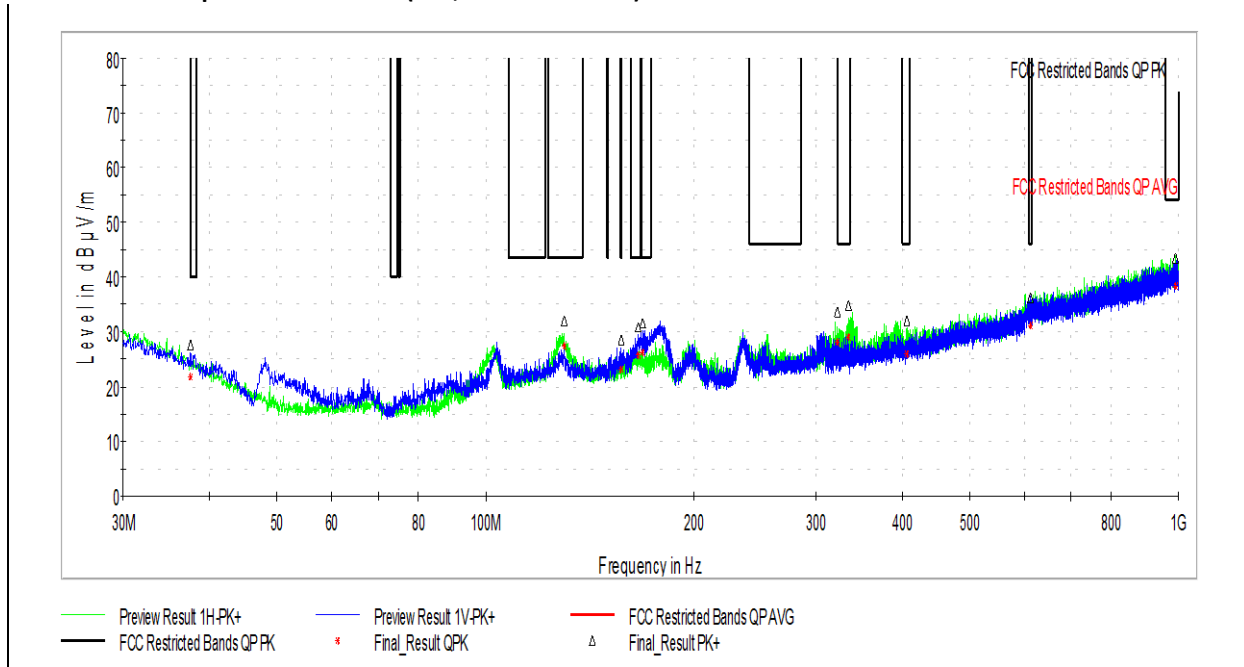

Frequency (MHz)	QuasiPeak (dBµV/m)	Limit (dBµV/m)	Margin (dB)	Bandwidth (kHz)	Height (cm)	Pol	Azimuth (deg)	Corr. (dB)
37.544445	21.73	40.00	18.27	120.000	104.4	V	341.0	22.0
129.910000	27.32	43.52	16.20	120.000	213.4	H	324.0	22.0
156.854445	23.26	43.52	20.26	120.000	101.1	V	141.0	21.7
166.285000	25.65	43.52	17.87	120.000	106.1	V	204.0	21.6
168.494445	26.16	43.52	17.36	120.000	101.6	V	210.0	21.4
322.077778	27.96	46.02	18.06	120.000	101.5	H	328.0	24.5
333.879445	29.11	46.02	16.91	120.000	101.1	H	339.0	24.8
405.713333	26.00	46.02	20.02	120.000	286.7	H	0.0	26.8
611.946111	31.15	46.02	14.87	120.000	359.5	V	10.0	31.1
989.222222	38.27	53.98	15.71	120.000	100.7	H	150.0	38.1

Test Personnel:	<u>Bryan Taylor</u>	Test Date:	<u>12/30/2020</u>
Supervising/Reviewing Engineer:	<u>N/A</u>	Limit Applied:	<u>15.205 Restricted Bands</u>
(Where Applicable)		Ambient Temperature:	<u>24.3°C</u>
Product Standard:	<u>FCC Part 15C, RSS-247</u>	Relative Humidity:	<u>52.8%</u>
Input Voltage:	<u>120VC / 60Hz</u>	Atmospheric Pressure:	<u>987.3 mbar</u>
Pretest Verification w / Ambient Signals or BB Source:	<u>Yes</u>		

Deviations, Additions, or Exclusions: Results presented represent the worst case from low, mid, and high channels



7.9 Radiated Spurious Emissions (BLE, Low Channel, 1GHz – 18GHz)

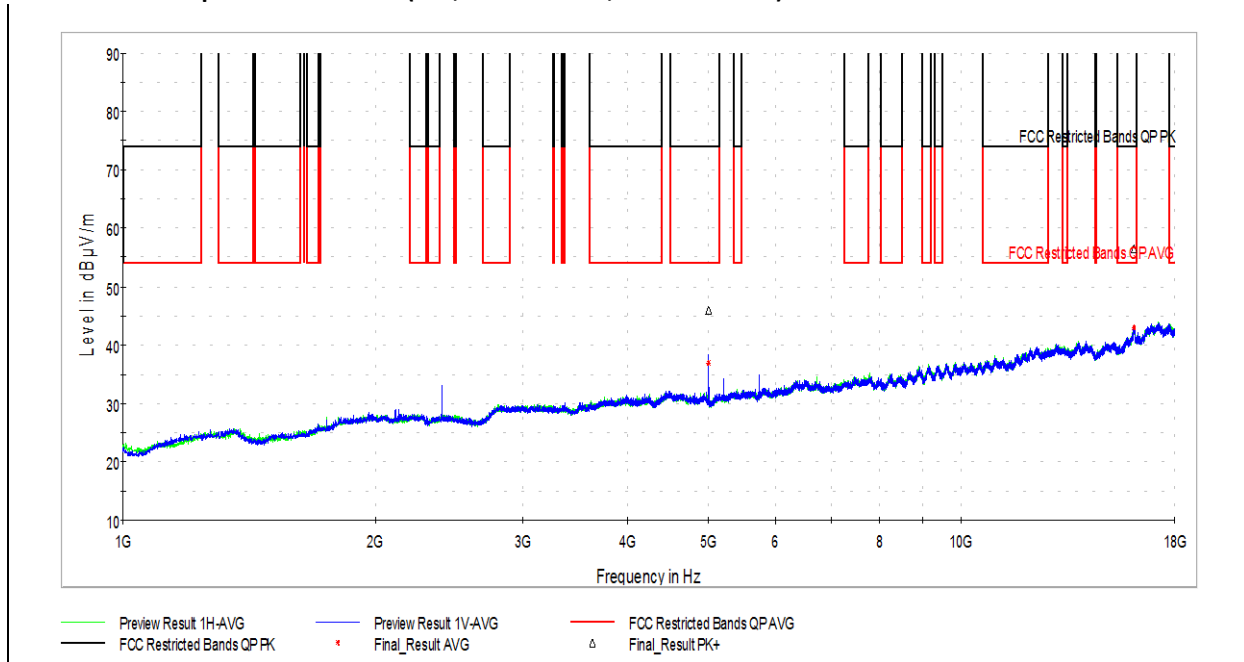

Frequency (MHz)	MaxPeak (dBµV/m)	Limit (dBµV/m)	Margin (dB)	Bandwidth (kHz)	Height (cm)	Pol	Azimuth (deg)	Corr. (dB)
5000.000000	45.99	73.98	27.99	1000.000	273.0	V	208.0	9.4
16102.000000	56.57	73.98	17.41	1000.000	326.0	H	282.0	25.3

Frequency (MHz)	Average (dBµV/m)	Limit (dBµV/m)	Margin (dB)	Bandwidth (kHz)	Height (cm)	Pol	Azimuth (deg)	Corr. (dB)
5000.000000	36.89	53.98	17.09	1000.000	273.0	V	208.0	9.4
16102.000000	42.95	53.98	11.03	1000.000	326.0	H	282.0	25.3

Test Personnel:	<u>Bryan Taylor</u>	Test Date:	<u>12/30/2020</u>
Supervising/Reviewing Engineer:	<u>N/A</u>	Limit Applied:	<u>15.205 Restricted Bands</u>
(Where Applicable)		Ambient Temperature:	<u>24.3°C</u>
Product Standard:	<u>FCC Part 15C, RSS-247</u>	Relative Humidity:	<u>52.8%</u>
Input Voltage:	<u>120VC / 60Hz</u>	Atmospheric Pressure:	<u>987.3 mbar</u>
Pretest Verification w / Ambient Signals or BB Source:	<u>Yes</u>		

Deviations, Additions, or Exclusions: None



7.10 Radiated Spurious Emissions (BLE, Mid Channel, 1GHz – 18GHz)

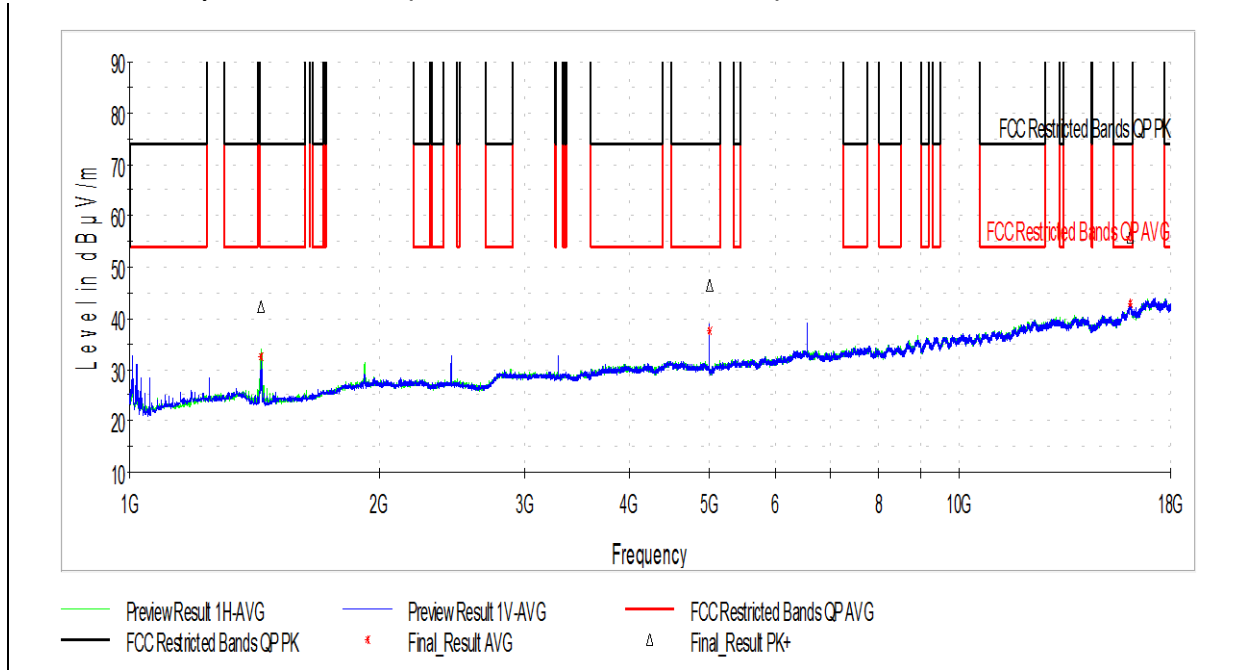

Frequency (MHz)	MaxPeak (dBµV/m)	Limit (dBµV/m)	Margin (dB)	Bandwidth (kHz)	Height (cm)	Pol	Azimuth (deg)	Corr. (dB)
1439.500000	42.31	73.98	31.67	1000.000	302.0	H	84.0	0.8
5000.000000	46.40	73.98	27.58	1000.000	213.0	V	207.0	9.4
16092.500000	56.04	73.98	17.94	1000.000	410.0	H	319.0	25.2

Frequency (MHz)	Average (dBµV/m)	Limit (dBµV/m)	Margin (dB)	Bandwidth (kHz)	Height (cm)	Pol	Azimuth (deg)	Corr. (dB)
1439.500000	32.62	53.98	21.36	1000.000	302.0	H	84.0	0.8
5000.000000	37.53	53.98	16.45	1000.000	213.0	V	207.0	9.4
16092.500000	42.88	53.98	11.10	1000.000	410.0	H	319.0	25.2

Test Personnel:	<u>Bryan Taylor</u>	Test Date:	<u>12/30/2020</u>
Supervising/Reviewing Engineer:	<u>(Where Applicable) N/A</u>	Limit Applied:	<u>15.205 Restricted Bands</u>
Product Standard:	<u>FCC Part 15C, RSS-247</u>	Ambient Temperature:	<u>24.3°C</u>
Input Voltage:	<u>120VC / 60Hz</u>	Relative Humidity:	<u>52.8%</u>
Pretest Verification w / Ambient Signals or BB Source:	<u>Yes</u>	Atmospheric Pressure:	<u>987.3 mbar</u>

Deviations, Additions, or Exclusions: None



7.11 Radiated Spurious Emissions (BLE, High Channel, 1GHz – 18GHz)

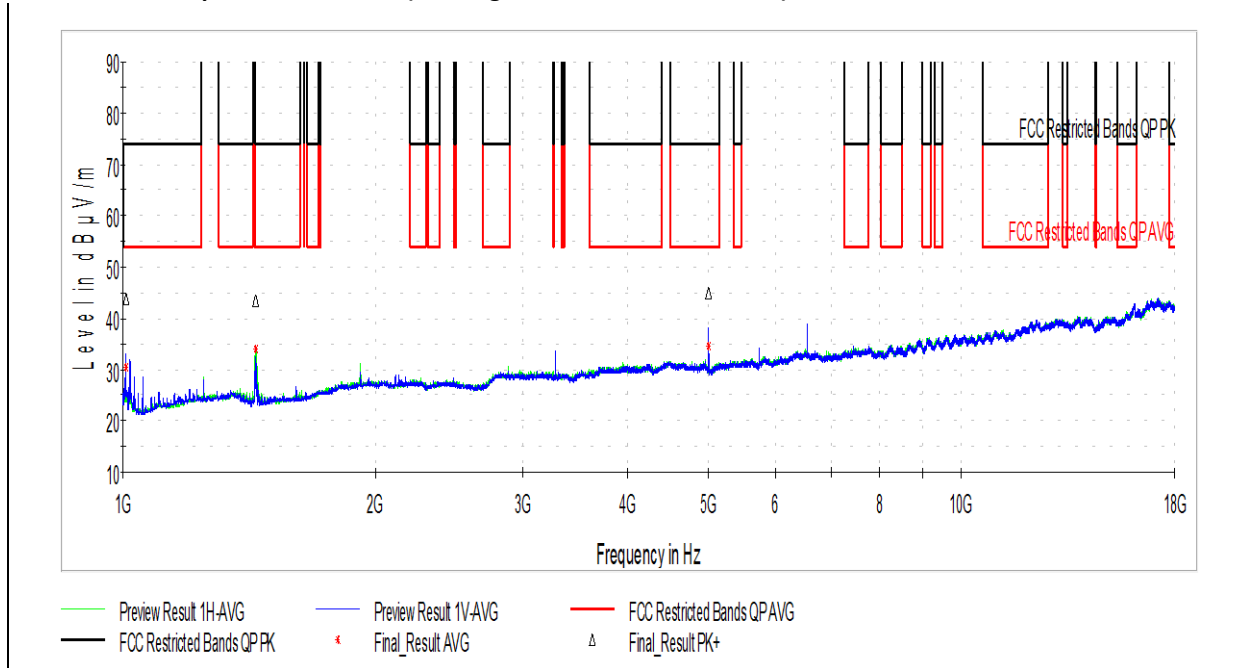

Frequency (MHz)	MaxPeak (dBµV/m)	Limit (dBµV/m)	Margin (dB)	Bandwidth (kHz)	Height (cm)	Pol	Azimuth (deg)	Corr. (dB)
1007.500000	43.79	73.98	30.19	1000.000	100.0	V	295.0	-1.6
1439.500000	43.41	73.98	30.57	1000.000	286.0	H	91.0	0.8
5000.000000	45.08	73.98	28.90	1000.000	202.0	V	204.0	9.4

Frequency (MHz)	Average (dBµV/m)	Limit (dBµV/m)	Margin (dB)	Bandwidth (kHz)	Height (cm)	Pol	Azimuth (deg)	Corr. (dB)
1007.500000	30.35	53.98	23.63	1000.000	100.0	V	295.0	-1.6
1439.500000	34.03	53.98	19.95	1000.000	286.0	H	91.0	0.8
5000.000000	34.69	53.98	19.29	1000.000	202.0	V	204.0	9.4

Test Personnel:	<u>Bryan Taylor</u>	Test Date:	<u>12/30/2020</u>
Supervising/Reviewing Engineer:	<u>(Where Applicable) N/A</u>	Limit Applied:	<u>15.205 Restricted Bands</u>
Product Standard:	<u>FCC Part 15C, RSS-247</u>	Ambient Temperature:	<u>24.3°C</u>
Input Voltage:	<u>120VC / 60Hz</u>	Relative Humidity:	<u>52.8%</u>
Pretest Verification w / Ambient Signals or BB Source:	<u>Yes</u>	Atmospheric Pressure:	<u>987.3 mbar</u>

Deviations, Additions, or Exclusions: None



8 Output Power

8.1 Test Limits

FCC Part 15.247(b)(3):

For systems using digital modulation in the 902-928 MHz, 2400-2483.5 MHz, and 5725-5850 MHz bands: 1 Watt. As an alternative to a peak power measurement, compliance with the one Watt limit can be based on a measurement of the maximum conducted output power. Maximum Conducted Output Power is defined as the total transmit power delivered to all antennas and antenna elements averaged across all symbols in the signaling alphabet when the transmitter is operating at its maximum power control level. Power must be summed across all antennas and antenna elements. The average must not include any time intervals during which the transmitter is off or is transmitting at a reduced power level. If multiple modes of operation are possible (e.g., alternative modulation methods), the maximum conducted output power is the highest total transmit power occurring in any mode.

RSS-247 Issue 2 § 5.4(d):

For DTSs employing digital modulation techniques operating in the bands 902-928 MHz and 2400-2483.5 MHz, the maximum peak conducted output power shall not exceed 1 W. The e.i.r.p. shall not exceed 4 W, except as provided in section 5.4(e).

As an alternative to a peak power measurement, compliance can be based on a measurement of the maximum conducted output power. The maximum conducted output power is the total transmit power delivered to all antennas and antenna elements, averaged across all symbols in the signalling alphabet when the transmitter is operating at its maximum power control level. Power must be summed across all antennas and antenna elements. The average must not include any time intervals during which the transmitter is off or transmitting at a reduced power level. If multiple modes of operation are implemented, the maximum conducted output power is the highest total transmit power occurring in any mode.



8.2 Test Method

Tests are performed in accordance with ANSI C63.10:2013 § 12.1.1 Annex G

8.3 Test Equipment Used

Description	Asset	Manufacturer	Model	Cal Date	Cal Due
EMI Test Receiver	3900	Rohde & Schwarz	ESU40	10/5/2020	10/5/2021
Horn Antenna	4001	ETS	3117	1/16/2020	1/16/2021
System Controller	4096	ETS Lindgren	2090	Verify at Time of Use	Verify at Time of Use
Coaxial Cable	2588			12/21/2020	12/21/2021
Coaxial Cable	2593			12/21/2020	12/21/2021
Coaxial Cable	2592			12/21/2020	12/21/2021

8.4 Test Results

The device was found to be **compliant**. The peak output power was less than 1W.

8.5 Test Conditions

Test Personnel:	<u>Bryan Taylor</u>	Test Date:	<u>12/31/2020</u>
Supervising/Reviewing Engineer: (Where Applicable)	<u>NA</u>	Limit Applied:	<u>1 Watt</u>
	<u>FCC Part 15.247</u>	Ambient Temperature:	<u>22.6C</u>
Product Standard:	<u>RSS-247 Issue 2</u>	Relative Humidity:	<u>41.2%</u>
Input Voltage:	<u>120VAC / 60Hz</u>	Atmospheric Pressure:	<u>991.2mbar</u>
Pretest Verification w / Ambient Signals or BB Source:	<u>Yes</u>		

8.6 Test Data

Frequency (MHz)	Peak Conducted Power (dBm)	Limit (dBm)	Margin (dB)	Result
2402	2.12	30	27.88	PASS
2440	1.9	30	28.1	PASS
2480	0.97	30	29.03	PASS

Note: Since the sample could not be configured for a conducted measurement, the peak output power was performed by first measuring the field strength and converting to EIRP as outlined in ANSI C63.10:2013. The antenna gain was then subtracted from the EIRP measurement to arrive at the conducted power readings shown in the table above.



9 Occupied Bandwidth

9.1 Test Limits

FCC Part 15.247(a)(2):

Systems using digital modulation techniques may operate in the 902-928 MHz, 2400-2483.5 MHz, and 5725-5850 MHz bands. The minimum 6 dB bandwidth shall be at least 500 kHz.

RSS-247 Issue 2 § 5.2(a):

The minimum 6 dB bandwidth shall be 500 kHz.

9.2 Test Method

Tests are performed in accordance with ANSI C63.10:2013 § 11.8.1.

9.3 Test Equipment Used

Description	Asset	Manufacturer	Model	Cal Date	Cal Due
EMI Test Receiver	3900	Rohde & Schwarz	ESU40	10/5/2020	10/5/2021
Horn Antenna	4001	ETS	3117	1/16/2020	1/16/2021
System Controller	4096	ETS Lindgren	2090	Verify at Time of Use	Verify at Time of Use
Coaxial Cable	2588			12/21/2020	12/21/2021
Coaxial Cable	2593			12/21/2020	12/21/2021
Coaxial Cable	2592			12/21/2020	12/21/2021



9.4 Test Results

The device was found to be **compliant**. The 6dB bandwidth was at least 500kHz.

9.5 Test Conditions

Test Personnel:	<u>Bryan Taylor</u>	Test Date:	<u>12/23/2020</u>
Supervising/Reviewing Engineer:		Limit Applied:	<u>500kHz (for 6dB bandwidth)</u>
(Where Applicable)	<u>NA</u>	Ambient Temperature:	<u>22.1C</u>
Product Standard:	<u>FCC Part 15.247</u>	Relative Humidity:	<u>47.7%</u>
	<u>RSS-247 Issue 2</u>	Atmospheric Pressure:	<u>992mbar</u>
Input Voltage:	<u>120VAC / 60Hz</u>		
Pretest Verification w / Ambient			
Signals or BB Source:	<u>Yes</u>		

9.6 Test Data

Channel	Frequency (MHz)	DTS BW (kHz)	6dB BW (kHz)	99% BW (MHz)
0	2402	741.4	625.2	1.04
39	2440	741.1	629.2	1.04
79	2480	733.4	629.2	1.04



Ref Lvl	Marker 1 [T1 ndB]	RBW	100 kHz	RF Att	0 dB	
-10 dBm	ndB	6.00 dB	VBW	300 kHz		
	BW	741.48296593 kHz	SWT	5 ms	Unit	dBm

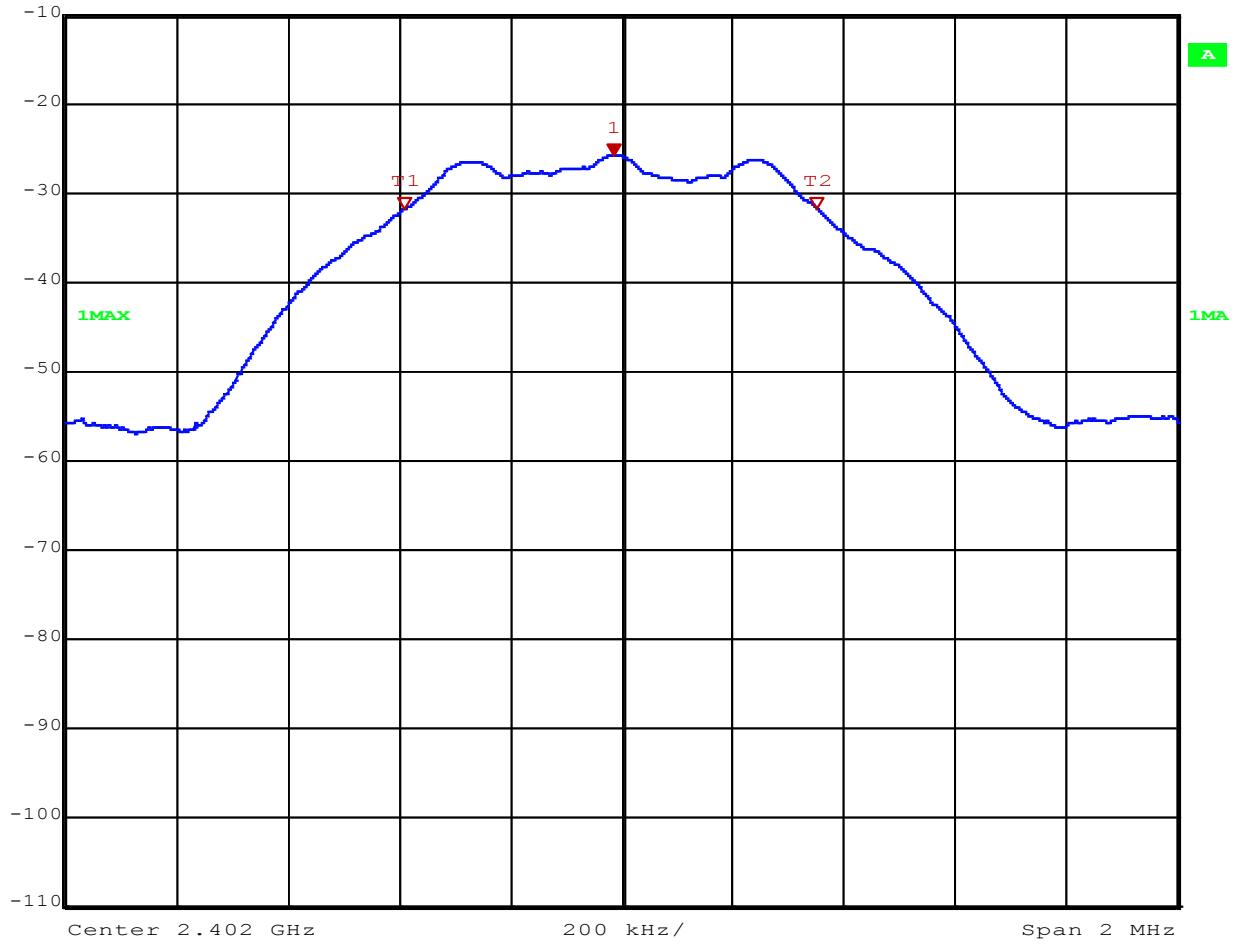

Date: 23.DEC.2020 15:35:01

DTS Bandwidth, 2402MHz



	Ref Lvl	Marker 1 [T1 ndB]	RBW	100 kHz	RF Att	0 dB	
	-10 dBm	ndB	6.00 dB	VBW	300 kHz		
		BW	741.48296593 kHz	SWT	5 ms	Unit	dBm

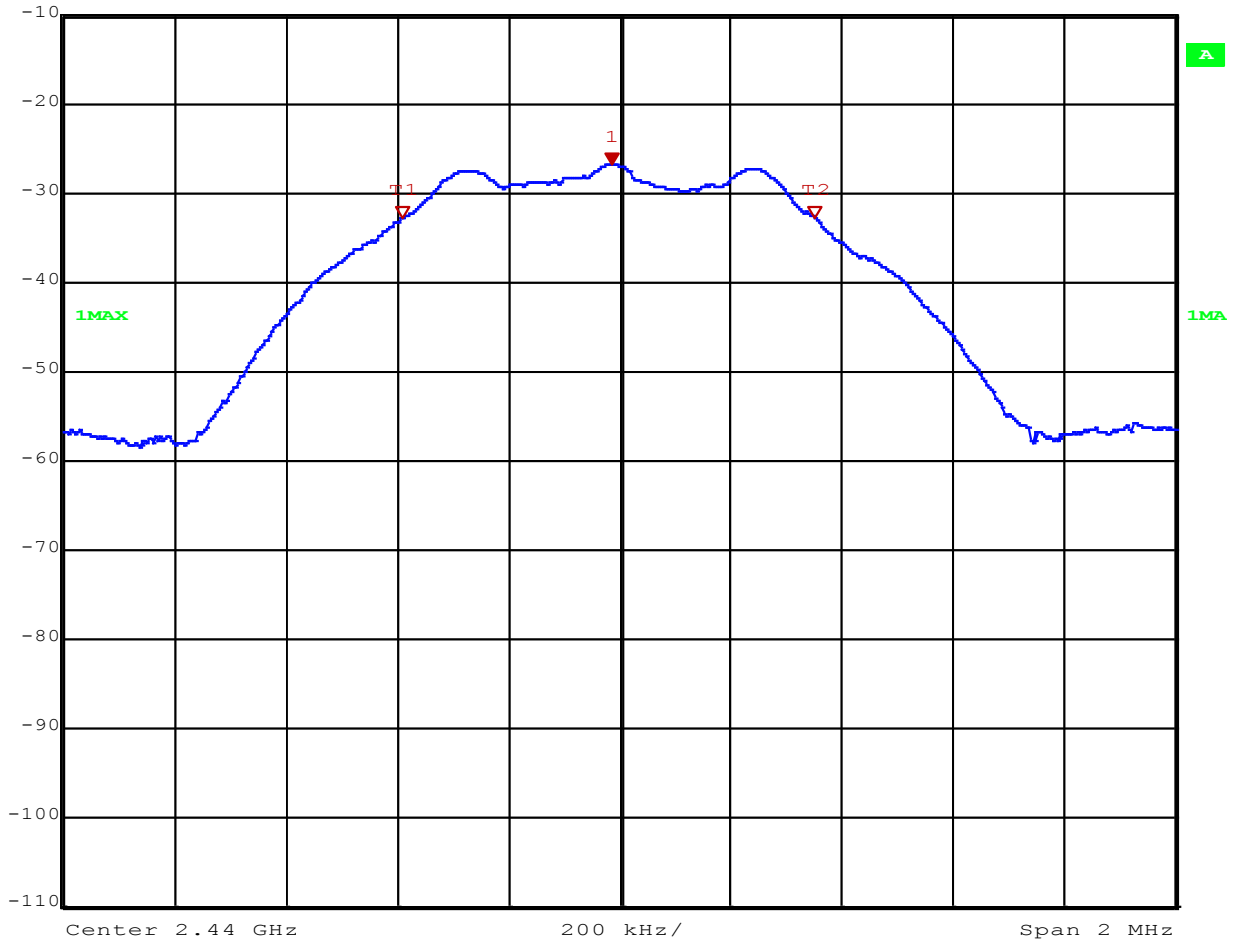

Date: 23.DEC.2020 15:36:15

DTS Bandwidth, 2440MHz



Ref Lvl	Marker 1 [T1 ndB]	RBW	100 kHz	RF Att	0 dB
-10 dBm	ndB 6.00 dB	VBW	300 kHz		
	BW 733.46693387 kHz	SWT	5 ms	Unit	dBm

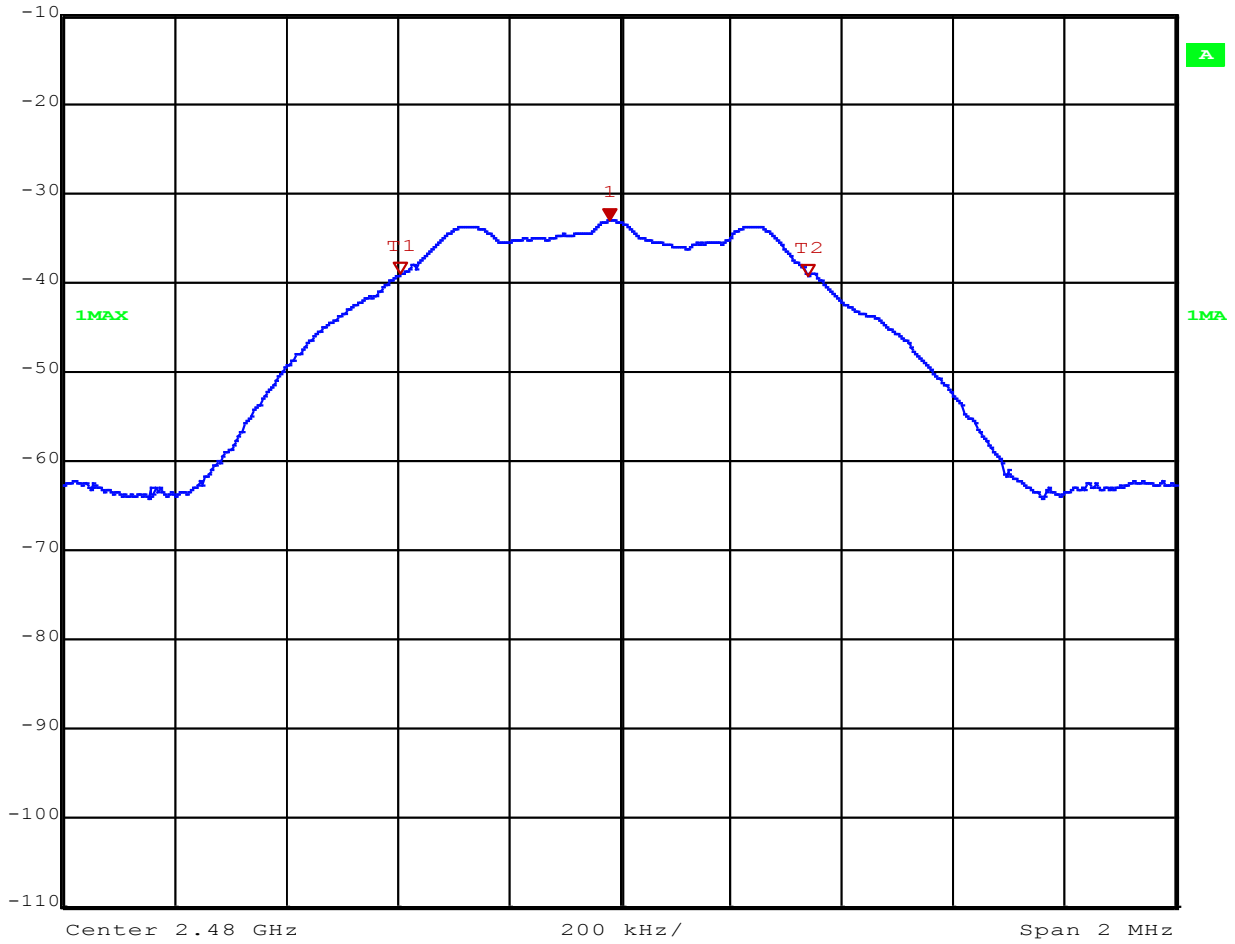

Date: 23.DEC.2020 15:36:56

DTS Bandwidth, 2480MHz



Ref Lvl	Delta 1 [T1]	RBW	30 kHz	RF Att	0 dB
-10 dBm	0.07 dB	VBW	300 kHz		
	625.25050100 kHz	SWT	6 ms	Unit	dBm

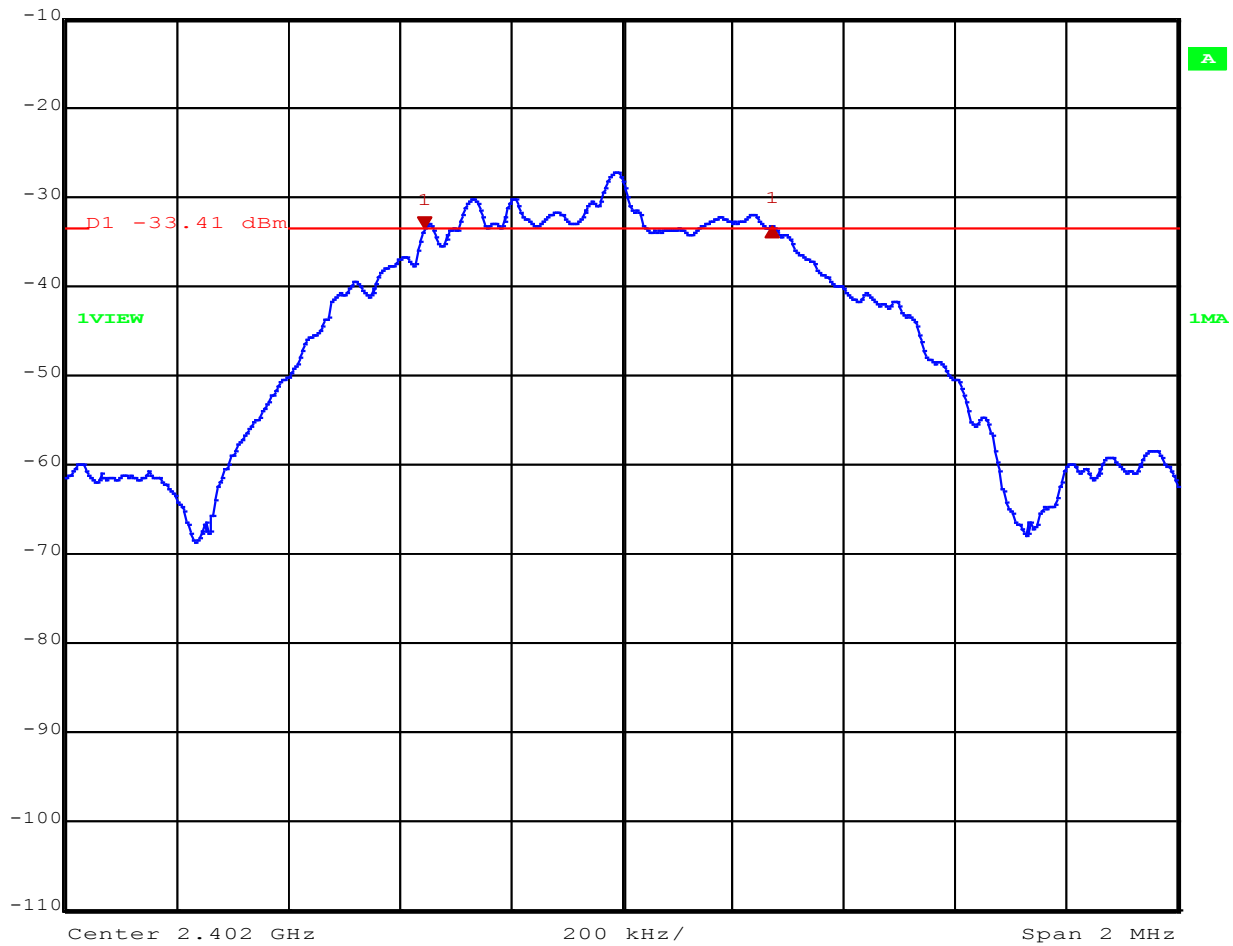

Date: 23.DEC.2020 15:43:39

6dB Bandwidth, 2402MHz



 Delta 1 [T1] RBW 30 kHz RF Att 0 dB
Ref Lvl 0.44 dB VBW 300 kHz
-10 dBm 629.25851704 kHz SWT 6 ms Unit dBm

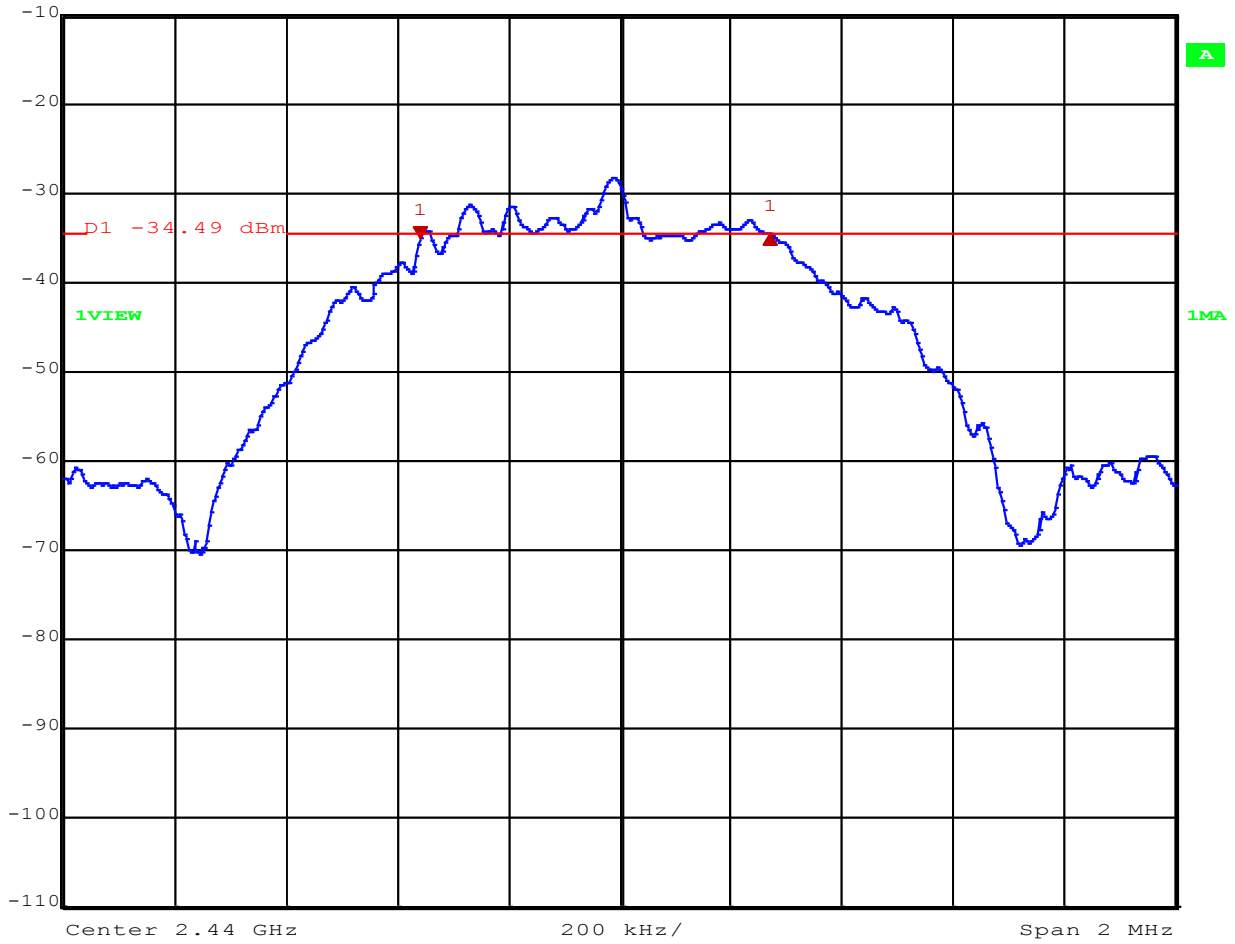

Date: 23.DEC.2020 15:45:26

6dB Bandwidth, 2440MHz



 Delta 1 [T1] RBW 30 kHz RF Att 0 dB
Ref Lvl 0.14 dB VBW 300 kHz
-10 dBm 629.25851703 kHz SWT 6 ms Unit dBm

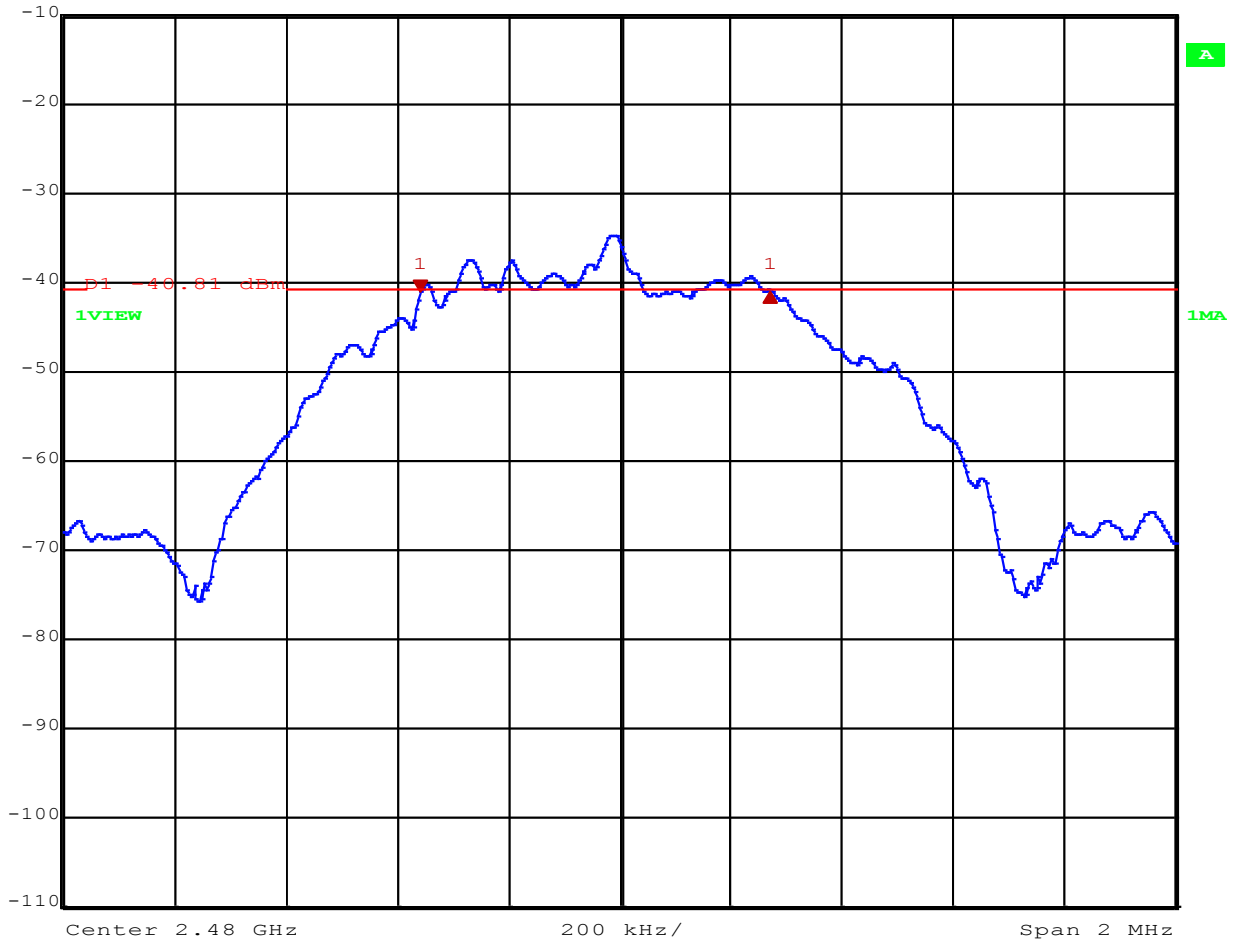

Date: 23.DEC.2020 15:47:12

6dB Bandwidth, 2480MHz



	Ref Lvl	-10 dBm	Marker 1 [T1]	-27.43 dBm	RBW	30 kHz	RF Att	0 dB
				2.40198998 GHz	VBW	300 kHz		
					SWT	6 ms	Unit	dBm

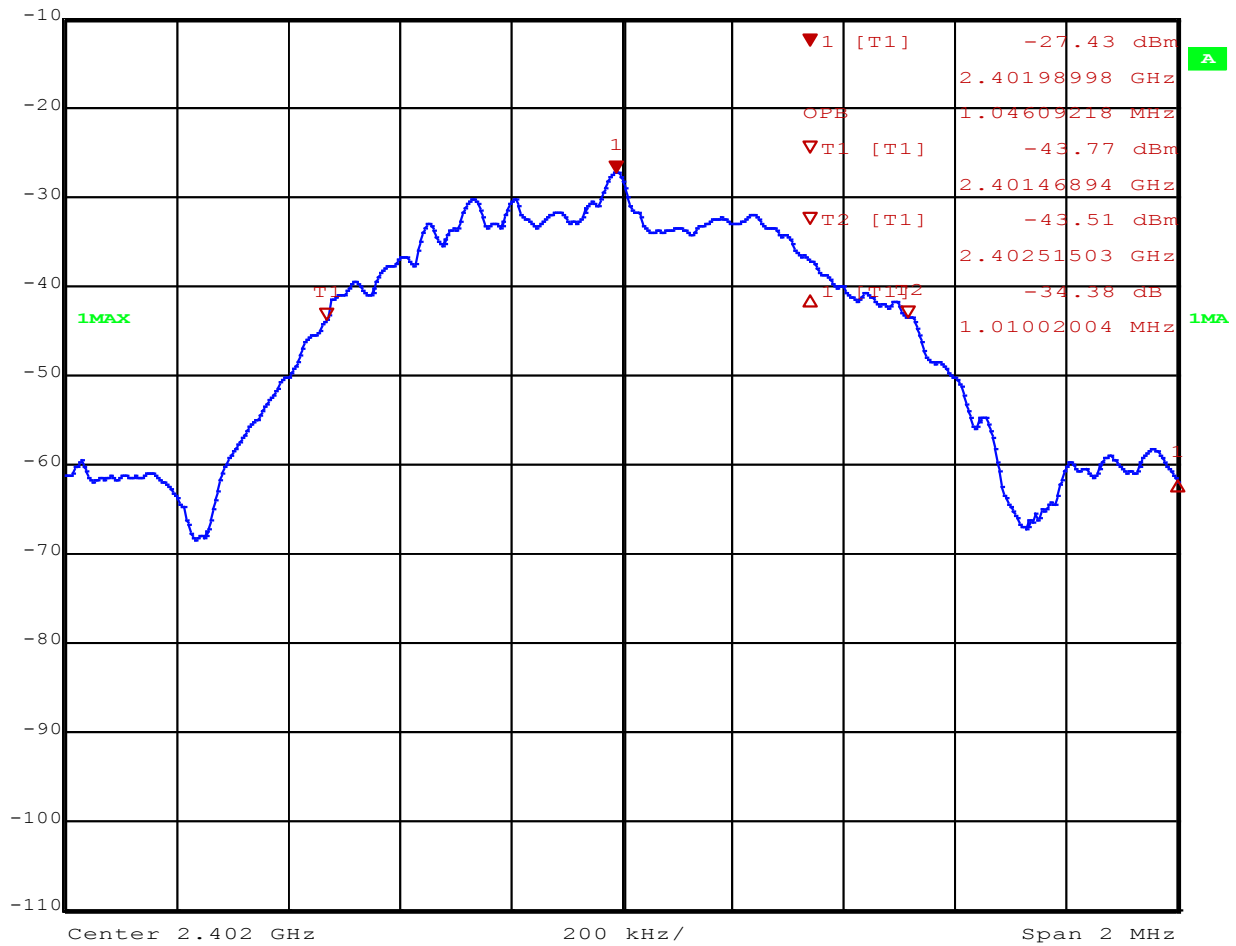

Date: 23.DEC.2020 15:53:25

99% Bandwidth, 2402MHz



	Marker 1 [T1]	RBW	30 kHz	RF Att	0 dB
	Ref Lvl	-28.48 dBm	VBW	300 kHz	
	-10 dBm	2.43998998 GHz	SWT	6 ms	Unit dBm

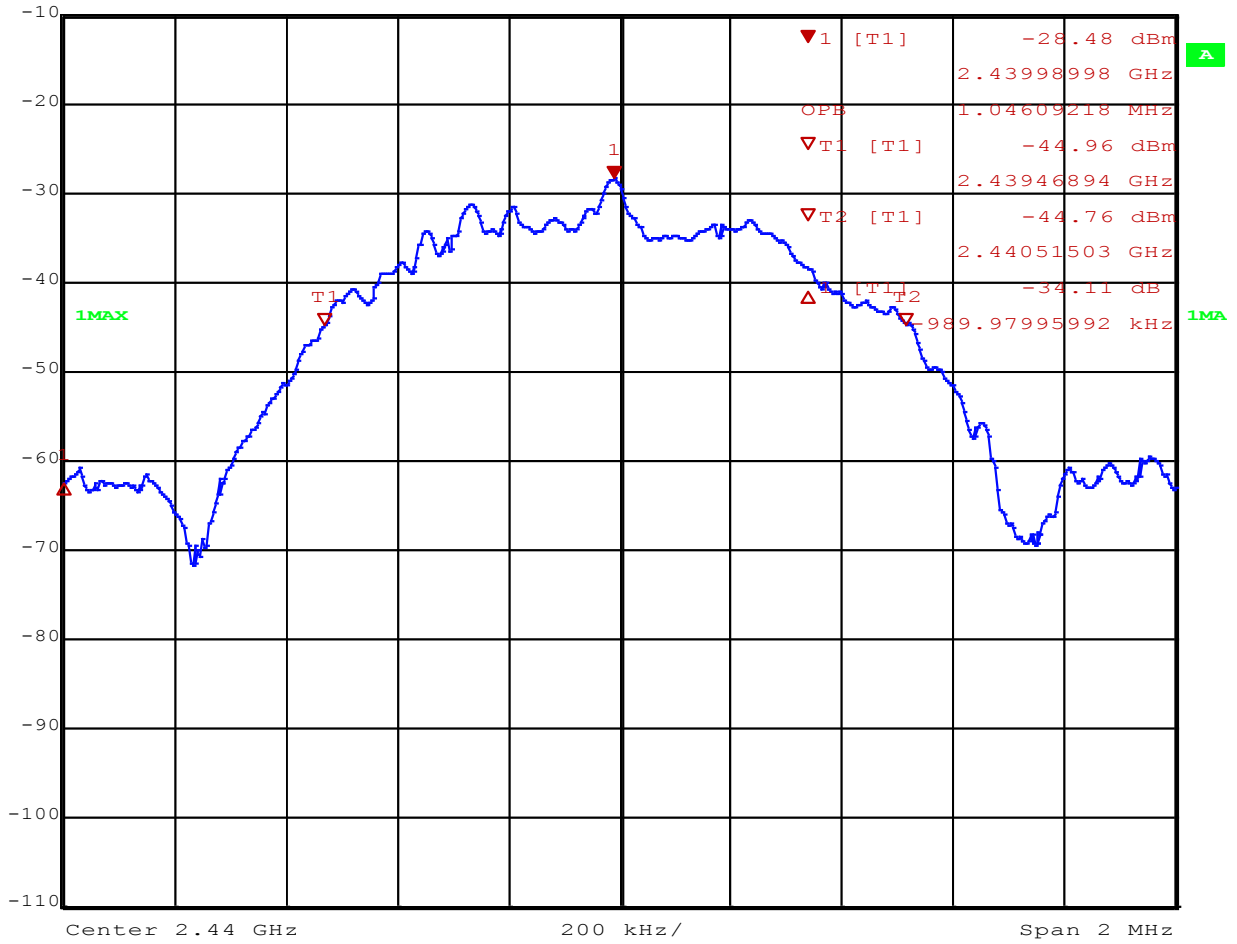

Date: 23.DEC.2020 15:54:29

99% Bandwidth, 2440MHz



	Marker 1 [T1]	RBW	30 kHz	RF Att	0 dB
Ref Lvl	-34.81 dBm	VBW	300 kHz		
-10 dBm	2.47998597 GHz	SWT	6 ms	Unit	dBm

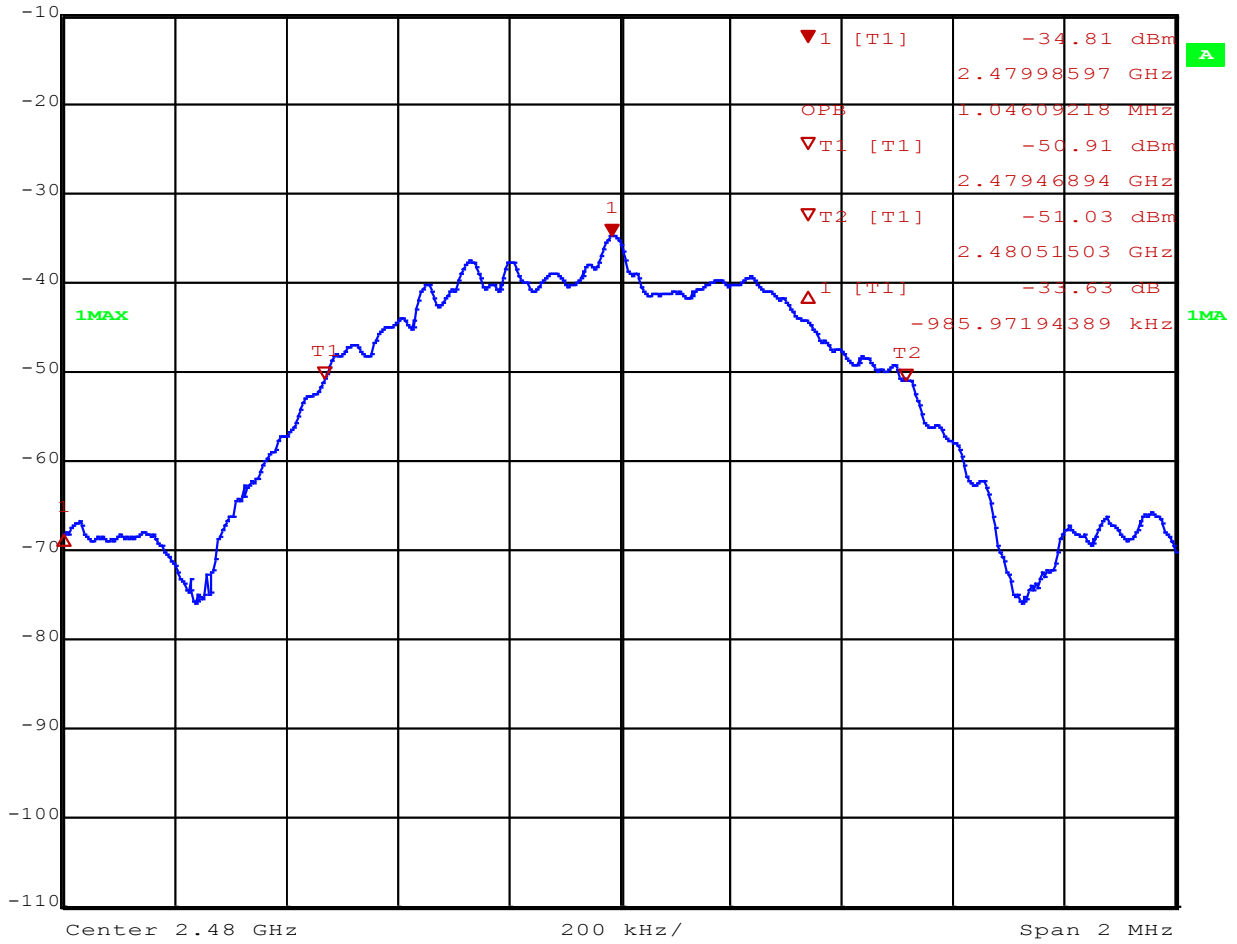

Date: 23.DEC.2020 15:55:34

99% Bandwidth, 2480MHz



10 Power Spectral Density

10.1 Test Limits

FCC Part 15.247(e):

For digitally modulated systems, the power spectral density conducted from the intentional radiator to the antenna shall not be greater than 8 dBm in any 3 kHz band during any time interval of continuous transmission. This power spectral density shall be determined in accordance with the provisions of paragraph (b) of this section. The same method of determining the conducted output power shall be used to determine the power spectral density.

RSS-247 Issue 2 § 5.2(b):

The transmitter power spectral density conducted from the transmitter to the antenna shall not be greater than 8 dBm in any 3 kHz band during any time interval of continuous transmission. This power spectral density shall be determined in accordance with the provisions of section 5.4(d), (i.e. the power spectral density shall be determined using the same method as is used to determine the conducted output power).

10.2 Test Method

Tests are performed in accordance with ANSI C63.10:2013 § 12.1.2, Annex G.

10.3 Test Equipment Used

Description	Asset	Manufacturer	Model	Cal Date	Cal Due
EMI Test Receiver	3900	Rohde & Schwarz	ESU40	10/5/2020	10/5/2021
Horn Antenna	4001	ETS	3117	1/16/2020	1/16/2021
System Controller	4096	ETS Lindgren	2090	Verify at Time of Use	Verify at Time of Use
3m Cable Antenna→Preamp	3074			12/21/2020	12/21/2021
3m Cable Preamp→Chamber	2588			12/21/2020	12/21/2021
3m Cable Chamber→Control Room	2593			12/21/2020	12/21/2021
3m Cable Control Room→Receiver	2592			12/21/2020	12/21/2021



10.4 Test Results

The device was found to be **compliant**. The peak power spectral density was less than 8dBm.

10.5 Test Conditions

Test Personnel:	<u>Bryan Taylor</u>	Test Date:	<u>12/31/2020</u>
Supervising/Reviewing Engineer:		Limit Applied:	<u>8dBm / 3kHz</u>
(Where Applicable)	<u>NA</u>		
	<u>FCC Part 15.247</u>	Ambient Temperature:	<u>22.6C</u>
Product Standard:	<u>RSS-247 Issue 2</u>	Relative Humidity:	<u>41.2%</u>
Input Voltage:	<u>120VAC / 60Hz</u>		
Pretest Verification w / Ambient		Atmospheric Pressure:	<u>991.2mbar</u>
Signals or BB Source:	<u>Yes</u>		

Deviations, Additions, or Exclusions: None.

10.6 Test Data

Frequency (MHz)	PPSD (dBm/3kHz)	Limit (dBm/3KHz)	Margin	Result
2402	-15.44	8	23.44	PASS
2440	-16	8	24	PASS
2480	-14.87	8	22.87	PASS

Note: Since the sample could not be configured for a conducted measurement, the PPSD was performed by first measuring the field strength and converting to EIRP as outlined in ANSI C63.10:2013. The antenna gain was then subtracted from the EIRP measurement to arrive at the conducted PPSD readings shown in the table above.



MARKER 1
2.401940385 GHz
Ref 126 dBµV *Att 0 dB

*RBW 3 kHz Marker 1 [T1]
*VBW 100 kHz 81.42 dBµV
SWT 135 ms 2.401940385 GHz

1 PK
MAXH

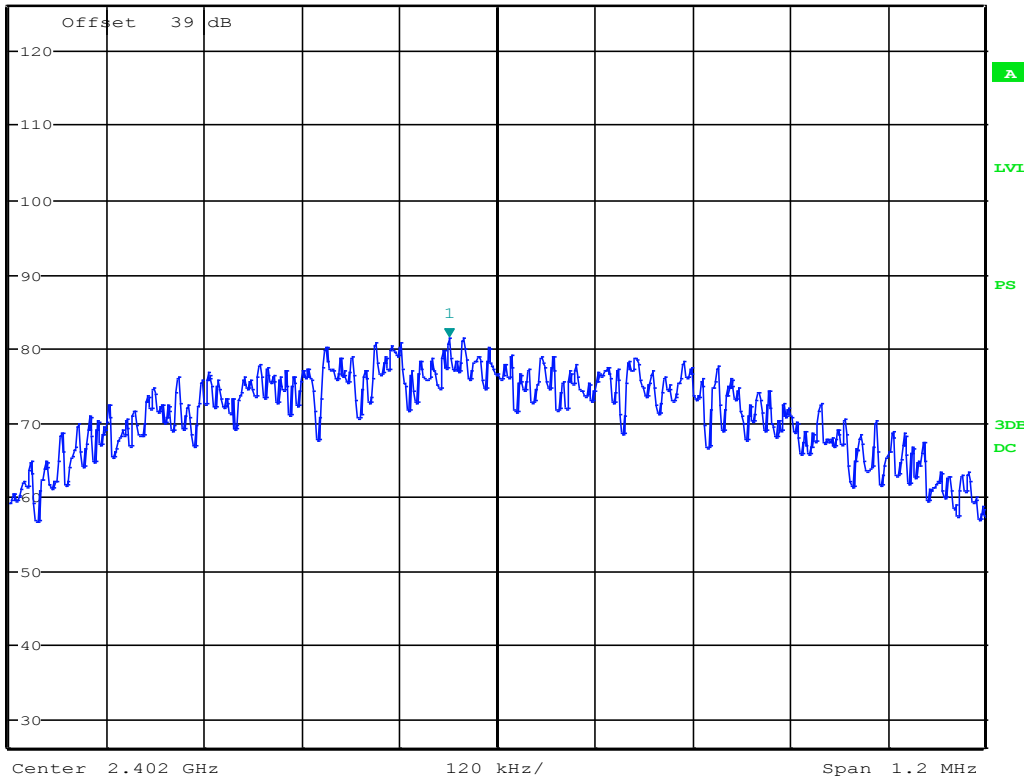

Date: 31.DEC.2020 21:53:05

PPSD(Field Strength), 2402MHz



MARKER 1

2.439940385 GHz

*RBW 3 kHz

Marker 1 [T1]

*VBW 100 kHz

80.86 dBµV

Ref 126 dBµV

*Att 0 dB

SWT 135 ms

2.439940385 GHz

1 PK
MAXH

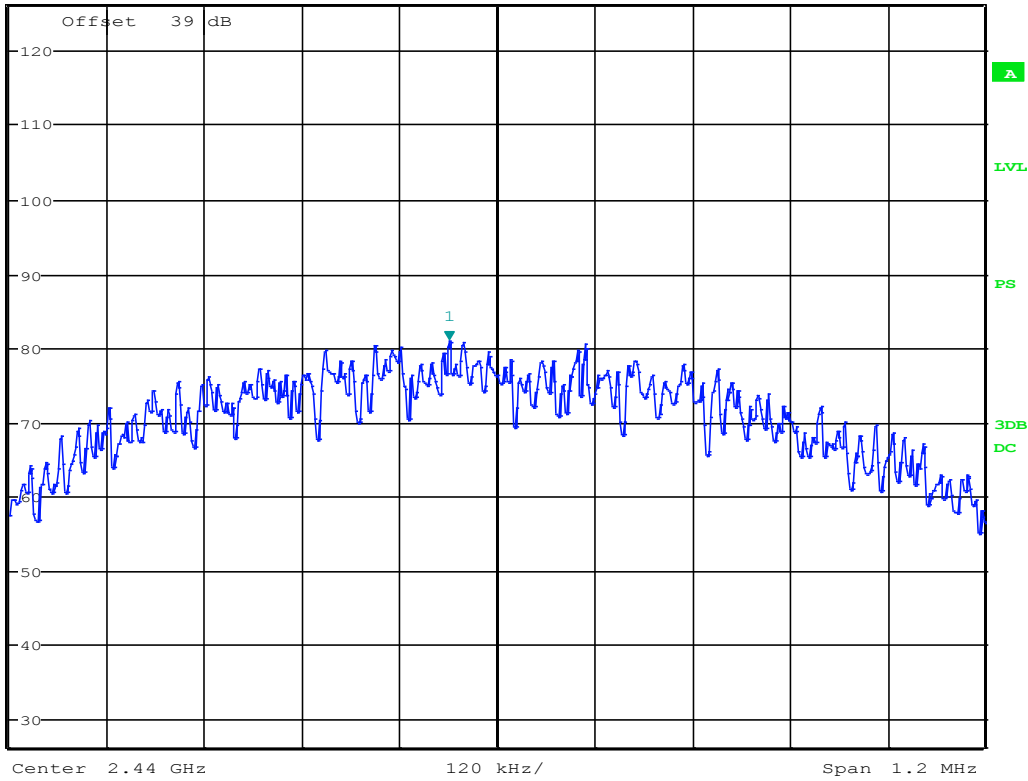

Date: 31.DEC.2020 21:55:21

PPSD(Field Strength), 2440MHz



MARKER 1

2.479940385 GHz

*RBW 3 kHz

Marker 1 [T1]

*VBW 100 kHz

81.99 dBµV

Ref 126 dBµV

*Att 0 dB

SWT 135 ms

2.479940385 GHz

1 PK
MAXH

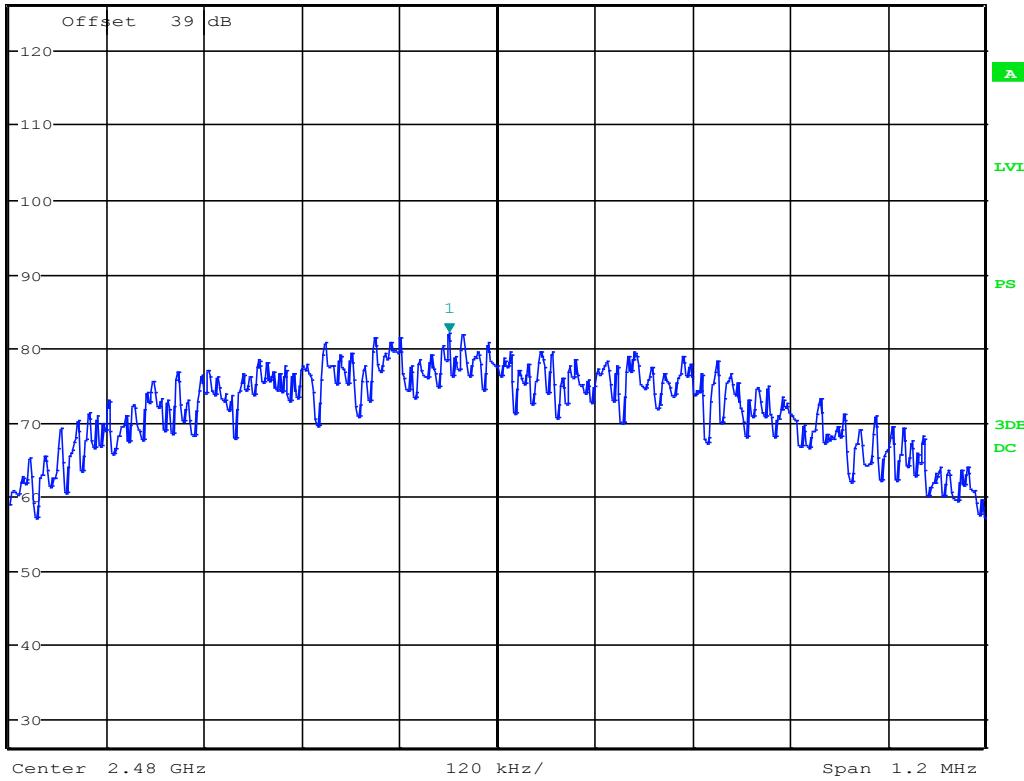

Date: 31.DEC.2020 21:56:42

PPSD(Field Strength), 2480MHz



11 Antenna Requirement

11.1 Test Limits

FCC Part 15.203:

An intentional radiator shall be designed to ensure that no antenna other than that furnished by the responsible party shall be used with the device. The use of a permanently attached antenna or of an antenna that uses a unique coupling to the intentional radiator shall be considered sufficient to comply with the provisions of this section. The manufacturer may design the unit so that a broken antenna can be replaced by the user, but the use of a standard antenna jack or electrical connector is prohibited. This requirement does not apply to carrier current devices or to devices operated under the provisions of §§15.211, 15.213, 15.217, 15.219, 15.221, or §15.236. Further, this requirement does not apply to intentional radiators that must be professionally installed, such as perimeter protection systems and some field disturbance sensors, or to other intentional radiators which, in accordance with §15.31(d), must be measured at the installation site. However, the installer shall be responsible for ensuring that the proper antenna is employed so that the limits in this part are not exceeded.

RSS-Gen Issue 5 § 6.8:

The applicant for equipment certification, as per RSP-100, must provide a list of all antenna types that may be used with the licence-exempt transmitter, indicating the maximum permissible antenna gain (in dBi) and the required impedance for each antenna.

Licence-exempt transmitters that have received equipment certification may operate with different types of antennas. However, it is not permissible to exceed the maximum equivalent isotropically radiated power (e.i.r.p.) limits specified in the applicable standard (RSS) for the licence-exempt apparatus.

Testing shall be performed using the highest gain antenna of each combination of licence-exempt transmitter and antenna type, with the transmitter output power set at the maximum level. When a measurement at the antenna connector is used to determine RF output power, the effective gain of the device's antenna shall be stated, based on a measurement or on data from the antenna manufacturer.

User manuals for transmitters equipped with detachable antennas shall also contain the following notice in a conspicuous location:

This radio transmitter (identify the device by certification number) has been approved by Industry Canada to operate with the antenna types listed below with the maximum permissible gain indicated. Antenna types not included in this list, having a gain greater than the maximum gain indicated for that type, are strictly prohibited for use with this device.

Immediately following the above notice, the manufacturer shall provide a list of all antenna types approved for use with the transmitter, indicating the maximum permissible antenna gain (in dBi).

11.2 Test Results

The device was found to be **compliant**. The device has an internal, permanently affixed antenna.



12 Conducted Emissions

12.1 Method

Tests are performed in accordance with ANSI C63.10: 2013

TEST SITE: Ground Plane

Site Designation: Ground Plane

Measurement Uncertainty

Measurement	Frequency Range	Expanded Uncertainty (k=2)	Ucisp
Power Line Conducted Emissions	150 kHz - 30 MHz	3.1dB	3.4dB

As shown in the table above our conducted emissions U_{lab} is less than the corresponding U_{CISPR} reference value in CISPR 16-4-2 Table 1, hence the compliance of the product is only based on the measured value, and no measurement uncertainty correction is required.

12.2 Sample Calculations

The following is how net line-conducted readings were determined:

$$NF = RF + LF + CF + AF$$

Where NF = Net Reading in dB μ V

RF = Reading from receiver in dB μ V

LF = LISN or ISN Correction Factor in dB

CF = Cable Correction Factor in dB

AF = Attenuator Loss Factor in dB

To convert from dB μ V to μ V or mV the following was used:

$$UF = 10^{(NF / 20)} \text{ where } UF = \text{Net Reading in } \mu\text{V}$$

NF = Net Reading in dB μ V

Example:

$$NF = RF + LF + CF + AF = 28.5 + 0.2 + 0.4 + 20.0 = 49.1 \text{ dB}\mu\text{V}$$

$$UF = 10^{(49.1 \text{ dB}\mu\text{V} / 20)} = 285.1 \mu\text{V/m}$$

**12.3 Test Equipment Used:**

Description	Asset	Manufacturer	Model	Cal Date	Cal Due
EMI Test Receiver	2327	Rohde&Schwarz	ESI26	10/9/2020	10/9/2021
LISN	2509	Fischer Custom Communication	FCC-LISN-50-50-2M	4/21/2020	4/21/2021
Coaxial Cable	6026			12/21/2020	12/21/2021

12.4 Software Utilized:

Name	Manufacturer	Version
TILE	ETS Lindgren	V7.0.6.545

12.5 Results:

The sample tested was found to Comply.



12.6 Plots/Data: Conducted Emissions (Line)

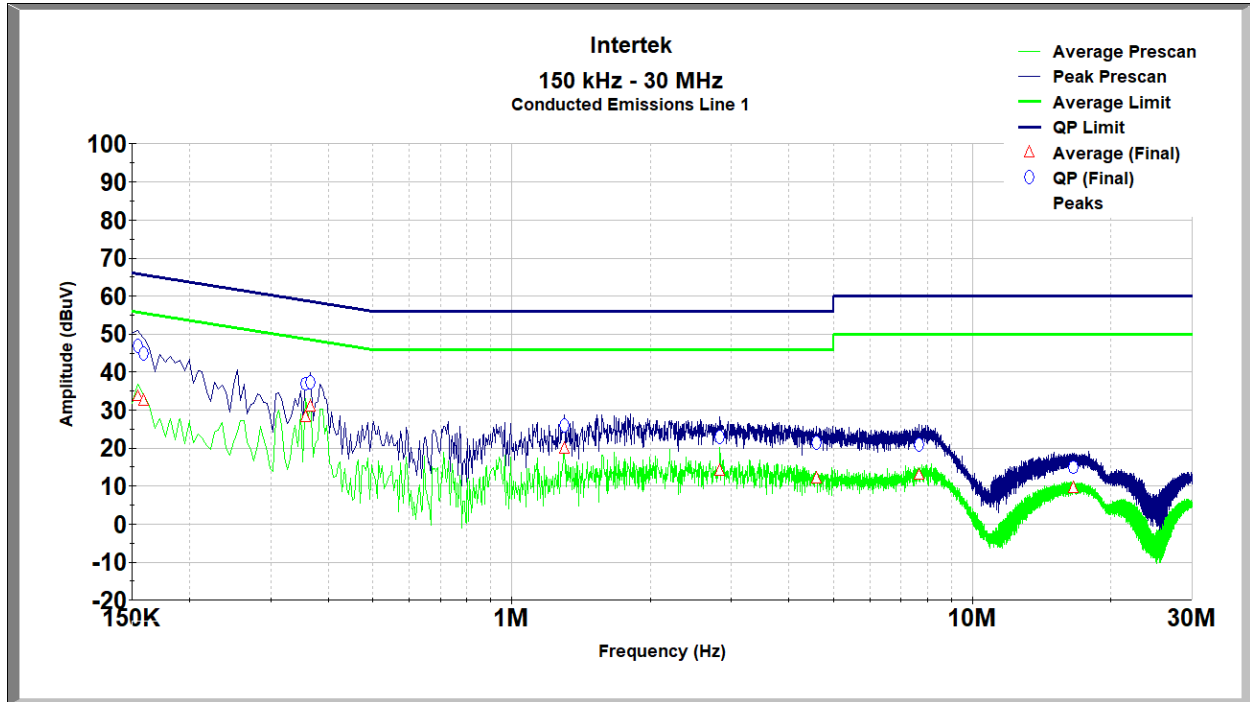

Frequency (MHz)	Quasi-Peak (dBuV)	Quasi-Peak Limit (dBuV)	Quasi-Peak Margin (dB)	Average (dBuV)	Average Limit (dBuV)	Average Margin (dB)
0.155	46.985	65.871	18.886	33.675	55.871	22.196
0.159	44.804	65.743	20.939	32.446	55.743	23.297
0.357	37.134	60.086	22.951	28.160	50.086	21.926
0.366	37.349	59.829	22.480	30.891	49.829	18.937
1.302	25.868	56.000	30.132	19.787	46.000	26.213
2.832	23.018	56.000	32.982	14.104	46.000	31.896
4.580	21.477	56.000	34.523	12.084	46.000	33.916
7.673	20.794	60.000	39.206	13.069	50.000	36.931
16.596	14.995	60.000	45.005	9.512	50.000	40.488

Test Personnel: Bryan Taylor
 Supervising/Reviewing Engineer: NA
 (Where Applicable)
 Product Standard: FCC Part 15.207
 Input Voltage: 120VAC 60Hz
 Pretest Verification w / Ambient Signals or BB Source: Yes

Test Date: 1/18/2020
 Limit Applied: Class B
 Ambient Temperature: 22.4°C
 Relative Humidity: 31.2%
 Atmospheric Pressure: 986 mbar

Deviations, Additions, or Exclusions: None



12.7 Plots/Data: Conducted Emissions (Neutral)

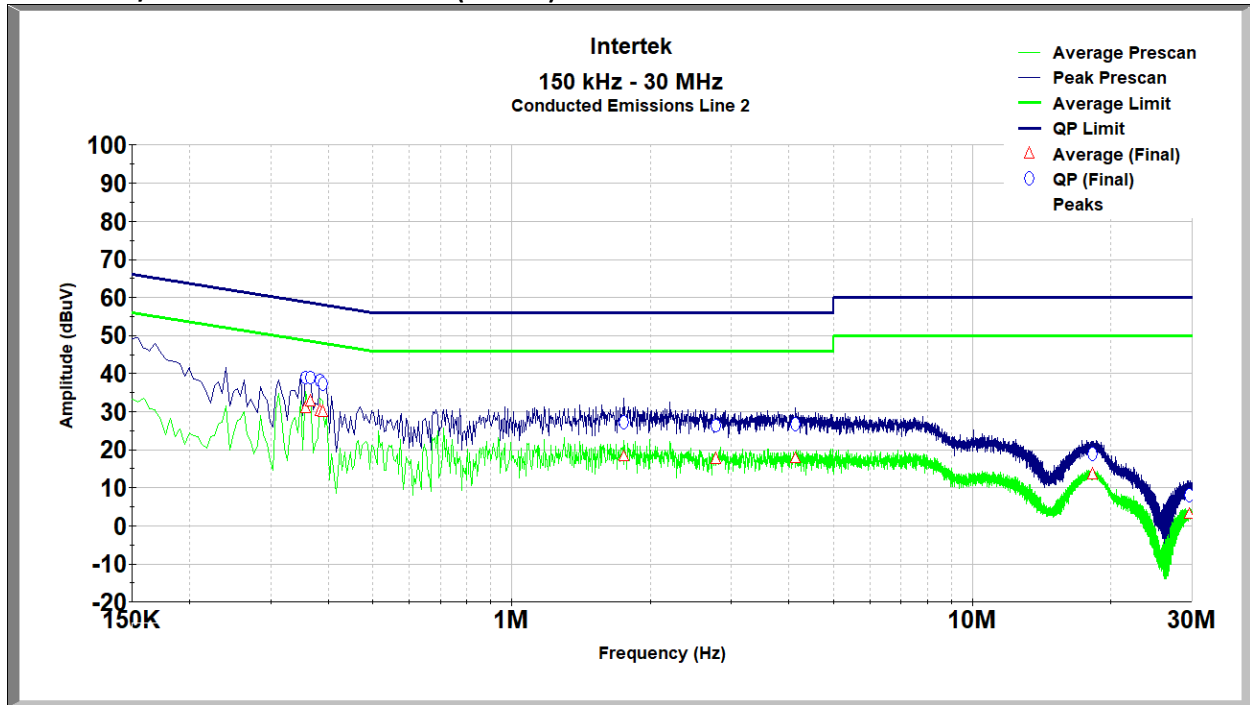

Frequency (MHz)	Quasi-Peak (dBuV)	Quasi-Peak Limit (dBuV)	Quasi-Peak Margin (dB)	Average (dBuV)	Average Limit (dBuV)	Average Margin (dB)
0.357	39.006	60.086	21.080	30.893	50.086	19.193
0.366	39.131	59.829	20.698	32.639	49.829	17.190
0.384	38.404	59.314	20.910	30.166	49.314	19.148
0.389	37.357	59.186	21.829	29.944	49.186	19.242
1.752	27.313	56.000	28.687	18.324	46.000	27.676
2.769	26.463	56.000	29.537	17.527	46.000	28.473
4.125	26.597	56.000	29.403	17.773	46.000	28.227
18.262	18.913	60.000	41.087	13.557	50.000	36.443
29.580	8.092	60.000	51.908	3.267	50.000	46.733

Test Personnel: Bryan Taylor
 Supervising/Reviewing Engineer: NA
 (Where Applicable)
 Product Standard: FCC Part 15.207
 Input Voltage: 120VAC 60Hz
 Pretest Verification w / Ambient Signals or BB Source: Yes

Test Date: 1/18/2020
 Limit Applied: Class B
 Ambient Temperature: 22.4°C
 Relative Humidity: 31.2%
 Atmospheric Pressure: 986 mbar

Deviations, Additions, or Exclusions: None



13 Revision History

Revision Level	Date	Report Number	Prepared By	Reviewed By	Notes
0	1/19/2020	104517828LEX-002	BCT	BZ	Original Issue