

---

# SAR Test Report

---

**Report No.: AGC05U120201S1**

FCC ID : C89ROCKMINI  
Product Designation : GSM Mobile Phone  
Brand Name : Ice Mobile  
Test model : ROCK MINI  
Client : Dynamics Hong Kong Limited  
Date of Issue : MAR.02.2012  
STANDARD(S) : FCC Oet65 Supplement C June 2001  
: IEEE Std. 1528-2003,47CFR § 2.1093

**Attestation of Global Compliance Co., Ltd.**

CAUTION: This report shall not be reproduced except in full without the written permission of the test laboratory and shall not be quoted out of context.

# Test Report Certification

Applicant Name	:	Dynamics Hong Kong Limited
Applicant Address	:	Room A4,3/F,Friend's House ,No.6A Carnarvon Road, Tsim Sha Tsui,Kowloon, Hong Kong
Manufacturer Name	:	Dynamics Hong Kong Limited
Manufacturer Address	:	Room A4,3/F,Friend's House ,No.6A Carnarvon Road, Tsim Sha Tsui,Kowloon, Hong Kong
Product Designation	:	GSM Mobile Phone
Brand Name	:	Ice Mobile
Test Model	:	ROCK MINI
EUT Voltage	:	DC3.7V
Applicable Standard	:	FCC Oet65 Supplement C June 2001 IEEE Std. 1528-2003,47CFR § 2.1093
Test Date	:	MAR.01.2012
Test Results	:	MAX SAR MEASUREMENT(1g) Head:1.245 W/Kg Body:0.659 W/Kg
Performed Location	:	Attestation of Global Compliance Co., Ltd. 1F., No.2 Building, Huafeng No.1 Technical Industrial Park, Sanwei, Xixiang, Baoan District, Shenzhen

Tested By



Angela Li

MAR.02.2012

Checked By



Forrest Lei

MAR.02.2012

Authorized By



Solger Zhang

MAR.02.2012

**TABLE OF CONTENTS**

<b>1. GENERAL INFORMATION .....</b>	<b>4</b>
1.1. EUT DESCRIPTION.....	4
1.2. TEST PROCEDURE .....	5
1.3. TEST ENVIRONMENT.....	5
<b>2. SAR MEASUREMENT SYSTEM.....</b>	<b>6</b>
2.1. COMOSAR SYSTEM DESCRIPTION.....	6
2.2. COMOSAR E-FIELD PROBE .....	8
2.3 ROBOT .....	8
2.4. VIDEO POSITIONING SYSTEM .....	9
2.5. DEVICE HOLDER .....	9
2.6. SAM TWIN PHANTOM.....	10
<b>3. TISSUE SIMULATING LIQUID.....</b>	<b>11</b>
3.1. THE COMPOSITION OF THE TISSUE SIMULATING LIQUID.....	11
3.2. TISSUE CALIBRATION RESULT.....	11
3.3. TISSUE DIELECTRIC PARAMETERS FOR HEAD AND BODY PHANTOMS.....	12
<b>4. SAR MEASUREMENT PROCEDURE .....</b>	<b>13</b>
4.1. SAR SYSTEM VALIDATION.....	13
4.2. SAR MEASUREMENT PROCEDURE .....	15
<b>5. SAR EXPOSURE LIMITS .....</b>	<b>16</b>
<b>6. TEST EQUIPMENT LIST .....</b>	<b>17</b>
<b>7. MEASUREMENT UNCERTAINTY .....</b>	<b>18</b>
<b>8. CONDUCTED POWER MEASUREMENT .....</b>	<b>19</b>
<b>9. TEST RESULTS .....</b>	<b>20</b>
9.1. SAR TEST RESULTS SUMMARY .....	20
<b>APPENDIX A. SAR SYSTEM VALIDATION DATA .....</b>	<b>25</b>
<b>APPENDIX B. SAR MEASUREMENT DATA.....</b>	<b>29</b>
<b>APPENDIX C. TEST SETUP PHOTOGRAPHS &amp;EUT PHOTOGRAPHS .....</b>	<b>89</b>
<b>APPENDIX D. PROBE CALIBRATION DATA .....</b>	<b>100</b>
<b>APPENDIX E. DIPOLE CALIBRATION DATA.....</b>	<b>109</b>

## 1. General Information

### 1.1. EUT Description

<b>General Information</b>	
Product Designation	GSM Mobile Phone
Test Model	ROCK MINI
Hardware Version	7707-43B
Software Version	7707V43_VS_1_1025P2_EN_PO_FR_SP_BT_FM_SC_DUAL _128X160_6432_V01_120216_0953
Device Category	Portable
RF Exposure Environment	Uncontrolled
Antenna Type	Internal
<b>GSM and GPRS</b>	
Support Band	<input checked="" type="checkbox"/> GSM 850 <input checked="" type="checkbox"/> PCS 1900 (U.S. Bands) <input checked="" type="checkbox"/> GSM 900 <input checked="" type="checkbox"/> DCS 1800 (Non-U.S. Bands)
GPRS Type	Class B
GPRS Class	Class 8,10 (1Tx+4Rx, 2Tx+3Rx)
TX Frequency Range	GSM 850: 824.2~848.8MHz PCS 1900: 1850.2~1909.8MHz
RX Frequency Range	GSM 850: 869~894MHz PCS 1900: 1930~1990MHz
Release Version	R99
Type of modulation	GMSK for GSM/GPRS
Antenna Gain	1.0dBi
Max. Output Power (Avg. Burst Power)	GSM850: 31.64 dBm ( 32.54 dBm Peak Power) PCS1900:29.02 dBm (29.74 dBm Peak Power)
Max. Output Power (Radiated)	GSM850: 30.79dBm- ERP PCS1900: 28.11 dBm- EIRP
<b>Accessories</b>	
Battery	Brand name: Ice Mobile Model No. : ROCK MINI Voltage and Capacitance: DC 3.7V/650mAh
Adapter	Brand name: Ice Mobile

	Model No. : ROCK MINI Input: 100-240V, 50/60HZ / Output: 0.15A 5.0V 500mA
Earphone	Brand name: Ice Mobile Model No. : ROCK MINI Input: 100-240V, 50/60HZ / Output: 0.15A 5.0V 500mA

Note: The sample used for testing is end product.

### 1.2. Test Procedure

1	Setup the EUT and simulators as shown on above.
2	Turn on the power of all equipment.
3	EUT communicate with CMU 200, and test them respectively at GSM 850 & PCS1900 bands

### 1.3. Test Environment

Ambient conditions in the laboratory:

Items	Required	Actual
Temperature (°C)	18-25	21± 2
Humidity (%RH)	30-70	55±2

## 2. SAR Measurement System

### 2.1. COMOSAR System Description

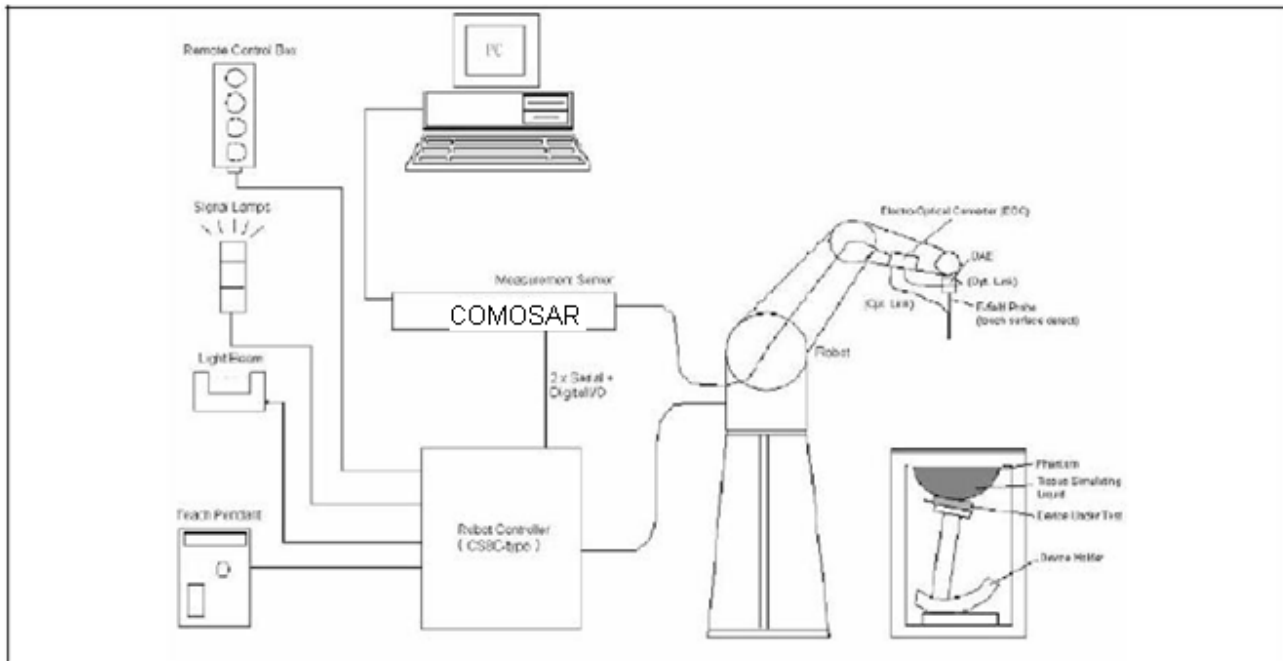

The COMOSAR system for performing compliance tests consists of the following items:

A standard high precision 6-axis robot with controller, teach pendant and software.

An arm extension for accommodating the data acquisition electronics (DAE).

A data acquisition electronics (DAE) which performs the signal amplification, signal multiplexing, AD-conversion, offset measurements, mechanical surface detection, collision detection, etc. The unit is battery powered with standard or rechargeable batteries. The signal is optically transmitted to the EOC.

The Electro-optical converter (EOC) performs the conversion from optical to electrical signals for the digital communication to the DAE. To use optical surface detection, a special version of the EOC is required. The EOC signal is transmitted to the measurement server.

The Light Beam used is for probe alignment. This improves the (absolute) accuracy of the probe positioning.

A computer running WinXP and the Opensar software.

Remote control and teach pendant as well as additional circuitry for robot safety such as warning lamps, etc.

The phantom, the device holder and other accessories according to the targeted measurement.

#### 2.1.1. Applications

Predefined procedures and evaluations for automated compliance testing with all worldwide standards, e.g., IEEE 1528, OET 65, IEC 62209-1, IEC 62209-2, EN 50360, EN 50383 and others.

### 2.1.2. Area Scans

Area scans are defined prior to the measurement process being executed with a user defined variable spacing between each measurement point (integral) allowing low uncertainty measurements to be conducted. Scans defined for FCC applications utilize a 10mm<sup>2</sup> step integral, with 1mm interpolation used to locate the peak SAR area used for zoom scan assessments.

When an Area Scan has measured all reachable points, it computes the field maxima found in the scanned area, within a range of the global maximum. The range (in dB) is specified in the standards for compliance testing. For example, a 2 dB range is required in IEEE 1528-2003, EN 50361 and IEC 62209 standards, whereby 3 dB is a requirement when compliance is assessed in accordance with the ARIB standard (Japan).

### 2.1.3. Zoom Scan (Cube Scan Averaging)

Zoom Scans are used to assess the peak spatial SAR values within a cubic averaging volume containing 1 g and 10 g of simulated tissue. A density of 1000 kg/m<sup>3</sup> is used to represent the head and body tissue density and not the phantom liquid density, in order to be consistent with the definition of the liquid dielectric properties, i.e. the side length of the 1 g cube is 10mm, with the side length of the 10 g cube 21,5mm.

The zoom scan integer steps can be user defined so as to reduce uncertainty, but normal practice for typical test applications utilize a physical step of 7x7x7 (5mmx5mmx5mm) providing a volume of 30mm in the X & Y axis, and 30mm in the Z axis.

### 2.1.4. Uncertainty of Inter-/Extrapolation and Averaging

In order to evaluate the uncertainty of the interpolation, extrapolation and averaged SAR calculation algorithms of the Post processor, COMOSAR allows the generation of measurement grids which are artificially predefined by analytically based test functions. Therefore, the grids of area scans and zoom scans can be filled with uncertainty test data, according to the SAR benchmark functions of IEEE 1528. The three analytical functions shown in equations as below are used to describe the possible range of the expected SAR distributions for the tested handsets. The field gradients are covered by the spatially flat distribution f1, the spatially steep distribution f3 and f2 accounts for H-field cancellation on the phantom/tissue surface.

$$f_1(x, y, z) = A e^{-\frac{z}{2a}} \cos^2 \left( \frac{\pi}{2} \frac{\sqrt{x'^2 + y'^2}}{5a} \right)$$

$$f_2(x, y, z) = A e^{-\frac{z}{a}} \frac{a^2}{a^2 + x'^2} \left( 3 - e^{-\frac{2z}{a}} \right) \cos^2 \left( \frac{\pi}{2} \frac{y'}{3a} \right)$$

$$f_3(x, y, z) = A \frac{a^2}{\frac{a^2}{4} + x'^2 + y'^2} \left( e^{-\frac{2z}{a}} + \frac{a^2}{2(a + 2z)^2} \right)$$

## 2.2. COMOSAR E-Field Probe

The SAR measurement is conducted with the dissymmetric probe manufactured by SPEAG.

The probe is specially designed and calibrated for use in liquid with high permittivity. The dissymmetric probe has special calibration in liquid at different frequency.

SPEAG conducts the probe calibration in compliance with international and national standards (e.g. IEEE 1528, EN62209-1, IEC 62209, etc.) Under ISO17025. The calibration data are in Appendix D.

### 2.2.1. Isotropic E-Field Probe Specification

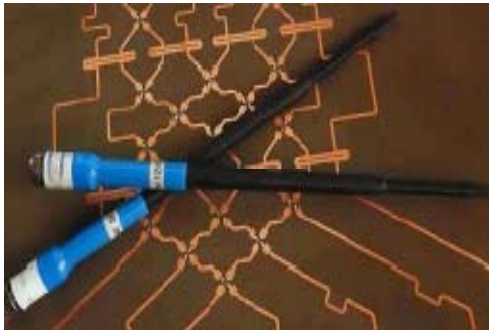
<b>Model</b>	SSE5	
<b>Manufacture</b>	Satimo	
<b>frequency</b>	0.3 GHz-3 GHz Linearity:±0.2dB(300 MHz-3 GHz)	
<b>Dynamic Range</b>	0.01W/Kg-100W/Kg Linearity:±0.2dB	
<b>Dimensions</b>	Overall length:330mm Length of individual dipoles:4.5mm Maxmum external diameter:8mm Probe Tip external diameter:5mm Distance between dipoles/ probe extremity:2.7mm	
<b>Application</b>	High precision dosimetric measurements in any exposure scenario (e.g., very strong gradient fields). Only probe which enables compliance testing for frequencies up to 3 GHz with precision of better 30%.	

## 2.3 Robot

The COMOSAR system uses the high precision robots TX90 XL type out of the newer series from Satimo SA (France).For the 6-axis controller COMOSAR system, the KUKA robot controller version from Satimo is used.

The XL robot series have many features that are important for our application:

- High precision (repeatability 0.02 mm)
- High reliability (industrial design)
- Jerk-free straight movements
- Low ELF interference (the closed metallic construction shields against motor control fields)
- 6-axis controller





## 2.4. Video Positioning System

The video positioning system is used in OpenSAR to check the probe. Which is composed of a camera, LED, mirror and mechanical parts. The camera is piloted by the main computer with firewire link.

During the process, the actual position of the probe tip with respect to the robot arm is measured, as well as the probe length and the horizontal probe offset. The software then corrects all movements, such that the robot coordinates are valid for the probe tip.

The repeatability of this process is better than 0.1 mm. If a position has been taught with an aligned probe, the same position will be reached with another aligned probe within 0.1 mm, even if the other probe has different dimensions. During probe rotations, the probe tip will keep its actual position.



## 2.5. Device Holder

The COMOSAR device holder is designed to cope with different positions given in the standard. It has two scales for the device rotation (with respect to the body axis) and the device inclination (with respect to the line between the ear reference points). The rotation center for both scales is the ear reference point (EPR).

Thus the device needs no repositioning when changing the angles.

The COMOSAR device holder has been made out of low-loss POM material having the following dielectric parameters: relative permittivity  $\epsilon_r = 3$  and loss tangent  $\delta = 0.02$ . The amount of dielectric material has been reduced in the closest vicinity of the device, since measurements have suggested that the influence of the clamp on the test results could thus be lowered.

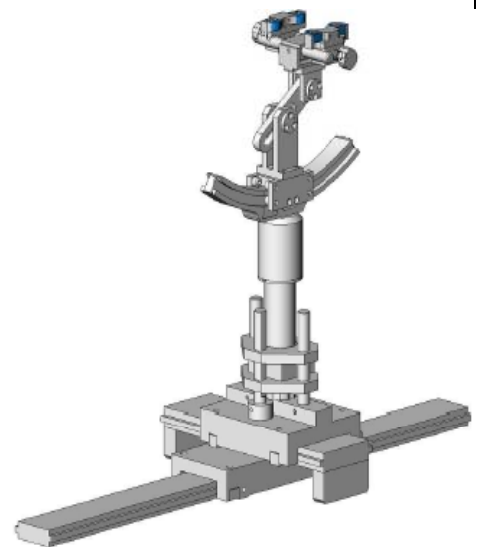

## 2.6. SAM Twin Phantom

The SAM twin phantom is a fiberglass shell phantom with 2mm shell thickness (except the ear region where shell thickness increases to 6mm). It has three measurement areas:

- Left head
- Right head
- Flat phantom



The bottom plate contains three pair of bolts for locking the device holder. The device holder positions are adjusted to the standard measurement positions in the three sections. A white cover is provided to tap the phantom during off-periods to prevent water evaporation and changes in the liquid parameters. On the phantom top, three reference markers are provided to identify the phantom position with respect to the robot.

### 3. Tissue Simulating Liquid

#### 3.1. The composition of the tissue simulating liquid

Ingredient	835MHz	835MHz	1900MHz	1900MHz
(% Weight)	Head	Body	Head	Body
<b>Water</b>	40.45	52.4	54.90	40.5
<b>Salt</b>	1.45	1.40	0.18	0.50
<b>Sugar</b>	57.6	45.0	0.00	58.0
<b>HEC</b>	0.40	1.00	0.00	0.50
<b>Preventol</b>	0.10	0.20	0.00	0.50
<b>DGBE</b>	0.00	0.00	44.92	0.00

#### 3.2. Tissue Calibration Result

The dielectric parameters of the liquids were verified prior to the SAR evaluation using COMOSAR Dielectric Probe Kit and R&S Network Analyzer ZVL6 .

Head Tissue Stimulant Measurement				
Frequency (MHz)	Description	Dielectric Parameters		Tissue Temp [°C]
835MHz	Reference result ±5% window	$\epsilon_r$ 41.50 39.43-43.58	$\delta$ [s/m] 0.90 0.86-0.95	N/A
	MAR.01.2012	40.83	0.91	21

Body Tissue Stimulant Measurement				
Frequency (MHz)	Description	Dielectric Parameters		Tissue Temp [°C]
835MHz	Reference result ±5% window	$\epsilon_r$ 55.20 52.44-57.96	$\delta$ [s/m] 0.97 0.92-1.02	N/A
	MAR.01.2012	55.80	0.99	21

Head Tissue Stimulant Measurement				
Frequency (MHz)	Description	Dielectric Parameters		Tissue Temp [°C]
1900MHz	Reference result ±5% window	$\epsilon_r$ 40.00 38.00-42.00	$\delta$ [s/m] 1.40 1.33-1.47	N/A
	MAR.01.2012	41.12	1.37	21

Body Tissue Stimulant Measurement				
Frequency (MHz)	Description	Dielectric Parameters		Tissue Temp [°C]
1900MHz	Reference result ±5% window	$\epsilon_r$ 53.30 50.64-55.97	$\delta$ [s/m] 1.52 1.44-1.60	N/A
	MAR.01.2012	52.98	1.54	21

### 3.3. Tissue Dielectric Parameters for Head and Body Phantoms

The head tissue dielectric parameters recommended by the IEEE SCC-34/SC-2 in P1528 have been incorporated in the following table. These head parameters are derived from planar layer models simulating the highest expected SAR for the dielectric properties and tissue thickness variations in a human head. Other head and body tissue parameters that have not been specified in P1528 are derived from the tissue dielectric parameters computed from the 4-Cole-Cole equations described in Reference [12] and extrapolated according to the head parameters specified in P1528.

Target Frequency (MHz)	head		body	
	$\epsilon_r$	$\sigma$ (S/m)	$\epsilon_r$	$\sigma$ (S/m)
300	45.3	0.87	58.2	0.92
450	43.5	0.87	56.7	0.94
<b>835</b>	<b>41.5</b>	<b>0.90</b>	<b>55.2</b>	<b>0.97</b>
900	41.5	0.97	55.0	1.05
915	41.5	0.98	55.0	1.06
1450	40.5	1.20	54.0	1.30
1610	40.3	1.29	53.8	1.40
<b>1800 – 2000</b>	<b>40.0</b>	<b>1.40</b>	<b>53.3</b>	<b>1.52</b>
2450	39.2	1.80	52.7	1.95
3000	38.5	2.40	52.0	2.73
5800	35.3	5.27	48.2	6.00

( $\epsilon_r$  = relative permittivity,  $\sigma$  = conductivity and  $\rho = 1000$  kg/m<sup>3</sup>)

## 4. SAR Measurement Procedure

### 4.1. SAR System Validation

#### 4.1.1. Validation Dipoles

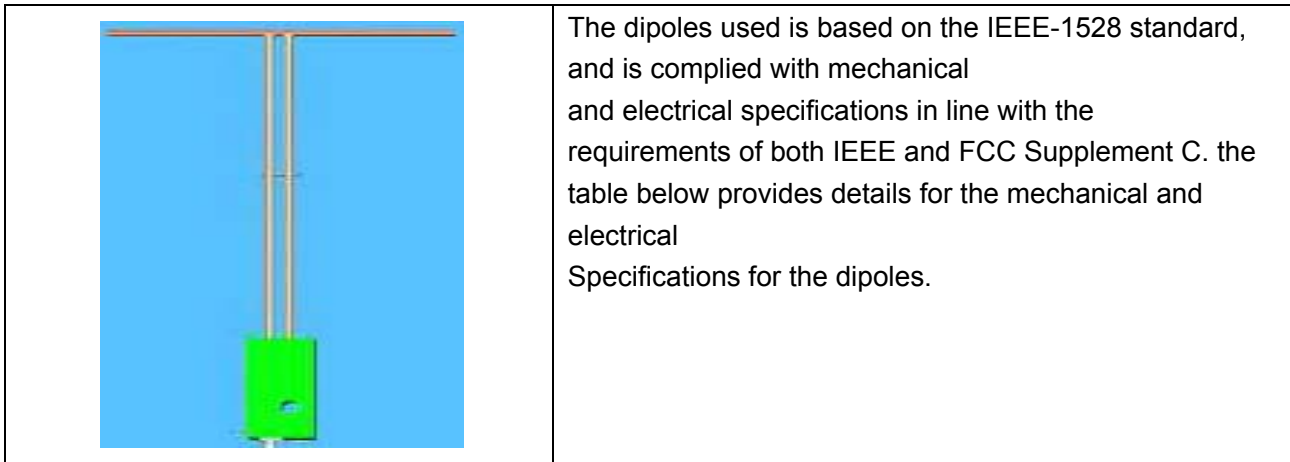

Frequency	L (mm)	h (mm)	d (mm)
900 MHz	149.0	83.3	3.6
1900MHz	68	39.5	3.6

**4.1.2. Validation Result**

<b>System Performance Check at 835 MHz &amp;1900MHz for Head</b>				
<b>Validation Kit: SN 46/11DIP 0G900-185</b>				
Frequency [MHz]	Description	SAR [w/kg] 1g	SAR [w/kg] 10g	Tissue Temp.[°C]
900 MHz	Reference result ± 10% window	10.9 9.81 to 11.99	6.99 6.29 to 7.69	N/A
	MAR.01.2012	10.50	6.80	21.0
<b>Validation Kit: SN 46/11DIP 1G900-187</b>				
Frequency [MHz]	Description	SAR [w/kg] 1g	SAR [w/kg] 10g	Tissue Temp.[°C]
1900 MHz	Reference result ± 10% window	39.7 35.73 to 43.67	20.5 18.45 to 22.55	N/A
	MAR.01.2012	41.09	19.15	21.0
Note: All SAR values are normalized to 1W forward power.				

## 4.2. SAR Measurement Procedure

The COMOSAR calculates SAR using the following equation,

$$SAR = \frac{\sigma |E|^2}{\rho}$$

$\sigma$ : represents the simulated tissue conductivity

$\rho$ : represents the tissue density

The EUT is set to transmit at the required power in line with product specification, at each frequency relating to the LOW, MID, and HIGH channel settings.

Pre-scans are made on the device to establish the location for the transmitting antenna, using a large area scan in either air or tissue simulation fluid.

The EUT is placed against the Universal Phantom where the maximum area scan dimensions are larger than the physical size of the resonating antenna. When the scan size is not large enough to cover the peak SAR distribution, it is modified by either extending the area scan size in both the X and Y directions, or the device is shifted within the predefined area.

The area scan is then run to establish the peak SAR location (interpolated resolution set at 1mm<sup>2</sup>) which is then used to orient the center of the zoom scan. The zoom scan is then executed and the 1g and 10g averages are derived from the zoom scan volume (interpolated resolution set at 1mm<sup>3</sup>).

When multiple peak SAR locations were found during the same configuration or test mode, Zoom scan shall performed on each peak SAR location, only the peak point with maximum SAR value will be reported for the configuration or test mode.

## 5. SAR Exposure Limits

SAR assessments have been made in line with the requirements of IEEE-1528, FCC Supplement C, and comply with ANSI/IEEE C95.1-1992 “Uncontrolled Environments” limits. These limits apply to a location which is deemed as “Uncontrolled Environment” which can be described as a situation where the general public may be exposed to an RF source with no prior knowledge or control over their exposure.

### Limits for General Population/Uncontrolled Exposure (W/kg)

Type Exposure	Uncontrolled Environment Limit
Spatial Peak SAR (1g cube tissue for brain or body)	1.60 W/kg
Spatial Average SAR (whole body)	0.08 W/kg
Spatial Peak SAR (10g for hands, feet, ankles and wrist)	4.00 W/kg



## 6. Test Equipment List

Equipment description	Manufacturer/Model	Identification No.	Current calibration date	Next calibration date
SAR Probe	Satimo	SN_3511_EP132	12/09/2011	12/08/2012
Phantom	Satimo	SN_4511_SAM90	Validated. No cal required.	Validated. No cal required.
Liquid	Satimo	-	Validated. No cal required.	Validated. No cal required.
Comm Tester	R&S - CMU200	069Y7-158-13-712	12/09/2011	12/08/2012
Multimeter	Keithley 2000	1188656	12/09/2011	12/08/2012
Dipole	Satimo SID900	SN46/11 DIP 0G900-185	12/09/2011	12/08/2014
Dipole	Satimo SID1900	SN46/11 DIP 1G900-187	12/09/2011	12/08/2014
Amplifier	Aethercomm	SN 046	12/09/2011	12/08/2012
Power Meter	HP E4418A	US38261498	12/09/2011	12/08/2012
Network Analyzer	Rhode & Schwarz ZVA	SN100132	12/09/2011	12/08/2012

Note: Per KDB 50824 Dipole SAR Validation Verification, AGC Lab has adopted 3 years calibration intervals. On annual basis, every measurement dipole has been evaluated and is in compliance with the following criteria:

1. There is no physical damage on the dipole;
2. System validation with specific dipole is within 10% of calibrated value;
3. Return-loss is within 20% of calibrated measurement;
4. Impedance is within 5Ω of calibrated measurement.

## 7. Measurement Uncertainty

<b>Satimo Uncertainty</b>									
Measurement uncertainty for 300 MHz to 3 GHz averaged over 1 gram / 10 gram.									
Error Description	Sec	Tol (±%)	Prob. Dist.	Div.	(Ci) 1g	(Ci) 10g	Std. Unc. (1g) (±%)	Std. Unc. (10g)(±%)	(Vi) Veff
<b>Measurement System</b>									
Probe Calibration	E.2.1	6	N	1	1	1	6	6	∞
Axial Isotropy	E.2.2	3	R	$\sqrt{3}$	$(1-c_p)^{1/2}$	$(1-c_p)^{1/2}$	1.22474	1.22474	∞
Hemispherical Isotropy	E.2.2	5	R	$\sqrt{3}$	$\sqrt{c_p}$	$\sqrt{c_p}$	2.04124	2.04124	∞
Boundary Effects	E.2.3	1	R	$\sqrt{3}$	1	1	0.57735	0.57735	∞
Linearity	E.2.4	5	R	$\sqrt{3}$	1	1	2.88675	2.88675	∞
System Detection Limits	E.2.5	1	R	$\sqrt{3}$	1	1	0.57735	0.57735	∞
Readout Electronics	E.2.6	0.5	N	1	1	1	0.5	0.5	∞
Response Time	E.2.7	0.2	R	$\sqrt{3}$	1	1	0.11547	0.11547	∞
Integration Time	E.2.8	2	R	$\sqrt{3}$	1	1	1.1547	1.1547	∞
RF Ambient Noise	E.6.1	3	R	$\sqrt{3}$	1	1	1.73205	1.73205	∞
Probe Positioner Mechanical Tolerance	E.6.2	2	R	$\sqrt{3}$	1	1	1.1547	1.1547	∞
Probe Positioning with Respect to Phantom Shell	E.6.3	1	R	$\sqrt{3}$	1	1	0.57735	0.57735	∞
Extrapolation, interpolation and Integration Algorithms for Max. SAR Evaluation	E.5.2	1.5	R	$\sqrt{3}$	1	1	0.86603	0.86603	∞
<b>Dipole</b>									
Device Positioning	8,E.4.2	1	N	$\sqrt{3}$	1	1	0.57735	0.57735	N-1
Power Drift	8.6.6.2	2	R	$\sqrt{3}$	1	1	1.1547	1.1547	∞
<b>Phantom and Tissue Parameters</b>									
Phantom Uncertainty	E.3.1	4	R	$\sqrt{3}$	1	1	2.3094	2.3094	∞
Liquid Conductivity (target)	E.3.2	5	R	$\sqrt{3}$	0.64	0.43	1.84752	1.2413	∞
Liquid Conductivity (meas.)	E.3.3	2.5	N	1	0.64	0.43	1.6	1.075	∞
Liquid Permittivity (target)	E.3.2	3	R	$\sqrt{3}$	0.6	0.49	1.03923	0.8487	∞
Liquid Permittivity (meas.)	E.3.3	2.5	N	1	0.6	0.49	1.5	1.225	M
Combined Standard Uncertainty			RSS				8.09272	7.9296	
Expanded Uncertainty (95%CONFIDENCE INTERVAL)			k				15.8617	15.542	

## 8. Conducted Power Measurement

Mode	Frequency(MHz)	Peak Power	Avg. Burst Power	Duty cycle Factor(dB)	Frame Power(dBm)
Maximum Power					
GSM 850	824.2	32.51	31.58	-9	22.58
	836.6	32.39	31.56	-9	22.56
	848.8	<b>32.54</b>	31.64	-9	22.64
GPRS850 (1 Slot)	824.2	32.44	31.47	-9	22.47
	836.6	32.36	31.51	-9	22.51
	848.8	32.49	31.59	-9	22.59
GPRS850 (2 Slot)	824.2	29.36	28.64	-6	22.64
	836.6	29.41	28.67	-6	22.67
	848.8	29.47	28.75	-6	22.75
PCS1900	1850.2	29.23	28.74	-9	19.74
	1880	29.45	28.81	-9	19.81
	1909.8	<b>29.74</b>	29.02	-9	20.02
GPRS1900 (1 Slot)	1850.2	29.2	28.67	-9	19.67
	1880	29.51	28.71	-9	19.71
	1909.8	29.61	28.79	-9	19.79
GPRS1900 (2 Slot)	1850.2	26.64	25.78	-6	19.78
	1880	26.78	25.81	-6	19.81
	1909.8	26.81	25.73	-6	19.73
GSM 850 <SIM 2>	824.2	32.33	31.34	-9	22.34
	836.6	32.29	31.45	-9	22.45
	848.8	<b>32.44</b>	31.56	-9	22.56
PCS1900 <SIM 2>	1850.2	29.21	28.55	-9	19.55
	1880	29.38	28.63	-9	19.63
	1909.8	<b>29.67</b>	28.78	-9	19.78

Note 1:

The Frame Power (Source-based time-averaged Power) is scaled the maximum burst average power based on time slots. The calculated methods are show as following:

Frame Power = Max burst power (1 Up Slot) – 9 dB

Frame Power = Max burst power (2 Up Slot) – 6 dB

## 9. Test Results

### 9.1. SAR Test Results Summary

#### 9.1.1. Test position and configuration

Head SAR was performed with the device configured in the positions according to IEEE1528, and Body SAR was performed with the device 15mm from the phantom. Body SAR was also performed with the headset attached and without.

#### 9.1.2. Body SAR with Headset

Testing with the headset was performed at the position and channels that resulted in the highest body SAR. This testing was performed with GPRS transmitting with 2/3/4 uplink timeslots. This operation mode represents the maximum SAR situation, when downloading data via GPRS and listening to music by headset. SAR without the headset attached was significantly higher than with the headset, and also was verified several times and confirmed, so the final test data shown were the worst case without headset. In the Body SAR test result table, body-worn means display of device down, body-front means display of device up.

#### 9.1.3. Operation Mode

This is a multi-slot class 10 device capable of 2 uplink timeslots. During the head SAR test, the device was transmitting with maximum 1 uplink timeslot; during the body SAR test, it was transmitting with maximum 2 uplink timeslots. Additionally, this device doesn't support dual transfer mode (DTM), and SIM <1> can't transmit with SIM <2> simultaneously.

#### 9.1.4. Co-located SAR

According to KDB 447498 and KDB 648474, due to the Max peak power for Bluetooth is less than Pref and the Maximum SAR for GSM part=1.245W/Kg, thus, regardless the closest separation distance between the GSM antenna and Bluetooth Antenna is more than 2.5cm, stand-alone SAR and simultaneous transmission SAR is not required.

Other reference document: KDB 941225.

**9.1.5. Test Result**

<b>SAR MEASUREMENT</b>									
Ambient Temperature (°C) : 21 ± 2						Relative Humidity (%): 55			
Liquid Temperature (°C) : 21 ± 2						Depth of Liquid (cm):>15			
Product: GSM MOBILE PHONE									
Test Mode: GSM850 with GMSK modulation									
Configuration			Antenna Position	Frequency		Frame Power (dBm)	Power Drift (<±0.2 dB)	SAR (1g) (W/kg)	Limit (W/kg)
SIM	Position	Status		channel	MHz				
<1>	Left Head	Cheek	Fixed	128	824.2	22.58	-0.05	1.186	1.6
				190	836.6	22.56	-0.02	<b>1.245</b>	1.6
				251	848.8	22.64	-0.06	0.842	1.6
		Tilted	Fixed	128	824.2	22.58	--	--	1.6
				190	836.6	22.56	-0.03	0.807	1.6
				251	848.8	22.64	--	--	1.6
	Right Head	Cheek	Fixed	128	824.2	22.58	--	--	1.6
				190	836.6	22.56	-0.01	1.184	1.6
				251	848.8	22.64	--	--	1.6
		Tilted	Fixed	128	824.2	22.58	--	--	1.6
				190	836.6	22.56	-0.03	0.746	1.6
				251	848.8	22.64	--	--	1.6
<2>	Left	Cheek	Fixed	190	836.6	22.45	-0.02	<b>1.121</b>	1.6

Note: when the 1-g SAR is ≤ 0.8 W/kg, testing for low and high channel is optional. refer to KDB 941225.

SAR MEASUREMENT									
Ambient Temperature (°C) : 21 ± 2						Relative Humidity (%): 55			
Liquid Temperature (°C) : 21 ± 2						Depth of Liquid (cm):>15			
Product: GSM MOBILE PHONE									
Test Mode: GSM850 with GMSK modulation									
Configuration			Antenna Position	Frequency		Frame Power (dBm)	Power Drift (<±0.2 dB)	SAR (1g) (W/kg)	Limit (W/kg)
SIM	Position	Status		channel	MHz				
<1>	Body Front	MS	Fixed	128	824.2	22.58	--	--	1.6
				190	836.6	22.56	-0.08	0.407	1.6
				251	848.8	22.64	--	--	1.6
		GPRS 2 TS	Fixed	128	824.2	22.64	--	--	1.6
				190	836.6	22.67	-0.11	0.467	1.6
				251	848.8	22.75	--	--	1.6
	Body Back	GPRS 2TS	Fixed	128	824.2	22.64	--	--	1.6
				190	836.6	22.67	-0.07	0.659	1.6
				251	848.8	22.75	--	--	1.6
		GPRS 2TS Earphone	Fixed	128	824.2	22.64	--	--	1.6
				190	836.6	22.67	-0.04	0.631	1.6
				251	848.8	22.75	--	--	1.6
<2>	--	--	--	--	--	--	--	--	

Note: when the 1-g SAR is ≤ 0.8 W/kg, testing for low and high channel is optional. refer to KDB 941225.

SAR MEASUREMENT									
Ambient Temperature (°C) : 21 ± 2						Relative Humidity (%): 55			
Liquid Temperature (°C) : 21 ± 2						Depth of Liquid (cm):>15			
Product: GSM MOBILE PHONE									
Test Mode: PCS1900 with GMSK modulation									
Configuration			Antenna Position	Frequency		Frame Power (dBm)	Power Drift (<±0.2 dB)	SAR (1g) (W/kg)	Limit (W/kg)
SIM	Position	Status		channel	MHz				
<1>	Left Head	Cheek	Fixed	512	1850.2	19.74	--	--	1.6
				661	1880.0	19.81	0.04	<b>0.823</b>	1.6
				810	1909.8	20.02	--	--	1.6
		Tilted	Fixed	512	1850.2	19.74	--	--	1.6
				661	1880.0	19.81	-0.08	<b>0.743</b>	1.6
				810	1909.8	20.02	--	--	1.6
	Right Head	Cheek	Fixed	512	1850.2	19.74	--	--	1.6
				661	1880.0	19.81	0.03	0.600	1.6
				810	1909.8	20.02	--	--	1.6
		Tilted	Fixed	512	1850.2	19.74	--	--	1.6
				661	1880.0	19.81	-0.09	0.461	1.6
				810	1909.8	20.02	--	--	1.6
<2>	Left	Cheek	Fixed	661	1880.0	19.63	-0.01	<b>0.761</b>	1.6

Note: when the 1-g SAR is ≤ 0.8 W/kg, testing for low and high channel is optional. refer to KDB 941225.

SAR MEASUREMENT									
Ambient Temperature (°C) : 21 ± 2						Relative Humidity (%): 55			
Liquid Temperature (°C) : 21 ± 2						Depth of Liquid (cm):>15			
Product: GSM MOBILE PHONE									
Test Mode: GSM1900 with GMSK modulation									
Configuration			Antenna Position	Frequency		Frame Power (dBm)	Power Drift (<±0.2 dB)	SAR (1g) (W/kg)	Limit (W/kg)
SIM	Position	Status		channel	MHz				
<1>	Body Front	MS	Fixed	512	1850.2	19.74	--	--	1.6
				661	1880.0	19.81	-0.01	0.192	1.6
				810	1909.8	20.02	--	--	1.6
		GPRS 2 TS		512	1850.2	19.78	--	--	1.6
				661	1880.0	19.81	-0.02	0.121	1.6
				810	1909.8	19.73	--	--	1.6
	Body Back	MS	Fixed	512	1850.2	19.74	--	--	1.6
				661	1880.0	19.81	-0.04	0.242	1.6
				810	1909.8	20.02	--	--	1.6
		MS Earphone		512	1850.2	19.74	--	--	1.6
				661	1880.0	19.81	-0.03	0.218	1.6
				810	1909.8	20.02	--	--	1.6
<2>	--	--	--	--	--	--	--	--	

Note: when the 1-g SAR is ≤ 0.8 W/kg, testing for low and high channel is optional. refer to KDB 941225.



## Appendix A. SAR System Validation Data

Test Laboratory: AGC Lab

Date:MAR.01.2012

### System Check Head 900 MHz

**DUT: Dipole 900 MHz Type: SID 900**

Communication System: CW; Communication System Band: D850(850.0 MHz); Duty Cycle: 1:1; ConvF=6.79

Frequency: 850 MHz; Medium parameters used:  $f = 850$  MHz;  $\sigma = 0.91$  mho/m;  $\epsilon_r = 40.83$ ;  $\rho = 1000$  kg/m<sup>3</sup> ;

Phantom section: Flat Section ; Input Power=20dBm

Ambient temperature (°C): 21, Liquid temperature (°C): 21

Satimo Configuration:

Probe:SSE5; Calibrated: 09/12/2011

- Sensor-Surface: 4mm (Mechanical Surface Detection)
- Phantom: SAM1; Type: SAM
- Measurement SW: OpenSAR V4\_02\_01

**Configuration/System Check GSM850 Head/Area Scan:** Measurement grid: dx=8mm, dy=8mm

**Configuration/System Check GSM850 Head/Zoom Scan :** Measurement grid: dx=8mm, dy=8mm, dz=5mm

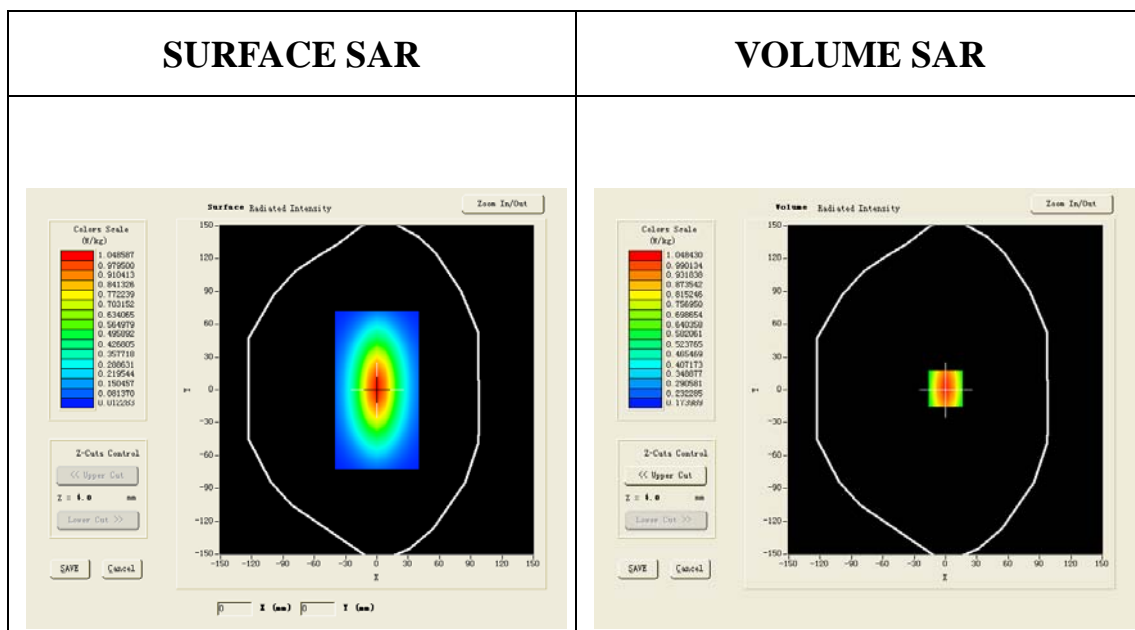

**Maximum location: X=0.00, Y=1.00**

<b>SAR 10g (W/Kg)</b>	0.680229
<b>SAR 1g (W/Kg)</b>	0.997012

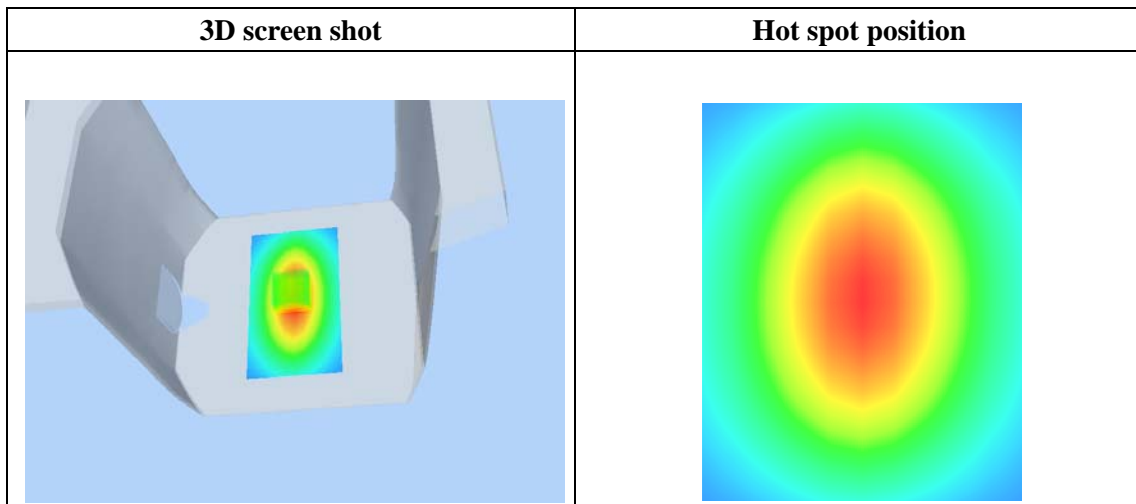
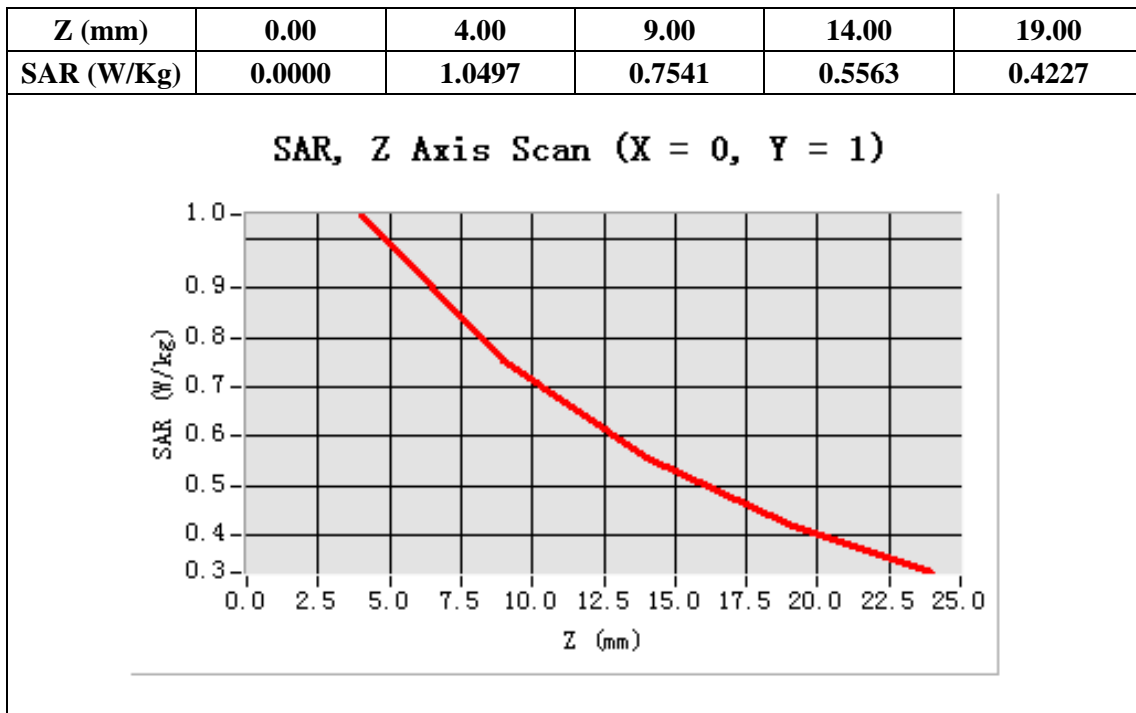

Test Laboratory: AGC Lab  
System Check Head 1900MHz

Date: MAR.01.2012

**DUT: Dipole 1900 MHz ; Type: SID 1900**

Communication System: CW; Communication System Band: D1900 (1900.0 MHz); Duty Cycle:1:1;ConvF=6.42  
Frequency: 1900 MHz; Medium parameters used:  $f = 1900$  MHz;  $\sigma = 1.37$  mho/m;  $\epsilon_r = 41.12$ ;  $\rho = 1000$  kg/m<sup>3</sup> ;  
Phantom section: Flat Section ; Input Power=20dBm  
Ambient temperature (°C): 21, Liquid temperature (°C): 21  
Satimo Configuration:

Probe:SSE5; Calibrated: 09/12/2011

- Sensor-Surface: 4mm (Mechanical Surface Detection)
- Phantom: SAM1; Type: SAM
- Measurement SW: OpenSAR V4\_02\_01

**Configuration/System Check PCS1900 Head/Area Scan:** Measurement grid: dx=8mm, dy=8mm

**Configuration/System Check PCS1900 Head/Zoom Scan:** Measurement grid: dx=8mm, dy=8mm, dz=5mm

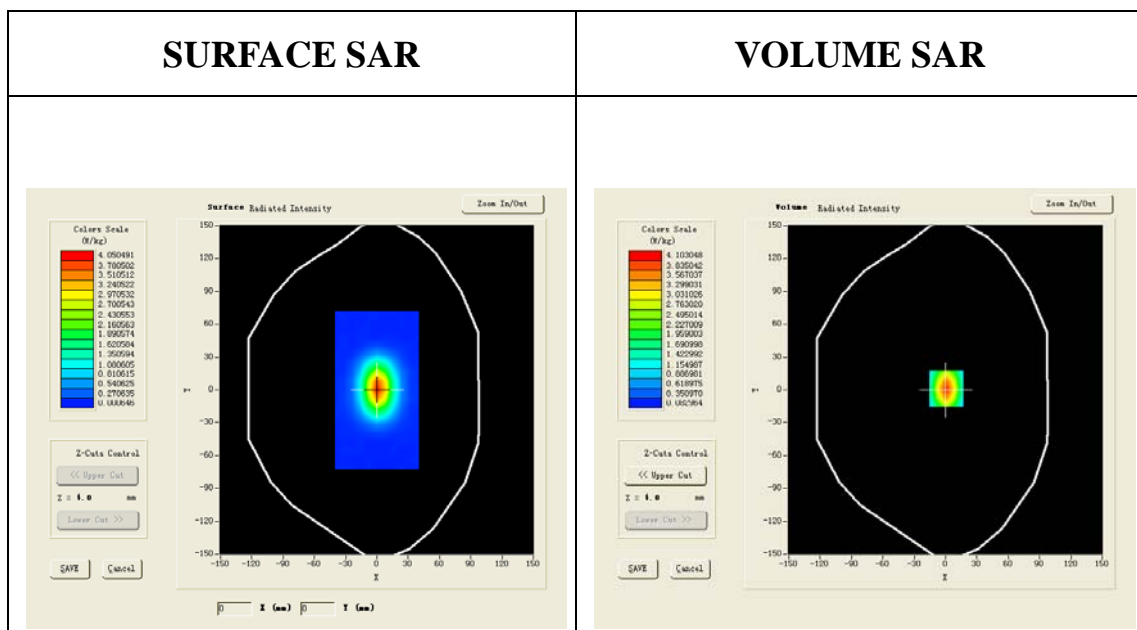

**Maximum location: X=1.00, Y=1.00**

<b>SAR 10g (W/Kg)</b>	1.915340
<b>SAR 1g (W/Kg)</b>	3.788039

<b>Z (mm)</b>	<b>0.00</b>	<b>4.00</b>	<b>9.00</b>	<b>14.00</b>	<b>19.00</b>
<b>SAR (W/Kg)</b>	<b>0.0000</b>	<b>4.1086</b>	<b>2.1927</b>	<b>1.1973</b>	<b>0.7021</b>

**SAR, Z Axis Scan (X = 1, Y = 1)**

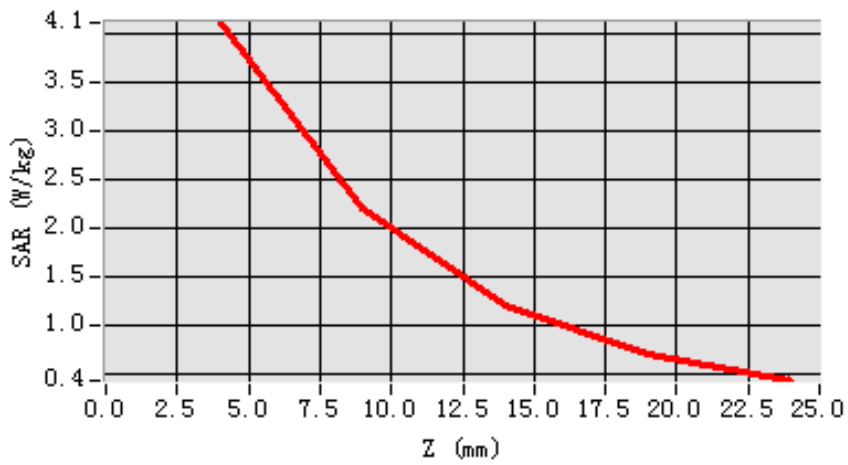

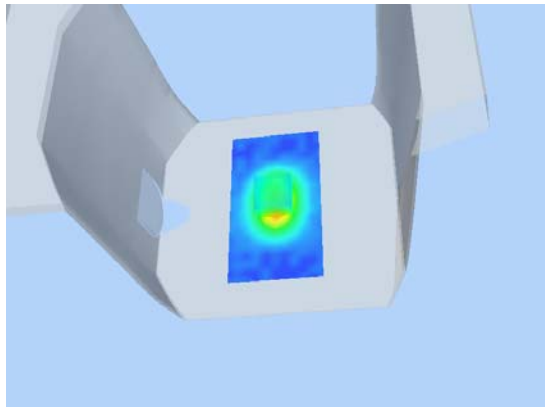
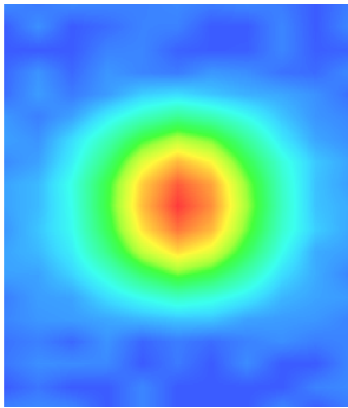
<b>3D screen shot</b>	<b>Hot spot position</b>
	

## Appendix B. SAR measurement Data

Test Laboratory: AGC Lab

Date:MAR.01.2012

GSM 850 Low-touch-Left <SIM 1>

**DUT:GSM MOBILE PHONE; Type: ROCK MINI**

Communication System: Generic GSM; Communication System Band: GSM 850; DutyCycle:1: 8; Conv.F=6.79  
Frequency: 836.6 MHz; Medium parameters used:  $f = 835$  MHz;  $\sigma = 0.91$  mho/m;  $\epsilon_r = 40.83$ ;  
 $\rho = 1000$  kg/m<sup>3</sup> ; Phantom section: Left Section  
Ambient temperature (°C): 21, Liquid temperature (°C): 21

Satimo Configuration:

Probe:SSE5; Calibrated: 09/12/2011

- Sensor-Surface: 4mm (Mechanical Surface Detection)
- Phantom: SAM1; Type: SAM
- Measurement SW: OpenSAR V4\_02\_01

**Configuration/GSM850 Mid Touch-Left/Area Scan (6x8x1):** Measurement grid: dx=20mm, dy=20mm

**Configuration/GSM850 Mid Touch-Left/Zoom Scan (5x5x7)/Cube 0:** Measurement grid: dx=8mm, dy=8mm, dz=5mm

<b>Area Scan</b>	sam_direct_droit2_surf8mm.txt
<b>ZoomScan</b>	5x5x7,dx=8mm dy=8mm dz=5mm,Very fast
<b>Phantom</b>	Left head
<b>Device Position</b>	Cheek
<b>Band</b>	GSM850
<b>Channels</b>	Low
<b>Signal</b>	TDMA (Crest factor: 8.0)

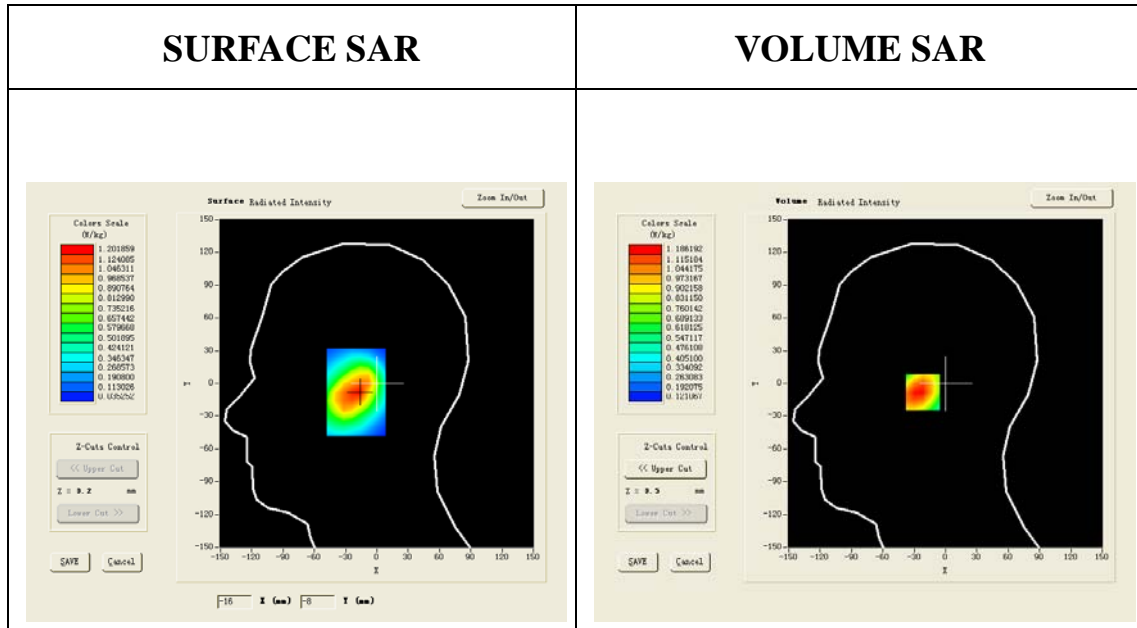

**Maximum location: X=-18.00, Y=-8.00**

<b>SAR 10g (W/Kg)</b>	0.779744
<b>SAR 1g (W/Kg)</b>	1.146590

Z (mm)	0.00	4.00	9.00	14.00	19.00
SAR (W/Kg)	0.0000	1.1862	0.8946	0.6585	0.4690

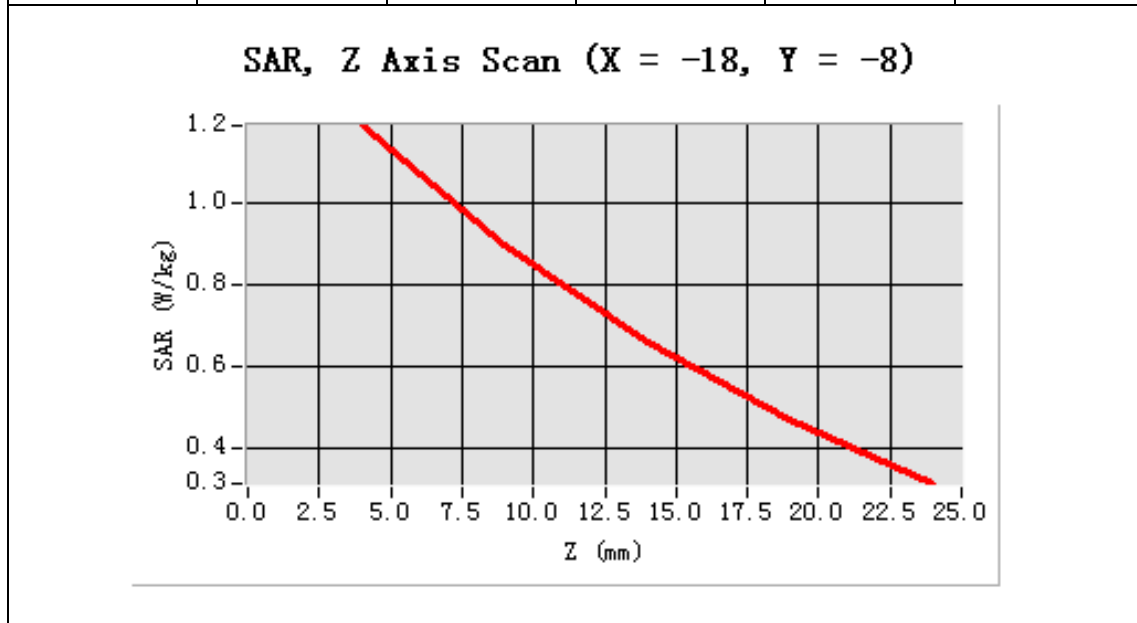

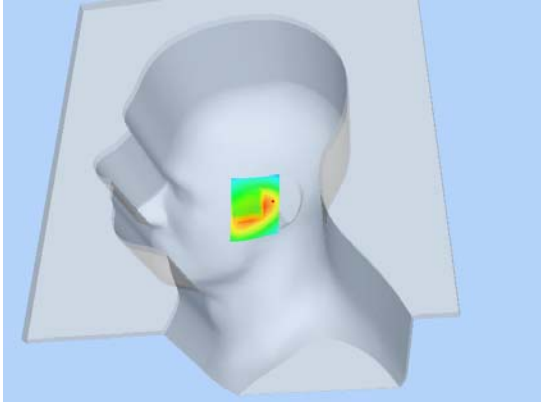
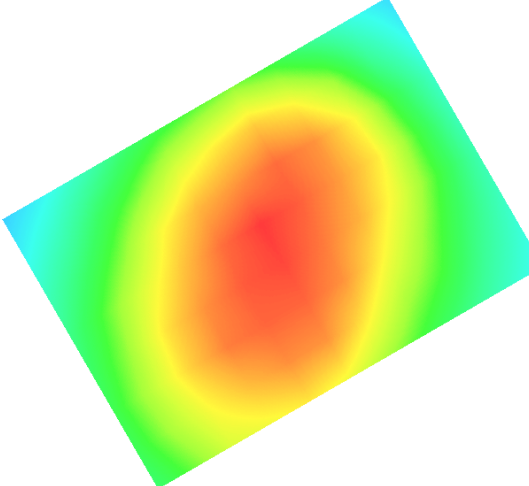
3D screen shot	Hot spot position
 A 3D rendering of a human head model in profile, facing left. A small, rectangular, multi-colored hot spot is overlaid on the side of the head, near the ear. The hot spot shows a gradient from green to yellow to red, indicating a localized area of high intensity.	 A 2D diagram showing a large, irregularly shaped area of high intensity. The area is colored with a gradient from green to yellow to red, indicating a localized area of high intensity. The shape is roughly circular but elongated and tilted.

Test Laboratory: AGC Lab

**Date:MAR.01.2012**

GSM 850 Middle-touch-Left &lt;SIM 1&gt;

**DUT:GSM MOBILE PHONE; Type: ROCK MINI**

Communication System: Generic GSM; Communication System Band: GSM 850; DutyCycle:1: 8; Conv.F=6.79

Frequency: 836.6 MHz; Medium parameters used:  $f = 835$  MHz;  $\sigma = 0.91$  mho/m;  $\epsilon_r = 40.83$ ; $\rho = 1000$  kg/m<sup>3</sup> ; Phantom section: Left Section

Ambient temperature (°C): 21, Liquid temperature (°C): 21

Satimo Configuration:

Probe:SSE5; Calibrated: 09/12/2011

- Sensor-Surface: 4mm (Mechanical Surface Detection)
- Phantom: SAM1; Type: SAM
- Measurement SW: OpenSAR V4\_02\_01

**Configuration/GSM850 Mid Touch-Left/Area Scan (6x8x1):** Measurement grid: dx=20mm, dy=20mm**Configuration/GSM850 Mid Touch-Left/Zoom Scan (5x5x7)/Cube 0:** Measurement grid: dx=8mm, dy=8mm, dz=5mm

<b>Area Scan</b>	sam_direct_droit2_surf8mm.txt
<b>ZoomScan</b>	5x5x7,dx=8mm dy=8mm dz=5mm,Very fast
<b>Phantom</b>	Left head
<b>Device Position</b>	Cheek
<b>Band</b>	GSM850
<b>Channels</b>	Middle
<b>Signal</b>	TDMA (Crest factor: 8.0)



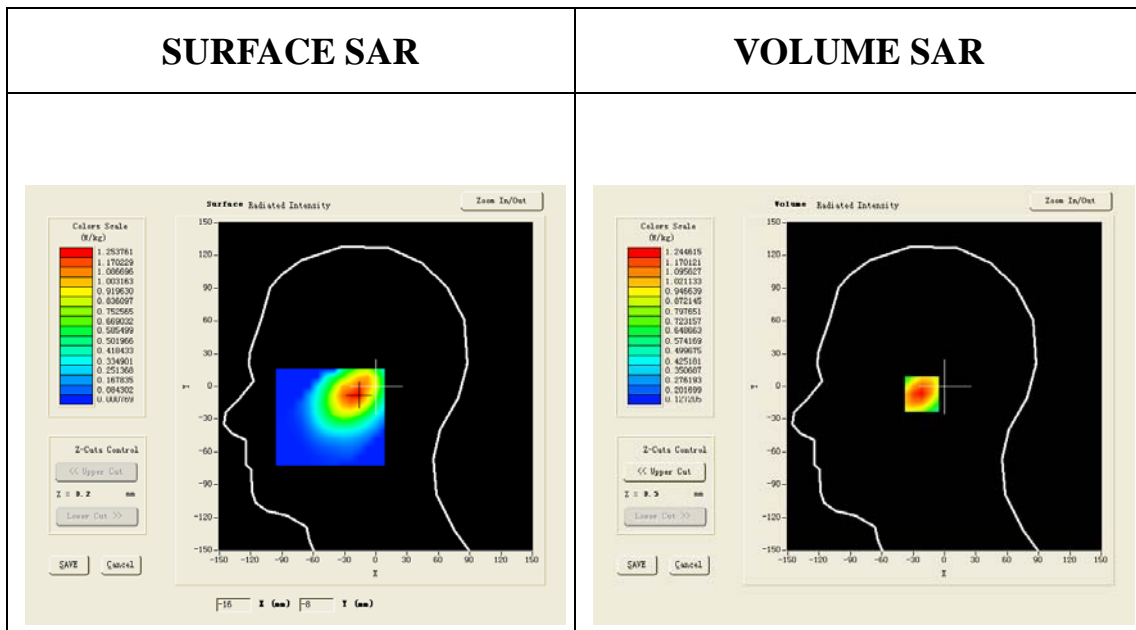

**Maximum location: X=-18.00, Y=-7.00**

<b>SAR 10g (W/Kg)</b>	0.790835
<b>SAR 1g (W/Kg)</b>	1.186893

<b>Z (mm)</b>	<b>0.00</b>	<b>4.00</b>	<b>9.00</b>	<b>14.00</b>	<b>19.00</b>
<b>SAR (W/Kg)</b>	<b>0.0000</b>	<b>1.2446</b>	<b>0.8991</b>	<b>0.6495</b>	<b>0.4694</b>

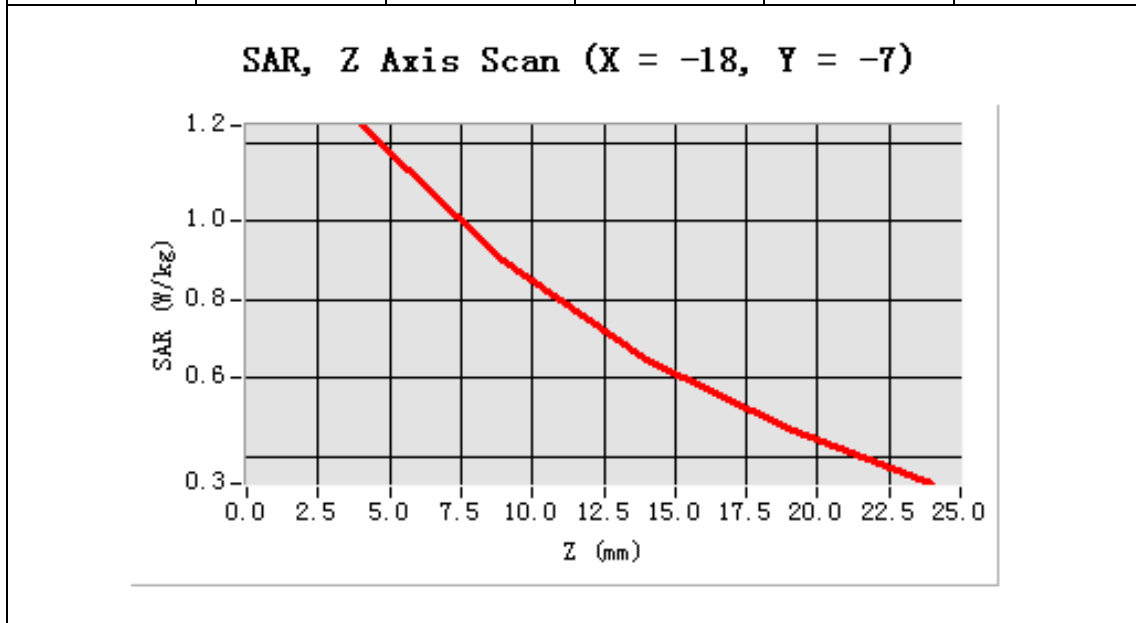

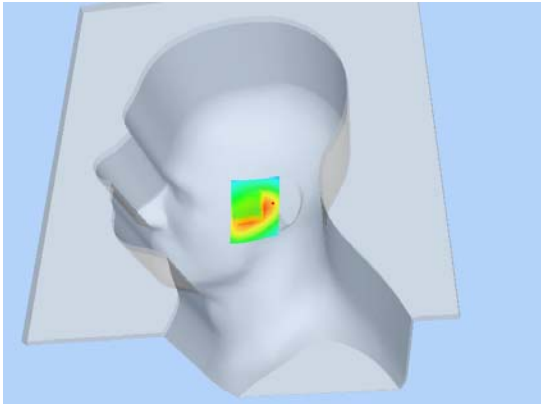
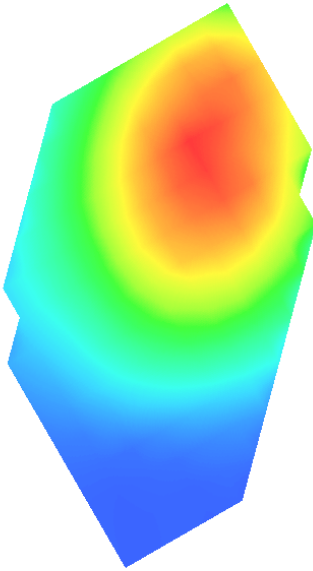
3D screen shot	Hot spot position
 A 3D rendering of a human head model in profile, facing left. A small, rectangular, multi-colored hot spot is visible on the forehead area. The hot spot uses a color gradient from blue (low intensity) to red (high intensity).	 A detailed, irregularly shaped hot spot visualization. It features a central red core, surrounded by concentric rings of orange, yellow, green, and blue, indicating a gradient of intensity. The shape is roughly circular but elongated and irregular.

Test Laboratory: AGC Lab

Date:MAR.01.2012

GSM 850 High-touch-Left <SIM 1>

**DUT:GSM MOBILE PHONE; Type: ROCK MINI**

Communication System: Generic GSM; Communication System Band: GSM 850; DutyCycle:1: 8; Conv.F=6.79  
Frequency: 836.6 MHz; Medium parameters used:  $f = 835$  MHz;  $\sigma = 0.91$  mho/m;  $\epsilon_r = 40.83$ ;  
 $\rho = 1000$  kg/m<sup>3</sup> ; Phantom section: Left Section  
Ambient temperature (°C): 21, Liquid temperature (°C): 21

Satimo Configuration:

Probe:SSE5; Calibrated: 09/12/2011

- Sensor-Surface: 4mm (Mechanical Surface Detection)
- Phantom: SAM1; Type: SAM
- Measurement SW: OpenSAR V4\_02\_01

**Configuration/GSM850 Mid Touch-Left/Area Scan (6x8x1):** Measurement grid: dx=20mm, dy=20mm

**Configuration/GSM850 Mid Touch-Left/Zoom Scan (5x5x7)/Cube 0:** Measurement grid: dx=8mm, dy=8mm, dz=5mm

<b>Area Scan</b>	sam_direct_droit2_surf8mm.txt
<b>ZoomScan</b>	5x5x7,dx=8mm dy=8mm dz=5mm,Very fast
<b>Phantom</b>	Left head
<b>Device Position</b>	Cheek
<b>Band</b>	GSM850
<b>Channels</b>	High
<b>Signal</b>	TDMA (Crest factor: 8.0)

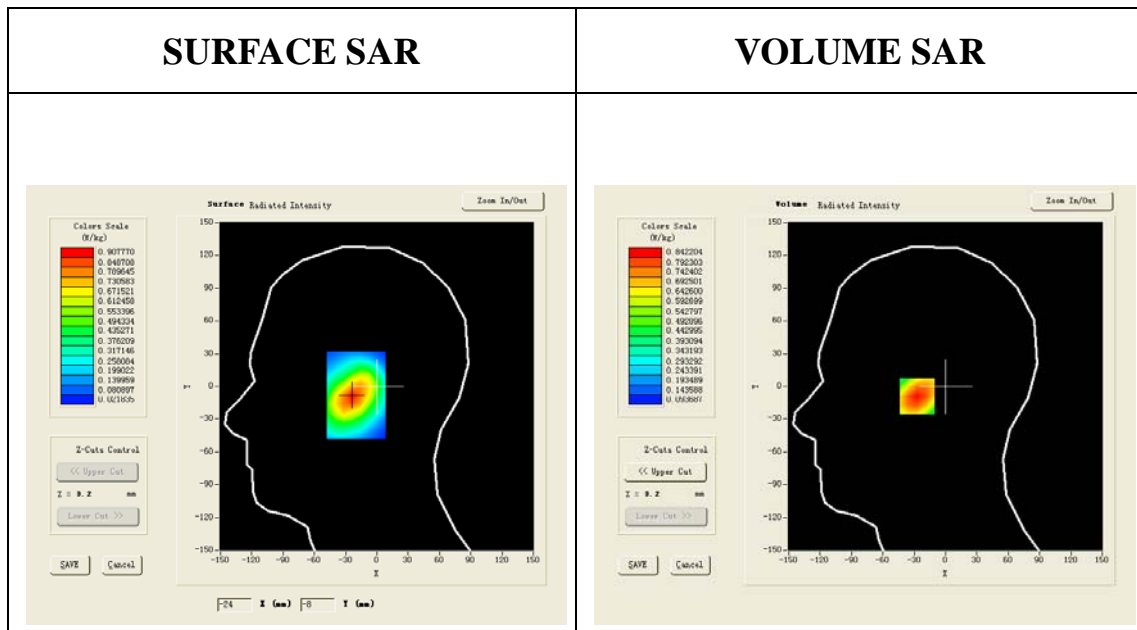

**Maximum location: X=-24.00, Y=-9.00**

<b>SAR 10g (W/Kg)</b>	0.546624
<b>SAR 1g (W/Kg)</b>	0.803155

<b>Z (mm)</b>	<b>0.00</b>	<b>4.00</b>	<b>9.00</b>	<b>14.00</b>	<b>19.00</b>
<b>SAR (W/Kg)</b>	<b>0.0000</b>	<b>0.8422</b>	<b>0.6220</b>	<b>0.4542</b>	<b>0.3265</b>

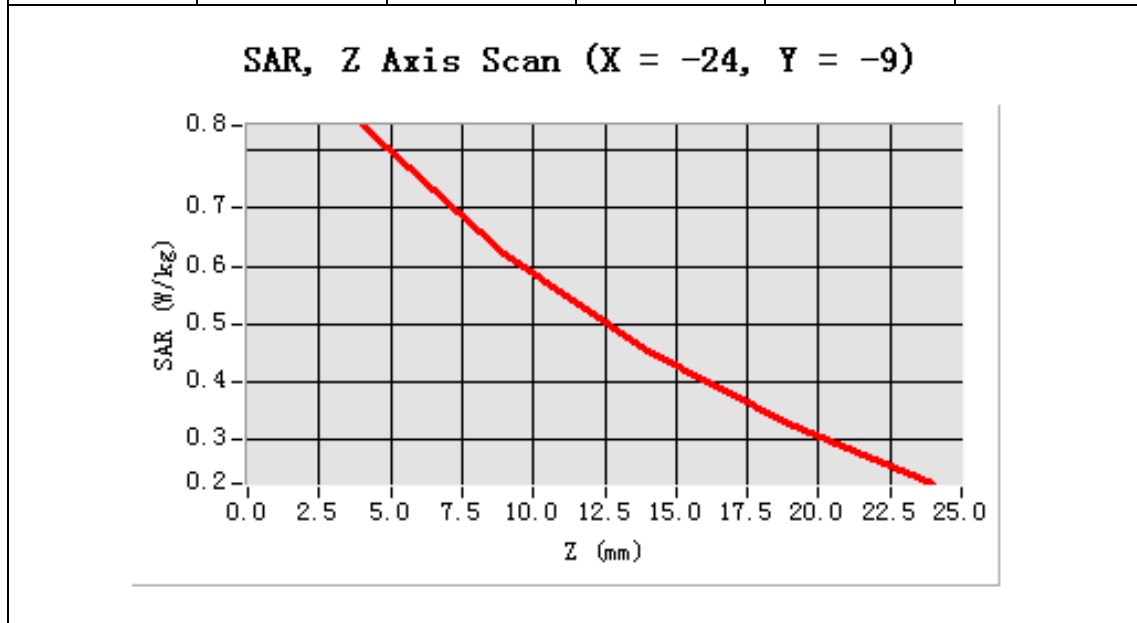

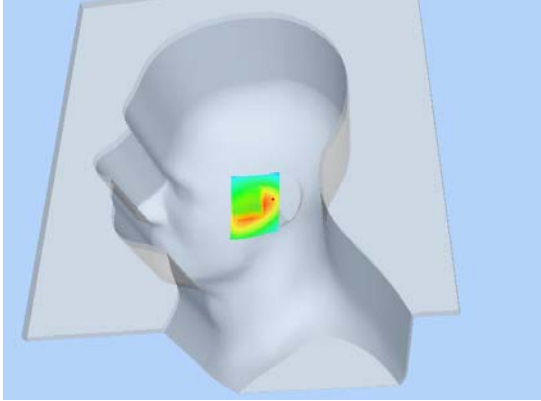
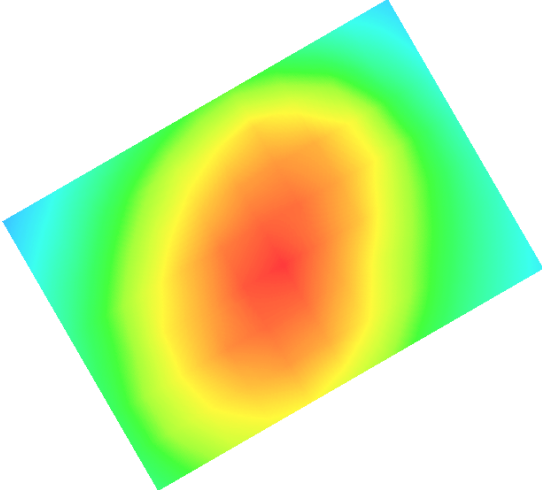
3D screen shot	Hot spot position
 A 3D rendering of a human head model in profile, facing left. A small, rectangular, multi-colored hot spot is overlaid on the side of the head, near the ear. The hot spot colors transition from red in the center to yellow, green, and cyan towards the edges.	 A close-up view of the hot spot position. It is a rectangular area with a color gradient. The center is red, transitioning through orange and yellow to green and cyan at the edges. The entire area is tilted at an angle.

Test Laboratory: AGC Lab

Date:MAR.01.2012

GSM 850 Mid Tilt-left <SIM 1>

**DUT:GSM MOBILE PHONE; Type: ROCK MINI**

Communication System: Generic GSM; Communication System Band: GSM 850; DutyCycle:1: 8; Conv.F=6.79

Frequency: 836.6 MHz; Medium parameters used:  $f = 835$  MHz;  $\sigma = 0.91$  mho/m;  $\epsilon_r = 40.83$ ;

$\rho = 1000$  kg/m<sup>3</sup> ; Phantom section: Left Section

Ambient temperature (°C): 21, Liquid temperature (°C): 21

Satimo Configuration:

Probe:SSE5; Calibrated: 09/12/2011

- Sensor-Surface: 4mm (Mechanical Surface Detection)
- Phantom: SAM1; Type: SAM
- Measurement SW: OpenSAR V4\_02\_01

**Configuration/GSM850 Mid Tilt-Left/Area Scan (6x8x1):** Measurement grid: dx=20mm, dy=20mm

**Configuration/GSM850 Mid Tilt-Left/Zoom Scan (5x5x7)/Cube 0:** Measurement grid: dx=8mm, dy=8mm, dz=5mm;

<b>Area Scan</b>	sam_direct_droit2_surf8mm.txt
<b>ZoomScan</b>	5x5x7,dx=8mm dy=8mm dz=5mm,Very fast
<b>Phantom</b>	Left head
<b>Device Position</b>	Tilt
<b>Band</b>	GSM850
<b>Channels</b>	Middle
<b>Signal</b>	TDMA (Crest factor: 8.0)

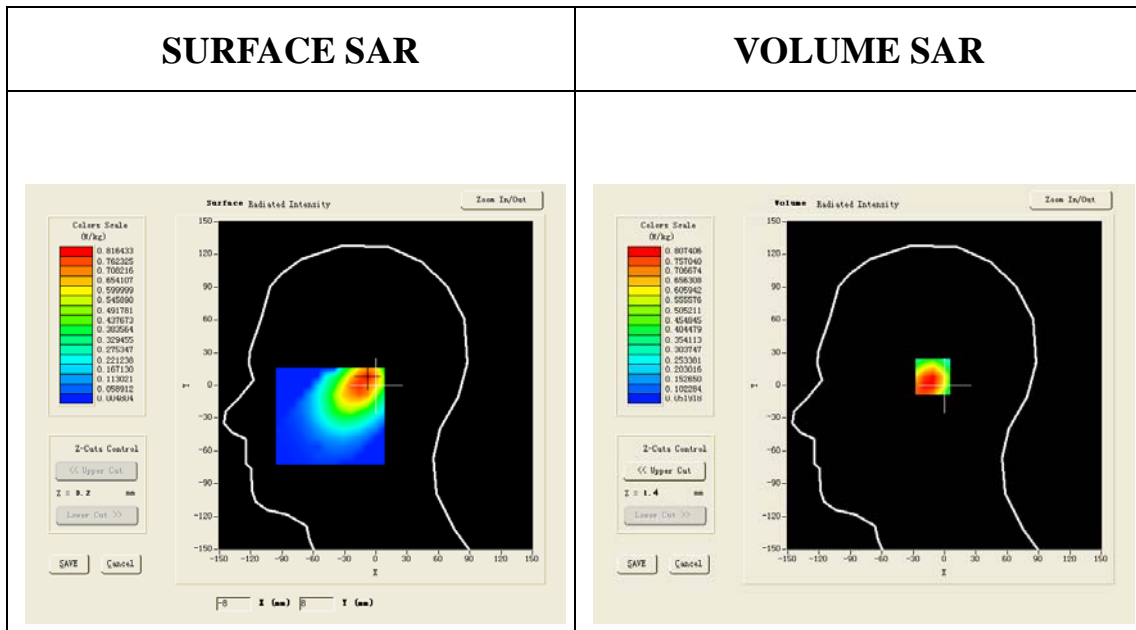

**Maximum location: X=-8.00, Y=8.00**

<b>SAR 10g (W/Kg)</b>	0.520555
<b>SAR 1g (W/Kg)</b>	0.789671

<b>Z (mm)</b>	<b>0.00</b>	<b>4.00</b>	<b>9.00</b>	<b>14.00</b>	<b>19.00</b>
<b>SAR (W/Kg)</b>	<b>0.0000</b>	<b>0.8074</b>	<b>0.5849</b>	<b>0.4178</b>	<b>0.2929</b>

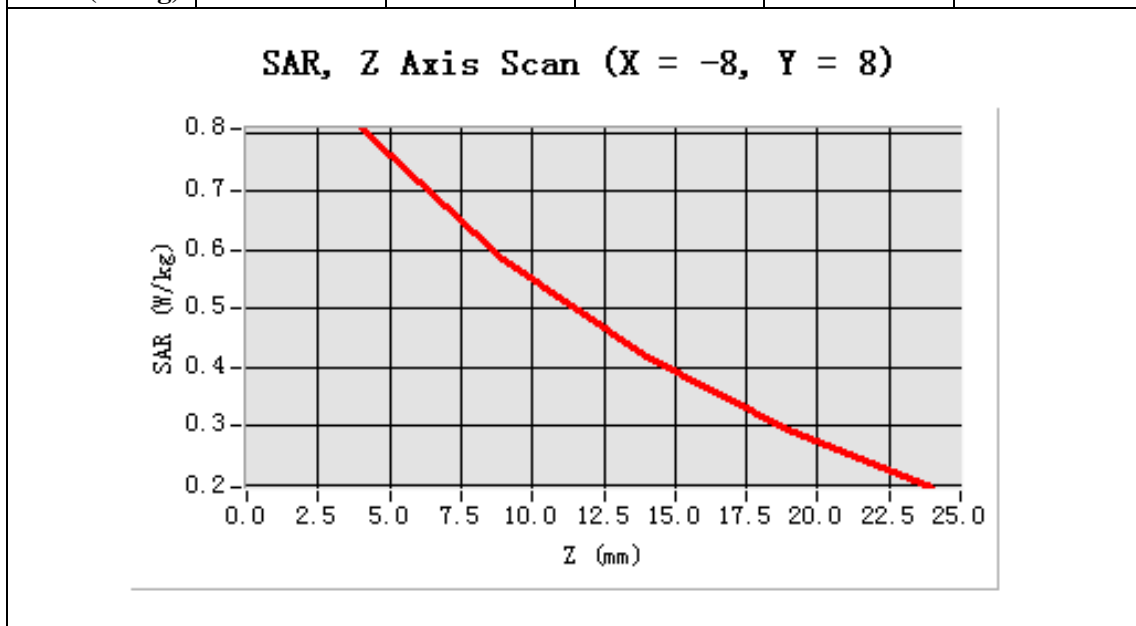

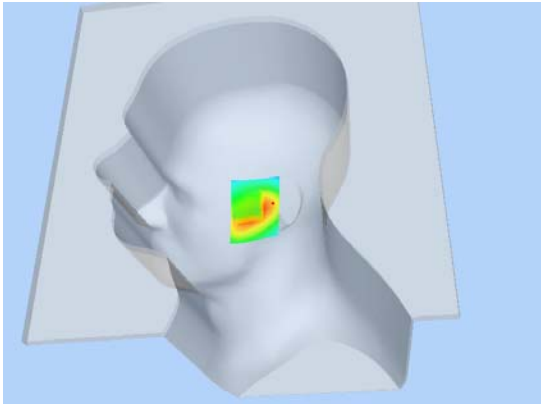
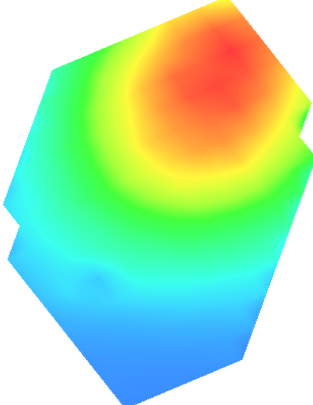
3D screen shot	Hot spot position
 A 3D rendering of a human head model in profile, facing left. A small, localized area on the forehead is highlighted with a color gradient from blue to red, indicating a hot spot. The rest of the head and neck are shown in a light gray color.	 A close-up view of the hot spot area. It shows a color gradient from blue at the bottom to red at the top, with yellow and green in between, representing the intensity of the hot spot. The shape is roughly circular and slightly irregular.



Test Laboratory: AGC Lab

**Date:MAR.01.2012**

GSM 850 Middle touch-Right <SIM 1>

**DUT:GSM MOBILE PHONE; Type: ROCK MINI**

Communication System: Generic GSM; Communication System Band: GSM 850; DutyCycle:1: 8; Conv.F=6.79  
Frequency: 836.6 MHz; Medium parameters used:  $f = 835$  MHz;  $\sigma = 0.91$  mho/m;  $\epsilon_r = 40.83$ ;  
 $\rho = 1000$  kg/m<sup>3</sup> ; Phantom section: Right Section  
Ambient temperature (°C): 21, Liquid temperature (°C): 21

Satimo Configuration:

Probe:SSE5; Calibrated: 09/12/2011

- Sensor-Surface: 4mm (Mechanical Surface Detection)
- Phantom: SAM1; Type: SAM
- Measurement SW: OpenSAR V4\_02\_01

**Configuration/GSM850 Mid Touch-Right/Area Scan:** Measurement grid: dx=20mm, dy=20mm

**Configuration/GSM850 Mid Touch-Right/Zoom Scan:** Measurement grid: dx=8mm,  
dy=8mm, dz=5mm;

<b>Area Scan</b>	sam_direct_droit2_surf8mm.txt
<b>ZoomScan</b>	5x5x7,dx=8mm dy=8mm dz=5mm,Very fast
<b>Phantom</b>	Right head
<b>Device Position</b>	Cheek
<b>Band</b>	GSM850
<b>Channels</b>	Middle
<b>Signal</b>	TDMA (Crest factor: 8.0)

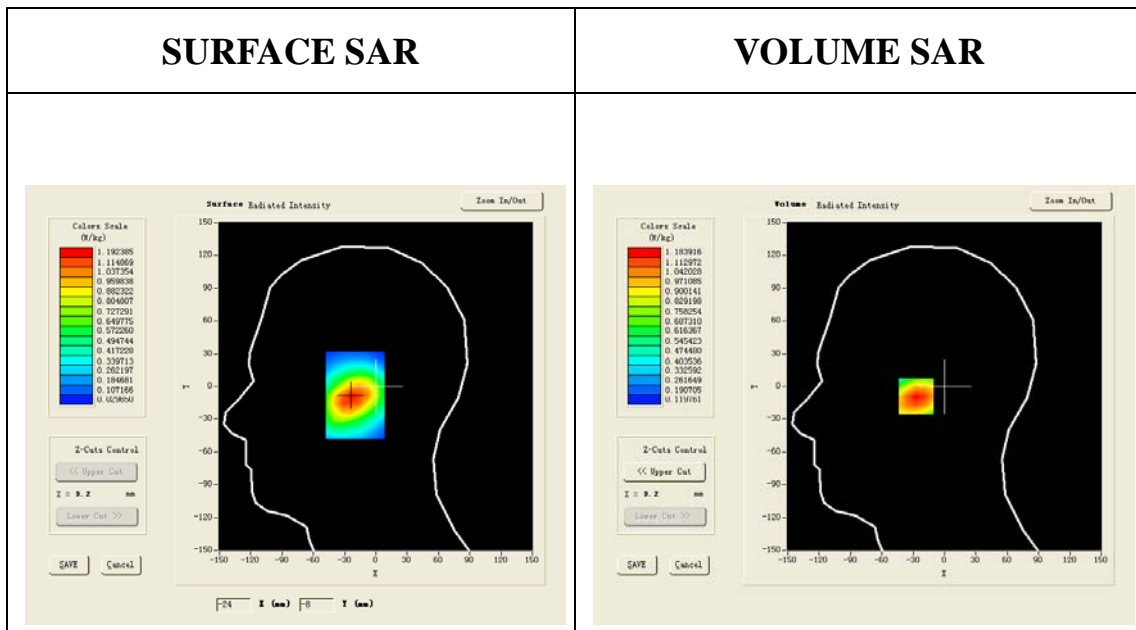

**Maximum location: X=-24.00, Y=-9.00**

<b>SAR 10g (W/Kg)</b>	0.752094
<b>SAR 1g (W/Kg)</b>	1.130145

<b>Z (mm)</b>	<b>0.00</b>	<b>4.00</b>	<b>9.00</b>	<b>14.00</b>	<b>19.00</b>
<b>SAR (W/Kg)</b>	<b>0.0000</b>	<b>1.1839</b>	<b>0.8426</b>	<b>0.6049</b>	<b>0.4399</b>

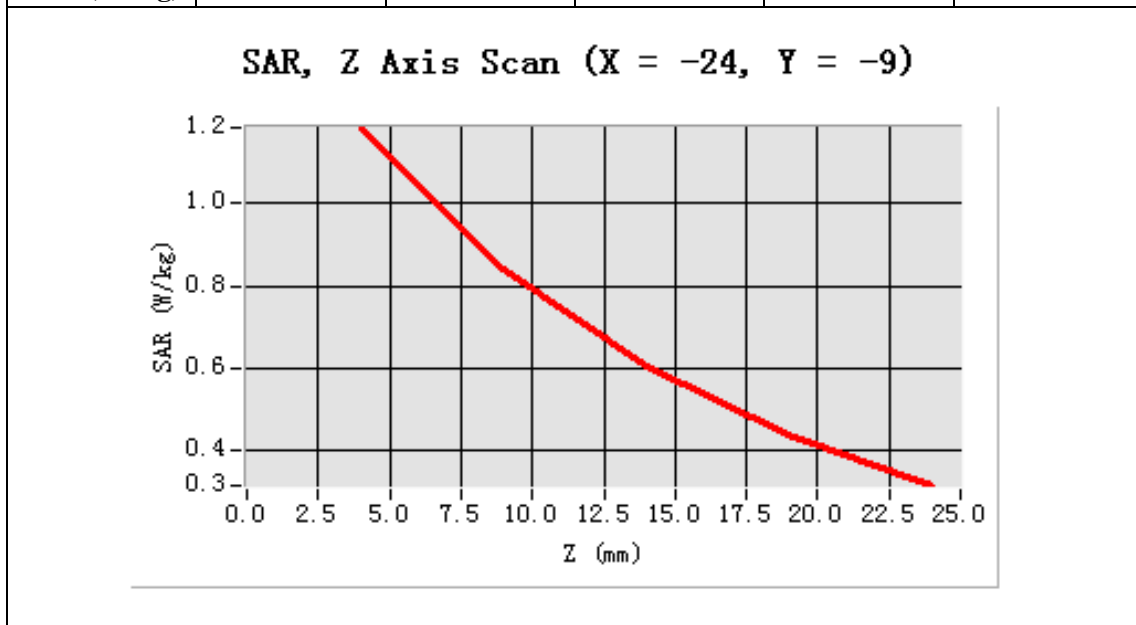

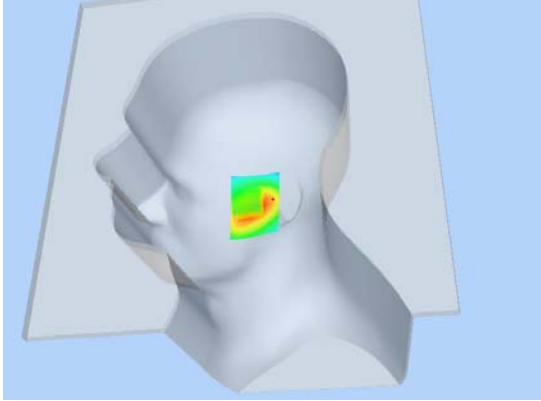
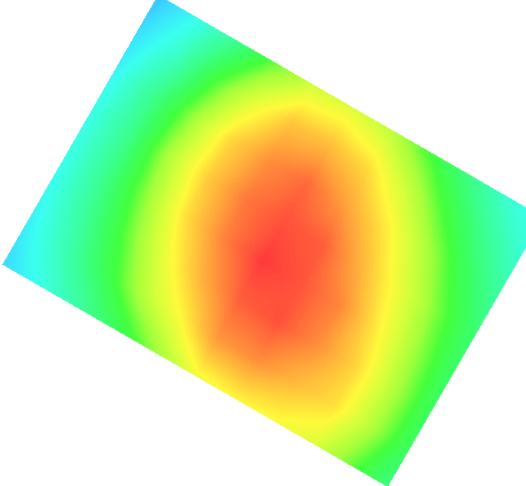
3D screen shot	Hot spot position
 A 3D rendering of a human head model in profile, facing left. A small, rectangular, multi-colored hot spot is visible on the side of the head, near the ear. The hot spot shows a gradient from green to yellow to red, indicating a localized area of high intensity.	 A 2D diagram showing a circular hot spot. The center of the circle is red, transitioning through orange and yellow to green and cyan at the edges. The diagram is tilted at an angle, suggesting it is a cross-section or a specific view of the hot spot's position.

Test Laboratory: AGC Lab

**Date:MAR.01.2012**

GSM 850 Mid-tilt-Right <SIM 1>

**DUT:GSM MOBILE PHONE; Type: ROCK MINI**

Communication System: Generic GSM; Communication System Band: GSM 850; DutyCycle:1: 8; Conv.F=6.79

Frequency: 836.6 MHz; Medium parameters used:  $f = 835$  MHz;  $\sigma = 0.91$  mho/m;  $\epsilon_r = 40.83$ ;

$\rho = 1000$  kg/m<sup>3</sup> ; Phantom section:Right Section

Ambient temperature (°C): 21, Liquid temperature (°C): 21

Satimo Configuration:

Probe:SSE5; Calibrated: 09/12/2011

- Sensor-Surface: 4mm (Mechanical Surface Detection)
- Phantom: SAM1; Type: SAM
- Measurement SW: OpenSAR V4\_02\_01

**Configuration/GSM850 Mid Tilt-Right/Area Scan:** Measurement grid: dx=20mm, dy=20mm

**Configuration/GSM850 Mid Tilt-Right/Zoom Scan:** Measurement grid: dx=8mm,  
dy=8mm, dz=5mm;

<b>Area Scan</b>	sam_direct_droit2_surf8mm.txt
<b>Zoom Scan</b>	5x5x7,dx=8mm dy=8mm dz=5mm,Very fast
<b>Phantom</b>	Right head
<b>Device Position</b>	Tilt
<b>Band</b>	GSM850
<b>Channels</b>	Middle
<b>Signal</b>	TDMA (Crest factor: 8.0)

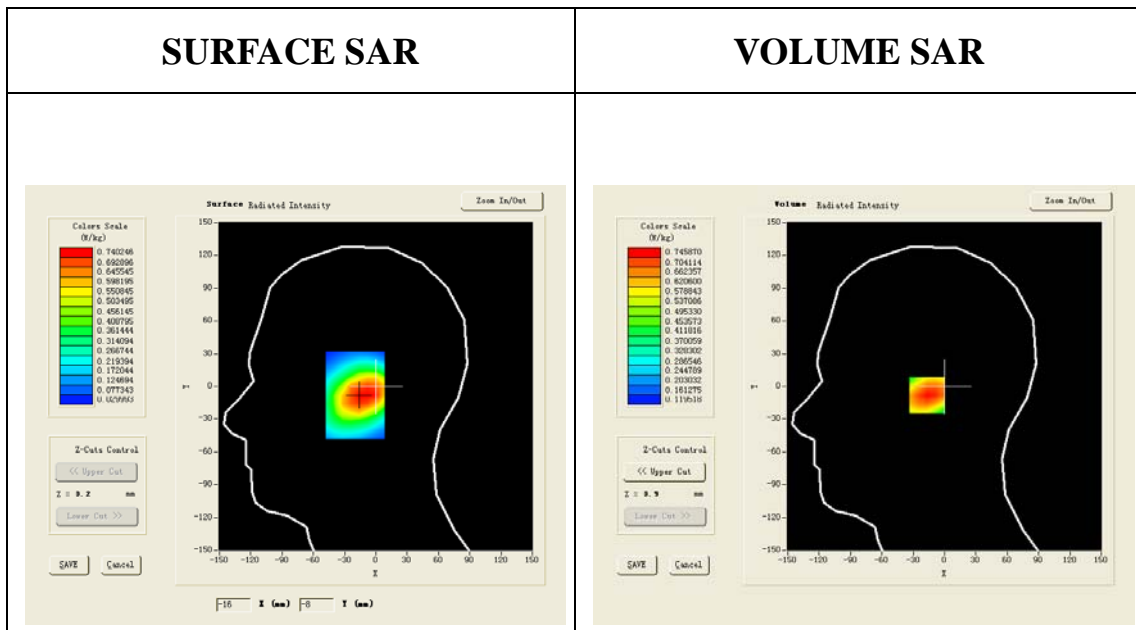

**Maximum location: X=-13.00, Y=-8.00**

<b>SAR 10g (W/Kg)</b>	0.506484
<b>SAR 1g (W/Kg)</b>	0.714791

<b>Z (mm)</b>	<b>0.00</b>	<b>4.00</b>	<b>9.00</b>	<b>14.00</b>	<b>19.00</b>
<b>SAR (W/Kg)</b>	<b>0.0000</b>	<b>0.7459</b>	<b>0.5690</b>	<b>0.4298</b>	<b>0.3204</b>

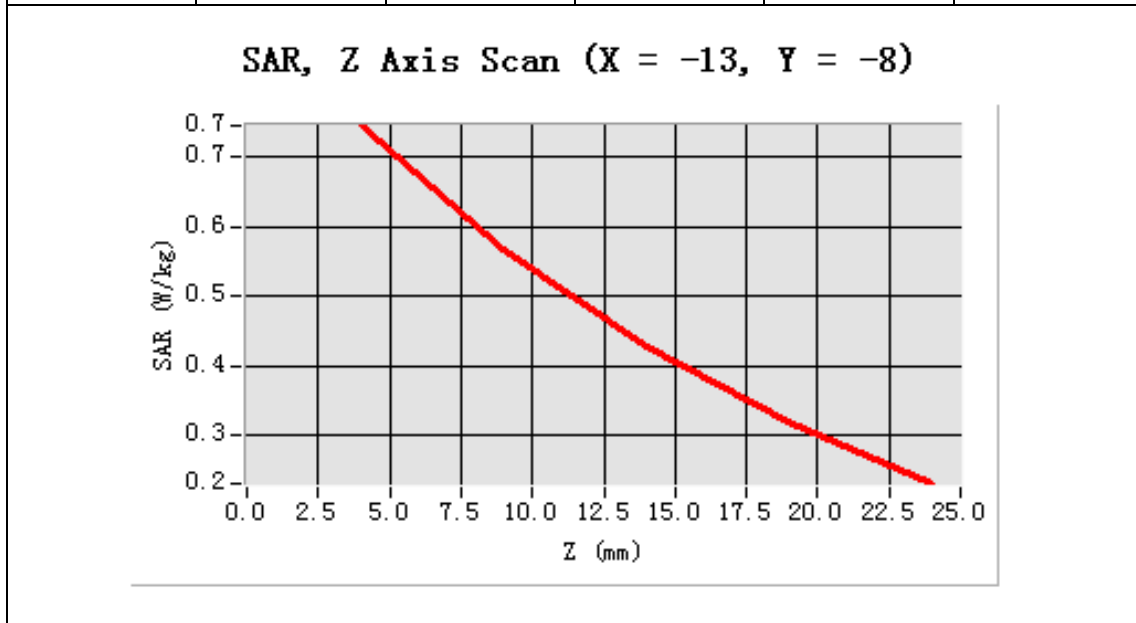

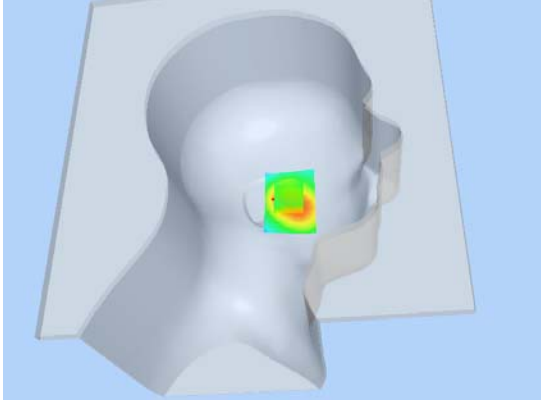
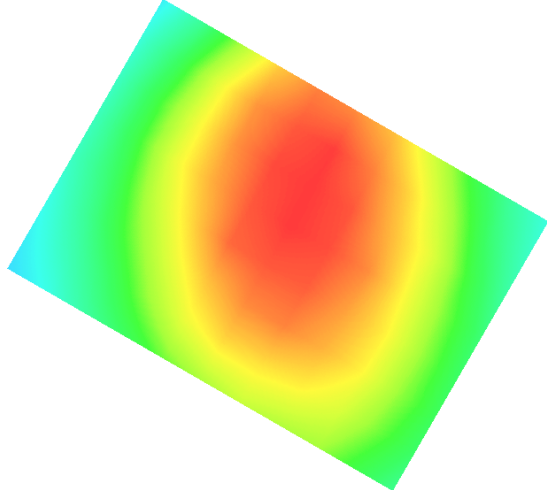
3D screen shot	Hot spot position
 A 3D rendering of a human head model in profile, facing right. A small, localized area on the ear is highlighted with a color gradient from green to red, indicating a hot spot. The rest of the head and neck are shown in a light gray color.	 A 2D diagram showing a circular gradient of colors. The center is red, transitioning through orange and yellow to green at the edges. The diagram is tilted at an angle, suggesting it is a cross-section or a specific view of the hot spot area.

Test Laboratory: AGC Lab

Date:MAR.01.2012

GSM 850 Middle touch-Left<SIM 2>

**DUT:GSM MOBILE PHONE; Type: ROCK MINI**

Communication System: Generic GSM; Communication System Band: GSM 850; DutyCycle:1: 8; Conv.F=6.79  
Frequency: 836.6 MHz; Medium parameters used:  $f = 835$  MHz;  $\sigma = 0.91$  mho/m;  $\epsilon_r = 40.83$ ;  
 $\rho = 1000$  kg/m<sup>3</sup> ; Phantom section: Left Section  
Ambient temperature (°C): 21, Liquid temperature (°C): 21

Satimo Configuration:

Probe:SSE5; Calibrated: 09/12/2011

- Sensor-Surface: 4mm (Mechanical Surface Detection)
- Phantom: SAM1; Type: SAM
- Measurement SW: OpenSAR V4\_02\_01

**Configuration/GSM850 Mid Touch-Right/Area Scan:** Measurement grid: dx=20mm, dy=20mm

**Configuration/GSM850 Mid Touch-Right/Zoom Scan:** Measurement grid: dx=8mm,  
dy=8mm, dz=5mm;

<b>Area Scan</b>	sam_direct_droit2_surf8mm.txt
<b>ZoomScan</b>	5x5x7,dx=8mm dy=8mm dz=5mm,Very fast
<b>Phantom</b>	Left head
<b>Device Position</b>	Cheek
<b>Band</b>	GSM850
<b>Channels</b>	Middle
<b>Signal</b>	TDMA (Crest factor: 8.0)

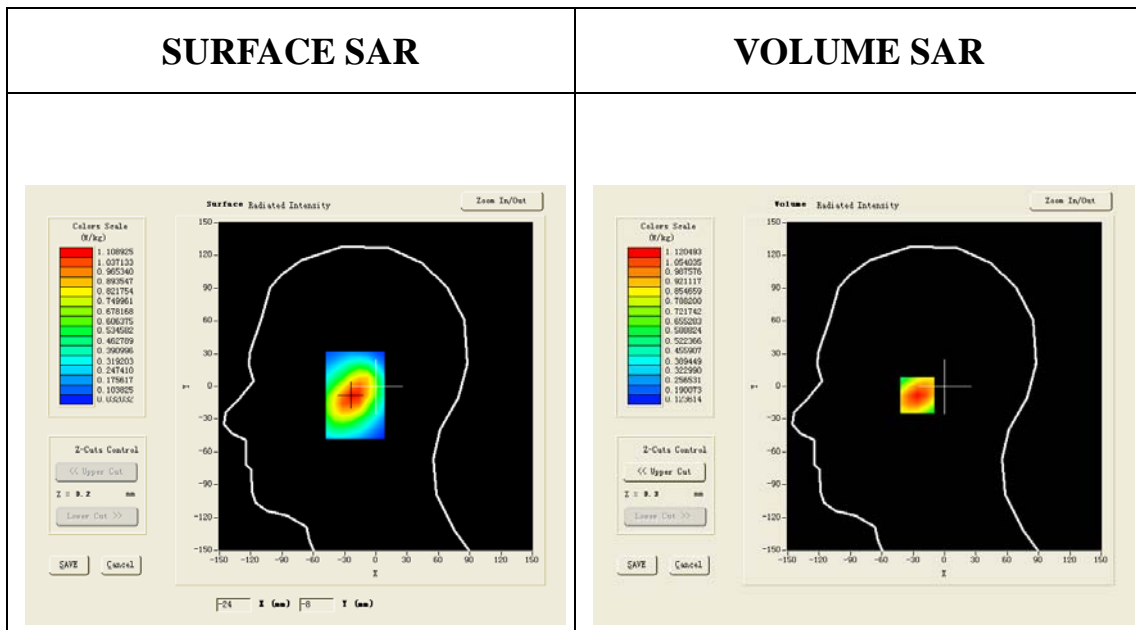

**Maximum location: X=-23.00, Y=-8.00**

<b>SAR 10g (W/Kg)</b>	0.715222
<b>SAR 1g (W/Kg)</b>	1.066541

<b>Z (mm)</b>	<b>0.00</b>	<b>4.00</b>	<b>9.00</b>	<b>14.00</b>	<b>19.00</b>
<b>SAR (W/Kg)</b>	<b>0.0000</b>	<b>1.1205</b>	<b>0.8038</b>	<b>0.5798</b>	<b>0.4218</b>

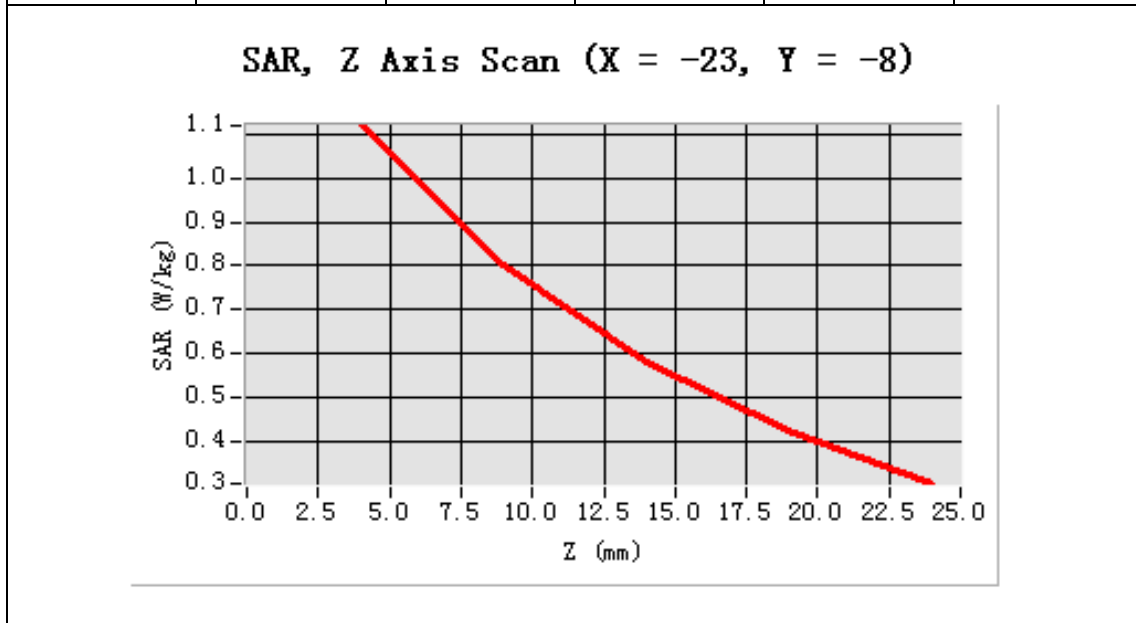

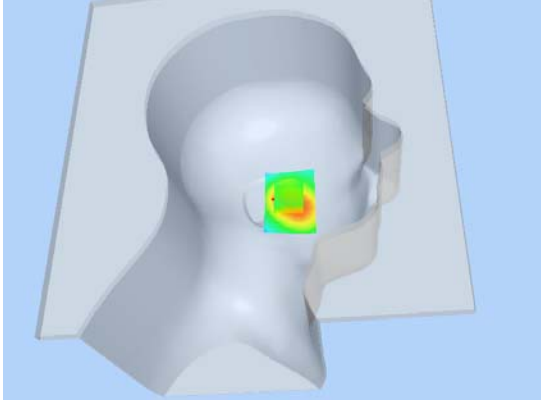
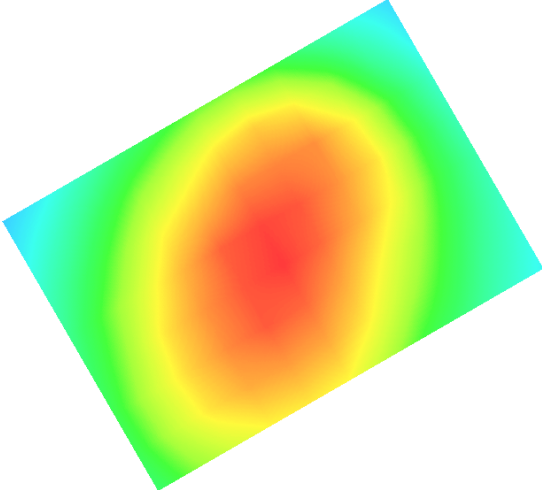

3D screen shot	Hot spot position
 A 3D rendering of a human head model in profile, facing right. A small, rectangular area on the ear is highlighted with a color gradient from green to red, indicating a hot spot. The rest of the head and neck are shown in a light gray color.	 A 2D diagram showing a color gradient representing a hot spot. The gradient starts with green at the corners and transitions through yellow to a bright red center, indicating the highest intensity. The shape is roughly rectangular with rounded corners.

Test Laboratory: AGC Lab

Date:MAR.01.2012

GSM 850 Mid-Body-Worn Front <SIM 1>

**DUT:GSM MOBILE PHONE; Type:ROCK MINI**

Communication System: Generic GSM; Communication System Band: GSM 850; Duty Cycle: 1:8; Conv.F=6.79  
Frequency: 836.6 MHz; Medium parameters used:  $f = 835$  MHz;  $\sigma = 0.99$  mho/m;  $\epsilon_r = 55.80$ ;  $\rho = 1000$  kg/m<sup>3</sup> ;  
Phantom section: Flat Section  
Ambient temperature (°C):21, Liquid temperature (°C):21

Satimo Configuration:

Probe:SSE5; Calibrated: 09/12/2011

- Sensor-Surface: 4mm (Mechanical Surface Detection)
- Phantom: SAM1; Type: SAM
- Measurement SW: OpenSAR V4\_02\_01

**Configuration/GSM850 Mid Body-Front/Area Scan (6x8x1):** Measurement grid: dx=20mm, dy=20mm

**Configuration/GSM850 Mid Body-Front/Zoom Scan (5x5x7)/Cube 0:** Measurement grid: dx=8mm, dy=8mm, dz=5mm;

<b>Area Scan</b>	surf_sam_plan.txt
<b>ZoomScan</b>	5x5x7,dx=8mm dy=8mm dz=5mm,Very fast
<b>Phantom</b>	Validation plane
<b>Device Position</b>	Body Front
<b>Band</b>	GSM850
<b>Channels</b>	Middle
<b>Signal</b>	TDMA (Crest factor: 8.0)