



FCC Test Report

Report No.: AGC00572130501FE04

FCC ID : C89-G2
APPLICATION PURPOSE : Original Equipment
PRODUCT DESIGNATION : Tablet PC
BRAND NAME : Ice Mobile
MODEL NAME : G2
CLIENT : Dynamics Hong Kong Limited
DATE OF ISSUE : May 23,2013
STANDARD(S) : FCC Part 15 Rules
REPORT VERSION : V1.0

Attestation of **Global Compliance (Shenzhen) Co., Ltd**



CAUTION:

This report shall not be reproduced except in full without the written permission of the test laboratory and shall not be quoted out of context.

Report Revise Record

Report Version	Revise Time	Issued Date	Valid Version	Notes
V1.0	/	May 23,2013	Valid	Original Report

TABLE OF CONTENTS

1. VERIFICATION OF CONFORMITY	5
2. GENERAL INFORMATION	6
2.1. PRODUCT DESCRIPTION.....	6
2.2. TABLE OF CARRIER FREQUENCIES.....	6
2.3. IEEE 802.11N MODULATION SCHEME	7
2.4. RELATED SUBMITTAL(S) / GRANT (S).....	7
2.5. TEST METHODOLOGY.....	7
2.6. SPECIAL ACCESSORIES	7
2.7. EQUIPMENT MODIFICATIONS	7
3. MEASUREMENT UNCERTAINTY.....	8
4. DESCRIPTION OF TEST MODES.....	8
5. SYSTEM TEST CONFIGURATION	9
5.1. CONFIGURATION OF EUT SYSTEM	9
5.2. EQUIPMENT USED IN EUT SYSTEM	9
5.3. SUMMARY OF TEST RESULTS	9
6. TEST FACILITY	10
7. PEAK OUTPUT POWER	11
7.1. MEASUREMENT PROCEDURE	11
7.2. TEST SET-UP (BLOCK DIAGRAM OF CONFIGURATION).....	11
7.3. LIMITS AND MEASUREMENT RESULT	12
8. 6DB BANDWIDTH	14
8.1. MEASUREMENT PROCEDURE	14
8.2. TEST SET-UP (BLOCK DIAGRAM OF CONFIGURATION).....	14
8.3. LIMITS AND MEASUREMENT RESULTS.....	15
9. CONDUCTED SPURIOUS EMISSION	25
9.1. MEASUREMENT PROCEDURE	25
9.2. TEST SET-UP (BLOCK DIAGRAM OF CONFIGURATION).....	25
9.3. MEASUREMENT EQUIPMENT USED.....	25
9.4. LIMITS AND MEASUREMENT RESULT	25
10. MAXIMUM CONDUCTED OUTPUT POWER SPECTRAL DENSITY	28
10.1 MEASUREMENT PROCEDURE	28
10.2 TEST SET-UP (BLOCK DIAGRAM OF CONFIGURATION).....	28
10.3 MEASUREMENT EQUIPMENT USED.....	28
10.4 LIMITS AND MEASUREMENT RESULT	28

- 11. RADIATED EMISSION 38**
 - 11.1. MEASUREMENT PROCEDURE38
 - 11.2. TEST SETUP39
 - 11.3. LIMITS AND MEASUREMENT RESULT 40
 - 11.4. TEST RESULT40
- 12. BAND EDGE EMISSION 49**
 - 12.1. MEASUREMENT PROCEDURE49
 - 12.2. TEST SET-UP49
 - 12.3. TEST RESULT50
- 13. FCC LINE CONDUCTED EMISSION TEST 58**
 - 13.1. LIMITS OF LINE CONDUCTED EMISSION TEST58
 - 13.2. BLOCK DIAGRAM OF LINE CONDUCTED EMISSION TEST58
 - 13.3. PRELIMINARY PROCEDURE OF LINE CONDUCTED EMISSION TEST59
 - 13.4. FINAL PROCEDURE OF LINE CONDUCTED EMISSION TEST59
 - 13.5. TEST RESULT OF LINE CONDUCTED EMISSION TEST60
- APPENDIX A: PHOTOGRAPHS OF TEST SETUP 62**
- APPENDIX B: PHOTOGRAPHS OF EUT 64**

1. VERIFICATION OF CONFORMITY

Applicant	Dynamics Hong Kong Limited
Address	Room A4, 3/F, Friend's House, No.6A Carnarvon Road, Tsim Sha Tsui, Kowloon, Hong Kong
Manufacturer	Dynamics Hong Kong Limited
Address	Room A4, 3/F, Friend's House, No.6A Carnarvon Road, Tsim Sha Tsui, Kowloon, Hong Kong
Product Designation	Tablet PC
Brand Name	Ice Mobile
Test Model	G2
Date of test	May 14,2013 to May 22,2013
Deviation	None
Condition of Test Sample	Normal
Report Template	AGCRT-US-BGN/RF (2013-03-01)

We hereby certify that:

The above equipment was tested by Attestation of Global Compliance (Shenzhen) Co., Ltd. The test data, data evaluation, test procedures, and equipment configurations shown in this report were made in accordance with the procedures given in ANSI C63.4 (2003) and the energy emitted by the sample EUT tested as described in this report is in compliance with requirement of FCC Part 15 Rules requirement.

Prepared By

Jane Wu

Jane Wu May 23,2013

Checked By

Forrest Lei

Forrest Lei May 23,2013

Authorized By

Solger Zhang

Solger Zhang May 23,2013

2. GENERAL INFORMATION

2.1. PRODUCT DESCRIPTION

The EUT is designed as "Tablet PC". It is designed by way of utilizing the DSSS and OFDM technology to achieve the system operation.

A major technical description of EUT is described as following

Operation Frequency	2.412 GHz ~ 2.462GHz
Max. Output Power	802.11b:12.94Bm , 802.11g:12.33Bm , 802.11n(20):11.95Bm , 802.11n(40):10.62Bm
Modulation	DSSS(BPSK/QPSK/CCK);OFDM(16-QAM/64-QAM)
Data Rate	DSSS(1/2/5.5/11),OFDM(6/9/12/18/24/36/48/54) See section 2.3 for 802.11n
Number of channels	11
Hardware Version	TZX-713B7
Software Version	N/A
Antenna Designation	Integrated Antenna
Antenna Gain	0.8dBi
Power Supply	DC3.7V by Built-in Li-ion Battery

2.2. TABLE OF CARRIER FREQUENCIES

Frequency Band	Channel Number	Frequency
2400~2483.5MHZ	1	2412 MHZ
	2	2417 MHZ
	3	2422 MHZ
	4	2427 MHZ
	5	2432 MHZ
	6	2437 MHZ
	7	2442 MHZ
	8	2447 MHZ
	9	2452 MHZ
	10	2457 MHZ
	11	2462 MHZ

Note: For 20MHZ bandwidth system use Channel 1 to Channel 11
For 40MHZ bandwidth system use Channel 3 to Channel 9

2.3. IEEE 802.11N MODULATION SCHEME

MCS Index	Nss	Modulation	R	NBPS	NCBPS		NDBPS		Data rate(Mbps)	
					20MHz	40MHz	20MHz	40MHz	800nsGI	
									20MHz	40MHz
0	1	BPSK	1/2	1	52	108	26	54	6.5	13.5
1	1	QPSK	1/2	2	104	216	52	108	13.0	27.0
2	1	QPSK	3/4	2	104	216	78	162	19.5	40.5
3	1	16-QAM	1/2	4	208	432	104	216	26.0	54.0
4	1	16-QAM	3/4	4	208	432	156	324	39.0	81.0
5	1	64-QAM	2/3	6	312	648	208	432	52.0	108.0
6	1	64-QAM	3/4	6	312	648	234	489	58.5	121.5
7	1	64-QAM	5/6	6	312	648	260	540	65.0	135.0

Symbol	Explanation
NSS	Number of spatial streams
R	Code rate
NBPS	Number of coded bits per single carrier
NCBPS	Number of coded bits per symbol
NDBPS	Number of data bits per symbol
GI	Guard interval

2.4. RELATED SUBMITTAL(S) / GRANT (S)

This submittal(s) (test report) is intended for **FCC ID: C89-G2** filing to comply with the FCC Part 15 requirements.

2.5. TEST METHODOLOGY

Because the EUT received power from DC3.7V lithium battery, so only radiated testing was performed according to the procedures in ANSI C63.4 (2003). Radiated testing was performed at an antenna to EUT distance 3 meters.

2.6. SPECIAL ACCESSORIES

Refer to section 5.2.

2.7. EQUIPMENT MODIFICATIONS

Not available for this EUT intended for grant.

3. MEASUREMENT UNCERTAINTY

Conducted measurement: +/- 2.75dB

Radiated measurement: +/- 3.2dB

4. DESCRIPTION OF TEST MODES

NO.	TEST MODE DESCRIPTION
1	Low channel TX
2	Middle channel TX
3	High channel TX
4	Normal operating (WiFi)

Note:

Transmit by 802.11b with Data rate (1/2/5.5/11)

Transmit by 802.11g with Data rate (6/9/12/18/24/36/48/54)

Transmit by 802.11n (20MHz) with Data rate (6.5/13/19.5/26/39/52/58.5/65)

Transmit by 802.11n (40MHz) with Data rate

(13.5/27/40.5/54/81/108/121.5/135)

Note:

1. The EUT has been set to operate continuously on the lowest, middle and highest operation frequency individually.
2. All modes under which configure applicable have been tested and the worst mode test data recording in the test report, if no other mode data.
3. For Radiated Emission, 3axis were chosen for testing for each applicable mode.

5. SYSTEM TEST CONFIGURATION

5.1. CONFIGURATION OF EUT SYSTEM

Configure 1:

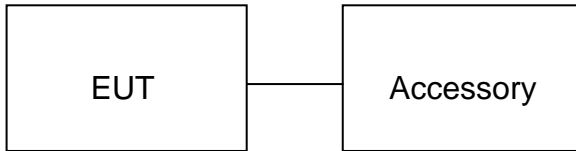

Configure 2:

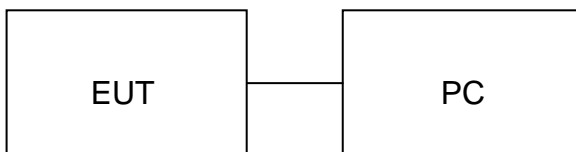

5.2. EQUIPMENT USED IN EUT SYSTEM

Item	Equipment	Mfr/Brand	Model/Type No.	Remark
1	Tablet PC	Ice Mobile	G2	EUT
2	Adapter	Ice Mobile	G2	Accessory
3	Battery	Ice Mobile	G2	Accessory
4	USB Cable	N/A	N/A	Accessory

Note: All the accessories have been used during the test in conduction emission test.

5.3. SUMMARY OF TEST RESULTS

FCC RULES	DESCRIPTION OF TEST	RESULT
§15.247	Peak Output Power	Compliant
§15.247	6 dB Bandwidth	Compliant
§15.247	Conducted Spurious Emission	Compliant
§15.247	Maximum Conducted Output Power SPECTRAL Density	Compliant
§15.209	Radiated Emission	Compliant
§15.247	Band Edges	Compliant
§15.207	Line Conduction Emission	Compliant

Note: The EUT received power from DC3.7V lithium battery.

6. TEST FACILITY

Site	Attestation of Global Compliance (Shenzhen) Co., Ltd
Location	2/F., Building 2, No.1-No.4, Chaxi Sanwei Technical Industrial Park, Gushu, Xixiang, Bao'an District, Shenzhen, Guangdong, China
Description	The test site is constructed and calibrated to meet the FCC requirements in documents ANSI C63.4:2003.

ALL TEST EQUIPMENT LIST

Description	Manufacturer	Model	S/N	Cal. Date	Cal. Due
Power meter	R&S	NRP-Z23	100323	07/18/2012	07/17/2013
RF attenuator	N/A	RFA20db	68	N/A	N/A
Spectrum Analyzer	Agilent	E4440A	US41421290	07/18/2012	07/17/2013
Amplifier	EM	EM30180	0607030	07/18/2012	07/17/2013
Horn Antenna	EM	EM-AH-10180	67	04/21/2013	04/20/2014
Horn Antenna	A.H. Systems Inc.	SAS-574	--	07/18/2012	07/17/2013
EMI Test Receiver	Rohde & Schwarz	ESCI	100694	07/18/2012	07/17/2013
Biological Antenna	A.H. Systems Inc.	SAS-521-4	26	06/08/2012	06/09/2013
Loop Antenna	A.H.	SAS-526B	264	07/15/2012	07/14/2013

7. PEAK OUTPUT POWER

7.1. MEASUREMENT PROCEDURE

1. The EUT was placed on a table which is 0.8m above ground plane.
2. Connect EUT RF output port to power meter through an RF attenuator
3. Set the EUT Work on the top, the middle and the bottom operation frequency individually.
4. Set the RBW greater than 6DB bandwidth of emission.
5. Record the maximum power from the power meter.
6. The maximum peak power shall be less 1 Watt (30dBm).

Note : The EUT was tested according to KDB 558074 for compliance to FCC 47CFR 15.247 requirements.

7.2. TEST SET-UP (BLOCK DIAGRAM OF CONFIGURATION)

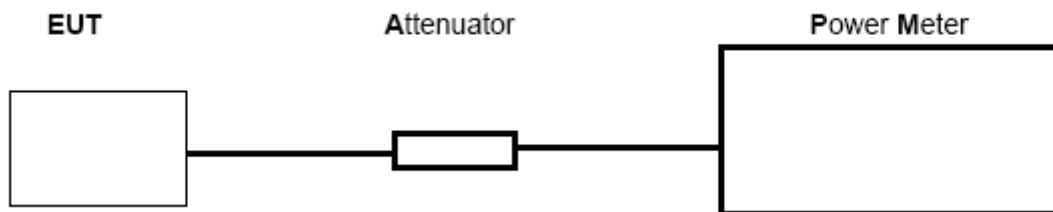

7.3. LIMITS AND MEASUREMENT RESULT

TEST ITEM	PEAK POWER
TEST MODE	802.11b with data rate 1

LIMITS AND MEASUREMENT RESULT				
Frequency (GHz)	Average Power (dBm)	Peak Power (dBm)	Applicable Limits (dBm)	Pass or Fail
2.412	9.79	12.62	30	Pass
2.437	9.56	12.43	30	Pass
2.462	9.98	12.94	30	Pass

TEST ITEM	PEAK POWER
TEST MODE	802.11g with data rate 6

LIMITS AND MEASUREMENT RESULT				
Frequency (GHz)	Average Power (dBm)	Peak Power (dBm)	Applicable Limits (dBm)	Pass or Fail
2.412	9.31	12.21	30	Pass
2.437	9.18	12.09	30	Pass
2.462	9.45	12.33	30	Pass

TEST ITEM	PEAK POWER
TEST MODE	802.11n 20 with data rate 6.5

LIMITS AND MEASUREMENT RESULT				
Frequency (GHz)	Average Power (dBm)	Peak Power (dBm)	Applicable Limits (dBm)	Pass or Fail
2.412	8.88	11.86	30	Pass
2.437	8.71	11.67	30	Pass
2.462	9.09	11.95	30	Pass

TEST ITEM	PEAK POWER
TEST MODE	802.11n 40 with data rate 13.5

LIMITS AND MEASUREMENT RESULT				
Frequency (GHz)	Average Power (dBm)	Peak Power (dBm)	Applicable Limits (dBm)	Pass or Fail
2.422	7.52	10.49	30	Pass
2.437	7.39	10.33	30	Pass
2.452	7.65	10.62	30	Pass

8. 6DB BANDWIDTH

8.1. MEASUREMENT PROCEDURE

1. The EUT was placed on a table which is 0.8m above ground plane.
2. Connect EUT RF output port to the Spectrum Analyzer through an RF attenuator
3. Set the EUT Work on the top, the middle and the bottom operation frequency individually.
3. Set SPA Centre Frequency = Operation Frequency, RBW= 100 KHz, VBW RBW.
4. Set SPA Trace 1 Max hold, then View.

Note: The EUT was tested according to KDB 558074 for compliance to FCC 47CFR 15.247 requirements.

8.2. TEST SET-UP (BLOCK DIAGRAM OF CONFIGURATION)

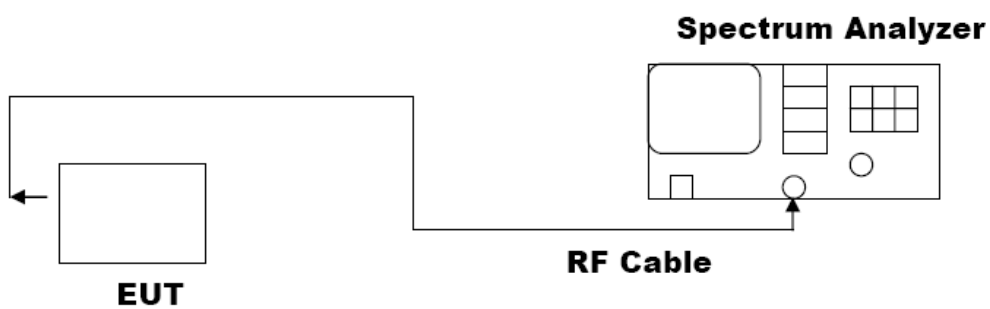

8.3. LIMITS AND MEASUREMENT RESULTS

TEST ITEM	6DB BANDWIDTH
TEST MODE	802.11b with data rate 11

LIMITS AND MEASUREMENT RESULT			
Applicable Limits	Applicable Limits		
	Test Data (MHz)		Criteria
>500KHZ	Low Channel	9.025	PASS
	Middle Channel	9.078	PASS
	High Channel	8.632	PASS

TEST ITEM	6DB BANDWIDTH
TEST MODE	802.11g with data rate 54

LIMITS AND MEASUREMENT RESULT			
Applicable Limits	Applicable Limits		
	Test Data (MHz)		Criteria
>500KHZ	Low Channel	16.477	PASS
	Middle Channel	16.471	PASS
	High Channel	16.486	PASS

TEST ITEM	6DB BANDWIDTH
TEST MODE	802.11n 20 with data rate 65

LIMITS AND MEASUREMENT RESULT			
Applicable Limits	Applicable Limits		
	Test Data (MHz)		Criteria
>500KHZ	Low Channel	17.656	PASS
	Middle Channel	17.670	PASS
	High Channel	17.691	PASS

TEST ITEM	6DB BANDWIDTH
TEST MODE	802.11n 40 with data rate 135

LIMITS AND MEASUREMENT RESULT			
Applicable Limits	Applicable Limits		
	Test Data (MHz)		Criteria
>500KHZ	Low Channel	35.975	PASS
	Middle Channel	36.051	PASS
	High Channel	35.704	PASS

802.11b TEST RESULT
TEST PLOT OF BANDWIDTH FOR LOW CHANNEL

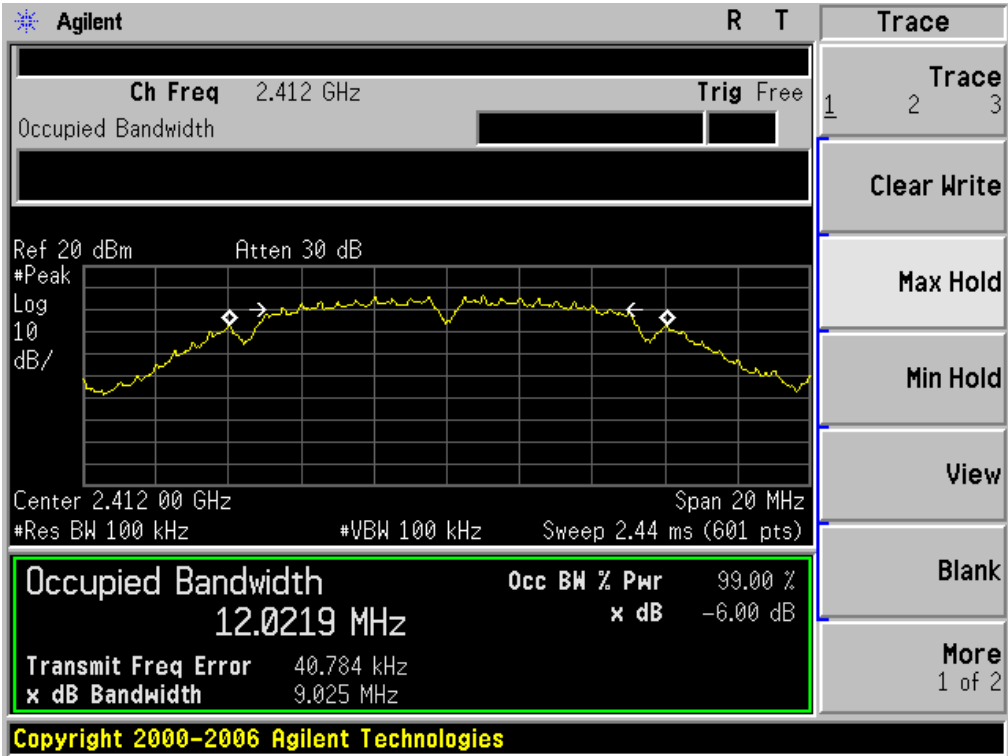

TEST PLOT OF BANDWIDTH FOR MIDDLE CHANNEL

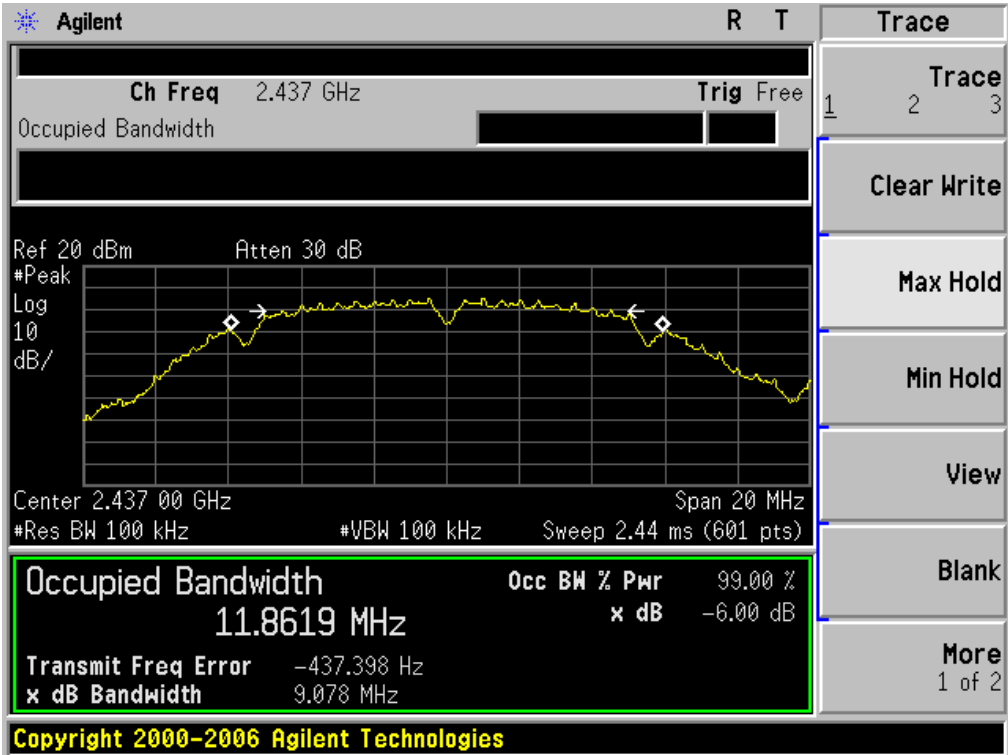

TEST PLOT OF BANDWIDTH FOR HIGH CHANNEL

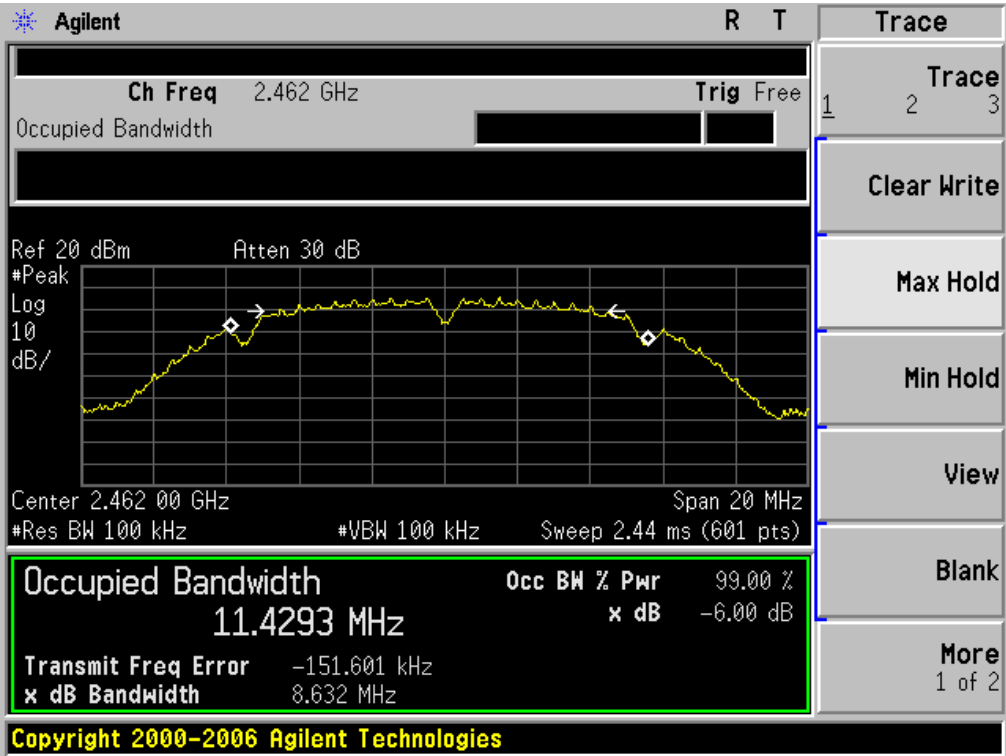

802.11g TEST RESULT
TEST PLOT OF BANDWIDTH FOR LOW CHANNEL

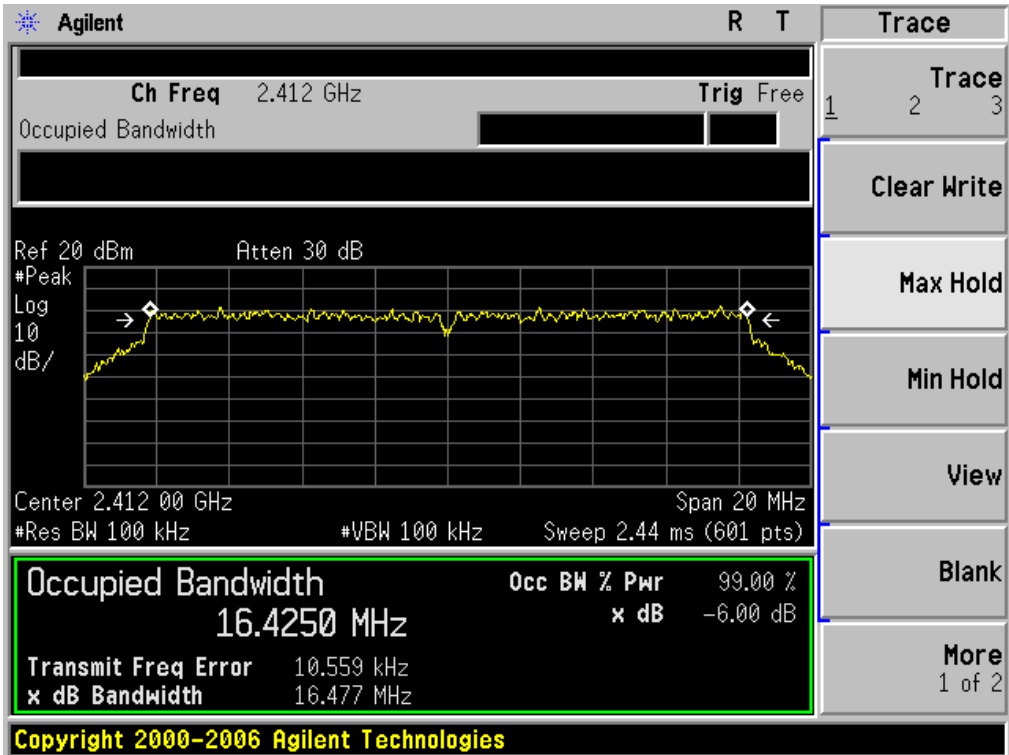

TEST PLOT OF BANDWIDTH FOR MIDDLE CHANNEL

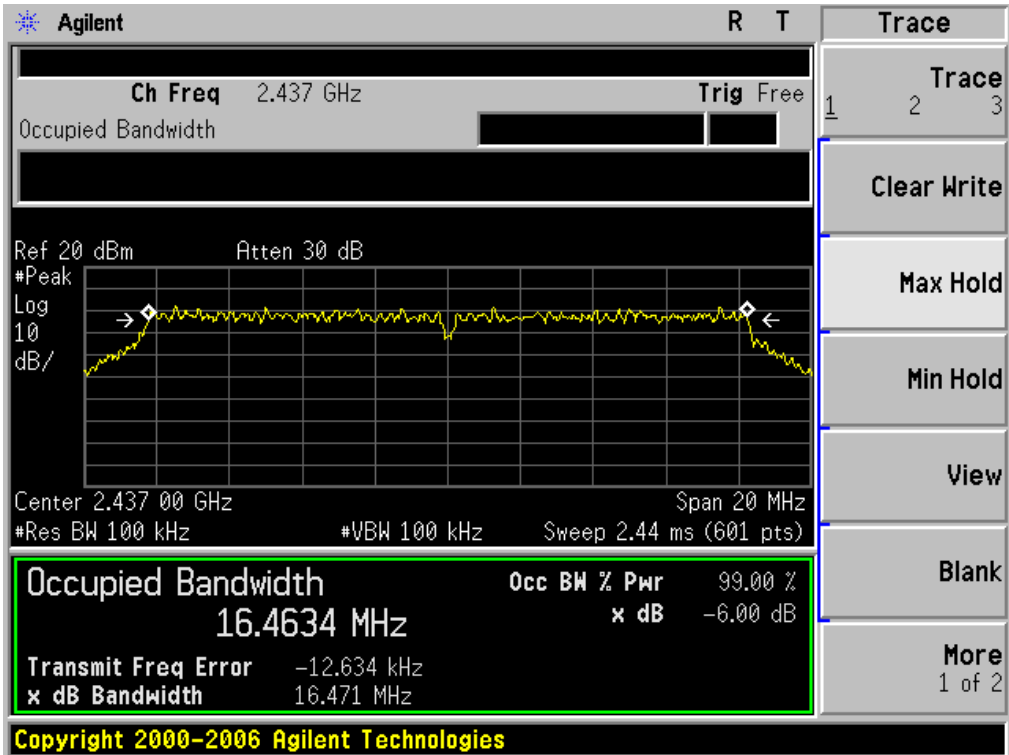

TEST PLOT OF BANDWIDTH FOR HIGH CHANNEL

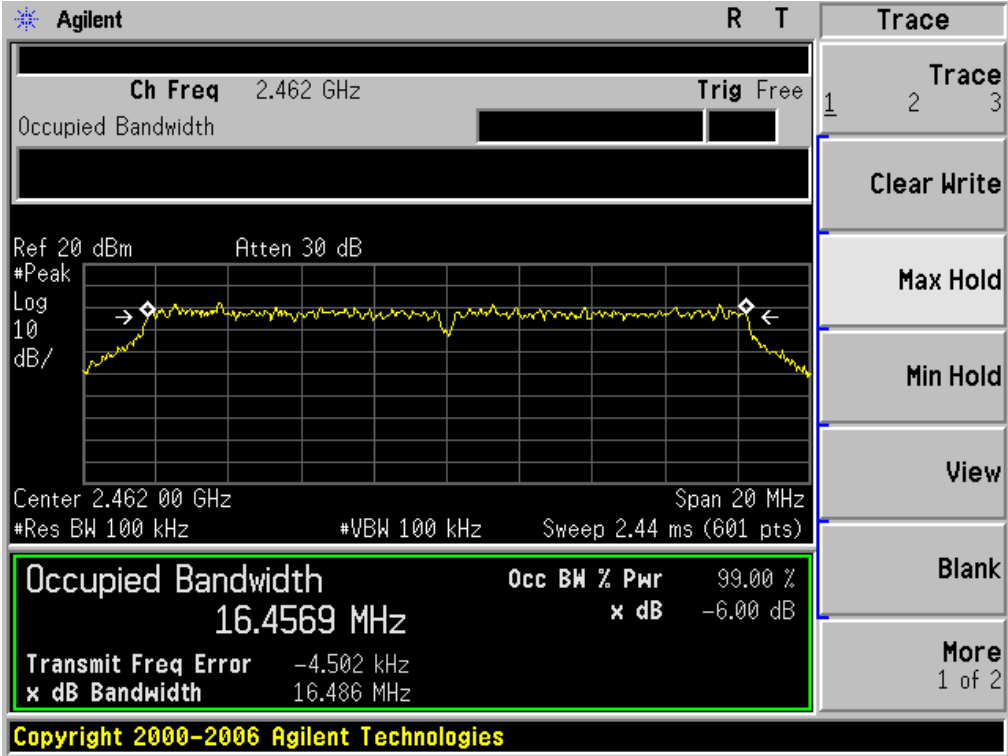

802.11n(20) TEST RESULT
TEST PLOT OF BANDWIDTH FOR LOW CHANNEL

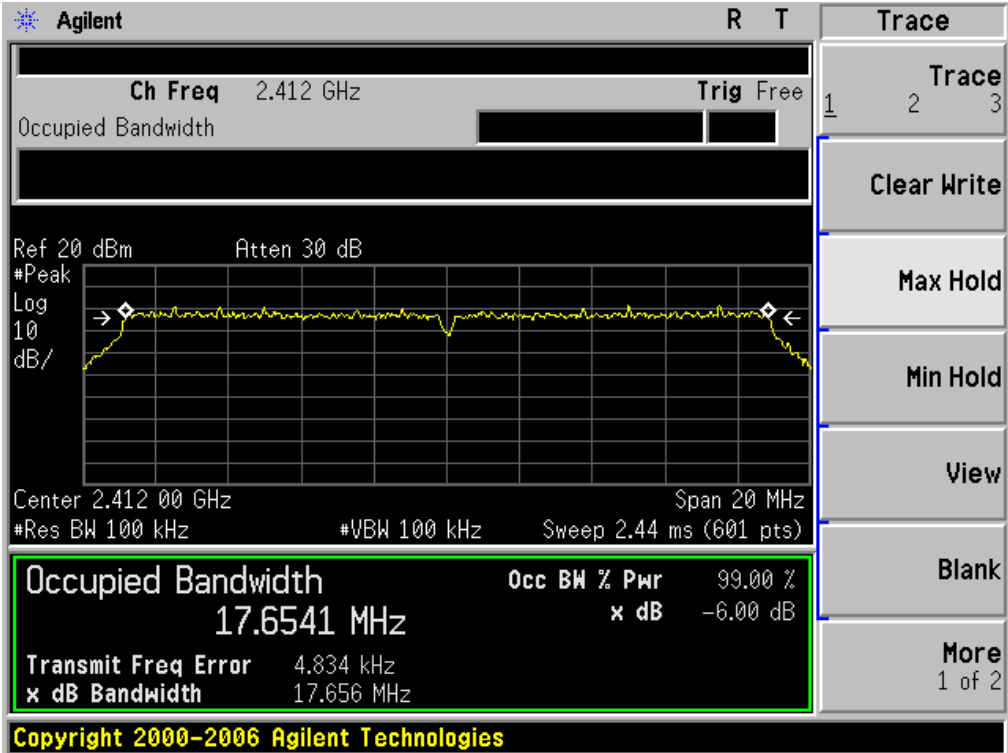

TEST PLOT OF BANDWIDTH FOR MIDDLE CHANNEL

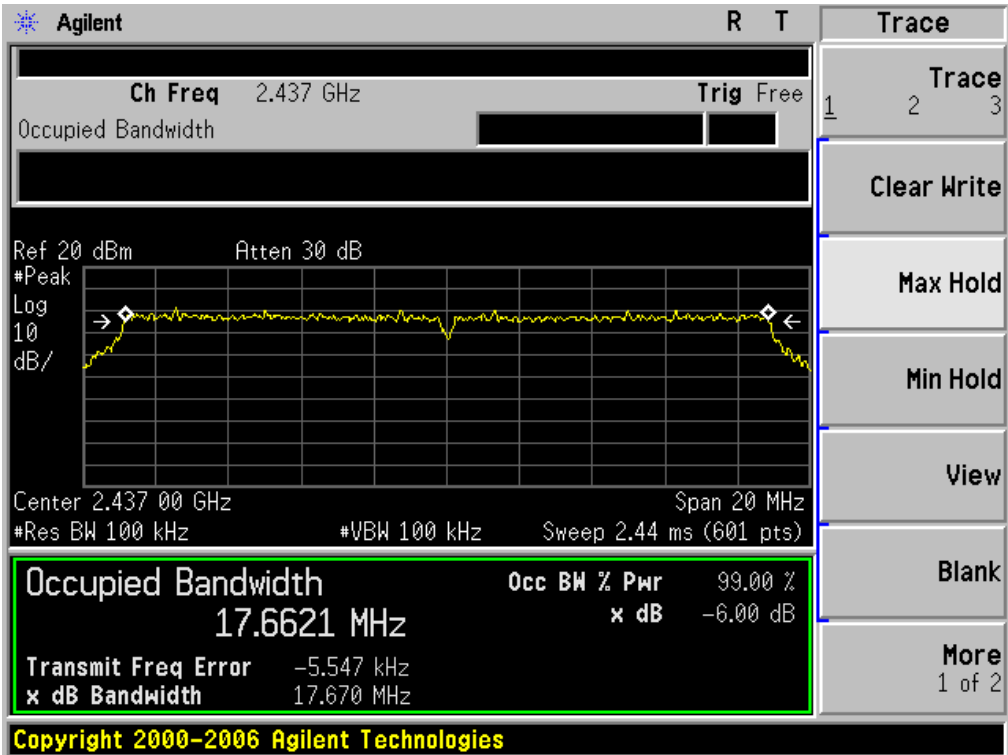

TEST PLOT OF BANDWIDTH FOR HIGH CHANNEL

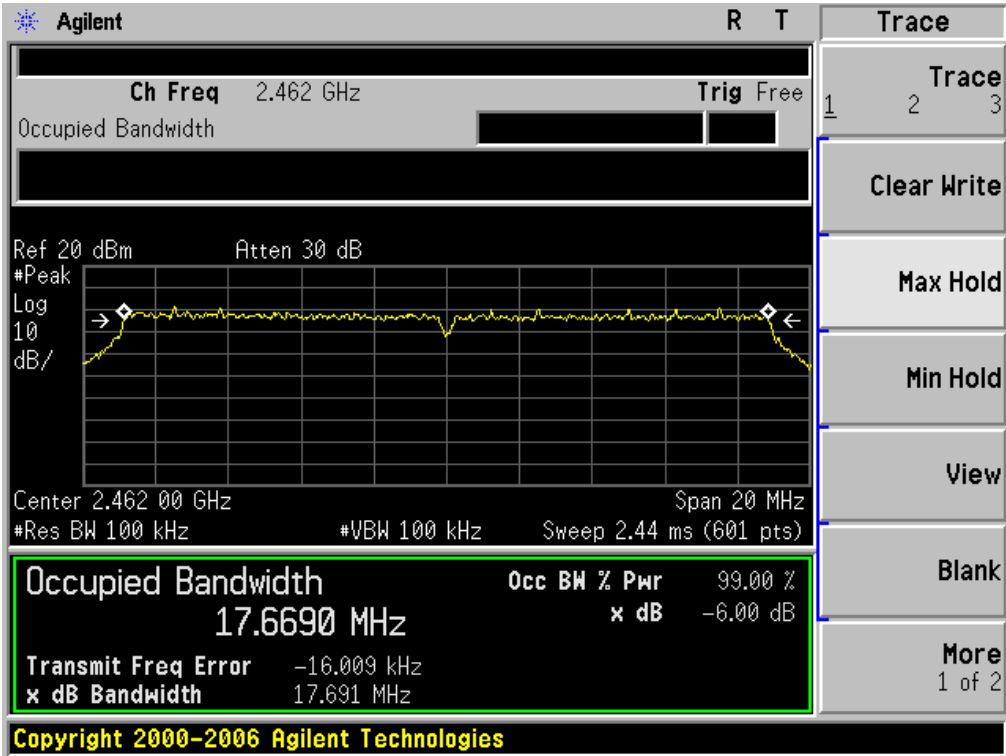

802.11n(40) TEST RESULT
TEST PLOT OF BANDWIDTH FOR LOW CHANNEL

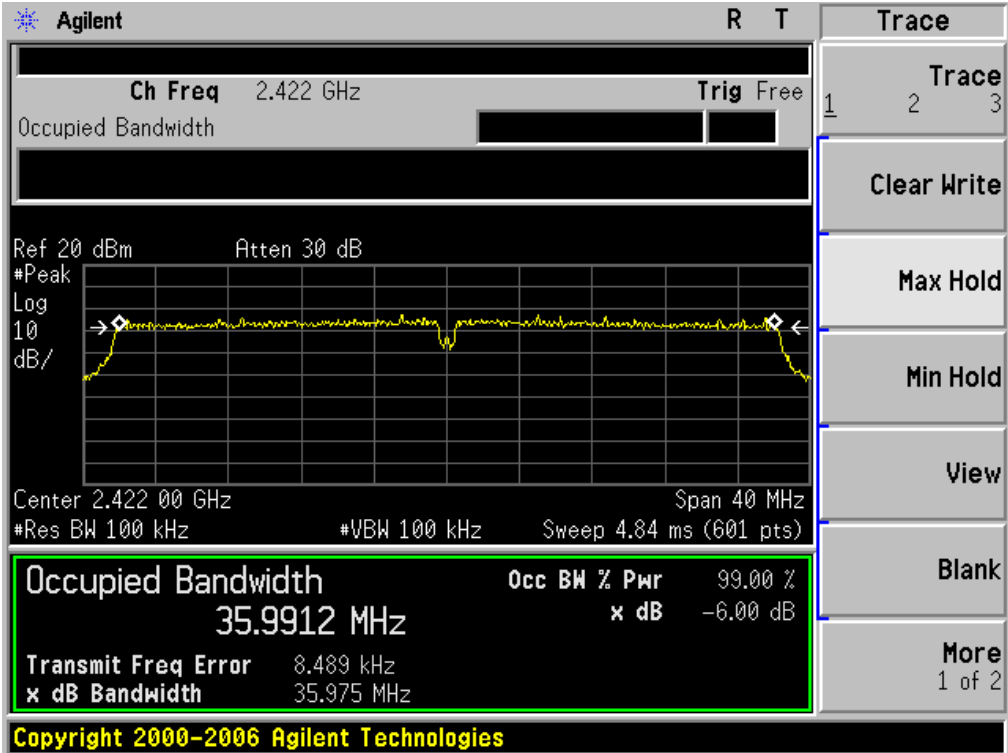

TEST PLOT OF BANDWIDTH FOR MIDDLE CHANNEL

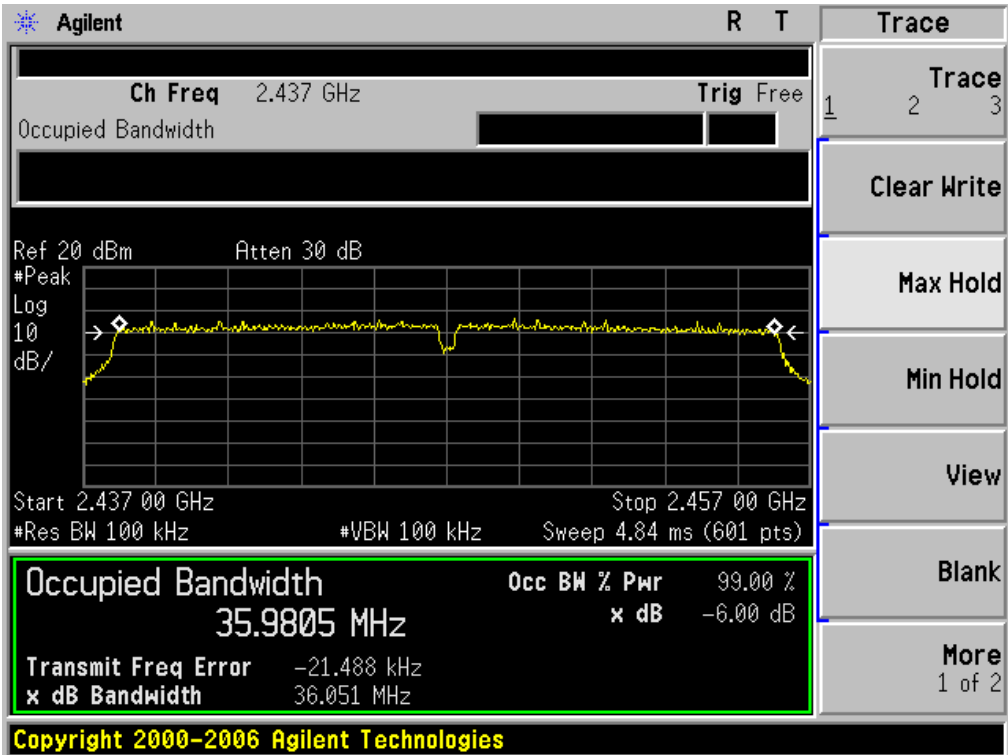

TEST PLOT OF BANDWIDTH FOR HIGH CHANNEL

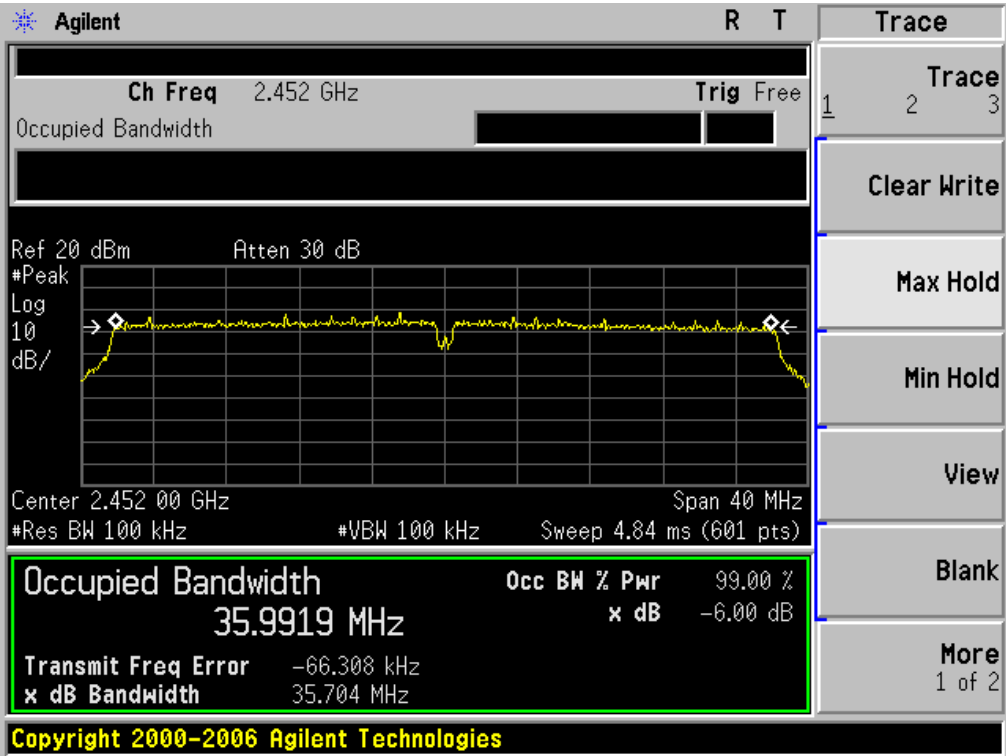

9. CONDUCTED SPURIOUS EMISSION

9.1. MEASUREMENT PROCEDURE

1. The EUT was placed on a turn table which is 0.8m above ground plane.
1. The EUT was placed on a turn table which is 0.8m above ground plane.
2. Connect EUT RF output port to the Spectrum Analyzer through an RF attenuator
- 3, Set the EUT Work on the top, the middle and the bottom operation frequency individually.
4. Set SPA Trace 1 Max hold, then View.

Note: The EUT was tested according to KDB 558074 for compliance to FCC 47CFR 15.247 requirements.
Set RBW = 100 kHz, Set VBW > RBW, scan up through 10th harmonic.

9.2. TEST SET-UP (BLOCK DIAGRAM OF CONFIGURATION)

The same as described in section 8.2.

9.3. MEASUREMENT EQUIPMENT USED

The same as described in section 6.

9.4. LIMITS AND MEASUREMENT RESULT

LIMITS AND MEASUREMENT RESULT		
Applicable Limits	Measurement Result	
	Test Data	Criteria
In any 100 KHz Bandwidth Outside the frequency band in which the spread spectrum intentional radiator is operating, the radio frequency power that is produce by the intentional radiator shall be at least 20 dB below that in 100KHz bandwidth within the band that contains the highest level of the desired power. In addition, radiation emissions which fall in the restricted bands, as defined in §15.205(a), must also comply with the radiated emission limits specified in§15.209(a)	At least -20dBc than the limit Specified on the BOTTOM Channel	PASS
	At least -20dBc than the limit Specified on the TOP Channel	PASS

TEST PLOT OF OUT OF BAND EMISSIONS WITH THE WORST CASE
 OF 802.11b FOR MODULATION IN LOW CHANNEL

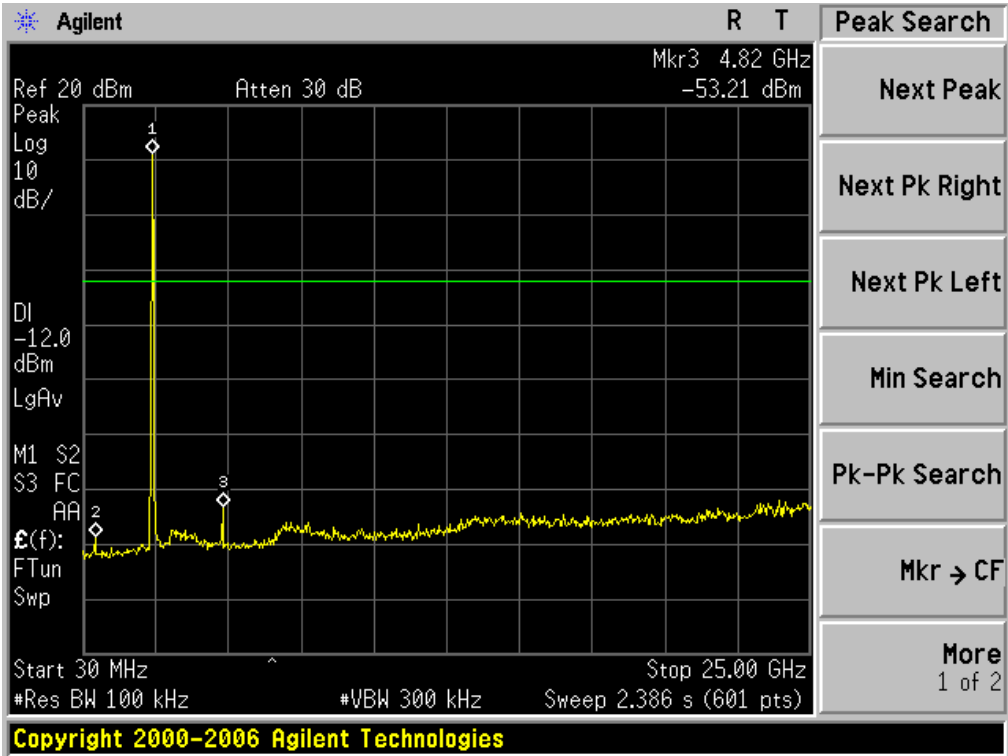

TEST PLOT OF OUT OF BAND EMISSIONS
 OF 802.11b FOR MODULATION IN MIDDLE CHANNEL

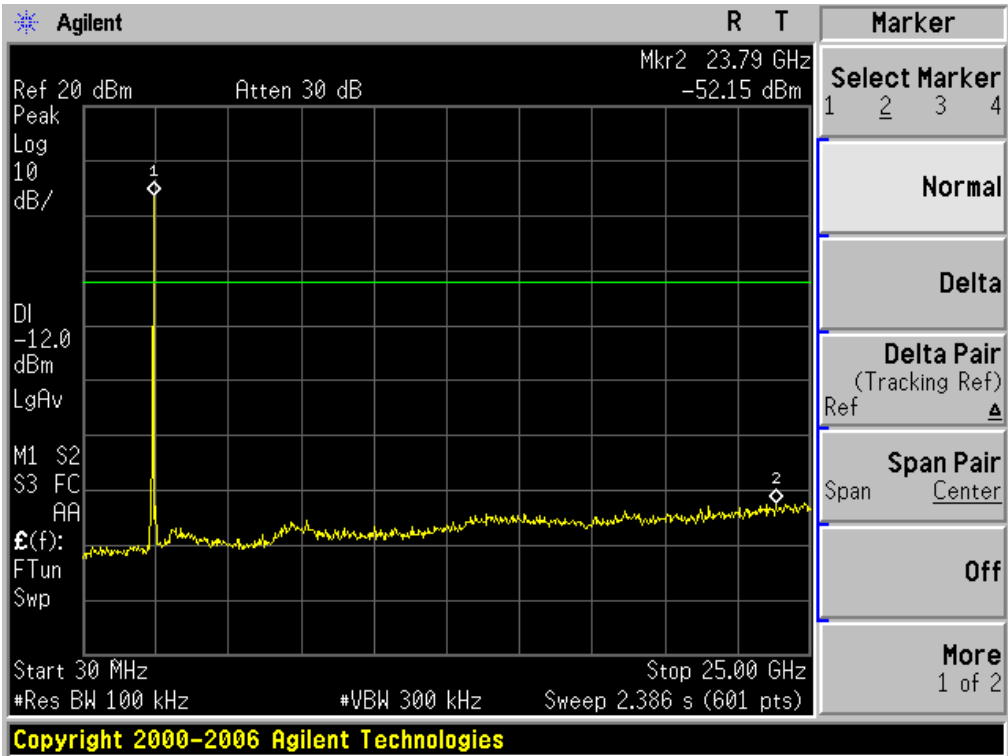

TEST PLOT OF OUT OF BAND EMISSIONS
OF 802.11b FOR MODULATION IN HIGH CHANNEL

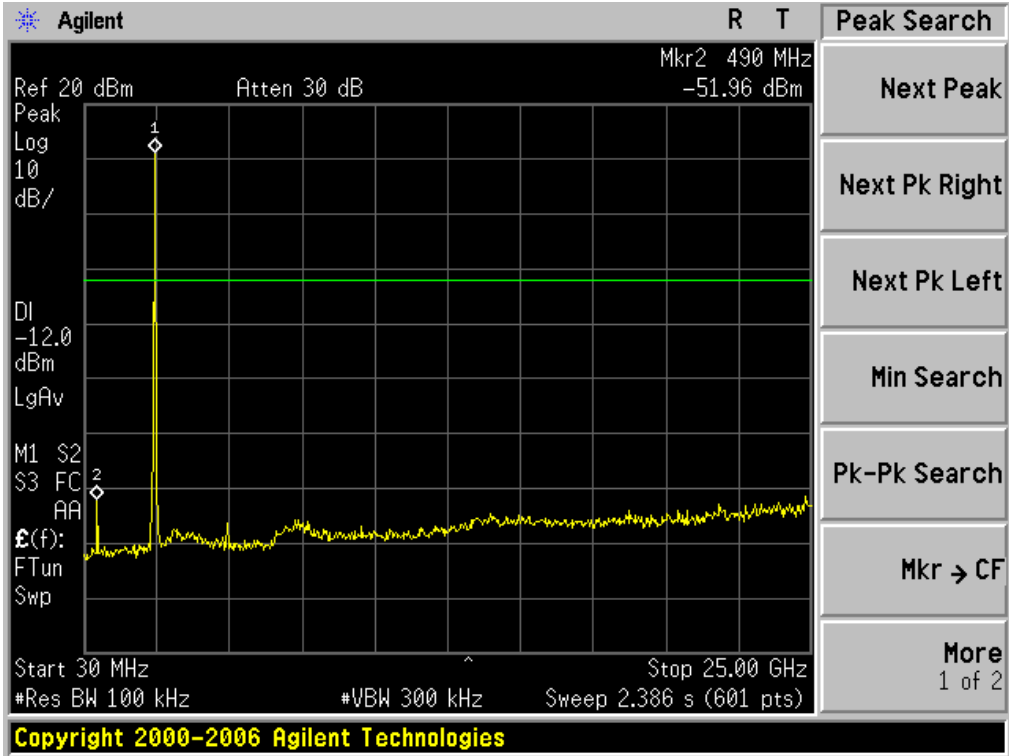

10. MAXIMUM CONDUCTED OUTPUT POWER SPECTRAL DENSITY

10.1 MEASUREMENT PROCEDURE

- (1). The EUT was placed on a turn table which is 0.8m above ground plane.
- (2). Connect EUT RF output port to the Spectrum Analyzer through an RF attenuator
- (3). Set the EUT Work on the top, the middle and the bottom operation frequency individually.
- (4). Set SPA Trace 1 Max hold, then View.

10.2 TEST SET-UP (BLOCK DIAGRAM OF CONFIGURATION)

Refer To Section 8.2.

10.3 MEASUREMENT EQUIPMENT USED

Refer To Section 6.

10.4 LIMITS AND MEASUREMENT RESULT

TEST ITEM	POWER PECTRAL DENSITY
TEST MODE	802.11b with data rate 1

Channel No.	PSD (dBm)	Limit (dBm)	Result
Low Channel	-8.43	8	Pass
Middle Channel	-8.93	8	Pass
High Channel	-6.48	8	Pass

TEST ITEM	POWER PECTRAL DENSITY
TEST MODE	802.11g with data rate 6

Channel No.	PSD (dBm)	Limit (dBm)	Result
Low Channel	-12.58	8	Pass
Middle Channel	-13.16	8	Pass
High Channel	-10.44	8	Pass

TEST ITEM	POWER PECTRAL DENSITY
TEST MODE	802.11n 20 with data rate 6.5

Channel No.	PSD (dBm)	Limit (dBm)	Result
Low Channel	-12.27	8	Pass
Middle Channel	-12.11	8	Pass
High Channel	-11.67	8	Pass

TEST ITEM	POWER PECTRAL DENSITY
TEST MODE	802.11n 40 with data rate 13.5

Channel No.	PSD (dBm)	Limit (dBm)	Result
Low Channel	-16.86	8	Pass
Middle Channel	-16.70	8	Pass
High Channel	-15.74	8	Pass

802.11b TEST RESULT
TEST PLOT OF SPECTRAL DENSITY FOR LOW CHANNEL

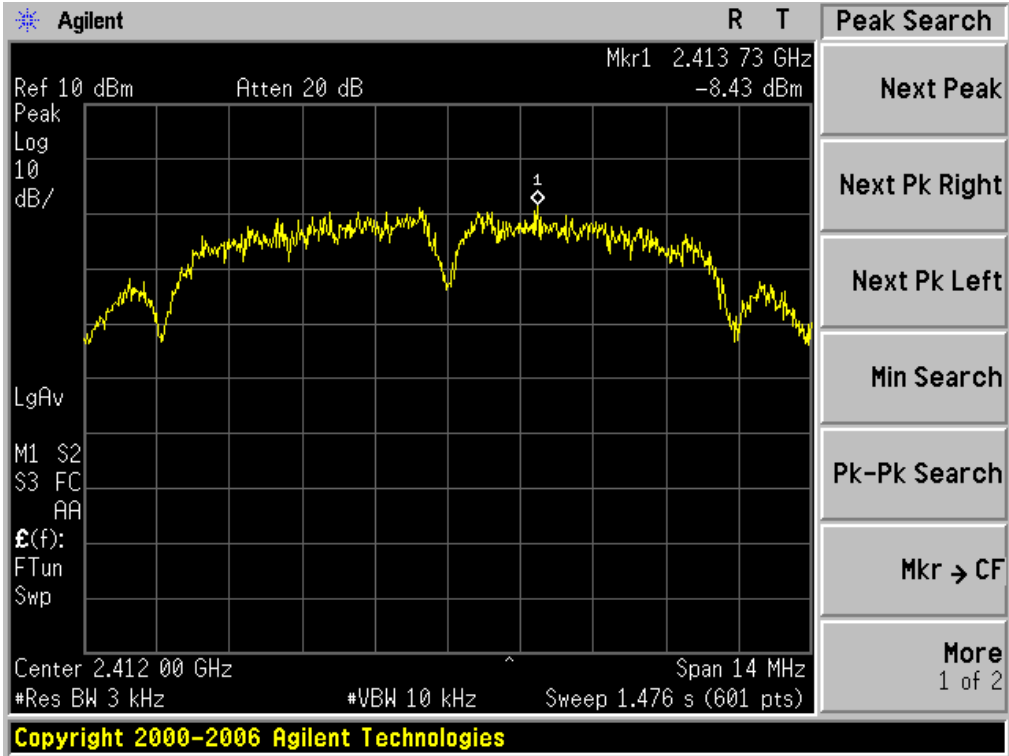

TEST PLOT OF SPECTRAL DENSITY FOR MIDDLE CHANNEL

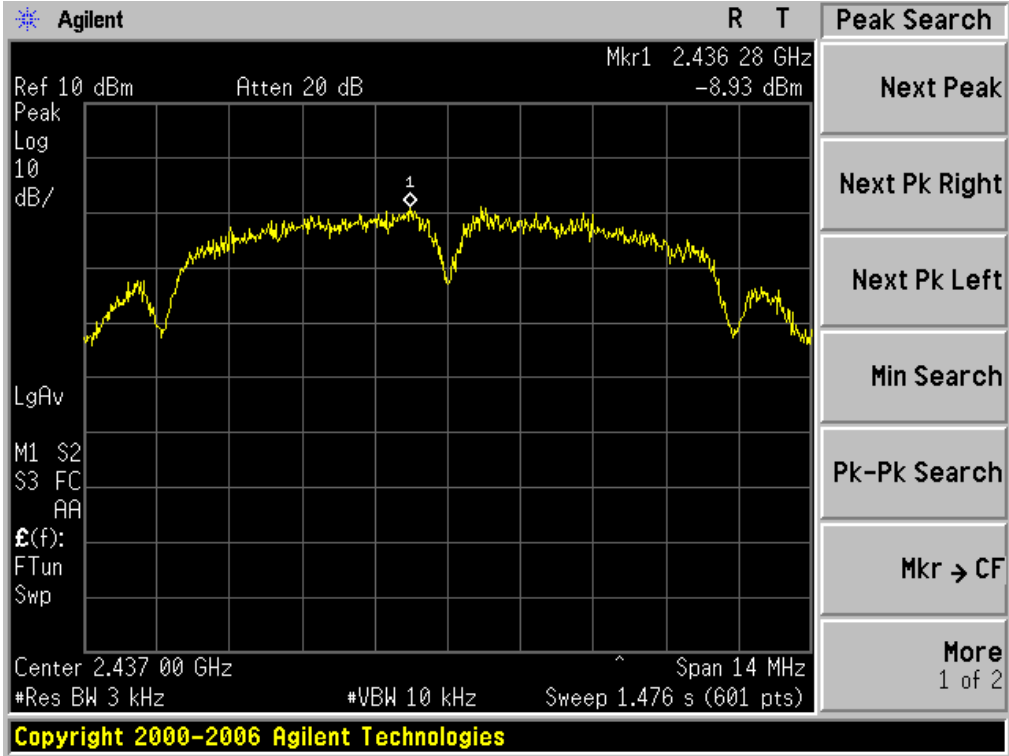

TEST PLOT OF SPECTRAL DENSITY FOR HIGH CHANNEL

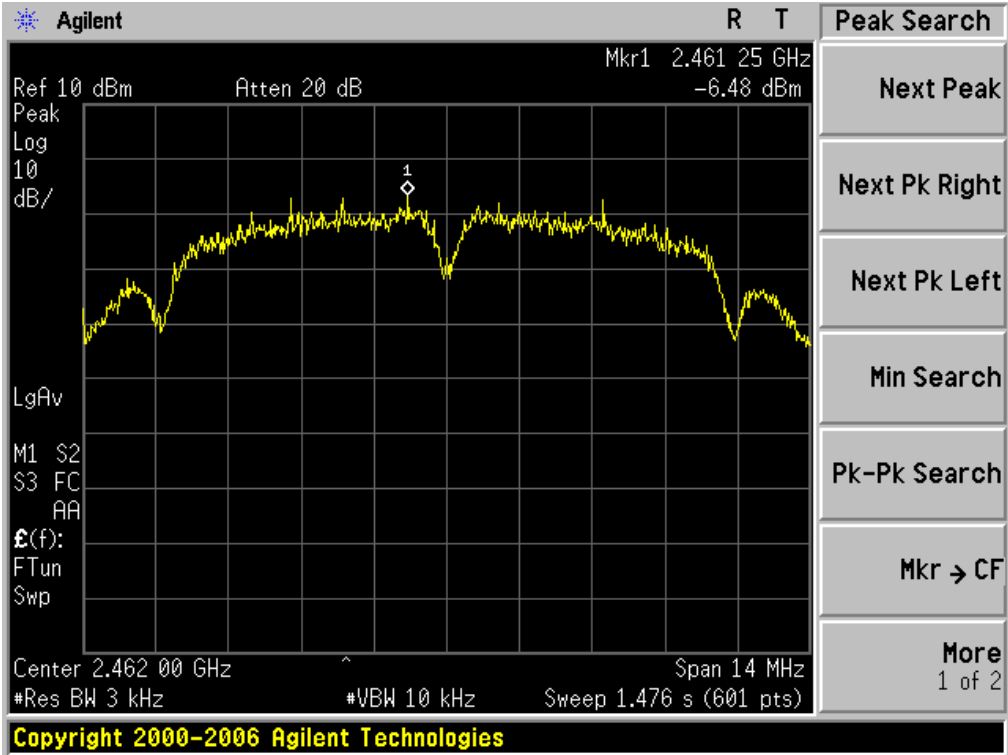

802.11g TEST RESULT
 TEST PLOT OF SPECTRAL DENSITY FOR LOW CHANNEL

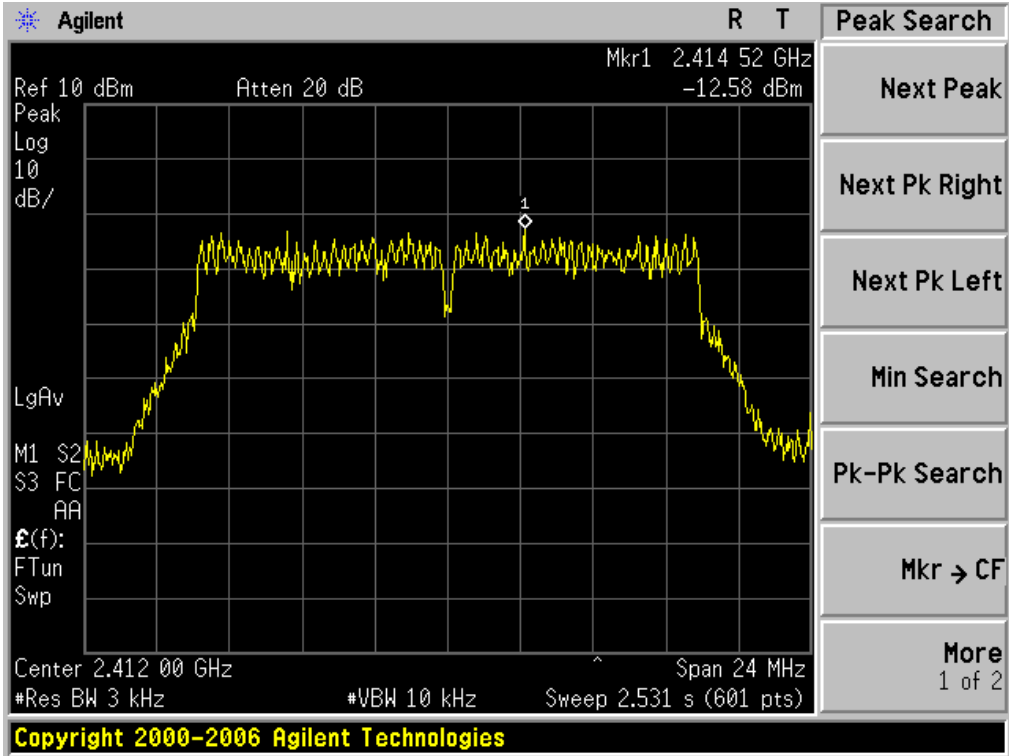

TEST PLOT OF SPECTRAL DENSITY FOR MIDDLE CHANNEL

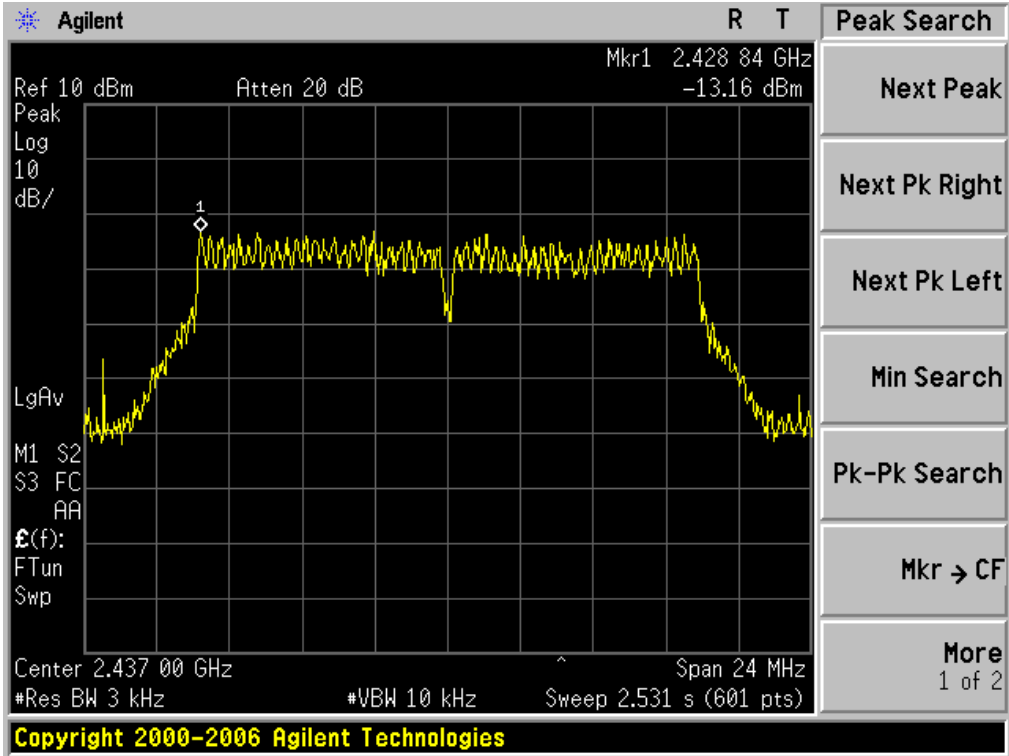

TEST PLOT OF SPECTRAL DENSITY FOR HIGH CHANNEL

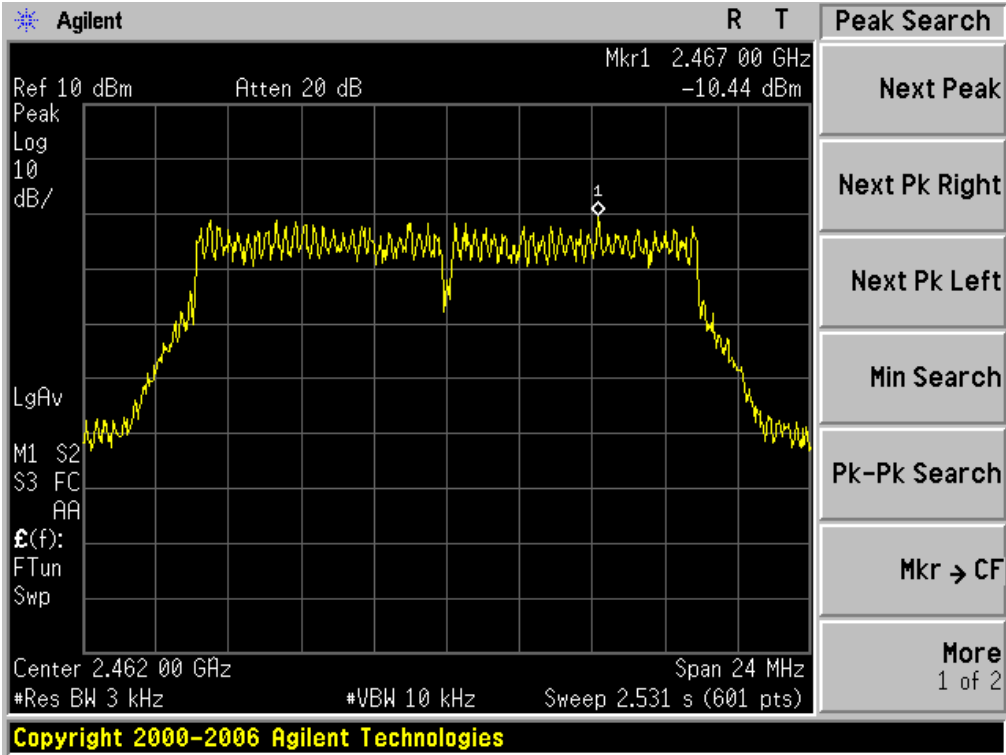

802.11n 20 TEST RESULT

TEST PLOT OF SPECTRAL DENSITY FOR LOW CHANNEL

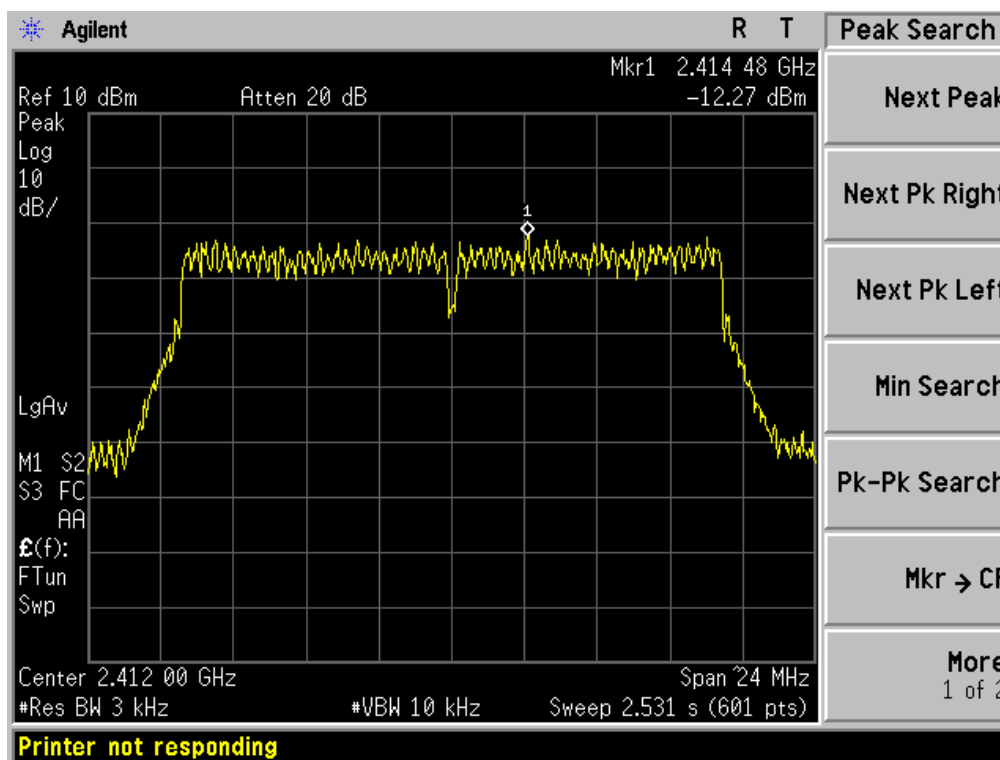

TEST PLOT OF SPECTRAL DENSITY FOR MIDDLE CHANNEL

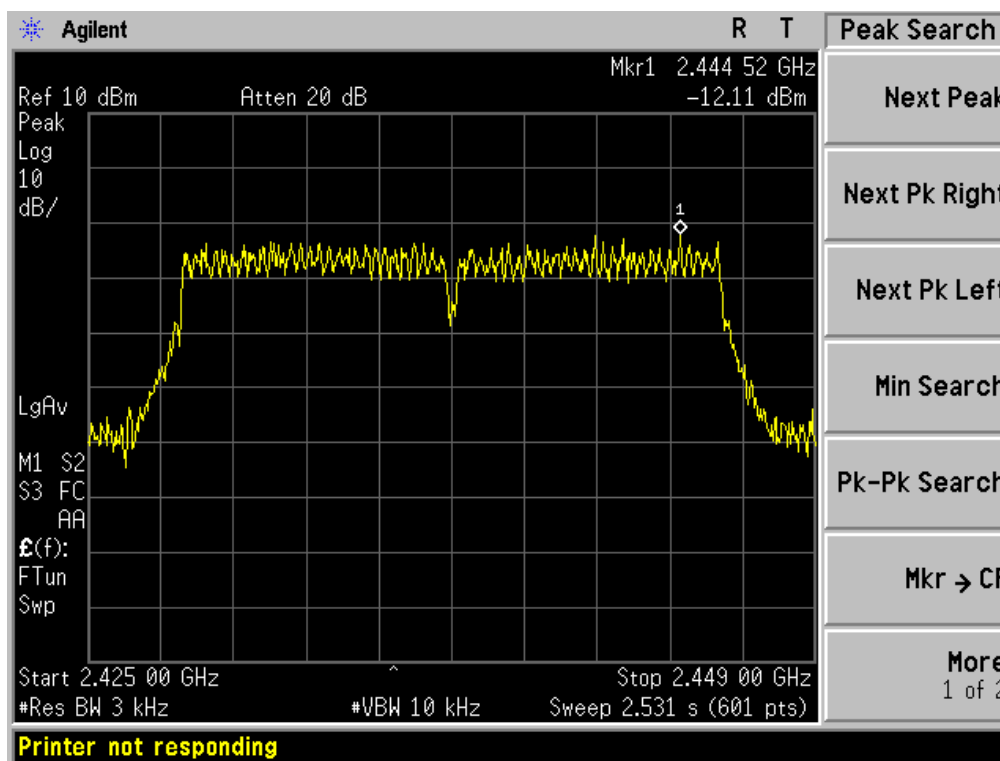

TEST PLOT OF SPECTRAL DENSITY FOR HIGH CHANNEL

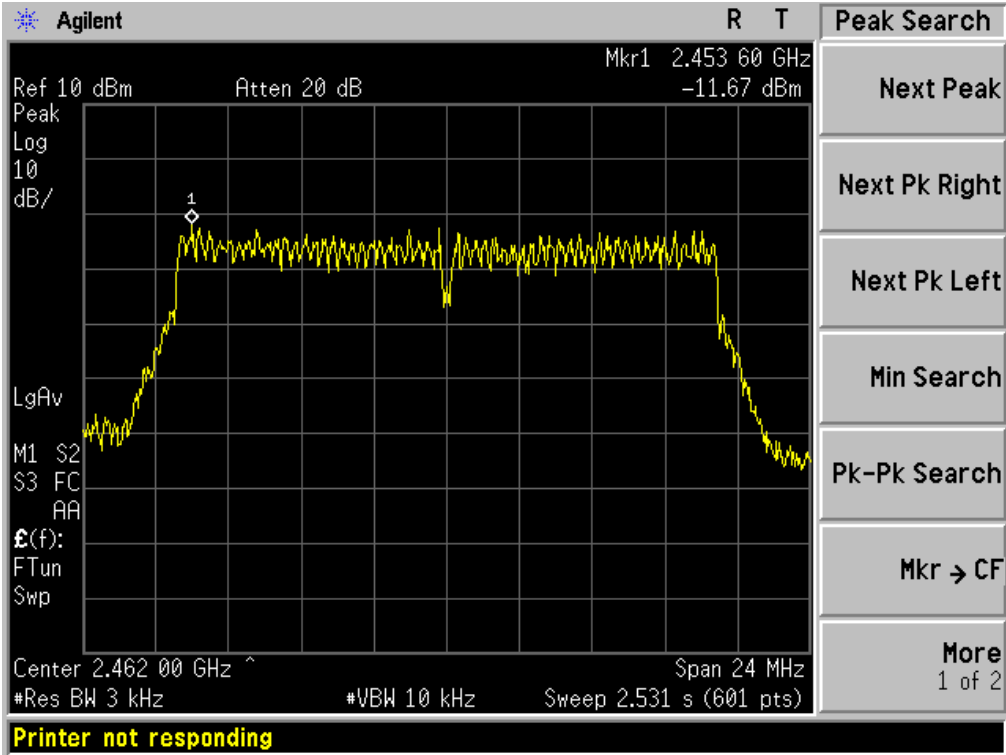

802.11n 40 TEST RESULT
TEST PLOT OF SPECTRAL DENSITY FOR LOW CHANNEL

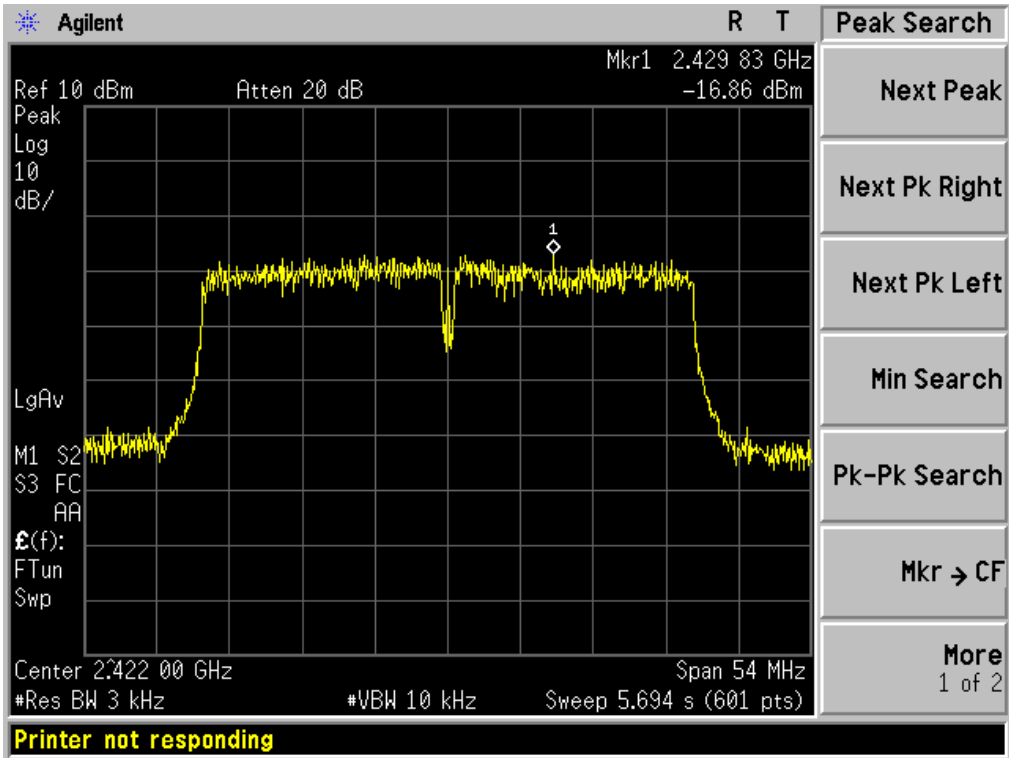

TEST PLOT OF SPECTRAL DENSITY FOR MIDDLE CHANNEL

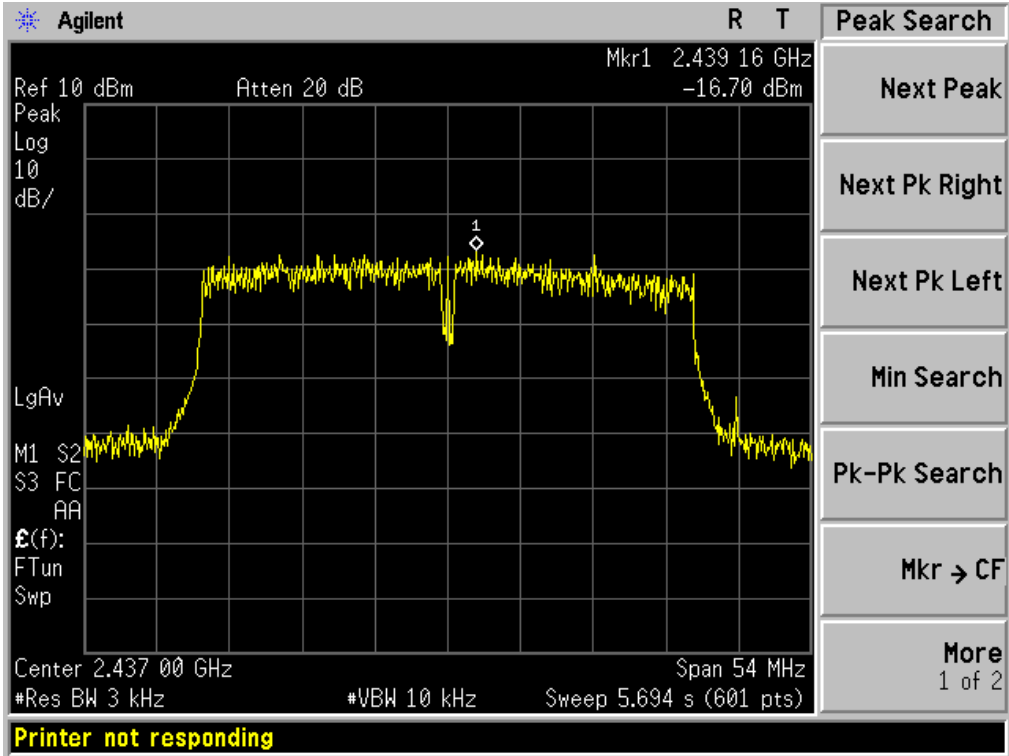

TEST PLOT OF SPECTRAL DENSITY FOR HIGH CHANNEL

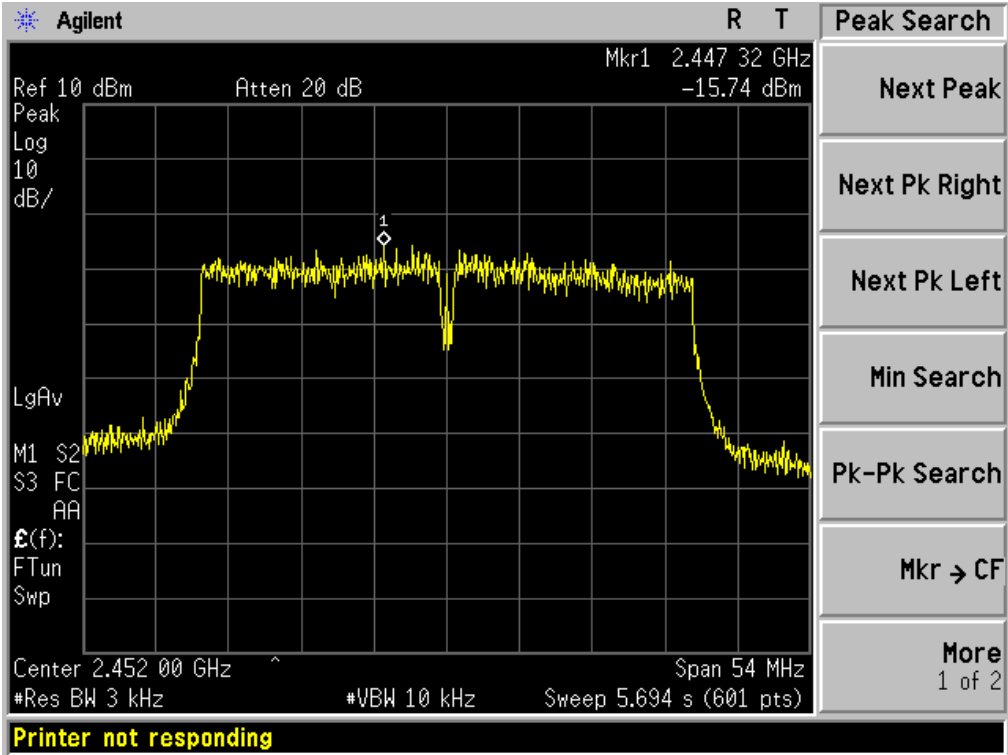

11. RADIATED EMISSION

11.1. MEASUREMENT PROCEDURE

1. Configure the EUT according to ANSI C63.4. The EUT was placed on the top of the turntable 0.8 meter above ground. The phase center of the receiving antenna mounted on the top of a height-variable antenna tower was placed 3 meters far away from the turntable.
2. Power on the EUT and all the supporting units. The turntable was rotated by 360 degrees to determine the position of the highest radiation.
3. The height of the broadband receiving antenna was varied between one meter and four meters above ground to find the maximum emissions field strength of both horizontal and vertical polarization.
4. For each suspected emissions, the antenna tower was scan (from 1 M to 4 M) and then the turntable was rotated (from 0 degree to 360 degrees) to find the maximum reading.
5. Set the test-receiver system to Peak or CISPR quasi-peak Detect Function with specified bandwidth under Maximum Hold Mode.
6. For emissions above 1GHz, use 1MHz VBW and RBW for peak reading. Then 1MHz RBW and 10Hz VBW for average reading in spectrum analyzer.
7. When the radiated emissions limits are expressed in terms of the average value of the emissions, and pulsed operation is employed, the measurement field strength shall be determined by averaging over one complete pulse train, including blanking intervals, as long as the pulse train does not exceed 0.1 seconds. As an alternative (provided the transmitter operates for longer than 0.1 seconds) or in cases where the pulse train exceeds 0.1 seconds, the measured field strength shall be determined from the average absolute voltage during a 0.1 second interval during which the field strength is at its maximum values.
8. If the emissions level of the EUT in peak mode was 3 dB lower than the average limit specified, then testing will be stopped and peak values of EUT will be reported, otherwise, the emissions which do not have 3 dB margin will be repeated one by one using the quasi-peak method for below 1GHz.
9. For testing above 1GHz, the emissions level of the EUT in peak mode was lower than average limit (that means the emissions level in peak mode also complies with the limit in average mode), then testing will be stopped and peak values of EUT will be reported, otherwise, the emissions will be measured in average mode again and reported.
10. In case the emission is lower than 30MHz, loop antenna has to be used for measurement and the recorded data should be QP measured by receiver. High - Low scan is not required in this case.

11.2. TEST SETUP

RADIATED EMISSION TEST SETUP BELOW 30MHz

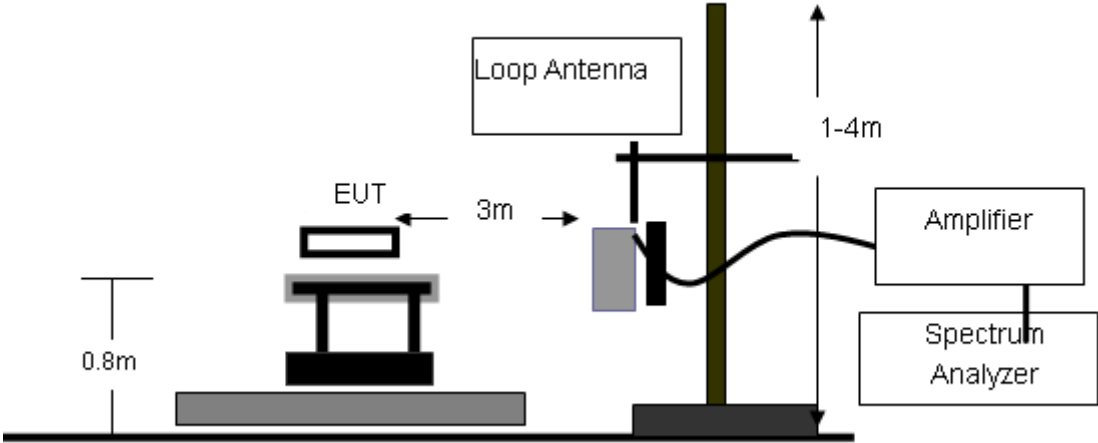

RADIATED EMISSION TEST SETUP 30MHz-1000MHz

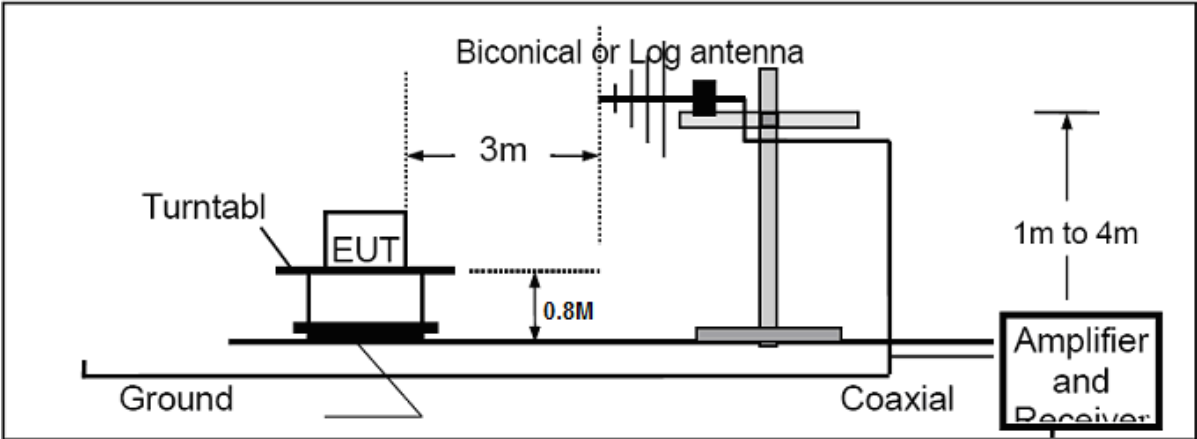

RADIATED EMISSION TEST SETUP ABOVE 1000MHz

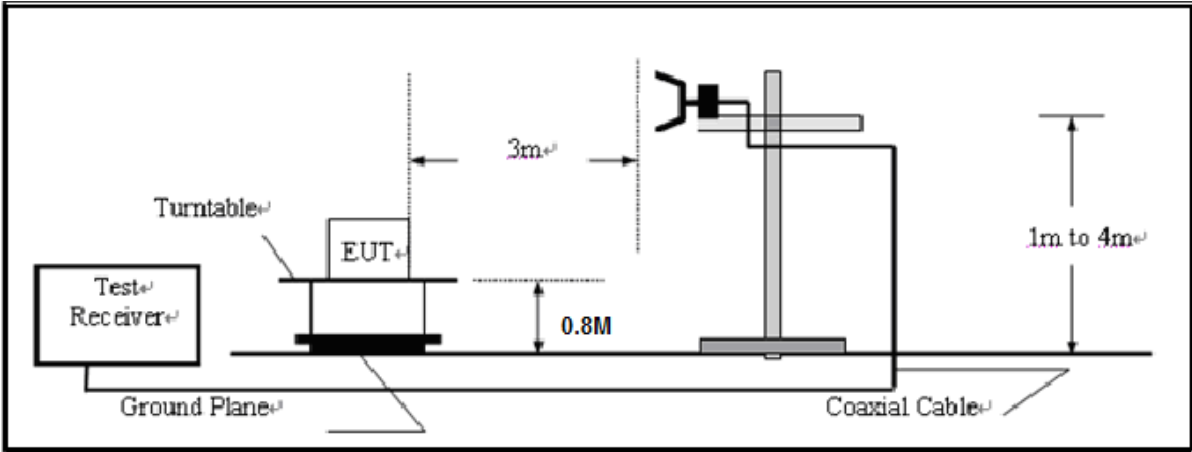

11.3. LIMITS AND MEASUREMENT RESULT

15.209(a) Limit in the below table has to be followed

Frequencies (MHz)	Field Strength (micorvolts/meter)	Measurement Distance (meters)
0.009~0.490	2400/F(KHz)	300
0.490~1.705	24000/F(KHz)	30
1.705~30.0	30	30
30~88	100	3
88~216	150	3
216~960	200	3
Above 960	500	3

Note: All modes were tested For restricted band radiated emission,
the test records reported below are the worst result compared to other modes.

11.4. TEST RESULT

RADIATED EMISSION BELOW 30MHZ

No emission found between lowest internal used/generated frequencies to 30MHz.

RADIATED EMISSION BELOW 1GHZ

EUT	Tablet PC	Model Name	G2
Temperature	25°C	Relative Humidity	55.4%
Pressure	960hPa	Test Voltage	Normal Voltage
Test Mode	802.11b with date rate 1 2412MHZ	Antenna	Horizontal

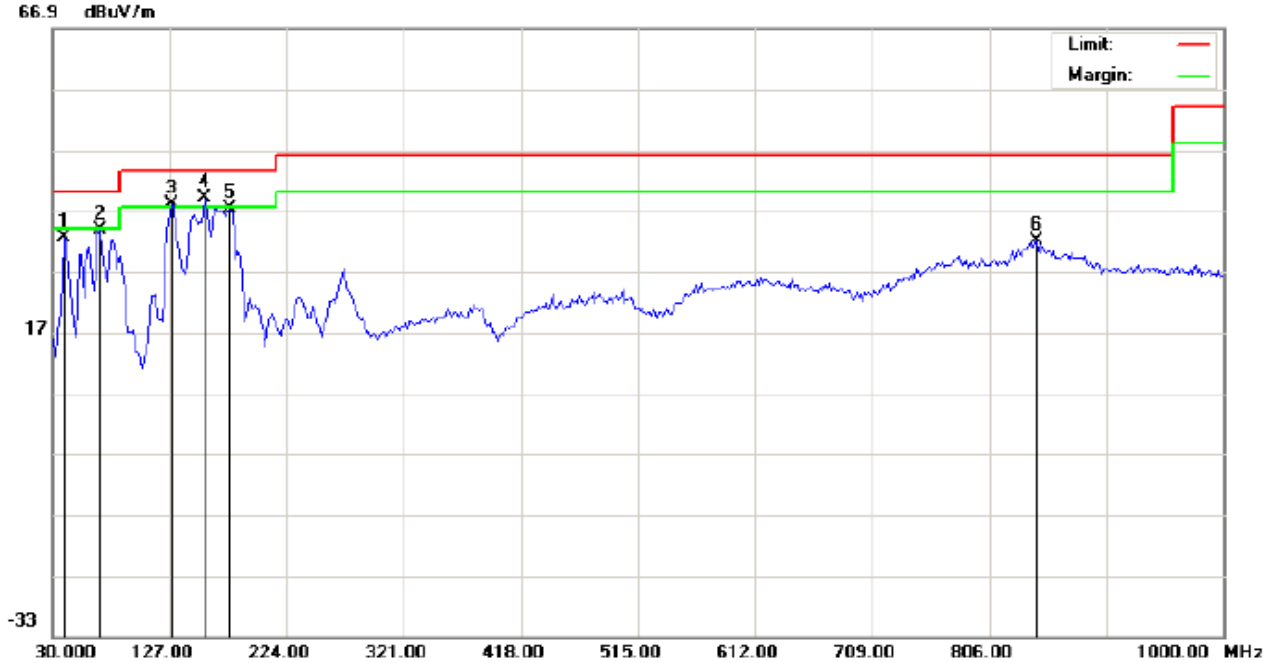

Site: site #1
 Limit: FCC Class B 3M Radiation
 EUT: Tablet PC
 M/N: G2
 Mode: Low channel TX
 Note:

Polarization: *Horizontal*
 Power:
 Distance:

Temperature: 26
 Humidity: 60 %

No.	Mk	Freq.	Reading	Factor	Measurement	Limit	Over	Detector	Antenna Height	Table Degree	Comment
		MHz	dBuV	dB/m	dBuV/m	dBuV/m	dB		cm	degree	
1		39.7000	24.51	8.04	32.55	40.00	-7.45	peak			
2		68.8000	30.91	2.91	33.82	40.00	-6.18	peak			
3	!	128.6167	24.25	13.89	38.14	43.50	-5.36	peak			
4	*	156.1000	25.35	13.74	39.09	43.50	-4.41	peak			
5		177.1167	25.39	11.82	37.21	43.50	-6.29	peak			
6		844.8000	1.24	30.81	32.05	46.00	-13.95	peak			

RESULT: PASS

EUT	Tablet PC	Model Name	G2
Temperature	25°C	Relative Humidity	55.4%
Pressure	960hPa	Test Voltage	Normal Voltage
Test Mode	802.11b with data rate 1 2412MHZ	Antenna	Vertical

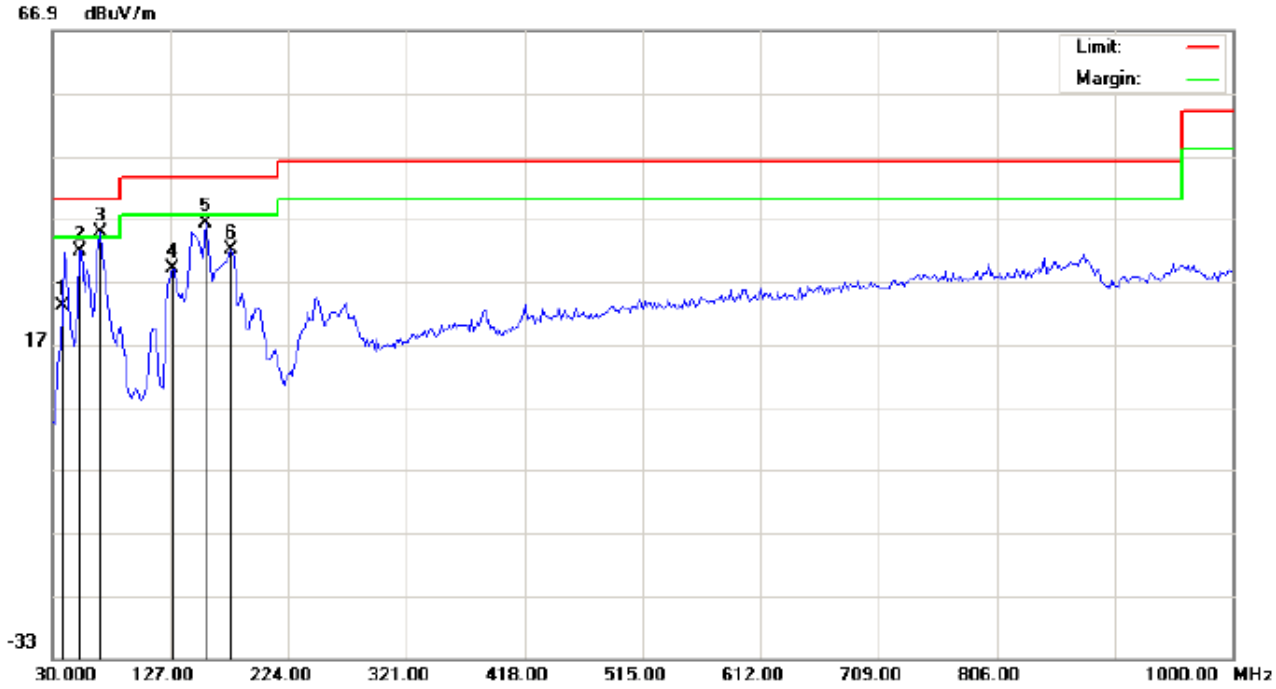

Site: site #1
 Limit: FCC Class B 3M Radiation
 EUT: Tablet PC
 M/N: G2
 Mode: Low channel TX
 Note:

Polarization: **Vertical**
 Power:
 Distance:

Temperature: 26
 Humidity: 60 %

No.	Mk	Freq.	Reading	Factor	Measurement	Limit	Over	Detector	Antenna Height	Table Degree	Comment
		MHz	dBuV	dB/m	dBuV/m	dBuV/m	dB		cm	degree	
1		38.0833	15.35	7.60	22.95	40.00	-17.05	peak			
2		52.6333	27.79	3.99	31.78	40.00	-8.22	peak			
3	*	68.8000	30.95	3.79	34.74	40.00	-5.26	peak			
4		128.6167	20.05	8.95	29.00	43.50	-14.50	peak			
5		156.1000	24.93	11.44	36.37	43.50	-7.13	peak			
6		177.1167	25.21	6.71	31.92	43.50	-11.58	peak			

RESULT: PASS

EUT	Tablet PC	Model Name	G2
Temperature	25°C	Relative Humidity	55.4%
Pressure	960hPa	Test Voltage	Normal Voltage
Test Mode	802.11b with data rate 1 2437MHZ	Antenna	Horizontal

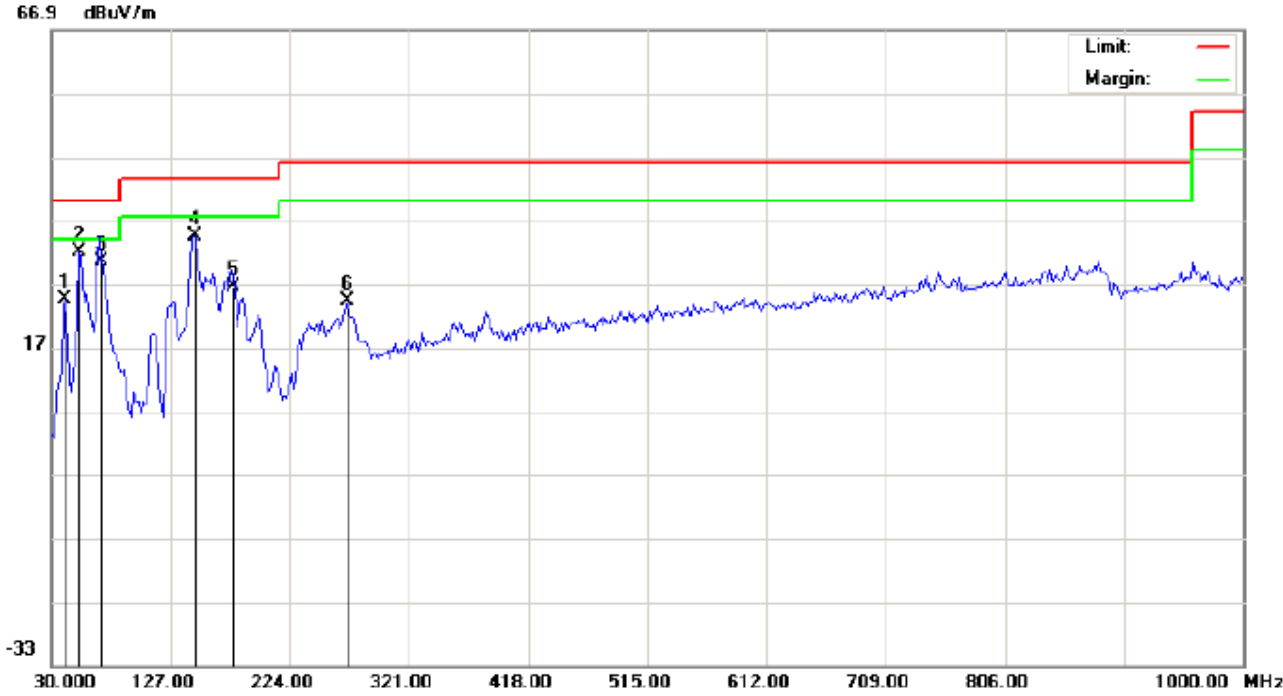

Site: site #1
 Limit: FCC Class B 3M Radiation
 EUT: Tablet PC
 M/N: G2
 Mode: Middle channel TX
 Note:

Polarization: *Horizontal*
 Power:
 Distance:

Temperature: 26
 Humidity: 60 %

No.	Mk	Freq.	Reading	Factor	Measurement	Limit	Over	Detector	Antenna Height	Table Degree	Comment
		MHz	dBuV	dB/m	dBuV/m	dBuV/m	dB		cm	degree	
1		41.3167	17.65	6.79	24.44	40.00	-15.56	peak			
2	*	52.6333	27.99	3.99	31.98	40.00	-8.02	peak			
3		70.4167	26.27	4.34	30.61	40.00	-9.39	peak			
4		146.4000	21.23	13.29	34.52	43.50	-8.98	peak			
5		178.7332	19.52	7.03	26.55	43.50	-16.95	peak			
6		270.8833	8.94	15.39	24.33	46.00	-21.67	peak			

RESULT: PASS

EUT	Tablet PC	Model Name	G2
Temperature	25°C	Relative Humidity	55.4%
Pressure	960hPa	Test Voltage	Normal Voltage
Test Mode	802.11b with date rate 1 2437MHZ	Antenna	Vertical

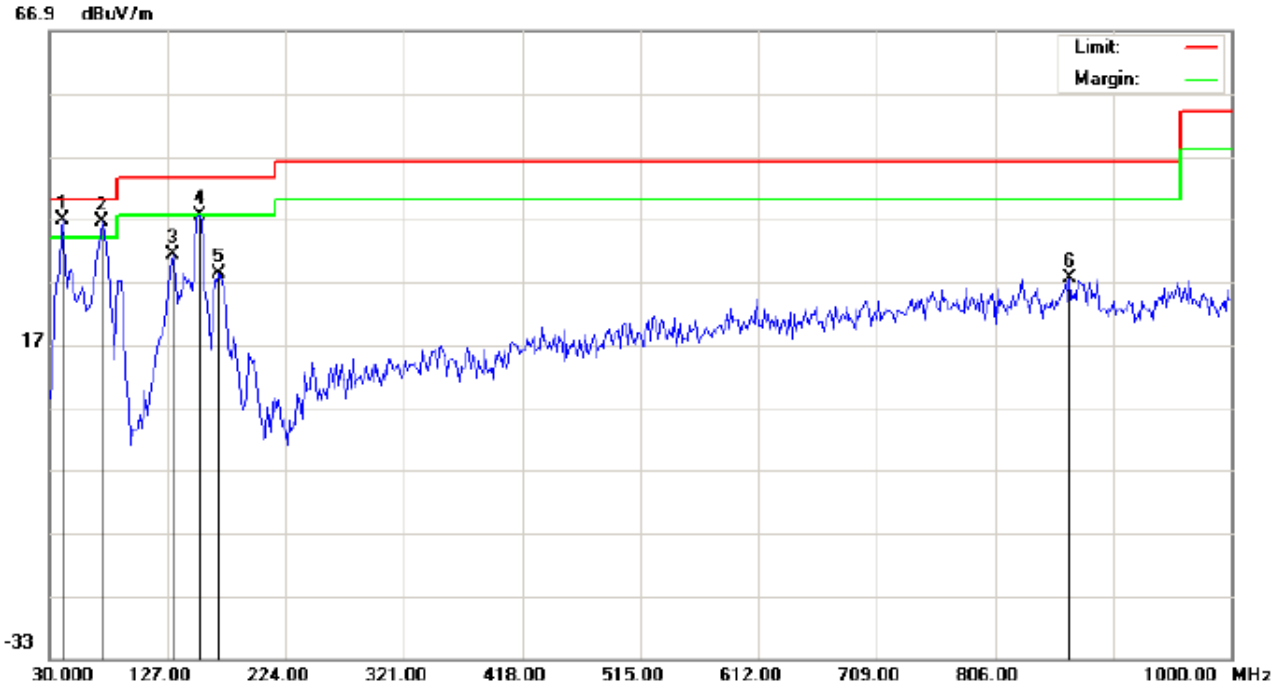

Site: site #1
 Limit: FCC Class B 3M Radiation
 EUT: Tablet PC
 M/N: G2
 Mode: Middle channel TX
 Note:

Polarization: *Vertical*
 Power:
 Distance:

Temperature: 26
 Humidity: 60 %

No.	Mk	Freq.	Reading	Factor	Measurement	Limit	Over	Detector	Antenna Height	Table Degree	Comment
		MHz	dBuV	dB/m	dBuV/m	dBuV/m	dB		cm	degree	
1	*	41.3166	29.90	6.79	36.69	40.00	-3.31	peak			
2	!	73.6500	31.17	5.35	36.52	40.00	-3.48	peak			
3		131.8500	21.40	9.93	31.33	43.50	-12.17	peak			
4		152.8667	24.57	12.93	37.50	43.50	-6.00	peak			
5		169.0333	22.62	5.74	28.36	43.50	-15.14	peak			
6		867.4333	-1.95	29.60	27.65	46.00	-18.35	peak			

RESULT: PASS

EUT	Tablet PC	Model Name	G2
Temperature	25°C	Relative Humidity	55.4%
Pressure	960hPa	Test Voltage	Normal Voltage
Test Mode	802.11b with date rate 1 2462MHZ	Antenna	Horizontal

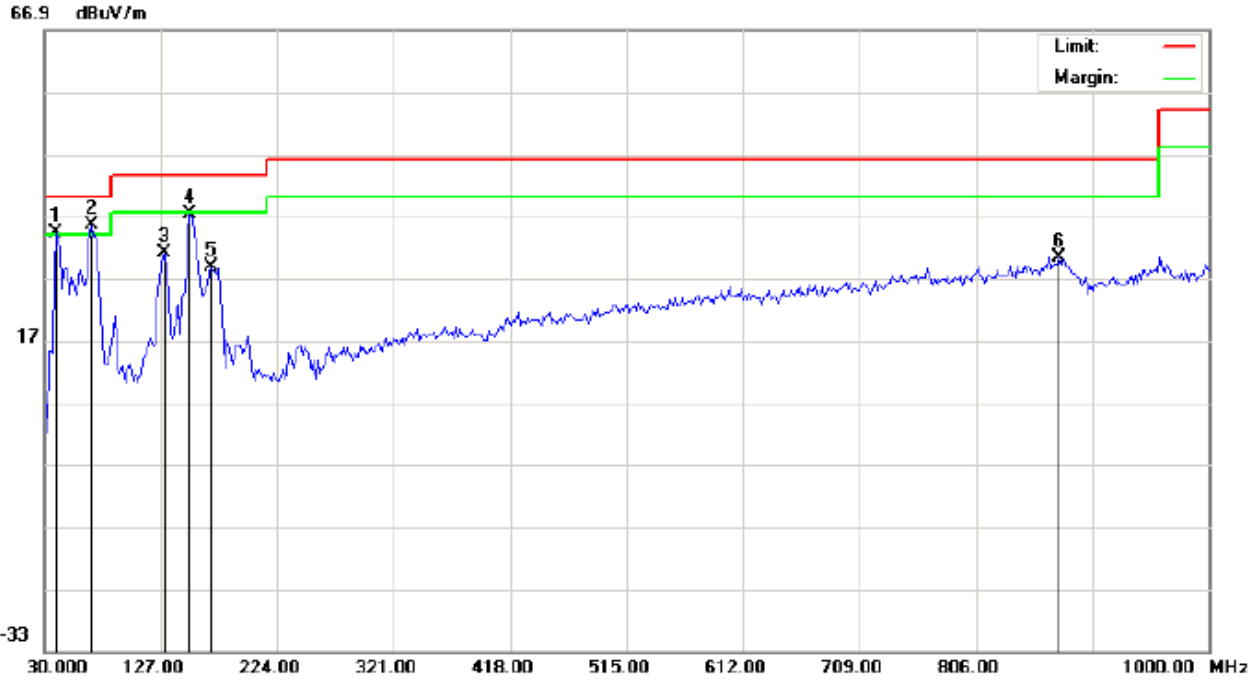

Site: site #1
 Limit: FCC Class B 3M Radiation
 EUT: Tablet PC
 M/N: G2
 Mode: High channel TX
 Note:

Polarization: **Horizontal**
 Power:
 Distance:

Temperature: 26
 Humidity: 60 %

No.	Mk	Freq.	Reading	Factor	Measurement	Limit	Over	Detector	Antenna Height	Table Degree	Comment
		MHz	dBuV	dB/m	dBuV/m	dBuV/m	dB		cm	degree	
1	!	39.7000	26.60	7.76	34.36	40.00	-5.64	peak			
2	*	68.8000	31.68	3.79	35.47	40.00	-4.53	peak			
3		130.2332	21.39	9.61	31.00	43.50	-12.50	peak			
4		151.2500	23.71	13.67	37.38	43.50	-6.12	peak			
5		169.0333	23.06	5.74	28.80	43.50	-14.70	peak			
6		875.5167	0.14	30.14	30.28	46.00	-15.72	peak			

RESULT: PASS

EUT	Tablet PC	Model Name	G2
Temperature	25°C	Relative Humidity	55.4%
Pressure	960hPa	Test Voltage	Normal Voltage
Test Mode	802.11b with date rate 1 2462MHZ	Antenna	Vertical

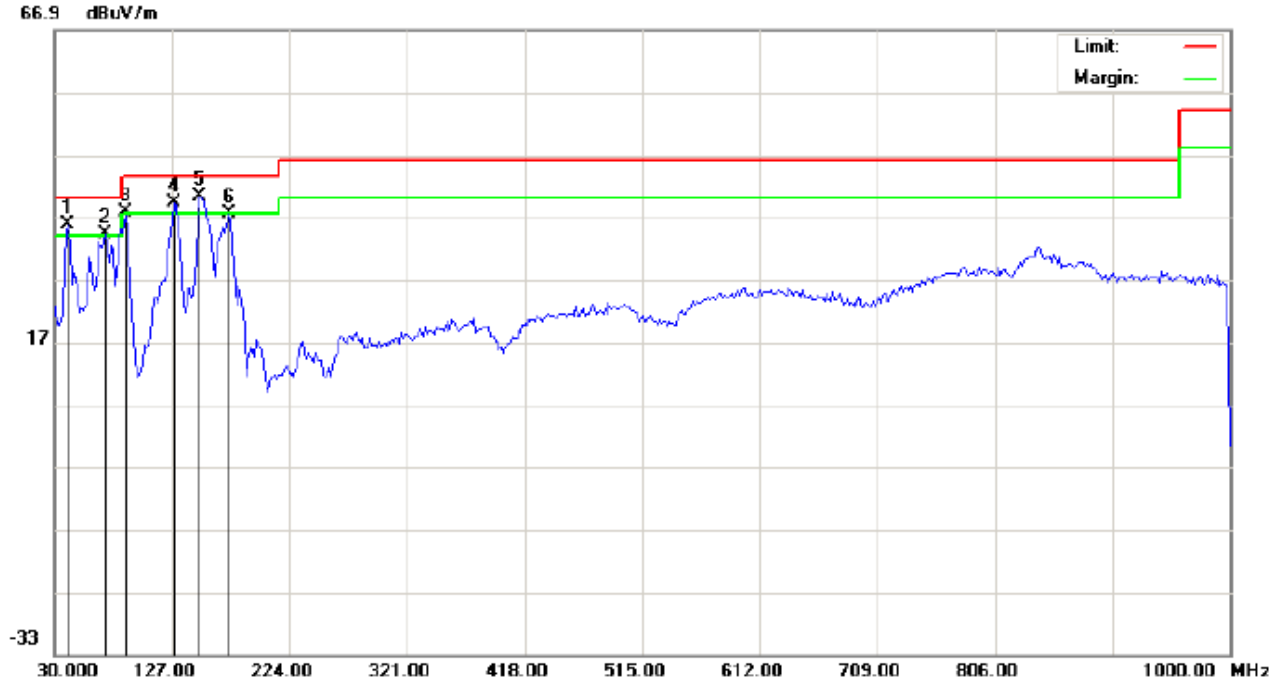

Site: site #1
 Limit: FCC Class B 3M Radiation
 EUT: Tablet PC
 M/N: G2
 Mode: High channel TX
 Note:

Polarization: *Vertical*
 Power:
 Distance:

Temperature: 26
 Humidity: 60 %

No.	Mk	Freq.	Reading	Factor	Measurement	Limit	Over	Detector	Antenna Height	Table Degree	Comment
		MHz	dBuV	dB/m	dBuV/m	dBuV/m	dB		cm	degree	
1	!	41.3166	28.38	7.34	35.72	40.00	-4.28	peak			
2	!	72.0332	30.87	3.45	34.32	40.00	-5.68	peak			
3	!	88.2000	21.74	16.03	37.77	43.50	-5.73	peak			
4	!	128.6167	25.34	13.89	39.23	43.50	-4.27	peak			
5	*	149.6332	27.06	13.30	40.36	43.50	-3.14	peak			
6		173.8833	26.09	11.39	37.48	43.50	-6.02	peak			

RESULT: PASS

Note: Measurement= Reading + Factor, Over=Measure-Limit.

RADIATED EMISSION ABOVE 1GHZ

EUT	Tablet PC	Model Name	G2
Temperature	25°C	Relative Humidity	55.4%
Pressure	960hPa	Test Voltage	Normal Voltage
Test Mode	802.11b with date rate 1 2412MHZ	Antenna	Horizontal

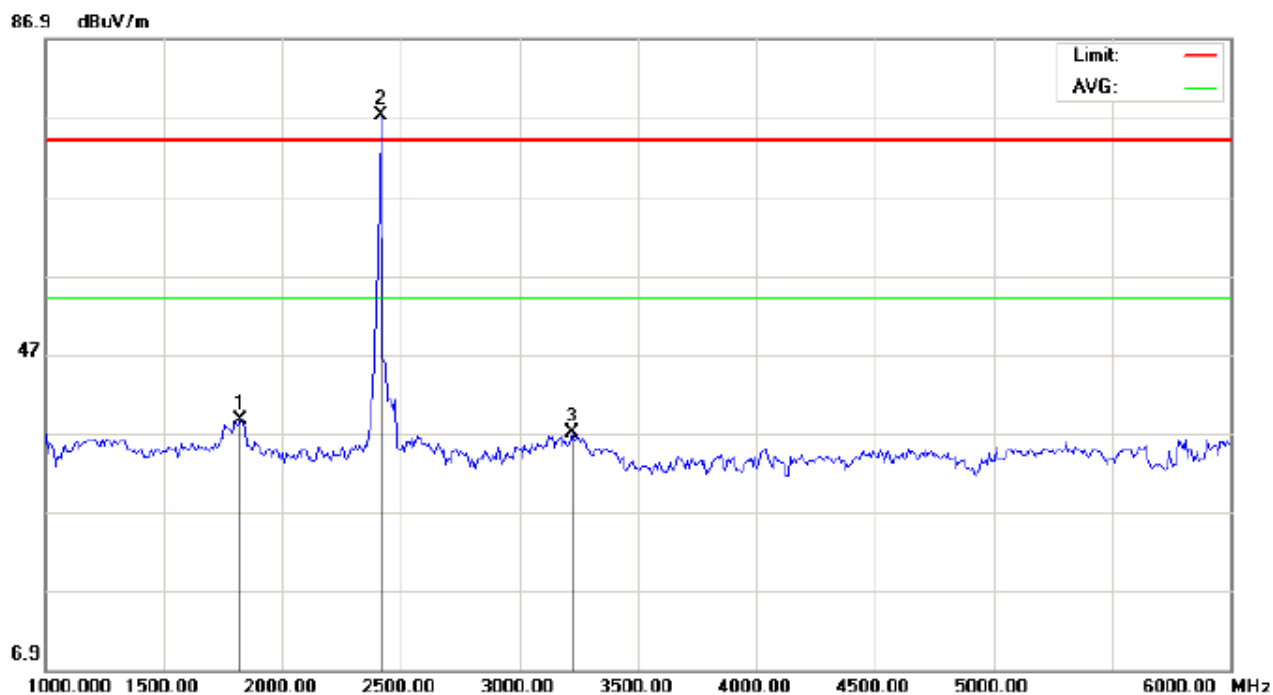

Site: site #1
Polarization: *Horizontal* Temperature: 26
Limit: FCC Class B 3M Radiation above 1GHZ(PK) Power:
Humidity: 60 %
EUT: Tablet PC Distance: 3m
M/N: G2
Mode: Low channel
Note:

No.	Mk	Freq.	Reading	Factor	Measurement	Limit	Over	Detector	Antenna Height	Table Degree	Comment
		MHz	dBuV	dB/m	dBuV/m	dBuV/m	dB		cm	degree	
1		1825.000	38.63	0.00	38.63	74.00	-35.37	peak			
2	*	2416.667	77.16	0.00	77.16	74.00	3.16	peak			
3		3225.000	36.91	0.00	36.91	74.00	-37.09	peak			

**The mark "2" is the basic frequency.

RESULT: PASS

EUT	Tablet PC	Model Name	G2
Temperature	25°C	Relative Humidity	55.4%
Pressure	960hPa	Test Voltage	Normal Voltage
Test Mode	802.11b with date rate 1 2412MHZ	Antenna	Vertical

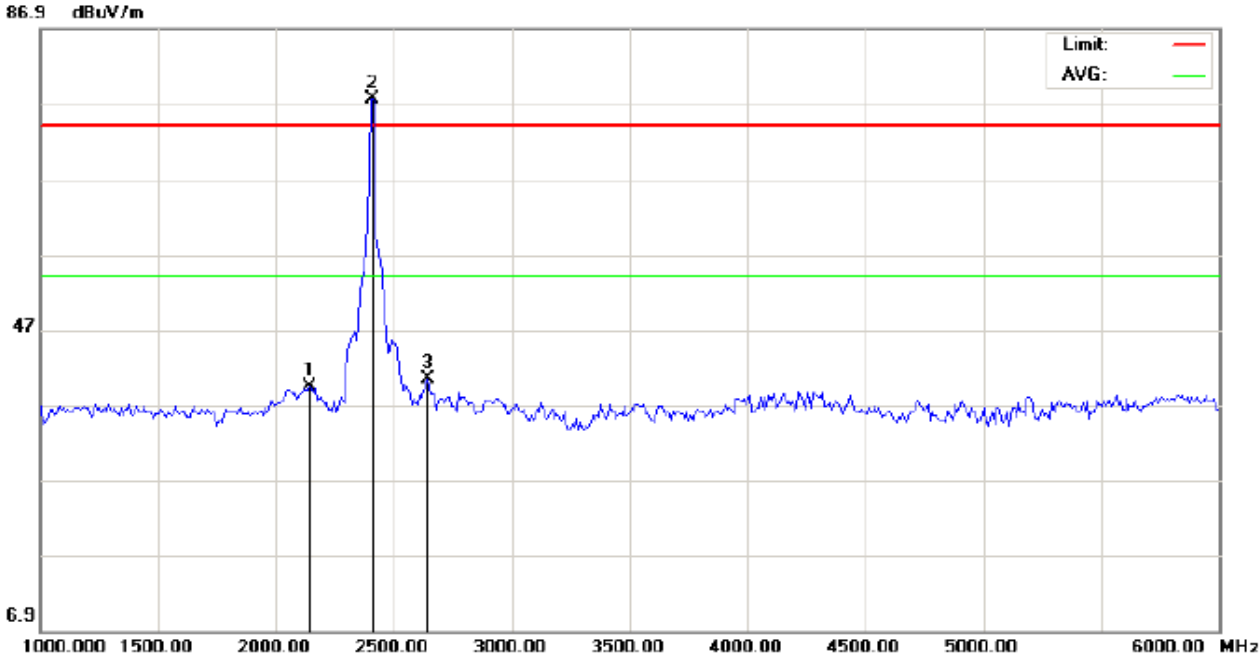

Site: site #1
Limit: FCC Class B 3M Radiation above 1GHZ(PK)
EUT: Tablet PC
M/N: G2
Mode: Low channel
Note:

Polarization: *Vertical*
Power:
Distance: 3m

Temperature: 26
Humidity: 60 %

No.	Mk	Freq.	Reading	Factor	Measurement	Limit	Over	Detector	Antenna Height	Table Degree	Comment
		MHz	dBuV	dB/m	dBuV/m	dBuV/m	dB		cm	degree	
1		2141.667	39.40	0.00	39.40	74.00	-34.60	peak			
2	*	2408.333	77.63	0.00	77.63	74.00	3.63	peak			
3		2641.667	40.42	0.00	40.42	74.00	-33.58	peak			

**The mark"2" is the basic frequency.

RESULT: PASS

Note: The other modes radiation emissions have more than 20dB margin.

Measurement= Reading + Factor, Over=Measure-Limit.

All modes radiation emission from 6GHz to 25GHz at least have 20dB margin.

12. BAND EDGE EMISSION

12.1. MEASUREMENT PROCEDURE

1. Set the EUT Work on the top, the bottom operation frequency individually.
2. Set SPA Start or Stop Frequency = Operation Frequency, $RBW \geq 1\% \text{span}$, $VBW \geq RBW$
3. The band edges was measured and recorded.

12.2. TEST SET-UP

Radiated same as 11.2

12.3. TEST RESULT

EUT	Tablet PC	Model Name	G2
Temperature	25°C	Relative Humidity	55.4%
Pressure	960hPa	Test Voltage	Normal Voltage
Test Mode	802.11b with data rate 1 2412MHZ	Antenna	Horizontal

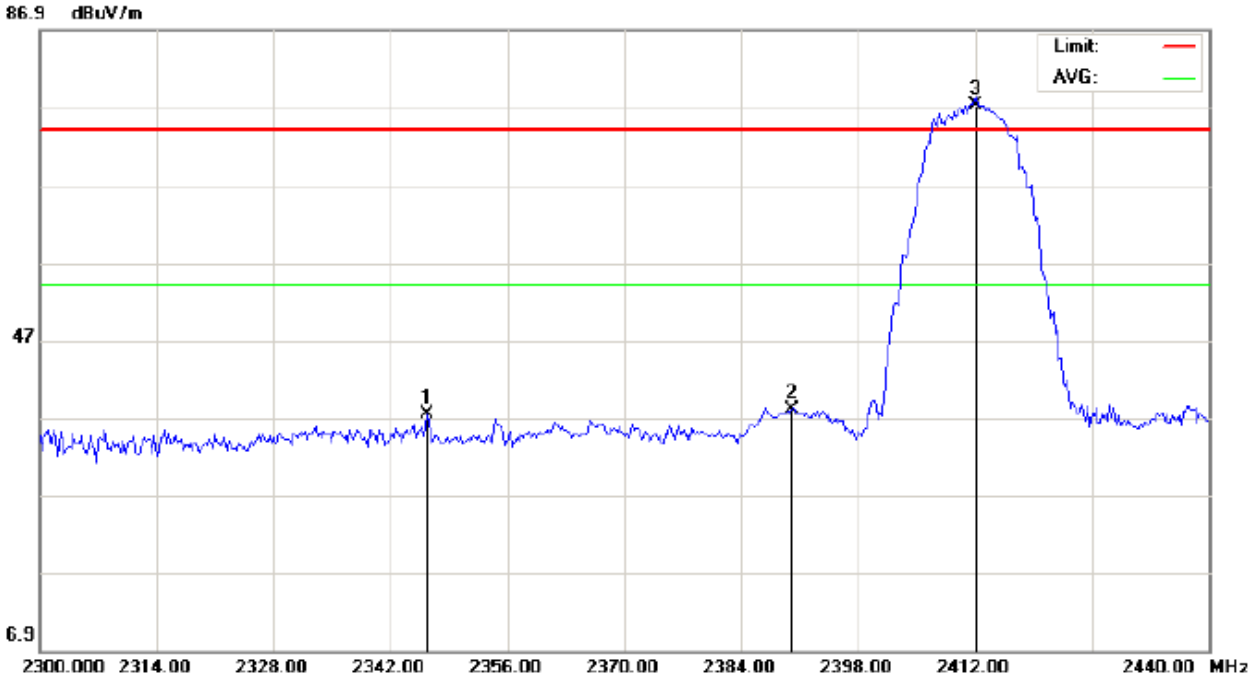

Site: site #1 Polarization: *Horizontal* Temperature: 26
 Limit: FCC Class B 3M Radiation above 1GHZ(PK) Power: Humidity: 60 %
 EUT: Tablet PC Distance: 3m
 M/N: G2
 Mode: 802.11b Low channel TX
 Note:

No.	Mk	Freq.	Reading	Factor	Measurement	Limit	Over	Detector	Antenna Height	Table Degree	Comment
		MHz	dBuV	dB/m	dBuV/m	dBuV/m	dB		cm	degree	
1		2346.433	37.45	0.00	37.45	74.00	-36.55	peak			
2		2390.009	38.10	0.00	38.10	74.00	-35.90	peak			
3	*	2412.025	77.23	0.00	77.23	74.00	3.23	peak			

RESULT: PASS

EUT	Tablet PC	Model Name	G2
Temperature	25°C	Relative Humidity	55.4%
Pressure	960hPa	Test Voltage	Normal Voltage
Test Mode	802.11b with data rate 1 2412MHZ	Antenna	Vertical

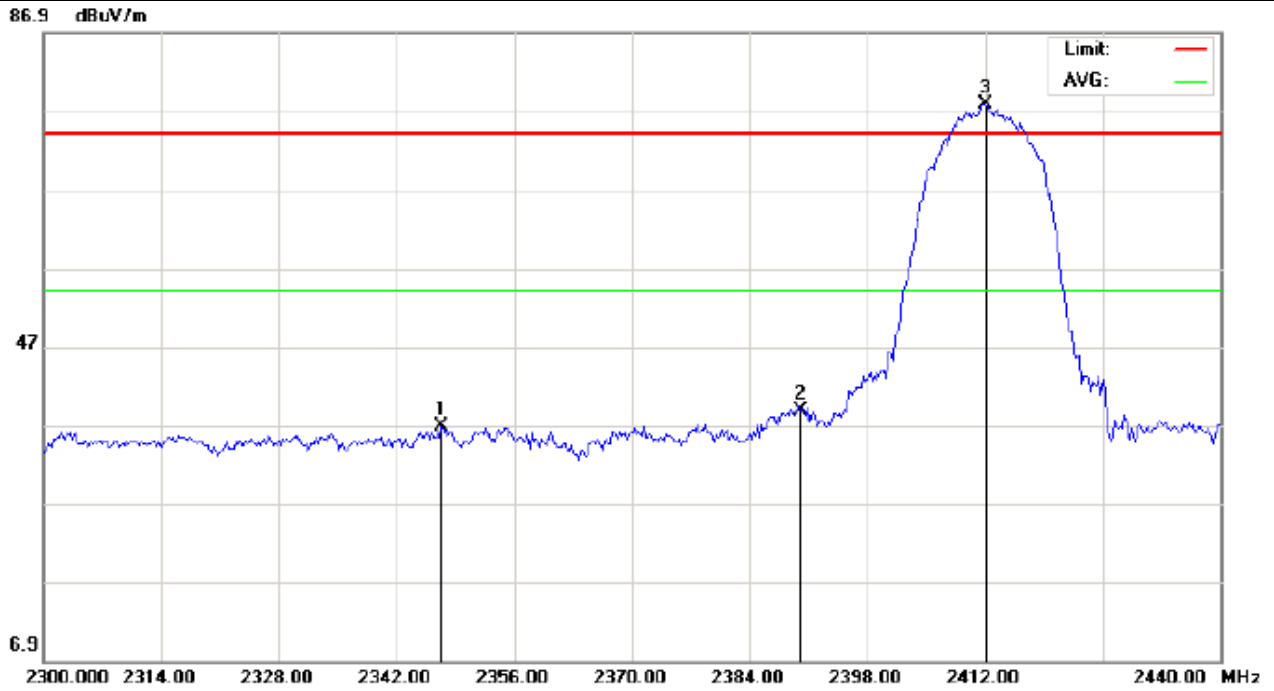

Site: site #1 Polarization: *Vertical* Temperature: 26
 Limit: FCC Class B 3M Radiation above 1GHZ(PK) Power: Humidity: 60 %
 EUT: Tablet PC Distance: 3m
 M/N: G2
 Mode: 802.11b Low channel TX
 Note:

No.	Mk	Freq.	Reading	Factor	Measurement	Limit	Over	Detector	Antenna Height	Table Degree	Comment
		MHz	dBuV	dB/m	dBuV/m	dBuV/m	dB		cm	degree	
1		2347.367	36.84	0.00	36.84	74.00	-37.16	peak			
2		2390.012	38.75	0.00	38.75	74.00	-35.25	peak			
3	*	2412.004	77.86	0.00	77.86	74.00	3.86	peak			

RESULT: PASS

EUT	Tablet PC	Model Name	G2
Temperature	25°C	Relative Humidity	55.4%
Pressure	960hPa	Test Voltage	Normal Voltage
Test Mode	802.11b with data rate 1 2462MHZ	Antenna	Horizontal

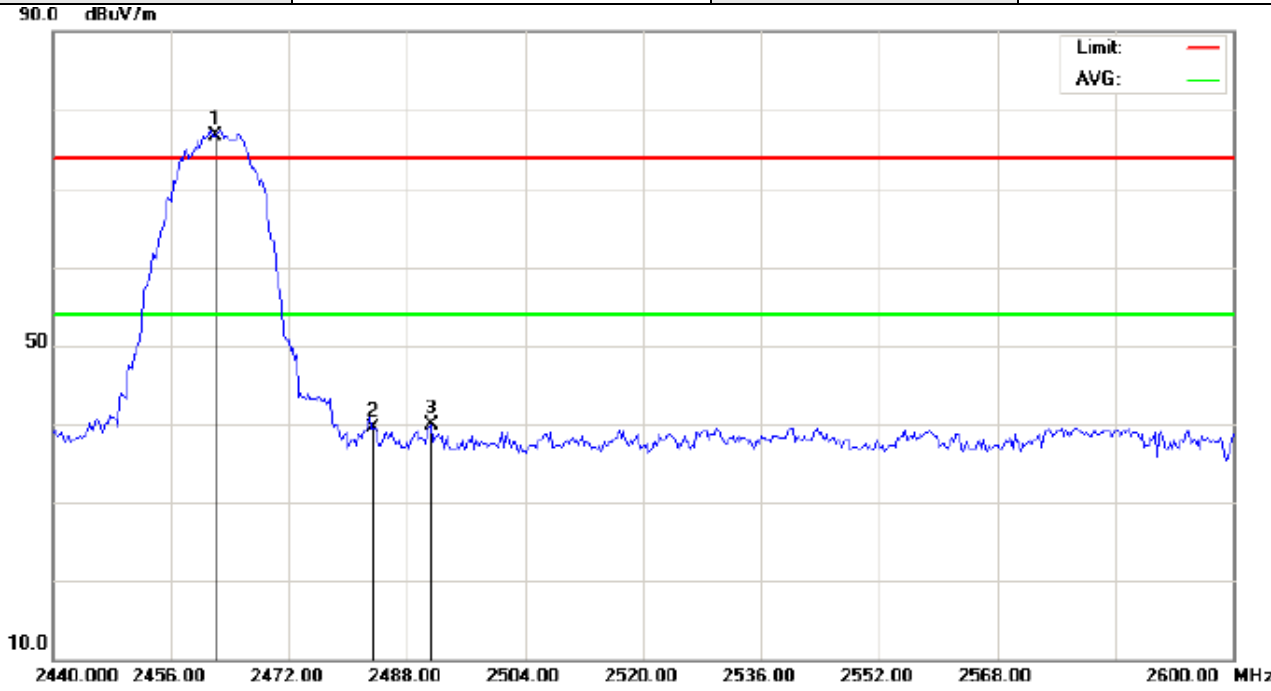

Site: site #1 Polarization: *Horizontal* Temperature: 26
Limit: FCC Class B 3M Radiation above 1GHZ(PK) Power: Humidity: 60 %
EUT: Tablet PC Distance: 3m
M/N: G2
Mode: 802.11b High channel TX
Note:

No.	Mk	Freq.	Reading	Factor	Measurement	Limit	Over	Detector	Antenna	Table	Comment
		MHz	dBuV	dB/m	dBuV/m	dBuV/m	dB		Height	Degree	
									cm	degree	
1	*	2462.031	76.76	0.00	76.76	74.00	2.76	peak			
2		2483.501	39.58	0.00	39.58	74.00	-34.42	peak			
3		2491.200	39.95	0.00	39.95	74.00	-34.05	peak			

RESULT: PASS

EUT	Tablet PC	Model Name	G2
Temperature	25°C	Relative Humidity	55.4%
Pressure	960hPa	Test Voltage	Normal Voltage
Test Mode	802.11b with data rate 1 2462MHZ	Antenna	Vertical

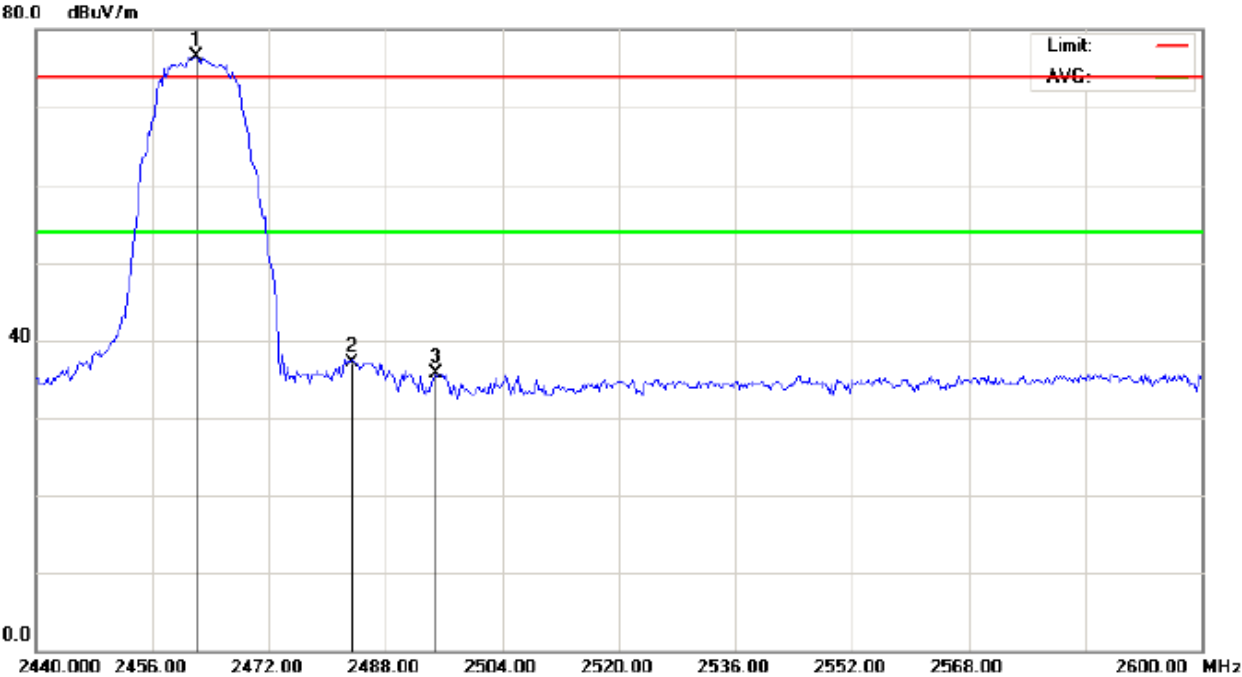

Site: site #1
 Limit: FCC Class B 3M Radiation above 1GHZ(PK)
 EUT: Tablet PC
 M/N: G2
 Mode: 802.11b High channel TX
 Note:

Polarization: *Vertical*
 Power:
 Distance: 3m

Temperature: 26
 Humidity: 60 %

No.	Mk	Freq.	Reading	Factor	Measurement	Limit	Over	Detector	Antenna Height	Table Degree	Comment
		MHz	dBuV	dB/m	dBuV/m	dBuV/m	dB		cm	degree	
1	*	2462.008	76.49	0.00	76.49	74.00	2.49	peak			
2		2483.512	37.13	0.00	37.13	74.00	-36.87	peak			
3		2494.933	35.71	0.00	35.71	74.00	-38.29	peak			

RESULT: PASS

EUT	Tablet PC	Model Name	G2
Temperature	25°C	Relative Humidity	55.4%
Pressure	960hPa	Test Voltage	Normal Voltage
Test Mode	802.11n 40 with data rate 13.5 2422MHZ	Antenna	Horizontal

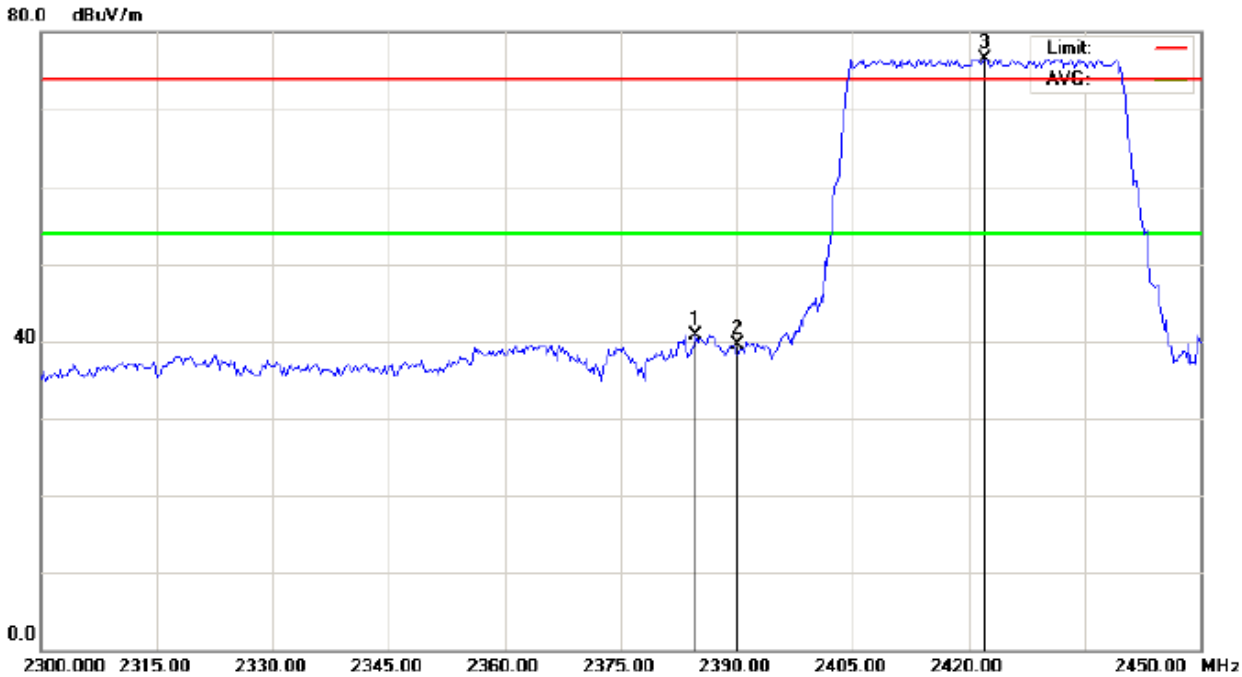

Site: site #1
Limit: FCC Class B 3M Radiation above 1GHZ(PK)
EUT: Tablet PC
M/N: G2
Mode: 802.11n(40) Low channel TX
Note:

Polarization: *Horizontal*
Power:
Distance: 3m

Temperature: 26
Humidity: 60 %

No.	Mk	Freq.	Reading	Factor	Measurement	Limit	Over	Detector	Antenna	Table	Comment
		MHz	dBuV	dB/m	dBuV/m	dBuV/m	dB		Height	Degree	
									cm	degree	
1		2384.750	40.64	0.00	40.64	74.00	-33.36	peak			
2		2390.033	39.56	0.00	39.56	74.00	-34.44	peak			
3	*	2422.037	76.43	0.00	76.43	74.00	2.43	peak			

RESULT: PASS

EUT	Tablet PC	Model Name	G2
Temperature	25°C	Relative Humidity	55.4%
Pressure	960hPa	Test Voltage	Normal Voltage
Test Mode	802.11n 40 with data rate 13.5 2422MHZ	Antenna	Vertical

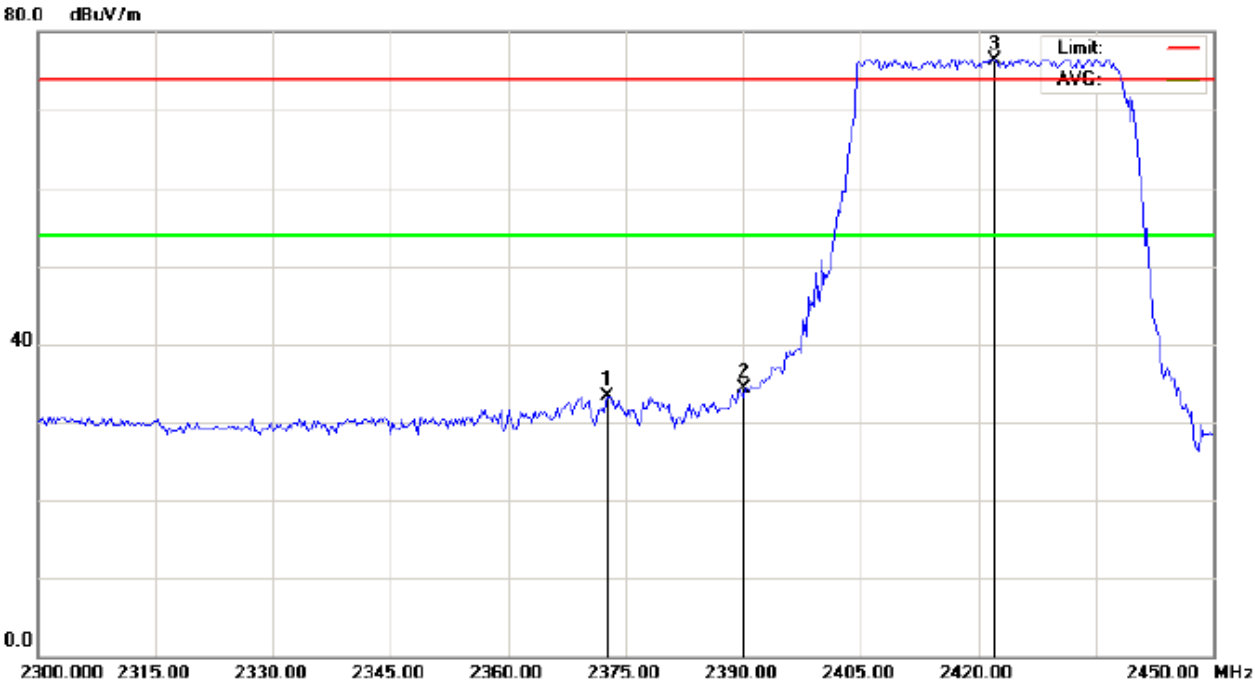

Site: site #1
 Limit: FCC Class B 3M Radiation above 1GHZ(PK)
 EUT: Tablet PC
 M/N: G2
 Mode: 802.11n(40) Low channel TX
 Note:

Polarization: **Vertical**
 Power:
 Distance: 3m

Temperature: 26
 Humidity: 60 %

No.	Mk	Freq.	Reading	Factor	Measurement	Limit	Over	Detector	Antenna Height	Table Degree	Comment
		MHz	dBuV	dB/m	dBuV/m	dBuV/m	dB		cm	degree	
1		2372.750	33.38	0.00	33.38	74.00	-40.62	peak			
2		2390.057	34.31	0.00	34.31	74.00	-39.69	peak			
3	*	2422.103	76.37	0.00	76.37	74.00	2.37	peak			

RESULT: PASS

EUT	Tablet PC	Model Name	G2
Temperature	25°C	Relative Humidity	55.4%
Pressure	960hPa	Test Voltage	Normal Voltage
Test Mode	802.11n 40 with data rate 13.5 2452MHZ	Antenna	Horizontal

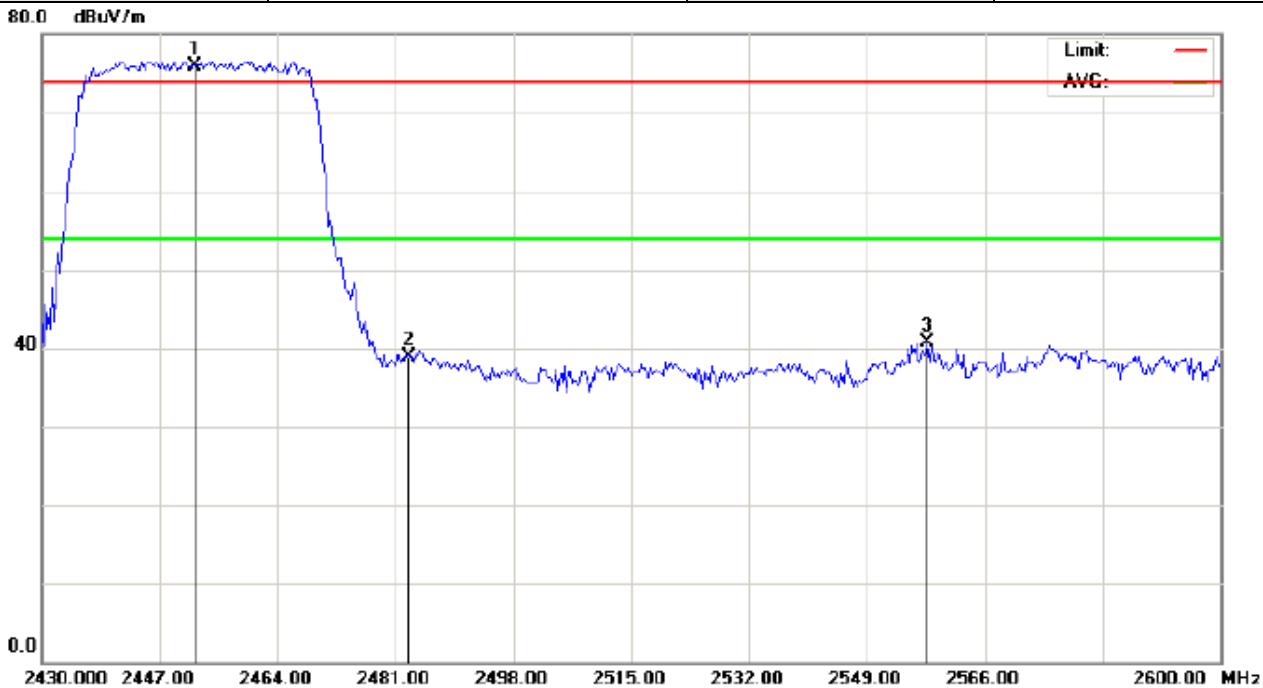

Site: site #1 Polarization: **Horizontal** Temperature: 26
 Limit: FCC Class B 3M Radiation above 1GHZ(PK) Power: Humidity: 60 %
 EUT: Tablet PC Distance: 3m
 M/N: G2
 Mode: 802.11n(40) High channel TX
 Note:

No.	Mk	Freq.	Reading	Factor	Measurement	Limit	Over	Detector	Antenna Height	Table Degree	Comment
		MHz	dBuV	dB/m	dBuV/m	dBuV/m	dB		cm	degree	
1	*	2452.043	76.00	0.00	76.00	74.00	2.00	peak			
2		2483.005	38.91	0.00	38.91	74.00	-35.09	peak			
3		2557.783	40.67	0.00	40.67	74.00	-33.33	peak			

RESULT: PASS

EUT	Tablet PC	Model Name	G2
Temperature	25°C	Relative Humidity	55.4%
Pressure	960hPa	Test Voltage	Normal Voltage
Test Mode	802.11n 40 with data rate 13.5 2452MHZ	Antenna	Vertical

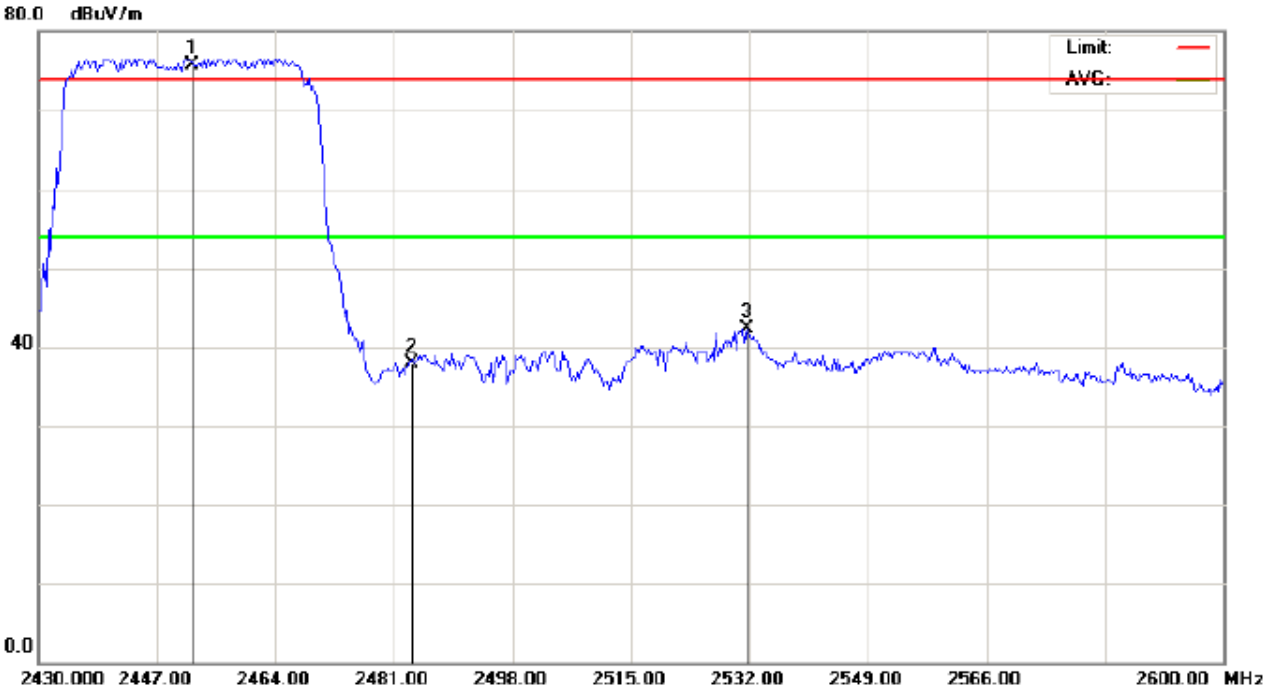

Site: site #1
 Limit: FCC Class B 3M Radiation above 1GHZ(PK)
 EUT: Tablet PC
 M/N: G2
 Mode: 802.11n(40) High channel TX
 Note:

Polarization: *Vertical*
 Power:
 Distance: 3m

Temperature: 26
 Humidity: 60 %

No.	Mk	Freq.	Reading	Factor	Measurement	Limit	Over	Detector	Antenna Height	Table Degree	Comment
		MHz	dBuV	dB/m	dBuV/m	dBuV/m	dB		cm	degree	
1	*	2452.128	75.61	0.00	75.61	74.00	1.61	peak			
2		2483.589	38.00	0.00	38.00	74.00	-36.00	peak			
3		2531.717	42.29	0.00	42.29	74.00	-31.71	peak			

RESULT: PASS

Note: the other modes radiation emission have enough 20dB margin.
 Measurement= Reading + Factor, Over=Measure-Limit.

13. FCC LINE CONDUCTED EMISSION TEST

13.1. LIMITS OF LINE CONDUCTED EMISSION TEST

Frequency	Maximum RF Line Voltage	
	Q.P.(dBuV)	Average(dBuV)
150kHz~500kHz	66-56	56-46
500kHz~5MHz	56	46
5MHz~30MHz	60	50

Note:

1. The lower limit shall apply at the transition frequency.
2. The limit decreases linearly with the logarithm of the frequency in the range 0.15 MHz to 0.50 MHz.

13.2. BLOCK DIAGRAM OF LINE CONDUCTED EMISSION TEST

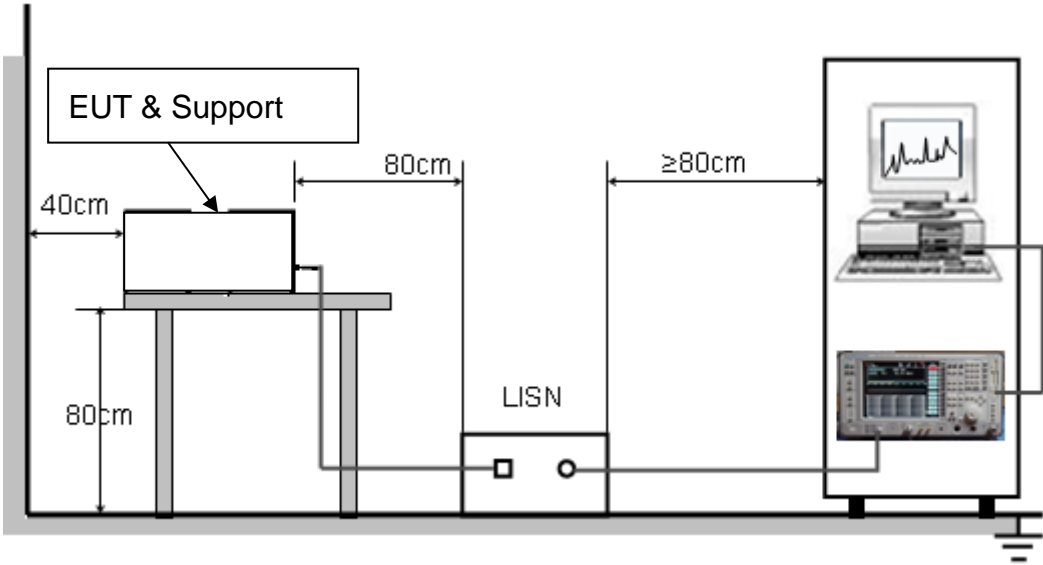

13.3. PRELIMINARY PROCEDURE OF LINE CONDUCTED EMISSION TEST

1. The equipment was set up as per the test configuration to simulate typical actual usage per the user's manual. When the EUT is a tabletop system, a wooden table with a height of 0.8 meters is used and is placed on the ground plane as per ANSI C63.4 (see Test Facility for the dimensions of the ground plane used). When the EUT is a floor-standing equipment, it is placed on the ground plane which has a 3-12 mm non-conductive covering to insulate the EUT from the ground plane.
2. Support equipment, if needed, was placed as per ANSI C63.4.
3. All I/O cables were positioned to simulate typical actual usage as per ANSI C63.4.
4. All support equipments received AC120V/60Hz power from a LISN, if any.
5. The EUT received DC5V charging voltage by adapter which received 120V/60Hz power by a LISN..
6. The test program was started. Emissions were measured on each current carrying line of the EUT using a spectrum Analyzer / Receiver connected to the LISN powering the EUT. The LISN has two monitoring points: Line 1 (Hot Side) and Line 2 (Neutral Side). Two scans were taken: one with Line 1 connected to Analyzer / Receiver and Line 2 connected to a 50 ohm load; the second scan had Line 1 connected to a 50 ohm load and Line 2 connected to the Analyzer / Receiver.
7. Analyzer / Receiver scanned from 150 kHz to 30MHz for emissions in each of the test modes.
8. During the above scans, the emissions were maximized by cable manipulation.
9. The test mode(s) were scanned during the preliminary test.

Then, the EUT configuration and cable configuration of the above highest emission level were recorded for reference of final testing.

13.4. FINAL PROCEDURE OF LINE CONDUCTED EMISSION TEST

1. EUT and support equipment was set up on the test bench as per step 2 of the preliminary test.
2. A scan was taken on both power lines, Line 1 and Line 2, recording at least the six highest emissions. Emission frequency and amplitude were recorded into a computer in which correction factors were used to calculate the emission level and compare reading to the applicable limit. If EUT emission level was less -2dB to the A.V. limit in Peak mode, then the emission signal was re-checked using Q.P and Average detector.
3. The test data of the worst case condition(s) was reported on the Summary Data page.

13.5. TEST RESULT OF LINE CONDUCTED EMISSION TEST

LINE CONDUCTED EMISSION TEST LINE 1-L

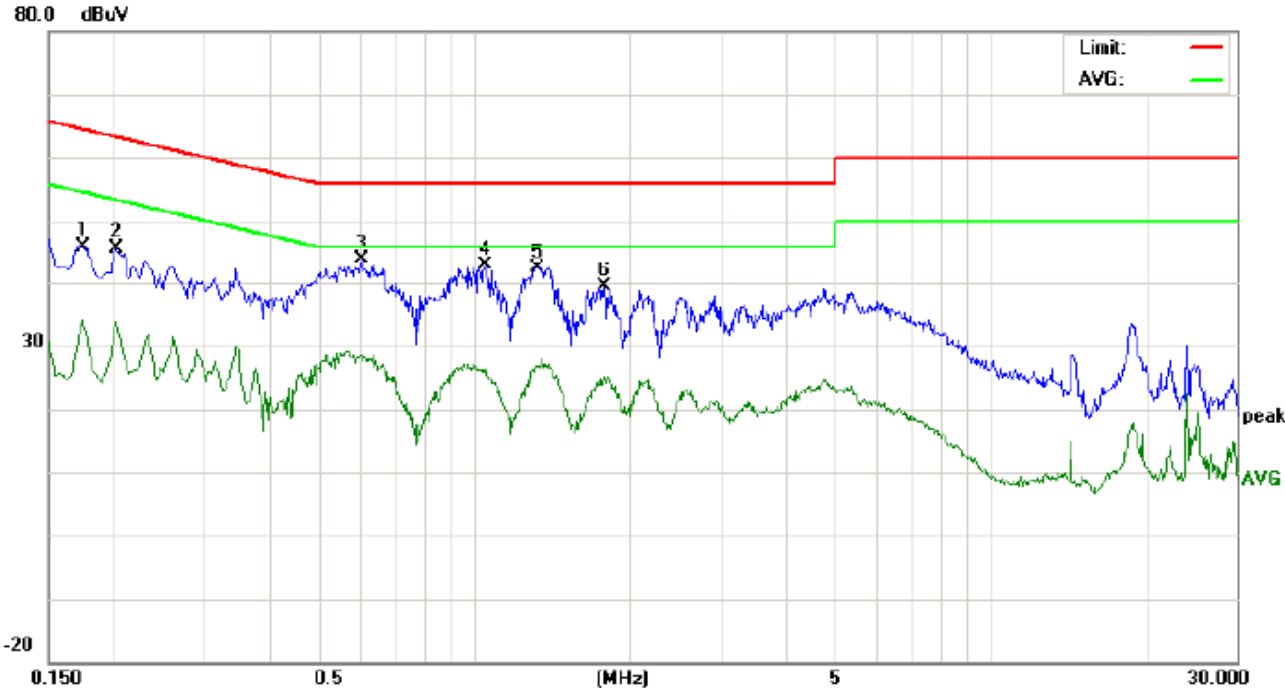

Site: Conduction Phase: *L1* Temperature: 26
 Limit: FCC Class B Conduction(QP) Power: Humidity: 60 %
 EUT: Tablet PC
 M/N: G2
 Mode: Normal operation(wifi)
 Note:

No.	Freq. (MHz)	Reading_Level (dBuV)			Correct Factor	Measurement (dBuV)			Limit (dBuV)		Margin (dB)		P/F	Comment
		Peak	QP	AVG		dB	Peak	QP	AVG	QP	AVG	QP		
1	0.1737	35.76		23.91	10.19	45.95		34.10	64.78	54.78	-18.83	-20.68	P	
2	0.2020	35.46		23.74	10.22	45.68		33.96	63.52	53.52	-17.84	-19.56	P	
3	0.6058	33.55		18.29	10.31	43.86		28.60	56.00	46.00	-12.14	-17.40	P	
4	1.0540	32.50		14.98	10.37	42.87		25.35	56.00	46.00	-13.13	-20.65	P	
5	1.3300	32.09		16.57	10.38	42.47		26.95	56.00	46.00	-13.53	-19.05	P	
6	1.7900	29.12		14.85	10.29	39.41		25.14	56.00	46.00	-16.59	-20.86	P	

Line Conducted Emission Test Line 2-N

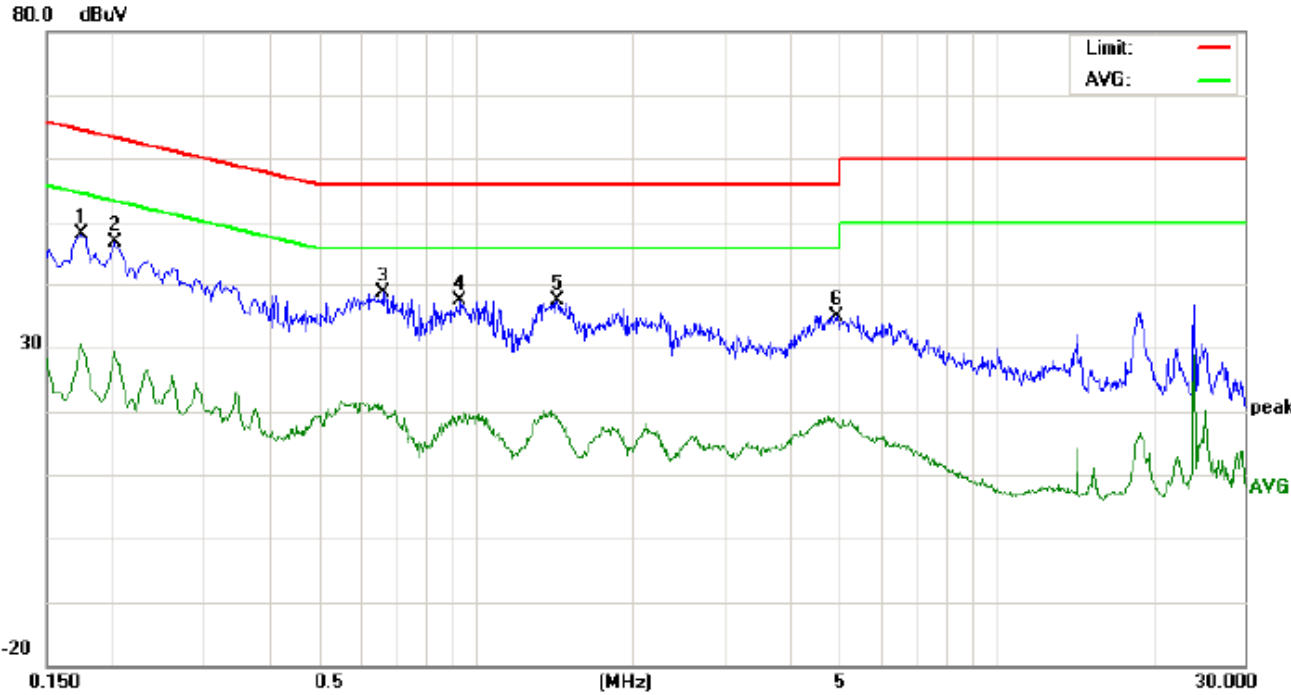

Site: Conduction Phase: **N** Temperature: 26
 Limit: FCC Class B Conduction(QP) Power: Humidity: 60 %
 EUT: Tablet PC
 M/N: G2
 Mode: Normal operation(wifi)
 Note:

No.	Freq. (MHz)	Reading_Level (dBuV)			Correct Factor (dB)	Measurement (dBuV)			Limit (dBuV)		Margin (dB)		P/F	Comment
		Peak	QP	AVG		Peak	QP	AVG	QP	AVG	QP	AVG		
1	0.1737	37.99		20.43	10.19	48.18		30.62	64.78	54.78	-16.60	-24.16	P	
2	0.2038	35.09		18.12	10.22	45.31		28.34	63.45	53.45	-18.14	-25.11	P	
3	0.6620	28.36		9.63	10.33	38.69		19.96	56.00	46.00	-17.31	-26.04	P	
4	0.9340	27.05		8.80	10.40	37.45		19.20	56.00	46.00	-18.55	-26.80	P	
5	1.4378	27.04		8.75	10.38	37.42		19.13	56.00	46.00	-18.58	-26.87	P	
6	4.9419	24.72		7.88	10.24	34.96		18.12	56.00	46.00	-21.04	-27.88	P	

APPENDIX A: PHOTOGRAPHS OF TEST SETUP
FCC LINE CONDUCTED EMISSION TEST SETUP



FCC RADIATED EMISSION TEST SETUP

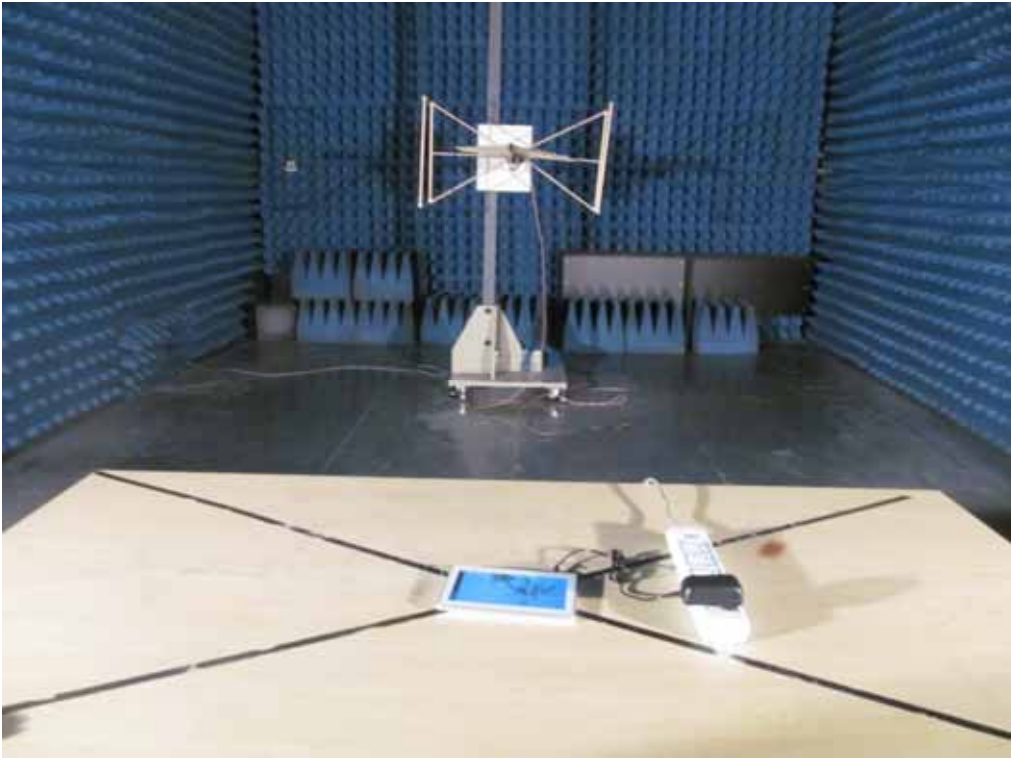

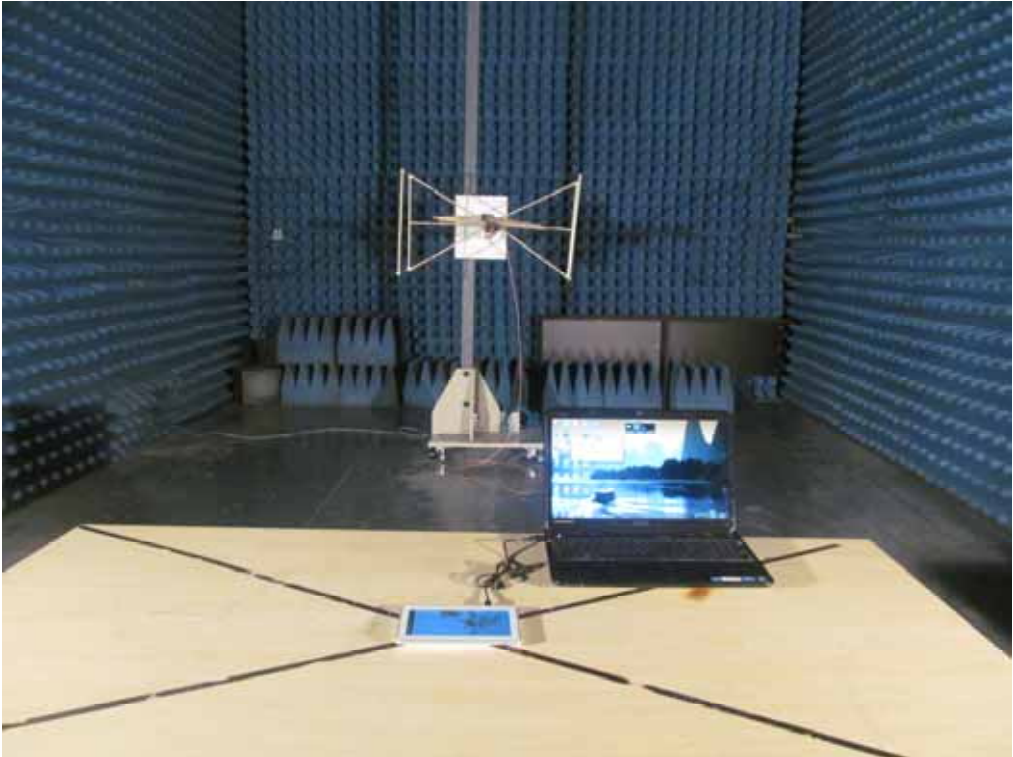

APPENDIX B: PHOTOGRAPHS OF EUT
TOTAL VIEW OF EUT



TOP VIEW OF EUT



BOTTOM VIEW OF EUT



FRONT VIEW OF EUT



BACK VIEW OF EUT



LEFT VIEW OF EUT



RIGHT VIEW OF EUT

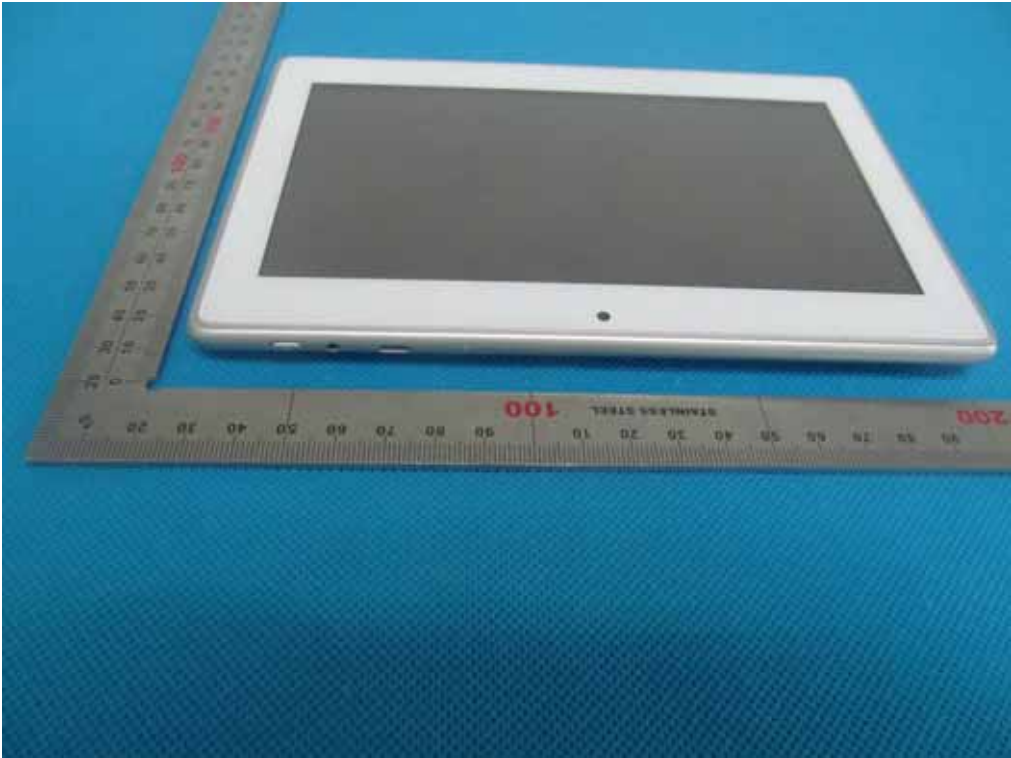

OPEN VIEW OF EUT-1



INTERNAL VIEW OF EUT-1



INTERNAL VIEW OF EUT-2

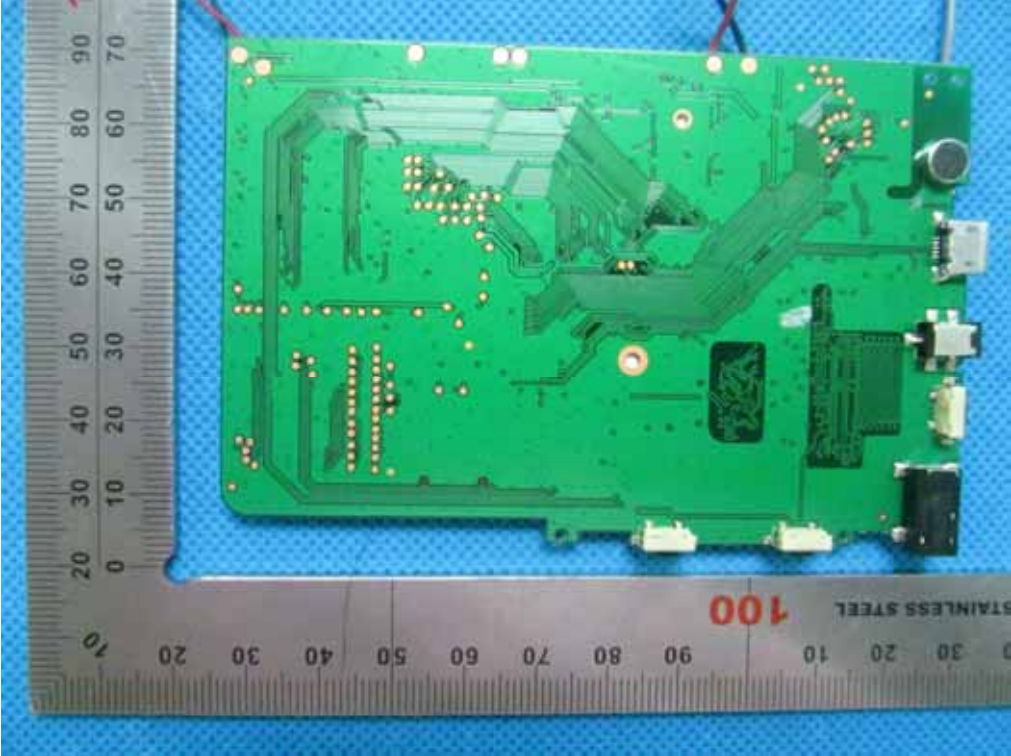

----END OF REPORT----