

5. Block Diagram

BLOCK DIAGRAM

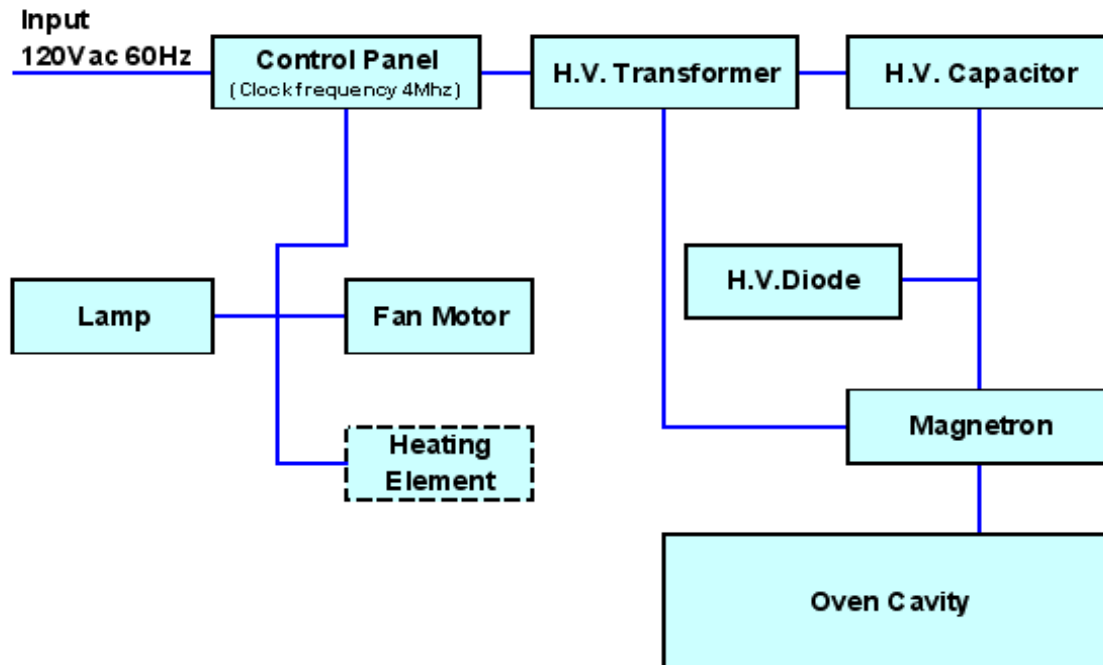

Note: Components outlined with dotted line is optional and may not be employed in the model

■ OPERATION DESCRIPTION

After main power supply, When we press Start button, DC 5V enter the microm of Control panel and Main relay on and then High voltage circuit formed.

DC 4KV be create by combination of H.V Transformer, H.V Capacitor and H.V Diode.

This high voltage, DC 4KV get into Magnetron and then Microwave generate.

FCC ID: C5F7NF1NMO100N