

# **FCC TEST REPORT**

for

## **47 CFR Part 24E**

Equipment : **GSM 1900 Mobile Phone**  
Model No. : **J6**  
FCC ID : **BW3DB-2068C**  
Filing Type : **Certification**  
Applicant : **DBTEL Incorporated**  
No. 29, Tzu Chiang St., Tu-Cheng, Taipei, Taiwan

- The test result refers exclusively to the test presented test model / sample.
- Without written approval of SPORTON International Inc., the test report shall not be reproduced except in full.
- **Certificate or Test Report must not be used by the applicant to claim the product in this test report endorsement by NVLAP or any agency of U.S. government.**

### ***SPORTON International Inc.***

6F, No.106, Sec. 1, Hsin Tai Wu Rd., Hsi Chih, Taipei Hsien, Taiwan, R.O.C.

---

The applicant has been cautioned as to the following:

15.21 Information to User.

The users manual or instruction manual for an intentional radiator shall caution the user that changes or modifications not expressly approved by the party responsible for compliance could void the user's authority to operate the equipment.

15.27(a) Special Accessories.

Equipment marketed to a consumer must be capable of complying with the necessary regulations in the configuration in which the equipment is marketed. Where special accessories, such as shielded cables and/or special connectors are required to enable an unintentional or intentional radiator to comply with the emission limits in this part, the equipment must be marketed with, i.e. shipped and sold with, those special accessories. However, in lieu of shipping or packaging the special accessories with the unintentional or intentional radiator, the responsible party may employ other methods of ensuring that the special accessories are provided to the consumer, without additional charge.

Information detailing any alternative method used to supply the special accessories for a grant of equipment authorization or retained in the verification records, as appropriate. The party responsible for the equipment, as detailed in § 2.909 of this chapter, shall ensure that these special accessories are provided with the equipment. The instruction manual for such devices shall include appropriate instructions on the first page of text concerned with the installation of the device that these special accessories must be used with the device. It is the responsibility of the user to use the needed special accessories supplied with the equipment.

**Table of Contents**

<b>Rule</b>	<b>Description</b>	<b>Page</b>
	Test Report	4
2.1033(c)	General Information Required	5
2.1033(c)(14)	Rule Summary	9
	General Information	10
	Standard Test Conditions and Engineering Practices	11
2.1046(a)	EIRP Carrier Power (Radiated)	12
2.1051, 2.1049(c), 24, 24.238(b)	Transmitter Conducted Measurements	17
	Conducted Spurious Emission	23
2.1053(a)	Field Strength of Spurious Radiation	28
2.1055(a)(1)	Frequency Stability (Temperature Variation)	40
2.1055(b)(1)	Frequency Stability (Voltage Variation)	43
	Antenna Factor & Cable Loss	44
	List of Measuring Equipments	45
	Uncertainty of Test Site	46
<b>Appendix A</b>	<b>External Product Photograph</b>	
<b>Appendix B</b>	<b>Internal Photograph</b>	
<b>Appendix C</b>	<b>Set up Photograph</b>	

## FCC TEST REPORT

Report No. : F462501-01

Required information per ISO/IEC Guide 25-1990, paragraph 13.2:

a) **Test Report**

b) Laboratory: Sporton International Inc.  
No.52, Hwa-Ya 1<sup>st</sup> RD., Hwa Ya Technology Park, Kwei-Shan  
Hsiang, TaoYuan Hsien, Taiwan, R.O.C.

c) Report Number: F462501-01

d) Client: DBTEL Incorporated  
No. 29 Tzu Chiang St., Tu-Cheng, Taipei, Taiwan

e) Identification: Model Name: J6  
FCC ID : BW3DB-2068C  
Description: GSM 1900 Radio

f) EUT Condition: Not required unless specified in individual tests.

g) Report Date: Aug. 02, 2004  
EUT Received: July 28, 2004

h, j, k): As indicated in individual tests.

i) Sampling method: No sampling procedure used.

l) Uncertainty: In accordance with Sporton internal quality manual.

m) Supervised by:  8/3/2004  
Hendry Yang

n) Results: The results presented in this report relate only to the item tested.

o) Reproduction: This report must not be reproduced, except in full, without written permission from this laboratory.

Accessories Used During Testing:

Type	Model
EUT	J6
Earpiece	N/A

**List of General Information Required for Certification**

In Accordance with FCC Rules and Regulations,  
Volume II, Part 2 and  
24E, Confidentiality

**Sub-Part 2.1033**

**(c)(1): Name and Address of Applicant:**

DBTEL Incorporated  
No. 29 Tzu Chiang St., Tu-Cheng, Taipei,  
Taiwan

**Manufacturer**

DBTEL Incorporated  
No. 29 Tzu Chiang St., Tu-Cheng, Taipei,  
Taiwan

**(c)(2): FCC ID:** BW3DB-2068C

**Model Number:** J6

**(c)(3): Instruction Manual(s):**

Please See Attached Exhibits

**(c)(4): Type of Emission:** 300 KGXW

**(c)(5): FREQUENCY RANGE, MHz:** 1850.2 to 1909.8

**(c)(6): Power Rating, Watts:** 0.832 (conducted)  
0.622 (EIRP)  
x Switchable Variable N/A

**(c)(7): Maximum Power Rating, Watts:** 1

**Subpart 2.1033** (continued)

(c)(8): Voltages & Currents in All Elements in Final RF Stage, Including Final Transistor or Solid State Device:

Collector Current, A = 0.5  
Collector Voltage, Vdc = 3.6  
Supply Voltage, Vdc = 3.6

(c)(9): **Tune-Up Procedure:**

Please See Attached Exhibits

(c)(10): **Circuit Diagram/Circuit Description:**

Please See Attached Exhibits

(c)(11): **Label Information:**

Please See Attached Exhibits

(c)(12): **Photographs:**

Please See Attached Exhibits

(c)(13): **Digital Modulation Description:**

Attached Exhibits  
 N/A

(c)(14): **Test and Measurement Data:**

Follows

---

**Testimonial  
and  
Statement of Certification**

**This is to certify that:**

1. **That** the application was prepared either by, or under the direct supervision of, the undersigned.
2. **That** the technical data supplied with the application was taken under my direction and supervision.
3. **That** the data was obtained on representative units, randomly selected.
4. **That**, to the best of my knowledge and belief, the facts set forth in the application and accompanying technical data are true and correct.

Certified by:

  
Daniel Lee  
Manager

Certificate of NVLAP Accreditation

United States Department of Commerce  
National Institute of Standards and Technology

**NVLAP**<sup>®</sup>

Certificate of Accreditation

SPORTON INTERNATIONAL, INC.  
TAIPEI HSIEN 221  
TAIWAN

*is recognized by the National Voluntary Laboratory Accreditation Program  
for satisfactory compliance with criteria set forth in NIST Handbook 150:2001,  
all requirements of ISO/IEC 17025:1999, and relevant requirements of ISO 9002:1994.  
Accreditation is awarded for specific services, listed on the Scope of Accreditation, for:*

**ELECTROMAGNETIC COMPATIBILITY AND TELECOMMUNICATIONS**

December 31, 2004

*Effective through*

  
For the National Institute of Standards and Technology  
NVLAP Lab Code: 200079-0



ISO/IEC 17025:1999  
ISO 9002:1994

NVLAP-01C (06-01)



Sub-part

**2.1033(c)(14): Test and Measurement Data**

All tests and measurement data shown were performed in accordance with FCC Rules and Regulations, Volume II; Part 2, Sub-part J, Sections 2.947, 2.1033(c), 2.1041, 2.1046, 2.1047, 2.1079, 2.1051, 2.1053, 2.1055, 2.1057 and the following individual Parts:

- 22 – Public Mobile Services
- 22 Subpart H - Cellular Radiotelephone Service
- x 24 – Personal Communications Services

**General Information**

Product Feature & Specification	
1. Type of Modulation	GMSK
2. Number of Channels	GSM 1900 : 512 to 810
3. Frequency Band , MHz	Tx:: 1850-1910 Rx: 1930-1990
4. Channel Spacing	200 KHz
5. Maximum Output Power to Antenna	29.2 dBm
6. HW Version	Main PCB: 56E, Sub PCB: 57F, Link PCB: 58H
7. SW Version	11version
8. Antenna Type	Fixed External Antenna

**Standard Test Conditions  
and  
Engineering Practices**

Except as noted herein, the following conditions and procedures were observed during the testing:

In accordance with TIA603, and unless otherwise indicated in the specific measurement results, the ambient temperature of the actual EUT was maintained within the range of 10° to 40°C (50° to 104 °F) unless the particular equipment requirements specify testing over a different temperature range. Also, unless otherwise indicated, the humidity levels were in the range of 10% to 90% relative humidity.

Prior to testing, the EUT was tuned up in accordance with the manufacturer's alignment procedures. All external gain controls were maintained at the position of maximum and/or optimum gain throughout the testing.

Measurement results, unless otherwise noted, are worst-case measurements.

**Name of Test:** EIRP Carrier Power (Radiated)

**Specification:** TIA/EIA 603A (Substitution Method)

**Definition:** The average radiated power of device is the equivalent power required, when delivered to a substitution antenna, to produce at a distant point the same average received power as produced by the licensed device.

**Method Of Measurement:**

a) Connect the equipment as illustrated. Place the transmitter to be tested on the turntable in the standard test site.

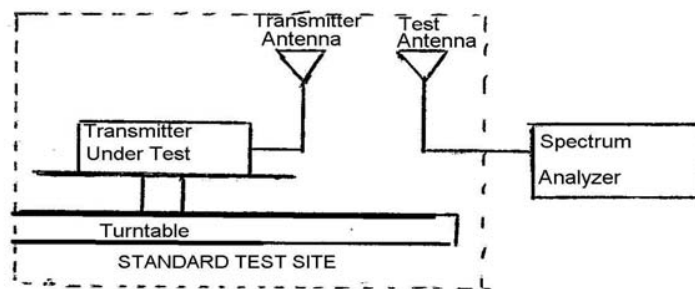

b) Raise and lower the test antenna from 1m to 4m and rotate turntable from 0° to 360°. Record the highest received signal showed in spectrum analyzer as  $R_t$ . Calculate electric field strength in receive antenna as  $E_t$ .

$$E_t = R_t + AF$$

AF (dB/m): Receive Antenna Factor

c) Replace the transmitter under test with a substitution antenna. The center of the antenna should be at the same location as the transmitter under test. Connect the antenna to a signal generator with a known output power level  $P_s$ . Raise and lower the test antenna like in step b) and record the highest received signal showed in spectrum analyzer as  $R_s$ . Calculate electric field strength in receive antenna as  $E_s$ .

$$E_s = R_s + AF$$

AF (dB/m): Receive Antenna Factor

d) Calculate radiated power as following:

$$EIRP = P_s + E_t - E_s + G_s$$

$P_s$  (dBm): Input Power to Substitution Antenna

$G_s$  (dBi) : Substitution Antenna Gain

Results Attached

*Tim Kao*

Tested By:

Tim Kao

**Test Results For:** EIRP Carrier Power (Radiated)

**Conducted Power**

Bands	Channel	Frequency (MHz)	Conducted Power (dBm)	Conducted Power (Watts)
GSM 1900	512	1850.2 (Low)	29.2	0.832
	661	1880.0 (Mid)	29.1	0.813
	810	1909.8 (High)	29.1	0.813

**EIRP**

Freq MHz	Pol	Substitution Antenna Input Power (dBm)	Substitution Antenna Gain (dBi)	Et (dBuV/m)	Es (dBuV/m)	Et - Es (dB)	Radiated Power (dBm)	Radiated Power (Watts)
1850.27	H	-3.76	6.64	124.17	101.70	22.47	25.36	0.343
1880.07	H	-3.78	6.65	125.79	101.64	24.15	27.02	0.504
1909.87	H	-3.81	6.66	126.66	101.58	25.08	27.93	0.622
1850.15	V	-3.76	6.64	123.19	101.70	21.49	24.38	0.274
1879.90	V	-3.78	6.65	124.86	101.64	23.22	26.09	0.406
1909.83	V	-3.81	6.66	125.77	101.58	24.19	27.04	0.506

GSM 1900 CH512 Horizontal Polarization

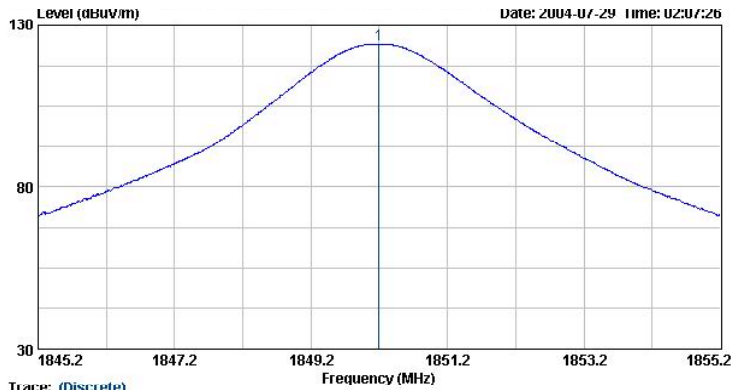

Trace: (Discrete)  
 Site : 03CH06  
 Condition : NULL 3m HF-HORN AH-118 HORIZONTAL  
 EUT : Tri-band handset  
 Power : 110Vac/60Hz  
 Model : J6  
 Memo : PCS CH512

	Freq	Level	Over	Limit	Antenna	Preamp	Cable	Remark	Ant	Table
	MHz	dBuV/m	dB	dBuV/m	Factor	Factor	Loss		Pos	Pos
					dB/m	dB	dB		cm	deg
1	1850.20	124.17	-----	-----	27.25	0.00	2.92	Peak	---	---

GSM 1900 CH512 Vertical Polarization

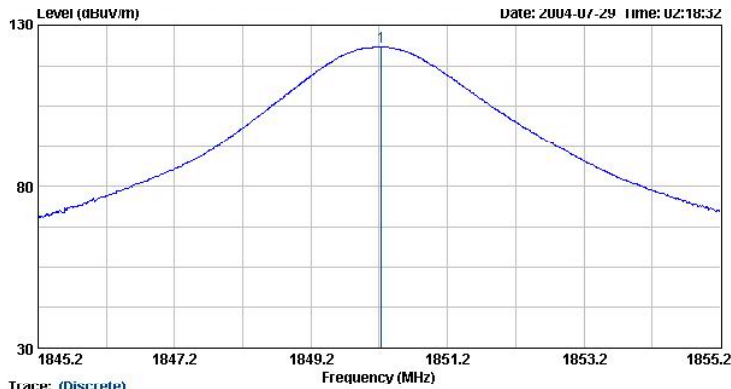

Trace: (Discrete)  
 Site : 03CH06  
 Condition : NULL 3m HF-HORN AH-118 VERTICAL  
 EUT : Tri-band handset  
 Power : 110Vac/60Hz  
 Model : J6  
 Memo : PCS CH512

	Freq	Level	Over	Limit	Antenna	Preamp	Cable	Remark	Ant	Table
	MHz	dBuV/m	dB	dBuV/m	Factor	Factor	Loss		Pos	Pos
					dB/m	dB	dB		cm	deg
1	1850.23	123.22	-----	-----	27.25	0.00	2.92	Peak	---	---

**GSM 1900 CH661 Horizontal Polarization**

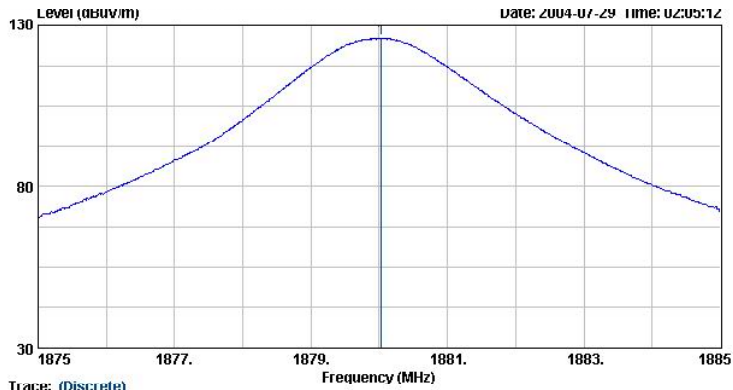

Trace: (Discrete)  
 Site : 03CH06  
 Condition : NULL 3m HF-HORN AH-118 HORIZONTAL  
 EUT : Tri-band handset  
 Power : 110Vac/60Hz  
 Model : J6  
 Memo : PCS CH661

	Freq	Level	Over	Limit	Antenna	Preamp	Cable	Remark	Ant	Table
	MHz	dBuV/m	dB	dBuV/m	dB/m	dB	dB		cm	deg
1 @	1880.03	125.94	-----	-----	27.42	0.00	2.95	Peak	---	---

**GSM 1900 CH661 Vertical Polarization**



Trace: (Discrete)  
 Site : 03CH06  
 Condition : NULL 3m HF-HORN AH-118 VERTICAL  
 EUT : Tri-band handset  
 Power : 110Vac/60Hz  
 Model : J6  
 Memo : PCS CH661

	Freq	Level	Over	Limit	Antenna	Preamp	Cable	Remark	Ant	Table
	MHz	dBuV/m	dB	dBuV/m	dB/m	dB	dB		cm	deg
1 @	1879.91	125.03	-----	-----	27.42	0.00	2.95	Peak	---	---

GSM 1900 CH810 Horizontal Polarization

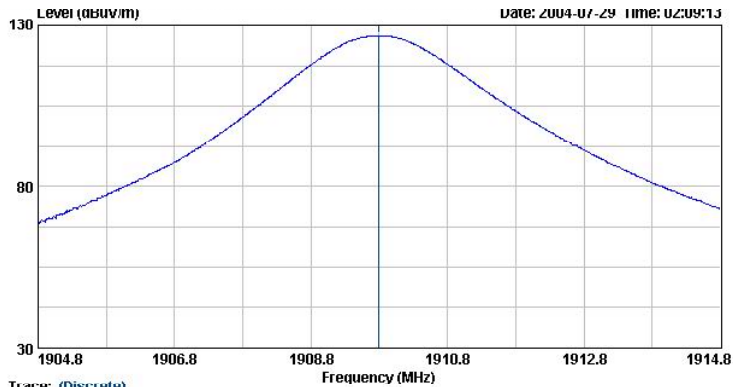

Trace: (Discrete)  
 Site : 03CH06  
 Condition : NULL 3m HF-HORN AH-118 HORIZONTAL  
 EUT : Tri-band handset  
 Power : 110Vac/60Hz  
 Model : J6  
 Memo : PCS CH810

	Freq	Level	Over	Limit	Antenna	Preamp	Cable	Remark	Ant	Table
	MHz	dBuV/m	dB	dBuV/m	dB/m	dB	dB		cm	deg
1 @	1909.80	126.66	-----	-----	27.58	0.00	2.97	Peak	---	---

GSM 1900 CH810 Vertical Polarization

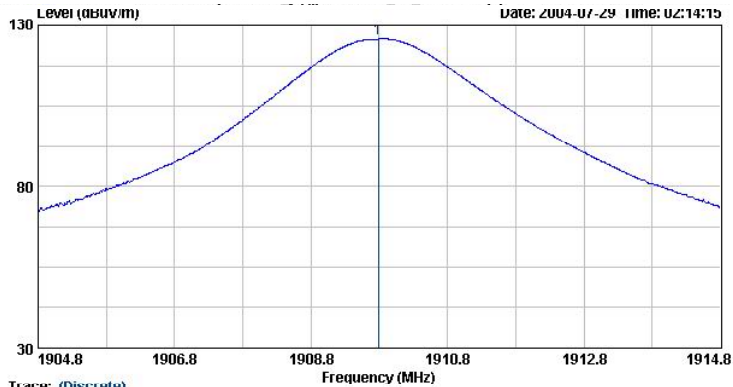

Trace: (Discrete)  
 Site : 03CH06  
 Condition : NULL 3m HF-HORN AH-118 VERTICAL  
 EUT : Tri-band handset  
 Power : 110Vac/60Hz  
 Model : J6  
 Memo : PCS CH810

	Freq	Level	Over	Limit	Antenna	Preamp	Cable	Remark	Ant	Table
	MHz	dBuV/m	dB	dBuV/m	dB/m	dB	dB		cm	deg
1 @	1909.79	125.78	-----	-----	27.58	0.00	2.97	Peak	---	---



**Name of Test:** Transmitter Conducted Measurements

**Specification:** 47 CFR 2.1051: Unwanted (spurious) Emissions  
2.1049(c), 24.238(b): Occupied Bandwidth  
24: Emissions at Band Edges

**Test Equipment:** As per attached page

**Measurement Procedure**

1. The EUT and test equipment were set up as shown on the following page with the Spectrum Analyzer connected.
2. The low and high channels for all RF powers within the transmitting frequency band were measured.
3. Measurement Results: Attached



Tested By:

Tim Kao

**Transmitter Spurious Emission**

Test A. Occupied Bandwidth (In-Band Spurious)

Test B. Out-of-Band Spurious

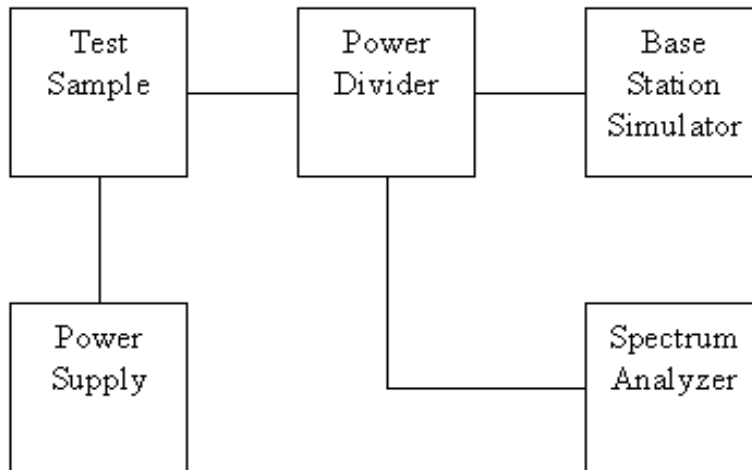

Asset	Model Name	S/N
Base Station Simulator	CMU200	102278
Base Station Simulator	E5515C	GB43460754
Spectrum Analyzer	FSP30	838858/014
AC/DC Power Source	HPA-500W	HPA0100024

Name of Test: Emission Masks (Occupied Bandwidth)  
State 2: High Power

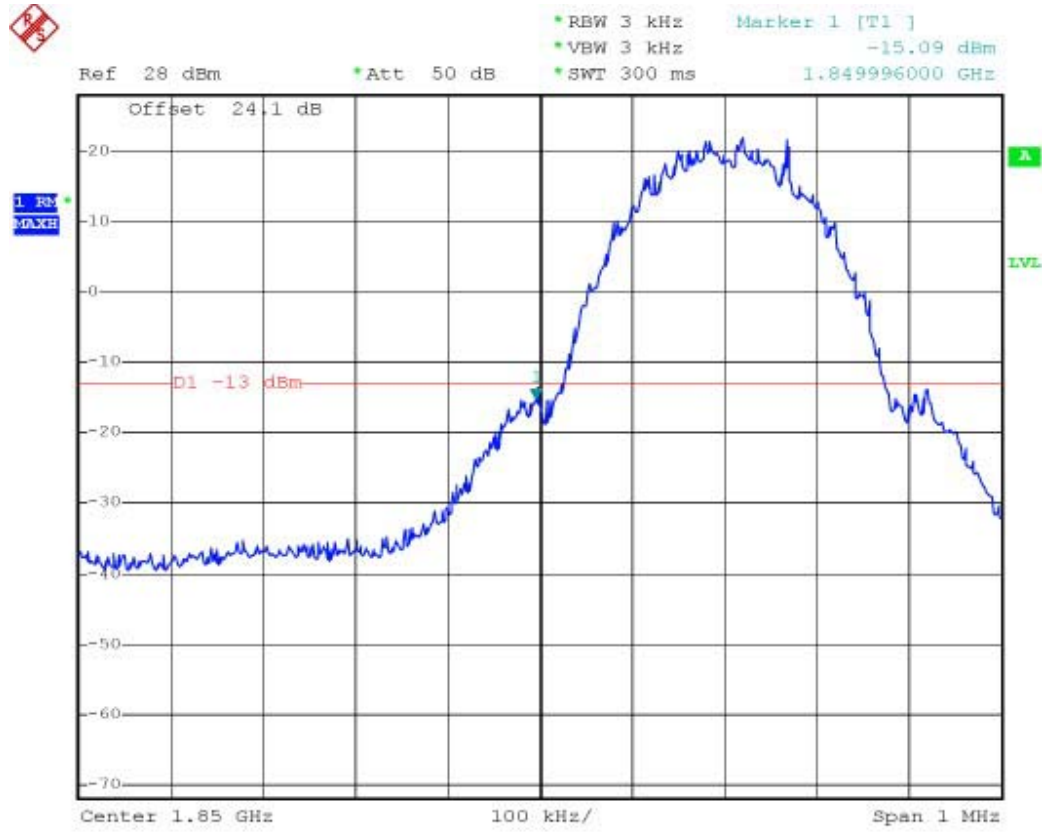

Power: HIGH  
Modulation: GSM 1900  
LOWER BAND EDGE

**Name of Test:** Emission Masks (Occupied Bandwidth)  
 State 1:Low Power

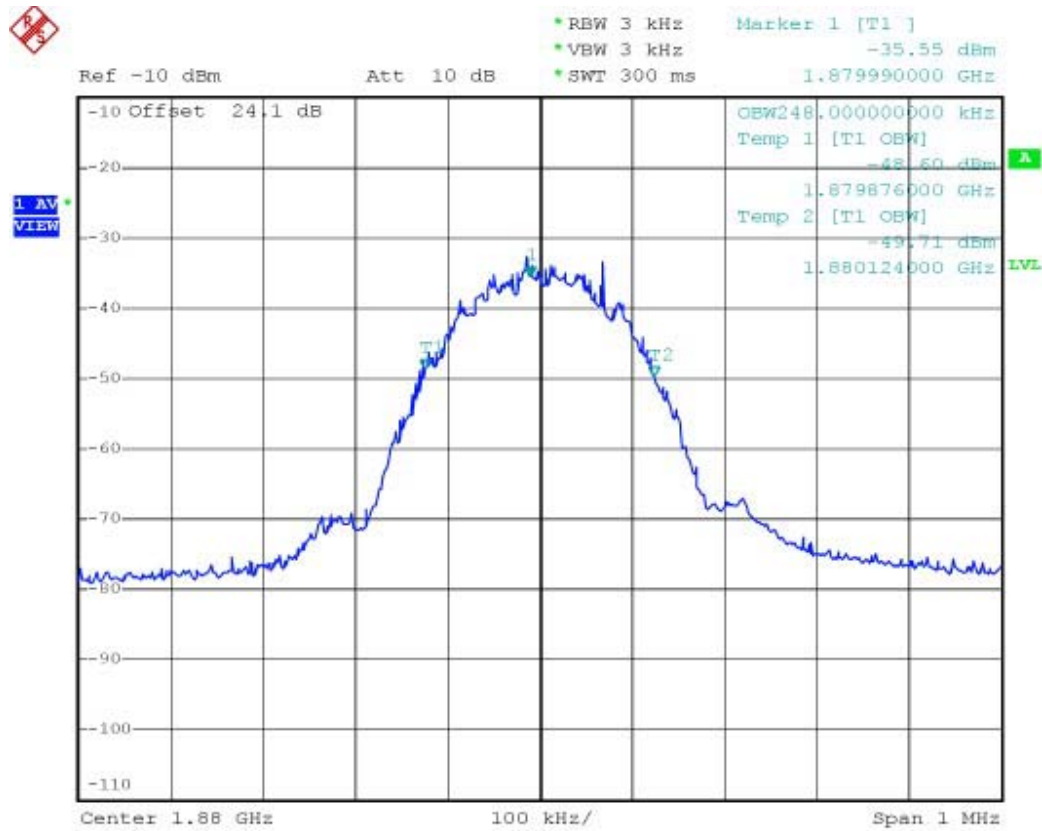

Power: LOW  
 Modulation: GSM 1900  
 99% BANDWIDTH

Name of Test: Emission Masks (Occupied Bandwidth)  
State 2:High Power

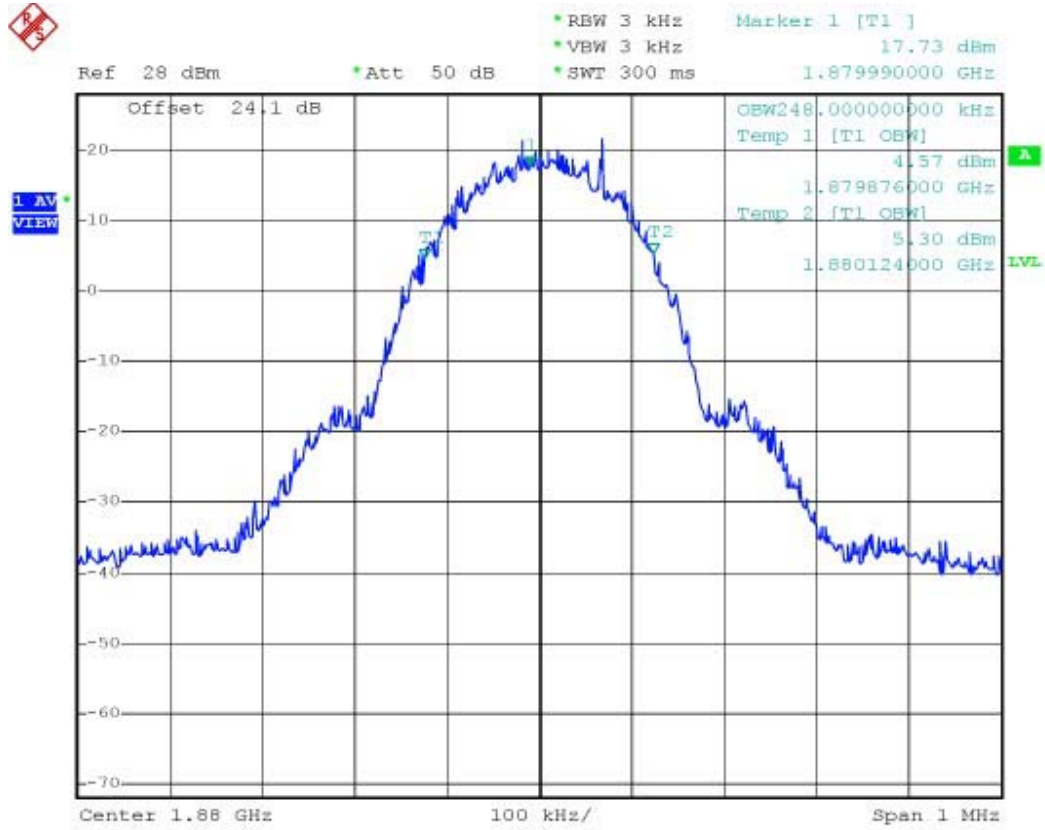

Power: HIGH  
Modulation: GSM 1900  
99% BANDWIDTH

Name of Test: Emission Masks (Occupied Bandwidth)  
State 2:High Power

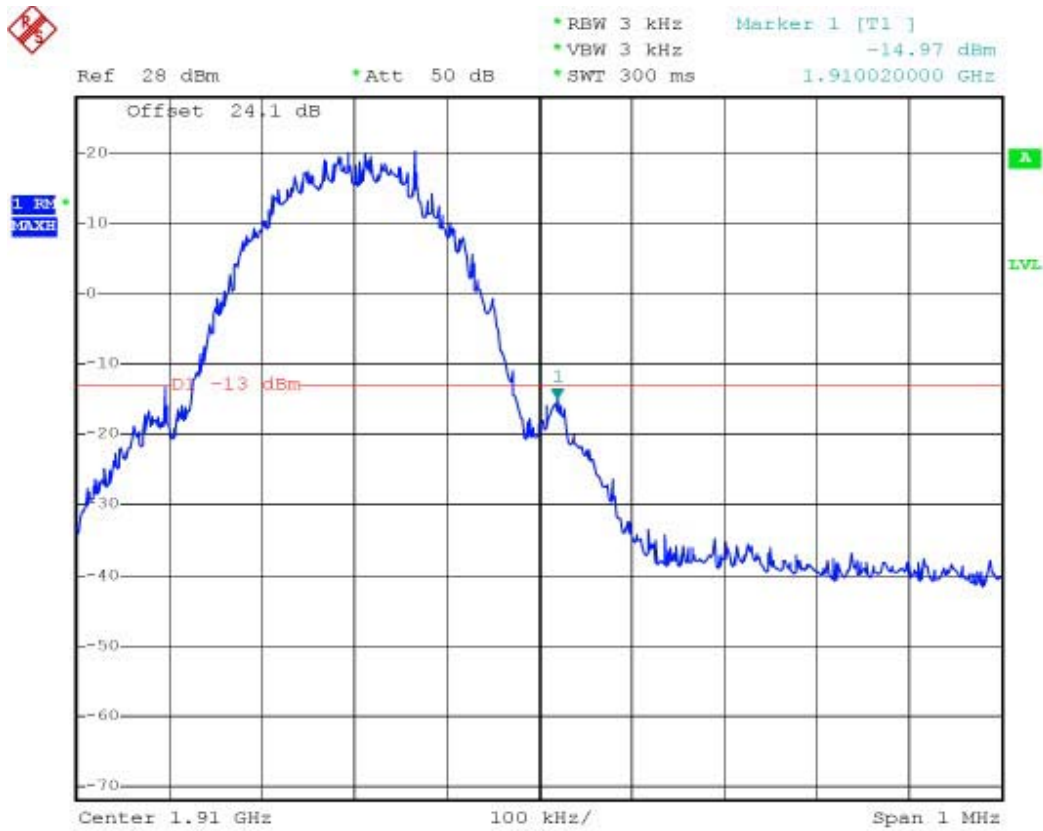

Power: HIGH  
Modulation: GSM 1900  
UPPER BAND EDGE

Name of Test: Conducted Spurious Emission  
30M-1G

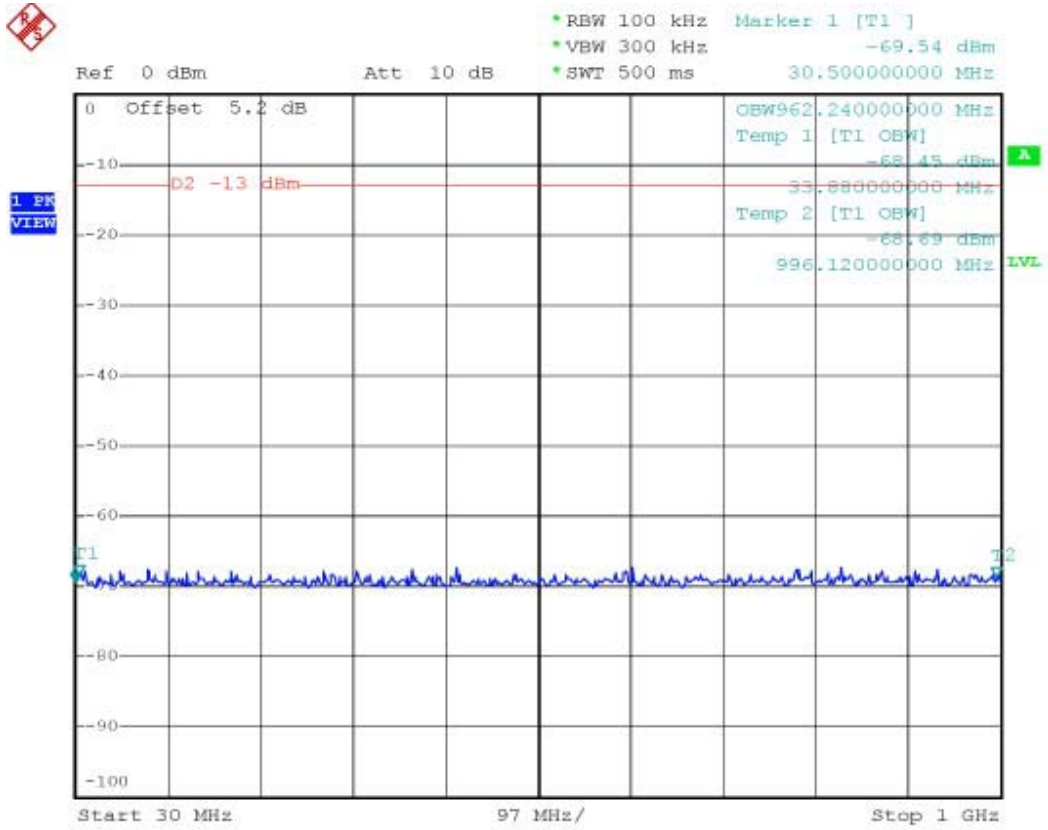

Name of Test: Conducted Spurious Emission  
1G-3G

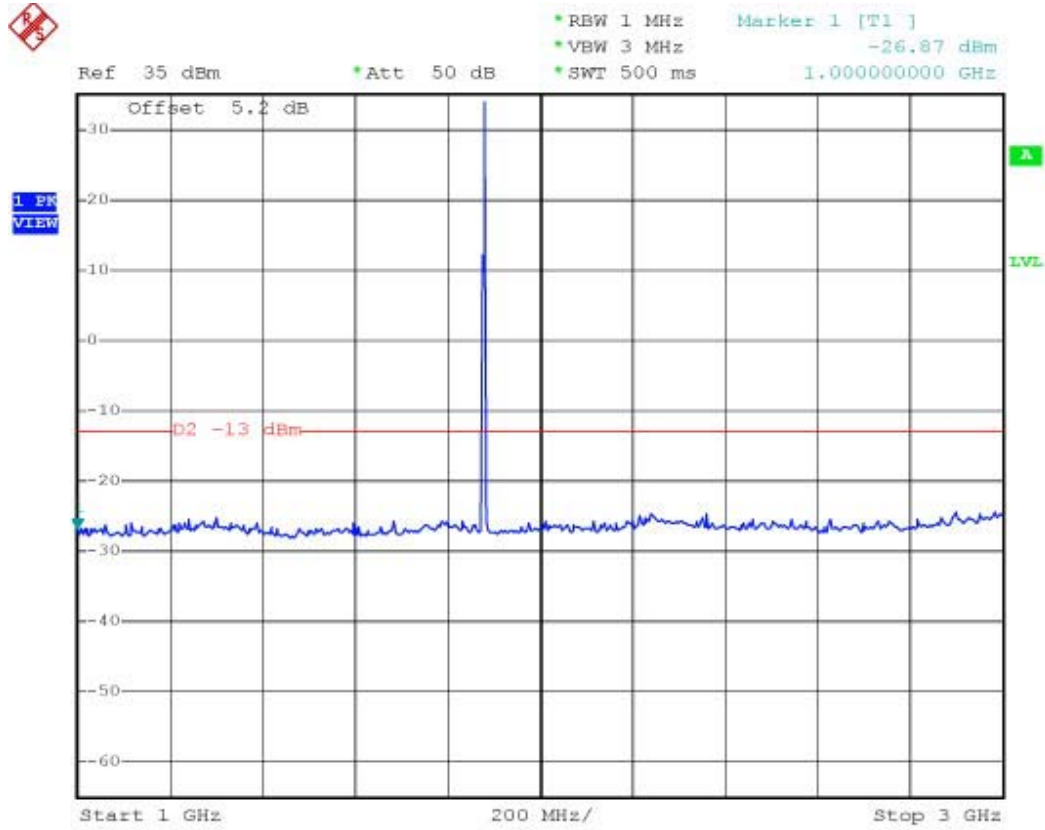



Name of Test: Conducted Spurious Emission  
3G-7G

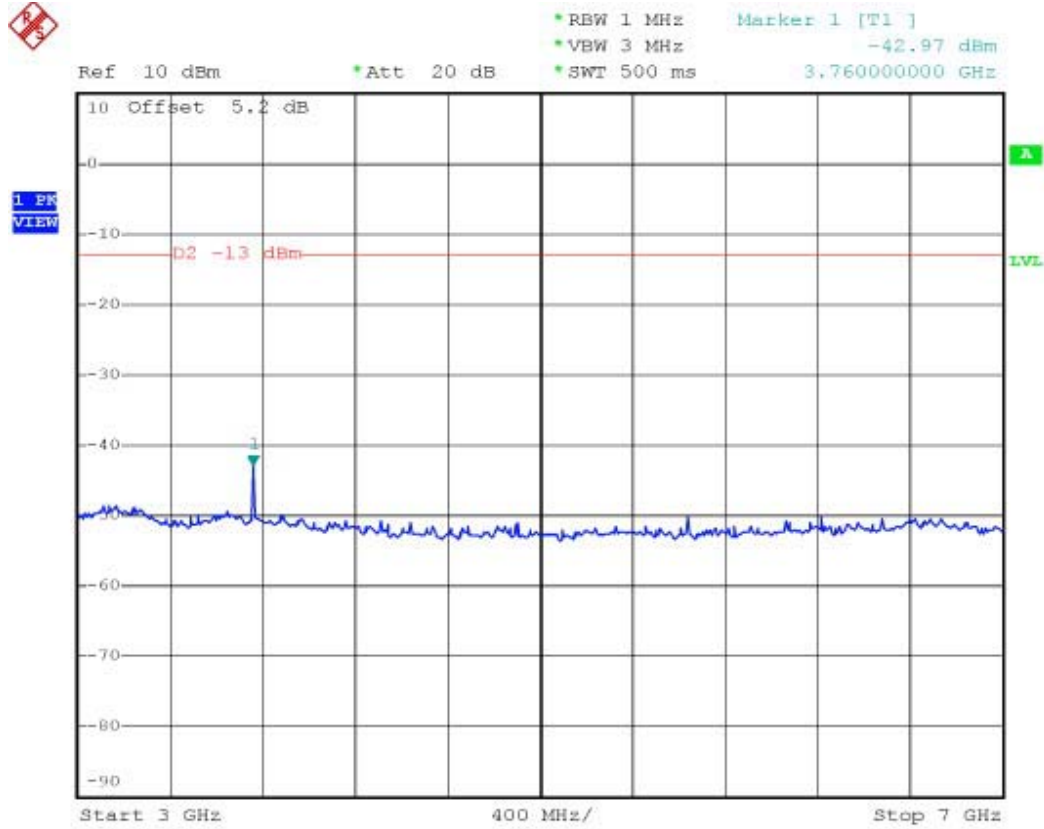

Name of Test: Conducted Spurious Emission  
7G-13G

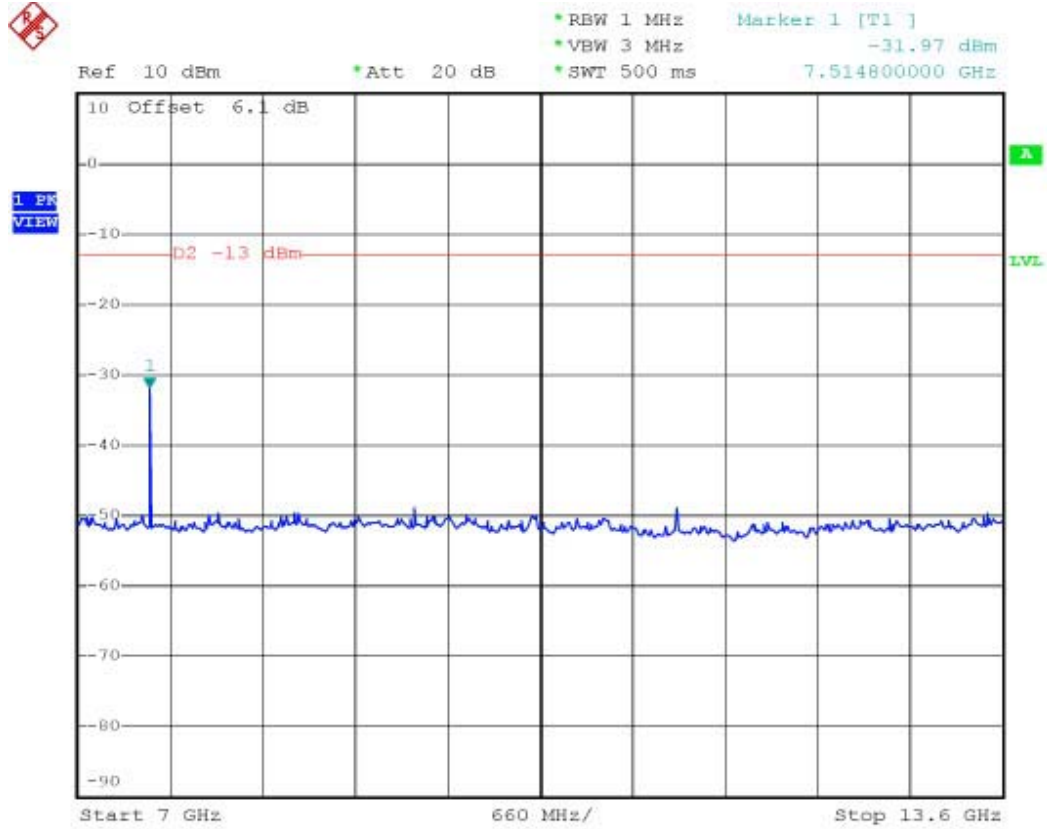

Name of Test: Conducted Spurious Emission  
13G-19G

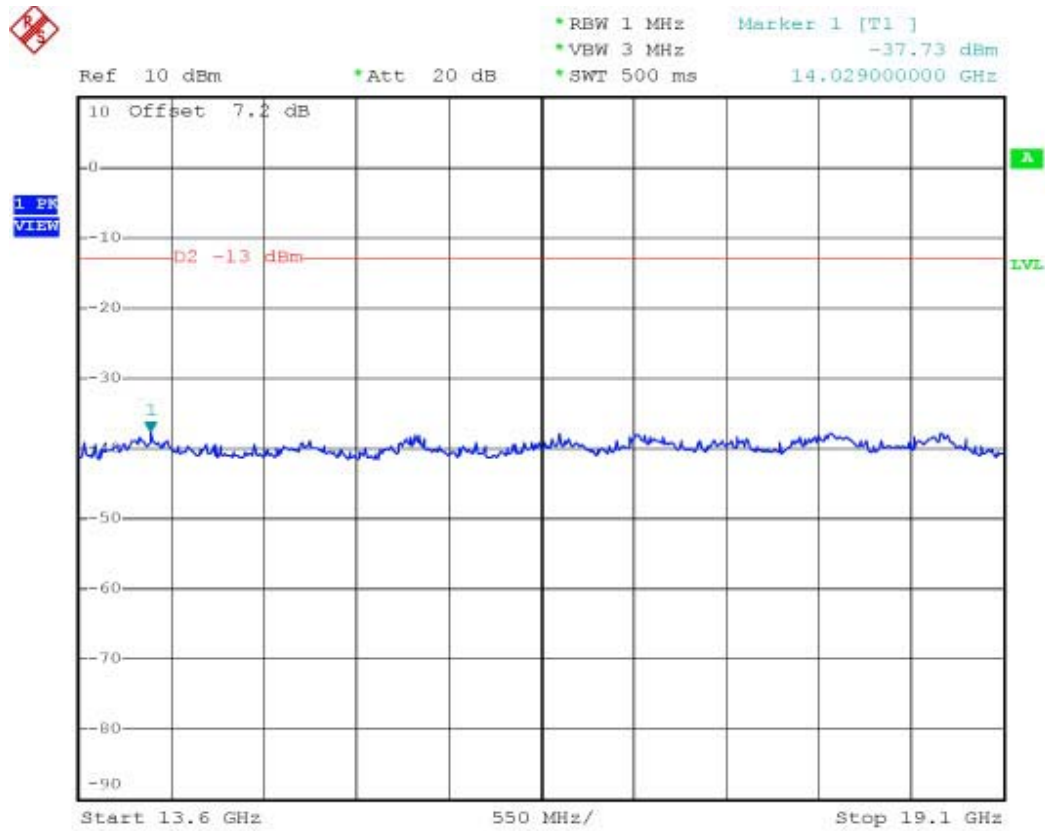

**Name of Test:** Field Strength of Spurious Radiation

**Specification:** 47 CFR 2.1053(a)

**Guide:** ANSI/TIA/EIA-603-1992/2001, Paragraph 1.2.12 and Table 16

**Measurement Procedure**

1.2.12.1 Definition: Radiated spurious emissions are emissions from the equipment when transmitting into a non-radiating load on a frequency or frequencies which are outside an occupied band sufficient to ensure transmission of information of required quality for the class of communications desired.

1.2.12.2 Method of Measurement

A) Connect the equipment as illustrated

- B) Adjust the spectrum analyzer for the following settings:
- 1) Resolution Bandwidth 100 kHz (<1 GHz), 1 MHz (> 1GHz).
  - 2) Video Bandwidth  $\geq$  3 times Resolution Bandwidth
  - 3) Sweep Speed  $\leq$ 2000 Hz/second
  - 4) Detector Mode = Mean or Average Power

C) Place the transmitter to be tested on the turntable in the standard test site. If the antenna is detachable, The transmitter is transmitting into a non-radiating load which is placed on the turntable. The RF cable to this load should be of minimum length.

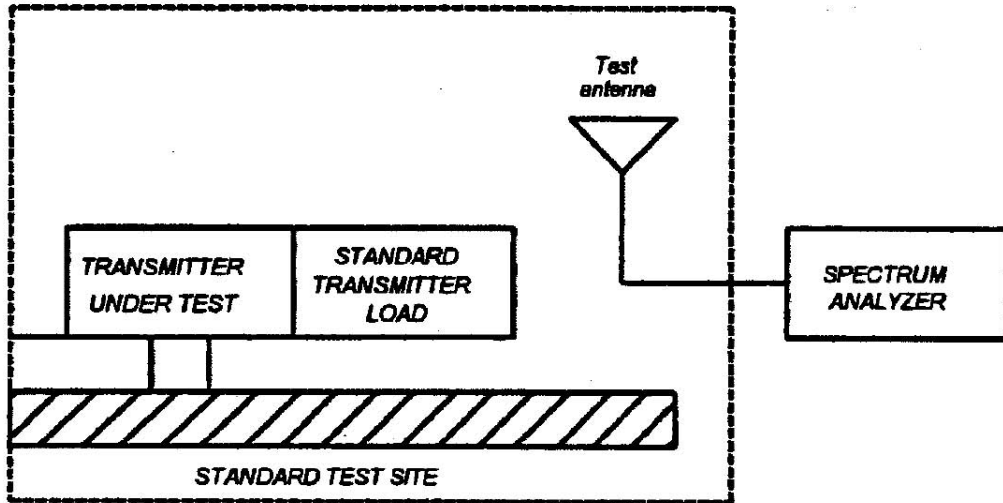

**Name of Test:** Field Strength of Spurious Radiation (Cont.)

- D) For each spurious measurement the test antenna should cover the measured frequency. Measurements shall be made from the lowest radio frequency generated in the equipment to the tenth harmonic of the carrier, except for the region close to the carrier equal to  $\pm$  the test bandwidth (see section 1.3.4.4).
- E) For each spurious frequency, raise and lower the test antenna from 1 m to 4 m to obtain a maximum reading on the spectrum analyzer with the test antenna at horizontal polarity. Repeat this procedure to obtain the highest possible reading. Record this maximum reading.
- F) Repeat step E) for each spurious frequency with the test antenna polarized vertically.

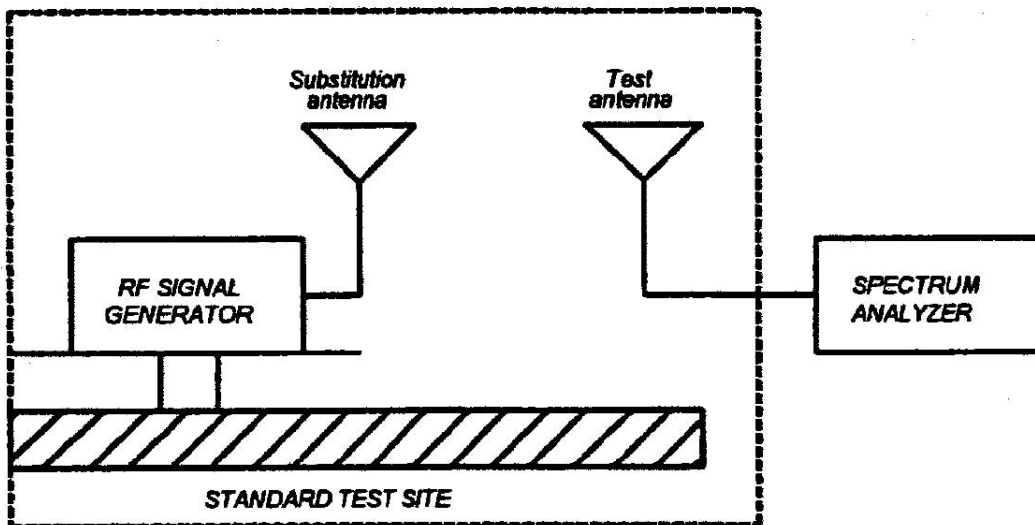

- G) Reconnect the equipment as illustrated.
- H) Keep the spectrum analyzer adjusted as in step B).
- I) Remove the transmitter and replace it with a substitution antenna. The center of the substitution antenna should be approximately at the same location as the center of the transmitter. At lower frequencies, where the substitution antenna is very long, this will be impossible to achieve when the antenna is polarized vertically. In such case the lower end of the antenna should be 0.3 m above the ground.

**Name of Test:** Field Strength of Spurious Radiation (Cont.)

- J) Feed the substitution antenna at the transmitter end with a signal generator connected to the antenna by means of a non-radiating cable. With the antennas at both ends horizontally polarized and with the signal generator tuned to a particular spurious frequency, raise and lower the test antenna to obtain a maximum reading at the spectrum analyzer. Adjust the level of the signal generator output until the previously recorded maximum reading for this set of conditions is obtained. This should be done carefully repeating the adjustment of the test antenna and generator output.
- K) Repeat step J) with both antennas vertically polarized for each spurious frequency.
- L) Calculate power in dBm into a reference ideal half-wave dipole antenna by reducing the readings obtained in steps J) and K) by the power loss in the cable between the generator and the antenna and further corrected for the gain of the substitution antenna used relative to an ideal half-wave dipole antenna.

NOTE: It is permissible that other antennas provided can be referenced to a dipole.



Tested By:

Tim Kao

**FCC TEST REPORT**

Report No. : F462913

**Name of Test:** Field Strength of Spurious Radiation  
GSM 1900 (Channel 661)

Freq MHz	Pol	Substitution Antenna Input Power (dBm)	Substitution Antenna Gain (dBi)	Et (dBuV/m)	Es (dBuV/m)	Et - Es (dB)	EIRP (dBm)	Limit (dBm)	Margin (dB)
700.27	H	-2.35	1.41	36.86	94.90	-58.04	-58.98	-13.0	-45.98
901.06	H	-2.67	0.99	35.46	92.95	-57.49	-59.17	-13.0	-46.17
935.98	H	-2.64	0.79	35.32	93.00	-57.68	-59.53	-13.0	-46.53
1012.00	H	-2.67	4.45	44.30	97.69	-53.39	-51.60	-13.0	-38.60
1436.00	H	-3.34	6.23	43.33	101.78	-58.45	-55.56	-13.0	-42.56
1534.00	H	-3.47	6.51	43.66	102.33	-58.67	-55.63	-13.0	-42.63
3760.00	H	-5.26	7.45	50.30	99.06	-48.76	-46.57	-13.0	-33.57
5636.00	H	-6.67	7.44	55.75	98.78	-43.03	-42.27	-13.0	-29.27
7514.80	H	-8.44	6.51	62.94	94.66	-31.72	-33.65	-13.0	-20.65
11270.20	H	-11.57	9.15	57.91	94.50	-36.59	-39.01	-13.0	-26.01
700.27	V	-2.35	1.41	37.47	94.90	-57.43	-58.37	-13.0	-45.37
858.38	V	-2.48	0.75	31.37	94.15	-62.78	-64.51	-13.0	-51.51
882.63	V	-2.54	0.89	33.35	93.83	-60.48	-62.13	-13.0	-49.13
901.06	V	-2.67	0.99	35.80	92.95	-57.15	-58.83	-13.0	-45.83
1758.00	V	-3.67	6.60	47.13	101.88	-54.75	-51.82	-13.0	-38.82
1998.00	V	-3.89	6.70	42.78	101.40	-58.62	-55.81	-13.0	-42.81
3760.00	V	-5.26	7.45	53.01	99.06	-46.05	-43.86	-13.0	-30.86
5636.00	V	-6.67	7.44	51.43	98.78	-47.35	-46.59	-13.0	-33.59
7514.80	V	-8.44	6.51	67.61	94.66	-27.05	-28.98	-13.0	-15.98
11270.20	V	-11.57	9.15	55.56	94.50	-38.94	-41.36	-13.0	-28.36

Radiated Scanned Data

GSM1900, Horizontal Polarization

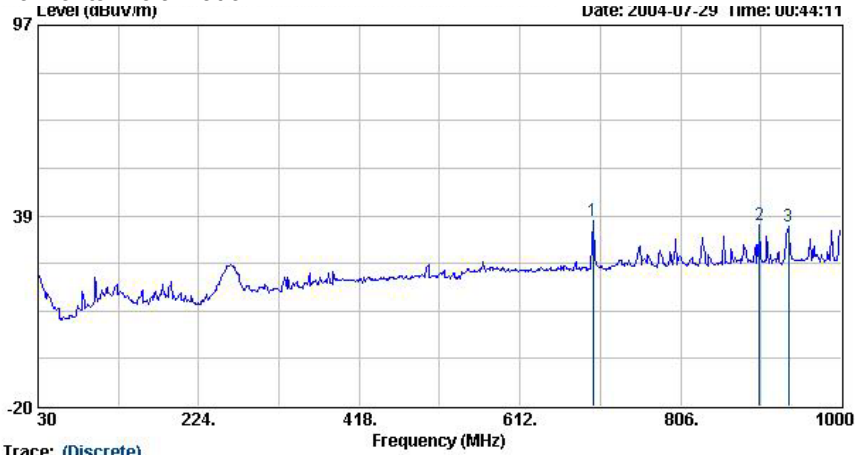

Trace: (Discrete)

Site : 03CH06  
 Condition : NULL 3m BI LOG 2004 0629 HORIZONTAL  
 EUT : Tri-band Handset  
 Power : 110 Vac / 60 Hz  
 Model : J6  
 Memo : PCS CH661 Link

	Freq	Level	Over Limit	Limit	Antenna Line	Preamp Factor	Cable Loss	Remark	Ant Pos	Table Pos
	MHz	dBuV/m	dB	dBuV/m	dB/m	dB	dB		cm	deg
1	700.27	36.86	-----	-----	19.10	31.45	2.57	Peak	---	---
2	901.06	35.46	-----	-----	20.60	30.76	2.95	Peak	---	---
3	935.98	35.32	-----	-----	20.77	31.04	3.09	Peak	---	---



**FCC TEST REPORT**

**Report No. : F462913**

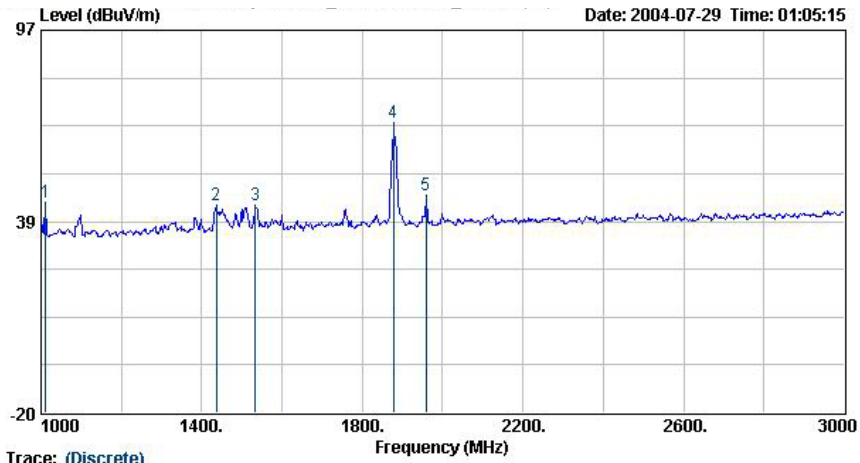

Trace: (Discrete)

Site : 03CH06  
 Condition : NULL 3m HF-HORN AH-118 HORIZONTAL  
 EUT : Tri-band Handset  
 Power : 110 Vac / 60 Hz  
 Model : J6  
 Memo : PCS CH661 Link

	Freq	Level	Over	Limit	Antenna	Preamp	Cable	Remark	Ant	Table
	MHz	dBuV/m	dB	dBuV/m	dB/m	dB	dB		cm	deg
1	1012.00	44.30	-----	-----	24.05	43.52	2.11	Peak	---	---
2	1436.00	43.33	-----	-----	25.34	44.04	2.58	Peak	---	---
3	1534.00	43.66	-----	-----	25.67	44.13	2.65	Peak	---	---
4 @	1878.00	68.84	-----	-----	27.42	44.41	2.95	Peak	---	---
5	1958.00	46.38	-----	-----	27.75	44.46	3.00	Peak	---	---

Remark: #5 BCCH from CMU200

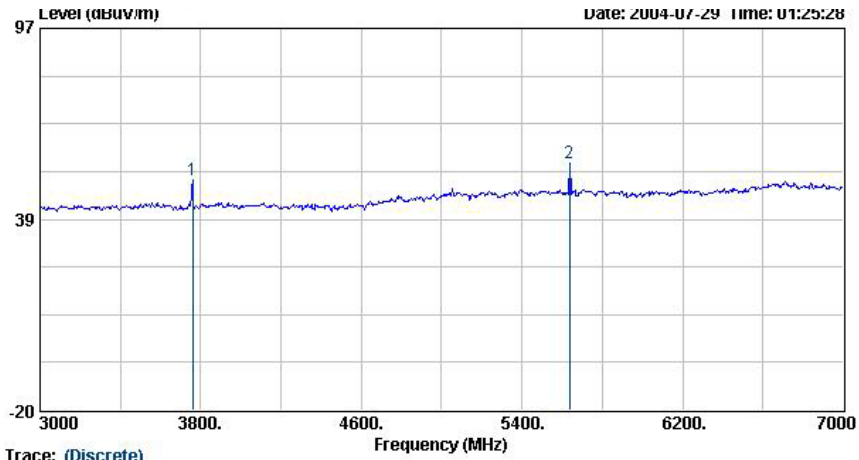

Site : 03CH06  
 Condition : NULL 3m HF-HORN AH-118 HORIZONTAL  
 EUT : Tri-band Handset  
 Power : 110 Vac / 60 Hz  
 Model : J6  
 Memo : PCS CH661 Link

	Freq	Level	Over Limit	Limit	Antenna Line	Preamp Factor	Cable Loss	Remark	Ant Pos	Table Pos
	MHz	dBuV/m	dB	dBuV/m	dB/m	dB	dB		cm	deg
1	3760.00	50.30	-----	-----	30.26	44.76	4.21	Peak	---	---
2 @	5636.00	55.75	-----	-----	34.01	46.54	5.34	Peak	---	---

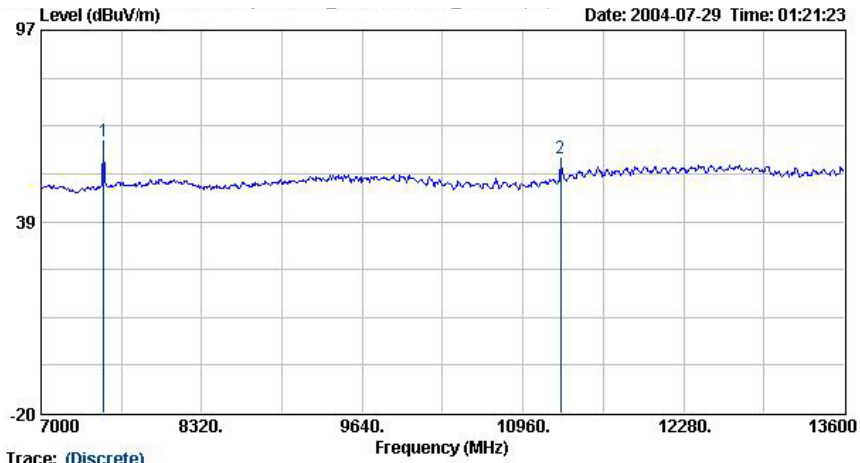

Trace: (Discrete)  
 Site : 03CH06  
 Condition : NULL 3m HF-HORN AH-118 HORIZONTAL  
 EUT : Tri-band Handset  
 Power : 110 Vac / 60 Hz  
 Model : J6  
 Memo : PCS CH661 Link

	Freq	Level	Over	Limit	Antenna	Preamo	Cable	Remark	Ant	Table
	MHz	dBuV/m	dB	dBuV/m	dB/m	dB	dB		cm	deg
1 @	7514.80	62.94	-----	-----	36.03	46.19	6.17	Peak	---	---
2 @	11270.20	57.91	-----	-----	38.37	44.00	7.82	Peak	---	---

➤ Mark:  
 Frequency from 13600MHz to 19000MHz, the emission emitted by the EUT is too low to be measured.

**FCC TEST REPORT**

Report No. : F462913

GSM1900, Vertical Polarization

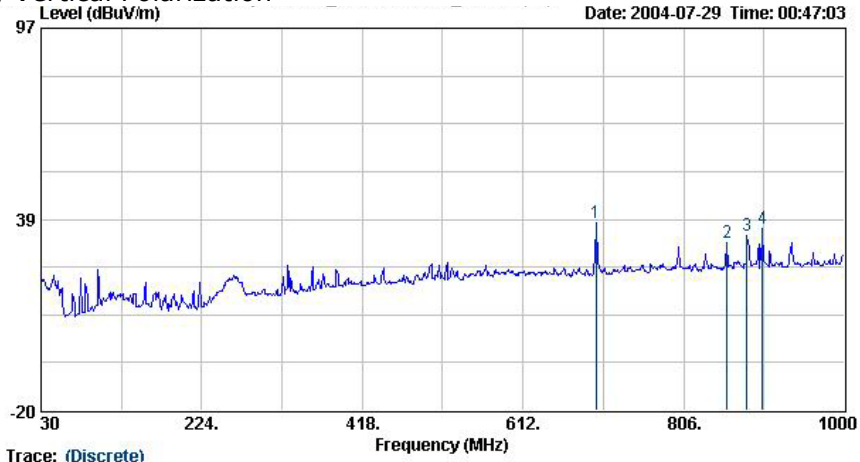

Trace: (Discrete)  
 Site : 03CH06  
 Condition : NULL 3m BI LOG 2004 0629 VERTICAL  
 EUT : Tri-band Handset  
 Power : 110 Vac / 60 Hz  
 Model : J6  
 Memo : PCS CH661 Link

	Freq	Level	Over	Limit	Antenna	Preamp	Cable	Remark	Ant	Table
	MHz	dBuV/m	dB	dBuV/m	dB/m	dB	dB		cm	deg
1	700.27	37.47	-----	-----	19.10	31.45	2.57	Peak	---	---
2	858.38	31.37	-----	-----	20.43	31.63	3.03	Peak	---	---
3	882.63	33.35	-----	-----	20.53	30.99	2.98	Peak	---	---
4	901.06	35.80	-----	-----	20.60	30.76	2.95	Peak	---	---

**FCC TEST REPORT**

**Report No. : F462913**

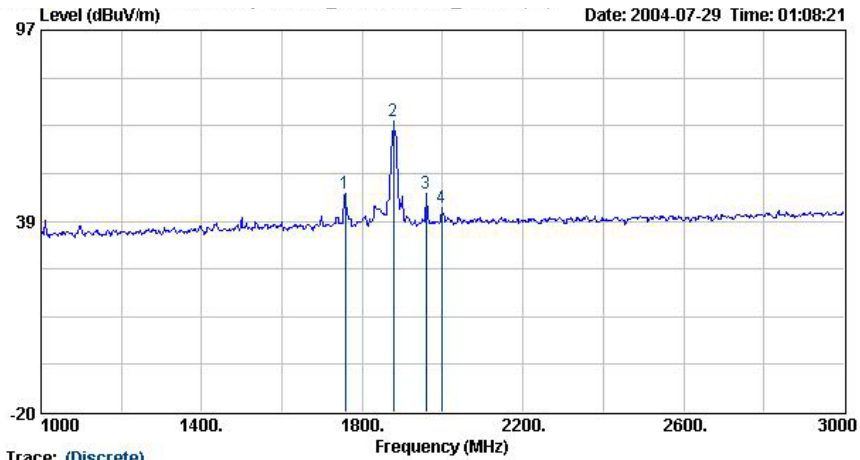

Trace: (Discrete)  
 Site : 03CH06  
 Condition : NULL 3m HF-HORN AH-118 VERTICAL  
 EUT : Tri-band Handset  
 Power : 110 Vac / 60 Hz  
 Model : J6  
 Memo : PCS CH661 Link

	Freq	Level	Over	Limit	Antenna	Preamp	Cable	Remark	Ant	Table
	MHz	dBuV/m	dB	dBuV/m	dB/m	dB	dB		cm	deg
1	1758.00	47.13	-----	-----	26.83	44.31	2.85	Peak	---	---
2 @	1878.00	69.01	-----	-----	27.42	44.41	2.95	Peak	---	---
3	1958.00	47.13	-----	-----	27.75	44.46	3.00	Peak	---	---
4	1998.00	42.78	-----	-----	28.00	44.50	3.04	Peak	---	---

Remark: #3 BCCH from CMU200

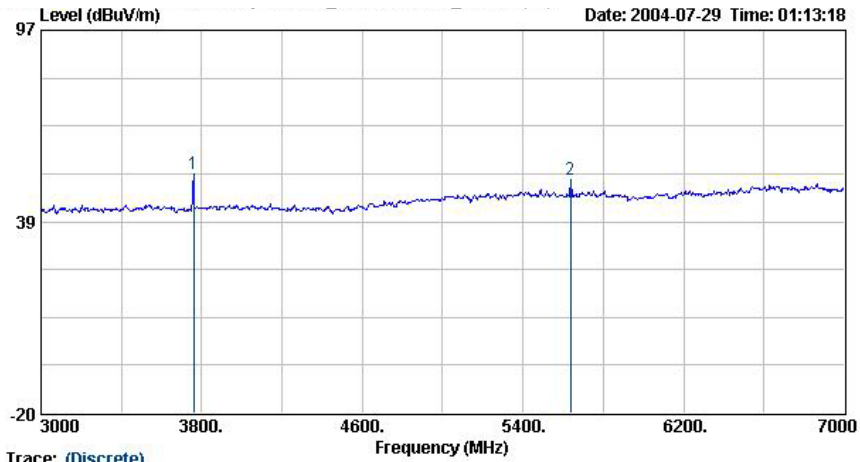

Trace: (Discrete)  
 Site : 03CH06  
 Condition : NULL 3m HF-HORN AH-118 VERTICAL  
 EUT : Tri-band Handset  
 Power : 110 Vac / 60 Hz  
 Model : J6  
 Memo : PCS CH661 Link

	Freq	Level	Over	Limit	Antenna	Preamp	Cable	Remark	Ant	Table
	MHz	dBuV/m	dB	dBuV/m	dB/m	dB	dB		cm	deg
1	3760.00	53.01	-----	-----	30.26	44.76	4.21	Peak	---	---
2	5636.00	51.43	-----	-----	34.01	46.54	5.34	Peak	---	---

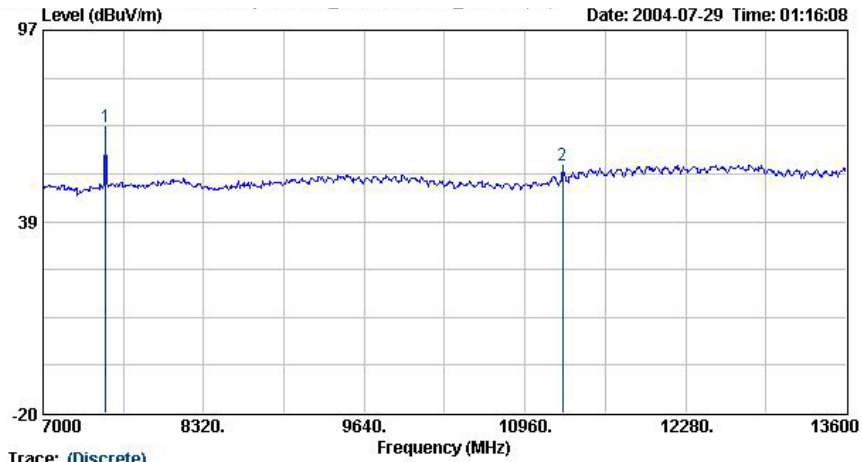

Trace: (Discrete)  
 Site : 03CH06  
 Condition : NULL 3m HF-HORN AH-118 VERTICAL  
 EUT : Tri-band Handset  
 Power : 110 Vac / 60 Hz  
 Model : J6  
 Memo : PCS CH661 Link

	Freq	Level	Over	Limit	Antenna	Preamp	Cable	Remark	Ant	Table
	MHz	dBuV/m	dB	dBuV/m	dB/m	dB	dB		cm	deg
1 @	7514.80	67.61	-----	-----	36.03	46.19	6.17	Peak	---	---
2	11270.20	55.56	-----	-----	38.37	44.00	7.82	Peak	---	---

- Mark:  
 Frequency from 13600MHz to 19000MHz, the emission emitted by the EUT is too low to be measured.

**Name of Test:** Frequency Stability (Temperature Variation)

**Specification:** 47 CFR 2.1055(a)(1)

**Test Conditions:** As Indicated

**Test Equipment:** As per previous page

#### **Measurement Procedure**

1. The EUT and test equipment were set up as shown on the following page.
2. With all power removed, the temperature was decreased to  $-30^{\circ}\text{C}$  and permitted to stabilize for three hours. Power was applied and the maximum change in frequency was noted within one minute.
3. With power OFF, the temperature was raised in  $10^{\circ}\text{C}$  steps. The sample was permitted to stabilize at each step for at least one-half hour. Power was applied and the maximum frequency change was noted within one minute.
4. The temperature tests were performed for the worst case.
5. Measurement Results: Attached



Tested By:

Tim Kao



**Transmitter Test Set-Up**

Frequency Stability: Temperature Variation  
Frequency Stability: Voltage Variation

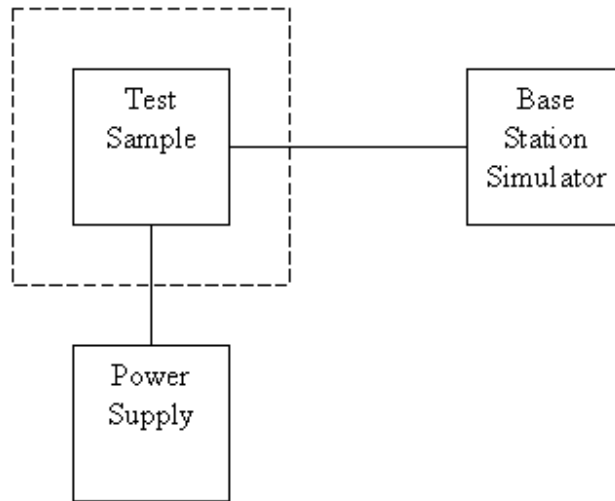

Asset	Model Name	S/N
Temperature & Humidity Controller	P-9000	612
AC/DC Power Source	HPA-500W	HPA0100024
Base Station Simulator	CMU200	102278
Base Station Simulator	E5515C	GB43460754

**Name of Test:** Frequency Stability (Temperature Variation)

GSM 1900 (Channel 661)

Temperature(°C)	Change, Hz	Change, ppm
-30	163	0.09
-20	138	0.07
-10	97	0.05
0	56	0.03
10	57	0.03
20	54	0.03
30	62	0.03
40	-48	-0.03
50	-68	-0.04

**Name of Test:** Frequency Stability (Voltage Variation)

**Specification:** 47 CFR 2.1055 (b)(1)

**Test Equipment:** As per previous page

**Measurement Procedure**

1. The EUT was placed in a temperature chamber at 25±5°C and connected as for "Frequency Stability - Temperature Variation" test.
2. The power supply voltage to the EUT was varied from 85% to 115% of the nominal value measured at the input to the EUT.
3. The variation in frequency was measured for the worst case.

**Results:** Frequency Stability (Voltage Variation)

GSM1900 (Channel 661)

Nominal Value (Voltage) = 3.6

Battery End Point (Voltage) = 3.25

Voltage(Volt)	Change, Hz	Change, ppm
3.7	56	0.03
BEP	78	0.04
4.3	97	0.05

Limit: Must remain within authorized frequency block.



Tested By:

Tim Kao

**Antenna Factor & Cable Loss**

Frequency (MHz)	Antenna Factor (dB)	Cable Loss (dB)	Frequency (MHz)	Antenna Factor (dB)	Cable Loss (dB)
30	15.35	4.50	1000	24.10	3.92
35	13.63	1.13	2000	27.40	5.66
40	11.11	1.18	3000	30.00	7.20
45	10.59	1.26	4000	32.60	9.36
50	6.47	1.31	5000	33.40	9.16
55	5.83	1.34	6000	34.20	10.70
60	5.18	1.43	7000	35.30	12.16
65	4.81	1.52	8000	36.90	13.12
70	4.43	1.56	9000	38.10	13.81
75	5.10	1.57	10000	39.00	14.83
80	5.91	1.60	11000	38.60	15.83
85	7.33	1.66	12000	39.50	17.11
90	8.74	1.75	13000	39.30	17.62
95	9.05	1.76	14000	41.60	18.37
100	9.36	1.83	15000	40.60	19.10
110	9.65	1.86	16000	37.20	19.72
120	9.97	1.92	17000	40.20	21.98
130	10.51	2.00	18000	48.90	21.22
140	10.32	2.11	19000	37.60	23.90
150	9.42	2.18	20000	37.30	24.07
160	8.09	2.22	21000	37.00	25.49
170	7.43	2.26	22000	38.00	24.92
180	7.60	2.31	23000	38.70	25.60
190	7.43	2.37	24000	38.60	25.70
200	7.26	2.43	25000	24.10	3.92
220	9.11	2.56	14000	27.40	5.66
240	10.88	2.70	15000	30.00	7.20
260	11.75	2.83	16000	32.60	9.36
280	11.55	2.93	17000	33.40	9.16
300	11.36	3.03	18000	34.20	10.70
320	12.03	3.13	19000	35.30	12.16
340	12.69	3.23	20000	36.90	13.12
360	13.33	3.32	21000	38.10	13.81
380	14.00	3.41	22000	39.00	14.83
400	14.63	3.48	23000	38.60	15.83
450	15.33	3.71	24000	39.50	17.11
500	16.03	3.85	25000	39.30	17.62
550	16.65	4.03			
600	17.29	4.32			
650	17.64	4.51			
700	18.00	4.54			
750	18.39	4.90			
800	18.79	5.04			
850	19.10	5.04			
900	19.42	5.20			
950	19.58	5.28			
1000	19.75	5.58			

**List of Measuring Equipments**

Instrument	Manufacturer	Model No.	Serial No.	Characteristics	Calibration Date	Remark
Spectrum analyzer	R&S	FSP40	100057	9KHz-40GHz	Feb. 26, 2004	Radiation (03CH06-HY)
Bilog Antenna	SCHAFFNER	CBL6112B	2885	30MHz -2GHz	Dec. 18, 2003	Radiation (03CH06-HY)
Horn Antenna	Com-Power	AH118	071025	1G-18G	Feb. 11, 2004	Radiation (03CH06-HY)
PreAmplifier	Com-Power	PA-103	161055	1MHz - 1000MHz	Apr. 26, 2004	Radiation (03CH06-HY)
HF Amplifier	MITEQ	AFS44	973248	0.1G - 26.5G	May. 20, 2004	Radiation (03CH06-HY)

- ※ Calibration Interval of instruments listed above is one year, except for Horn Antenna, BBHA9170.
- ※ Calibration Interval of Horn Antenna, BBHA9170, is three years.

**Uncertainty of Test Site**

Uncertainty of Radiated Emission Measurement (30MHz ~ 1000MHz) (03CH03)

Contribution	Uncertainty of $x_i$		$u(x_i)$
	dB	Probability Distribution	
Receiver reading	0.41	Normal(k=2)	0.21
Antenna factor calibration	0.83	Normal(k=2)	0.42
Cable loss calibration	0.25	Normal(k=2)	0.13
Pre Amplifier Gain calibration	0.27	Normal(k=2)	0.14
RCV/SPA specification	2.50	Rectangular	0.72
Antenna Factor Interpolation for Frequency	1.00	Rectangular	0.29
Site imperfection	1.43	Rectangular	0.83
Mismatch Receiver VSWR $\Gamma_1 = 0.20$ Antenna VSWR $\Gamma_2 = 0.23$ Uncertainty = $20\log(1-\Gamma_1*\Gamma_2)$	+0.39/-0.41	U-shaped	0.28
<b>combined standard uncertainty Uc(y)</b>	<b>1.27</b>		
<b>Measuring uncertainty for a level of confidence of 95% U=2Uc(y)</b>	<b>2.54</b>		

Uncertainty of Radiated Emission Measurement (1GHz ~ 40GHz)

Contribution	Uncertainty of $x_i$		$u(x_i)$	$C_i$	$C_i * u(x_i)$
	dB	Probability Distribution			
Receiver reading	±0.10	Normal(k=1)	0.10	1	0.10
Antenna factor calibration	±1.70	Normal(k=2)	0.85	1	0.85
Cable loss calibration	±0.50	Normal(k=2)	0.25	1	0.25
Receiver Correction	±2.00	Rectangular	1.15	1	1.15
Antenna Factor Directional	±1.50	Rectangular	0.87	1	0.87
Site imperfection	±2.80	Triangular	1.14	1	1.14
Mismatch Receiver VSWR $\Gamma_1 = 0.197$ Antenna VSWR $\Gamma_2 = 0.194$ Uncertainty = $20\log(1-\Gamma_1*\Gamma_2*\Gamma_3)$	+0.34/-0.35	U-shaped	0.244	1	0.244
<b>Combined standard uncertainty Uc(y)</b>	<b>2.36</b>				
<b>Measuring uncertainty for a level of confidence of 95% U=2Ue(y)</b>	<b>4.72</b>				

$U = \sqrt{\{(1/2)^2 + (0.3/2)^2 + (2^2 + 0.5^2 + 2^2 + 0.25^2 + 2^2)/3 + (0.54)^2/2\}} = 2.2$  for 10m test distance

$U = \sqrt{\{(1/2)^2 + (0.3/2)^2 + (2^2 + 3^2 + 2^2 + 0.25^2 + 2^2)/3 + (0.54)^2/2\}} = 2.7$  for 3m test distance

END OF TEST REPORT