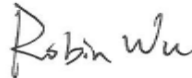

MEASUREMENT REPORT

FCC PART 15.247/ IC RSS-247

FCC ID: BRWSR6100AT
IC: 6157A-SR6100AT
Applicant: Horizon Hobby, LLC
Application Type: Certification
Product: Receiver
Model No.: SR6100AT, SR6110AT
Brand Name: Spektrum
FCC Classification: Digital Transmission System (DTS)
FCC Rule Part(s): Part 15 Subpart C (Section 15.247)
IC Rule(s): RSS-247 Issue 2, RSS-GEN Issue 5
Test Procedure(s): ANSI C63.10-2013, KDB 558074 D01v05r02
Test Date: September 05 ~ 19, 2019

Reviewed By: 
(Sunny Sun)

Approved By: 
(Robin Wu)



The test results relate only to the samples tested.

This equipment has been shown to be capable of compliance with the applicable technical standards as indicated in the measurement report and was tested in accordance with the measurement procedures specified in ANSI C63.10-2013. Test results reported herein relate only to the item(s) tested.

The test report shall not be reproduced except in full without the written approval of MRT Technology (Suzhou) Co., Ltd.

Revision History

Report No.	Version	Description	Issue Date	Note
1909RSU007-U1	Rev. 01	Initial Report	11-07-2019	Valid

Note: This report is prepared for FCC Class II permissive change and supplement to MRT Original “1904RSU005-U1” report changing antenna length, others are same as original. We reassessed the output power, radiated spurious emission and band edge again.

CONTENTS

Description	Page
1. INTRODUCTION	6
1.1. Scope.....	6
1.2. MRT Test Location.....	6
2. PRODUCT INFORMATION	7
2.1. Feature of Equipment under Test	7
2.2. Working Frequencies	7
2.3. Test Mode	7
2.4. Device Capabilities	8
2.5. Test Configuration.....	8
2.6. EMI Suppression Device(s)/Modifications.....	8
2.7. Labeling Requirements	9
3. DESCRIPTION of TEST	10
3.1. Evaluation Procedure.....	10
3.2. AC Line Conducted Emissions	10
3.3. Radiated Emissions	11
4. ANTENNA REQUIREMENTS	12
5. TEST EQUIPMENT CALIBRATION DATE	13
6. MEASUREMENT UNCERTAINTY	15
7. TEST RESULT	16
7.1. Summary.....	16
7.2. Output Power Measurement	17
7.2.1. Test Limit.....	17
7.2.2. Test Procedure Used.....	17
7.2.3. Test Setting	17
7.2.4. Test Setup	17
7.2.5. Test Result	18
7.3. Radiated Spurious Emission Measurement	19
7.3.1. Test Limit.....	19
7.3.2. Test Procedure Used.....	19
7.3.3. Test Setting	19
7.3.4. Test Setup	21
7.3.5. Test Result	22
7.4. Radiated Restricted Band Edge Measurement.....	27

7.4.1.	Test Limit	27
7.4.2.	Test Procedure Used.....	30
7.4.3.	Test Setting	30
7.4.4.	Test Setup	31
7.4.5.	Test Result	32
7.5.	AC Conducted Emissions Measurement	36
7.5.1.	Test Limit	36
7.5.2.	Test Setup	36
7.5.3.	Test Result	36
8.	CONCLUSION	37
	Appendix A - Test Setup Photograph	38
	Appendix B - EUT Photograph	39

§2.1033 General Information

Applicant:	Horizon Hobby, LLC
Applicant Address:	2904 Research Rd. Champaign, IL 61822
Manufacturer:	Horizon Hobby, LLC
Manufacturer Address:	2904 Research Rd. Champaign, IL 61822
Test Site:	MRT Technology (Suzhou) Co., Ltd
Test Site Address:	D8 Building, No.2 Tian'edang Rd., Wuzhong Economic Development Zone, Suzhou, China

Test Facility / Accreditations

Measurements were performed at MRT Laboratory located in Tian'edang Rd., Suzhou, China.

- MRT facility is a FCC registered (MRT Reg. No. 893164) test facility with the site description report on file and has met all the requirements specified in ANSI C63.4-2014.
- MRT facility is an IC registered (MRT Reg. No. 11384A-1) test laboratory with the site description on file at Industry Canada.
- MRT facility is a VCCI registered (R-20025, G-20034, C-20020, T-20020) test laboratory with the site description on file at VCCI Council.
- MRT Lab is accredited to ISO 17025 by the American Association for Laboratory Accreditation (A2LA) under the American Association for Laboratory Accreditation Program (A2LA Cert. No. 3628.01) in EMC, Telecommunications, Radio and SAR testing.



1. INTRODUCTION

1.1. Scope

Measurement and determination of electromagnetic emissions (EMC) of radio frequency devices including intentional and/or unintentional radiators for compliance with the technical rules and regulations of the Federal Communications Commission and the Innovation, Science and Economic Development Canada and Certification and Engineering Bureau.

1.2. MRT Test Location

The map below shows the location of the MRT LABORATORY, its proximity to the Taihu Lake. These measurement tests were conducted at the MRT Technology (Suzhou) Co., Ltd. Facility located at D8 Building, No.2 Tian'edang Rd., Wuzhong Economic Development Zone, Suzhou, China. The measurement facility compliant with the test site requirements specified in ANSI C63.4-2014.

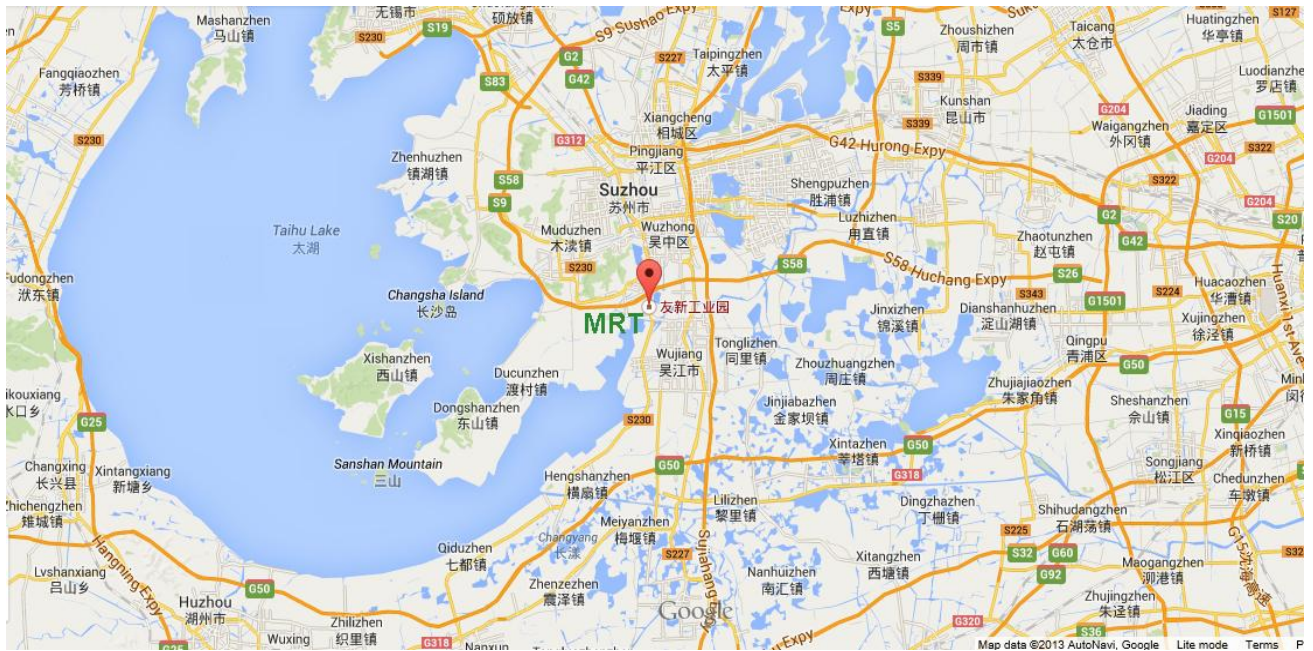

2. PRODUCT INFORMATION

2.1. Feature of Equipment under Test

Product Name:	Receiver
Model No.:	SR6100AT, SR6110AT
Brand Name:	Spektrum
Frequency Range:	2405 ~ 2478 MHz
Type of Modulation:	GFSK
Channel Number:	23
Antenna Information:	Monopole Antenna, 2dBi

Note: The different models are only for marketing different clients, others are the same.

2.2. Working Frequencies

Channel	Frequency	Channel	Frequency
01	2405 MHz	02	2408 MHz
03	2412 MHz	04	2415 MHz
05	2418 MHz	06	2421 MHz
07	2425 MHz	08	2428 MHz
09	2431 MHz	10	2434 MHz
11	2438 MHz	12	2440 MHz
13	2444 MHz	14	2447 MHz
15	2451 MHz	16	2454 MHz
17	2457 MHz	18	2460 MHz
19	2464 MHz	20	2467 MHz
21	2470 MHz	22	2474 MHz
23	2478 MHz	---	---

Note: The engineer test sample was provided by the manufacturer, it was configured into fixed frequency transmitter status after power on.

2.3. Test Mode

Test Mode	Mode 1: Transmit by GFSK
-----------	--------------------------

2.4. Device Capabilities

This device contains the following capabilities:

2.4G Transmitter.

The maximum achievable duty cycles for all modes were determined based on measurements performed on a spectrum analyzer in zero-span mode with RBW = 1MHz, VBW = 3MHz, and detector = peak. The RBW and VBW were both greater than $50/T$, where T is the minimum transmission duration, and the number of sweep points across T was greater than 100. The duty cycles are as follows:

Time On (ms)	One Period (ms)	Duty Cycle (%)	Duty Cycle Factor (dB)
12.15	100	12.15	-18.31

Note: Duty Cycle Factor = $20 \cdot \log(\text{Duty Cycle})$

2.5. Test Configuration

The device was tested per the guidance of ANSI C63.10-2013. ANSI C63.10-2013 was used to reference the appropriate EUT setup for radiated spurious emissions testing and AC line conducted testing.

2.6. EMI Suppression Device(s)/Modifications

No EMI suppression device(s) were added and/or no modifications were made during testing.

2.7. Labeling Requirements

Per 2.1074 & 15.19; Docket 95-19

The label shall be permanently affixed at a conspicuous location on the device; instruction manual or pamphlet supplied to the user and be readily visible to the purchaser at the time of purchase.

However, when the device is so small wherein placement of the label with specified statement is not practical, only the FCC ID must be displayed on the device per Section 15.19(a)(5). Please see attachment for FCC ID label and label location.

RSS-Gen Issue 5 Section 4

In addition to complying with the applicable RSSs and RSP-100, each unit of a product model (i.e. of a radio apparatus) shall meet the labelling requirements set out in this section prior to being marketed in Canada or imported into Canada.

For information regarding the labelling option, see Section 4.1, 4.2, 4.3 4.4. The label for the certified product represents the manufacturer's or importer's compliance with Innovation, Science and Economic Development Canada's (ISED) regulatory requirements.

Please see attachment for IC label and label location.

3. DESCRIPTION of TEST

3.1. Evaluation Procedure

The measurement procedures described in the American National Standard for Testing Unlicensed Wireless Devices (ANSI C63.10-2013), and the guidance was used in the measurement of the device.

Deviation from measurement procedure.....None

3.2. AC Line Conducted Emissions

The line-conducted facility is located inside an 8'x4'x4' shielded enclosure. A 1m x 2m wooden table 80cm high is placed 40cm away from the vertical wall and 80cm away from the sidewall of the shielded room. Two 10kHz-30MHz, 50Ω/50uH Line-Impedance Stabilization Networks (LISNs) are bonded to the shielded room floor. Power to the LISNs is filtered by external high-current high-insertion loss power line filters. These filters attenuate ambient signal noise from entering the measurement lines. These filters are also bonded to the shielded enclosure.

The EUT is powered from one LISN and the support equipment is powered from the second LISN. All interconnecting cables more than 1 meter were shortened to a 1 meter length by non-inductive bundling (serpentine fashion) and draped over the back edge of the test table. All cables were at least 40cm above the horizontal reference ground-plane. Power cables for support equipment were routed down to the second LISN while ensuring that that cables were not draped over the second LISN.

Sufficient time for the EUT, support equipment, and test equipment was allowed in order for them to warm up to their normal operating condition. The RF output of the LISN was connected to the receiver and exploratory measurements were made to determine the frequencies producing the maximum emission from the EUT. The receiver was scanned from 150kHz to 30MHz. The detector function was set to peak mode for exploratory measurements while the bandwidth of the analyzer was set to 9kHz. The EUT, support equipment, and interconnecting cables were arranged and manipulated to maximize each emission. Each emission was also maximized by varying: power lines, the mode of operation or data exchange speed, or support equipment whichever determined the worst-case emission. Once the worst case emissions have been identified, the one EUT cable configuration/arrangement and mode of operation that produced these emissions are used for final measurements on the same test site. The analyzer is set to CISPR quasi-peak and average detectors with a 9kHz resolution bandwidth for final measurements.

An extension cord was used to connect to a single LISN which powered by EUT. The extension cord was calibrated with LISN, the impedance and insertion loss are compliance with the requirements as stated in ANSI C63.10-2013.

3.3. Radiated Emissions

The radiated test facilities consisted of an indoor 3 meter semi-anechoic chamber used for final measurements and exploratory measurements, when necessary. The measurement area is contained within the semi-anechoic chamber which is shielded from any ambient interference. For measurements above 1GHz absorbers are arranged on the floor between the turn table and the antenna mast in such a way so as to maximize the reduction of reflections. For measurements below 1GHz, the absorbers are removed. A MF Model 210SS turntable is used for radiated measurement. It is a continuously rotatable, remote controlled, metallic turntable and 2 meters (6.56 ft.) in diameter. The turn table is flush with the raised floor of the chamber in order to maintain its function as a ground plane. An 80cm high PVC support structure is placed on top of the turntable.

For all measurements, the spectrum was scanned through all EUT azimuths and from 1 to 4 meter receive antenna height using a broadband antenna from 30MHz up to the upper frequency shown in 15.33(b)(1) depending on the highest frequency generated or used in the device or on which the device operates or tunes. For frequencies above 1GHz, linearly polarized double ridge horn antennas were used. For frequencies below 30MHz, a calibrated loop antenna was used. When exploratory measurements were necessary, they were performed at 1 meter test distance inside the semi-anechoic chamber using broadband antennas, broadband amplifiers, and spectrum analyzers to determine the frequencies and modes producing the maximum emissions. Sufficient time for the EUT, support equipment, and test equipment was allowed in order for them to warm up to their normal operating condition. The test set-up for frequencies below 1GHz was placed on top of the 0.8 meter high, 1 x 1.5 meter table; and test set-up for frequencies 1-40GHz was placed on top of the 1.5 meter high, 1 x 1.5 meter table. The EUT, support equipment, and interconnecting cables were arranged and manipulated to maximize each emission. Appropriate precaution was taken to ensure that all emissions from the EUT were maximized and investigated. The system configuration, clock speed, mode of operation or video resolution, if applicable, turntable azimuth, and receive antenna height was noted for each frequency found.

Final measurements were made in the semi-anechoic chamber using calibrated, linearly polarized broadband and horn antennas. The test setup was configured to the setup that produced the worst case emissions. The spectrum analyzer was set to investigate all frequencies required for testing to compare the highest radiated disturbances with respect to the specified limits. The turntable containing the EUT was rotated through 360 degrees and the height of the receive antenna was varied 1 to 4 meters and stopped at the azimuth and height producing the maximum emission. Each emission was maximized by changing the orientation of the EUT through three orthogonal planes and changing the polarity of the receive antenna, whichever produced the worst-case emissions. According to 3dB Beam-Width of horn antenna, the horn antenna should be always directed to the EUT when rising height.

4. ANTENNA REQUIREMENTS

Excerpt from §15.203 of the FCC Rules/Regulations:

“An intentional radiator antenna shall be designed to ensure that no antenna other than that furnished by the responsible party can be used with the device. The use of a permanently attached antenna or of an antenna that uses a unique coupling to the intentional radiator shall be considered sufficient to comply with the provisions of this section.”

Conclusion:

The device unit complies with the requirement of §15.203.

5. TEST EQUIPMENT CALIBRATION DATE

Conducted Emissions - SR2

Instrument	Manufacturer	Type No.	Asset No.	Cali. Interval	Cali. Due Date
EMI Test Receiver	R&S	ESR3	MRTSUE06185	1 year	2020/04/15
Two-Line V-Network	R&S	ENV 216	MRTSUE06002	1 year	2020/06/13
Two-Line V-Network	R&S	ENV 216	MRTSUE06003	1 year	2020/06/13
Thermohygrometer	Testo	608-H1	MRTSUE06404	1 year	2020/08/08
Shielding Room	MIX-BEP	Chamber-SR2	MRTSUE06215	N/A	N/A

Radiated Emissions - AC1

Instrument	Manufacturer	Type No.	Asset No.	Cali. Interval	Cali. Due Date
EMI Test Receiver	R&S	ESR7	MRTSUE06001	1 year	2020/08/01
PXA Signal Analyzer	Keysight	9030B	MRTSUE06395	1 year	2020/09/03
Loop Antenna	Schwarzbeck	FMZB 1519	MRTSUE06025	1 year	2019/11/09
Bilog Period Antenna	Schwarzbeck	VULB 9168	MRTSUE06172	1 year	2020/03/31
Broad Band Horn Antenna	Schwarzbeck	BBHA 9120D	MRTSUE06023	1 year	2020/10/13
Broad Band Horn Antenna	Schwarzbeck	BBHA 9170	MRTSUE06024	1 year	2019/12/17
Microwave System Amplifier	Agilent	83017A	MRTSUE06076	1 year	2019/11/16
Preamplifier	Schwarzbeck	BBV 9721	MRTSUE06121	1 year	2020/06/11
Thermohygrometer	Testo	608-H1	MRTSUE06403	1 year	2020/08/08
Anechoic Chamber	TDK	Chamber-AC1	MRTSUE06212	1 year	2020/04/30

Radiated Emission - AC2

Instrument	Manufacturer	Type No.	Asset No.	Cali. Interval	Cali. Due Date
Spectrum Analyzer	Keysight	N9038A	MRTSUE06125	1 year	2020/08/01
Loop Antenna	Schwarzbeck	FMZB 1519	MRTSUE06025	1 year	2019/11/09
Bilog Period Antenna	Schwarzbeck	VULB 9162	MRTSUE06022	1 year	2020/10/13
Horn Antenna	Schwarzbeck	BBHA9120D	MRTSUE06171	1 year	2019/11/09
Broad Band Horn Antenna	Schwarzbeck	BBHA 9170	MRTSUE06024	1 year	2019/12/17
Broadband Coaxial Preamplifier	Schwarzbeck	BBV 9718	MRTSUE06176	1 year	2019/11/16
Preamplifier	Schwarzbeck	BBV 9721	MRTSUE06121	1 year	2020/06/11
Temperature/Humidity Meter	Minggao	ETH529	MRTSUE06170	1 year	2019/12/13
Anechoic Chamber	RIKEN	Chamber-AC2	MRTSUE06213	1 year	2020/04/30

Conducted Test Equipment - TR3

Instrument	Manufacturer	Type No.	Asset No.	Cali. Interval	Cali. Due Date
EXA Signal Analyzer	Agilent	N9020A	MRTSUE06106	1 year	2020/04/15
EXA Signal Analyzer	Keysight	N9010B	MRTSUE06452	1 year	2020/07/11
Signal Analyzer	R&S	FSV40	MRTSUE06218	1 year	2020/04/15
Power Meter	Agilent	U2021XA	MRTSUE06030	1 year	2019/11/16
USB wideband power sensor	Keysight	U2021XA	MRTSUE06446	1 year	2020/06/30
USB wideband power sensor	Keysight	U2021XA	MRTSUE06447	1 year	2020/06/30
Bluetooth Test Set	Anritsu	MT8852B-042	MRTSUE06389	1 year	2020/06/13
Audio Analyzer	Agilent	U8903B	MRTSUE06143	1 year	2020/06/13
Modulation Analyzer	HP	8901A	MRTSUE06098	1 year	2020/10/10
Wideband Radio Communication Tester	R&S	CMW 500	MRTSUE06243	1 year	2019/11/16
DC Power Supply	GWINSTEK	DPS-3303C	MRTSUE06064	N/A	N/A
Temperature & Humidity Chamber	BAOYT	BYH-150CL	MRTSUE06051	1 year	2019/11/16
Thermohygrometer	testo	608-H1	MRTSUE06401	1 year	2020/08/08

Software	Version	Function
EMI Software	V3	EMI Test Software

6. MEASUREMENT UNCERTAINTY

Where relevant, the following test uncertainty levels have been estimated for tests performed on the EUT as specified in CISPR 16-4-2. This uncertainty represents an expanded uncertainty expressed at approximately the 95% confidence level using a coverage factor of $k = 2$.

AC Conducted Emission Measurement - SR2
Measuring Uncertainty for a Level of Confidence of 95% ($U=2Uc(y)$): 9kHz~150kHz: 3.84dB 150kHz~30MHz: 3.46dB
Radiated Emission Measurement - AC1
Measuring Uncertainty for a Level of Confidence of 95% ($U=2Uc(y)$): Horizontal: 30MHz~300MHz: 4.07dB 300MHz~1GHz: 3.63dB 1GHz~18GHz: 4.16dB Vertical: 30MHz~300MHz: 4.18dB 300MHz~1GHz: 3.60dB 1GHz~18GHz: 4.76dB
Radiated Emission Measurement - AC2
Measuring Uncertainty for a Level of Confidence of 95% ($U=2Uc(y)$): Horizontal: 30MHz~300MHz: 3.75dB 300MHz~1GHz: 3.53dB 1GHz~18GHz: 4.28dB Vertical: 30MHz~300MHz: 3.86dB 300MHz~1GHz: 3.53dB 1GHz~18GHz: 4.33dB

7. TEST RESULT

7.1. Summary

FCC Section(s)	IC Section(s)	Test Description	Test Limit	Test Condition	Test Result	Reference
15.247(b)(3)	RSS-247 [5.4(4)]	Output Power	$\leq 1\text{Watt}$ & $\text{EIRP} \leq 4\text{Watt}$	Conducted	Pass	Section 7.2
15.205 15.209	RSS-247 [5.5]	General Field Strength Limits (Restricted Bands and Radiated Emission Limits)	Emissions in restricted bands must meet the radiated limits detailed in 15.209	Radiated	Pass	Section 7.3 & 7.4
15.207	RSS-Gen [8.8]	AC Conducted Emissions 150kHz - 30MHz	< FCC 15.207 limits	Line Conducted	N/A	Section 7.5

Notes:

- 1) All modes of operation and data rates were investigated. For radiated emission test, every axis (X, Y, Z) was also verified. The test results shown in the following sections represent the worst case emissions.
- 2) The analyzer plots shown in this section were all taken with a correction table loaded into the analyzer. The correction table was used to account for the losses of the cables and attenuators used as part of the system to connect the EUT to the analyzer at all frequencies of interest.
- 3) "N/A" means that the test item is not applicable, and the details information refers to relevant section.

7.2. Output Power Measurement

7.2.1. Test Limit

The maximum conducted output power shall be exceed 1 Watt (30dBm) and the E.I.R.P shall not exceed 4 Watt (36dBm).

7.2.2. Test Procedure Used

ANSI C63.10 Section 11.9.2.3.2

7.2.3. Test Setting

Average Power Measurement

Average power measurements were perform only when the EUT was transmitting at its maximum power control level using a broadband power meter with a pulse sensor. The power meter implemented triggering and gating capabilities which were set up such that power measurements were recorded only during the ON time of the transmitter.

7.2.4. Test Setup

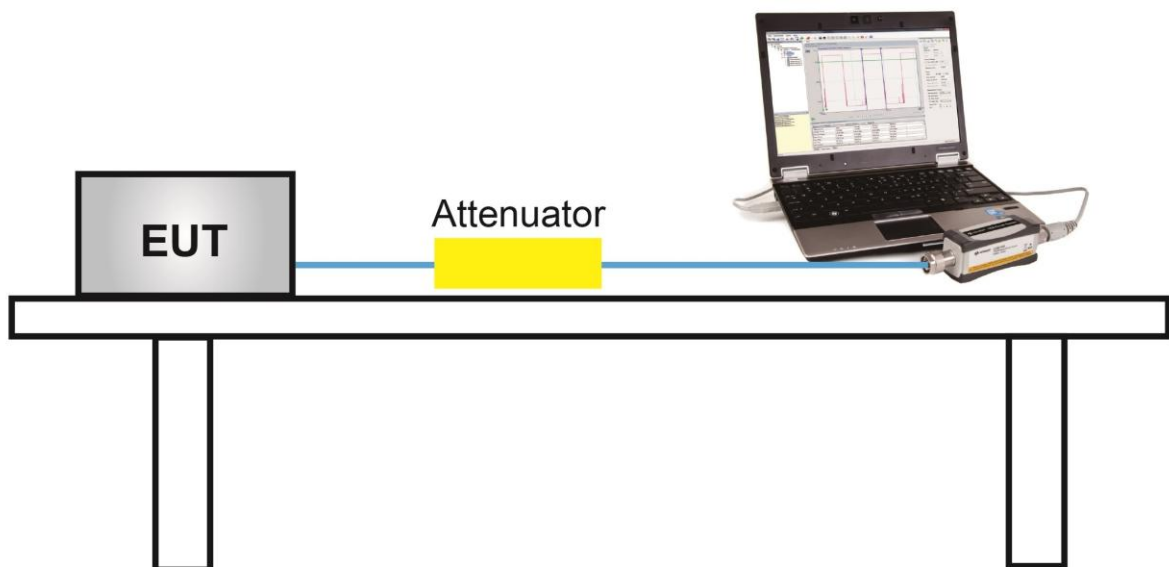

7.2.5. Test Result

Product	Receiver	Temperature	23°C
Test Engineer	Ternence Wang	Relative Humidity	51%
Test Site	TR3	Test Date	2019/09/12

Test Mode / Bandwidth	Channel No.	Freq. (MHz)	Average Power (dBm)	Limit (dBm)	Result
GFSK	01	2405	25.47	≤ 30.00	Pass
GFSK	12	2440	25.58	≤ 30.00	Pass
GFSK	23	2478	25.69	≤ 30.00	Pass

Note: The max EIRP = 25.69dBm + 2dBi = 27.69dBm.

7.3. Radiated Spurious Emission Measurement

7.3.1. Test Limit

All out of band emissions appearing in a restricted band as specified in Section 15.205 of the Title 47 CFR must not exceed the limits shown in Table per Section 15.209.

FCC Part 15 Subpart C Paragraph 15.209		
Frequency [MHz]	Field Strength [V/m]	Measured Distance [Meters]
0.009 - 0.490	2400/F (kHz)	300
0.490 - 1.705	24000/F (kHz)	30
1.705 - 30	30	30
30 - 88	100	3
88 - 216	150	3
216 - 960	200	3
Above 960	500	3

7.3.2. Test Procedure Used

ANSI C63.10 Section 6.3 (General Requirements)

ANSI C63.10 Section 6.4 (Standard test method below 30MHz)

ANSI C63.10 Section 6.5 (Standard test method above 30MHz to 1GHz)

ANSI C63.10 Section 6.6 (Standard test method above 1GHz)

7.3.3. Test Setting

Quasi-Peak Measurements below 1GHz

1. Analyzer center frequency was set to the frequency of the radiated spurious emission of interest
2. Span was set greater than 1MHz
3. RBW = as specified in Table 1
4. Detector = CISPR quasi-peak or average
5. Sweep time = auto couple
6. Trace was allowed to stabilize

Table 1 - RBW as a function of frequency

Frequency	RBW
9 ~ 150 kHz	200 ~ 300 Hz
0.15 ~ 30 MHz	9 ~ 10 kHz
30 ~ 1000 MHz	100 ~ 120 kHz

Peak Measurements above 1GHz

1. Analyzer center frequency was set to the frequency of the radiated spurious emission of interest
2. RBW = 1MHz
3. VBW = 3MHz
4. Detector = peak
5. Sweep time = auto couple
6. Trace mode = max hold
7. Trace was allowed to stabilize

7.3.4. Test Setup

Below 1GHz Test Setup:

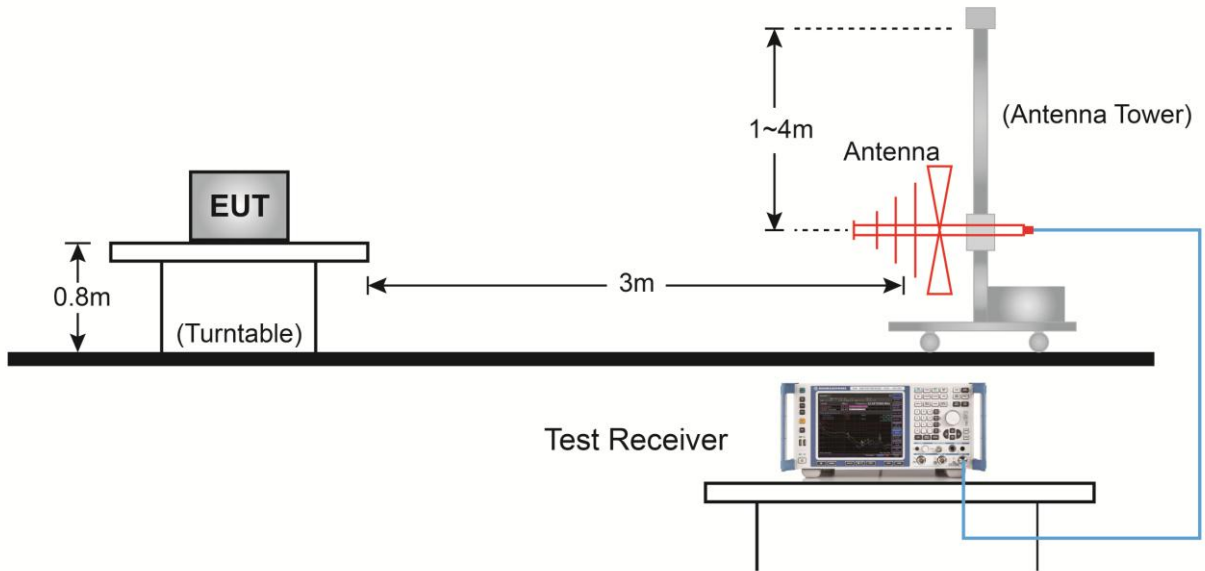

Above 1GHz Test Setup:

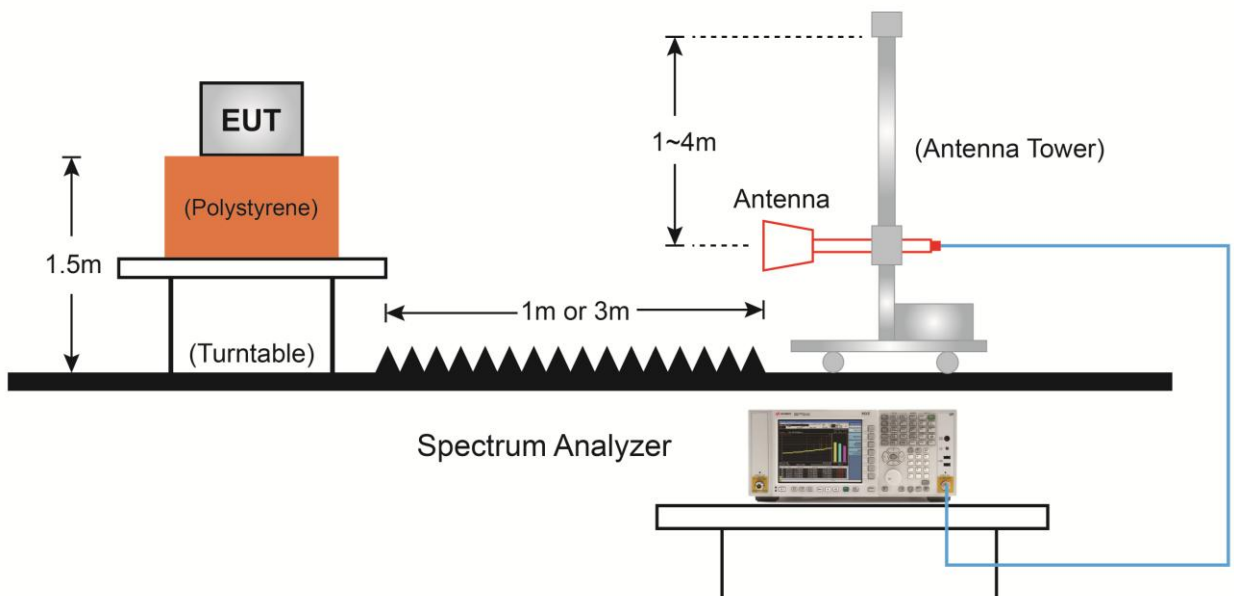

7.3.5. Test Result

Product	Receiver	Temperature	26°C
Test Engineer	Messiah Li	Relative Humidity	56%
Test Site	AC1	Test Date	2019/09/19
Test Mode:	GFSK	Test Channel:	01
Remark:	1. Average measurement was not performed if peak level lower than average limit (54dBµV/m). 2. Other frequency was 20dB below limit line within 1-18GHz, there is not show in the report.		

Mark	Frequency (MHz)	Reading Level (dBµV)	Factor (dB)	Duty Cycle Factor (dB)	Measure Level (dBµV/m)	Limit (dBµV/m)	Margin (dB)	Detector	Polarization
	4808.0	55.1	3.5	N/A	58.6	74.0	-15.4	Peak	Horizontal
	4808.0	55.1	3.5	-18.3	40.3	54.0	-13.7	Average	Horizontal
*	7205.0	56.1	11.7	N/A	67.8	91.2	-23.4	Peak	Horizontal
*	9610.5	53.2	13.5	N/A	66.7	91.2	-24.5	Peak	Horizontal
	12007.5	44.0	19.5	N/A	63.5	74.0	-10.5	Peak	Horizontal
	12007.5	44.0	19.5	-18.3	45.2	54.0	-8.8	Average	Horizontal
	4799.5	59.7	3.5	N/A	63.2	74.0	-10.8	Peak	Vertical
	4799.5	59.7	3.5	-18.3	44.9	54.0	-9.1	Average	Vertical
*	7205.0	53.4	11.7	N/A	65.1	91.2	-26.1	Peak	Vertical
*	9610.5	49.4	13.5	N/A	62.9	91.2	-28.3	Peak	Vertical
	12007.5	40.3	19.5	N/A	59.8	74.0	-14.2	Peak	Vertical
	12007.5	40.3	19.5	-18.3	41.5	54.0	-12.5	Average	Vertical

Note 1: "*" is not in restricted band, its limit is 30dBc of the fundamental emission level (121.1dBµV/m) or 15.209 which is higher.

Note 2: Peak Measure Level (dBµV/m) = Reading Level (dBµV) + Factor (dB)

Average Measure Level = Peak Measure Level + Duty Cycle Factor

Factor (dB) = Cable Loss (dB) + Antenna Factor (dB/m) - Pre Amplifier Gain (dB)

Note 3: Average measurement was not performed when the peak level lower than average limit.

Product	Receiver	Temperature	26°C
Test Engineer	Messiah Li	Relative Humidity	56%
Test Site	AC1	Test Date	2019/09/19
Test Mode:	GFSK	Test Channel:	12
Remark:	1. Average measurement was not performed if peak level lower than average limit (54dB μ V/m). 2. Other frequency was 20dB below limit line within 1-18GHz, there is not show in the report.		

Mark	Frequency (MHz)	Reading Level (dB μ V)	Factor (dB)	Duty Cycle Factor (dB)	Measure Level (dB μ V/m)	Limit (dB μ V/m)	Margin (dB)	Detector	Polarization
	4884.5	61.1	3.5	N/A	64.6	74.0	-9.4	Peak	Horizontal
	4884.5	61.1	3.5	-18.3	46.3	54.0	-7.7	Average	Horizontal
	7315.5	54.3	11.9	N/A	66.2	74.0	-7.8	Peak	Horizontal
	7315.5	54.3	11.9	-18.3	47.9	54.0	-6.1	Average	Horizontal
*	9763.5	46.0	14.0	N/A	60.0	91.9	-31.9	Peak	Horizontal
*	14642.5	38.9	22.8	N/A	61.7	91.9	-30.2	Peak	Horizontal
	4876.0	67.6	3.6	N/A	71.2	74.0	-2.8	Peak	Vertical
	4876.0	67.6	3.6	-18.3	52.9	54.0	-1.1	Average	Vertical
	7315.5	51.0	11.9	N/A	62.9	74.0	-11.1	Peak	Vertical
	7315.5	51.0	11.9	-18.3	44.6	54.0	-9.4	Average	Vertical
*	9763.5	47.0	14.0	N/A	61.0	91.9	-30.9	Peak	Vertical
*	14642.5	41.3	22.8	N/A	64.1	91.9	-27.8	Peak	Vertical

Note 1: "*" is not in restricted band, its limit is 30dBc of the fundamental emission level (121.9dB μ V/m) or 15.209 which is higher.

Note 2: Peak Measure Level (dB μ V/m) = Reading Level (dB μ V) + Factor (dB)

Average Measure Level = Peak Measure Level + Duty Cycle Factor

Factor (dB) = Cable Loss (dB) + Antenna Factor (dB/m) - Pre Amplifier Gain (dB)

Note 3: Average measurement was not performed when the peak level lower than average limit.

Product	Receiver	Temperature	26°C
Test Engineer	Messiah Li	Relative Humidity	56%
Test Site	AC1	Test Date	2019/09/19
Test Mode:	GFSK	Test Channel:	23
Remark:	1. Average measurement was not performed if peak level lower than average limit (54dBμV/m). 2. Other frequency was 20dB below limit line within 1-18GHz, there is not show in the report.		

Mark	Frequency (MHz)	Reading Level (dBμV)	Factor (dB)	Duty Cycle Factor (dB)	Measure Level (dBμV/m)	Limit (dBμV/m)	Margin (dB)	Detector	Polarization
	4952.5	64.8	3.5	N/A	68.3	74.0	-5.7	Peak	Horizontal
	4952.5	64.8	3.5	-18.3	50.0	54.0	-4.0	Average	Horizontal
	7434.5	52.0	11.8	N/A	63.8	74.0	-10.2	Peak	Horizontal
	7434.5	52.0	11.8	-18.3	45.5	54.0	-8.5	Average	Horizontal
*	9908.0	42.0	14.2	N/A	56.2	92.4	-36.2	Peak	Horizontal
*	14863.5	38.4	22.3	N/A	60.7	92.4	-31.7	Peak	Horizontal
	4952.5	68.0	3.5	N/A	71.5	74.0	-2.5	Peak	Vertical
	4952.5	68.0	3.5	-18.3	53.2	54.0	-0.8	Average	Vertical
	7434.5	47.1	11.8	N/A	58.9	74.0	-15.1	Peak	Vertical
	7434.5	47.1	11.8	-18.3	40.6	54.0	-13.4	Average	Vertical
*	9908.0	40.2	14.2	N/A	54.4	92.4	-38.0	Peak	Vertical
*	14863.5	36.4	22.3	N/A	58.7	92.4	-33.7	Peak	Vertical

Note 1: "*" is not in restricted band, its limit is 30dBc of the fundamental emission level (122.4dBμV/m) or 15.209 which is higher.

Note 2: Peak Measure Level (dBμV/m) = Reading Level (dBμV) + Factor (dB)

Average Measure Level = Peak Measure Level + Duty Cycle Factor

Factor (dB) = Cable Loss (dB) + Antenna Factor (dB/m) - Pre Amplifier Gain (dB)

Note 3: Average measurement was not performed when the peak level lower than average limit.

The worst case of Radiated Emission below 1GHz:

Site: AC1	Time: 2019/09/05 - 01:45
Limit: FCC_Part15.209_RSE(3m)	Engineer: David Lv
Probe: VULB 9168_20-2000MHz	Polarity: Horizontal
EUT: Receiver	Power: By Battery
Test Mode: There is the worst case within frequency range 30MHz~1GHz.	

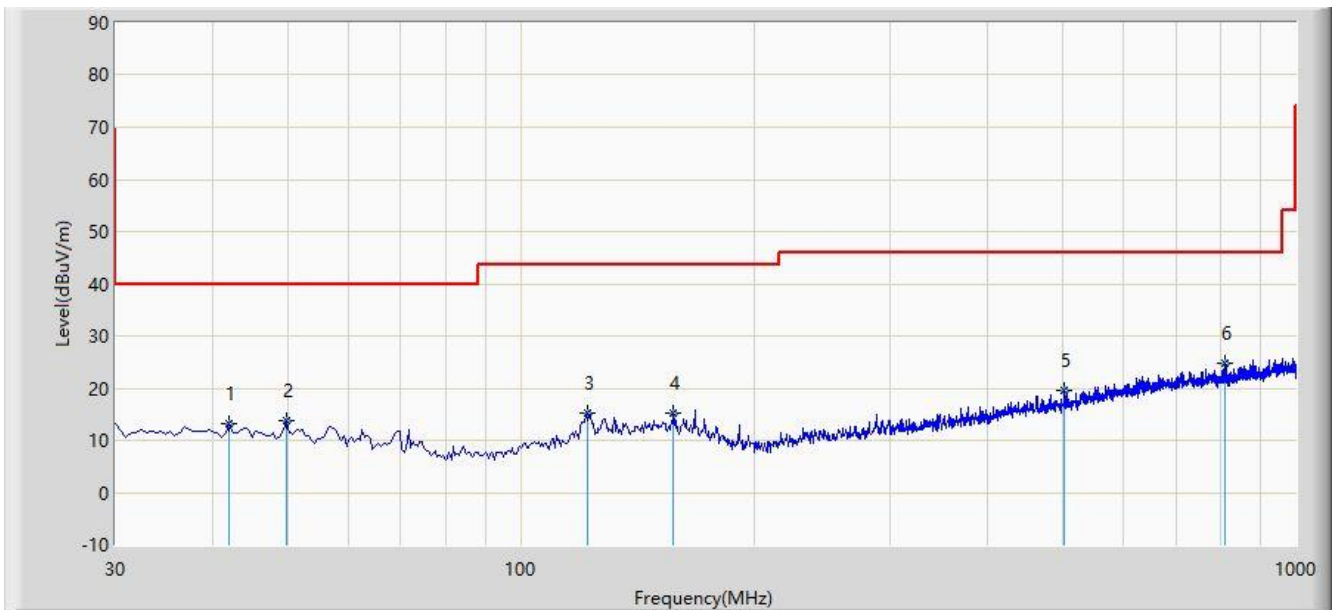

No	Flag	Mark	Frequency (MHz)	Measure Level (dBuV/m)	Reading Level (dBuV)	Margin (dB)	Limit (dBuV/m)	Factor (dB)	Type
1		*	42.125	13.282	-1.267	-26.718	40.000	14.549	QP
2			49.885	13.893	-0.360	-26.107	40.000	14.253	QP
3			122.150	15.311	1.838	-28.189	43.500	13.472	QP
4			157.555	15.174	-0.235	-28.326	43.500	15.409	QP
5			502.875	19.576	0.633	-26.424	46.000	18.943	QP
6			811.335	24.710	0.954	-21.290	46.000	23.756	QP

Note 1: Measure Level (dB μ V/m) = Reading Level (dB μ V) + Factor (dB)

Factor (dB) = Cable Loss (dB) + Antenna Factor (dB/m)

Note 2: The test trace is same as the ambient noise and the amplitude of the emissions are attenuated more than 20dB below the permissible (the test frequency range: 9kHz ~ 30MHz, 18GHz ~ 25GHz), therefore no data appear in the report.

Site: AC1	Time: 2019/09/05 - 01:46
Limit: FCC_Part15.209_RSE(3m)	Engineer: David Lv
Probe: VULB 9168_20-2000MHz	Polarity: Vertical
EUT: Receiver	Power: By Battery
Test Mode: There is the worst case within frequency range 30MHz~1GHz.	

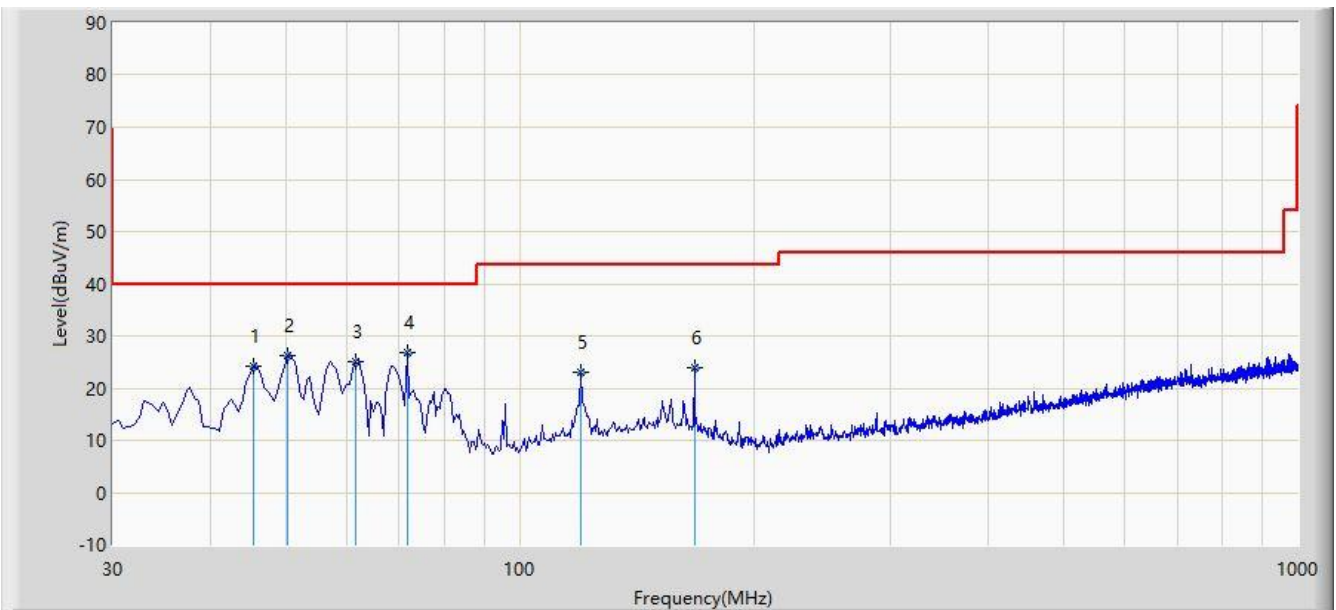

No	Flag	Mark	Frequency (MHz)	Measure Level (dBuV/m)	Reading Level (dBuV)	Margin (dB)	Limit (dBuV/m)	Factor (dB)	Type
1			45.520	24.292	9.957	-15.708	40.000	14.334	QP
2			50.370	26.375	12.151	-13.625	40.000	14.224	QP
3			61.525	25.030	11.786	-14.970	40.000	13.244	QP
4			71.710	26.862	15.444	-13.138	40.000	11.418	QP
5			119.725	22.955	9.669	-20.545	43.500	13.286	QP
6		*	167.740	23.984	9.287	-19.516	43.500	14.697	QP

Note 1: Measure Level (dBμV/m) = Reading Level (dBμV) + Factor (dB)

Factor (dB) = Cable Loss (dB) + Antenna Factor (dB/m)

Note 2: The test trace is same as the ambient noise and the amplitude of the emissions are attenuated more than 20dB below the permissible (the test frequency range: 9kHz ~ 30MHz, 18GHz ~ 25GHz), therefore no data appear in the report.

7.4. Radiated Restricted Band Edge Measurement

7.4.1. Test Limit

For 15.205 requirement:

Radiated emissions which fall in the restricted bands, as defined in Section 15.205(a) of FCC part 15, must also comply with the radiated emission limits specified in Section 15.209(a).

Frequency (MHz)	Frequency (MHz)	Frequency (MHz)	Frequency (GHz)
0.090 - 0.110	16.42 - 16.423	399.9 - 410	4.5 - 5.15
¹ 0.495 - 0.505	16.69475 - 16.69525	608 - 614	5.35 - 5.46
2.1735 - 2.1905	16.80425 - 16.80475	960 - 1240	7.25 - 7.75
4.125 - 4.128	25.5 - 25.67	1300 - 1427	8.025 - 8.5
4.17725 - 4.17775	37.5 - 38.25	1435 - 1626.5	9.0 - 9.2
4.20725 - 4.20775	73 - 74.6	1645.5 - 1646.5	9.3 - 9.5
6.215 - 6.218	74.8 - 75.2	1660 - 1710	10.6 - 12.7
6.26775 - 6.26825	108 - 121.94	1718.8 - 1722.2	13.25 - 13.4
6.31175 - 6.31225	123 - 138	2200 - 2300	14.47 - 14.5
8.291 - 8.294	149.9 - 150.05	2310 - 2390	15.35 - 16.2
8.362 - 8.366	156.52475 - 156.525	2483.5 - 2500	17.7 - 21.4
8.37625 - 8.38675	156.7 - 156.9	2690 - 2900	22.01 - 23.12
8.41425 - 8.41475	162.0125 - 167.17	3260 - 3267	23.6 - 24.0
12.29 - 12.293	167.72 - 173.2	3332 - 3339	31.2 - 31.8
12.51975 - 12.52025	240 - 285	3345.8 - 3358	36.43 - 36.5
12.57675 - 12.57725	322 - 335.4	3600 - 4400	(²)
13.36 - 13.41	--	--	--

All out of band emissions appearing in a restricted band as specified in Section 15.205 of the Title 47CFR must not exceed the limits shown in Table per Section 15.209.

FCC Part 15 Subpart C Paragraph 15.209		
Frequency [MHz]	Field Strength [uV/m]	Measured Distance [Meters]
0.009 - 0.490	2400/F (kHz)	300
0.490 - 1.705	24000/F (kHz)	30
1.705 - 30	30	30
30 - 88	100	3
88 - 216	150	3
216 - 960	200	3
Above 960	500	3

For RSS-Gen Section 8.10 requirement:

Radiated emissions which fall in the restricted bands, as defined in Section 8.10 of RSS-Gen, must also comply with the radiated emission limits specified in Section 8.9.

Frequency (MHz)	Frequency (MHz)	Frequency (MHz)	Frequency (GHz)
0.090 - 0.110	16.42 - 16.423	1645.5 - 1646.5	9.0 - 9.2
0.495 - 0.505	16.69475 - 16.69525	1660 - 1710	9.3 - 9.5
2.1735 - 2.1905	16.80425 - 16.80475	1718.8-1722.2	10.6 - 12.7
3.020 - 3.026	25.5 - 25.67	2200 - 2300	13.25 - 13.4
4.125 - 4.128	37.5 - 38.25	2310-2390	14.47 - 14.5
4.17725 - 4.17775	73 - 74.6	2483.5 - 2500	15.35 - 16.2
4.20725 - 4.20775	74.8 - 75.2	2655 - 2900	17.7 - 21.4
5.677 - 5.683	108 - 138	3260 - 3267	22.01 - 23.12
6.215 - 6.218	149.9 - 150.05	3332 - 3339	23.6 - 24.0
6.26775 - 6.26825	156.52475 - 156.52525	3345.8 - 3358	31.2 - 31.8
6.31175 - 6.31225	156.7 - 156.9	3500 - 4400	36.43 - 36.5
8.291 - 8.294	162.0125 - 167.17	4500 - 5150	Above 38.6
8.362 - 8.366	167.72 - 173.2	5350 - 5460	--
8.37625 - 8.38675	240 - 285	7250 - 7750	--
8.41425 - 8.41475	322 - 335.4	8025 - 8500	--
12.29 - 12.293	399.9 - 410	--	--
12.51975 - 12.52025	608 - 614	--	--
12.57675 - 12.57725	960 - 1427	--	--
13.36 -13.41	1435 - 1626.5	--	--

All out of band emissions appearing in a restricted band as specified in Section 8.10 of the RSS-Gen must not exceed the limits shown in Table per Section 8.9.

RSS-Gen Section 8.9		
Frequency [MHz]	Field Strength [uV/m]	Measured Distance [Meters]
0.009 - 0.490	2400/F (kHz)	300
0.490 - 1.705	24000/F (kHz)	30
1.705 - 30	30	30
30 - 88	100	3
88 - 216	150	3
216 - 960	200	3
Above 960	500	3

7.4.2. Test Procedure Used

ANSI C63.10 Section 6.3 (General Requirements)

ANSI C63.10 Section 6.6 (Standard test method above 1GHz)

7.4.3. Test Setting

Peak Field Strength Measurements

1. Analyzer center frequency was set to the frequency of the radiated spurious emission of interest
2. RBW = as specified in Table 1
3. VBW = 3MHz
4. Detector = peak
5. Sweep time = auto couple
6. Trace mode = max hold
7. Trace was allowed to stabilize

7.4.4. Test Setup

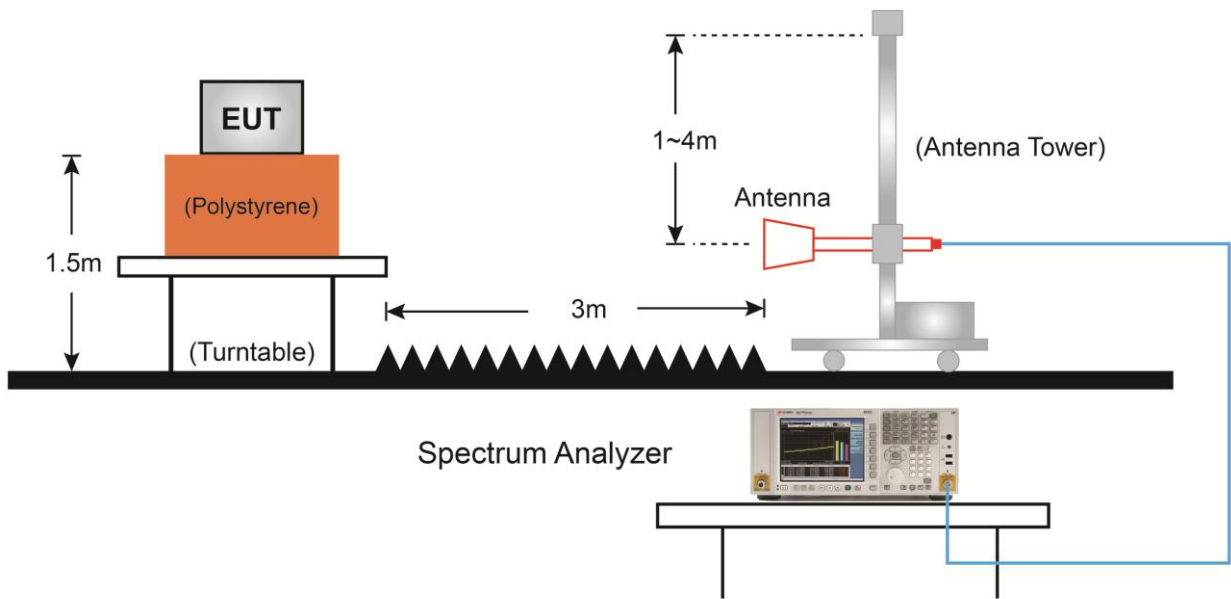

7.4.5. Test Result

Site: AC1	Time: 2019/09/05 - 03:51
Limit: FCC_Part15_Band Edge(3m)	Engineer: Messiah Li
Probe: BBHA9120D_1-18GHz	Polarity: Horizontal
EUT: Receiver	Power: By Battery
Test Mode: Transmit at Low Channel 2402MHz	

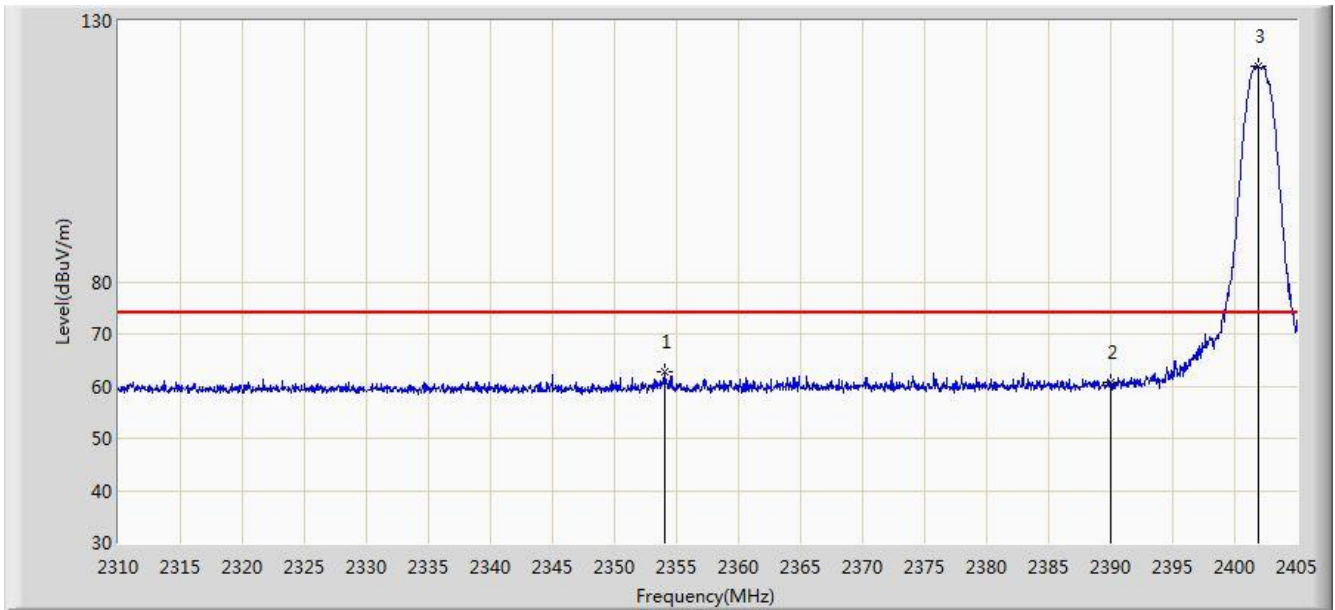

No	Flag	Mark	Frequency (MHz)	Reading Level (dBuV)	Factor (dB)	Duty Cycle Factor (dB)	Measure Level (dBuV/m)	Limit (dBuV/m)	Margin (dB)	Type
1			2354.080	30.314	32.495	N/A	62.809	74.000	-11.191	PK
			2354.080	30.314	32.495	-18.31	44.499	54.000	-9.501	AV
2			2390.000	28.175	32.413	N/A	60.588	74.000	-13.412	PK
			2390.000	28.175	32.413	-18.31	42.278	54.000	-11.722	AV
3		*	2401.865	88.779	32.396	N/A	121.175	N/A	N/A	PK

Note: Peak Measure Level (dB μ V/m) = Reading Level (dB μ V) + Factor (dB)

Average Measure Level = Peak Measure Level + Duty Cycle Factor

Factor (dB) = Cable Loss (dB) + Antenna Factor (dB/m)

Site: AC1	Time: 2019/09/05 - 03:56
Limit: FCC_Part15_Band Edge(3m)	Engineer: Messiah Li
Probe: BBHA9120D_1-18GHz	Polarity: Vertical
EUT: Receiver	Power: By Battery
Test Mode: Transmit at Low Channel 2402MHz	

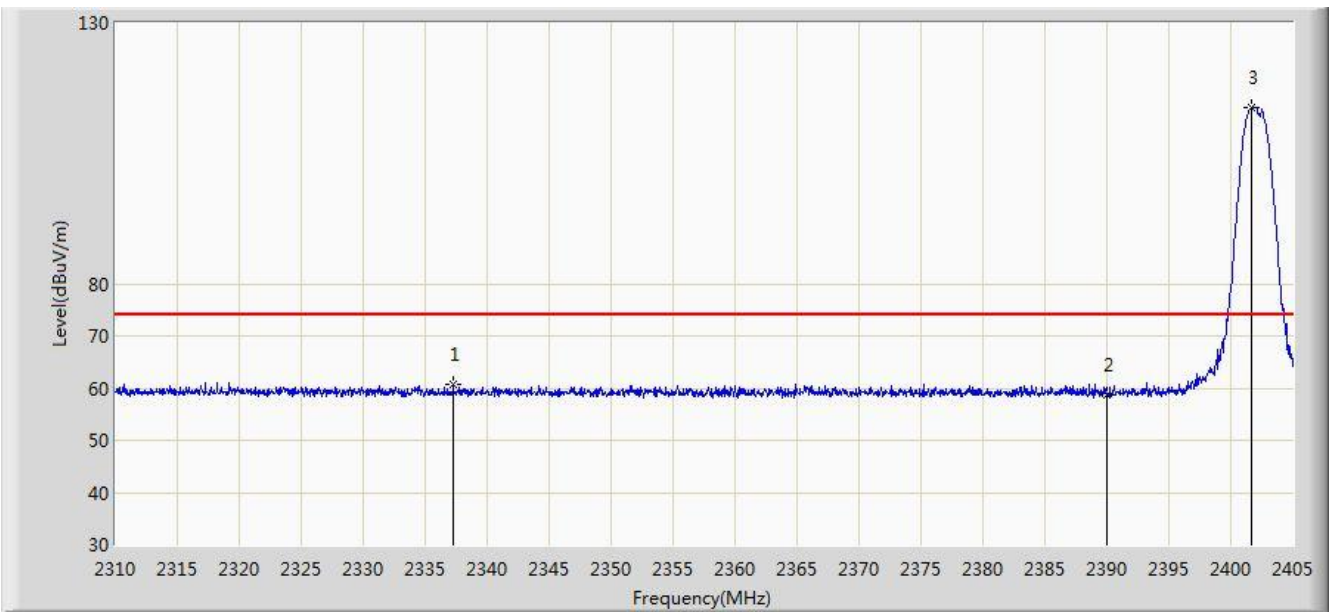

No	Flag	Mark	Frequency (MHz)	Reading Level (dBuV)	Factor (dB)	Duty Cycle Factor (dB)	Measure Level (dBuV/m)	Limit (dBuV/m)	Margin (dB)	Type
1			2337.265	28.160	32.561	N/A	60.721	74.000	-13.279	PK
			2337.265	28.160	32.561	-18.31	42.411	54.000	-11.589	AV
2			2390.000	26.294	32.413	N/A	58.707	74.000	-15.293	PK
			2390.000	26.294	32.413	-18.31	40.397	54.000	-13.603	AV
4		*	2401.722	81.462	32.396	N/A	113.858	N/A	N/A	PK

Note: Peak Measure Level (dBμV/m) = Reading Level (dBμV) + Factor (dB)

Average Measure Level = Peak Measure Level + Duty Cycle Factor

Factor (dB) = Cable Loss (dB) + Antenna Factor (dB/m)

Site: AC1	Time: 2019/09/05 - 04:04
Limit: FCC_Part15_Band Edge(3m)	Engineer: Messiah Li
Probe: BBHA9120D_1-18GHz	Polarity: Horizontal
EUT: Receiver	Power: By Battery
Test Mode: Transmit at High Channel 2478MHz	

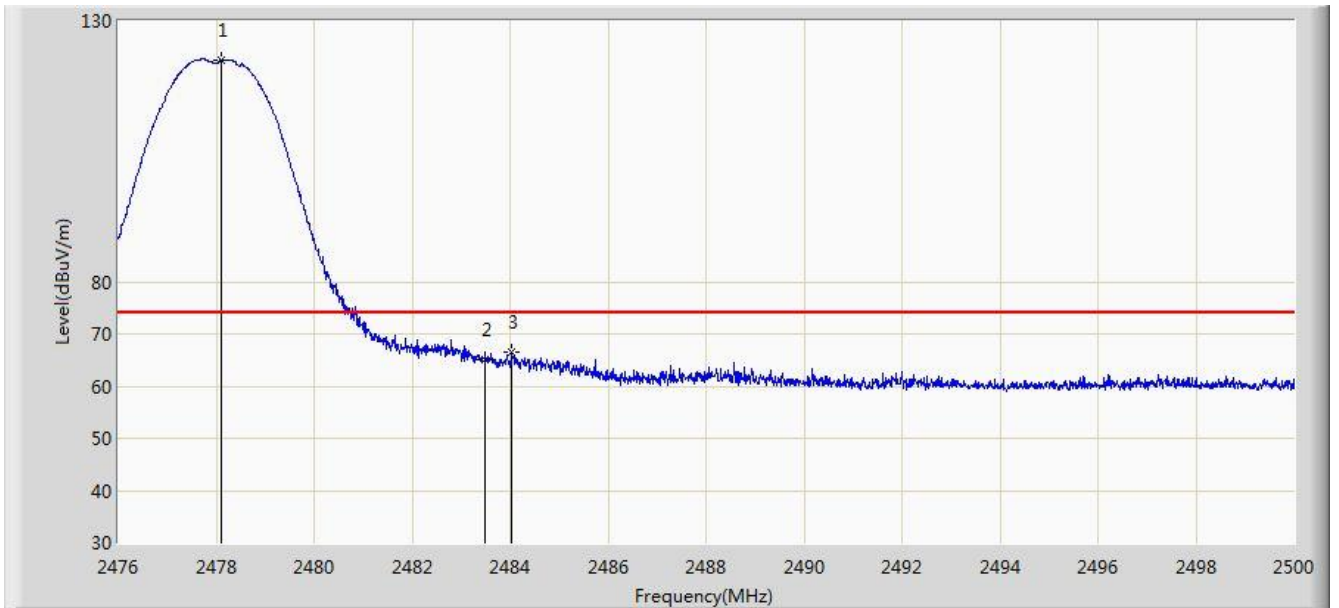

No	Flag	Mark	Frequency (MHz)	Reading Level (dBuV)	Factor (dB)	Duty Cycle Factor (dB)	Measure Level (dBuV/m)	Limit (dBuV/m)	Margin (dB)	Type
1		*	2478.112	89.992	32.404	N/A	122.396	N/A	N/A	PK
2			2483.500	32.760	32.416	N/A	65.176	74.000	-8.824	PK
			2483.500	32.760	32.416	-18.31	46.866	54.000	-7.134	AV
3			2484.040	34.214	32.417	N/A	66.631	74.000	-7.369	PK
			2484.040	34.214	32.417	-18.31	48.321	54.000	-5.679	AV

Note: Peak Measure Level (dB μ V/m) = Reading Level (dB μ V) + Factor (dB)

Average Measure Level = Peak Measure Level + Duty Cycle Factor

Factor (dB) = Cable Loss (dB) + Antenna Factor (dB/m)

Site: AC1	Time: 2019/09/05 - 04:07
Limit: FCC_Part15_Band Edge(3m)	Engineer: Messiah Li
Probe: BBHA9120D_1-18GHz	Polarity: Vertical
EUT: Receiver	Power: By Battery
Test Mode: Transmit at High Channel 2478MHz	

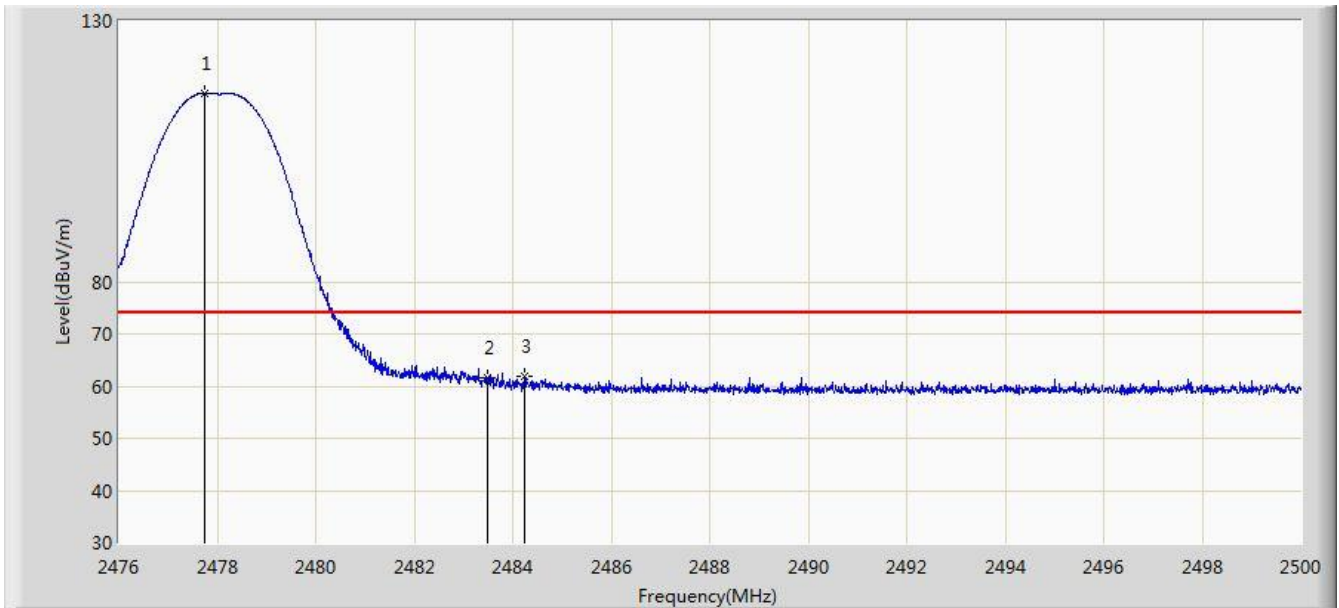

No	Flag	Mark	Frequency (MHz)	Reading Level (dBuV)	Factor (dB)	Duty Cycle Factor (dB)	Measure Level (dBuV/m)	Limit (dBuV/m)	Margin (dB)	Type
1		*	2477.740	83.668	32.403	N/A	116.071	N/A	N/A	PK
2			2483.500	29.082	32.416	N/A	61.498	74.000	-12.502	PK
			2483.500	29.082	32.416	-18.31	43.188	54.000	-10.812	AV
3			2484.232	29.529	32.417	N/A	61.946	74.000	-12.054	PK
			2484.232	29.529	32.417	-18.31	43.636	54.000	-10.364	AV

Note: Peak Measure Level (dB μ V/m) = Reading Level (dB μ V) + Factor (dB)

Average Measure Level = Peak Measure Level + Duty Cycle Factor

Factor (dB) = Cable Loss (dB) + Antenna Factor (dB/m)

7.5. AC Conducted Emissions Measurement

7.5.1. Test Limit

FCC Part 15 Subpart C Paragraph 15.207 Limits		
Frequency (MHz)	QP (dBuV)	AV (dBuV)
0.15 ~ 0.50	66 ~ 56	56 ~ 46
0.50 ~ 5.0	56	46
5.0 ~ 30	60	50

Note 1: The lower limit shall apply at the transition frequencies.

Note 2: The limit decreases linearly with the logarithm of the frequency in the range 0.15MHz to 0.5MHz.

7.5.2. Test Setup

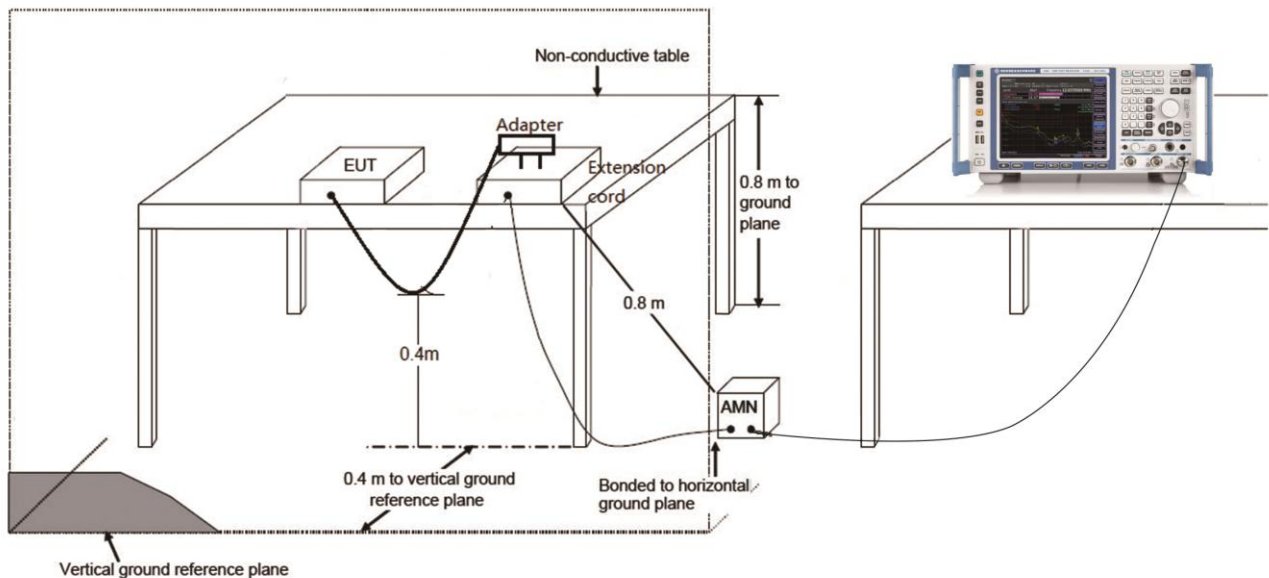

7.5.3. Test Result

The EUT is powered by battery, so this requirement does not apply.

8. CONCLUSION

The data collected relate only the item(s) tested and show that unit is in compliance with Part 15C of the FCC Rules and ISED Rules.

_____ The End _____

Appendix A - Test Setup Photograph

Refer to "1907RSU007-UT" file.

Appendix B - EUT Photograph

Refer to “ 1907RSU007-UE” file.