

Register your product and get support at
www.philips.com/welcome

SCD520



PHILIPS

AVENT

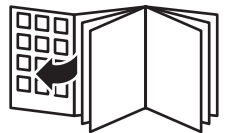

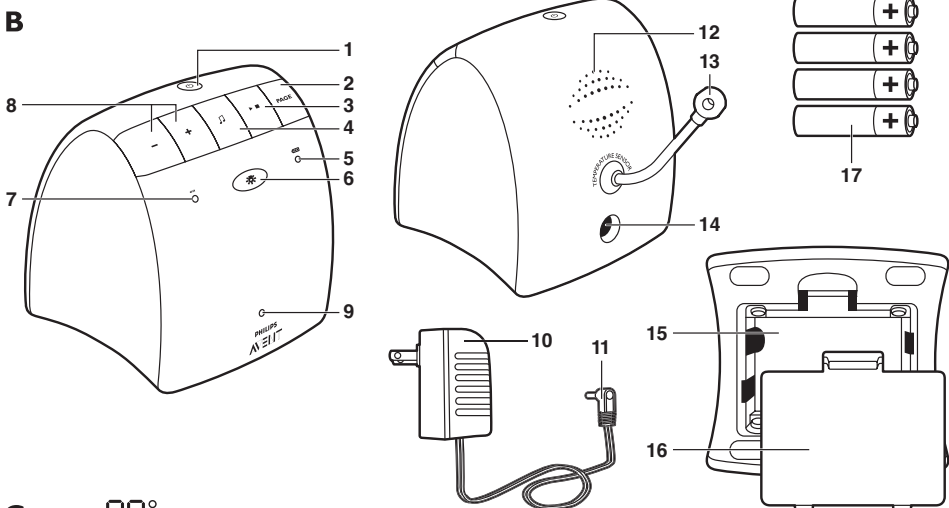
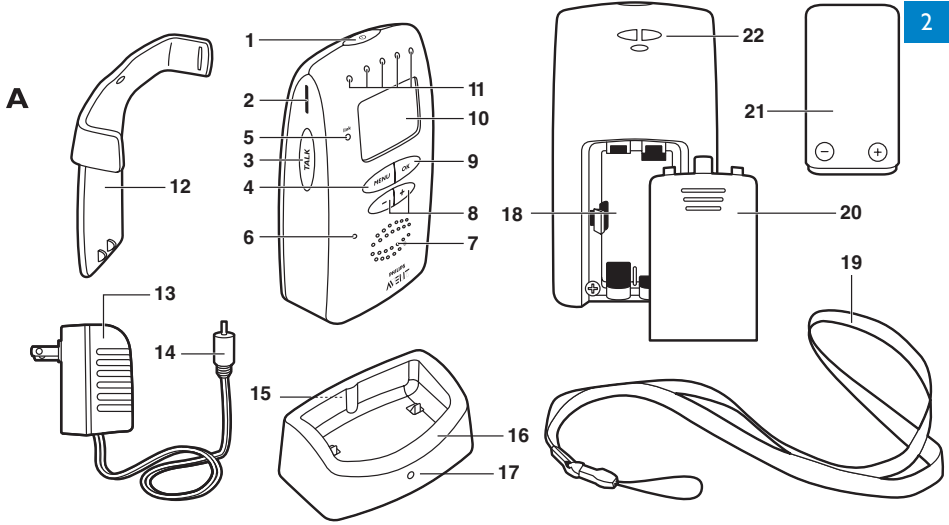

- C**
- 1 — 88°
 - 2 —)))
 - 3 — 🎵
 - 4 — 🔋
 - 5 — ☀️

SCD520

ENGLISH 6

IMPORTANT SAFETY INSTRUCTIONS

Some of the following information may not apply to your particular product; however, when using baby monitor equipment, basic safety precautions should always be followed to reduce the risk of fire, electric shock and injury to persons, including the following:

- 1 Read these instructions.
- 2 Keep these instructions.
- 3 Heed all warnings.
- 4 Follow all instructions.
- 5 Do not use this apparatus near water.
- 6 Clean only with dry cloth.
- 7 Do not block any ventilation openings. Install in accordance with the manufacturer's instructions.
- 8 Do not install near any heat sources such as radiators, heat registers, stoves or other apparatus (including amplifiers) that produce heat.
- 9 Do not defeat the safety purpose of the polarized or grounding-type plug. A polarized plug has two blades with one wider than the other. A grounding-type plug has two blades and a third grounding prong. The wide blade or the third prong are provided for your safety. If the provided plug does not fit into your outlet, consult an electrician for replacement of the obsolete outlet.
- 10 Protect the power cord from being walked on or pinched particularly at plugs, convenience receptacles, and the point where they exit from the apparatus.
- 11 Only use attachments/accessories specified by the manufacturer.
- 12 Unplug this appliance during lightning storms or when not used for long periods of time.
- 13 Refer all servicing to qualified service personnel. Servicing is required when the apparatus has been damaged in any way, such as power-supply cord or plug is damaged, liquid has been spilled or objects have fallen into the apparatus, the apparatus has been exposed to rain or moisture, does not operate normally, or has been dropped.
- 14 This baby monitor is intended as an aid. It is not a substitute for responsible and proper adult supervision and should not be used as such.
- 15 Use this appliance only for its intended use as described in this manual.
- 16 Unplug this product from the wall outlet before cleaning. Do not use liquid cleaners or aerosol cleaners.
- 17 Products should not be used while you are in a bathtub, shower or pool. Immersion of the product in water could cause an electrical shock.
- 18 This product should be operated only from the type of power source indicated on the type plate of the adapters (A15,B9). If you are not sure of the type of power supply to your home, consult your dealer or local power company.

- 19 Do not overload wall outlets and extension cords as this can result in the risk of fire or electric shock.
- 20 Never push objects of any kind into this product through casing slots as they may touch dangerous voltage points or short out parts that could result in a risk of fire or electric shock. Never spill liquid of any kind on the product.
- 21 To reduce the risk of electric shock, do not disassemble this product, but call 1-800-54-AVENT (1-800-542-8368) for assistance. Opening or removing covers (except battery compartment lids) may expose you to dangerous voltage or other risks. Incorrect reassembly can cause electric shock when the appliance is subsequently used.
- 22 To prevent strangulation with power cord, never place monitor within reach of child. Do not use with extension cords.

If your product utilizes batteries, the following additional precautions should be observed:

- 1 Use only the type and size of batteries specified in the user manual.
- 2 Do not dispose of batteries in fire. They may explode. Check with local regulations for possible special disposal instructions.
- 3 Exercise care in handling batteries in order not to short out the batteries with conducting materials such as rings, bracelets and keys. Overcharging, short circuiting, reverse charging, mutilation, or incineration of batteries must be avoided to prevent one or more of the following occurrences: release of toxic materials, release of hydrogen and/or oxygen gas, rise in surface temperature.
- 4 Do not attempt to recharge batteries provided with or identified for use with this product that are not intended to be charged. The batteries may leak corrosive electrolyte or explode.
- 5 Do not attempt to rejuvenate the batteries provided with or identified for use with this product by heating them. Sudden release of battery electrolyte may occur, causing burns or irritation to eyes or skin.
- 6 If and when necessary, the batteries must be replaced with identical new ones from the same manufacturer. If a battery to be replaced is connected with other batteries in series, it is recommended that the other batteries be replaced with new ones at the same time.
- 7 Reverse polarity installation of the batteries in the end product must be avoided. Reverse insertion of batteries can cause charging, and that may result in leakage or explosion.
- 8 Remove batteries from this product if you store the product over 30 days because the batteries could leak and damage the product.
- 9 Discard 'dead' batteries as soon as possible since 'dead' batteries are more likely to leak in a product. If a battery has leaked or vented, it should be replaced immediately using protective gloves.
- 10 Do not store this product, or the batteries provided with or identified for use with this product, in high-temperature areas. Batteries that are stored in a freezer or refrigerator for the purpose of extending shelf life should be protected from condensation during storage and defrosting. Batteries should be stabilized at room temperature prior to use after cold storage.
- 11 If your product uses rechargeable batteries, charge the batteries only in accordance with the instructions and limitations specified in the user manual.

- 12 There is a risk of explosion if batteries are replaced with an incorrect type. For the **parent unit**, always use the SCD520 NiMH **rechargeable** battery pack as supplied with the appliance.

SAVE THESE INSTRUCTIONS



- **CAUTION: THE SYMBOL SHOWN IN FIGURE 1 MEANS THAT THERE IS A RISK OF EXPLOSION OF THE BATTERIES AND/OR OF SERIOUS DAMAGE TO THE BABY MONITOR IF THE BATTERIES OR THE ADAPTER ARE REPLACED WITH AN INCORRECT TYPE.**

Adapters for baby unit and charger:

- Input: 120 VAC 60 Hz
- Output: 7.5 VDC 400 mA
- Adapter no. UD075040B

The socket-outlet shall be installed near the equipment and shall be easily accessible.

For the baby unit, only use 1.5V AA alkaline batteries (batteries not supplied).

For the parent unit, only use the SCD520 NiMH rechargeable battery pack as supplied with the appliance.

Dispose of used batteries according to the instructions.

Compliance information

The FCC ID number is located on the casing bottom of the parent unit and in the battery compartment of the baby unit.

The term 'IC' before the certification number signifies that Industry Canada technical specifications were met. This certification means that the equipment meets certain radio communications and operational requirements. This device complies with Part 15 of the FCC Rules and ICES-003 of Industry Canada. Operation is subject to the following two conditions: (1) this device may not cause harmful interference, and (2) this device must accept any interference received, including interference that may cause undesired operation. This device complies also with RSS-213 of Industry Canada.

Radio interference

This equipment has been tested and found to comply with the limits for a Class B digital device, pursuant to Part 15 of the FCC Rules and applicable Industry Canada specifications. These limits are designed to provide reasonable protection against harmful interference in a residential installation. This equipment generates, uses and can radiate radio frequency energy and, if not installed and used in accordance with the instructions, may cause harmful interference to radio communications. However, there is no guarantee that interference will not occur in a particular installation. If this equipment does cause harmful interference to radio or television reception, which can be determined by turning the equipment off and on, the user is encouraged to try to correct the interference by one or more of the following measures:

- Reorient or relocate the receiving antenna.
- Increase the separation between the equipment and receiver.
- Connect the equipment to an outlet on a circuit different from that to which the receiver is connected.

RF Radiation Exposure Statement

This equipment complies with FCC RF radiation exposure limits set forth for an uncontrolled environment. This equipment should be installed and operated with a minimum distance of 20 centimeters between the radiator and your body. For handheld operation, this equipment has been tested and meets the FCC RF exposure guidelines. For body-worn operation, this product has been tested and meets the FCC RF exposure guideline when used with the belt clip or neck strap supplied with this product. This transmitter must not be co-located or operating in conjunction with any other antenna or transmitter. This equipment also complies with Industry Canada RSS-102 with respect to Canada's Health Code 6 for Exposure of Humans to RF Fields.

Do not attempt to repair or modify this equipment

Any repairs or alterations made by the user to the equipment may void the warranty and compliance of the equipment. Refer servicing to authorized or designated service centers.

Introduction

Congratulations on your purchase and welcome to Philips AVENT! To fully benefit from the support that Philips AVENT offers, register your product at www.philips.com/welcome.

Philips AVENT is dedicated to producing caring, reliable products that give parents the reassurance they need. This Philips AVENT baby monitor provides round-the-clock support by ensuring you can always hear your baby clearly without any distracting noise. The DECT technology guarantees zero interference from other wireless appliances and a crystal clear signal between the baby unit and the parent unit. The temperature sensor enables you to monitor the temperature in your baby's room, and offers you personalized settings to help keep your baby's room comfortable.





General description (Fig. 2)

A Parent unit





- 1 On/off button 
- 2 Slot for belt clip
- 3 TALK button
- 4 MENU button
- 5 LINK light
- 6 Microphone
- 7 Loudspeaker
- 8 Menu and volume +/- buttons
- 9 OK button
- 10 Display
- 11 Sound level lights
- 12 Belt clip
- 13 Adapter
- 14 Small appliance plug

- 15 Socket for small appliance plug
- 16 Charger
- 17 Charging light
- 18 Compartment for rechargeable battery pack
- 19 Neck strap
- 20 Lid of compartment for rechargeable battery pack
- 21 Rechargeable battery pack (included)
- 22 Opening for neck strap

B Baby unit

- 1 On/off button 
- 2 PAGE button
- 3 Play/stop button 
- 4 Lullaby button 
- 5 Battery light 
- 6 Nightlight button 
- 7 Power-on light
- 8 Volume +/- buttons
- 9 Microphone
- 10 Adapter
- 11 Large appliance plug
- 12 Loudspeaker
- 13 Temperature sensor
- 14 Socket for large appliance plug
- 15 Compartment for non-rechargeable batteries
- 16 Lid of compartment for non-rechargeable batteries
- 17 Non-rechargeable batteries (not included)

C Display

- 1  = room temperature indication
- 2  = sound alert
- 3  = lullaby
- 4  = battery symbol
- 5  = nightlight

For other display indications and volume/sensitivity levels, see chapters 'Features' and 'Menu options'.

Important

- Read the user manual carefully before you use the appliance and save it for future reference.
- This baby monitor is intended as an aid. It is not a substitute for responsible and proper adult supervision and should not be used as such.
- This monitor is not intended to be used as a medical monitor and its use should not replace adult supervision.
- Check if the voltage indicated on the adapter corresponds to the local electrical voltage before you connect the appliance.
- Use and store the appliance at a temperature between 50°F (10°C) and 104°F (40°C).
- This appliance is suitable for electrical outlet voltages of 120V.
- Do not expose the baby monitor to extreme cold or heat or to direct sunlight.

- ▶ Make sure the baby unit and power cord are always out of reach of the baby (at least 3 feet / 1 meter away).
- ▶ Never place the baby unit inside the baby's bed or playpen.
- ▶ Never cover the baby monitor with a towel or blanket.
- ▶ Never immerse any part of the baby monitor in water or any other liquid.
- ▶ Never use the baby monitor in moist places or close to water.
- ▶ Except for the battery compartment, do not open the housing of the baby unit and parent unit in order to prevent electric shock.
- ▶ Only use the adapters supplied.
- ▶ The adapters contain a transformer. Do not cut off the adapters to replace them with other plugs, as this will cause a hazardous situation.
- ▶ If one of the adapters is damaged, always have it replaced with one of the original type in order to avoid a hazard.
- ▶ If you place the parent unit next to a transmitter or other DECT appliance (e.g. a DECT telephone), the connection with the baby unit may be lost.
- ▶ The temperature sensor only measures the temperature in the baby's room. It cannot be used to control or adjust the temperature in the baby's room.
- ▶ The power outlet should be located near the appliance and easily accessible.

Preparing for use

Baby unit

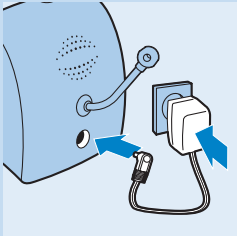

You can use the baby unit corded or on non-rechargeable batteries. Even if you are going to use the unit corded, we advise you to insert the non-rechargeable batteries. This guarantees automatic back-up in case of power failure.

Corded operation

- 1 Put the large appliance plug in the baby unit and put the adapter in a wall socket.
- ▶ The power-on light goes on.

Battery operation (non-rechargeable batteries)

The baby unit runs on four 1.5V R6 AA batteries (not included). We recommend you to use Philips LR6 PowerLife batteries or an equivalent type.

Do not use rechargeable batteries, as the baby unit does not have a charging function.

Unplug the baby unit and make sure your hands and the unit are dry when you insert the non-rechargeable batteries.

- 1 Remove the lid of the compartment for non-rechargeable batteries.

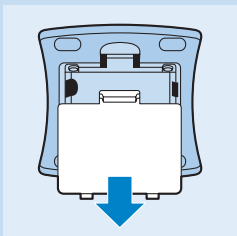

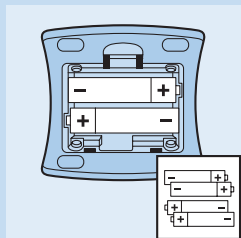

- 2 Insert four non-rechargeable batteries.

Note: Make sure the + and - poles point in the right direction.

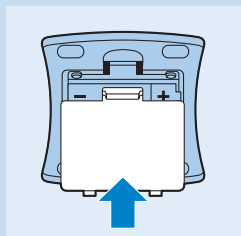

- 3 Reattach the lid.

Note: When the batteries are low, the battery light on the baby unit flashes red.

Parent unit

Battery operation (rechargeable battery pack)

The parent unit comes with a SCD520 NiMH rechargeable battery pack. Charge the parent unit before you use it for the first time or when the parent unit indicates that the battery pack is low (the empty battery symbol flashes on the display and the parent unit beeps). The parent unit starts indicating that the battery pack is low 30 minutes before the battery pack is completely empty.

Note: If the battery pack is completely empty, the parent unit automatically switches off and loses contact with the baby unit.

- 1 Remove the lid of the compartment for the rechargeable battery pack.

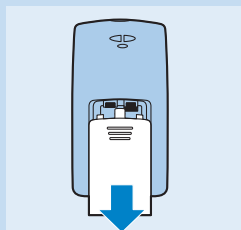

- 2 Insert the rechargeable battery pack.

Note: Make sure the + and - poles of the battery pack point in the right direction.

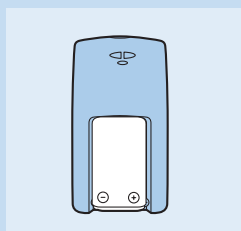

- 3 Reattach the lid.

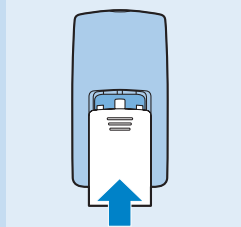

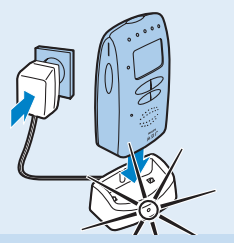

- 4 Insert the small appliance plug into the charger, put the adapter in a wall socket and place the parent unit in the charger.
 - ▶ The charging light on the charger goes on.
 - ▶ The display shows a charging battery symbol to indicate that the parent unit is charging.
- 5 Leave the parent unit in the charger until the battery pack is fully charged.
 - ▶ During charging, the charging light on the charger lights up continuously.
 - ▶ When the battery pack is fully charged, the display of the parent unit shows a full battery symbol .
 - When you charge the parent unit for the first time or after a long period of disuse, switch it off and let it charge continuously for at least 10 hours.
 - Charging normally takes 8 hours, but it takes longer when the parent unit is switched on while charging. To keep the charging time as short as possible, switch off the parent unit during charging.
 - When the battery pack is fully charged, the parent unit can be used cordlessly for at least 24 hours.

Note: When the parent unit is charged for the first time, the operating time is less than 24 hours. The battery pack only reaches its full capacity after you have charged and discharged it four times.

Note: When the parent unit is not connected to a power outlet or even when the parent unit is switched off, the battery pack gradually discharges.

Using the appliance

Use the baby monitor for its intended household use as described in this manual.

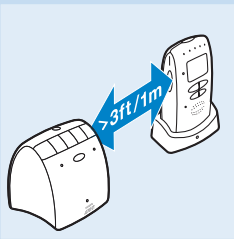

- 1 Place the parent unit and the baby unit in the same room to test the connection.

Make sure the baby unit is at least 3 feet/1 meter away from the parent unit.

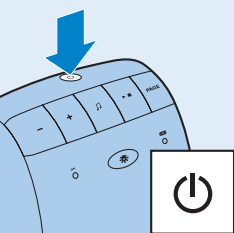

- 2 Press and hold the on/off button  on the baby unit until the green power-on light goes on.

Note: The power-on light always lights up green, even when there is no connection with the parent unit.

- ▶ The nightlight lights up briefly and then goes out again.

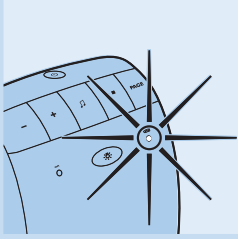

- ▶ The battery light  lights up briefly and then goes out again.

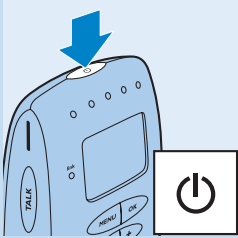

- ▶ Press and hold the on/off button  on the parent unit until the sound level lights light up briefly.

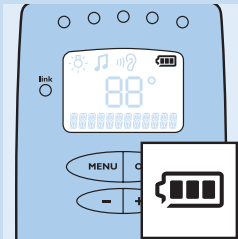

- ▶ The display goes on and the battery symbol appears on the display.

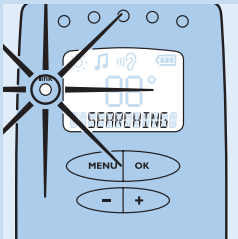

- ▶ The LINK light flashes red and the message 'Searching' appears on the display.

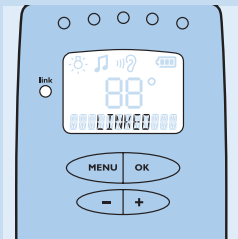

- ▶ The LINK light on the parent unit turns green and lights up continuously when a connection has been established between the baby unit and parent unit. The message 'Linked' appears on the display.

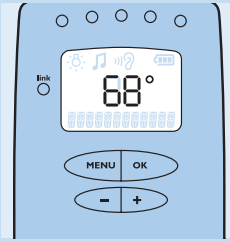

- After 2 seconds the message 'Linked' disappears and the temperature value is shown on the display.

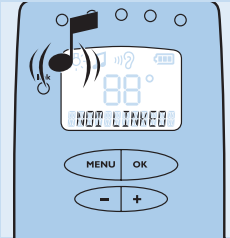

- If no connection is established, the LINK light on the parent unit stops flashing and lights up red. The parent unit beeps from time to time and the message 'Not Linked' appears on the display.

Positioning the baby monitor

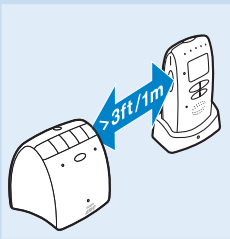

- Place the baby unit at least 3 feet/1 meter away from your baby.

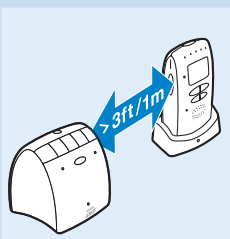

- Place the parent unit within the operating range of the baby unit. Make sure it is at least 3 feet/1 meter away from the baby unit to avoid acoustic feedback.

For more information on the operating range, see section 'Operating range' below.

Operating range

The operating range of the baby monitor is 330 meters/1000 feet in open air. Depending on the surroundings and other disturbing factors, this range may be smaller. Indoors the operating range is up to 50 meters/150 feet.

Dry materials	Material thickness	Loss of range
Wood, plaster, cardboard, glass (without metal, wires or lead)	< 30cm/12in	0-10%
Brick, plywood	< 30cm/12in	5-35%
Reinforced concrete	< 30cm/12in	30-100%
Metal grilles or bars	< 1cm /0.4in	90-100%
Metal or aluminum sheets	< 1cm/0.4in	100%

For wet and moist materials, the range loss may be up to 100%.

Features

The following features are described in chapter 'Menu options', as they can only be operated in the menu of the parent unit:

- Adjusting microphone sensitivity
- Sound alert on/off
- Setting room temperature range (minimum and maximum temperature)
- Temperature alert on/off

Adjusting loudspeaker volume

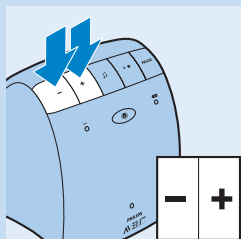

- 1** Press the volume + or – button on the baby unit until the desired loudspeaker volume for the baby unit has been reached.

Note: You can only set the loudspeaker volume on the baby unit when a lullaby is playing.

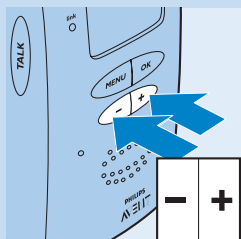

- 2** Press the volume + or – button on the parent unit until the desired loudspeaker volume for the parent unit has been reached.

► The display gives visual feedback on the volume settings of the parent unit:

- = volume switched off/silent baby monitoring
- = minimum volume
- = maximum volume

Note: If the volume is set to a high level, the units consume more power.

Talk function

You can use the TALK button on the parent unit to talk to your baby (e.g. to comfort your baby).

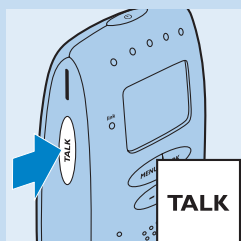

- 1** Press and hold the TALK button and talk clearly into the microphone from a distance of 15-30cm/6-12in.

► The green LINK light starts flashing and the message 'Talk' appears on the display.

- 2** Release the TALK button when you have finished talking.

Sound level lights

The parent unit continuously monitors the sound level in your baby's room and the sound level lights let you know if there is any activity. If your baby cries, you see the sound level lights light up on the parent unit.

- As long as the baby unit does not detect a sound, all sound level lights on the parent unit are out.

- When the baby unit picks up a sound, one or more sound level lights on the parent unit go on. The number of lights that go on is related to the loudness of the sound picked up by the baby unit.

Nightlight

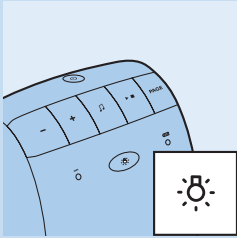

- 1 Press the nightlight button ☀ on the baby unit to switch on the nightlight.
 - ▶ ☀ appears on the display of the parent unit.
- 2 Press the nightlight button ☀ again to switch off the nightlight.
 - ▶ The nightlight dims gradually before it goes out completely.
 - ▶ ☀ disappears from the display of the parent unit.

Tip: Switch off the nightlight when you operate the baby unit on the non-rechargeable batteries. This saves power.

Paging the parent unit

If you have misplaced the parent unit and its volume is switched off, you can use the PAGE button on the baby unit to locate the parent unit.

Note: The paging function only works when the parent unit is switched on.

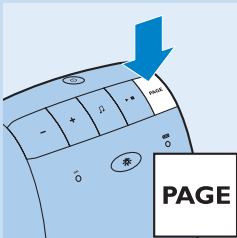

- 1 Press the PAGE button on the baby unit.
 - ▶ The message 'Paging' appears on the display of the parent unit.
 - ▶ The parent unit produces a paging alert tone.
- 2 To stop the paging alert tone, press the PAGE button again or press any button on the parent unit.

Lullaby function

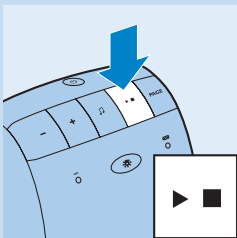

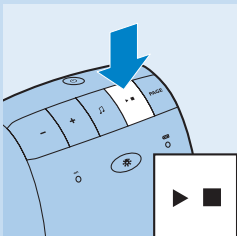

- 1 Press the play/stop button ▶■ on the baby unit to play the currently selected lullaby.
 - ▶ The lullaby starts to play and repeats continuously.

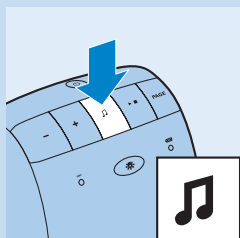

- 2 To stop the lullaby, press the play/stop button ▶■ on the baby unit again.



3 To select another lullaby when a lullaby is playing:

- Press the lullaby button  on the baby unit.
- Wait 2 seconds for the next lullaby to start.
- If you want another lullaby, press the lullaby button  on the baby unit again.

Out of range alert

When the parent unit is out of range of the baby unit, the parent unit beeps from time to time and the message 'Not linked' appears on the display. The LINK light on the parent unit flashes red.

Note: The message 'Not Linked' also appears on the display of the parent unit when the baby unit is switched off.

Menu options

The following functions are operated in the menu of the parent unit.

Menu operation - general explanation

Note: Menu functions can only be operated when a connection has been established between the baby unit and the parent unit.

- 1 Press the MENU button to open the menu.
 - ▶ The first menu option appears on the display.

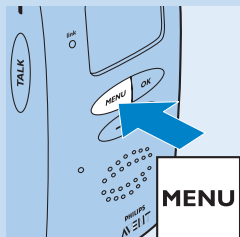

- 2 Use the – and + buttons to select the desired menu option.

Note: The arrow indicates in which direction you can navigate.

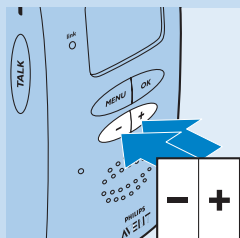

- 3 Press the OK button to confirm.

- 4 Use the + and - buttons to select the desired setting.

- 5 Press the OK button to confirm.

- ▶ The new setting flashes twice and then disappears from the display.

- 6 Press the MENU button again to exit the menu.

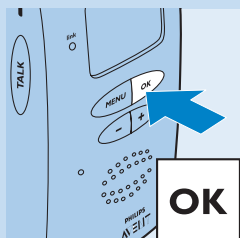

Adjusting microphone sensitivity

You can set the microphone sensitivity of the baby unit to the desired level. You can only change the microphone sensitivity when a connection between the baby unit and the parent unit has been established, i.e. when the LINK light on the parent unit lights up green continuously.

- 1 Select 'Sensitivity' with the + and - buttons.
- 2 Press the OK button to confirm.
- 3 Select the desired microphone sensitivity level for the baby unit with the + and - buttons.
 - ▶ = minimum sensitivity level
 - ▶ = maximum sensitivity level
- 4 Press the OK button to confirm.
 - ▶ The message 'Saved' appears on the display.

Note: When the microphone sensitivity of the baby unit is set to a high level, it picks up more sounds and therefore transmits more often. As a result, the units consume more power.

Sound alert on/off

This feature allows you to monitor your baby silently. It enables you to switch off the volume on your parent unit and still be alerted if your baby cries.

If the sound alert is switched on, the parent unit beeps as soon as the fourth sound level light lights up blue while the volume is switched off. In addition, the backlight of the parent unit display goes on and the sound alert symbol () flashes on the display.

- 1 Select 'Sound Alert' with the + and - buttons.
- 2 Press the OK button to confirm.
- 3 If the alert is off, the display shows 'On?'. Press the OK button to switch on the alert. If the alert is on, the display shows 'Off?'. Press the OK button to switch off the alert.
 - ▶ If you have set the sound alert to 'on', the sound alert symbol () appears on the display of the parent unit.

Setting room temperature range

A baby will sleep comfortably in a room heated to a temperature between 61°F and 68°F. This is important, since a baby cannot regulate its body temperature as well as an adult. A baby needs more time to adjust to temperature changes.

If you do not set a temperature range, the baby monitor alerts you when the temperature in your baby's room drops below 57°F or rises above 86°F. In this case, the backlight of the parent unit display goes on and 'High' or 'Low' appears on the display. To change the default minimum and maximum temperature, follow the instructions below.

Note: The temperature of the baby's room is shown on the display of the parent unit when they are linked.

- 1 Select 'Temperature' with the + and - buttons.
- 2 Press the OK button to confirm.

- 3 Select 'Range' with the + and - buttons.
- 4 Press the OK button to confirm.
- 5 Set the desired minimum temperature with the + and - buttons.
- 6 Press the OK button to confirm.
- 7 Set the desired maximum temperature with the + and - buttons.
- 8 Press the OK button to confirm.
- ▶ The message 'Saved' appears on the display.

Note: If the temperature in the baby's room drops below or exceeds the set temperature range, the display of the parent unit is on continuously. This causes the unit to consume more power.

Temperature alert on/off

Note: If the temperature alert is activated too often, reduce the set minimum temperature and/or increase the set maximum temperature (see 'Setting room temperature range').

If the temperature alert is switched on, the parent unit beeps if the actual room temperature exceeds the set maximum temperature or drops below the set minimum temperature. In addition, the backlight of the parent unit display goes on and 'High' or 'Low' appears on the display. If no minimum and maximum temperatures have been set, the temperature alert is given when the room temperature drops below 57°F or rises above 86°F.

- 1 Select 'Temperature' with the + and - buttons.
- 2 Press the OK button to confirm.
- 3 Select 'Alert' with the + and - buttons.
- 4 Press the OK button to confirm.
- 5 If the alert is off, the display shows 'On?'. Press the OK button to switch on the alert. If the alert is on, the display shows 'Off?'. Press the OK button to switch off the alert.

Reset function

This function in the menu of the parent unit allows you to reset both the parent unit and the baby unit to the default settings at the same time. You can use this function if problems occur that you cannot solve by following the suggestions in chapter 'Frequently asked questions'.

- 1 Select 'Reset' with the + and - buttons.
- 2 Press the OK button to confirm.
- ▶ The message 'Confirm?' appears on the display of the parent unit.
- 3 Press the OK button to confirm.
- ▶ The parent unit switches off and then switches on again.
- ▶ The units have now both been reset to the default factory settings.

Default settings

Parent unit

- Loudspeaker volume: 1
- Microphone sensitivity: 3
- Sound alert: off

- Temperature alert: off
- 'Temperature low' alert: 57°F
- 'Temperature high' alert: 86°F

Baby unit

- Loudspeaker volume: 3
- Nightlight: off
- Lullaby: 1

Accessories

Belt clip and neck strap

If the battery pack of the parent unit is sufficiently charged, you can take the unit with you inside and outside the house if you attach the unit to your belt or waistband with the belt clip or if you hang it around your neck with the neck strap. This allows you to monitor your baby while you are moving around.

Connecting the belt clip

- 1 Snap the belt clip onto the parent unit.

Disconnecting the belt clip

- 1 Pull the belt clip off the parent unit.

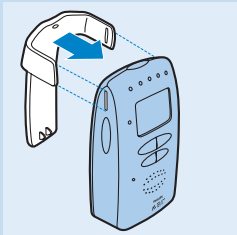

Connecting the neck strap

- 1 Insert the end loop of the neck strap through the hole behind the strap post. Thread the neck strap through the end loop and pull the neck strap tight.

Disconnecting the neck strap

- 1 Pass the neck strap through the end loop and pull the end loop out of the hole behind the strap post.

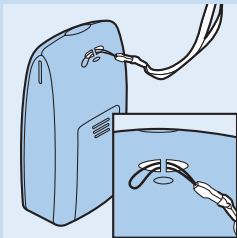

Cleaning and maintenance

Do not immerse the parent unit or the baby unit in water and do not clean them under the tap.

Do not use cleaning spray or liquid cleaners.

- 1 Unplug the baby unit if it is connected to an electrical outlet and take the parent unit out of the charger.

- 2 Clean the parent unit and the baby unit with a damp cloth.

Make sure the parent unit is dry before you put it back into the plugged-in charger.

- 3 Clean the charger with a dry cloth.

- 4 Clean the adapters with a dry cloth.

This appliance has no other user-serviceable parts. For assistance call 1-800-54-AVENT (1-800-542-8368).

Storage

- When you are not going to use the baby monitor for some time, remove the non-rechargeable batteries from the baby unit and the rechargeable battery pack from the parent unit. Store the parent unit, the baby unit, the charger of the parent unit and the adapters in a cool and dry place.
- Do not wrap cord around the monitor when storing. Store cord in a safe location where it will not be cut or damaged.

Replacement

Baby unit

Batteries

Only replace the non-rechargeable batteries of the baby unit with four non-rechargeable 1.5V R6 AA batteries.

Note: We recommend you to use Philips non-rechargeable batteries or an equivalent type.

Adapter

Only replace the adapter of the baby unit with an adapter of the original type. For assistance call 1-800-54-AVENT (1-800-542-8368) or visit our website: www.philips.com/AVENT.

Parent unit

Batteries

Only replace the SCD520 NiMH rechargeable battery pack of the parent unit with a pack of the original type. For assistance, call 1-800-54-AVENT (1-800-542-8368) or visit our website: www.philips.com/AVENT.

Adapter

Only replace the adapter of the parent unit charger with an adapter of the original type. For assistance call 1-800-54-AVENT (1-800-542-8368) or visit our website: www.philips.com/AVENT.

Assistance

For assistance call 1-800-54-AVENT (1-800-542-8368) or visit our website: www.philips.com/AVENT.

Environment



- Dispose of batteries properly. Do not incinerate. Batteries may explode if overheated. Do not wrap in metal or aluminum foil. Wrap in newspaper before discarding.
- It is suggested that you contact your local town or city to determine proper battery redemption site(s) in your area.

Warranty

FULL TWO YEAR WARRANTY

Philips Electronics North America Corporation (USA) and Philips Electronics Ltd (CANADA) warrant each new Philips AVENT product, model SCD520/00, against defects in materials or workmanship for a period of two years from the date of purchase, and agrees to repair or replace any defective product without charge. **IMPORTANT:** This warranty does not cover damage resulting from accident, misuse or abuse, lack of reasonable care, or the affixing of any attachment not provided with the product. **NO RESPONSIBILITY IS ASSUMED FOR ANY SPECIAL, INCIDENTAL OR CONSEQUENTIAL DAMAGES.** In order to obtain warranty service, simply call toll-free 1-800-54-AVENT.

Frequently asked questions

This chapter lists the questions most frequently asked about the appliance. If you cannot find the answer to your question, call 1-800-54-AVENT (1-800-542-8368) for assistance.

Question

Answer

Why don't both the power-on light of the baby unit and the LINK light of the parent unit come on when I press the on/off buttons of the units?

Perhaps the battery pack of the parent unit are empty and the parent unit is not in the plugged-in charger. Insert the small appliance plug into the charger; put the adapter of the charger in a wall socket and place the parent unit in the charger. Then press the on/off button to establish connection with the baby unit.

Perhaps the non-rechargeable batteries of the baby unit are empty and the baby unit is not connected to an electrical outlet. Replace the non-rechargeable batteries or connect the baby unit to an electrical outlet. Then press the on/off button to establish connection with the parent unit.

The baby unit and the parent unit may be out of range of each other. Move the parent unit closer to the baby unit, but not closer than 3 feet/1 meter.

If the LINK light on the parent unit still does not start to flash, use the reset function to reset the units to their default settings.

Why does the LINK light on the parent unit light up red continuously and why is the message 'Not Linked' shown on the display?

The baby unit and the parent unit are out of range of each other. Move the parent unit closer to the baby unit.

The baby unit may be switched off. Switch on the baby unit.

Why does the battery light on the baby unit flash red?

The non-rechargeable batteries of the baby unit are running low. Replace the non-rechargeable batteries or connect the baby unit to an electrical outlet (see chapter 'Preparing for use').

Question	Answer
Why does the parent unit beep?	If the parent unit beeps while the LINK light lights up red continuously and the message 'Not Linked' is shown on the display, the connection with the baby unit is lost. Move the parent unit closer to the baby unit.
	If the parent unit beeps and the battery symbol on the display is empty, the rechargeable battery pack of the parent unit is running low. Recharge the battery pack.
	If you have switched off the volume while the sound alert is on, the parent unit beeps whenever the fourth sound level light lights up because the baby unit has picked up a sound.
	If you have set the room temperature range on the parent unit and the temperature alert is on, the parent unit beeps when the temperature drops below the set level or below 57°F or when the temperature rises above the set level or above 86°F.
	The baby unit may be switched off. Switch on the baby unit.
Why does the appliance produce a high-pitched noise?	The units may be too close to each other. Make sure the parent unit and the baby unit are at least 3 feet/1 meter away from each other.
	The volume of the parent unit may be set too high. Decrease the volume of the parent unit.
Why don't I hear a sound/ Why can't I hear my baby cry?	The volume of the parent unit may be set too low or may be switched off. Increase the volume of the parent unit.
	The microphone sensitivity level of the baby unit may be set too low. Set the microphone sensitivity level to a higher level in the menu of the parent unit.
	The baby unit and the parent unit may be out of range of each other. Reduce the distance between the units.
Why does the parent unit react too quickly to other sounds?	The baby unit also picks up other sounds than those of your baby. Move the baby unit closer to the baby (but observe the minimum distance of 3 feet/1 meter).
	The microphone sensitivity level of the baby unit may be set too high. Decrease the microphone sensitivity level in the menu of the parent unit.
Why does the parent unit react slowly to the baby's crying?	The microphone sensitivity level of the baby unit may be set too low. Increase the microphone sensitivity level in the menu of the parent unit.
Why do the non-rechargeable batteries of the baby unit run low quickly?	The microphone sensitivity level of the baby unit may be set too high, which causes the baby unit to transmit more often. Decrease the microphone sensitivity level in the menu of the parent unit.
	The volume on the baby unit may be set too high, which causes the baby unit to consume a lot of energy. Decrease the volume of the baby unit.

Question	Answer
	You may have set a maximum room temperature that is lower than the actual room temperature or a minimum room temperature that is higher than the actual room temperature. The baby unit continues to send data to the parent unit and therefore uses more power. This causes the non-rechargeable batteries of the baby unit to run low quickly.
	Perhaps you have switched on the nightlight. If you want to use the nightlight, we advise you to run the baby unit on electrical power.
Why does the charging time of the parent unit exceed 8 hours?	The parent unit may be switched on during charging. Switch off the parent unit during charging.
The specified operating range of the baby monitor is 330 meters/1000 feet. Why does my baby monitor manage a much smaller distance than that?	The specified range is only valid outdoors in open air. Inside your house, the operating range is limited by the number and type of walls and/or ceilings in between. Inside the house, the operating range is up to 50 meters/150 feet.
Why is the connection lost every now and then? Why are there sound interruptions?	The baby unit and the parent unit are probably close to the outer limits of the operating range. Try a different location or decrease the distance between the units. Please note that it takes about 30 seconds each time before a connection between the units is established.
What happens during a power failure?	If the parent unit is sufficiently charged, it continues to operate during a power failure, both inside and outside the charger. If there are batteries in the baby unit, it also continues to operate during a power failure.
Is my baby monitor secure from eavesdropping and interference?	The DECT technology of this baby monitor guarantees no interference from other equipment and no eavesdropping.
The operating time of the parent unit is supposed to be at least 24 hours. Why is the operating time of my parent unit shorter?	When the parent unit has been charged for the first time, the operating time is less than 24 hours. The rechargeable battery pack only reaches its full capacity after you have charged and discharged it at least four times.
	The volume of the parent unit may be set too high, which causes the parent unit to consume a lot of energy. Decrease the volume of the parent unit.
	The microphone sensitivity level of the baby unit may be set too high, which causes the parent unit to consume a lot of energy. Decrease the microphone sensitivity level in the menu of the parent unit.
Why doesn't the battery symbol appear on the display of the parent unit when I start to recharge the parent unit?	It may take a few minutes before the battery symbol appears on the display of the parent unit when you charge the parent for the first time or after a long period of disuse.



PHILIPS

EC DECLARATION OF CONFORMITY

Philips Domestic Appliances and Personal Care
 The aspects radio, EMC and safety have been investigated by the
 Competent Body CETECOM.
 The results have been laid down in the report series 4-2545-xxx

Ref: DOC-SCD530

Date: 5 Jun, 2008

By: Phoebe Cheng

We, PHILIPS DOMESTIC APPLIANCES AND PERSONAL CARE BV
 (Manufacturer's name)

Tussendiepen 4, 9206 AD DRACHTEN, The Netherlands
 (Manufacturer's address)

declare under our responsibility that the electrical products:

Philips

SCD510, SCD520, SCD530

(Name)

(Type or model)

Baby Monitor
 (Product description)

To which this declaration relates is in conformity with the following harmonized standards:

EN60950-1:2001 + am 11: 2004	EN 50371 : 2002	ETSI EN 301 489-1 V1.6.1 (2005-09)
		ETSI EN 301 489-6 V1.2.1 (2002-08)
		ETSI EN 301 406 V 1.5.1 (2003-07)

Year in which the CE-mark was affixed: (2008)

Following the provisions of 1999/5/EC (R&TTE Directive)

and are produced under a quality scheme at least in conformity with ISO 9001 or CENELEC
 Permanent Documents

For the CoC

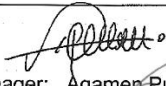
Signature: 

Name Quality Manager: Agamen Pun

Date: 5 Jun, 2008

For DAP

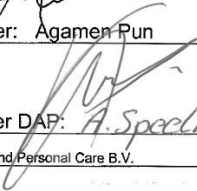
Signature: 

Name Quality Manager DAP: A. Speelman

Date: 10 jun, 2008

© Philips Domestic Appliances and Personal Care B.V.
 DHV 999-0304 d8

Corporate Quality Support



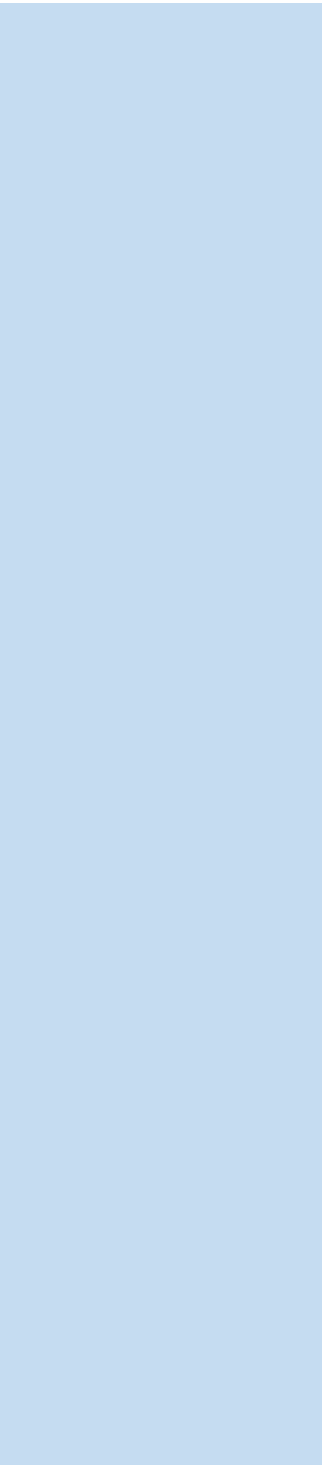



Manufactured for: Philips Consumer Lifestyle,
a division of Philips Electronics North America Corporation.
1600 Summer Street, 5 Fl., Stamford,
CT 06905-5125

CE 0682

www.philips.com/AVENT

4222.002.7190.1