

FCC and ISED Test Report

Apple Inc
Model: A2843

In accordance with FCC 47 CFR Part 15B, ICES-003 and ISED RSS-GEN
(2.4 GHz Bluetooth, Thread, 2.4 GHz WLAN and 5 GHz WLAN)

Prepared for: Apple Inc
One Apple Park Way, Cupertino
California, 95014, USA



Add value.
Inspire trust.

FCC ID: BCGA2843

IC: 579C-A2843

COMMERCIAL-IN-CONFIDENCE

Document 75954422-24 Issue 01

SIGNATURE

| NAME | JOB TITLE | RESPONSIBLE FOR | ISSUE DATE |
|---------------|---------------------|----------------------|-------------------|
| Andrew Lawson | Chief Engineer, EMC | Authorised Signatory | 28-September-2022 |

Signatures in this approval box have checked this document in line with the requirements of TÜV SÜD document control rules.

ENGINEERING STATEMENT

The measurements shown in this report were made in accordance with the procedures described on test pages. All reported testing was carried out on a sample equipment to demonstrate limited compliance with FCC 47 CFR Part 15B, ICES-003 and ISED RSS-GEN. The sample tested was found to comply with the requirements defined in the applied rules.

| RESPONSIBLE FOR | NAME | DATE | SIGNATURE |
|-------------------|----------------|-------------------|-----------|
| Report Generation | Lauren Walters | 28-September-2022 | |

FCC Accreditation
90987 Octagon House, Fareham Test Laboratory

ISED Accreditation
12669A Octagon House, Fareham Test Laboratory

EXECUTIVE SUMMARY

A sample of this product was tested and found to be compliant with FCC 47 CFR Part 15B: 2020, ICES-003: Issue 7: 2020 and ISED RSS-GEN: Issue 5 (04-2018) + A2 (02-2021) for the tests detailed in section 1.3.



DISCLAIMER AND COPYRIGHT

This non-binding report has been prepared by TÜV SÜD with all reasonable skill and care. The document is confidential to the potential Client and TÜV SÜD. No part of this document may be reproduced without the prior written approval of TÜV SÜD. © 2022 TÜV SÜD. This report relates only to the actual item/items tested.

ACCREDITATION

Our UKAS Accreditation does not cover opinions and interpretations and any expressed are outside the scope of our UKAS Accreditation. Results of tests not covered by our UKAS Accreditation Schedule are marked NUA (Not UKAS Accredited).

TÜV SÜD
is a trading name of TÜV SÜD Ltd
Registered in Scotland at East Kilbride,
Glasgow G75 0QF, United Kingdom
Registered number: SC215164

TÜV SÜD Ltd is a
TÜV SÜD Group Company

Phone: +44 (0) 1489 558100
Fax: +44 (0) 1489 558101
www.tuvsud.com/en

TÜV SÜD
Octagon House
Concorde Way
Fareham
Hampshire PO15 5RL
United Kingdom



Contents

| | | |
|----------|--|-----------|
| 1 | Report Summary | 2 |
| 1.1 | Report Modification Record..... | 2 |
| 1.2 | Introduction..... | 2 |
| 1.3 | Brief Summary of Results | 3 |
| 1.4 | Product Information | 4 |
| 1.5 | Deviations from the Standard..... | 4 |
| 1.6 | EUT Modification Record | 4 |
| 1.7 | Test Location | 5 |
| 2 | Test Details | 6 |
| 2.1 | Conducted Disturbance at Mains Terminals | 6 |
| 2.2 | Radiated Disturbance..... | 11 |
| 3 | Incident Reports | 18 |
| 4 | Measurement Uncertainty | 19 |



1 Report Summary

1.1 Report Modification Record

Alterations and additions to this report will be issued to the holders of each copy in the form of a complete document.

| Issue | Description of Change | Date of Issue |
|-------|-----------------------|-------------------|
| 1 | First Issue | 28-September-2022 |

Table 1

1.2 Introduction

| | |
|-------------------------------|--|
| Applicant | Apple Inc |
| Manufacturer | Apple Inc |
| Model Number(s) | A2843 |
| Serial Number(s) | V09QYNPXN6 and YWL2C4T4WY |
| Hardware Version(s) | REV 1.0 |
| Software Version(s) | 20J42560n |
| Number of Samples Tested | 2 |
| Test Specification/Issue/Date | FCC 47 CFR Part 15B: 2020 ICES-003: Issue 7: 2020 ISED RSS-GEN: Issue 5 (04-2018) + A2 (02-2021) |
| Order Number | 540246998 |
| Date of Receipt of EUT | 01-July-2022 |
| Start of Test | 30-August-2022 |
| Finish of Test | 15-September-2022 |
| Name of Engineer(s) | James Cumming, Mohammad Malik, Colin Brain, Thomas Randall, Taha Shafique and Elliot Callender |
| Related Document(s) | ANSI C63.4: 2014 |



1.3 Brief Summary of Results

A brief summary of the tests carried out in accordance with FCC 47 CFR Part 15B, ICES-003 and ISED RSS-GEN is shown below.

| Section | Specification Clause | | | Test Description | Result | Comments/Base Standard |
|---|----------------------|----------|---------|--|--------|------------------------|
| | Part 15B | ICES-003 | RSS-GEN | | | |
| Configuration and Mode: AC Powered - Transmitter Idle | | | | | | |
| 2.1 | 15.107 | 3.1 | 8.8 | Conducted Disturbance at Mains Terminals | Pass | ANSI C63.4: 2014 |
| 2.2 | 15.109 | 3.2 | 7.1 | Radiated Disturbance | Pass | ANSI C63.4: 2014 |

Table 2



1.4 Product Information

1.4.1 Technical Description

The equipment under test was an Apple TV Set Top Box with Bluetooth®, Thread and IEEE 802.11 a/b/g/n/ac/ax Wi-Fi capabilities in the 2.4GHz and 5GHz bands.

1.4.2 EUT Port/Cable Identification

| Port | Max Cable Length specified | Usage | Type | Screened |
|---|----------------------------|-------|----------------------|----------|
| Configuration and Mode: AC Powered - Transmitter Idle | | | | |
| AC Power Port | 2 m | Power | 115 V 60 Hz AC Power | No |

Table 3

1.4.3 Test Configuration

| Configuration | Description |
|---------------|--|
| AC Powered | The EUT was powered by 115 V 60 Hz AC Mains. A switchbox was used to terminate the ethernet port. A switchbox was used to terminate the HDMI port. |

Table 4

1.4.4 Modes of Operation

| Mode | Description |
|------------------|---|
| Transmitter Idle | The EUT was powered on and configured to have all transmitters disabled. As there was no display output from the EUT, access to exercise the EUT was limited. |

Table 5

1.5 Deviations from the Standard

No deviations from the applicable test standard were made during testing.

1.6 EUT Modification Record

The table below details modifications made to the EUT during the test programme.

The modifications incorporated during each test are recorded on the appropriate test pages.

| Modification State | Description of Modification still fitted to EUT | Modification Fitted By | Date Modification Fitted |
|---|---|------------------------|--------------------------|
| Model: A2843, Serial Number: YWL2C4T4WY | | | |
| 0 | As supplied by the customer | Not Applicable | Not Applicable |
| Model: A2843, Serial Number: V09QYNPXN6 | | | |
| 0 | As supplied by the customer | Not Applicable | Not Applicable |

Table 6



1.7 Test Location

TÜV SÜD conducted the following tests at our Fareham Test Laboratory.

| Test Name | Name of Engineer(s) | Accreditation |
|---|---------------------|---------------|
| Configuration and Mode: AC Powered - Transmitter Idle | | |
| Conducted Disturbance at Mains Terminals | James Cumming | UKAS |

Table 7

Office Address:

TÜV SÜD
Octagon House
Concorde Way
Fareham
Hampshire
PO15 5RL
United Kingdom

TÜV SÜD conducted the following tests at our Concorde Park Test Laboratory.

| Test Name | Name of Engineer(s) | Accreditation |
|---|---|---------------|
| Configuration and Mode: AC Powered - Transmitter Idle | | |
| Radiated Disturbance | Mohammad Malik, Colin Brain, Thomas Randall, Taha Shafique and Elliot Callender | UKAS |

Table 8

Office Address:

TÜV SÜD
Concorde Park
Concorde Way
Fareham
Hampshire
PO15 5FG
United Kingdom



2 Test Details

2.1 Conducted Disturbance at Mains Terminals

2.1.1 Specification Reference

FCC 47 CFR Part 15B, Clause 15.107
ICES-003, Clause 3.1
ISED RSS-GEN, Clause 8.8

2.1.2 Equipment Under Test and Modification State

A2843, S/N: V09QYNPXN6 - Modification State 0

2.1.3 Date of Test

15-September-2022

2.1.4 Test Method

The EUT was setup according to ANSI C63.4, clause 5.2.

The EUT was placed on a non-conductive table 0.8 m above a reference ground plane. A vertical coupling plane was placed 0.4 m from the EUT boundary. A Line Impedance Stabilisation Network (LISN) was directly bonded to the ground-plane. The EUT was located so that the distance between the boundary of the EUT and the closest surface of the LISN was 0.8 m.

Interconnecting cables that hanged closer than 0.4 m to the ground plane were folded back and forth in the centre forming a bundle 0.3 m to 0.4 m long.

Input and output cables were terminated with equipment or loads representative of real usage conditions.

The EUT was configured to give the highest level of emissions within reason of a typical installation as described by the manufacturer.

2.1.5 Example Calculation

Quasi-Peak level (dB μ V) = Receiver level (dB μ V) + Correction Factor (dB)
Margin (dB) = Quasi-Peak level (dB μ V) - Limit (dB μ V)

CISPR Average level (dB μ V) = Receiver level (dB μ V) + Correction Factor (dB)
Margin (dB) = CISPR Average level (dB μ V) - Limit (dB μ V)

2.1.6 Test Setup Diagram

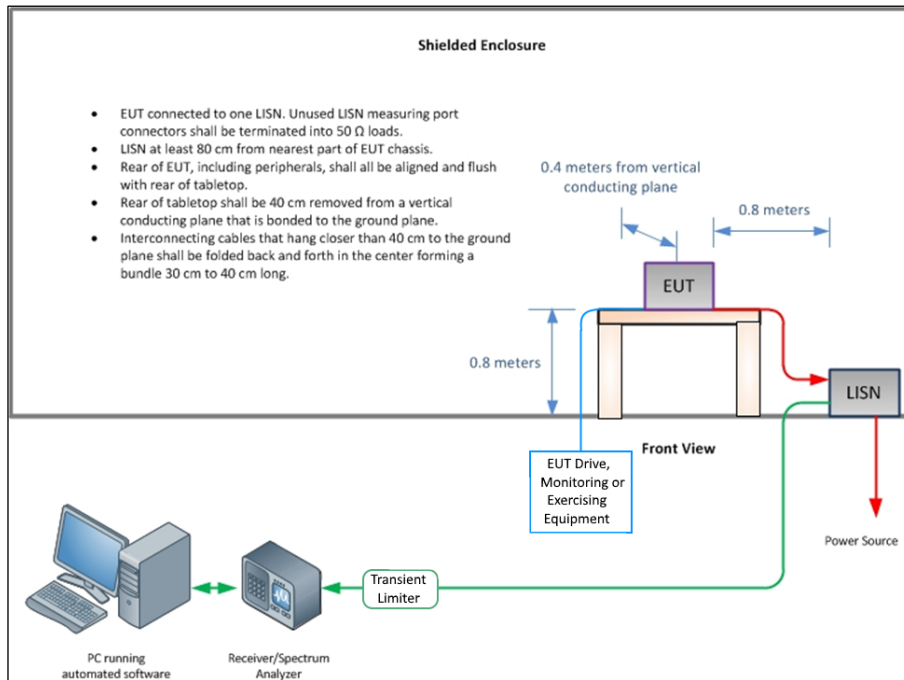

Figure 1 - Conducted Emissions

2.1.7 Environmental Conditions

Ambient Temperature 20.8 °C
 Relative Humidity 55.3 %
 Atmospheric Pressure 1013.0 mbar

2.1.8 Specification Limits

| Required Specification Limits - Class B | | | |
|---|-----------------------|------------------------------|---------------------------------|
| Line Under Test | Frequency Range (MHz) | Quasi-Peak Test Limit (dBµV) | CISPR Average Test Limit (dBµV) |
| AC Power Port | 0.15 to 0.5 | 66 to 56 ⁽¹⁾ | 56 to 46 ⁽¹⁾ |
| | 0.5 to 5 | 56 | 46 |
| | 5 to 30 | 60 | 50 |

Supplementary information:
 Note 1. Decreases with the logarithm of the frequency.

Table 9



2.1.9 Test Results

Results for Configuration and Mode: 115 V AC Powered - Transmitter Idle.

This test was performed to the requirements of the Class B limits.

Performance assessment of the EUT made during this test: Pass.

Detailed results are shown below.

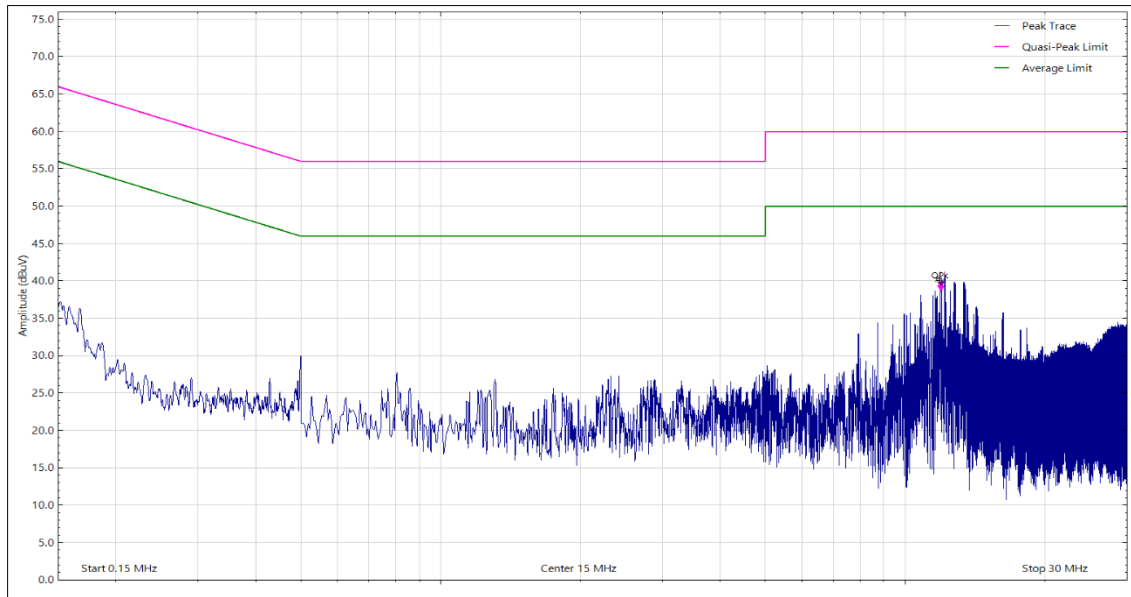

Figure 2 - Graphical Results - Live

| Frequency (MHz) | Level (dBuV) | Limit (dBuV) | Margin (dB) | Detector | Angle (°) | Height (cm) | Polarisation |
|-----------------|--------------|--------------|-------------|-----------|-----------|-------------|--------------|
| 11.953 | 38.9 | 60.0 | -21.1 | Q-Peak | 0 | 100 | Horizontal |
| 11.953 | 38.3 | 50.0 | -11.7 | CISPR Avg | 0 | 100 | Horizontal |

Table 10

No other final measurements were made as all other peak emissions seen above the measurement system noise floor during the pre-scan were greater than 6 dB below the CISPR Average test limit.

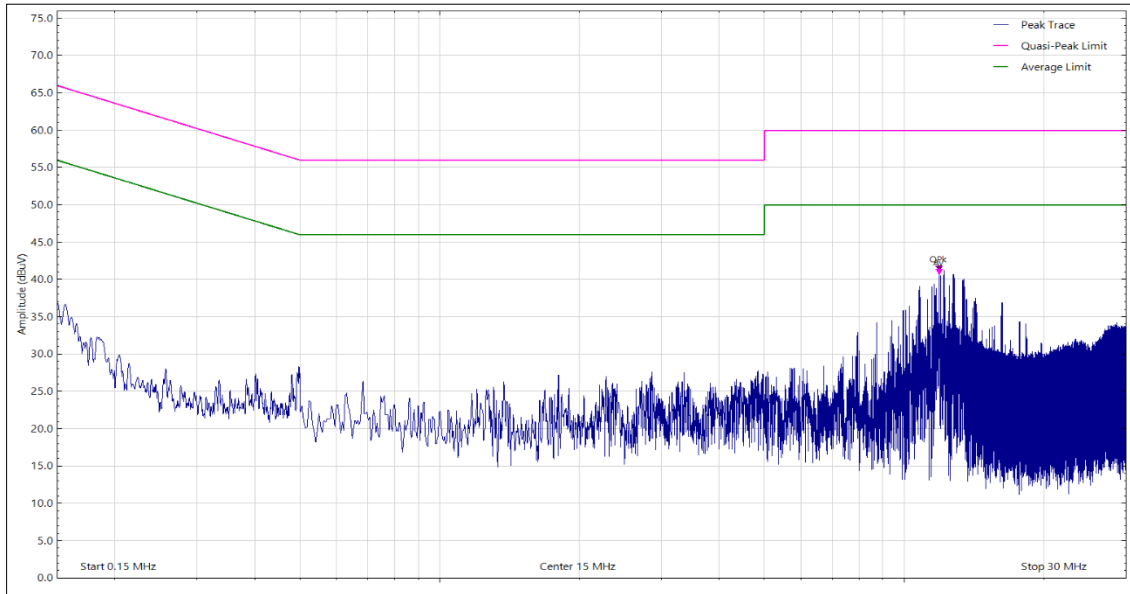

Figure 3 - Graphical Results - Neutral

| Frequency (MHz) | Level (dBuV) | Limit (dBuV) | Margin (dB) | Detector | Angle (°) | Height (cm) | Polarisation |
|-----------------|--------------|--------------|-------------|-----------|-----------|-------------|--------------|
| 11.894 | 40.8 | 60.0 | -19.2 | Q-Peak | 0 | 100 | Horizontal |
| 11.894 | 40.4 | 50.0 | -9.6 | CISPR Avg | 0 | 100 | Horizontal |

Table 11

No other final measurements were made as all other peak emissions seen above the measurement system noise floor during the pre-scan were greater than 6 dB below the CISPR Average test limit.



2.1.10 Test Location and Test Equipment Used

This test was carried out in EMC Chamber 12.

| Instrument | Manufacturer | Type No | TE No | Calibration Period (months) | Calibration Expires |
|-------------------------------|-----------------|--------------------|-------|-----------------------------|---------------------|
| Screened Room (12) | MVG | EMC-3 | 5621 | 36 | 11-Aug-2023 |
| Emissions Software | TUV SUD | EmX V3.1.4 | 5125 | - | Software |
| Test Receiver | Rohde & Schwarz | ESU40 | 3506 | 12 | 25-Mar-2023 |
| Transient Limiter | Hewlett Packard | 11947A | 2377 | 12 | 28-Feb-2023 |
| Termination (50ohm) | Meca | 405-1 | 3517 | 12 | 16-Dec-2022 |
| Cable (SMA to SMA, 2 m) | Rhophase | 3PS-1801A-2000-3PS | 4113 | 12 | 27-Jan-2023 |
| Cable (N-Type to N-Type, 8 m) | Teledyne | PR90-088-8MTR | 5450 | 6 | 06-Oct-2022 |
| LISN (CISPR 16, Single Phase) | Chase | MN 2050 | 336 | 12 | 04-Jul-2023 |
| LISN (CISPR 16, Single Phase) | Rohde & Schwarz | ESH3-Z5 | 1390 | 12 | 31-Jan-2023 |

Table 12



2.2 Radiated Disturbance

2.2.1 Specification Reference

FCC 47 CFR Part 15B, Clause 15.109
ICES-003, Clause 3.2
ISED RSS-GEN, Clause 7.1

2.2.2 Equipment Under Test and Modification State

A2843, S/N: YWL2C4T4WY - Modification State 0

2.2.3 Date of Test

30-August-2022 to 05-September-2022

2.2.4 Test Method

The EUT was set up on a non-conductive table 0.8 m above a reference ground plane within a semi-anechoic chamber on a remotely controlled turntable.

A pre-scan of the EUT emissions profile using a peak detector was made at a 3 m antenna distance whilst varying the antenna-to-EUT azimuth and polarisation.

Using a list of the highest emissions detected during the pre-scan along with their bearing and associated antenna polarisation, the EUT was then formally measured using a Quasi-Peak, Peak or CISPR Average detector as appropriate.

The readings were maximised by adjusting the antenna height, polarisation and turntable azimuth, in accordance with the specification.

2.2.5 Example Calculation

Below 1 GHz:

$$\begin{aligned} \text{Quasi-Peak level (dB}\mu\text{V/m)} &= \text{Receiver level (dB}\mu\text{V)} + \text{Correction Factor (dB/m)} \\ \text{Margin (dB)} &= \text{Quasi-Peak level (dB}\mu\text{V/m)} - \text{Limit (dB}\mu\text{V/m)} \end{aligned}$$

Above 1 GHz:

$$\begin{aligned} \text{CISPR Average level (dB}\mu\text{V/m)} &= \text{Receiver level (dB}\mu\text{V)} + \text{Correction Factor (dB/m)} \\ \text{Margin (dB)} &= \text{CISPR Average level (dB}\mu\text{V/m)} - \text{Limit (dB}\mu\text{V/m)} \end{aligned}$$

$$\text{Peak level (dB}\mu\text{V/m)} = \text{Receiver level (dB}\mu\text{V)} + \text{Correction Factor (dB/m)}$$

2.2.6 Test Setup Diagram

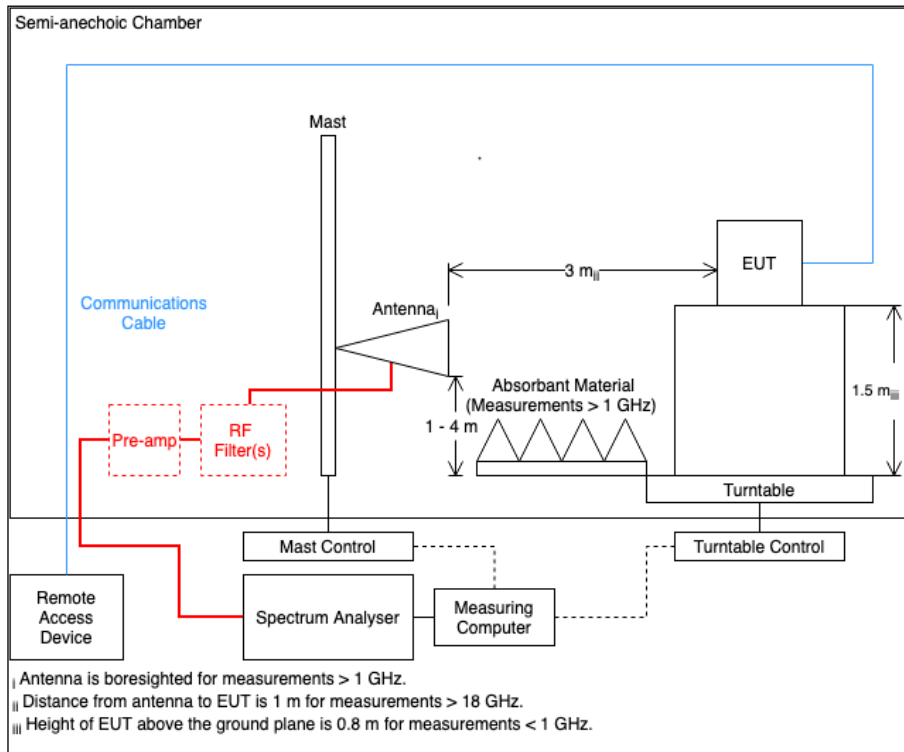

Figure 4 – Radiated Emissions

2.2.7 Environmental Conditions

Ambient Temperature 19.6 - 23.1 °C
 Relative Humidity 44.0 - 55.9 %
 Atmospheric Pressure 1010.0 mbar

2.2.8 Specification Limits

| Required Specification Limits, Field Strength - Class B Test Limit at a 3 m Measurement Distance | | |
|--|-------------------|---------------------|
| Frequency Range (MHz) | Test Limit (µV/m) | Test Limit (dBµV/m) |
| 30 to 88 | 100 | 40.0 |
| 88 to 216 | 150 | 43.5 |
| 216 to 960 | 200 | 46.0 |
| Above 960 | 500 | 54.0 |

Supplementary information:
 Note 1. A Quasi-peak detector is to be used for measurements below 1 GHz.
 Note 2. A CISPR Average detector is to be used for measurements above 1 GHz.
 Note 3. The Peak test limit above 1 GHz is 20 dB higher than the CISPR Average test limit.

Table 13



2.2.9 Test Results

Results for Configuration and Mode: AC Powered - Transmitter Idle.

This test was performed to the requirements of the Class B limits.

Performance assessment of the EUT made during this test: Pass.

Detailed results are shown below.

Highest frequency generated or used within the EUT: 5825 MHz

Which necessitates an upper frequency test limit of: 30 GHz

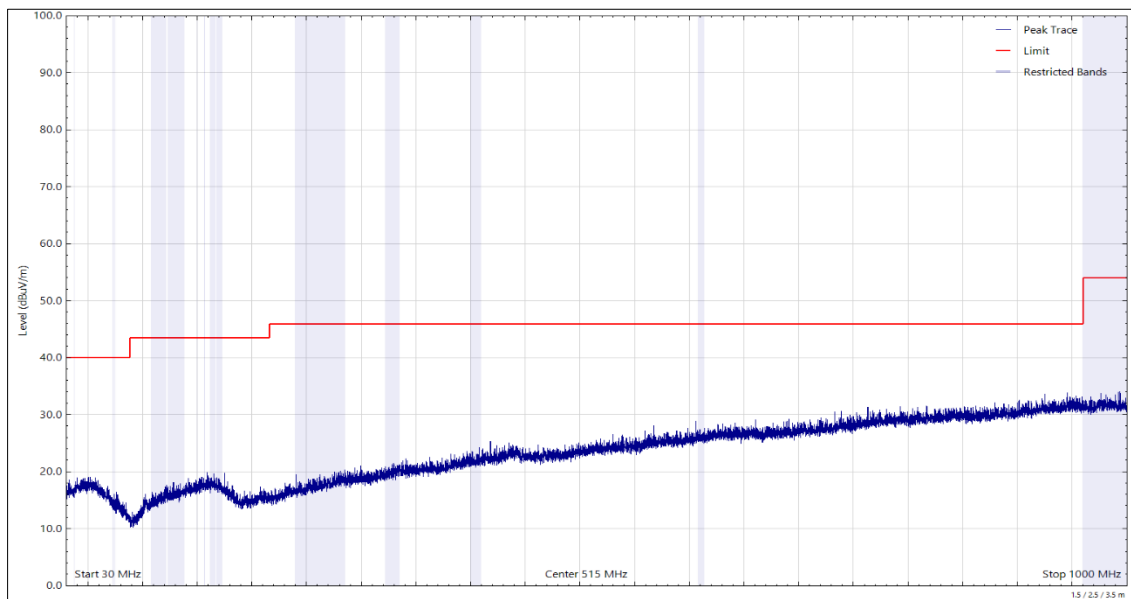

Figure 5 - 30 MHz to 1 GHz, Quasi-Peak, Horizontal

| Frequency (MHz) | Level (dBuV/m) | Limit (dBuV/m) | Margin (dB) | Detector | Angle (°) | Height (cm) | Polarisation |
|-----------------|----------------|----------------|-------------|----------|-----------|-------------|--------------|
| * | | | | | | | |

Table 14

*No final measurements were made as all peak emissions seen above the measurement system noise floor during the pre-scan were greater than 10 dB below the test limit.

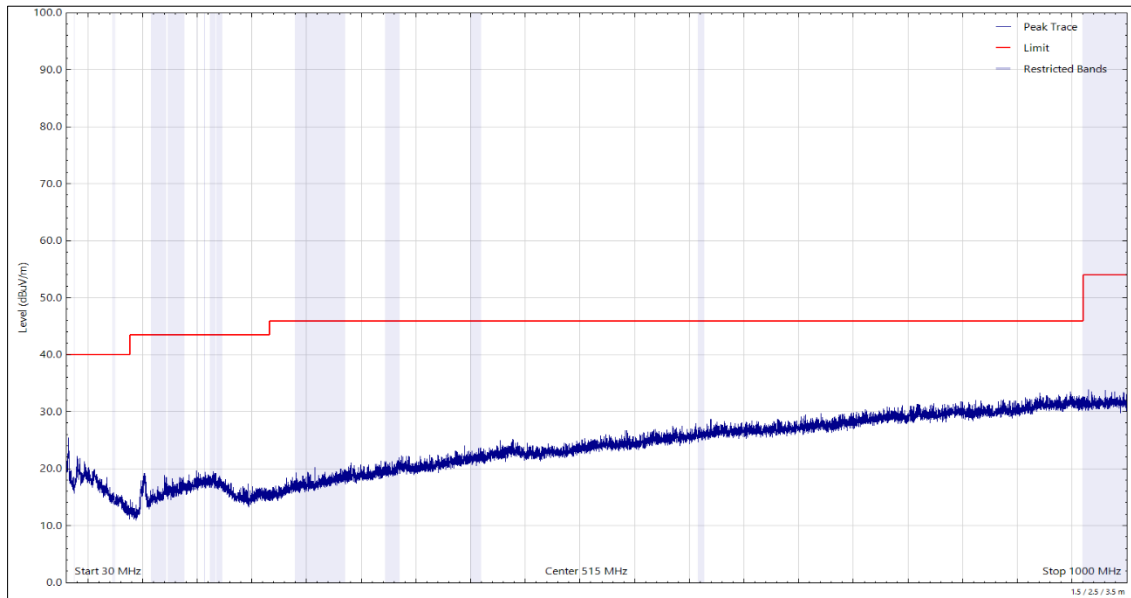

Figure 6 - 30 MHz to 1 GHz, Quasi-Peak, Vertical

| Frequency (MHz) | Level (dBuV/m) | Limit (dBuV/m) | Margin (dB) | Detector | Angle (°) | Height (cm) | Polarisation |
|-----------------|----------------|----------------|-------------|----------|-----------|-------------|--------------|
| * | | | | | | | |

Table 15

*No final measurements were made as all peak emissions seen above the measurement system noise floor during the pre-scan were greater than 10 dB below the test limit.

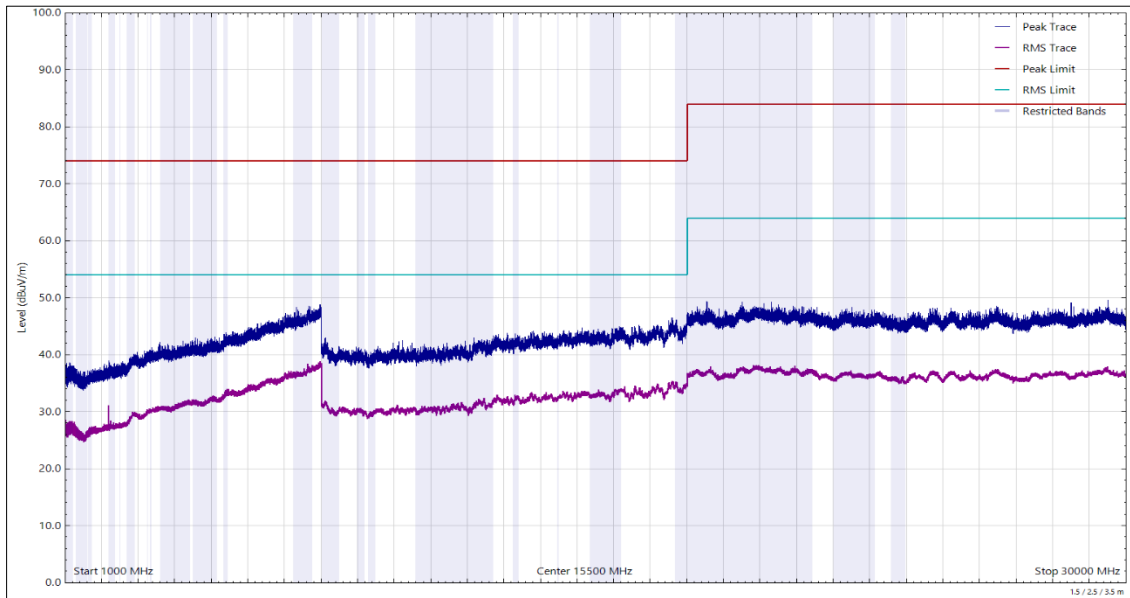

Figure 7 - 1 GHz to 30 GHz, Peak-CISPR Average, Horizontal

| Frequency (MHz) | Level (dBuV/m) | Limit (dBuV/m) | Margin (dB) | Detector | Angle (°) | Height (cm) | Polarisation |
|-----------------|----------------|----------------|-------------|----------|-----------|-------------|--------------|
| * | | | | | | | |

Table 16

*No final measurements were made as all peak emissions seen above the measurement system noise floor during the pre-scan were greater than 10 dB below the test limit.

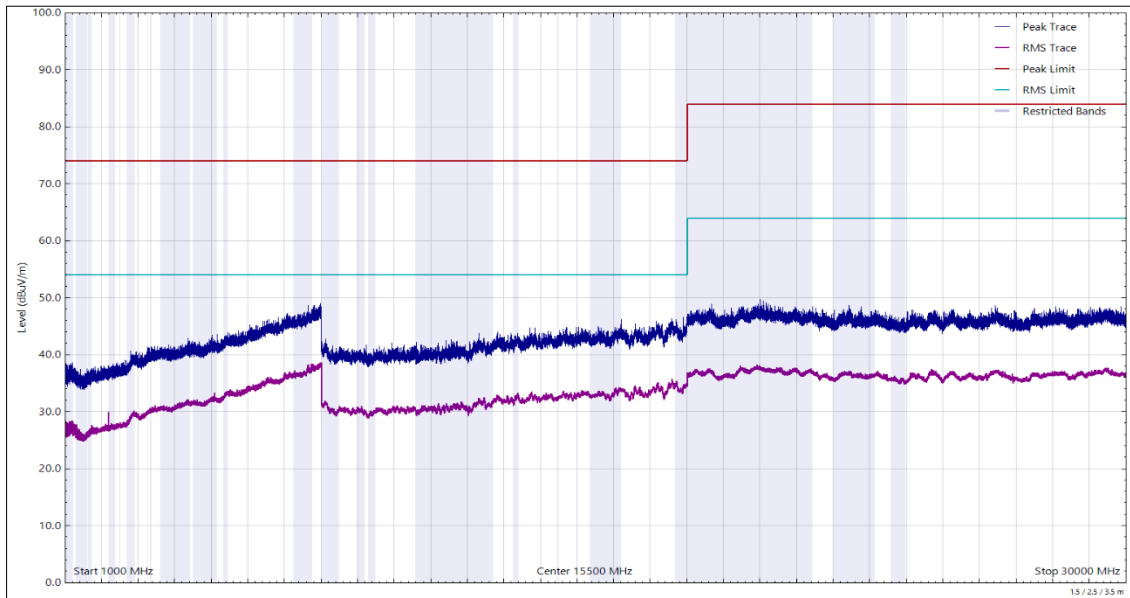

Figure 8 - 1 GHz to 30 GHz, Peak-CISPR Average, Vertical

| Frequency (MHz) | Level (dBuV/m) | Limit (dBuV/m) | Margin (dB) | Detector | Angle (°) | Height (cm) | Polarisation |
|-----------------|----------------|----------------|-------------|----------|-----------|-------------|--------------|
| * | | | | | | | |

Table 17

*No final measurements were made as all peak emissions seen above the measurement system noise floor during the pre-scan were greater than 10 dB below the test limit.

2.2.10 Test Location and Test Equipment Used

This test was carried out in RF Chamber 14.

| Instrument | Manufacturer | Type No. | TE No. | Calibration Period (months) | Calibration Expiry Date |
|--------------------------------------|-----------------------|----------------------|--------|-----------------------------|-------------------------|
| Emissions Software | TUV SUD | EmX V3.1.4 | 5125 | - | Software |
| EMI Test Receiver | Rohde & Schwarz | ESW44 | 5912 | 12 | 17-Feb-2023 |
| Cable (K Type 2m) | Junkosha | MWX241-01000KMSKMS/B | 5937 | 12 | 14-May-2023 |
| DRG Horn Antenna (7.5-18GHz) | Schwarzbeck | HWRD750 | 5941 | 12 | 29-May-2023 |
| TRILOG Super Broadband Test Antenna | Schwarzbeck | VULB 9168 | 5943 | 24 | 03-Feb-2024 |
| 5m Semi-Anechoic Chamber (Dual-Axis) | Albatross Projects | RF Chamber 14 | 5958 | 36 | 26-Apr-2025 |
| Compact Antenna Mast | Maturo Gmbh | CAM4.0-P | 5959 | - | TU |
| Mast & Turntable Controller | Maturo Gmbh | FCU3.0 | 5960 | - | TU |
| Tilt Antenna Mast | Maturo Gmbh | BAM4.5-P | 5961 | - | TU |
| Turntable | Maturo Gmbh | TT1.5SI | 5962 | - | TU |
| Modular Power System Mainframe | Keysight Technologies | N6701C | 5969 | - | O/P Mon |



| Instrument | Manufacturer | Type No. | TE No. | Calibration Period (months) | Calibration Expiry Date |
|--|---------------------|----------------------|--------|-----------------------------|-------------------------|
| Cable (sma to sma 1m) | Junkosha | MWX221-01000AMSAMS/A | 5997 | 12 | 06-Jun-2023 |
| Cable (N to N 1m) | Junkosha | MWX221-01000NMSNMS/B | 5999 | 12 | 05-Jun-2023 |
| Cable (SMA to SMA 6.5m) | Junkosha | MWX221-06500AMSAMS/B | 6003 | 12 | 07-Jun-2023 |
| Cable (N to N 7m) | Junkosha | MWX221-07000NMSNMS/B | 6005 | 12 | 05-Jun-2023 |
| Cable (N to N 8m) | Junkosha | MWX221-08000NMSNMS/A | 6006 | 12 | 05-Jun-2023 |
| Cable (SMA to SMA 1m) | Junkosha | MWX221-01000AMSAMS/A | 6008 | 12 | 06-Jun-2023 |
| Cable (N to N 7m) | Junkosha | MWX221-07000NMSNMS/B | 6016 | 12 | 05-Jun-2023 |
| Cable (N to N 8m) | Junkosha | MWX221-08000NMSNMS/A | 6017 | 12 | 05-Jun-2023 |
| Cable (SMA to SMA 1m) | Junkosha | MWX221-01000AMSAMS/B | 6019 | 12 | 07-Jun-2023 |
| Horn Antenna (1-10 GHz) | Schwarzbeck | BBHA9120B | 6141 | 12 | 21-Jun-2023 |
| SAC Switch Unit | TUV SUD | SSU001 | 6144 | 12 | 07-Jul-2023 |
| Digital Multimeter | Fluke | 115 | 6147 | 12 | 16-Jun-2023 |
| Humidity & Temperature meter | R.S Components | 1364 | 6150 | 12 | 17-Jun-2023 |
| Double Ridge Active Horn Antenna (18-40 GHz) | Com-Power | AHA-840 | 6187 | 24 | 02-Jun-2024 |
| Pre Amp 8 - 18 GHz | Wright Technologies | APS06 0061 | 6198 | 12 | 19-Jul-2023 |
| Cable (SMA to SMA 20cm) | TUV SUD | MH-FH 8-18 | 6215 | 12 | 25-Jul-2023 |

Table 18

TU - Traceability Unscheduled
 O/P Mon – Output Monitored using calibrated equipment



3 Incident Reports

No incidents reports were raised.



4 Measurement Uncertainty

For a 95% confidence level, the measurement uncertainties for defined systems are:

| Test Name | Measurement Uncertainty |
|--|---|
| Conducted Disturbance at Mains Terminals | 150 kHz to 30 MHz, LISN, ± 3.7 dB |
| Radiated Disturbance | 30 MHz to 1 GHz, Bilog Antenna, ± 5.2 dB 1 GHz to 40 GHz, Horn Antenna, ± 6.3 dB |

Table 19

Worst case error for both Time and Frequency measurement 12 parts in 10^6 .

Measurement Uncertainty Decision Rule

Determination of conformity with the specification limits is based on the decision rule according to IEC Guide 115:2007, Clause 4.4.3 and 4.5.1. (Procedure 2). The measurement results are directly compared with the test limit to determine conformance with the requirements of the standard.

Risk: The uncertainty of measurement about the measured result is negligible regarding the final pass/fail decision. The measurement result can be directly compared with the test limit to determine conformance with the requirement (compare IEC Guide 115). The level of risk to falsely accept and falsely reject items is further described in ILAC-G8.