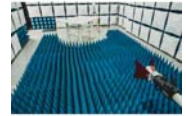




# PCTEST ENGINEERING LABORATORY, INC.

18855 Adams Court, Morgan Hill, CA 95037 USA  
Tel. 410.290.6652 / Fax 410.290.6654  
<http://www.pctest.com>



## MEASUREMENT REPORT FCC PART 15.407 / ISED RSS-247 DFS

**Applicant Name:**  
Apple Inc.  
1 Infinite Loop  
Cupertino, CA 95014  
United States

**Date of Testing:**  
10/31-2/14/2018  
**Test Site/Location:**  
PCTEST Lab. Morgan Hill, CA, USA  
**Test Report Serial No.:**  
1C1710060006-07.BCG

<b>FCC ID:</b>	<b>BCGA1954</b>
<b>IC:</b>	<b>579C-A1954</b>
<b>APPLICANT:</b>	<b>Apple Inc.</b>

**Application Type:** Certification  
**Model/HVIN:** A1954  
**EUT Type:** Client Only Device, No Radar Detection Capability  
**Max. RF Output Power:** 98.410 mW (19.93dBm) Conducted (802.11n UNII Band 2A MIMO)  
 100.007 mW (20.00dBm) Conducted (802.11n UNII Band 2C MIMO)  
**Frequency Range:** 5250 – 5350 MHz (UNII-2A Band)  
 5470 – 5725 MHz (UNII-2C Band)  
**FCC Classification:** Unlicensed National Information Infrastructure (UNII)  
**Test Procedure(s):** KDB 905462 D02 v02

This equipment has been shown to be capable of compliance with the applicable technical standards as indicated in the measurement report and was tested in accordance with the measurement procedures specified in KDB 905462 D02 v02 Compliance Measurement Procedures for Unlicensed-National Information Infrastructure Devices Operating in the 5.25 – 5.35 GHz and 5.47 – 5.725 GHz Bands Incorporating Dynamic Frequency Selection. Test results reported herein relate only to the item(s) tested.

I attest to the accuracy of data. All measurements reported herein were performed by me or were made under my supervision and are correct to the best of my knowledge and belief. I assume full responsibility for the completeness of these measurements and vouch for the qualifications of all persons taking them.

Randy Ortanez  
President



<b>FCC ID:</b> BCGA1954		<b>MEASUREMENT REPORT (CERTIFICATION)</b>	<b>Approved by:</b> Quality Manager
<b>Test Report S/N:</b> 1C1710060006-07.BCG	<b>Test Dates:</b> 10/31-1/31/2018	<b>EUT Type:</b> Tablet Device	Page 1 of 45

# TABLE OF CONTENTS

1.0	INTRODUCTION .....	3
1.1	Scope .....	3
1.2	Evaluation Procedure .....	3
1.3	Summary of Test Results .....	3
2.0	PRODUCT INFORMATION .....	5
2.1	Equipment Description .....	5
2.2	EUT Capabilities .....	5
2.3	Modifications .....	5
3.0	DESCRIPTION OF DYNAMIC FREQUENCY SELECTION TEST .....	6
3.1	Applicability .....	6
3.2	Requirements .....	7
3.3	DFS Detection Threshold Values .....	9
3.4	Parameters of DFS Test Signals .....	9
3.5	System Overview and Procedure .....	11
3.6	System Calibration: .....	12
4.0	TEST EQUIPMENT AND SOFTWARE .....	13
5.0	EUT TEST SETUP .....	14
6.0	RADAR PULSES AND TRAFFIC SIGNALS .....	18
6.1	Radar Waveform Calibration: .....	18
6.1	Traffic Signal: .....	20
7.0	TEST RESULTS - Channel loading .....	22
7.1	Channel Loading Mode1/Mode2: .....	22
7.2	Channel Loading Mode3/Mode4: .....	25
8.0	TEST RESULTS - Move Time and Aggregate Time .....	28
8.1	Move Time and Aggregate Time Mode 1: .....	28
8.2	Move Time and Aggregate Time Mode 2: .....	30
8.3	Move Time and Aggregate Time Mode 3: .....	32
8.4	Move Time and Aggregate Time Mode 4: .....	34
9.0	TEST RESULTS - Client Beacon test (10 Minutes) .....	37
9.1	Monitoring 10 minutes Mode 1: .....	37
9.2	Monitoring 10 minutes Mode 2: .....	39
9.3	Monitoring 10 minutes Mode 3: .....	41
9.4	Monitoring 10 minutes Mode 4: .....	43
10.0	CONCLUSION .....	45

<b>FCC ID:</b> BCGA1954		<b>MEASUREMENT REPORT (CERTIFICATION)</b>	<b>Approved by:</b> Quality Manager
<b>Test Report S/N:</b> 1C1710060006-07.BCG	<b>Test Dates:</b> 10/31-1/31/2018	<b>EUT Type:</b> Tablet Device	Page 2 of 45

# 1.0 INTRODUCTION

## 1.1 Scope

This report has been prepared to demonstrate compliance with the requirements for Dynamic Frequency Selection (DFS) as stated in KDB 905462 D02 v02. Testing was performed on the **Apple, Inc. Table FCC ID: BCA1954**. As of July 20, 2007, all devices operating in the 5250 – 5350 MHz and/or the 5470 – 5725 MHz bands (excluding 5600-5650MHz for ISED Canada) must comply with the DFS requirements. As the EUT does not have radar detection capability it was evaluated as a Client Only Device. All test results reported herein are applicable to the sample selected for testing. The unit used for testing was supplied by Apple Inc.

## 1.2 Evaluation Procedure

Conducted test methodology was used for the DFS evaluation procedure of the EUT. No deviations to the test procedure and test methods occurred during the evaluation of the EUT.

## 1.3 Summary of Test Results

The EUT was found to be compliant with the requirements for DFS as required for a Client Device per Part 15.407(h), RSS-247 and KDB 905462 D02 v02. The following table lists the measured parameters. The actual data and plots can be found in Section 5 and 6 of this report.

FCC ID: BCGA1954	 <b>MEASUREMENT REPORT (CERTIFICATION)</b>		Approved by: Quality Manager
Test Report S/N: 1C1710060006-07.BCG	Test Dates: 10/31-1/31/2018	EUT Type: Tablet Device	Page 3 of 45

	Mode	Parameter	Measured			Limit	Result
			20MHz Bandwidth	40MHz Bandwidth	80MHz Bandwidth		
<b>5470 – 5725 MHz</b> <b>(excluding 5600-5650MHz for ISED Canada)</b> <b>UNII – 2C Band</b>	1 Client Mode	Channel Move Time	4.196 s	0.088 s	0.072 s	10 seconds	Pass
		Channel Closing Transmission Time	< 200ms + 8.001 ms (aggregate)	< 200ms + 0.067 ms (aggregate)	< 200ms + 0.118 ms (aggregate)	200 ms + aggregate of 60ms over remaining 10 second period	Pass
		Client beacon test	Monitored for 10 minutes with no client transmission	Monitored for 10 minutes with no client transmission	Monitored for 10 minutes with no client transmission	No client transmission occurred	Pass
	2 Client to Client	Channel Move Time	4.999 s	0.144 s	0.208 s	10 seconds	Pass
		Channel Closing Transmission Time	< 200ms + 2.012 ms (aggregate)	< 200ms + 13.660 ms (aggregate)	< 200ms + 4.561 ms (aggregate)	200 ms + aggregate of 60ms over remaining 10 second period	Pass
		Client beacon test	Monitored for 10 minutes with no client transmission	Monitored for 10 minutes with no client transmission	Monitored for 10 minutes with no client transmission	No client transmission occurred	Pass
	3 Peer to Peer	Channel Move Time	4.113 s	0.170 s	0.140 s	10 seconds	Pass
		Channel Closing Transmission Time	< 200ms + 16.850 ms (aggregate)	< 200ms + 12.918 ms (aggregate)	< 200ms + 5.446 ms (aggregate)	200 ms + aggregate of 60ms over remaining 10 second period	Pass
		Client beacon test	Monitored for 10 minutes with no client transmission	Monitored for 10 minutes with no client transmission	Monitored for 10 minutes with no client transmission	No client transmission occurred	Pass
	4 Peer to Peer	Channel Move Time	1.434 s	0.069 s	0.235 s	10 seconds	Pass
		Channel Closing Transmission Time	< 200ms + 9.223 ms (aggregate)	< 200ms + 2.959 ms (aggregate)	< 200ms + 5.884 ms (aggregate)	200 ms + aggregate of 60ms over remaining 10 second period	Pass
		Client beacon test	Monitored for 10 minutes with no client transmission	Monitored for 10 minutes with no client transmission	Monitored for 10 minutes with no client transmission	No client transmission occurred	Pass

**Table 1-1. Parameters of EUT**

FCC ID: BCGA1954	 <b>MEASUREMENT REPORT</b> <b>(CERTIFICATION)</b>		Approved by: Quality Manager
Test Report S/N: 1C1710060006-07.BCG	Test Dates: 10/31-1/31/2018	EUT Type: Tablet Device	Page 4 of 45

## 2.0 PRODUCT INFORMATION

### 2.1 Equipment Description

The Client is the **Apple Inc. Tablet Device FCC ID: BCGA1954 / IC ID: 579C-A1954**

**Mode of Operation:**

<b>Master Device</b>	<input type="checkbox"/>
<b>Client Device (No radar detection)</b>	<input checked="" type="checkbox"/>
<b>Client Device with Radar Detection</b>	<input type="checkbox"/>

<b>Parameters of Client:</b>	
Frequency	5250 – 5350 MHz, 5470 – 5725 MHz (FCC 15.407) 5250 – 5350 MHz, 5470 – 5600 MHz, 5650 – 5725MHz (ISED RSS-247)
Max Output Power:	98.410 mW (19.93dBm) (802.11n UNII Band 2A MIMO) 100.007 mW (20.00dBm) (802.11n UNII Band 2C MIMO)
Max Antenna Gain	5.29 dBi (UNII Band 2A - MIMO) 6.22 dBi (UNII Band 2C - MIMO)
Max EIRP Level:	25.51 dBm (UNII Band 2A - MIMO) 26.22 dBm (UNII Band 2C - MIMO)
Modulation:	OFDM
Channel Bandwidth:	20, 40, 80 MHz
EUT Software version	11.3 (15E173)

**Table 2-1. Parameters of EUT**

**Test Device Serial No.:** F9FVT00PJM4W

<b>Parameters of Master:</b>	
Minimum Antenna Gain	1.4 dBi
EIRP Level:	23 dBm
Access Point Software Version	7.7.4f0 dev

**Table 2-2. Parameters of Master**

### 2.2 EUT Capabilities

This device contains the following capabilities:

850/1900 CDMA/EvDO Rev0/A, 1x Advanced (BC0, BC1, BC10), 850/1900 GSM/GPRS/EDGE, 850/1700/1900 WCDMA/HSPA, Multi-band LTE, 802.11b/g/n WLAN, 802.11a/n/ac UNII, Bluetooth (1x, EDR, LE),

### 2.3 Modifications

No modifications to the EUT were required to comply with the DFS specifications.

<b>FCC ID:</b> BCGA1954		<b>MEASUREMENT REPORT (CERTIFICATION)</b>	<b>Approved by:</b> Quality Manager
<b>Test Report S/N:</b> 1C1710060006-07.BCG	<b>Test Dates:</b> 10/31-1/31/2018	<b>EUT Type:</b> Tablet Device	Page 5 of 45

## 3.0 DESCRIPTION OF DYNAMIC FREQUENCY SELECTION TEST

### 3.1 Applicability

The following table from KDB 905462 D02 v02 lists the applicable requirements for the DFS testing. The device evaluated in this report is considered a client device without radar detection capability.

Requirement	Operational Mode		
	Master	Client Without Radar Detection	Client With Radar Detection
Non-Occupancy Period	Yes	Not required	Yes
DFS Detection Threshold	Yes	Not required	Yes
Channel Availability Check Time	Yes	Not required	Not required
Uniform Spreading	Yes	Not required	Not required
U-NII Detection Bandwidth	Yes	Not required	Yes

**Table 3-1. DFS Applicability**

Requirement	Operational Mode		
	Master	Client Without Radar Detection	Client With Radar Detection
DFS Detection Threshold	Yes	Not required	Yes
Channel Closing Transmission Time	Yes	Yes	Yes
Channel Move Time	Yes	Yes	Yes
U-NII Detection Bandwidth	Yes	Not required	Yes
Client Beacon Test	N/A	Yes	Yes

**Table 3-2. DFS Applicability During Normal Operation**

FCC ID: BCGA1954	 <b>MEASUREMENT REPORT (CERTIFICATION)</b>		Approved by: Quality Manager
Test Report S/N: 1C1710060006-07.BCG	Test Dates: 10/31-1/31/2018	EUT Type: Tablet Device	Page 6 of 45

### 3.2 Requirements

Per KDB 905462 D02 v02 the following are the requirements for Client Devices:

- a) A Client Device will not transmit before having received appropriate control signals from a Master Device.
- b) A Client Device will stop all its transmissions whenever instructed by a Master Device to which it is associated and will meet the Channel Move Time and Channel Closing Transmission Time requirements.

The Client Device will not resume any transmissions until it has again received control signals from a Master Device.

- c) If a Client Device is performing In-Service Monitoring and detects a Radar Waveform above the DFS Detection Threshold, it will inform the Master Device. This is equivalent to the Master Device detecting the Radar Waveform and d) through f) of section 5.1.1 apply.
- d) Irrespective of Client Device or Master Device detection the Channel Move Time and Channel Closing Transmission Time requirements remain the same.

FCC ID: BCGA1954	 <b>MEASUREMENT REPORT (CERTIFICATION)</b>		<b>Approved by:</b> Quality Manager
Test Report S/N: 1C1710060006-07.BCG	Test Dates: 10/31-1/31/2018	EUT Type: Tablet Device	Page 7 of 45

Channel Move Time and Channel Closing Transmission Time requirements are listed in the following table.

Parameter	Value
Non-occupancy period	Minimum 30 minutes
Channel Availability Check Time	60 seconds
Channel Move Time	10 seconds See Note 1.
Channel Closing Transmission Time	200 milliseconds + an aggregate of 60 milliseconds over remaining 10 second period. See Note 1 and 2.
U-NII Detection Bandwidth	Minimum 80% of the U-NII 99% transmission power bandwidth. See Note 3.
<p><b>Note 1: The instant that the Channel Move Time and the Channel Closing Transmission Time begins is as follows:</b></p> <ul style="list-style-type: none"> <li>• For the Short Pulse Radar Test Signals this instant is the end of the Burst.</li> <li>• For the Frequency Hopping radar Test Signal, this instant is the end of the last radar Burst generated.</li> <li>• For the Long Pulse Radar Test Signal this instant is the end of the 12 second period defining the Radar Waveform.</li> </ul> <p><b>Note 2: The Channel Closing Transmission Time is comprised of 200 milliseconds starting at the beginning of the Channel Move Time plus any additional intermittent control signals required to facilitate a Channel move (an aggregate of 60 milliseconds) during the remainder of the 10 second period. The aggregate duration of control signals will not count quiet periods in between transmissions.</b></p> <p><b>Note 3: During the U-NII Detection Bandwidth detection test, radar type 1 is used and for each frequency step the minimum percentage of detection is 90 percent. Measurements are performed with no data traffic.</b></p>	

**Table 3-3: DFS Response Requirements**

FCC ID: BCGA1954	 <b>MEASUREMENT REPORT (CERTIFICATION)</b>		Approved by: Quality Manager
Test Report S/N: 1C1710060006-07.BCG	Test Dates: 10/31-1/31/2018	EUT Type: Tablet Device	Page 8 of 45



### 3.3 DFS Detection Threshold Values

The DFS detection thresholds are defined for Master devices and Client Devices with In-service monitoring. These detection thresholds are listed in the following table.

Maximum Transmit Power	Value (See Notes 1 and 2)
≥ 200 milliwatt	-64 dBm
< 200 milliwatt	-62 dBm
<p>Note 1: This is the level at the input of the receiver assuming a 0 dBi receive antenna.</p> <p>Note 2: Throughout these test procedures an additional 1 dB has been added to the amplitude of the test transmission waveforms to account for variations in measurement equipment. This will ensure that the test signal is at or above the detection threshold level to trigger a DFS response.</p> <p>Note 3: For this test, the radiated output power of the Master Unit is greater than 23 dBm. Hence, DFS Detection Threshold Value was set to -64dBm.</p>	

**Table 3-4: Detection Thresholds for Master Devices and Client Devices with Radar Detection**

### 3.4 Parameters of DFS Test Signals

As the EUT is a Client Device with no Radar Detection only one type radar pulse is required for the testing. Radar Pulse type 1 was used in the evaluation of the Client device for the purpose of measuring the Channel Move Time and the Channel Closing Transmission Time. Table 3-5 lists the parameters for the Short Pulse Radar Waveforms. A plot of the Radar Pulse Type 1 used for testing is included in Section 7.0 of this report.

Radar Type	Pulse Width (µsec)	PRI (µsec)	Number of Pulses	Minimum Percentage of Successful Detection	Minimum Number of Trials
1	1	1428	18	60%	30
2	1-5	150-230	23-29	60%	30
3	6-10	200-500	16-18	60%	30
4	11-20	200-500	12-16	60%	30
Aggregate (Radar Types 1-4)				80%	120

**Table 3-5: Parameters for Short Pulse Radar Waveforms**

FCC ID: BCGA1954			MEASUREMENT REPORT (CERTIFICATION)	Approved by: Quality Manager
Test Report S/N: 1C1710060006-07.BCG	Test Dates: 10/31-1/31/2018	EUT Type: Tablet Device		Page 9 of 45

Radar Type	Pulse Width (µsec)	Chirp Width (MHz)	PRI (µsec)	Number of Pulses per Burst	Number of Bursts	Minimum Percentage of Successful Detection	Minimum Number of Trials
5	50 - 100	5 - 20	5 - 20	1 - 3	8 - 20	60%	30

**Table 3-6. Parameters for Long Pulse Radar Waveforms**

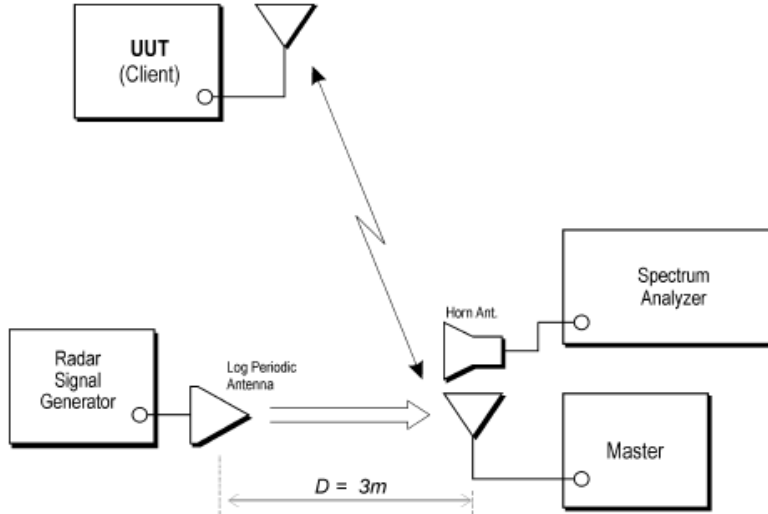
Radar Type	Pulse Width (µsec)	PRI (µsec)	Pulses per Hop	Hopping Rate (kHz)	Hopping Sequence Length (msec)	Minimum Percentage of Successful Detection	Minimum Number of Trials
6	1	333	9	0.333	300	70%	30

**Table 3-7. Parameters for Frequency Hopping Radar Waveforms**

FCC ID: BCGA1954	 <b>MEASUREMENT REPORT (CERTIFICATION)</b>		Approved by: Quality Manager
Test Report S/N: 1C1710060006-07.BCG	Test Dates: 10/31-1/31/2018	EUT Type: Tablet Device	Page 10 of 45

### 3.5 System Overview and Procedure

KDB 905462 D02 v02 describes a radiated test setup and a conducted test setup. The conducted test setup was used for this testing. Figure 3-1 shows the typical test setup. In Band 2C, one channel selected between 5470 and 5725 MHz was chosen for testing.



**Figure 3-1. Radiated Test Setup for DFS**

1. The “Aeroflex PXI DFS Radar Simulator and Analyzer Test Suite” is setup to provide a simulated radar pulse at the frequency that the Master and Client are operating. A Type 0 radar pulse was used.
2. The Client Device (EUT) is set up per the diagram in Figure 3-1 and communications between the Master device and the Client is established.
3. The FCC video test file is streamed from the Master to the Client to properly load the network.
4. The “Aeroflex PXI DFS Radar Simulator and Analyzer Test Suite” is set to record and display 12 seconds of time, starting from where the simulated radar is generated. This time domain plot captures any transmissions occurring up to and after 10sec. Aggregate time is computed to ensure compliance. (Note: the channel may be different since the Master and Client have changed channels due to the detection of the initial radar pulse.)
5. After the initial radar burst the channel is monitored for 10 minutes to ensure no transmissions or beacons occur. A second monitoring setup is used to verify that the Master and Client have both moved to different channels.

FCC ID: BCGA1954	<b>PCTEST</b> ENGINEERING LABORATORY, INC.		<b>MEASUREMENT REPORT (CERTIFICATION)</b>	<b>Approved by:</b> Quality Manager
<b>Test Report S/N:</b> 1C1710060006-07.BCG	<b>Test Dates:</b> 10/31-1/31/2018	<b>EUT Type:</b> Tablet Device		Page 11 of 45

### 3.6 System Calibration:

Radar pulses generated at the PXI RF Synthesizer's Output Port (as depicted as 'RADAR Test Signal Generator' in Figure 3-1) was injected through the Vivaldi Antenna. It was received by the horn antenna at a 3m distance. The horn antenna was connected by a low loss RF cable with the spectrum analyzer. The offset of the spectrum analyzer was calculated based on the loss of the RF cable and gain of the horn antenna. In the 'PXI DFS Radar Simulator & Analyzer' Software, Signal Generator was set to Continuous Wave mode. The 'DUT Peak Input Level Setting' is adjusted to yield a level of -64dBm as measured on Spectrum Analyzer. This value will be used when the main DFS testing would be performed as described in section 3.4.

After collecting the plots of the Radar pulses, the spectrum analyzer was reconnected with the DFS test system as shown in Figure 3-1. The spectrum analyzer displays the transmission level of the signal generator using the Vivaldi Antenna and the transmission is received using Horn Antenna that is 3 meters away from the antenna post where the Master device will reside during testing. The interference detection threshold may be varied from the calibrated value of -64dBm and the Spectrum analyzer will still indicate the level as received by the Master Device.

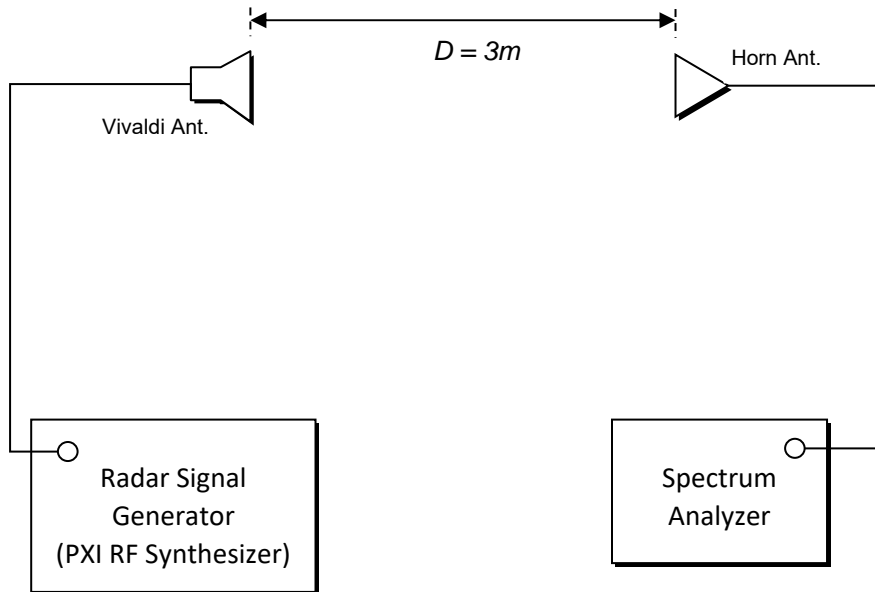


Figure 3-2. Test Setup Calibration

FCC ID: BCGA1954	 <b>MEASUREMENT REPORT (CERTIFICATION)</b>		Approved by: Quality Manager
Test Report S/N: 1C1710060006-07.BCG	Test Dates: 10/31-1/31/2018	EUT Type: Tablet Device	Page 12 of 45

## 4.0 TEST EQUIPMENT AND SOFTWARE

### Test Equipment:

Test Equipment Calibration is traceable to the National Institute of Standards and Technology (NIST). Measurements antennas used during testing were calibrated in accordance to the requirements of ANSI C63.5-2006.

Manufacturer	Type/Model	Description	Cal. Date	Cal. Interval	Cal. Due Date	Serial No.
Aeroflex	PXI 82531	PXI RF Synthesizer/DFS Radar Simulator & Analyzer	9/22/2016	Biennial	9/22/2018	1082329
Rohde & Schwarz	ESW44	ESW/EMI Test Receiver	11/14/2017	Biennial	11/14/2018	101570
Rohde & Schwarz	TC-TA18	Cross-Pol Antenna 400MHz-18GHz	1/19/2018	Annual	1/19/2019	101056
ETS-Lindgren	3117	1M Horizontal & Vertical / 3M Free Space	1/18/2017	Annual	1/18/2018	205956
Seekonk	NC-100	Torque Wrench 5/16", 8" lbs.	3/2/2016	Biennial	3/2/2018	N/A

**Table 4-1. Annual Test Equipment Calibration Schedule**

**Note:** For equipment listed above that has a calibration date or calibration due date that falls within the test date range, care was taken to ensure that this equipment was used after the calibration date and before the calibration due date.

### Support Equipment:

The following equipment was used in support of the DFS testing.

Device	Manufacturer	Model	Description	S/N:	FCC ID:
Master	Apple	A1521	Access Point	C86PJ5RUFJIR	BCGA1521
		MacBook Air	Controller	C02P41RZG086	QDS-BRCM1072
Client	Apple	Apple TV	Controller	C07PR001GPWK	BCGA1625
		MacBook Air	Controller	C02P52H6G085	QDS-BRCM1072
	Dell	U24177HJ	Monitor Display	0RXP1N-74261-71Q-0APL-A01	N/A

**Table 4-2. Support Equipment**

### Test Software:

Automated test software was used to measure emissions and capture the corresponding plots necessary to show compliance. The list is given below,

1. DFS threshold count v1.1 (Python)
2. DFS Radar Simulator and Analyzer (Aeroflex Inc.)
3. iPerf Software

FCC ID: BCGA1954	 <b>MEASUREMENT REPORT (CERTIFICATION)</b>		Approved by: Quality Manager
Test Report S/N: 1C1710060006-07.BCG	Test Dates: 10/31-1/31/2018	EUT Type: Tablet Device	Page 13 of 45

## 5.0 EUT TEST SETUP

The EUT was tested in 4 different test configurations,

Mode 1: Client Mode

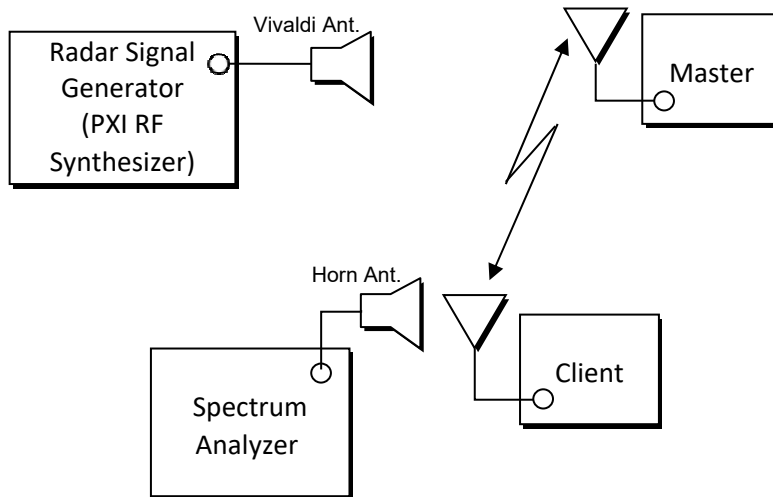
Mode 2: Client to Client

Mode 3: Peer to Peer (EUT)

Mode 4: Peer to Peer (Apple TV)

### **Mode 1: Client Mode**

Client is connected to Master (AP) via WLAN network and plays a video test file “6 ½ Magic Hours” in a Server (MacBook Air). This Server is connected to the Master (AP) via ethernet cable. The Horn antenna is adjusted so that the WLAN traffic level, as displayed on the spectrum analyzer, is at lower amplitude than the radar detection threshold.



**Figure 5-1. Mode-1 Test Setup**

FCC ID: BCGA1954	 <b>MEASUREMENT REPORT (CERTIFICATION)</b>		Approved by: Quality Manager
Test Report S/N: 1C1710060006-07.BCG	Test Dates: 10/31-1/31/2018	EUT Type: Tablet Device	Page 14 of 45

## Mode 2: Client-to-Client Communications Mode

Client plays the video test file that is streamed to generate WLAN while linked to Master and streamed the video through Apple TV to Monitor display. The Horn antenna is adjusted so that the WLAN traffic level, as displayed on the spectrum analyzer, is at lower amplitude than the radar detection threshold.

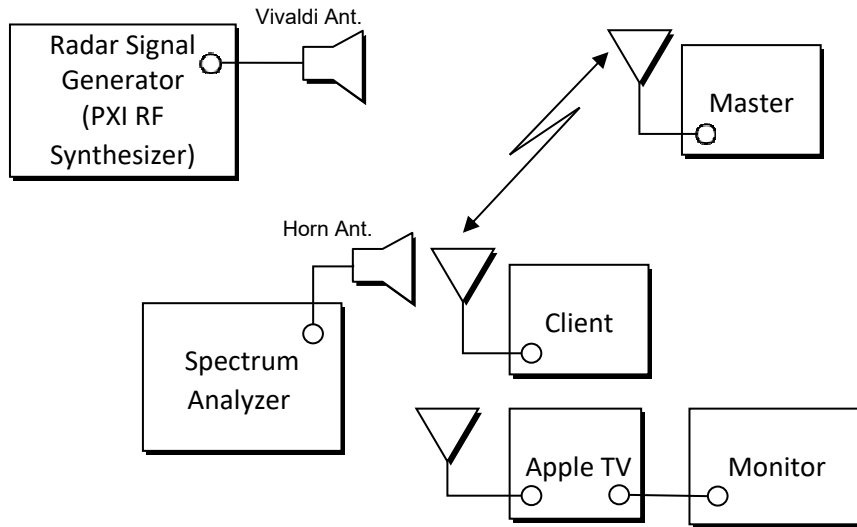


Figure 5-2. Mode-2 Test Setup

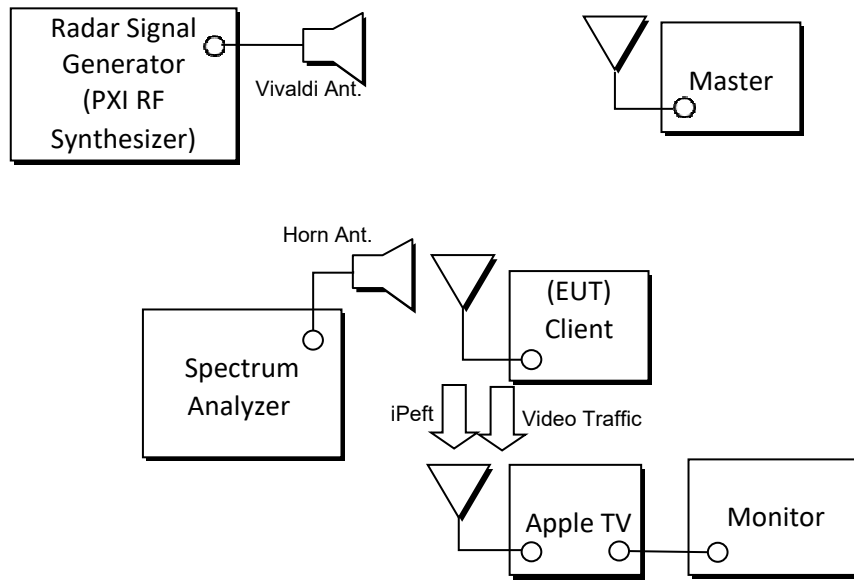
FCC ID: BCGA1954	 <b>MEASUREMENT REPORT (CERTIFICATION)</b>		Approved by: Quality Manager
Test Report S/N: 1C1710060006-07.BCG	Test Dates: 10/31-1/31/2018	EUT Type: Tablet Device	Page 15 of 45

**Mode 3: Peer-to-Peer (EUT) Communications Mode**

Generate and inject additional transmission:

1. Client and Apple TV must be linked to the Master.
2. Client plays video that is saved within its internal storage and begin mirroring screen via Apple TV.
3. Connect the Apple TV and Client to the support laptop and initiate additional transmission using iPerf.
4. After the additional transmission is injected, the Client must be disconnected to the Master.
5. Client stops and re-start mirroring screen.

Client plays video that is saved within its internal storage and streamed through Apple TV to the Monitor display. The receive antenna/ monitoring antenna is placed near the EUT. Additional data traffic was sent from the EUT (Client) to Apple TV (Server) using iPerf. The Horn antenna is adjusted so that the WLAN traffic level, as displayed on the spectrum analyzer, is at lower amplitude than the radar detection threshold.



**Figure 5-3. Test Setup (Mode 3)**

FCC ID: BCGA1954	<b>MEASUREMENT REPORT (CERTIFICATION)</b>		Approved by: Quality Manager
Test Report S/N: 1C1710060006-07.BCG	Test Dates: 10/31-1/31/2018	EUT Type: Tablet Device	Page 16 of 45

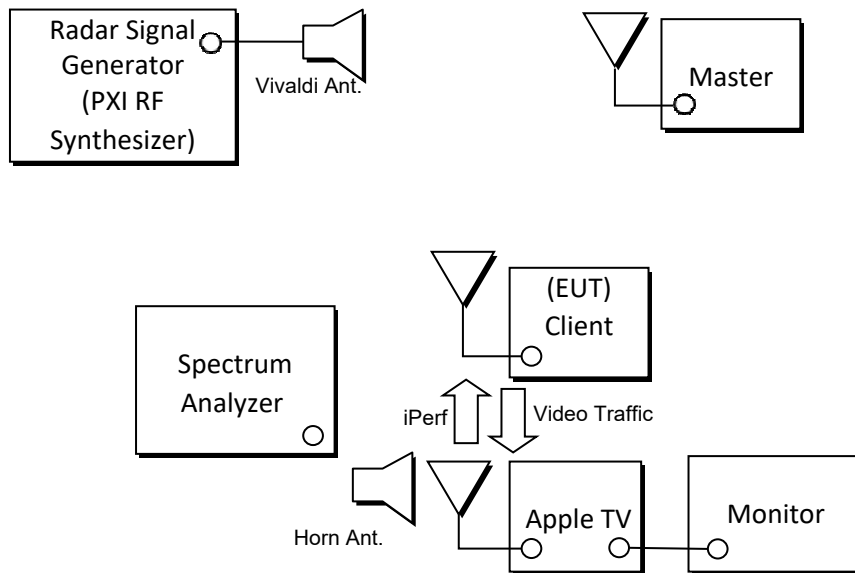


**Mode 4: Peer-to-Peer (Apple TV) Communications Mode**

Generate and inject additional transmission:

1. Client and Apple TV must be linked to the Master.
2. Client plays video that is saved within its internal storage and begin mirroring screen via Apple TV.
3. Connect the Apple TV and Client to the support laptop and initiate additional transmission using iPerf.
4. After the additional transmission is injected, the Client must be disconnected to the Master.
5. Client stops and re-start mirroring screen.

Client plays video that is saved within its internal storage and streamed through Apple TV to the Monitor display. The receive antenna/ monitoring antenna is placed near the Apple TV. Additional data traffic was sent from the Apple TV (Client) to the EUT (Server) using iPerf. The Horn antenna is adjusted so that the WLAN traffic level, as displayed on the spectrum analyzer, is at lower amplitude than the radar detection threshold.



**Figure 5-4. Test Setup (Mode 4)**

In summary, for Modes 1 and Mode 2, Client is linked to the Master, and for Modes 3 and Mode 4, Client is not linked to the Master.

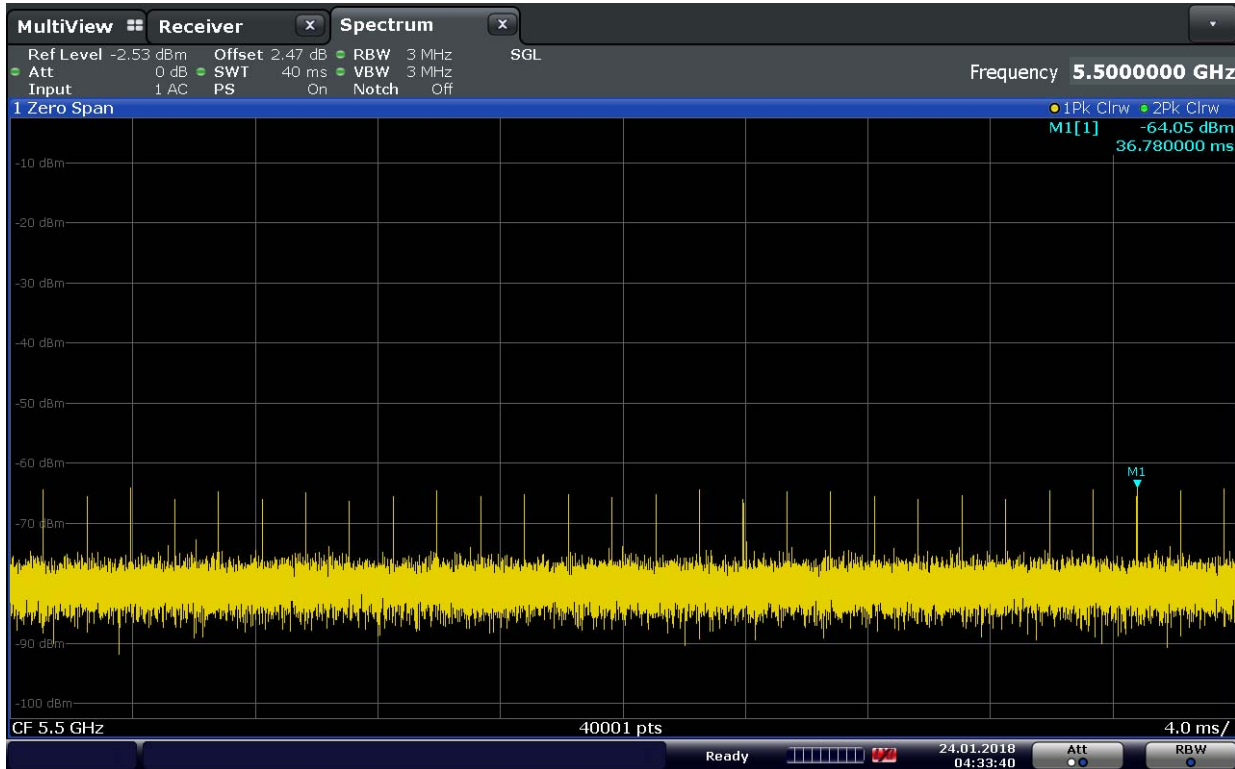
FCC ID: BCGA1954	<b>MEASUREMENT REPORT (CERTIFICATION)</b>		Approved by: Quality Manager
Test Report S/N: 1C1710060006-07.BCG	Test Dates: 10/31-1/31/2018	EUT Type: Tablet Device	Page 17 of 45

## 6.0 RADAR PULSES AND TRAFFIC SIGNALS

### 6.1 Radar Waveform Calibration:

**Radar Pulse Notes:**

The radiated plots of the RADAR pulse signals (Type 0) are given below after performing the system calibration as described in section 3.6,



**Figure 6-1. 5500MHz - RADAR Pulses Type 0 (20MHz)**

FCC ID: BCGA1954	<b>PCTEST</b> ENGINEERING LABORATORY, INC.		<b>MEASUREMENT REPORT (CERTIFICATION)</b>	Approved by: Quality Manager
Test Report S/N: 1C1710060006-07.BCG	Test Dates: 10/31-1/31/2018	EUT Type: Tablet Device		Page 18 of 45

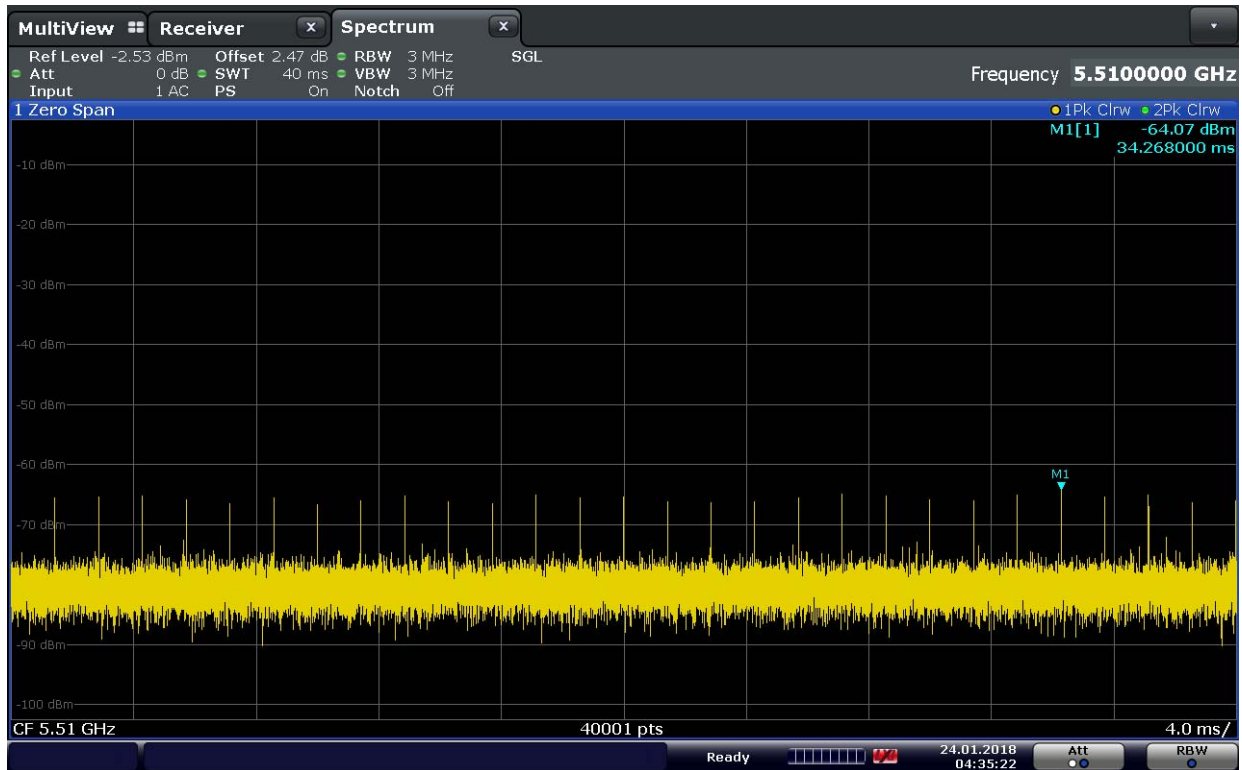


Figure 6-2. 5510MHz - RADAR Pulses Type 0 (40MHz)

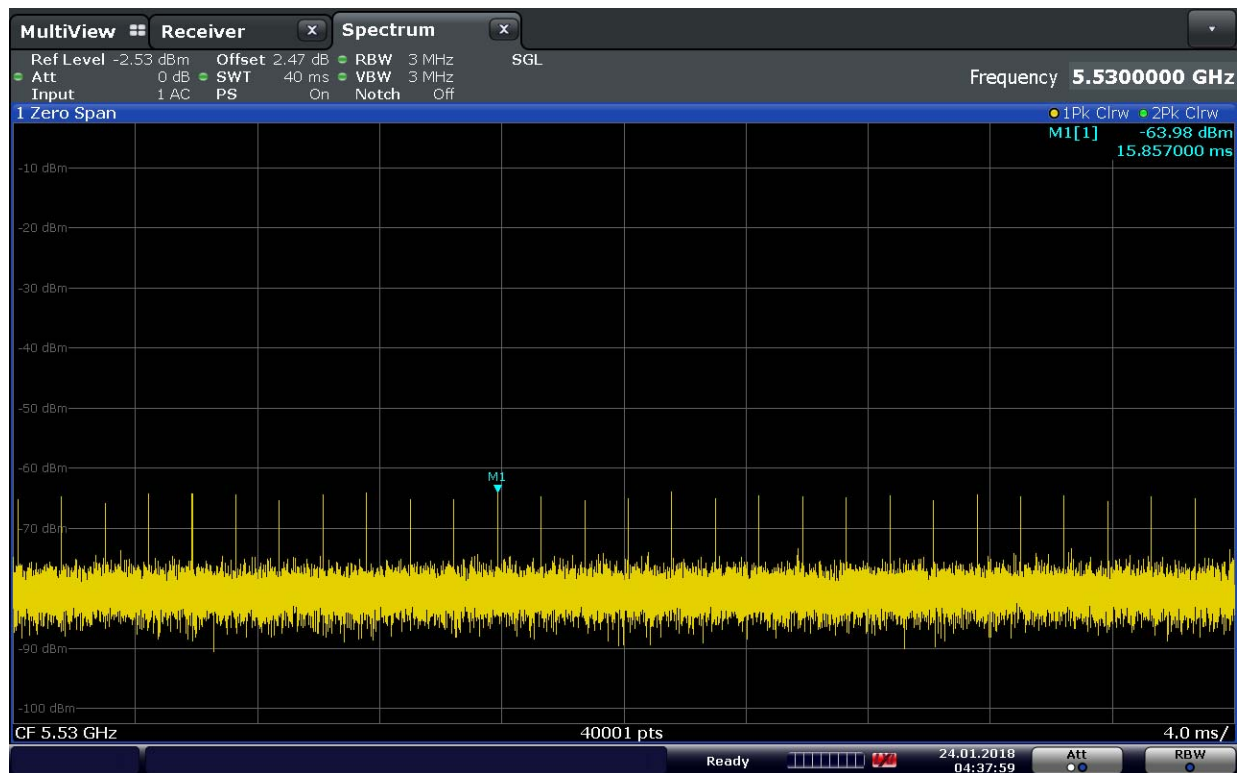


Figure 6-3. 5530MHz - RADAR Pulses Type 0 (80MHz)

FCC ID: BCGA1954	<b>PCTEST</b> ENGINEERING LABORATORY, INC.		<b>MEASUREMENT REPORT</b> (CERTIFICATION)	Approved by: Quality Manager
Test Report S/N: 1C1710060006-07.BCG	Test Dates: 10/31-1/31/2018	EUT Type: Tablet Device		Page 19 of 45

## 6.1 Traffic Signal:

### Traffic Signal Notes:

The traffic signals were generated by the EUT different modes of operations, and the corresponding plots were captured accordingly.

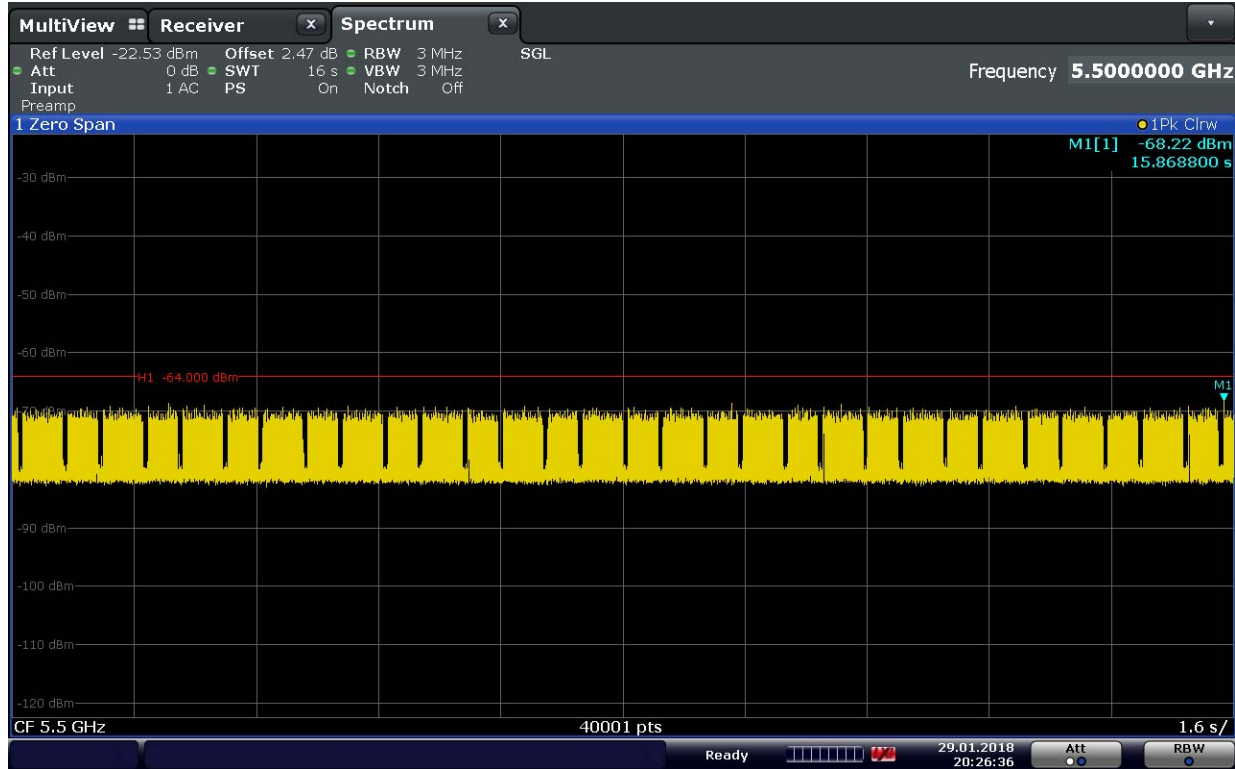


Figure 6-4. 5500MHz - Traffic Signals Type 0 (20MHz)

FCC ID: BCGA1954	<b>PCTEST</b> ENGINEERING LABORATORY, INC.		<b>MEASUREMENT REPORT (CERTIFICATION)</b>	Approved by: Quality Manager
Test Report S/N: 1C1710060006-07.BCG	Test Dates: 10/31-1/31/2018	EUT Type: Tablet Device		Page 20 of 45

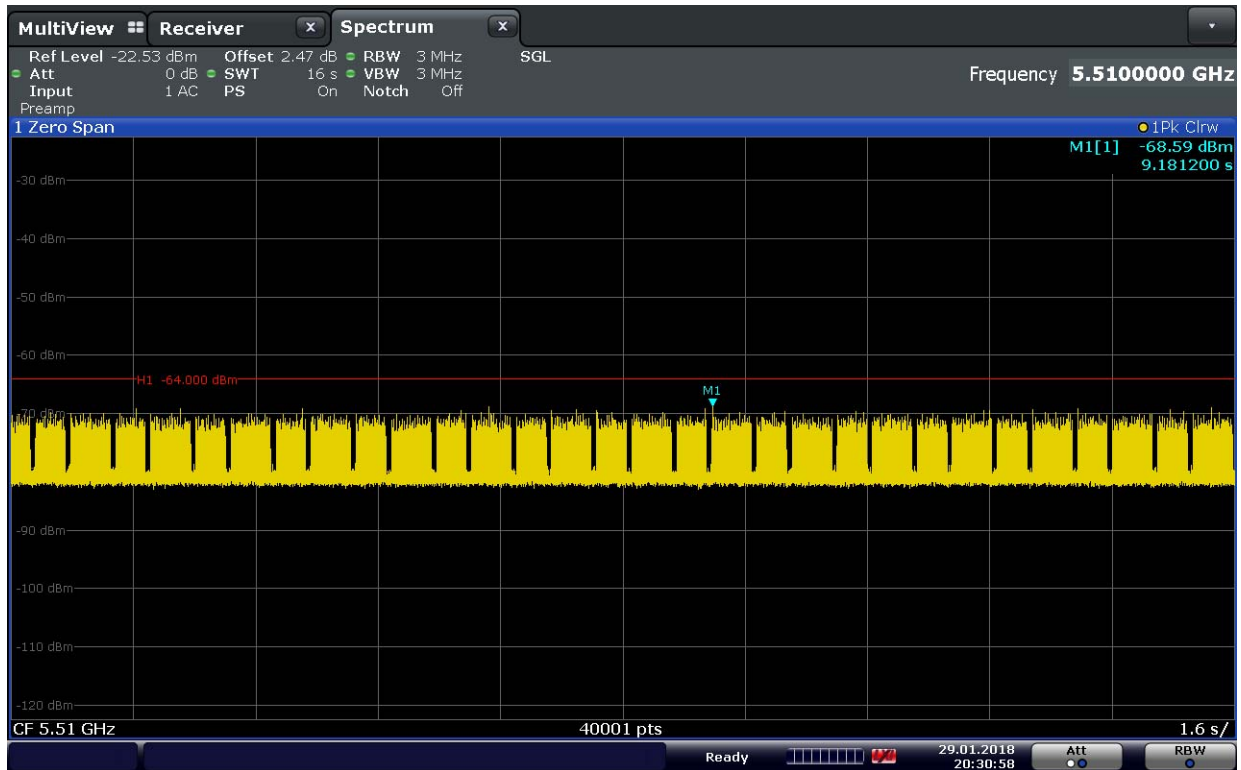


Figure 6-5. 5510MHz - Traffic Signals Type 0 (40MHz)

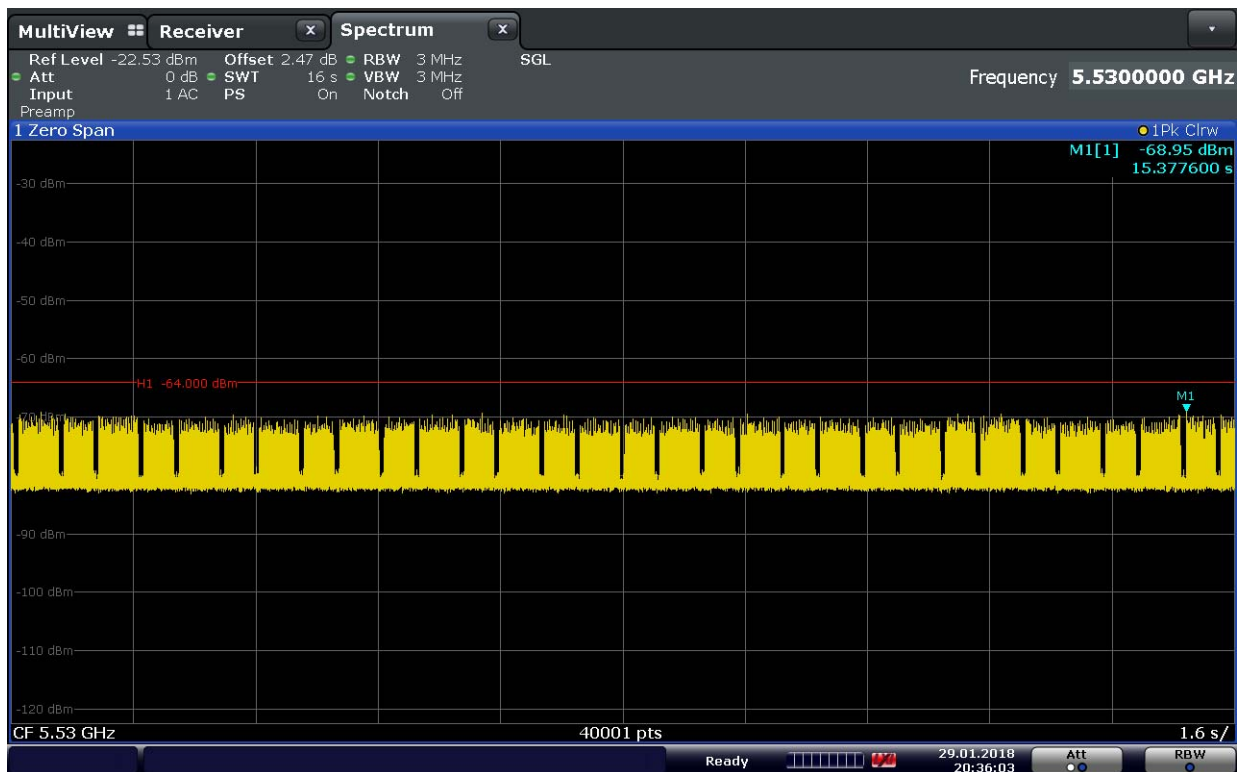


Figure 6-6. 5530MHz - Traffic Signals Type 0 (80MHz)

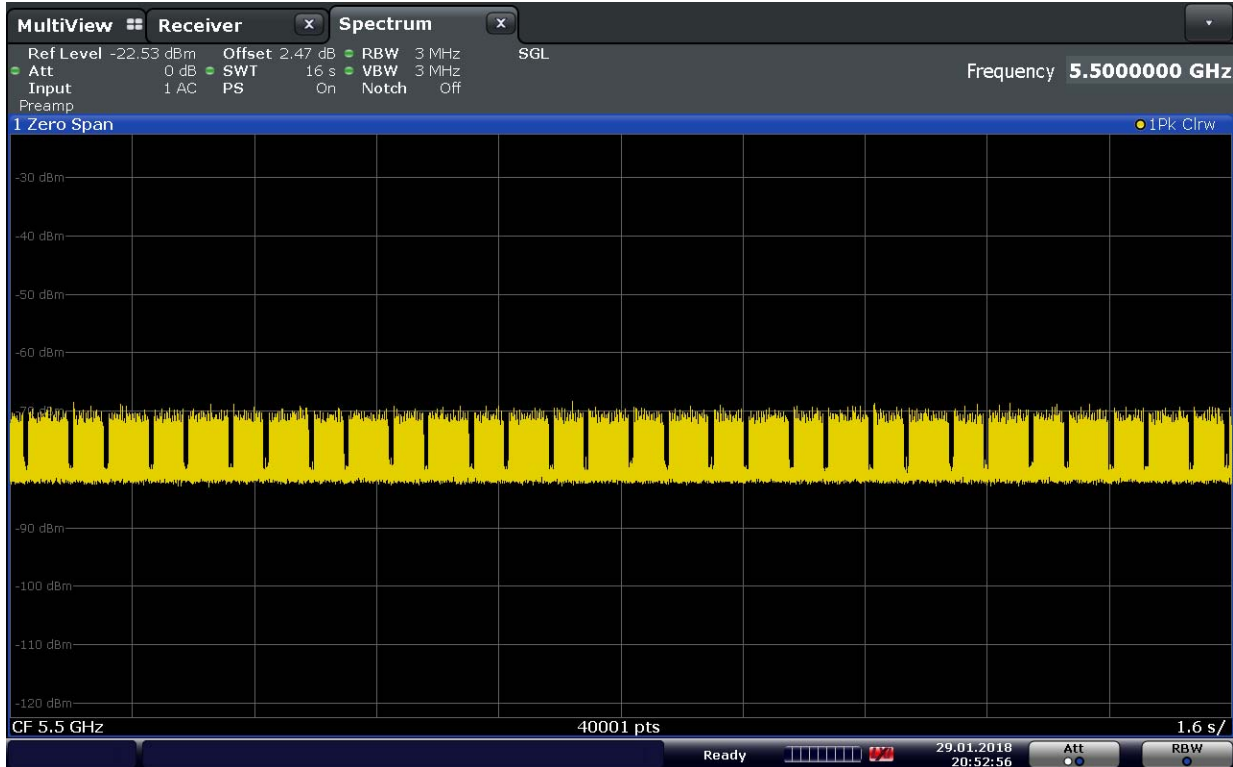
FCC ID: BCGA1954	<b>PCTEST</b> ENGINEERING LABORATORY, INC.		MEASUREMENT REPORT (CERTIFICATION)	Approved by: Quality Manager
Test Report S/N: 1C1710060006-07.BCG	Test Dates: 10/31-1/31/2018	EUT Type: Tablet Device	Page 21 of 45	

# 7.0 TEST RESULTS - CHANNEL LOADING

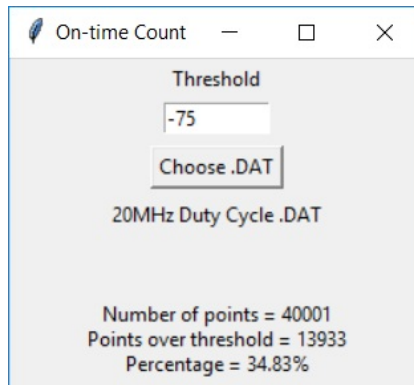
## 7.1 Channel Loading Mode1/Mode2:

### Channel Loading Notes:

Per KDB 905462 D02 v02, timing plots are required with calculations demonstrating a minimum channel loading of approximately 17% or greater. For example, you can zero span the spectrum analyzer and approximate the transmission time.

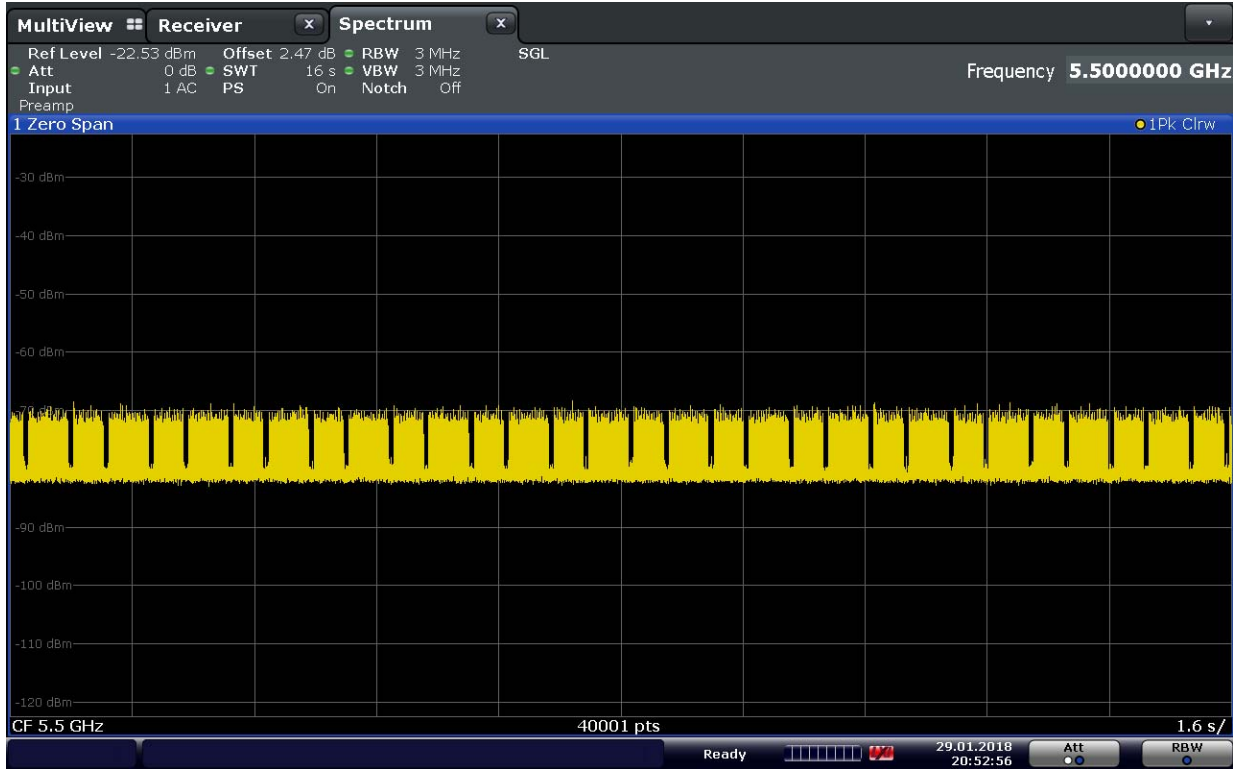


**Figure 7-1. 5500MHz - Channel Loading (20MHz)**

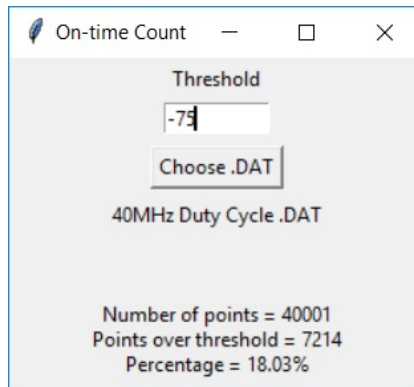


**Figure 7-2. 5500MHz - Channel Loading Calculation (20MHz)**

FCC ID: BCGA1954	<b>MEASUREMENT REPORT (CERTIFICATION)</b>		Approved by: Quality Manager
Test Report S/N: 1C1710060006-07.BCG	Test Dates: 10/31-1/31/2018	EUT Type: Tablet Device	Page 22 of 45



**Figure 7-3. 5510MHz - Band - Channel Loading (40MHz)**



**Figure 7-4 5510MHz - Channel Loading Calculation (40MHz)**

FCC ID: BCGA1954	<b>PCTEST</b> ENGINEERING LABORATORY, INC.		<b>MEASUREMENT REPORT (CERTIFICATION)</b>	Approved by: Quality Manager
Test Report S/N: 1C1710060006-07.BCG	Test Dates: 10/31-1/31/2018	EUT Type: Tablet Device		Page 23 of 45

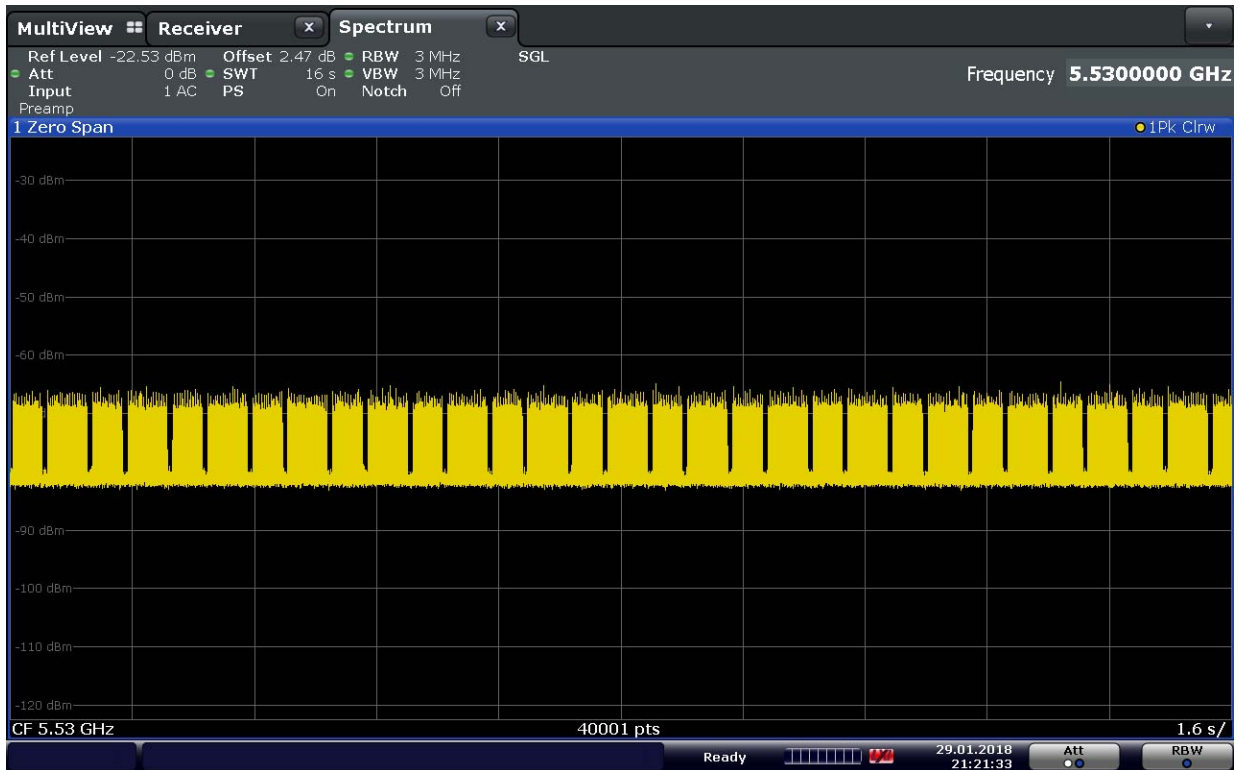


Figure 7-5. 5530MHz - Channel Loading (80MHz)

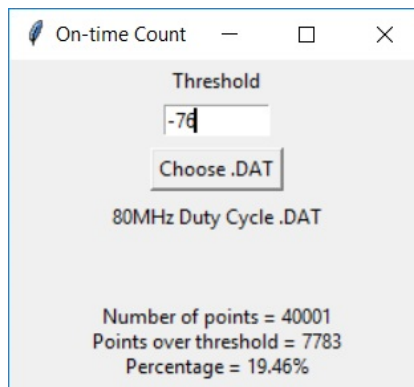


Figure 7-6. 5530MHz - Channel Loading Calculation (80MHz)

FCC ID: BCGA1954	<b>PCTEST</b> ENGINEERING LABORATORY, INC.		MEASUREMENT REPORT (CERTIFICATION)	Approved by: Quality Manager
Test Report S/N: 1C1710060006-07.BCG	Test Dates: 10/31-1/31/2018	EUT Type: Tablet Device	Page 24 of 45	



## 7.2 Channel Loading Mode3/Mode4:

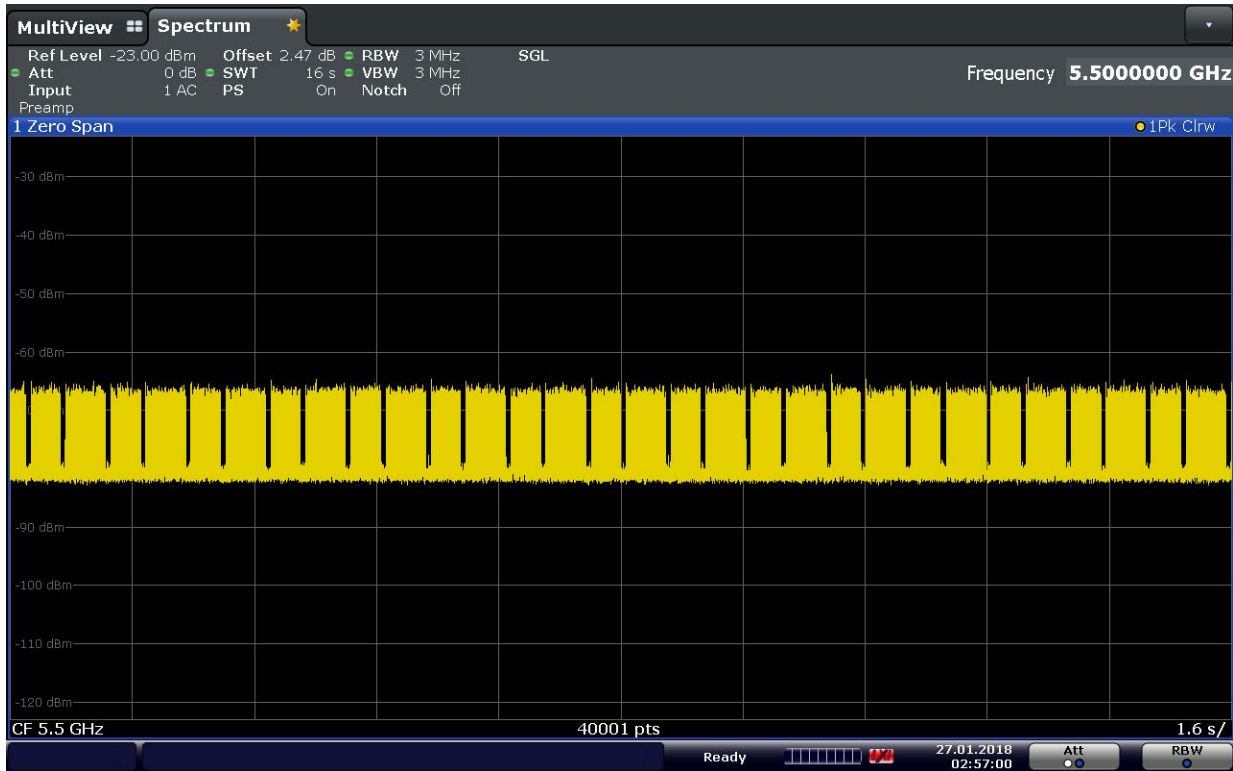


Figure 7-7. 5500 MHz - Channel Loading (20MHz)

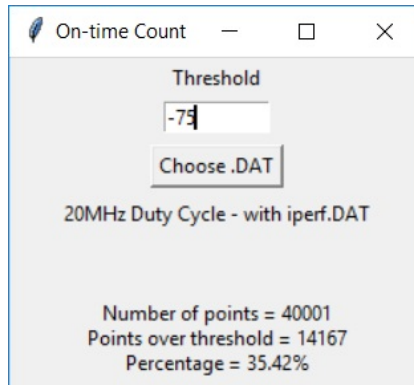
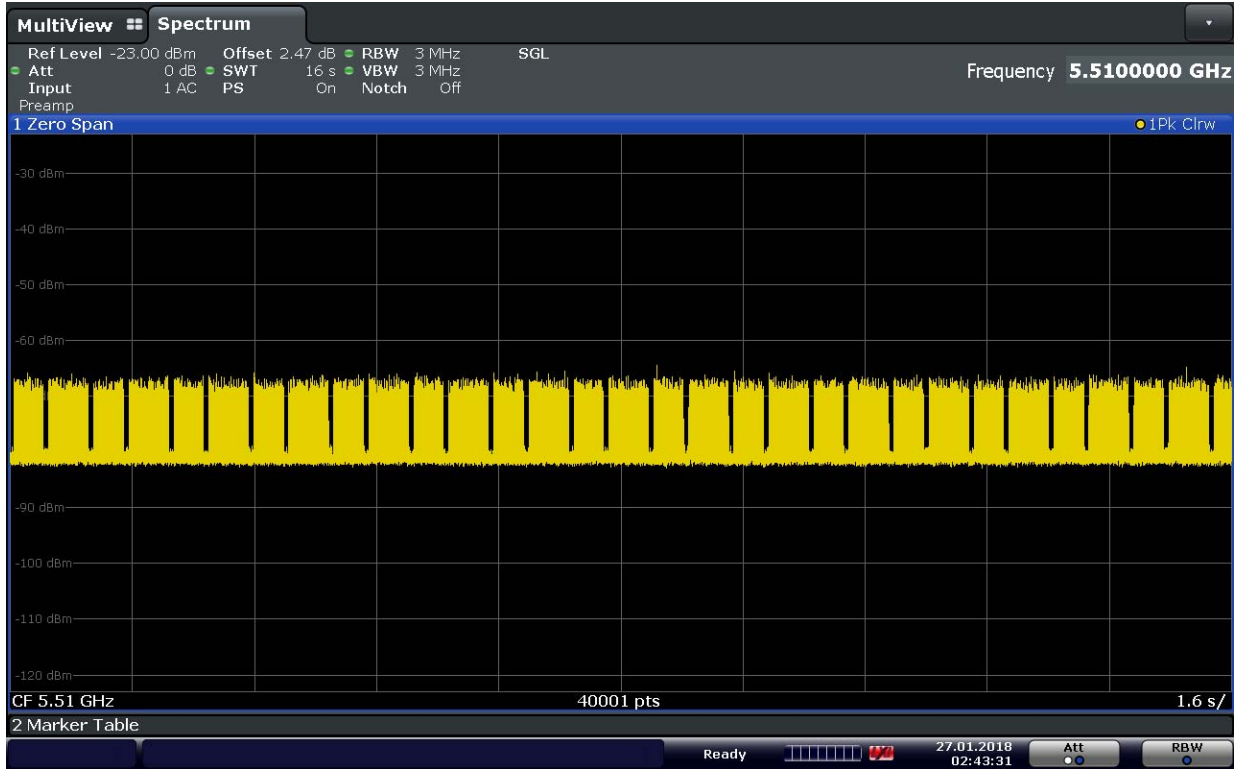
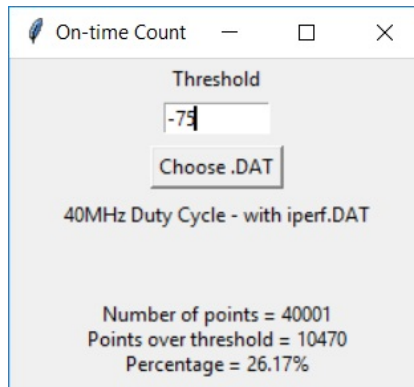


Figure 7-8. 5500MHz - Channel Loading Calculation (20MHz)

FCC ID: BCGA1954	<b>PCTEST</b> ENGINEERING LABORATORY, INC.		<b>MEASUREMENT REPORT (CERTIFICATION)</b>	Approved by: Quality Manager
Test Report S/N: 1C1710060006-07.BCG	Test Dates: 10/31-1/31/2018	EUT Type: Tablet Device		Page 25 of 45

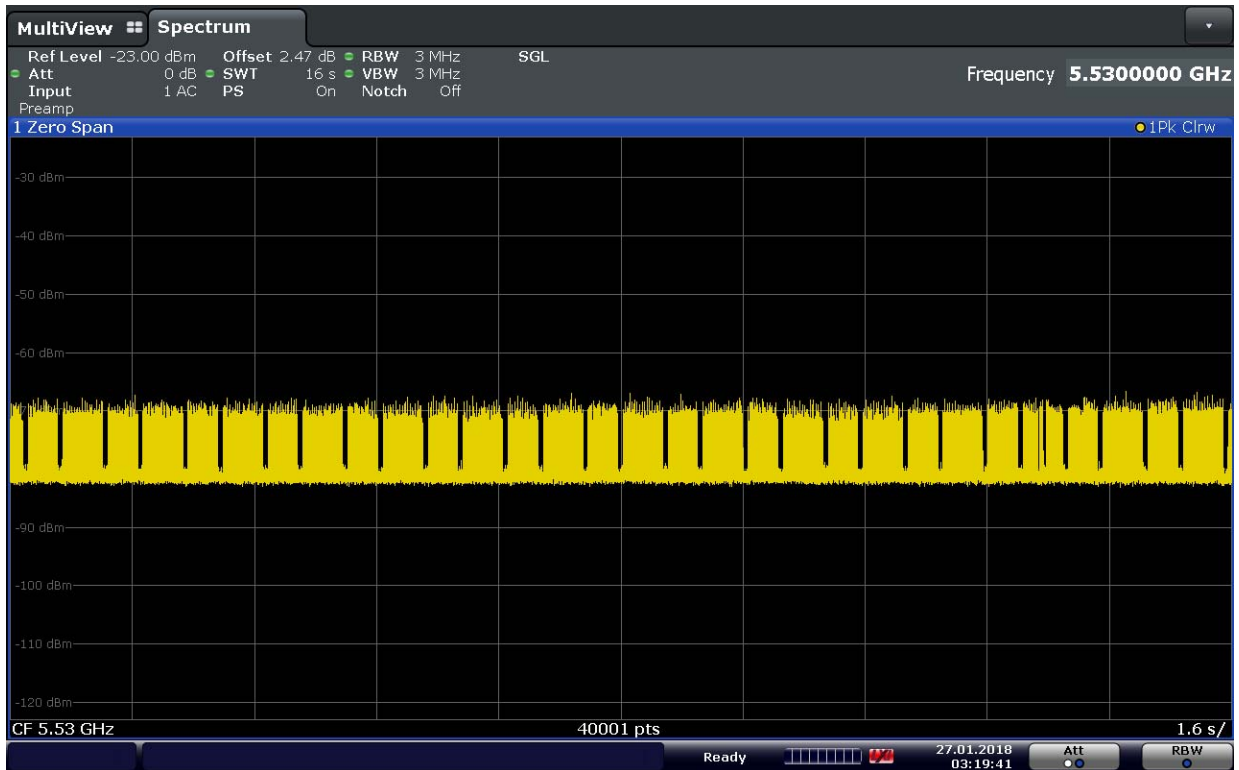


**Figure 7-9. 5510MHz - Channel Loading (40MHz)**

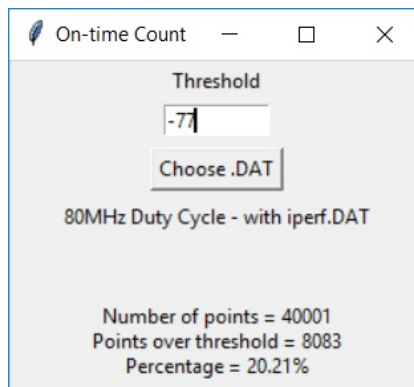


**Figure 7-10. 5510MHz - Channel Loading Calculation (40MHz)**

FCC ID: BCGA1954	<b>PCTEST</b> ENGINEERING LABORATORY, INC.		MEASUREMENT REPORT (CERTIFICATION)	Approved by: Quality Manager
Test Report S/N: 1C1710060006-07.BCG	Test Dates: 10/31-1/31/2018	EUT Type: Tablet Device	Page 26 of 45	



**Figure 7-11. 5530MHz - Channel Loading (80MHz)**



**Figure 7-12. 5530MHz - Channel Loading Calculation (80MHz)**

FCC ID: BCGA1954	<b>PCTEST</b> ENGINEERING LABORATORY, INC.		<b>MEASUREMENT REPORT (CERTIFICATION)</b>	Approved by: Quality Manager
Test Report S/N: 1C1710060006-07.BCG	Test Dates: 10/31-1/31/2018	EUT Type: Tablet Device		Page 27 of 45

# 8.0 TEST RESULTS - MOVE TIME AND AGGREGATE TIME

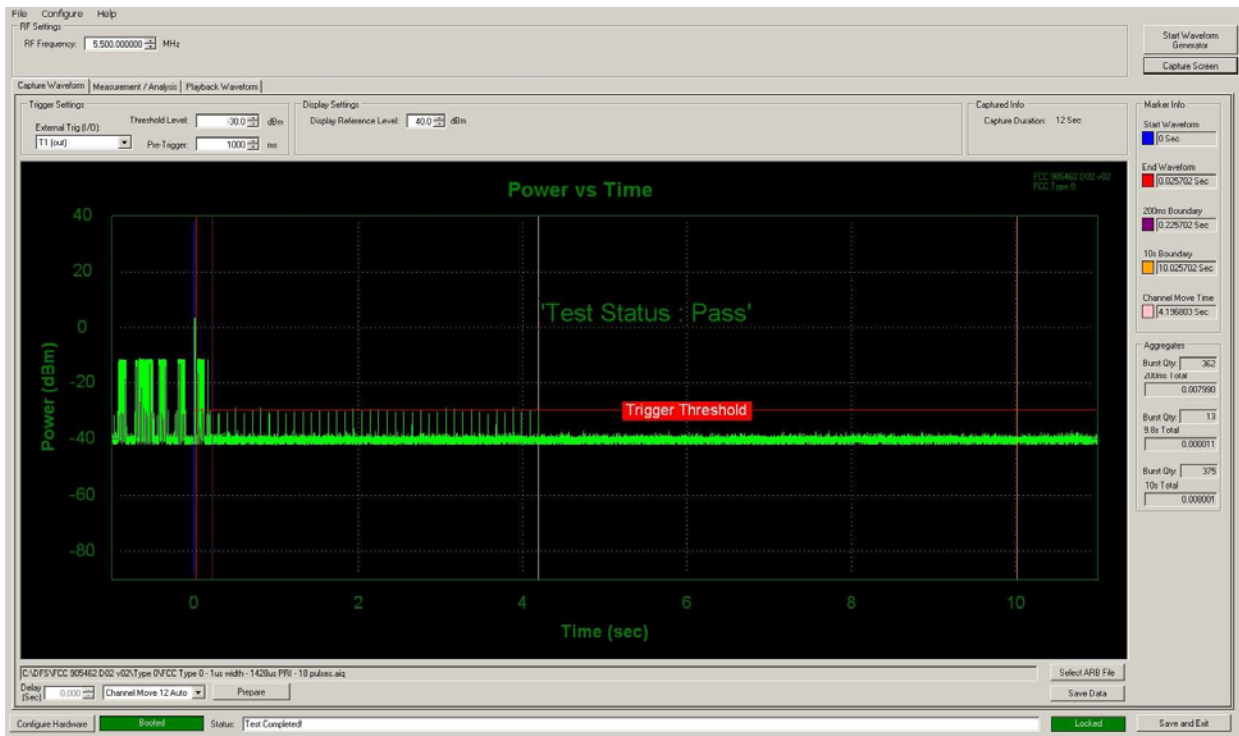
## 8.1 Move Time and Aggregate Time Mode 1:

### Result

Parameter	Measured			Limit
	20MHz Bandwidth	40MHz Bandwidth	80MHz Bandwidth	
Channel Move Time	4.196 s	0.088 s	0.072 s	10 seconds
Channel Closing Transmission Time	< 200ms + 8.001 ms (aggregate)	< 200ms + 0.067 ms (aggregate)	< 200ms + 0.118 ms (aggregate)	200 ms + aggregate of 60ms over remaining 10 second period

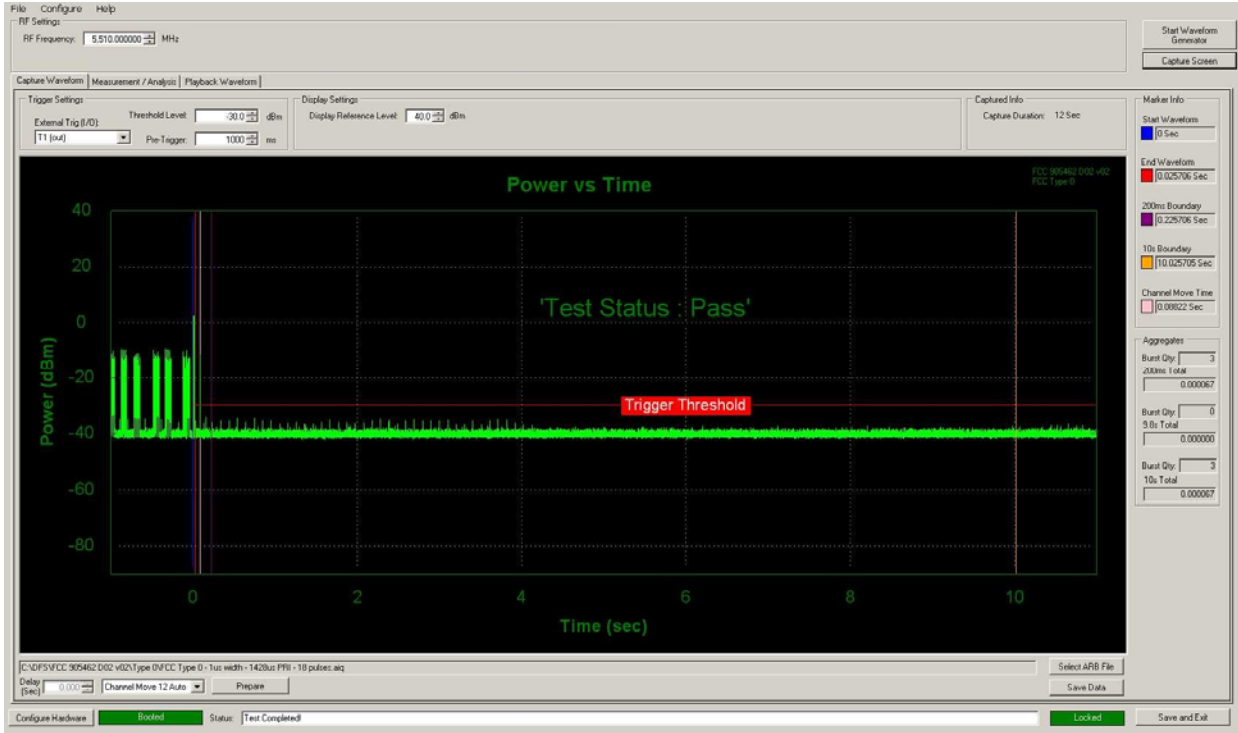
### Notes:

1. Trigger Threshold was configured to only capture client pulses. The pulses shown in the plots below have been determined to be from the Master AP.
2. Marker Info and Aggregate time results are shown on the right side of the plots below.

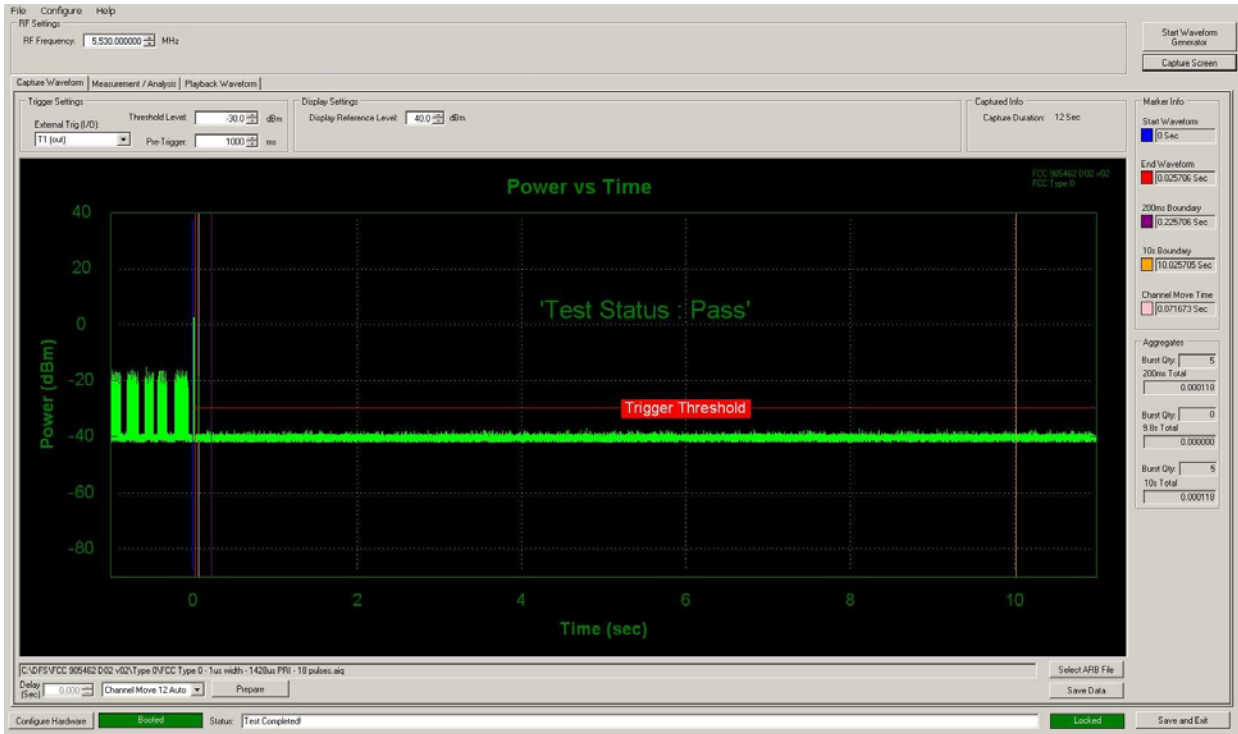


**Figure 8-1. 5500MHz - Move Time and Aggregate Time (20 MHz)**

FCC ID: BCGA1954	<b>MEASUREMENT REPORT (CERTIFICATION)</b>		Approved by: Quality Manager
Test Report S/N: 1C1710060006-07.BCG	Test Dates: 10/31-1/31/2018	EUT Type: Tablet Device	Page 28 of 45



**Figure 8-2. 5510MHz - Move Time and Aggregate Time (40 MHz)**



**Figure 8-3. 5530MHz - Move Time and Aggregate Time (80 MHz)**

<b>FCC ID:</b> BCGA1954	 <b>MEASUREMENT REPORT (CERTIFICATION)</b>		<b>Approved by:</b> Quality Manager
<b>Test Report S/N:</b> 1C1710060006-07.BCG	<b>Test Dates:</b> 10/31-1/31/2018	<b>EUT Type:</b> Tablet Device	Page 29 of 45

## 8.2 Move Time and Aggregate Time Mode 2:

### Result:

Parameter	Measured			Limit
	20MHz Bandwidth	40MHz Bandwidth	80MHz Bandwidth	
Channel Move Time	4.999 s	0.144 s	0.208 s	10 seconds
Channel Closing Transmission Time	< 200ms + 2.012 ms (aggregate)	< 200ms + 13.660 ms (aggregate)	< 200ms + 4.561 ms (aggregate)	200 ms + aggregate of 60ms over remaining 10 second period

### Notes:

1. Trigger Threshold was configured to only capture client pulses. The pulses shown in the plots below have been determined to be from the Master AP.
2. Marker Info and Aggregate time results are shown on the right side of the plots below.

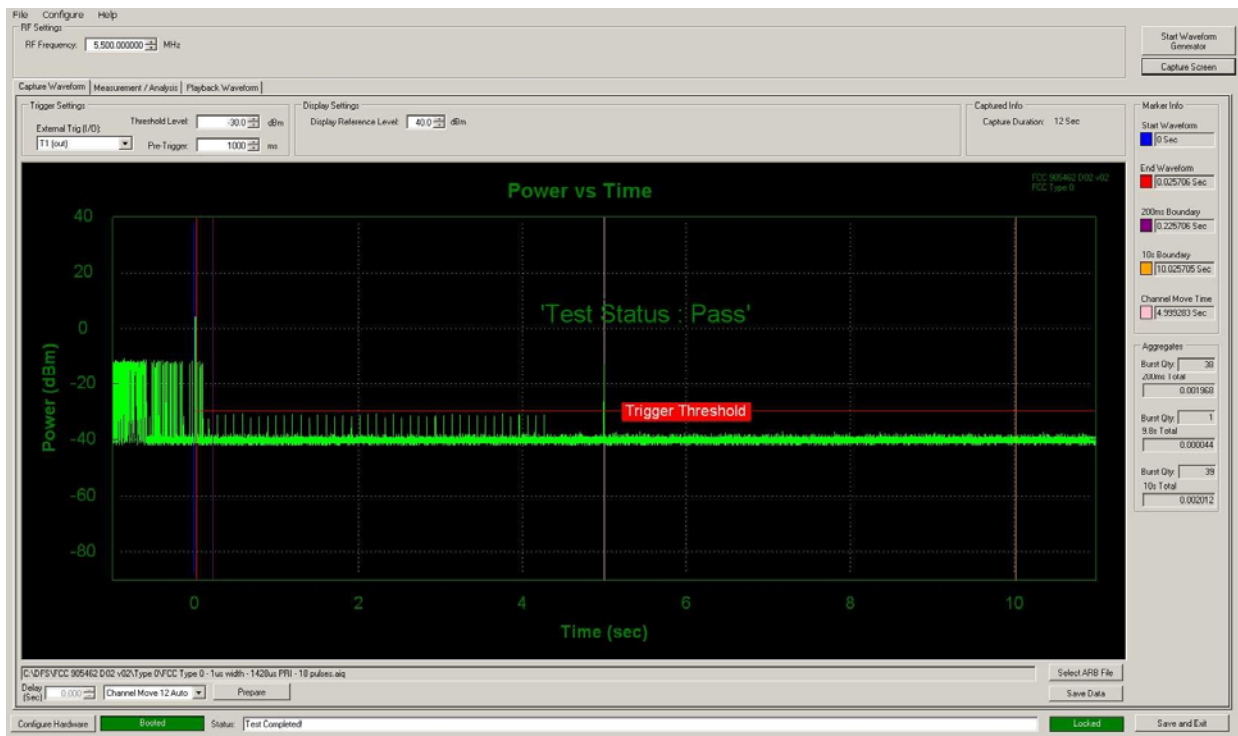


Figure 8-4. 5500MHz - Move Time and Aggregate Time (20 MHz)

FCC ID: BCGA1954	<b>MEASUREMENT REPORT (CERTIFICATION)</b>		Approved by: Quality Manager
Test Report S/N: 1C1710060006-07.BCG	Test Dates: 10/31-1/31/2018	EUT Type: Tablet Device	Page 30 of 45

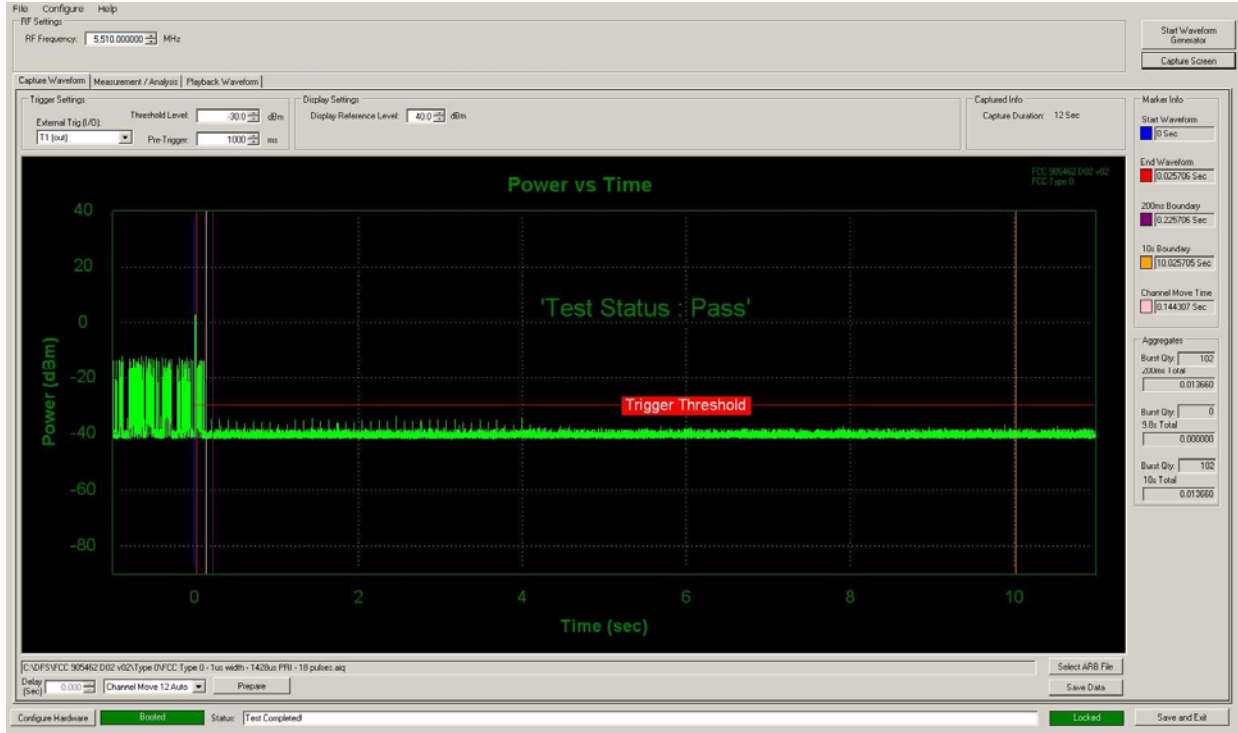


Figure 8-5. 5510MHz - Move Time and Aggregate Time (40 MHz)

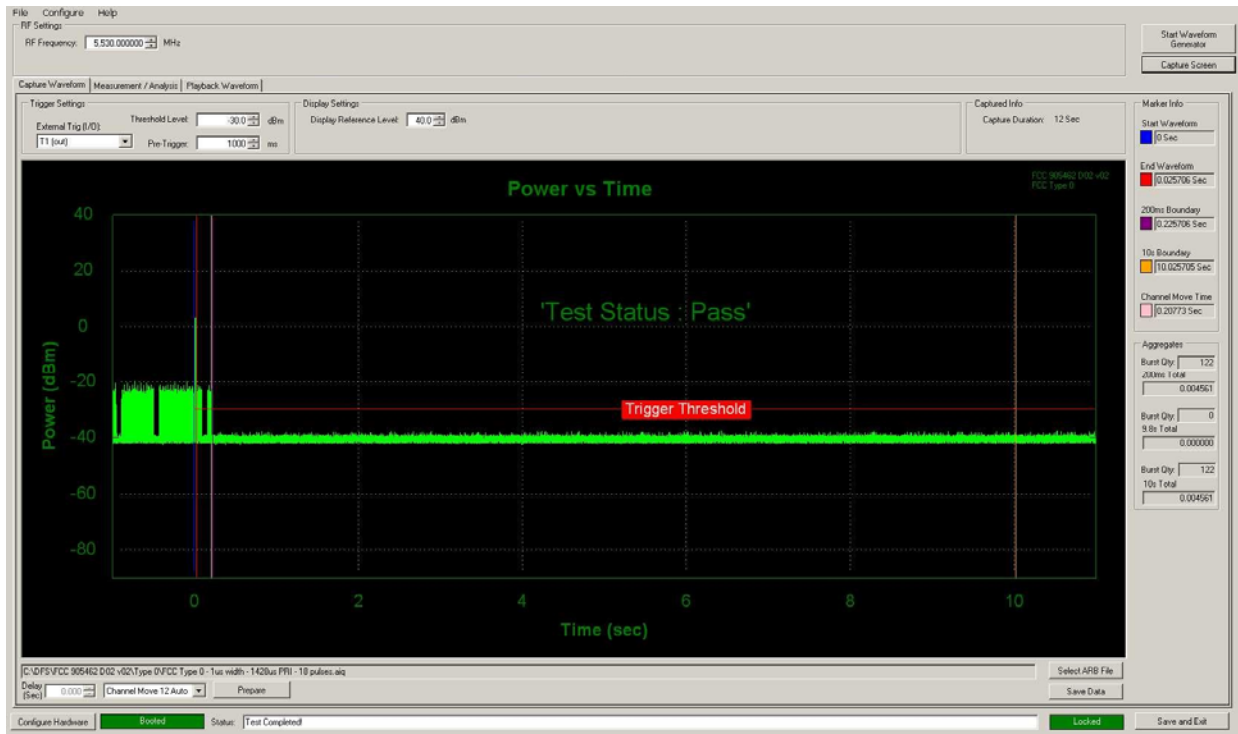


Figure 8-6. 5530MHz - Move Time and Aggregate Time (80 MHz)

FCC ID: BCGA1954		MEASUREMENT REPORT (CERTIFICATION)	Approved by: Quality Manager
Test Report S/N: 1C1710060006-07.BCG	Test Dates: 10/31-1/31/2018	EUT Type: Tablet Device	Page 31 of 45

### 8.3 Move Time and Aggregate Time Mode 3:

**Result:**

Parameter	Measured			Limit
	20MHz Bandwidth	40MHz Bandwidth	80MHz Bandwidth	
Channel Move Time	4.113 s	0.170 s	0.140 s	10 seconds
Channel Closing Transmission Time	< 200ms + 16.850 ms (aggregate)	< 200ms + 12.918 ms (aggregate)	< 200ms + 5.446 ms (aggregate)	200 ms + aggregate of 60ms over remaining 10 second period

**Notes:**

1. Trigger Threshold was configured to only capture client pulses. The pulses shown in the plots below have been determined to be from the Master AP.
2. Marker Info and Aggregate time results are shown on the right side of the plots below.

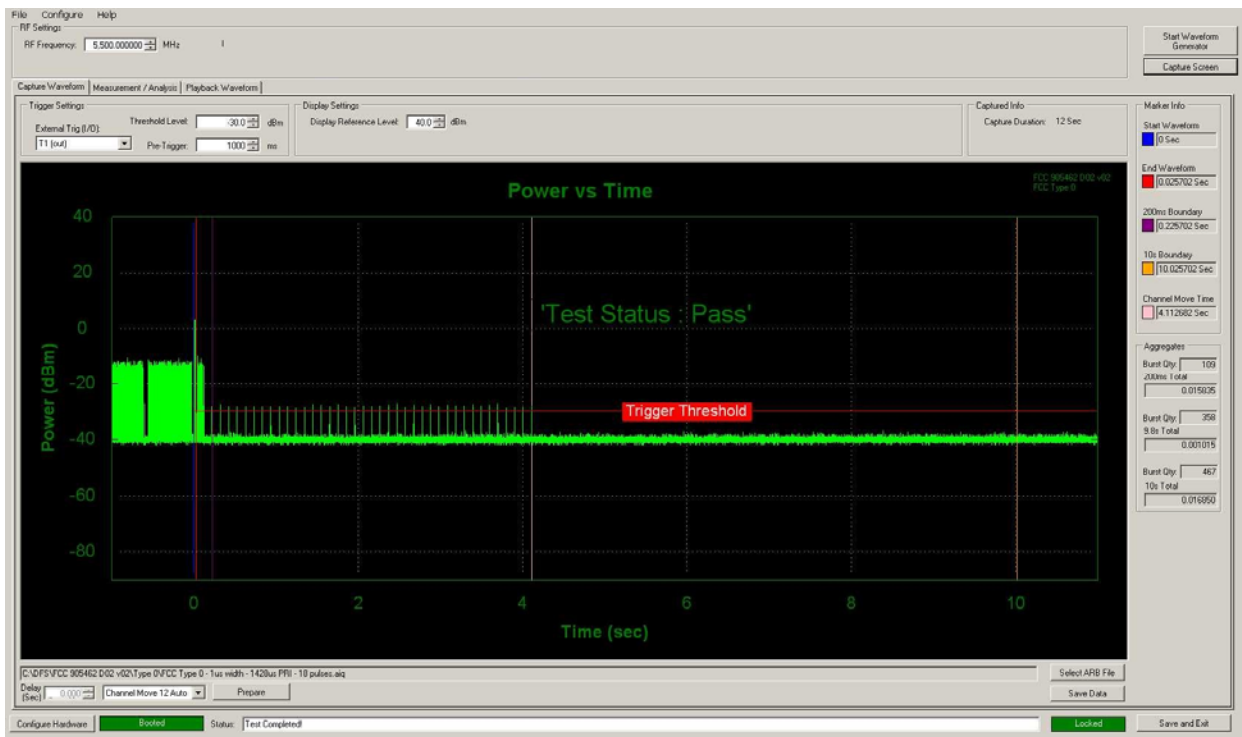
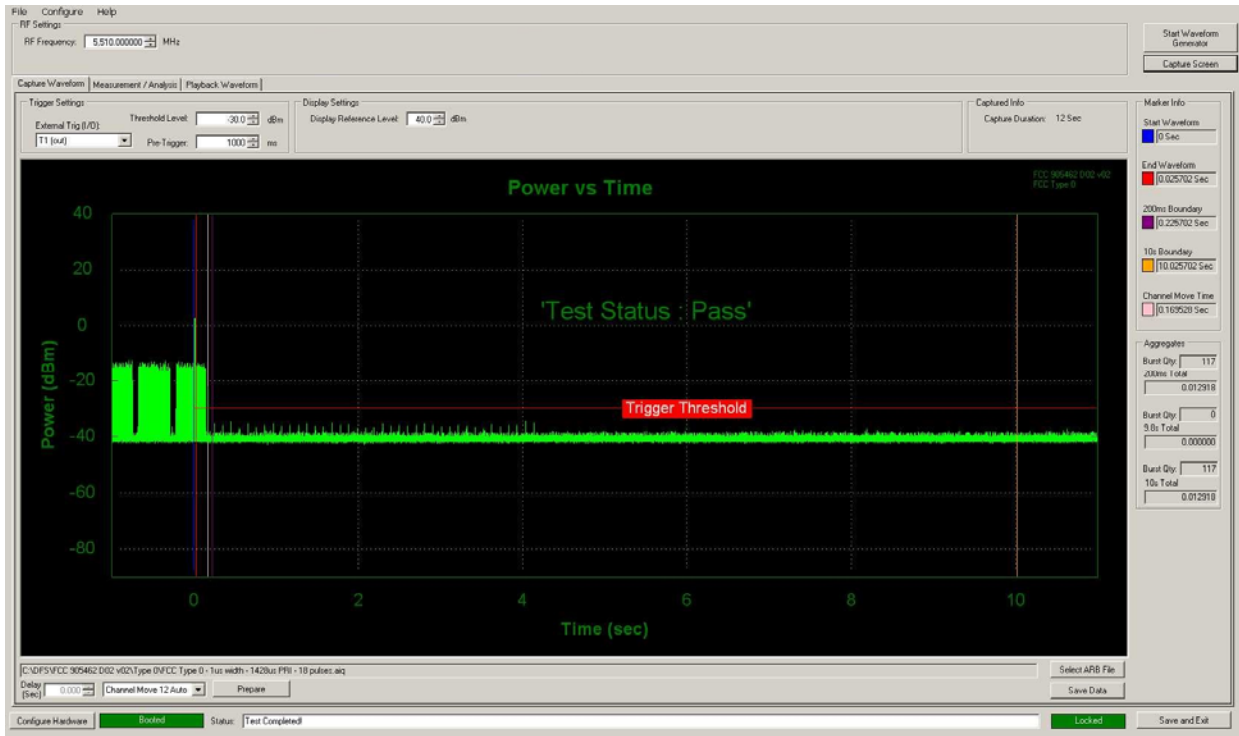


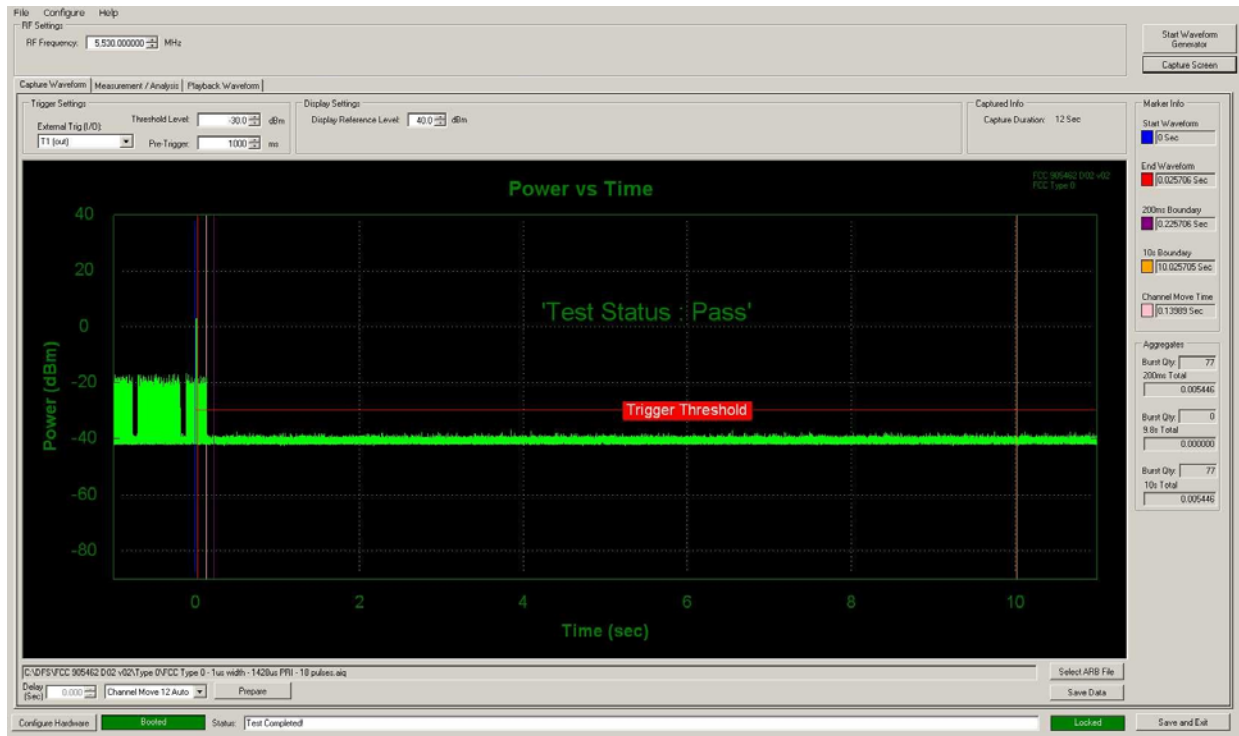
Figure 8-7. 5500MHz - Move Time and Aggregate Time (20 MHz)

FCC ID: BCGA1954			MEASUREMENT REPORT (CERTIFICATION)	Approved by: Quality Manager
Test Report S/N: 1C1710060006-07.BCG	Test Dates: 10/31-1/31/2018	EUT Type: Tablet Device	Page 32 of 45	





**Figure 8-8. 5510MHz - Move Time and Aggregate Time (40 MHz)**



**Figure 8-9. 5530MHz - Move Time and Aggregate Time (80 MHz)**

<b>FCC ID:</b> BCGA1954	<b>PCTEST</b> ENGINEERING LABORATORY, INC.		<b>MEASUREMENT REPORT</b> (CERTIFICATION)	<b>Approved by:</b> Quality Manager
<b>Test Report S/N:</b> 1C1710060006-07.BCG	<b>Test Dates:</b> 10/31-1/31/2018	<b>EUT Type:</b> Tablet Device		Page 33 of 45

## 8.4 Move Time and Aggregate Time Mode 4:

### Result:

Parameter	Measured			Limit
	20MHz Bandwidth	40MHz Bandwidth	80MHz Bandwidth	
Channel Move Time	1.434 s	0.069 s	0.235 s	10 seconds
Channel Closing Transmission Time	< 200ms + 9.223 ms (aggregate)	< 200ms + 2.959 ms (aggregate)	< 200ms + 5.884 ms (aggregate)	200 ms + aggregate of 60ms over remaining 10 second period

### Notes:

1. Trigger Threshold was configured to only capture client pulses. The pulses shown in the plots below have been determined to be from the Master AP.
2. Marker Info and Aggregate time results are shown on the right side of the plots below.

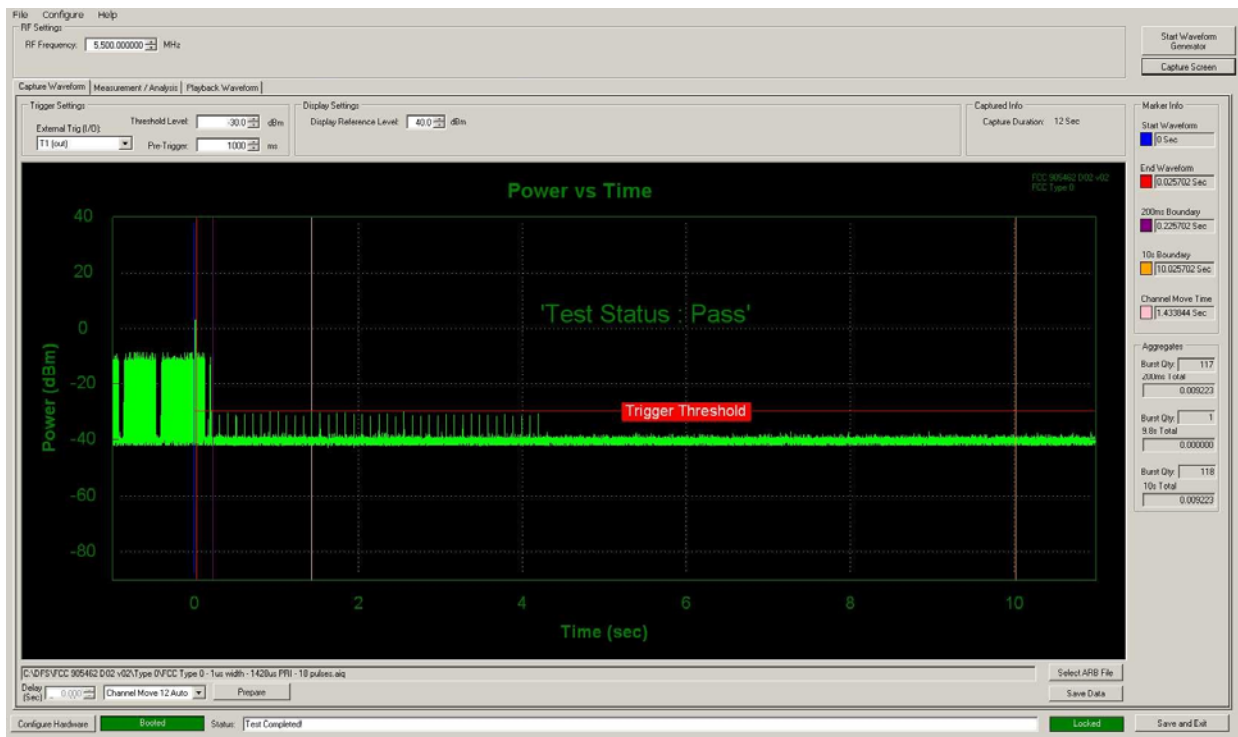


Figure 8-10. 5500MHz - Move Time and Aggregate Time (20 MHz)

FCC ID: BCGA1954	PCTEST ENGINEERING LABORATORY, INC.		MEASUREMENT REPORT (CERTIFICATION)	Approved by: Quality Manager
Test Report S/N: 1C1710060006-07.BCG	Test Dates: 10/31-1/31/2018	EUT Type: Tablet Device	Page 34 of 45	

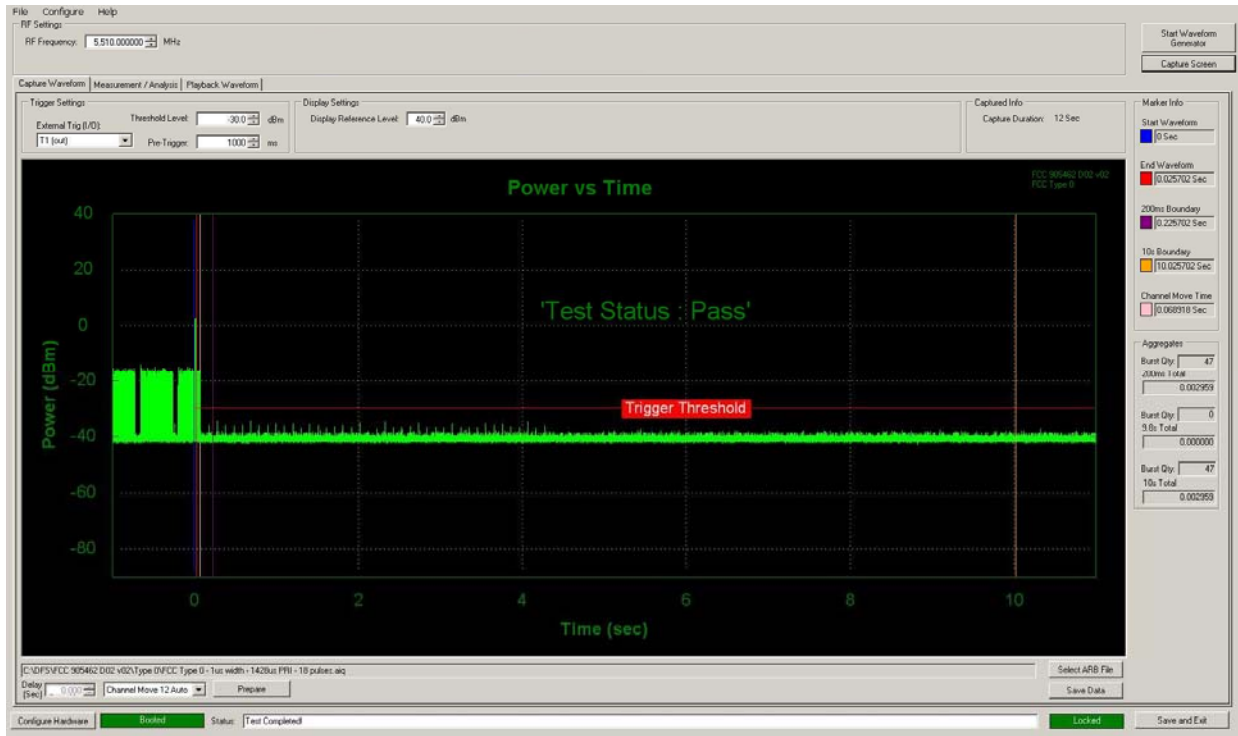


Figure 8-11. 5510MHz - Move Time and Aggregate Time (40 MHz)

FCC ID: BCGA1954	<b>PCTEST</b> ENGINEERING LABORATORY, INC.		<b>MEASUREMENT REPORT</b> (CERTIFICATION)	Approved by: Quality Manager
Test Report S/N: 1C1710060006-07.BCG	Test Dates: 10/31-1/31/2018	EUT Type: Tablet Device		Page 35 of 45

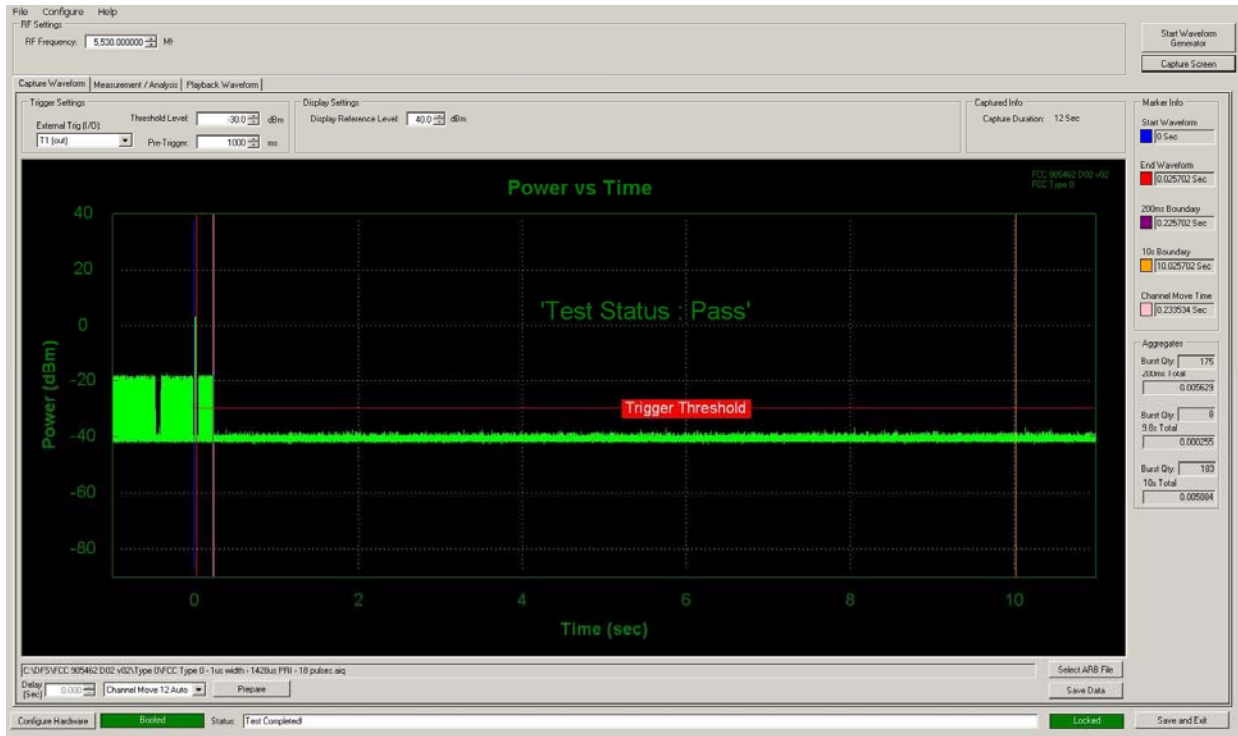


Figure 8-12. 5530MHz - Move Time and Aggregate Time (80 MHz)

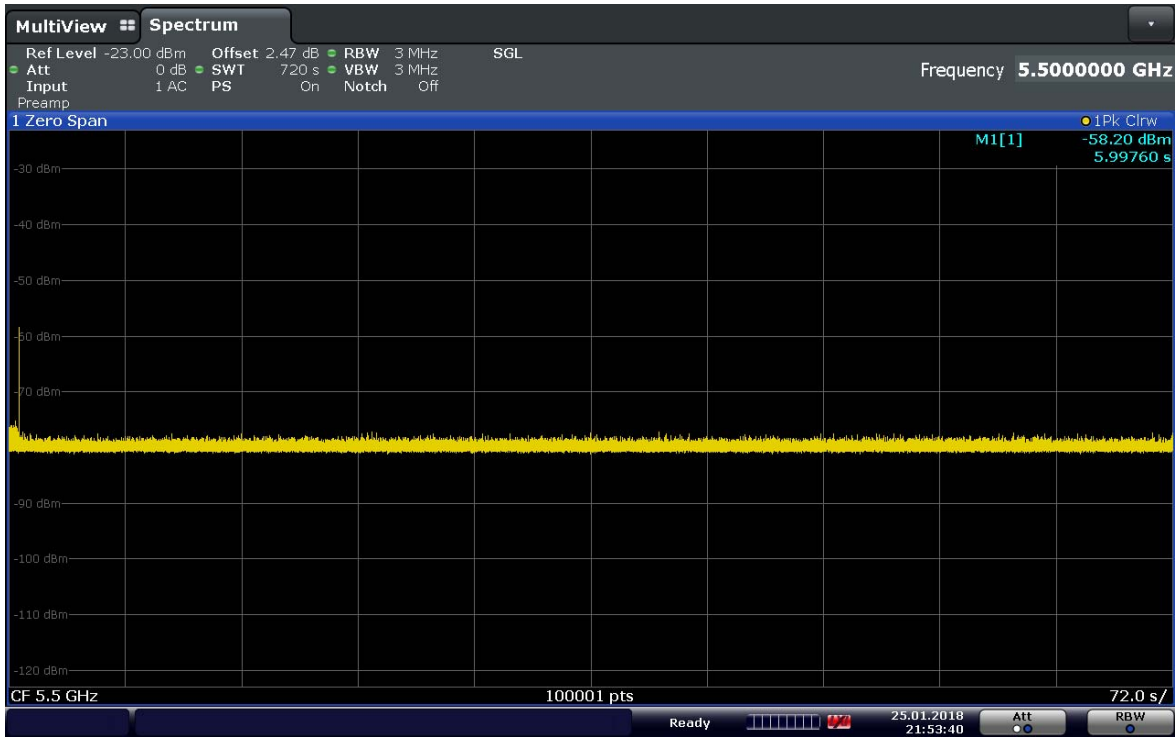
FCC ID: BCGA1954	 <b>MEASUREMENT REPORT (CERTIFICATION)</b>		Approved by: Quality Manager
Test Report S/N: 1C1710060006-07.BCG	Test Dates: 10/31-1/31/2018	EUT Type: Tablet Device	Page 36 of 45

# 9.0 TEST RESULTS - CLIENT BEACON TEST (10 MINUTES)

## 9.1 Monitoring 10 minutes Mode 1:

**Notes:**

1. No frequency transmission detected during the aggregate 10 monitoring period.



**Figure 9-1. 5500MHz - Monitoring 10 minutes (20MHz)**

<b>FCC ID:</b> BCGA1954		<b>MEASUREMENT REPORT (CERTIFICATION)</b>	<b>Approved by:</b> Quality Manager
<b>Test Report S/N:</b> 1C1710060006-07.BCG	<b>Test Dates:</b> 10/31-1/31/2018	<b>EUT Type:</b> Tablet Device	Page 37 of 45

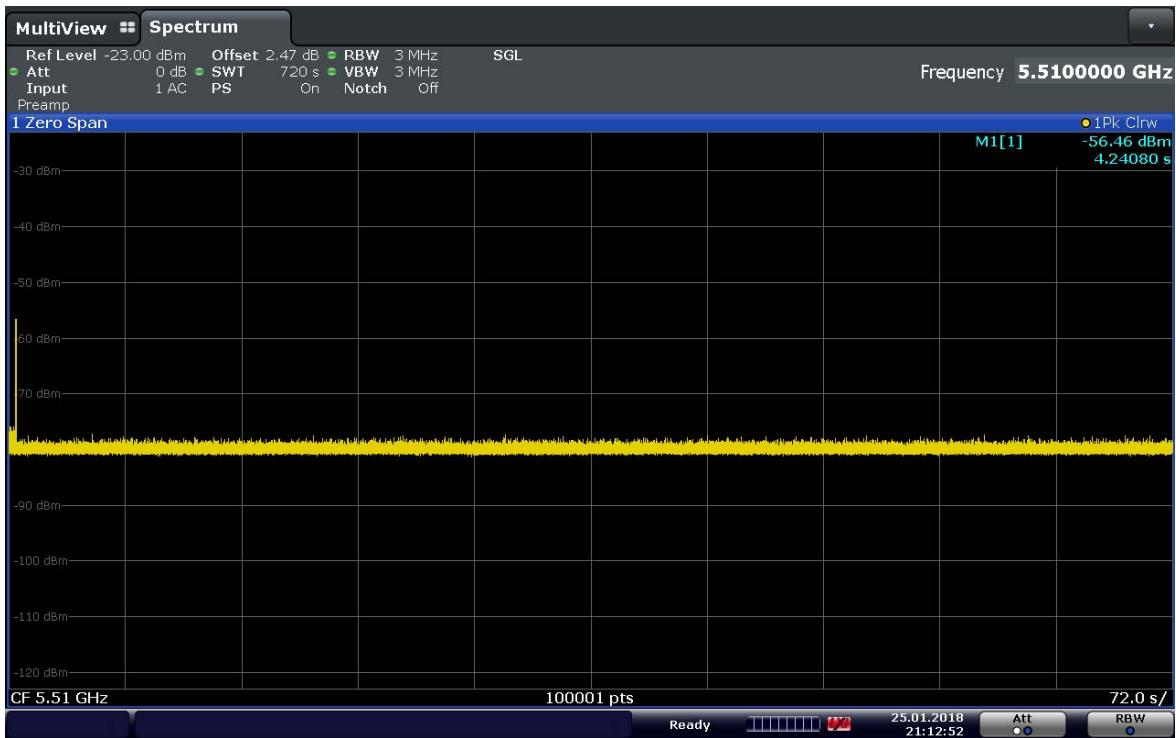


Figure 9-2 5510MHz - Monitoring 10 minutes (40MHz)

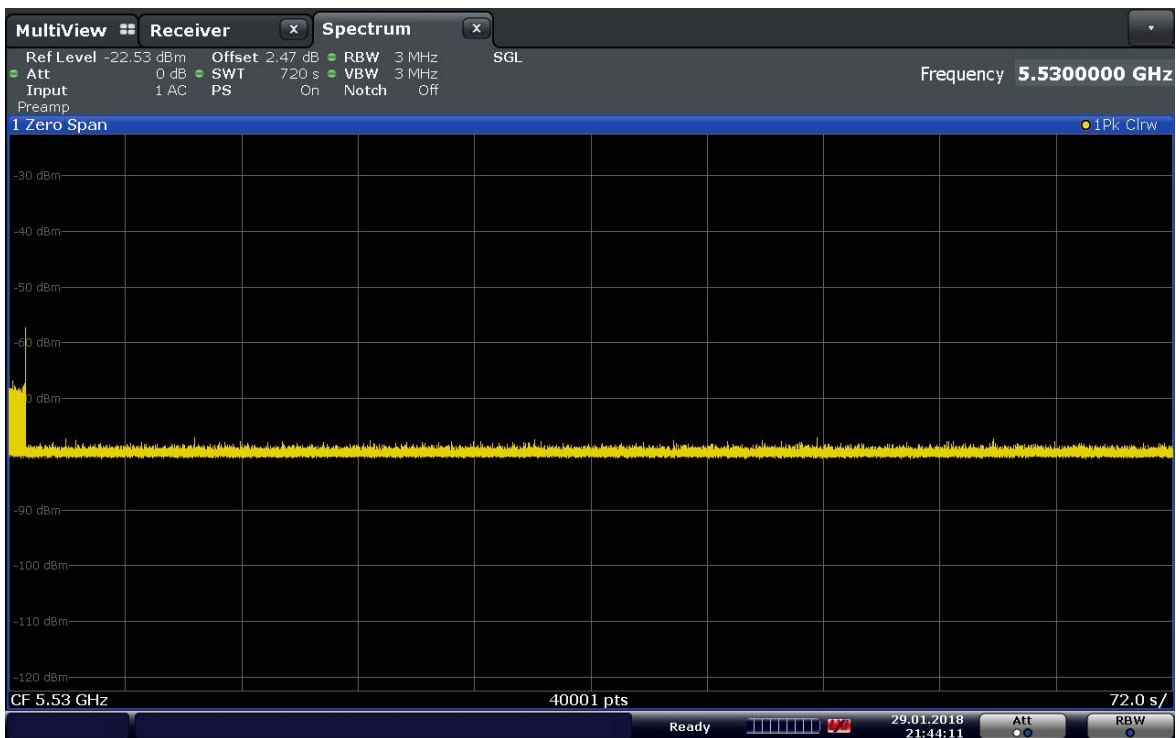


Figure 9-3. 2 5530MHz - Monitoring 10 minutes (80MHz)

FCC ID: BCGA1954	<b>PCTEST</b> ENGINEERING LABORATORY, INC.		<b>MEASUREMENT REPORT (CERTIFICATION)</b>	Approved by: Quality Manager
Test Report S/N: 1C1710060006-07.BCG	Test Dates: 10/31-1/31/2018	EUT Type: Tablet Device		Page 38 of 45

## 9.2 Monitoring 10 minutes Mode 2:

### Notes:

1. No frequency transmission detected during the aggregate 10 monitoring period.

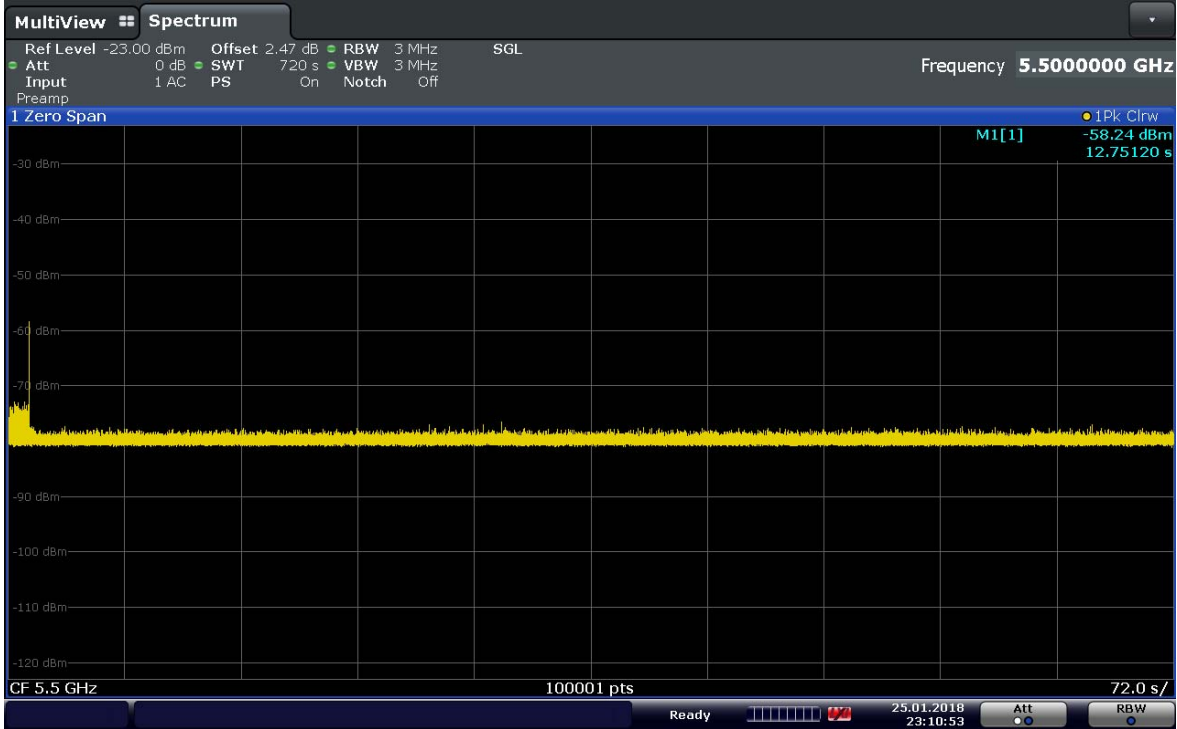


Figure 9-4. 5500MHz - Monitoring 10 minutes (20MHz)

FCC ID: BCGA1954	 <b>MEASUREMENT REPORT (CERTIFICATION)</b>		Approved by: Quality Manager
Test Report S/N: 1C1710060006-07.BCG	Test Dates: 10/31-1/31/2018	EUT Type: Tablet Device	Page 39 of 45

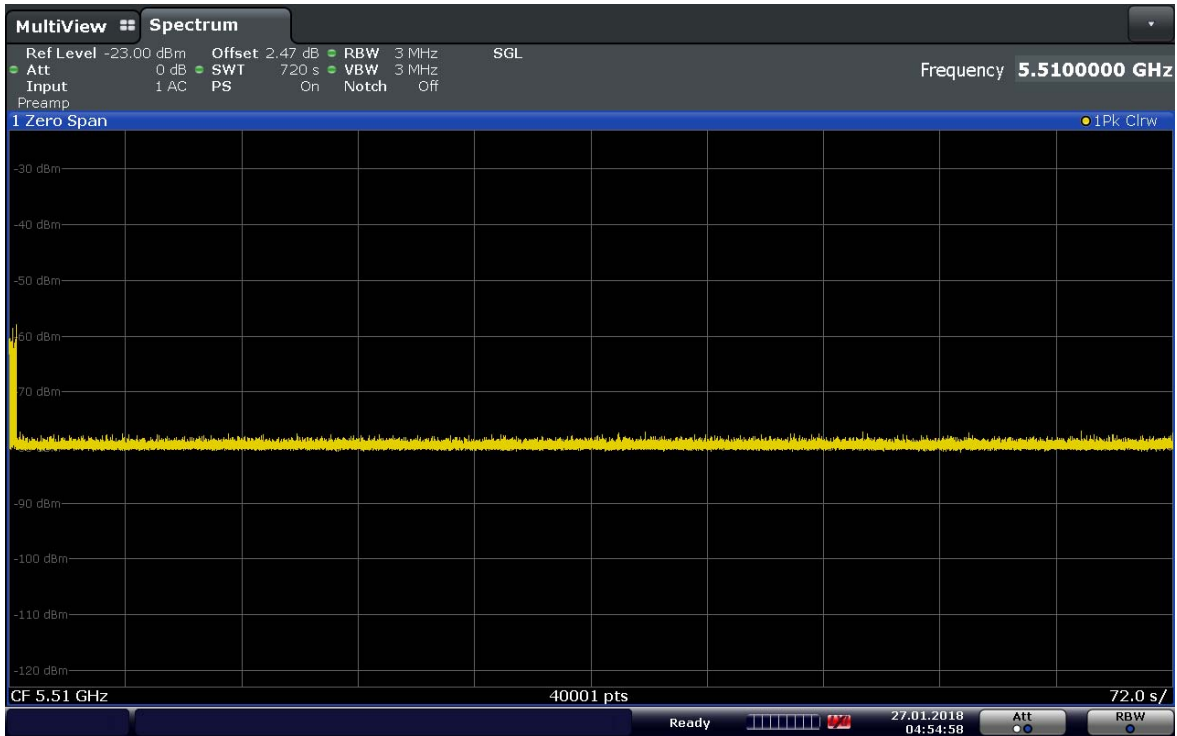


Figure 9-5. 5510MHz - Monitoring 10 minutes (40MHz)

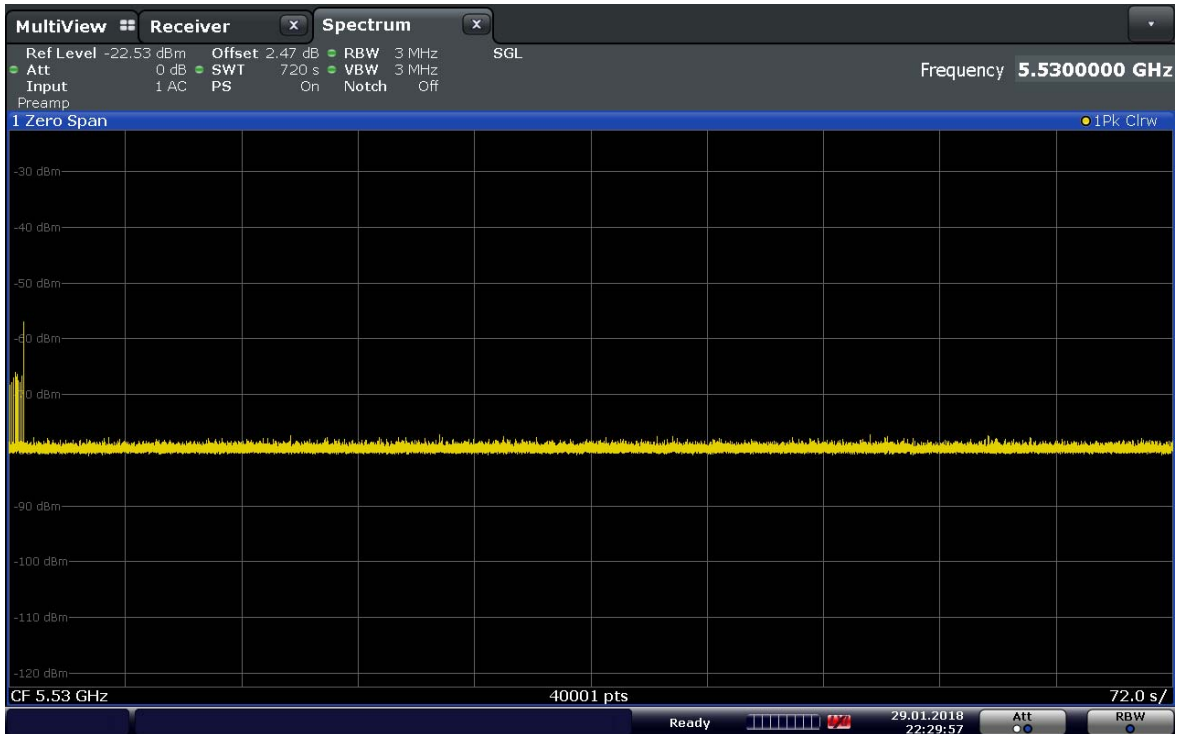


Figure 9-6. 5530MHz - Monitoring 10 minutes (80MHz)

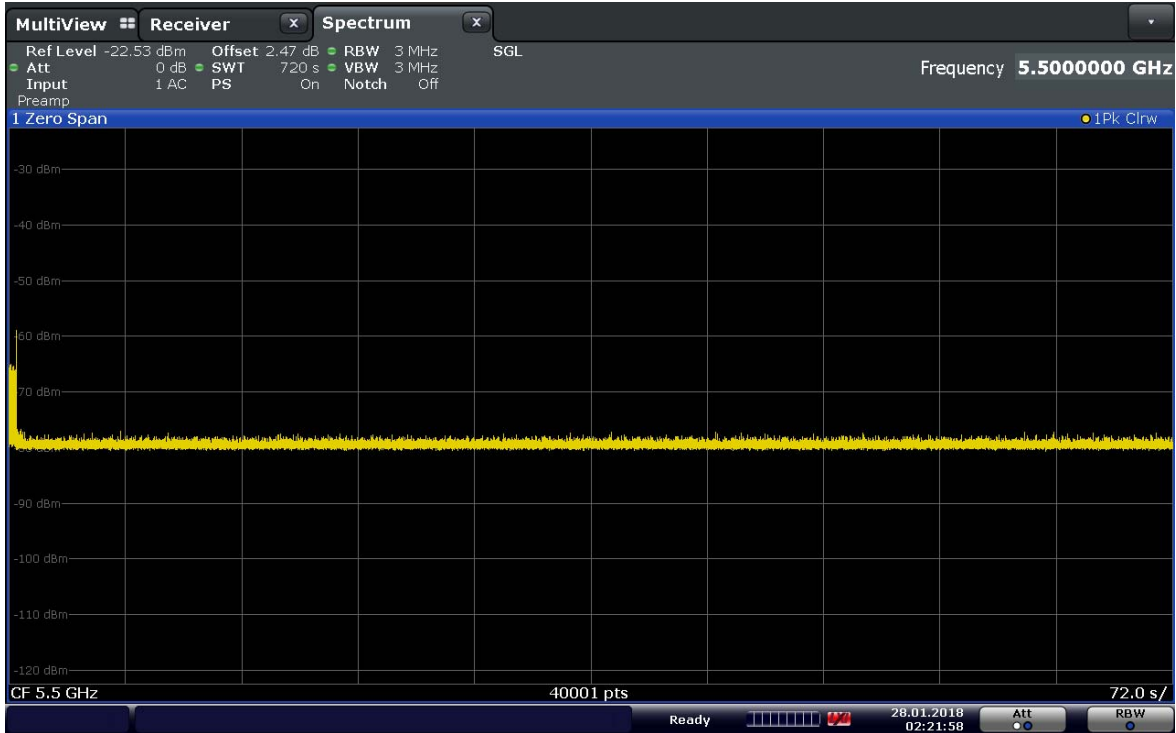
FCC ID: BCGA1954	<b>PCTEST</b> ENGINEERING LABORATORY, INC.		<b>MEASUREMENT REPORT (CERTIFICATION)</b>	Approved by: Quality Manager
Test Report S/N: 1C1710060006-07.BCG	Test Dates: 10/31-1/31/2018	EUT Type: Tablet Device		Page 40 of 45



### 9.3 Monitoring 10 minutes Mode 3:

**Notes:**

1. No frequency transmission detected during the aggregate 10 monitoring period.



**Figure 9-7. 5500MHz - Monitoring 10 minutes (20MHz)**

FCC ID: BCGA1954	 <b>MEASUREMENT REPORT (CERTIFICATION)</b>		Approved by: Quality Manager
Test Report S/N: 1C1710060006-07.BCG	Test Dates: 10/31-1/31/2018	EUT Type: Tablet Device	Page 41 of 45

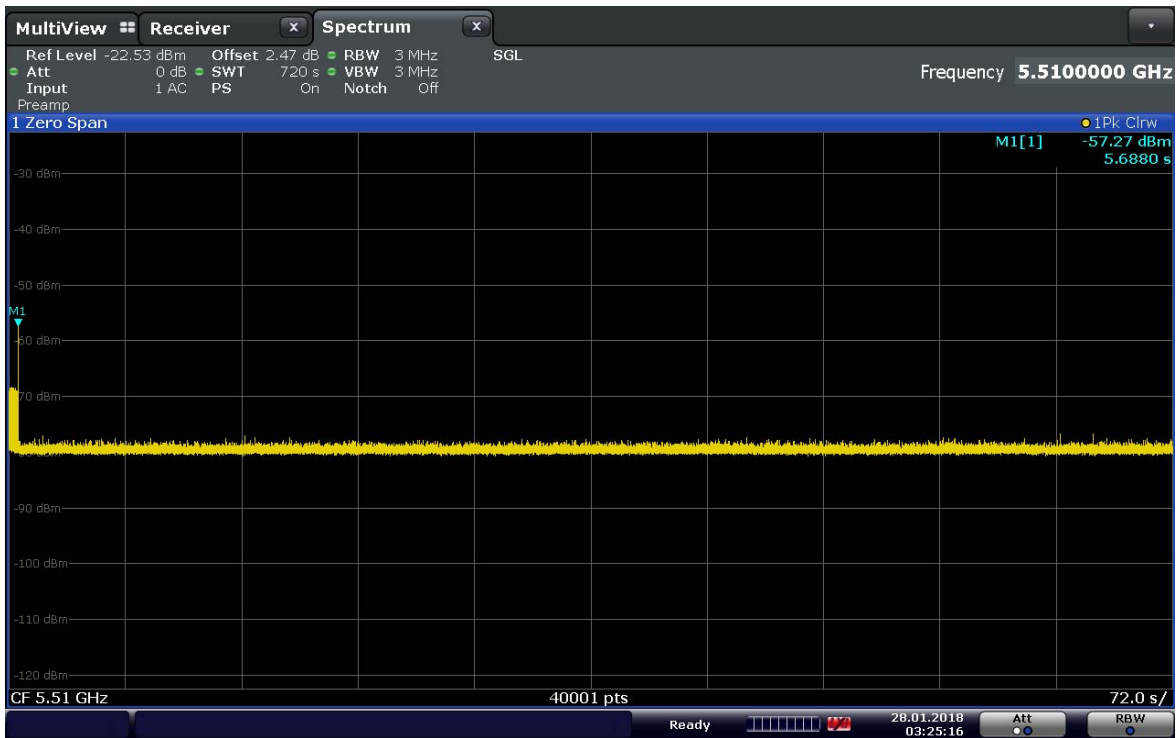


Figure 9-8. 5510MHz - Monitoring 10 minutes (40MHz)

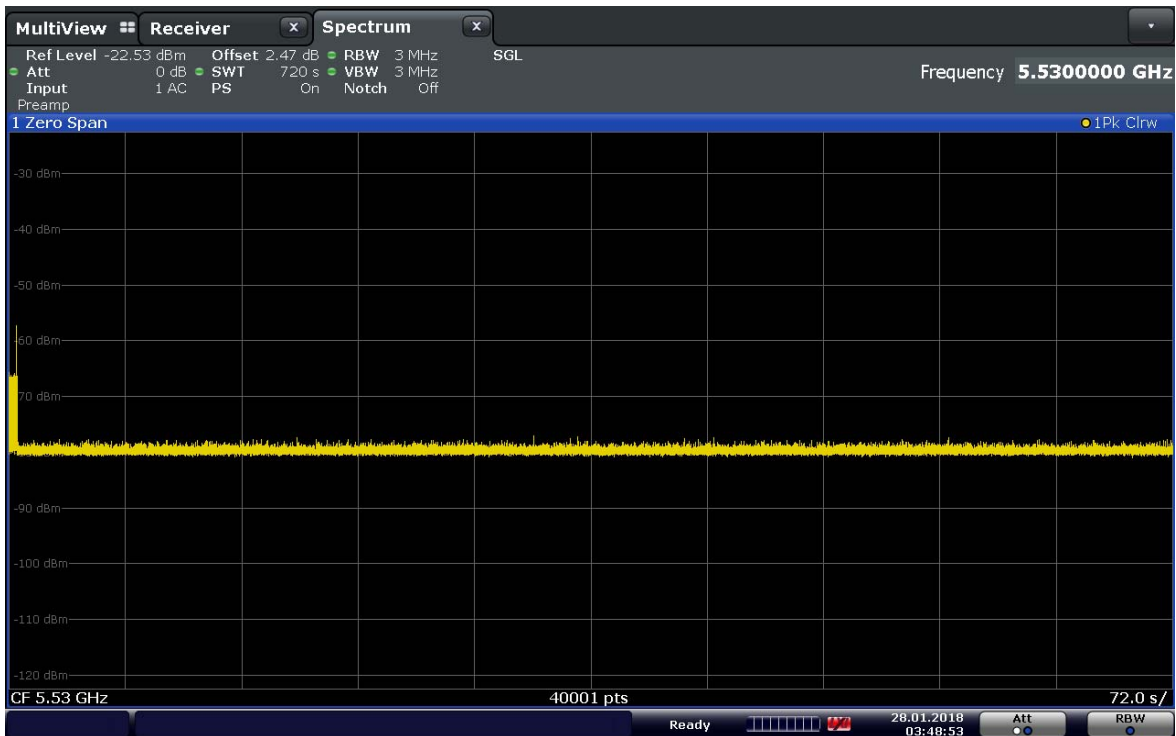


Figure 9-9. 5530MHz - Monitoring 10 minutes (80MHz)

FCC ID: BCGA1954	<b>MEASUREMENT REPORT (CERTIFICATION)</b>		Approved by: Quality Manager
Test Report S/N: 1C1710060006-07.BCG	Test Dates: 10/31-1/31/2018	EUT Type: Tablet Device	Page 42 of 45

## 9.4 Monitoring 10 minutes Mode 4:

### Notes:

1. No frequency transmission detected during the aggregate 10 monitoring period.

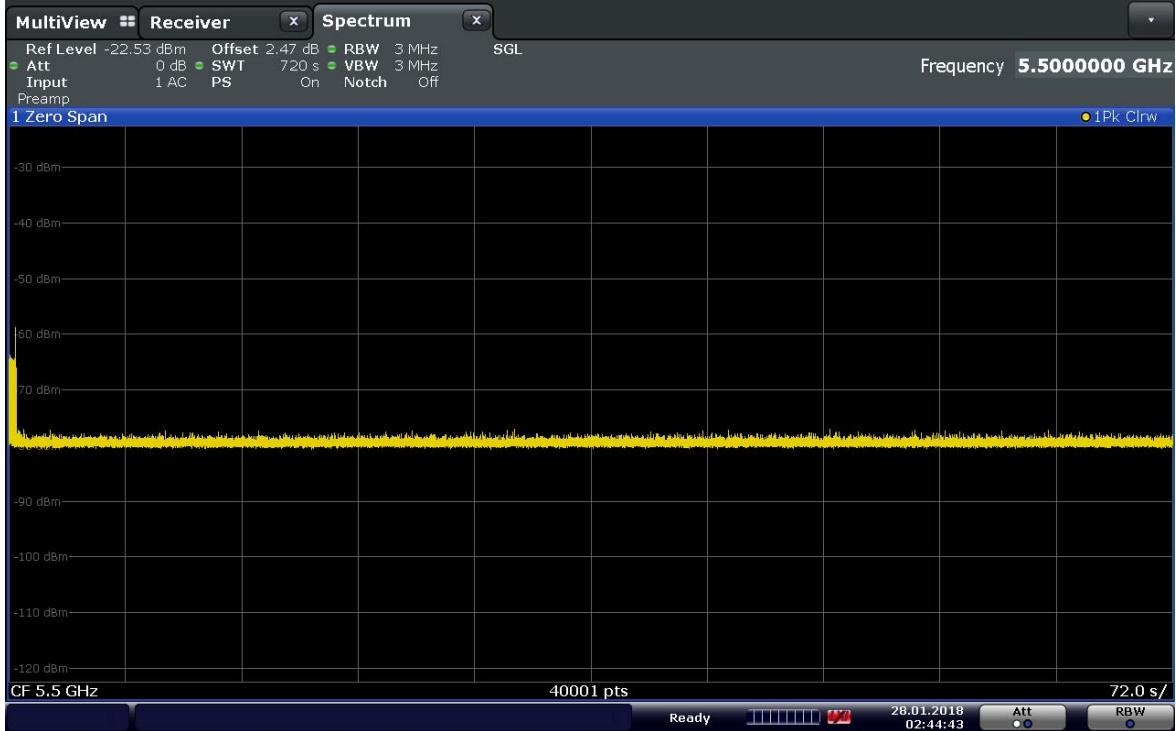
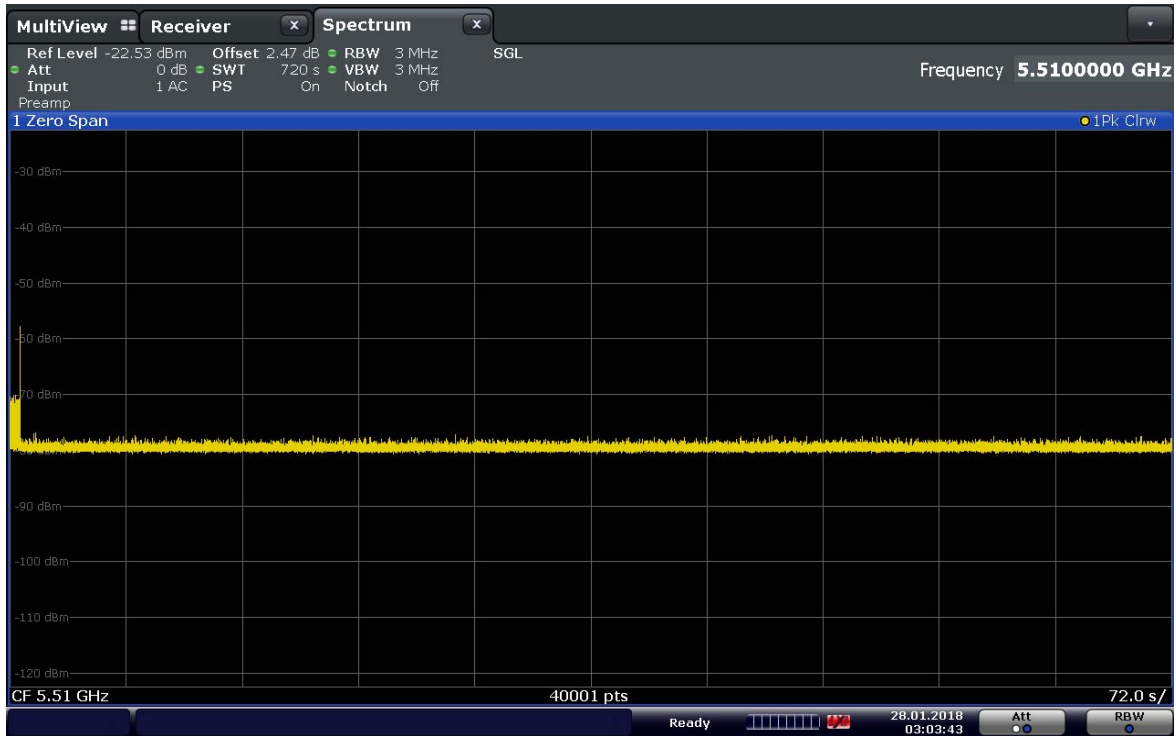
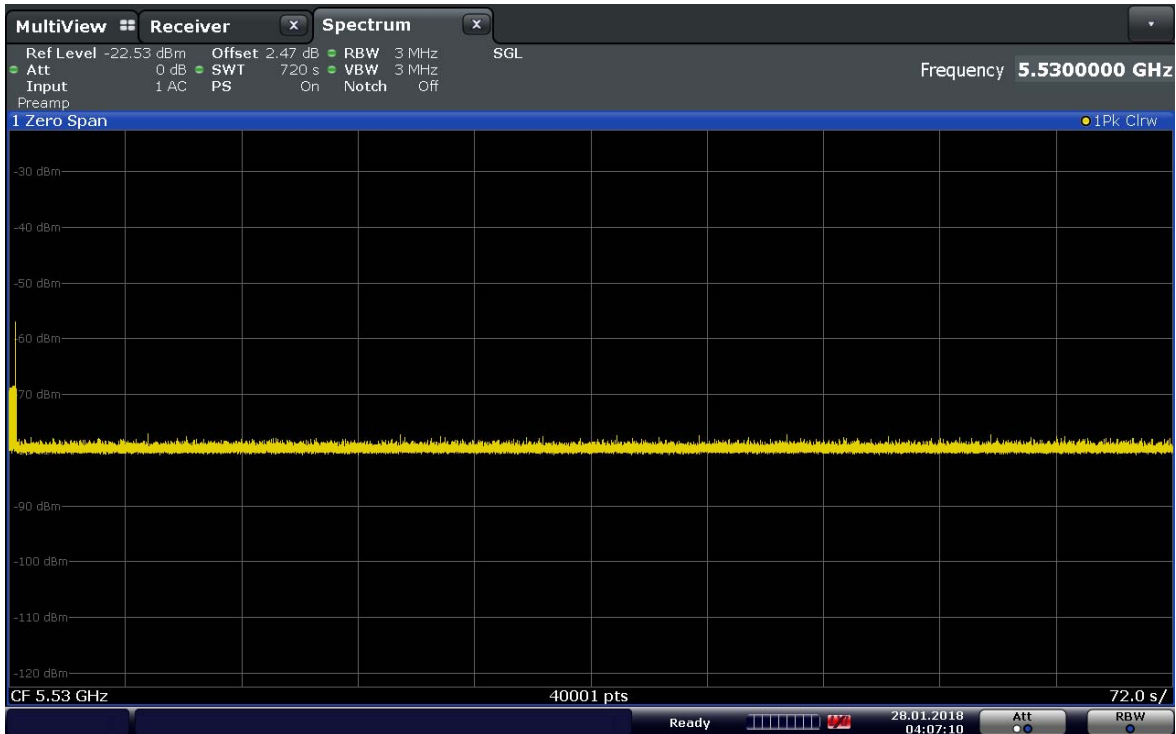


Figure 9-100. 5500MHz - Monitoring 10 minutes (20MHz)

FCC ID: BCGA1954			MEASUREMENT REPORT (CERTIFICATION)	Approved by: Quality Manager
Test Report S/N: 1C1710060006-07.BCG	Test Dates: 10/31-1/31/2018	EUT Type: Tablet Device		Page 43 of 45



**Figure 9-11 5510MHz - Monitoring 10 minutes (40MHz)**



**Figure 9-111 5530MHz - Monitoring 10 minutes (80MHz)**

FCC ID: BCGA1954	<b>PCTEST</b> ENGINEERING LABORATORY, INC.		<b>MEASUREMENT REPORT (CERTIFICATION)</b>	Approved by: Quality Manager
Test Report S/N: 1C1710060006-07.BCG	Test Dates: 10/31-1/31/2018	EUT Type: Tablet Device		Page 44 of 45

## 10.0 CONCLUSION

The data collected relate only to the item(s) tested and show that the **Apple Tablet Device FCC ID: BCGA1954** is in compliance with the DFS requirements for a Client Device without radar detection in accordance with Part 15.407 of the FCC Rules and RSS-247 of the Innovation, Science and Economic Development Canada Rules.

<b>FCC ID:</b> BCGA1954	 <b>MEASUREMENT REPORT (CERTIFICATION)</b>		<b>Approved by:</b> Quality Manager
<b>Test Report S/N:</b> 1C1710060006-07.BCG	<b>Test Dates:</b> 10/31-1/31/2018	<b>EUT Type:</b> Tablet Device	Page 45 of 45