



FCC Test Report

FCC Part 15.247 for FHSS systems

Model #: A1303
FCC ID: BCGA1303B

Apple Inc.
1 Infinite Loop Mail Stop26A
Cupertino, California 95014
U.S.A

TEST REPORT #: EMC_APPLE_047_09001_15.247FHSS_BCGA1303B
DATE: 2009-05-27



FCC listed:
A2LA
accredited

IC recognized #
3462B

CETECOM Inc.

411 Dixon Landing Road • Milpitas, CA 95035 • U.S.A.

Phone: + 1 (408) 586 6200 • Fax: + 1 (408) 586 6299 • E-mail: info@cetecomusa.com • <http://www.cetecom.com>

CETECOM Inc. is a Delaware Corporation with Corporation number: 2113686
Board of Directors: Dr. Harald Ansorge, Dr. Klaus Matkey, Hans Peter May



TABLE OF CONTENTS

1	Assessment	4
2	Administrative Data	5
2.1	Identification of the Testing Laboratory Issuing the EMC Test Report	5
2.2	Identification of the Client	5
2.3	Identification of the Manufacturer	5
3	Equipment Under Test (EUT)	6
3.1	Specification of the Equipment under Test	6
3.2	Identification of the Equipment under Test (EUT)	6
3.3	Identification of Accessory equipment	6
4	Subject Of Investigation	7
5	Measurements (RADIATED)	8
5.1	MAXIMUM PEAK OUTPUT POWER § 15.247 (RADIATED)	8
5.1.1	LIMIT SUB CLAUSE § 15.247 (b) (1) (2) (3) (4)	8
5.1.2	Test Results	8
5.2	RESTRICTED BAND EDGE COMPLIANCE RADIATED §15.247/15.205	9
5.2.1	LIMITS	9
5.2.2	RESULTS: GFSK	10
5.2.3	RESULTS: $\pi/4$ DQPSK	14
5.2.4	RESULTS: 8DPSK	18
5.3	TRANSMITTER SPURIOUS EMISSIONS RADIATED § 15.247/15.205/15.209	22
5.3.1	LIMITS	22
5.3.2	RESULTS	23
5.4	RECEIVER SPURIOUS RADIATION RSS-Gen(4.10)	32
5.4.1	LIMITS	32
5.4.2	Results	33
6	Measurements (CONDUCTED)	36
6.1	MAXIMUM PEAK OUTPUT POWER § 15.247 (CONDUCTED)	36
6.1.1	LIMIT SUB CLAUSE § 15.247 (b) (1)	36
6.1.2	RESULTS: GFSK	36
6.1.3	RESULTS: $\pi / 4$ DQPSK	36
6.1.4	RESULTS: 8DPSK	36
6.2	20dB BANDWIDTH	46
6.2.1	LIMIT SUB CLAUSE § 15.247 (a) (1) (i) (ii) (iii)	46
6.2.2	RESULTS: GFSK	46
6.3	CARRIER FREQUENCY SEPARATION	56
6.3.1	LIMIT SUB CLAUSE § 15.247 (a) (1) (i) (ii) (iii)	56
6.3.2	RESULTS:	56
6.4	NUMBER OF HOPPING CHANNELS	57
6.4.1	LIMIT SUB CLAUSE § 15.247 (a) (1) (iii)	57
6.4.2	RESULTS:	57



6.5	TIME OF OCCUPANCY (DWELL TIME)	59
6.5.1	LIMIT SUB CLAUSE § 15.247 (a) (1) (i) (ii) (iii)	59
6.5.2	RESULTS:	59
6.6	CONDUCTED SPURIOUS EMISSION	60
6.6.1	LIMIT SUB CLAUSE § 15.247 (d)	60
6.6.2	RESULTS: Tnom(23)°C VnomVDC	60
7	TEST EQUIPMENT AND ANCILLARIES USED FOR TESTS	63
8	BLOCK DIAGRAMS	64



1 Assessment

The following is in compliance with the applicable criteria specified in FCC rules Part 15.247 of the Code of Federal Regulations.

Company	Description	Model #
Apple Inc.	This device is a GSM and WCDMA smart handset with WiFi, Bluetooth +EDR and iPod and application functions	A1303

Technical responsibility for area of testing:

Heiko Strehlow
 (Director Antenna &
 Regulatory Services)

2009-05-27 EMC & Radio

Date	Section	Name	Signature
------	---------	------	-----------

This report is prepared by:

Marc Douat
 (Test Lab Manager)

2009-05-27 EMC & Radio

Date	Section	Name	Signature
------	---------	------	-----------

The test results of this test report relate exclusively to the test item specified in Identification of the Equipment under Test. The CETECOM Inc. USA does not assume responsibility for any conclusions and generalizations drawn from the test results with regard to other specimens or samples of the type of the equipment represented by the test item. The test report may only be reproduced or published in full. Reproduction or publication of extracts from the report requires the prior written approval of the CETECOM Inc USA.



2 Administrative Data

2.1 Identification of the Testing Laboratory Issuing the EMC Test Report

Company Name:	CETECOM Inc.
Department:	EMC
Address:	411 Dixon Landing Road Milpitas, CA 95035 U.S.A.
Telephone:	+1 (408) 586 6200
Fax:	+1 (408) 586 6299
Responsible Test Lab Manager:	Heiko Strehlow
Responsible Project Leader:	Marc Douat
Date of test:	2009-04-21 to 2009-04-24

2.2 Identification of the Client

APPLICANT	
Applicant (Company Name)	Apple Inc.
Street Address	1 Infinite Loop Mail Stop26A
City/Zip Code	Cupertino, California 95014
Country	USA
Contact Person	Robert Steinfeld
Telephone	408-974-2618
Fax	408-862-5061
e-mail	steinfel@apple.com

2.3 Identification of the Manufacturer

Same as above applicant.



3 Equipment Under Test (EUT)

3.1 Specification of the Equipment under Test

EUT	
Marketing Name of EUT (if not same as Model No.)	iPhone 3G
Description	This device is a GSM and WCDMA smart handset with WiFi, Bluetooth +EDR and iPod and application functions
Model No.	A1303
H/W	REV4-16GB
	04.24.02 (7A290)
FCC-ID:	BCGA1303B

Frequency Range:	2400MHz – 2483.5MHz
Type(s) of Modulation:	GFSK, DQPSK, 8PSK
Number of Channels:	79
Antenna Type/gain:	IFA - inverted F Antenna 1.2dBi gain
Output Power:	Conducted GFSK: 8.1 dBm, 6.46 mW Conducted DQPSK: 9.8 dBm, 9.55 mW Conducted 8DPSK: 10 dBm, 10 mW Radiated GFSK: 9.3 dBm, 8.51 mW Radiated DQPSK: 11 dBm, 12.59 mW Radiated 8DPSK: 11.2 dBm, 13.18 mW

3.2 Identification of the Equipment under Test (EUT)

EUT #	TYPE	MANF.	MODEL
1	Radiated Sample	Apple Inc.	A1303
2	Condcuted Sample	Apple Inc.	A1303

3.3 Identification of Accessory equipment



AE #	TYPE	MANF.	MODEL
1	AC/DC ADAPTER	Flextronics	A1265

4 Subject Of Investigation

All testing was performed on the product referred to in Section 3 as EUT. This test report contains full radiated and contacted testing as per FCC15.247 on the EUT with the Bluetooth module.

During the testing process the EUT was tested on low, mid, and high channels using PRBS9 payload using DH5, 2DH5, and 3DH5 packets, all data in this report shows the worst case between horizontal and vertical polarization for above 1GHz.

The objective of the measurements done by Cetecom Inc. was to measure the performance of the EUT as specified by requirements listed in FCC rules Part 15.247 of Title 47 of the Code of Federal Regulations. The maximization of portable equipment is conducted in accordance with ANSI C63.4.



5 Measurements (RADIATED)

5.1 MAXIMUM PEAK OUTPUT POWER § 15.247 (RADIATED)

5.1.1 LIMIT SUB CLAUSE § 15.247 (b) (1) (2) (3) (4)

Frequency range	RF power output
2400-2483.5 MHz	36dBm EIRP

*limit is based upon antenna gain of less than or equal to 6dBi.

5.1.2 Test Results

EIRP = Conducted Peak Power + Antenna Gain (1.2dBi)

EIRP: GFSK

TEST CONDITIONS		MAXIMUM PEAK OUTPUT POWER (dBm)		
Frequency (MHz)		2402	2441	2480
T _{nom} (23)°C	V _{nom} VDC	9.1	9.2	9.3
Measurement uncertainty		±0.5dBm		

EIRP: π / 4 DQPSK

TEST CONDITIONS		MAXIMUM PEAK OUTPUT POWER (dBm)		
Frequency (MHz)		2402	2441	2480
T _{nom} (23)°C	V _{nom} VDC	10.4	11	11
Measurement uncertainty		±0.5dBm		

EIRP: 8DPSK

TEST CONDITIONS		MAXIMUM PEAK OUTPUT POWER (dBm)		
Frequency (MHz)		2402	2441	2480
T _{nom} (23)°C	V _{nom} VDC	10.6	11.2	11.2
Measurement uncertainty		±0.5dBm		



5.2 RESTRICTED BAND EDGE COMPLIANCE RADIATED §15.247/15.205

5.2.1 LIMITS

30.□ Except as shown in paragraph (d) of this section, only spurious emissions are permitted in any of the frequency bands listed below:

MHz	MHz	MHz	GHz
0.090 - 0.110	16.42 - 16.423	399.9 - 410	4.5 - 5.15
¹ 0.495 - 0.505	16.69475 - 16.69525	608 - 614	5.35 - 5.46
2.1735 - 2.1905	16.80425 - 16.80475	960 - 1240	7.25 - 7.75
4.125 - 4.128	25.5 - 25.67	1300 - 1427	8.025 - 8.5
4.17725 - 4.17775	37.5 - 38.25	1435 - 1626.5	9.0 - 9.2
4.20725 - 4.20775	73 - 74.6	1645.5 - 1646.5	9.3 - 9.5
6.215 - 6.218	74.8 - 75.2	1660 - 1710	10.6 - 12.7
6.26775 - 6.26825	108 - 121.94	1718.8 - 1722.2	13.25 - 13.4
6.31175 - 6.31225	123 - 138	2200 - 2300	14.47 - 14.5
8.291 - 8.294	149.9 - 150.05	2310 - 2390	15.35 - 16.2
8.362 - 8.366	156.52475 - 156.52525	2483.5 - 2500	17.7 - 21.4
8.37625 - 8.38675	156.7 - 156.9	2690 - 2900	22.01 - 23.12
8.41425 - 8.41475	162.0125 - 167.17	3260 - 3267	23.6 - 24.0
12.29 - 12.293	167.72 - 173.2	3332 - 3339	31.2 - 31.8
12.51975 - 12.52025	240 - 285	3345.8 - 3358	36.43 - 36.5
12.57675 - 12.57725	322 - 335.4	3600 - 4400	(²)
13.36 - 13.41			

*PEAK LIMIT= 74dBuV/m
 *AVG. LIMIT= 54dBuV/m



**5.2.2 RESULTS: GFSK
 (2402MHz) LOWER BAND EDGE PEAK –GFSK MODULATION**

EUT: A1303
 Customer:: Apple
 Test Mode: BT Ch.0
 ANT Orientation: H
 EUT Orientation: V
 Test Engineer: Chris
 Voltage: FCC AC Adapter
 Comments:

SWEEP TABLE: "FCC15.247 LBE_PK"

Start Frequency	Stop Frequency	Detector	Meas. Time	IF Bandw.	Transducer
2.3 GHz	2.4 GHz	MaxPeak	Coupled	1 MHz	#326horn_AF_vert

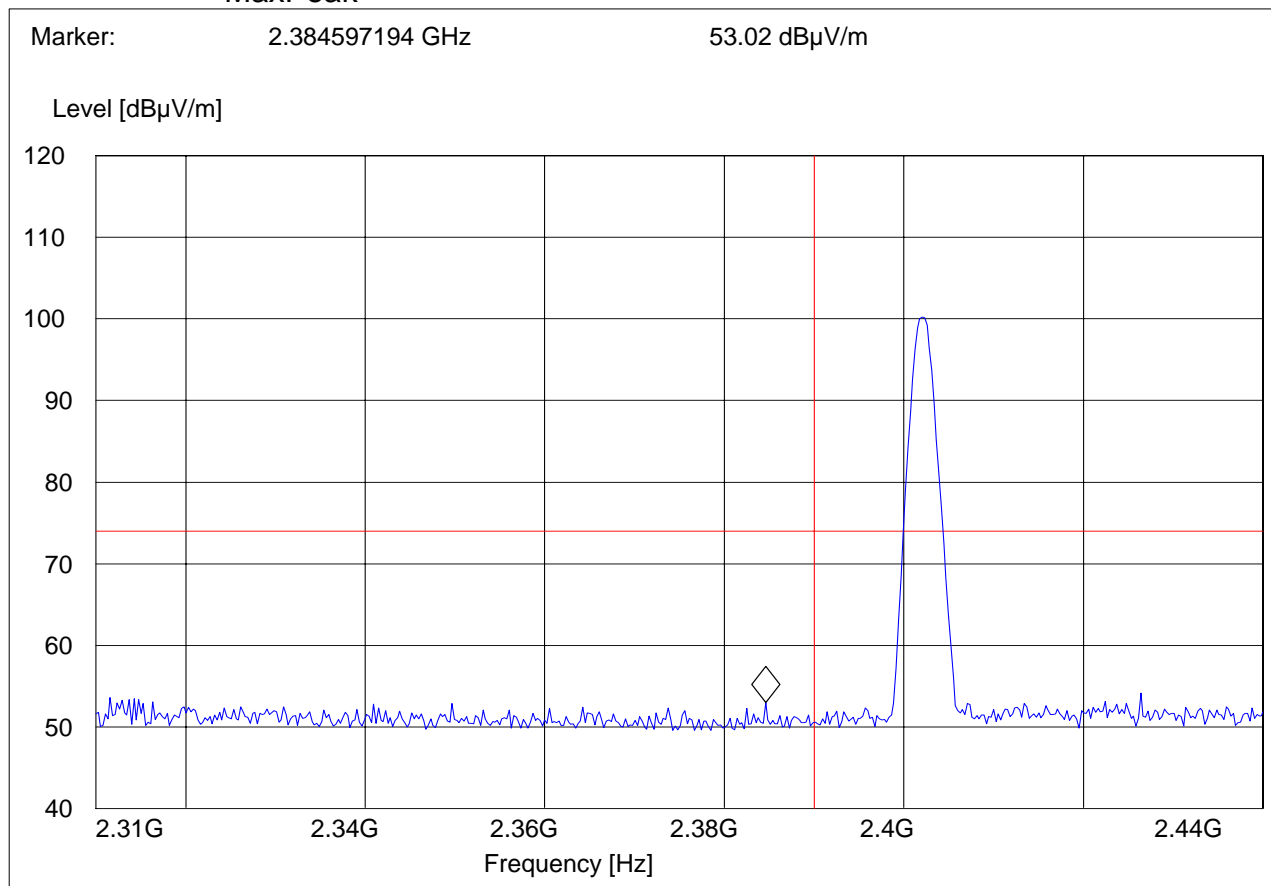



(2402MHz) LOWER BAND EDGE AVERAGE –GFSK MODULATION

EUT: A1303
Customer:: Apple
Test Mode: BT Ch.0
ANT Orientation: H
EUT Orientation: V
Test Engineer: Chris
Voltage: FCC AC Adapter
Comments:

SWEEP TABLE: "FCC15.247 LBE_AVG"

Start Frequency	Stop Frequency	Detector	Meas. Time	IF Bandw.	Transducer
2.3 GHz	2.4 GHz	MaxPeak	Coupled	1 MHz	#326horn_AF_vert

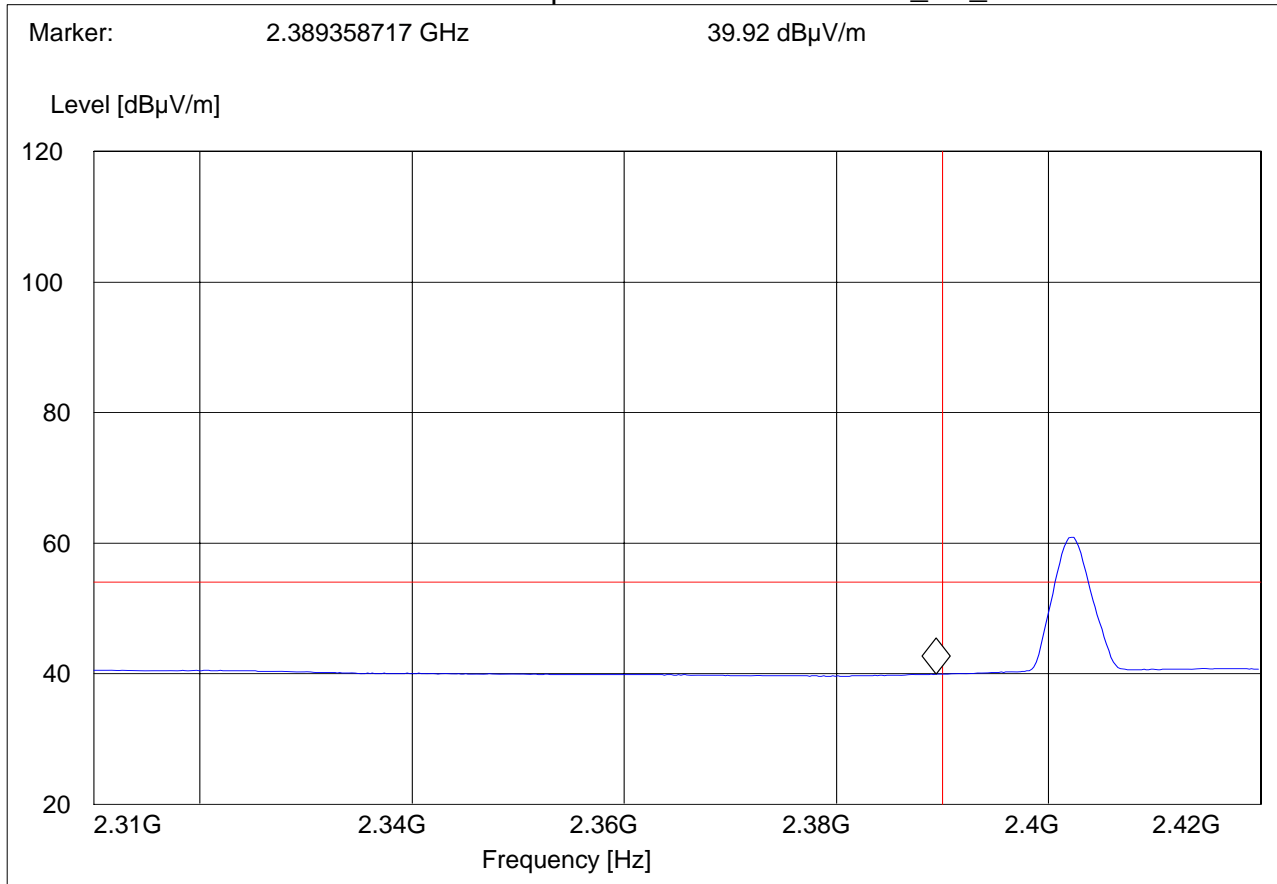



(2480MHz) HIGHER BAND EDGE PEAK –GFSK MODULATION

EUT: A1303
Customer:: Apple
Test Mode: BT Ch.78
ANT Orientation: H
EUT Orientation: V
Test Engineer: Chris
Voltage: FCC AC Adapter
Comments:

SWEEP TABLE: "FCC15.247 HBE_PK"

Start Frequency	Stop Frequency	Detector	Meas. Time	IF Bandw.	Transducer
2.5 GHz	2.5 GHz	MaxPeak	Coupled	1 MHz	#326horn_AF_vert

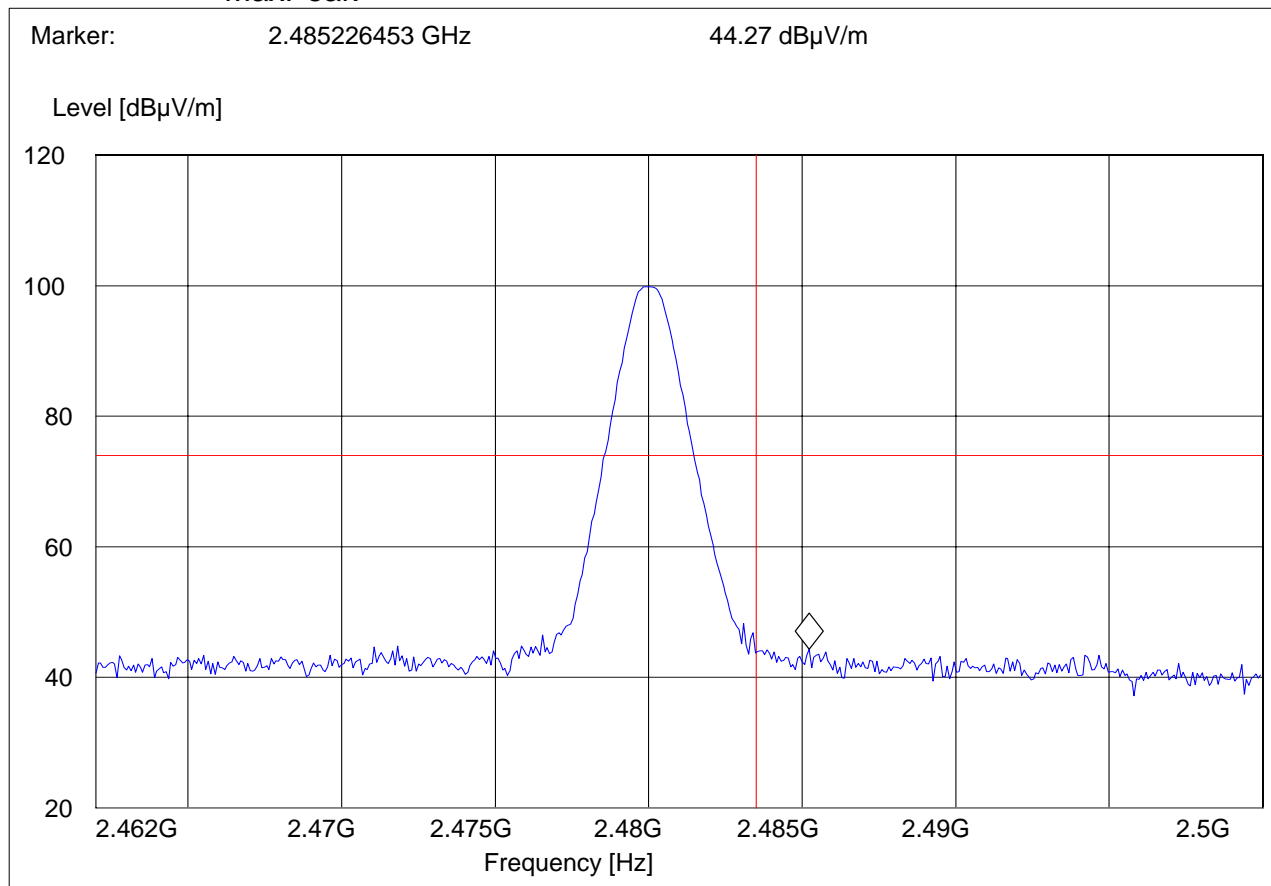



HIGHER BAND EDGE AVERAGE-GFSK MODULATION

EUT: A1303
Customer:: Apple
Test Mode: BT Ch.78
ANT Orientation: H
EUT Orientation: V
Test Engineer: Chris
Voltage: FCC AC Adapter
Comments:

SWEEP TABLE: "FCC15.247 HBE_AVG"

Start Frequency	Stop Frequency	Detector	Meas. Time	IF Bandw.	Transducer
2.5 GHz	2.5 GHz	MaxPeak	Coupled	1 MHz	#326horn_AF_horz

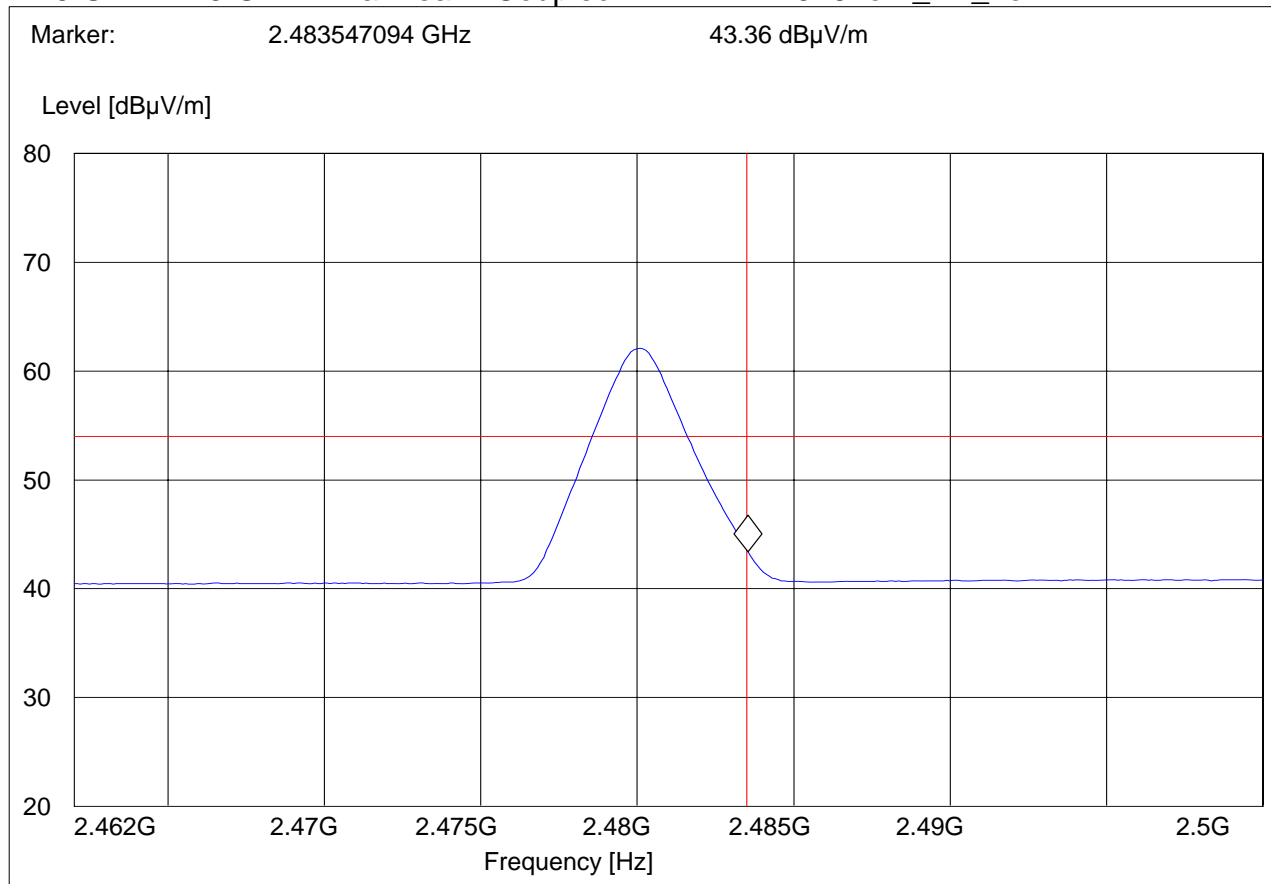



5.2.3 RESULTS: $\pi/4$ DQPSK

(2402MHz) LOWER BAND EDGE PEAK – $\pi/4$ DQPSK MODULATION

EUT: A1303
Customer:: Apple
Test Mode: BT Ch.0
ANT Orientation: H
EUT Orientation: V
Test Engineer: Chris
Voltage: FCC AC Adapter
Comments:

SWEEP TABLE: "FCC15.247 LBE_PK"

Start Frequency	Stop Frequency	Detector	Meas. Time	IF Bandw.	Transducer
2.3 GHz	2.4 GHz	MaxPeak	Coupled	1 MHz	#326horn_AF_vert

MaxPeak

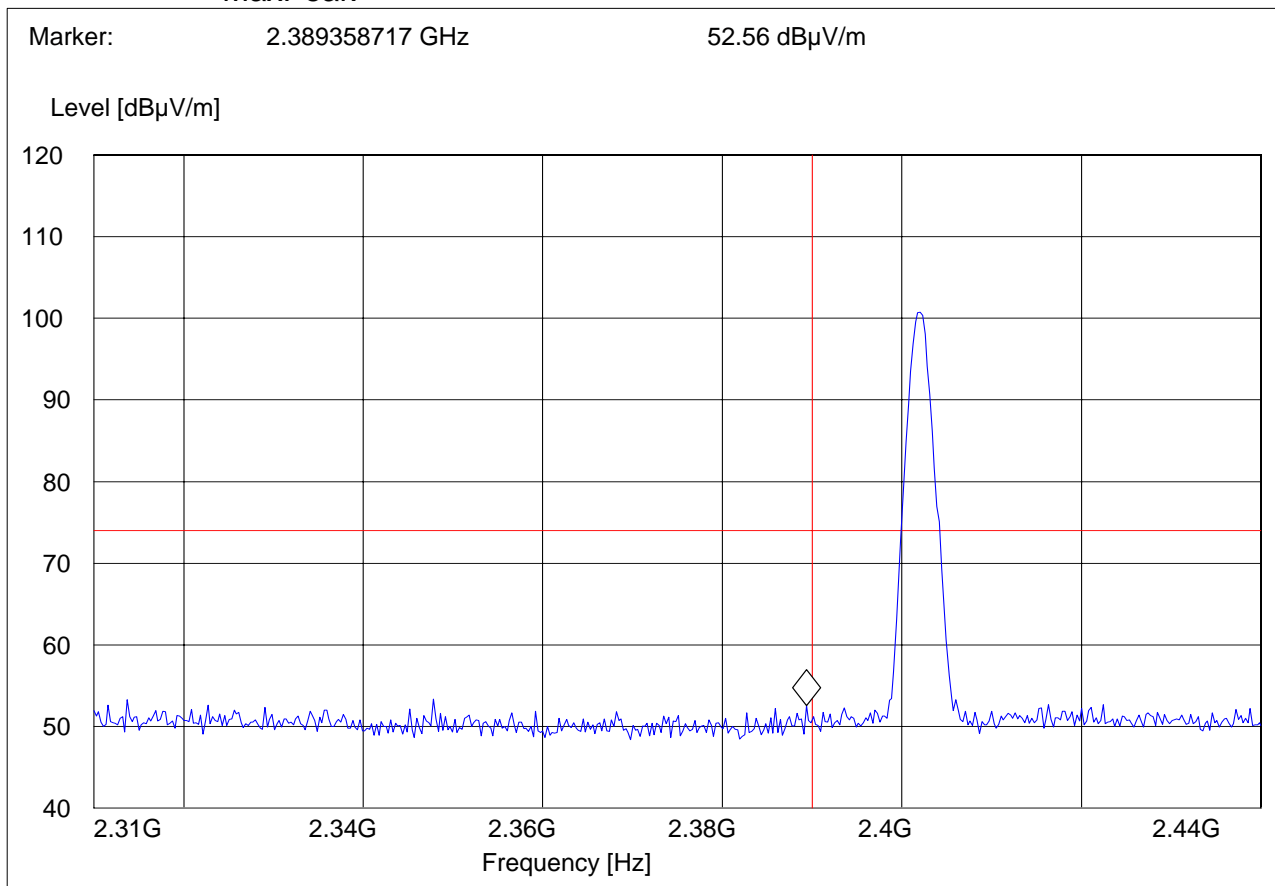



(2402MHz) LOWER BAND EDGE AVERAGE $-\pi/4$ DQPSK MODULATION

EUT: A1303
Customer:: Apple
Test Mode: BT Ch.0
ANT Orientation: H
EUT Orientation: V
Test Engineer: Chris
Voltage: FCC AC Adapter
Comments:

SWEEP TABLE: "FCC15.247 LBE_AVG"

Start Frequency	Stop Frequency	Detector	Meas. Time	IF Bandw.	Transducer
2.3 GHz	2.4 GHz	MaxPeak	Coupled	1 MHz	#326horn_AF_vert

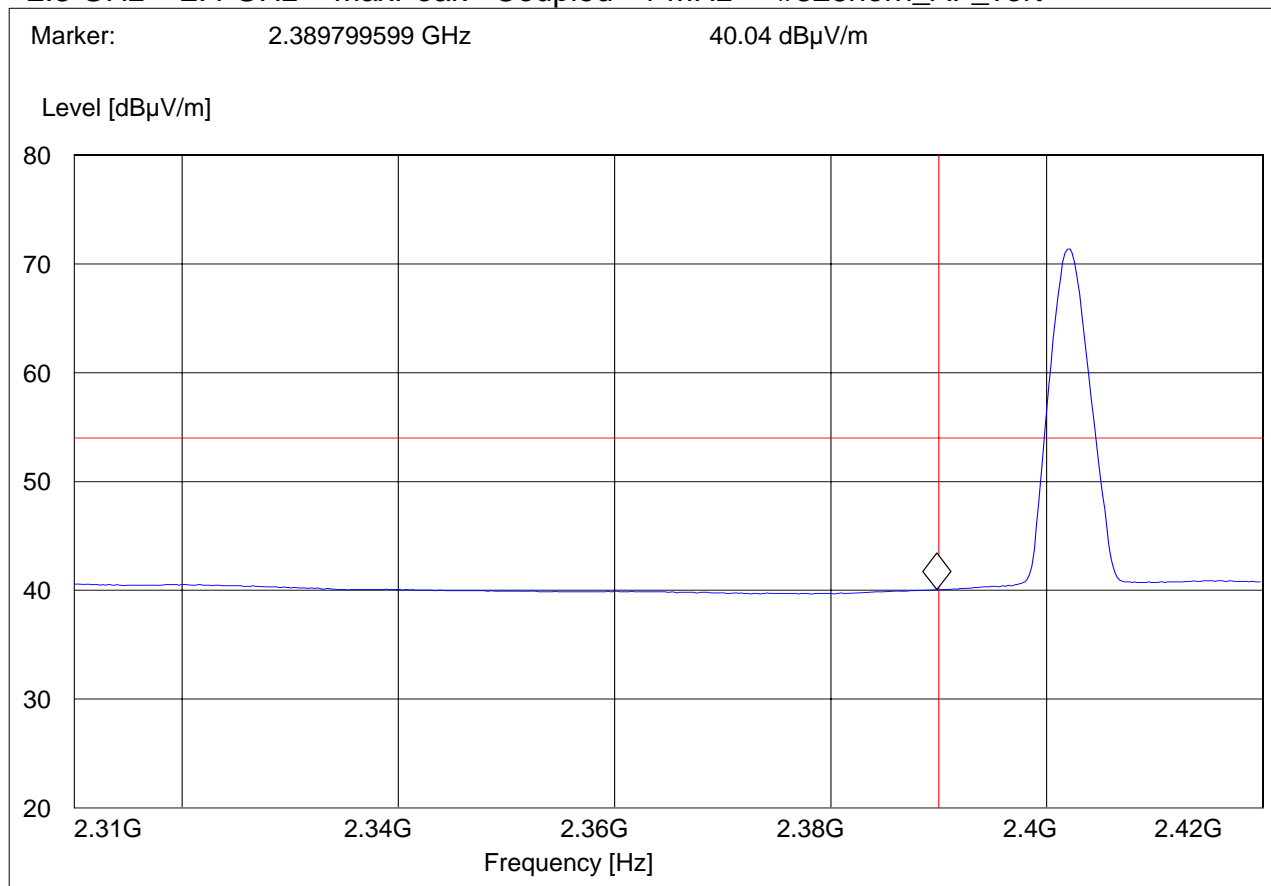



(2480MHz) HIGHER BAND EDGE PEAK $-\pi/4$ DQPSK MODULATION

EUT: A1303
Customer:: Apple
Test Mode: BT Ch.78
ANT Orientation: H
EUT Orientation: V
Test Engineer: Chris
Voltage: FCC AC Adapter
Comments:

SWEEP TABLE: "FCC15.247 HBE_PK"

Start Frequency	Stop Frequency	Detector	Meas. Time	IF Bandw.	Transducer
2.5 GHz	2.5 GHz	MaxPeak	Coupled	1 MHz	#326horn_AF_vert
MaxPeak					

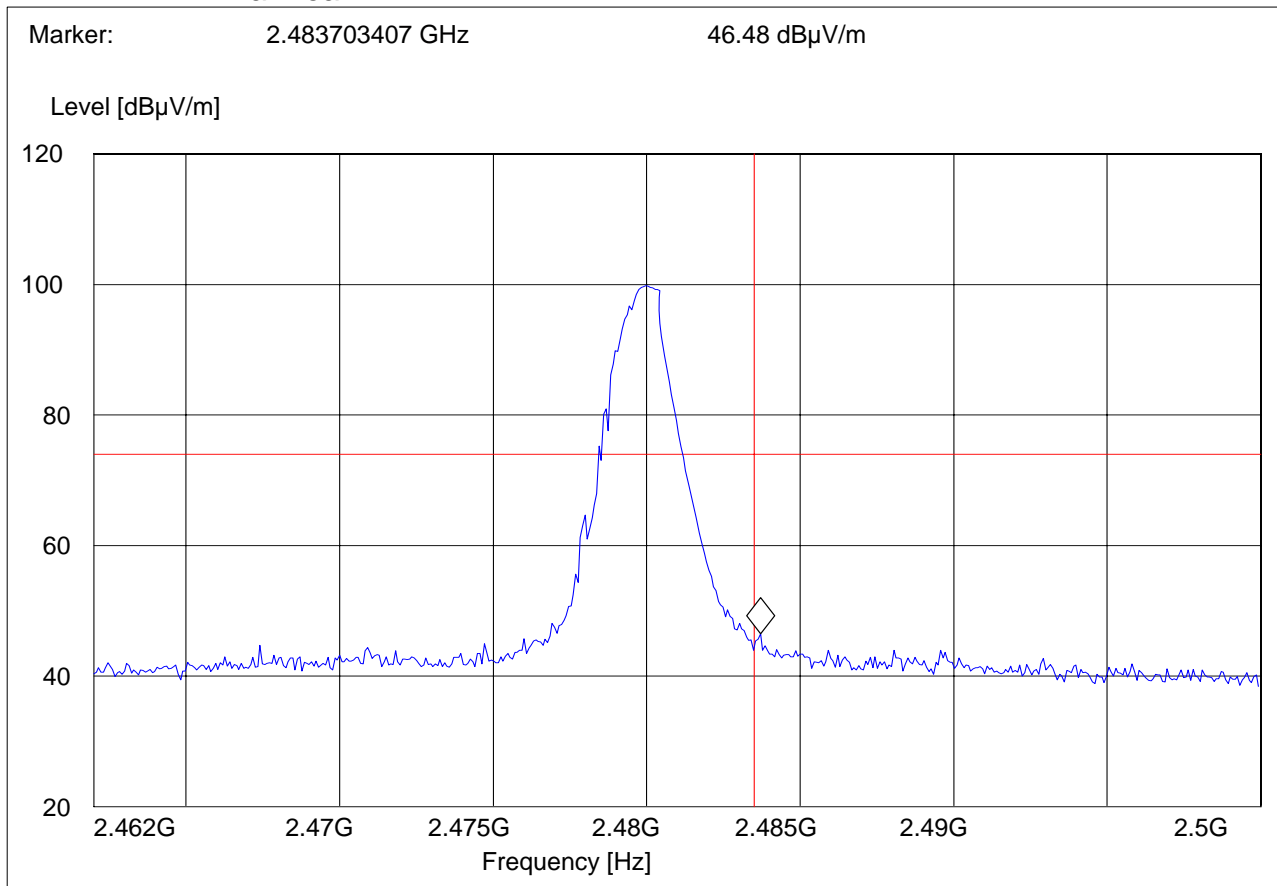



HIGHER BAND EDGE AVERAGE- $\pi/4$ DQPSK MODULATION

EUT: A1303
Customer:: Apple
Test Mode: BT Ch.78
ANT Orientation: H
EUT Orientation: V
Test Engineer: Chris
Voltage: FCC AC Adapter
Comments:

SWEEP TABLE: "FCC15.247 HBE_AVG"

Start Frequency	Stop Frequency	Detector	Meas. Time	IF Bandw.	Transducer
2.5 GHz	2.5 GHz	MaxPeak	Coupled	1 MHz	#326horn_AF_horz

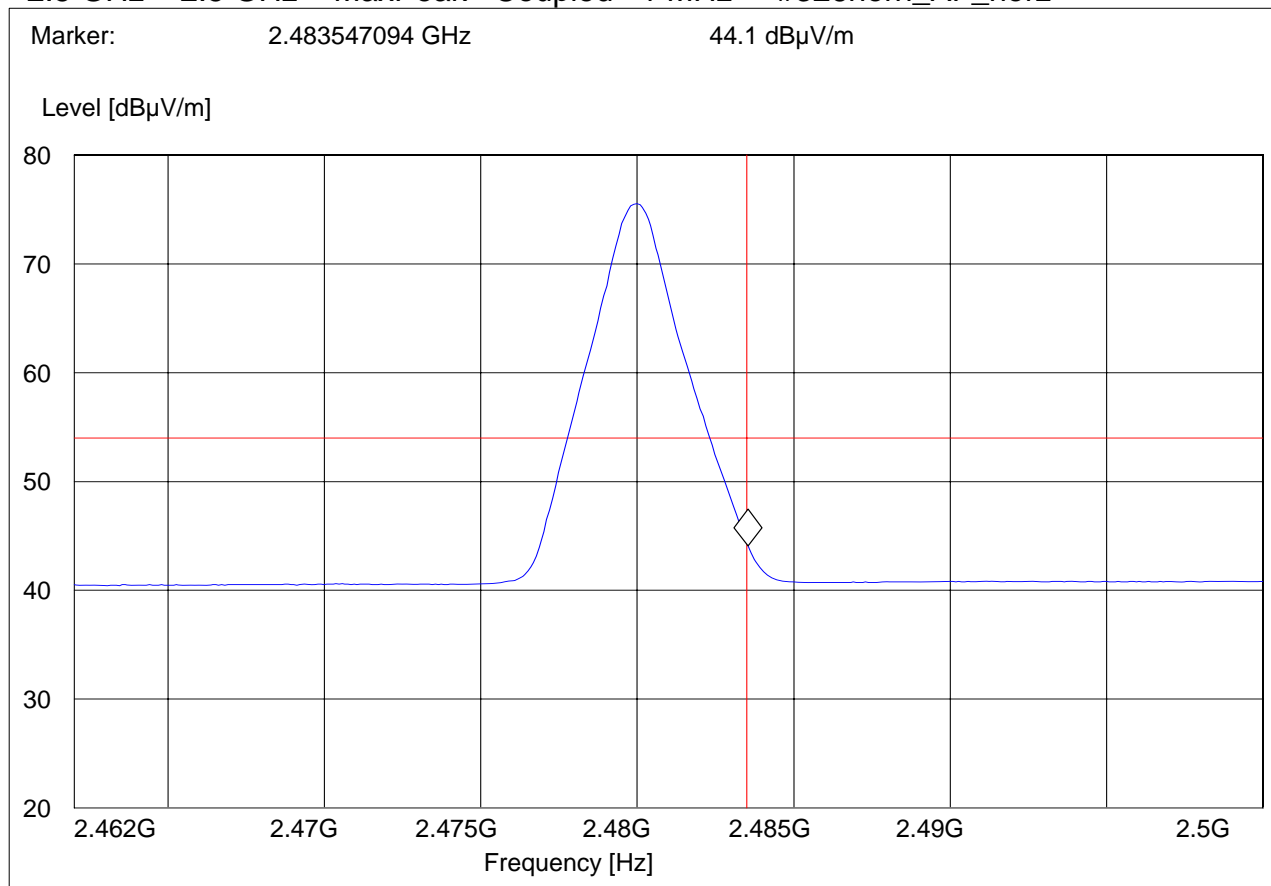



5.2.4 RESULTS: 8DPSK

(2402MHz) LOWER BAND EDGE PEAK – 8DPSK MODULATION

EUT: A1303
Customer:: Apple
Test Mode: BT Ch.0
ANT Orientation: H
EUT Orientation: V
Test Engineer: Chris
Voltage: FCC AC Adapter
Comments:

SWEEP TABLE: "FCC15.247 LBE_PK"

Start Frequency	Stop Frequency	Detector	Meas. Time	IF Bandw.	Transducer
2.3 GHz	2.4 GHz	MaxPeak	Coupled	1 MHz	#326horn_AF_vert

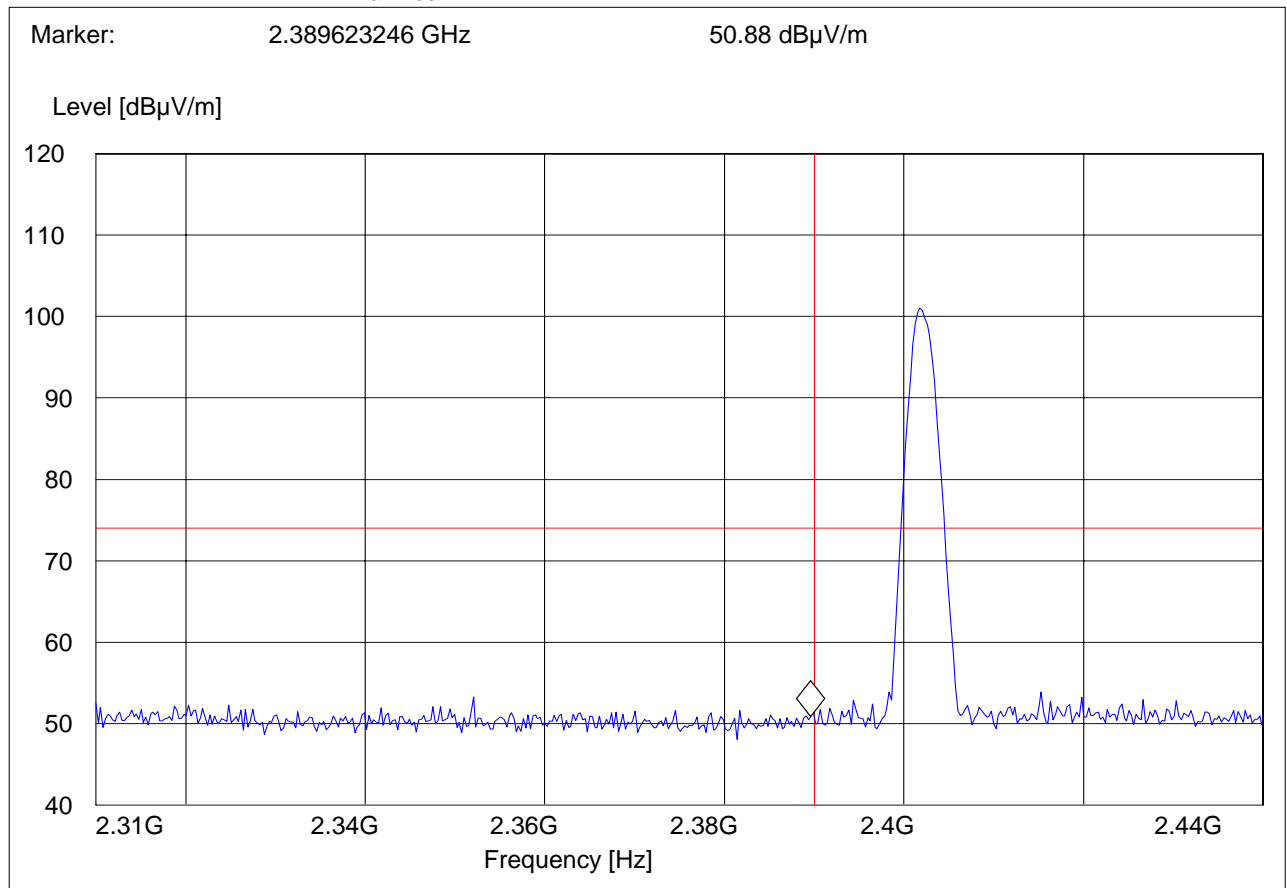



(2402MHz) LOWER BAND EDGE AVERAGE -8DPSK MODULATION

EUT: A1303
Customer:: Apple
Test Mode: BT Ch.0
ANT Orientation: H
EUT Orientation: V
Test Engineer: Chris
Voltage: FCC AC Adapter
Comments:

SWEEP TABLE: "FCC15.247 LBE_AVG"

Start Frequency	Stop Frequency	Detector	Meas. Time	IF Bandw.	Transducer
2.3 GHz	2.4 GHz	MaxPeak	Coupled	1 MHz	#326horn_AF_vert

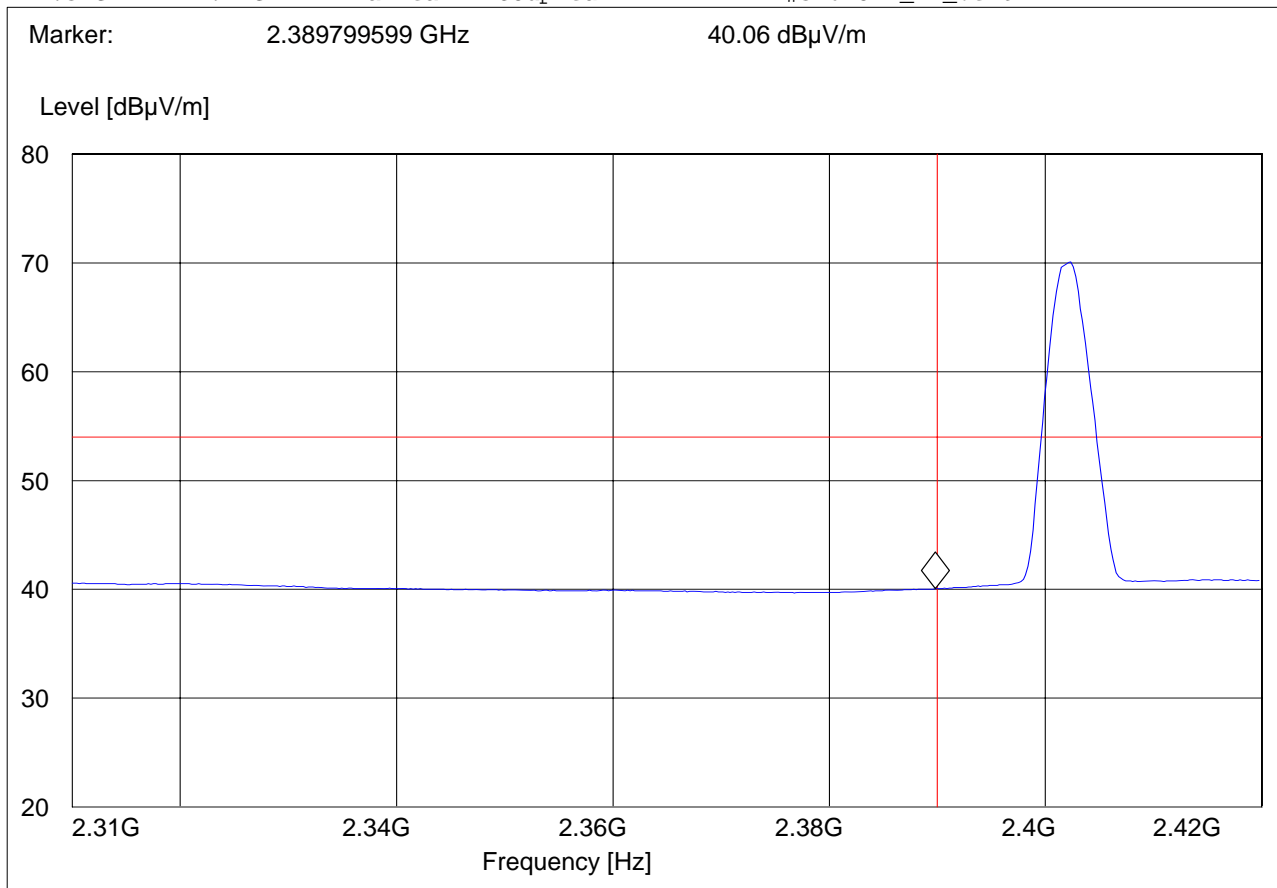



(2480MHz) HIGHER BAND EDGE PEAK – 8DPSK MODULATION

EUT: A1303
 Customer:: Apple
 Test Mode: BT Ch.78
 ANT Orientation: H
 EUT Orientation: V
 Test Engineer: Chris
 Voltage: FCC AC Adapter
 Comments:

SWEEP TABLE: "FCC15.247 HBE_PK"

Start Frequency	Stop Frequency	Detector	Meas. Time	IF Bandw.	Transducer
2.5 GHz	2.5 GHz	MaxPeak	Coupled	1 MHz	#326horn_AF_vert
		MaxPeak			

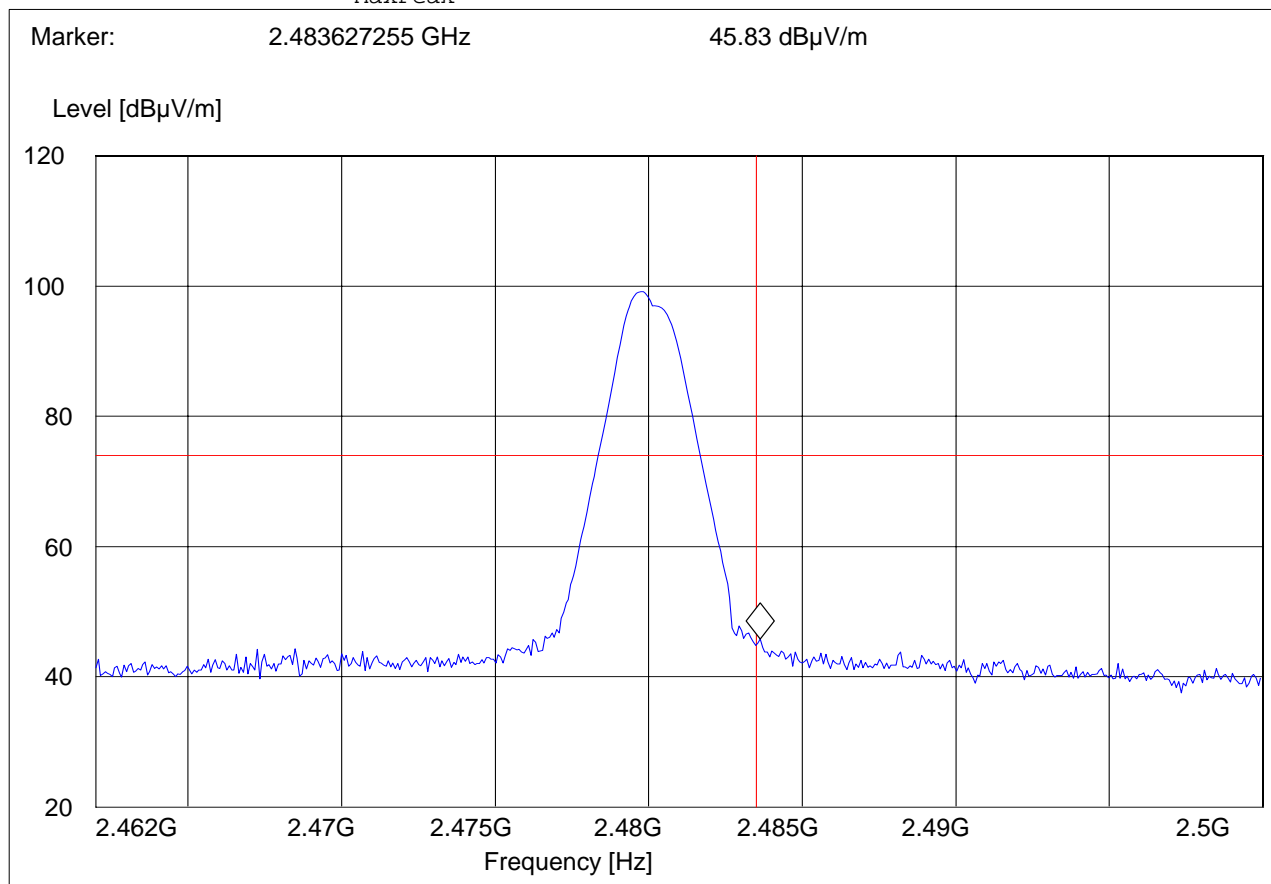



HIGHER BAND EDGE AVERAGE-8DPSK MODULATION

EUT: A1303
 Customer:: Apple
 Test Mode: BT Ch.78
 ANT Orientation: H
 EUT Orientation: V
 Test Engineer: Chris
 Voltage: FCC AC Adapter
 Comments:

SWEEP TABLE: "FCC15.247 HBE_AVG"

Start Frequency	Stop Frequency	Detector	Meas. Time	IF Bandw.	Transducer
2.5 GHz	2.5 GHz	MaxPeak	Coupled	1 MHz	#326horn_AF_horz

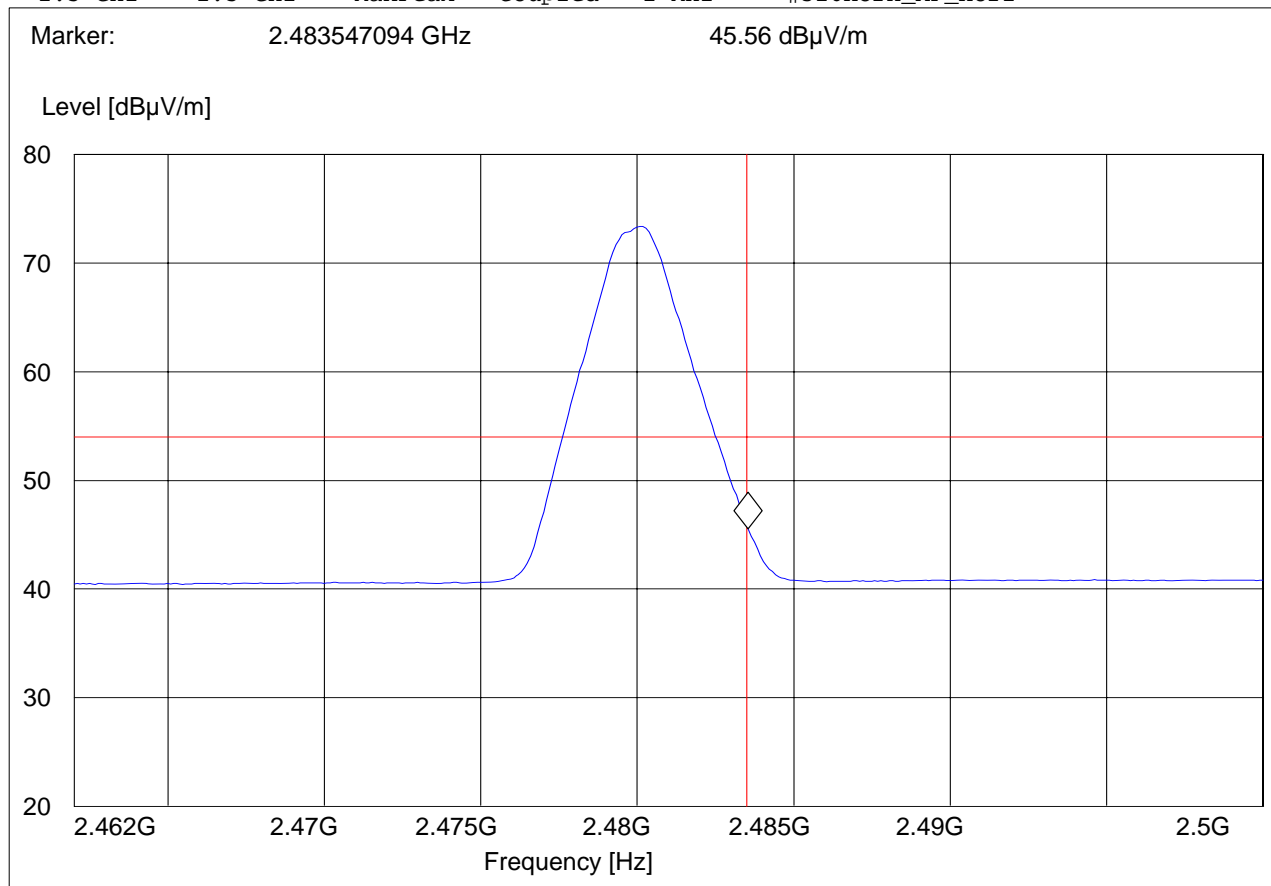



5.3 TRANSMITTER SPURIOUS EMISSIONS RADIATED § 15.247/15.205/15.209

5.3.1 LIMITS

Except as shown in paragraph (d) of this section, only spurious emissions are permitted in any of the frequency bands listed below:

MHz	MHz	MHz	GHz
0.090 - 0.110	16.42 - 16.423	399.9 - 410	4.5 - 5.15
0.495 - 0.505	16.69475 - 16.69525	608 - 614	5.35 - 5.46
2.1735 - 2.1905	16.80425 - 16.80475	960 - 1240	7.25 - 7.75
4.125 - 4.128	25.5 - 25.67	1300 - 1427	8.025 - 8.5
4.17725 - 4.17775	37.5 - 38.25	1435 - 1626.5	9.0 - 9.2
4.20725 - 4.20775	73 - 74.6	1645.5 - 1646.5	9.3 - 9.5
6.215 - 6.218	74.8 - 75.2	1660 - 1710	10.6 - 12.7
6.26775 - 6.26825	108 - 121.94	1718.8 - 1722.2	13.25 - 13.4
6.31175 - 6.31225	123 - 138	2200 - 2300	14.47 - 14.5
8.291 - 8.294	149.9 - 150.05	2310 - 2390	15.35 - 16.2
8.362 - 8.366	156.52475 - 156.52525	2483.5 - 2500	17.7 - 21.4
8.37625 - 8.38675	156.7 - 156.9	2690 - 2900	22.01 - 23.12
8.41425 - 8.41475	162.0125 - 167.17	3260 - 3267	23.6 - 24.0
12.29 - 12.293	167.72 - 173.2	3332 - 3339	31.2 - 31.8
12.51975 - 12.52025	240 - 285	3345.8 - 3358	36.43 - 36.5
12.57675 - 12.57725	322 - 335.4	3600 - 4400	(²)
13.36 - 13.41			

*PEAK LIMIT= 74dBuV/m
 *AVG. LIMIT= 54dBuV/m

NOTE:

1. The radiated emissions were done with different settings, using the relevant pre-amplifiers for the relevant frequency ranges. This is the reason that the graphs show different noise levels. In the range between 3 and 25 GHz very short cable connections to the antenna was used to minimize the noise level.
2. All measurements are done in peak mode using an average limit , unless specified with the plots.

Results for the radiated measurements below 30MHz according § 15.33

Frequency	Measured values	Remarks
9KHz – 30MHz	No emissions found, caused by the EUT	This is valid for all the tested channels

All Spurious Emission measurements are done in GFSK mode and represents the worse case emission from the device.



5.3.2 RESULTS

30MHz – 1GHz Antenna: vertical.

EUT: A1303
 Customer:: Apple
 Test Mode: BT DQPSK
 ANT Orientation: V
 EUT Orientation: V
 Test Engineer: Chris
 Voltage: FCC AC Adapter
 Comments:

SWEEP TABLE: "FCC15.247_30M-1G_Ver"

Start Frequency	Stop Frequency	Detector	Meas. Time	IF Bandw.	Transducer
30.0 MHz	1.0 GHz	MaxPeak	Coupled	100 kHz	3141-#1186_Vert

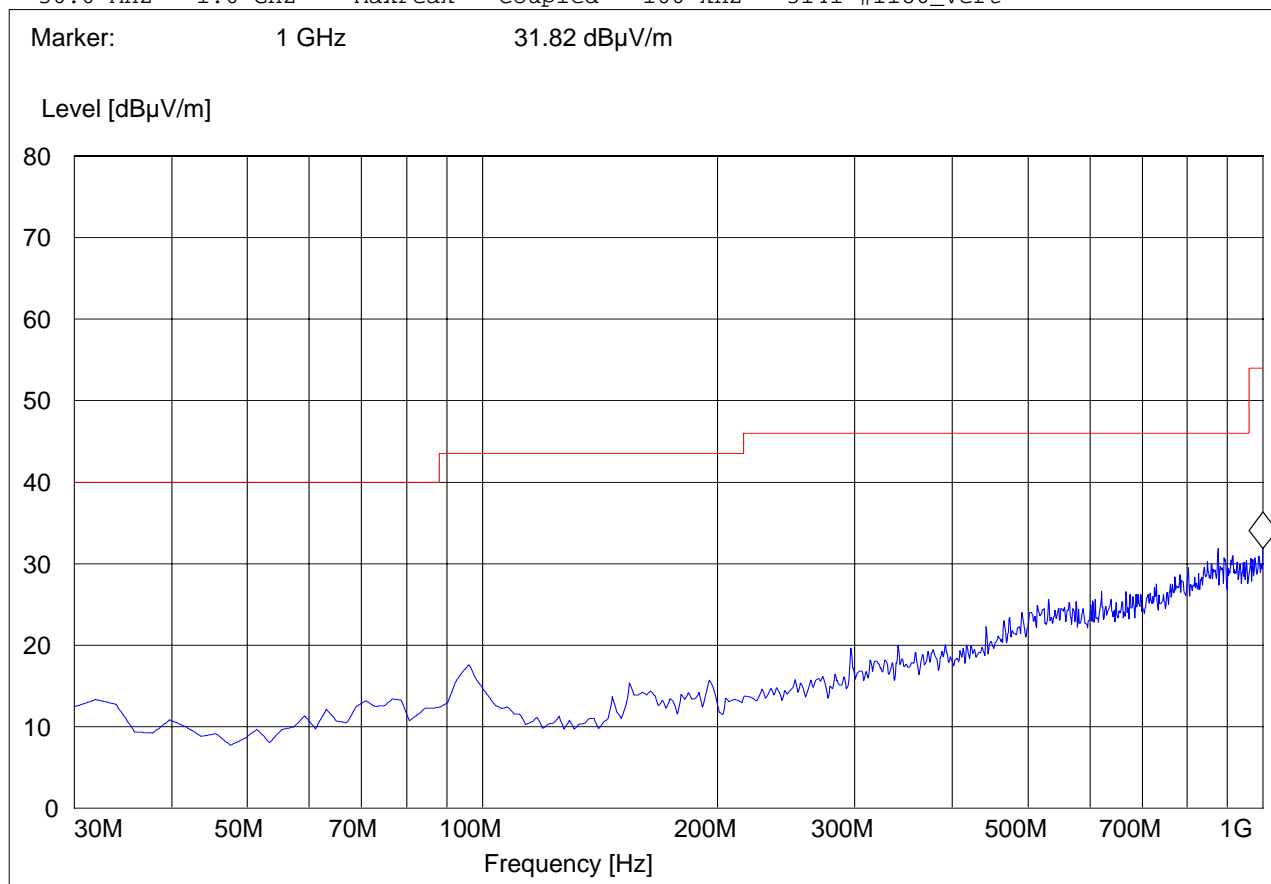



30MHz – 1GHz Antenna: horizontal

Note: This plot is valid for low, mid, high channels (worst-case plot)

EUT: A1303
Customer:: Apple
Test Mode: BT DQPSK
ANT Orientation: H
EUT Orientation: V
Test Engineer: Chris
Voltage: FCC AC Adapter
Comments:

SWEEP TABLE: "FCC15.247_30M-1G_Horz"

Start Frequency	Stop Frequency	Detector	Meas. Time	IF Bandw.	Transducer
30.0 MHz	1.0 GHz	MaxPeak	Coupled	100 kHz	3141-#1186_Horz

Marker: 963.066132 MHz 34.42 dBµV/m

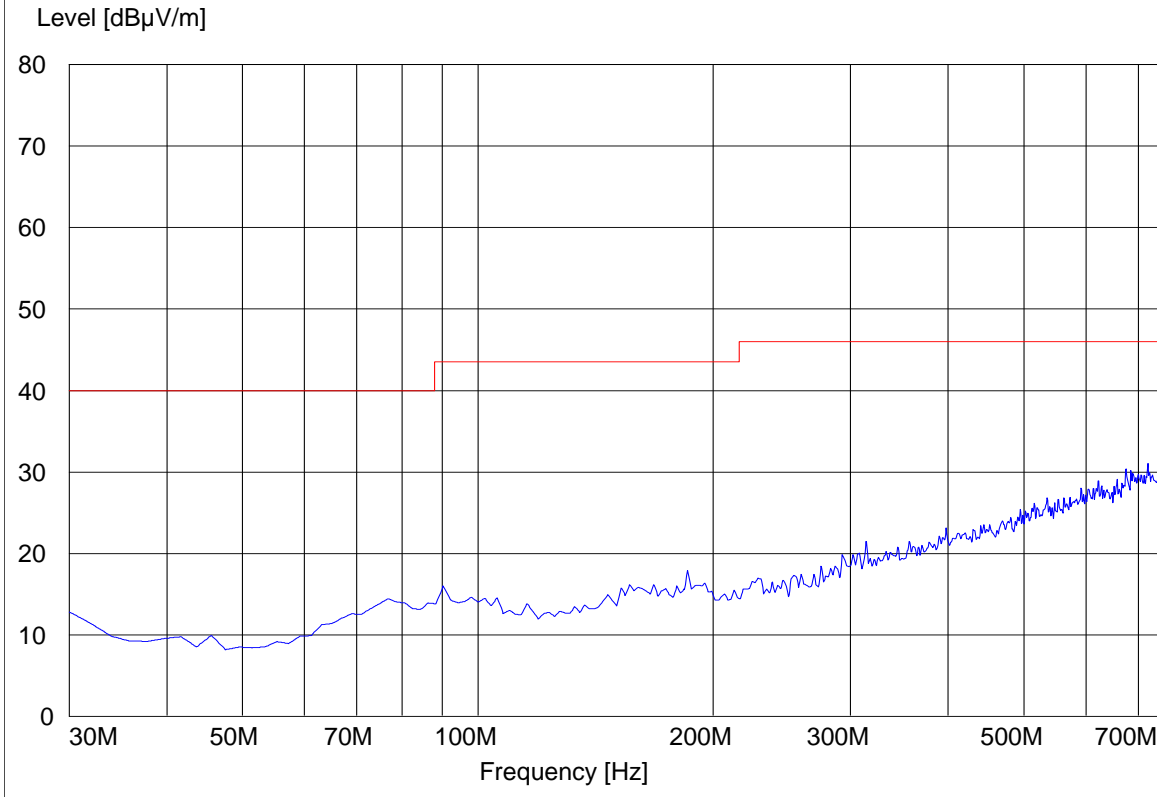



1-3GHz (2402MHz)

Note: The peak above the limit line is the carrier freq.

Note: Peak Reading vs. Average limit

EUT: A1303
Customer:: Apple
Test Mode: BT Ch.0 DQPSK
ANT Orientation: H
EUT Orientation: V
Test Engineer: Chris
Voltage: FCC AC Adapter
Comments:

SWEEP TABLE: "FCC15.247_1-3G"

Start Frequency	Stop Frequency	Detector	Meas. Time	IF Bandw.	Transducer
1.0 GHz	3.0 GHz	MaxPeak	Coupled	1 MHz	#326horn_AF_vert

Marker: 2.402805611 GHz 95.15 dBμV/m

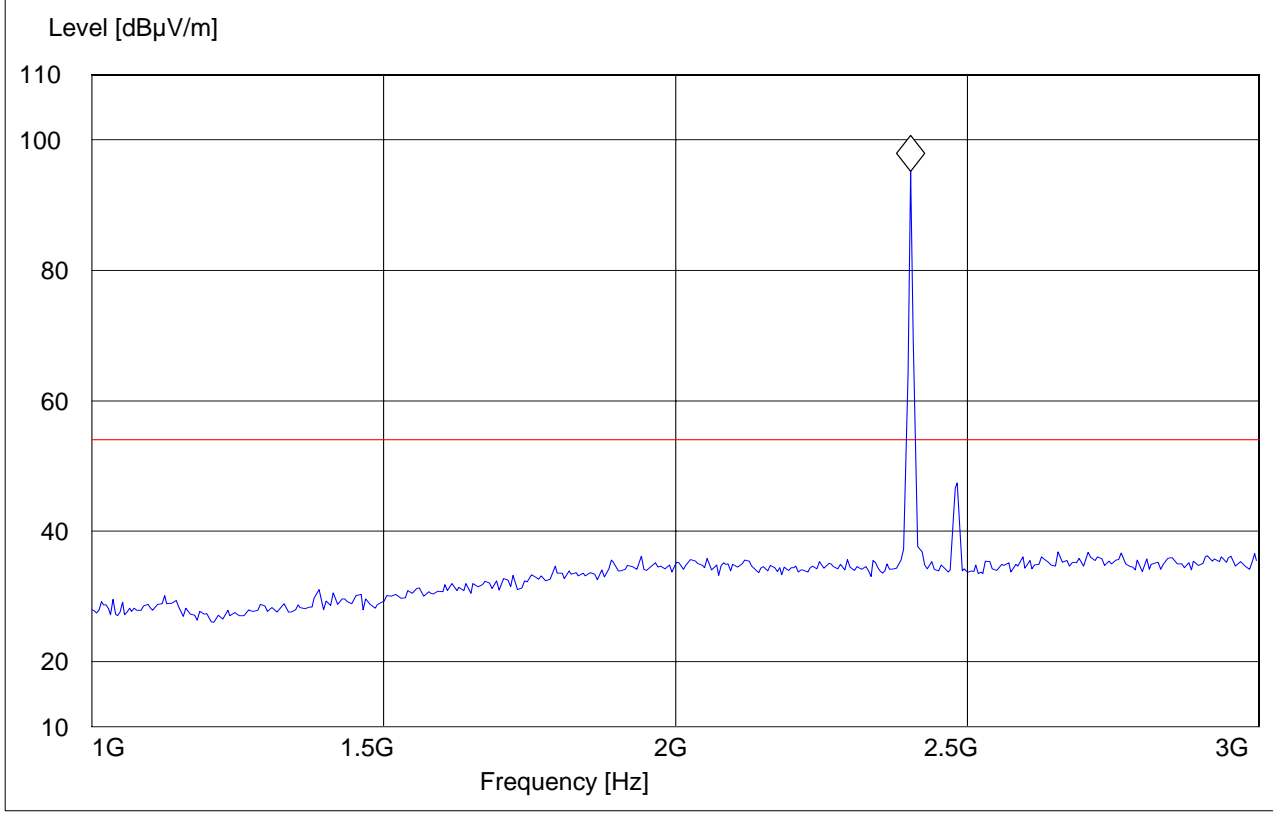



1-3GHz (2441MHz)

Note: The peak above the limit line is the carrier freq.

EUT: A1303
Customer:: Apple
Test Mode: BT Ch.39 DQPSK
ANT Orientation: H
EUT Orientation: V
Test Engineer: Chris
Voltage: FCC AC Adapter
Comments:

SWEEP TABLE: "FCC15.247_1-3G"

Start Frequency	Stop Frequency	Detector	Meas. Time	IF Bandw.	Transducer
1.0 GHz	3.0 GHz	MaxPeak	Coupled	1 MHz	#326horn_AF_vert

Marker: 2.442885772 GHz 95.09 dBµV/m

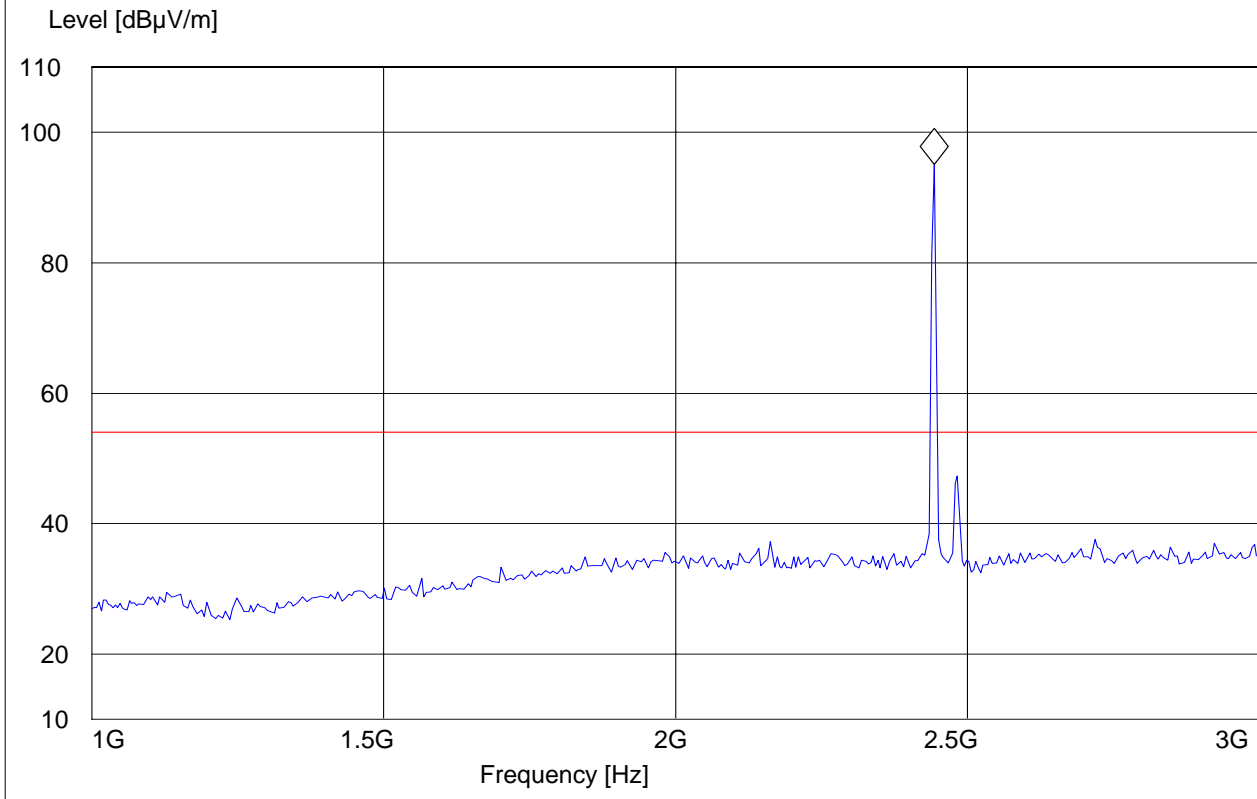



1-3GHz (2480MHz)

Note: The peak above the limit line is the carrier freq.

Note: Peak Reading vs. Average limit

EUT: A1303
 Customer:: Apple
 Test Mode: BT Ch.78 DQPSK
 ANT Orientation: H
 EUT Orientation: V
 Test Engineer: Chris
 Voltage: FCC AC Adapter
 Comments:

SWEEP TABLE: "FCC15.247_1-3G"

Start Frequency	Stop Frequency	Detector	Meas. Time	IF Bandw.	Transducer
1.0 GHz	3.0 GHz	MaxPeak	Coupled	1 MHz	#326horn_AF_vert

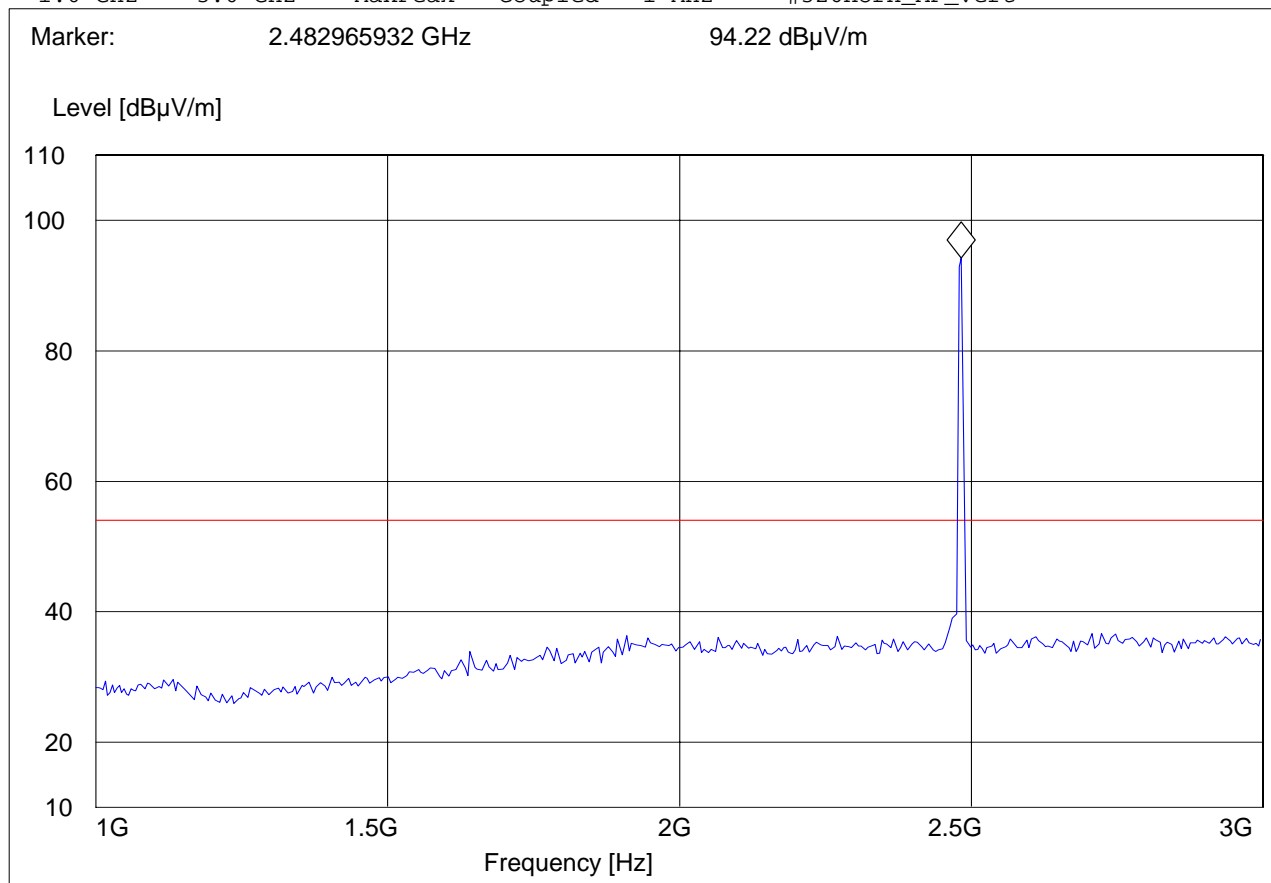



3-18GHz (2402MHz)

Note: Peak Reading vs. Average limit

EUT: A1303
Customer:: Apple
Test Mode: BT Ch.0 DQPSK
ANT Orientation: H
EUT Orientation: V
Test Engineer: Chris
Voltage: FCC AC Adapter
Comments:

SWEEP TABLE: "FCC15.247_3-18G"

Start Frequency	Stop Frequency	Detector	Meas. Time	IF Bandw.	Transducer
3.0 GHz	18.0 GHz	MaxPeak	Coupled	1 MHz	#326horn_AF_vert

Marker: 17.488977956 GHz 47.12 dB μ V/m

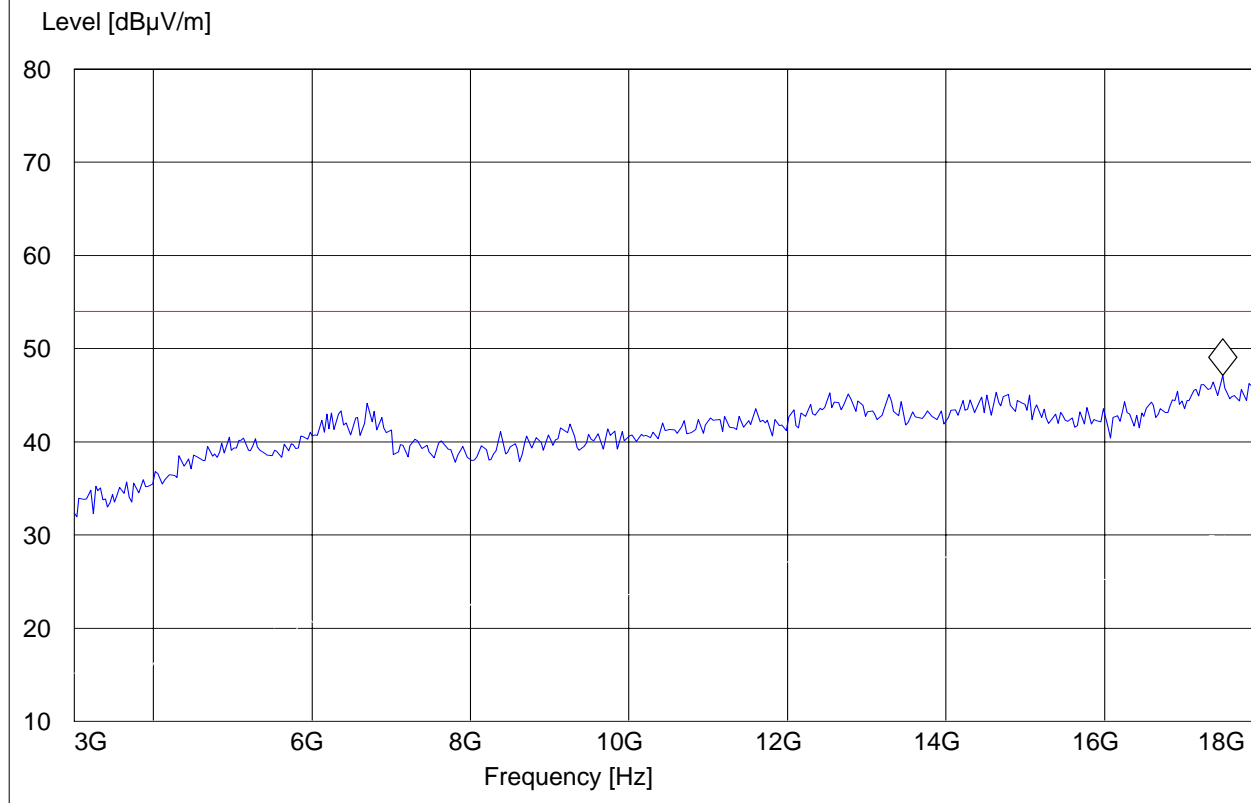



3-18GHz (2441MHz)

Note: Peak Reading vs. Average limit

EUT: A1303
Customer:: Apple
Test Mode: BT Ch.39 DQPSK
ANT Orientation: H
EUT Orientation: V
Test Engineer: Chris
Voltage: FCC AC Adapter
Comments:

SWEEP TABLE: "FCC15.247_3-18G"

Start Frequency	Stop Frequency	Detector	Meas. Time	IF Bandw.	Transducer
3.0 GHz	18.0 GHz	MaxPeak	Coupled	1 MHz	#326horn_AF_vert

Marker: 17.158316633 GHz 47.77 dB μ V/m

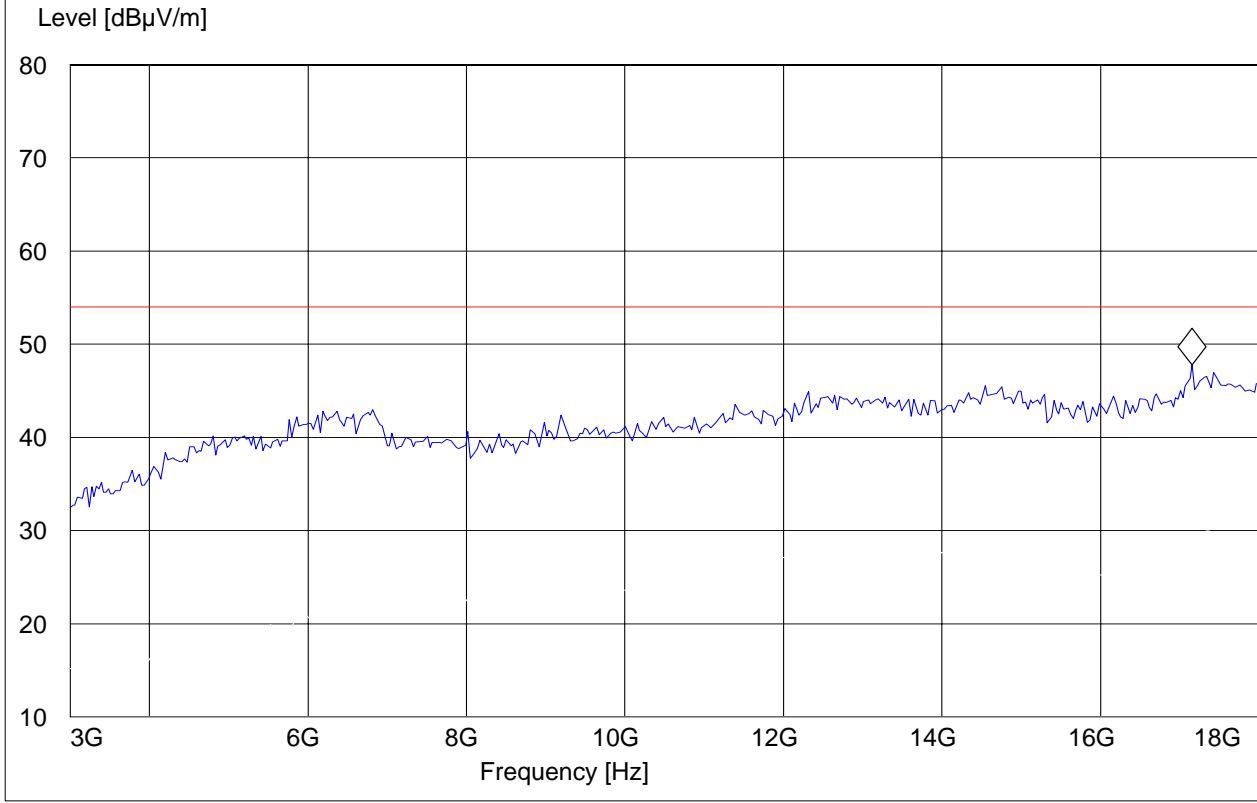



3-18GHz (2480MHz)

Note: Peak Reading vs. Average limit

EUT: A1303
 Customer:: Apple
 Test Mode: BT Ch.78 DQPSK
 ANT Orientation: H
 EUT Orientation: V
 Test Engineer: Chris
 Voltage: FCC AC Adapter
 Comments:

SWEEP TABLE: "FCC15.247_3-18G"

Start Frequency	Stop Frequency	Detector	Meas. Time	IF Bandw.	Transducer
3.0 GHz	18.0 GHz	MaxPeak	Coupled	1 MHz	#326horn_AF_vert

Marker: 17.308617234 GHz 48.12 dBµV/m

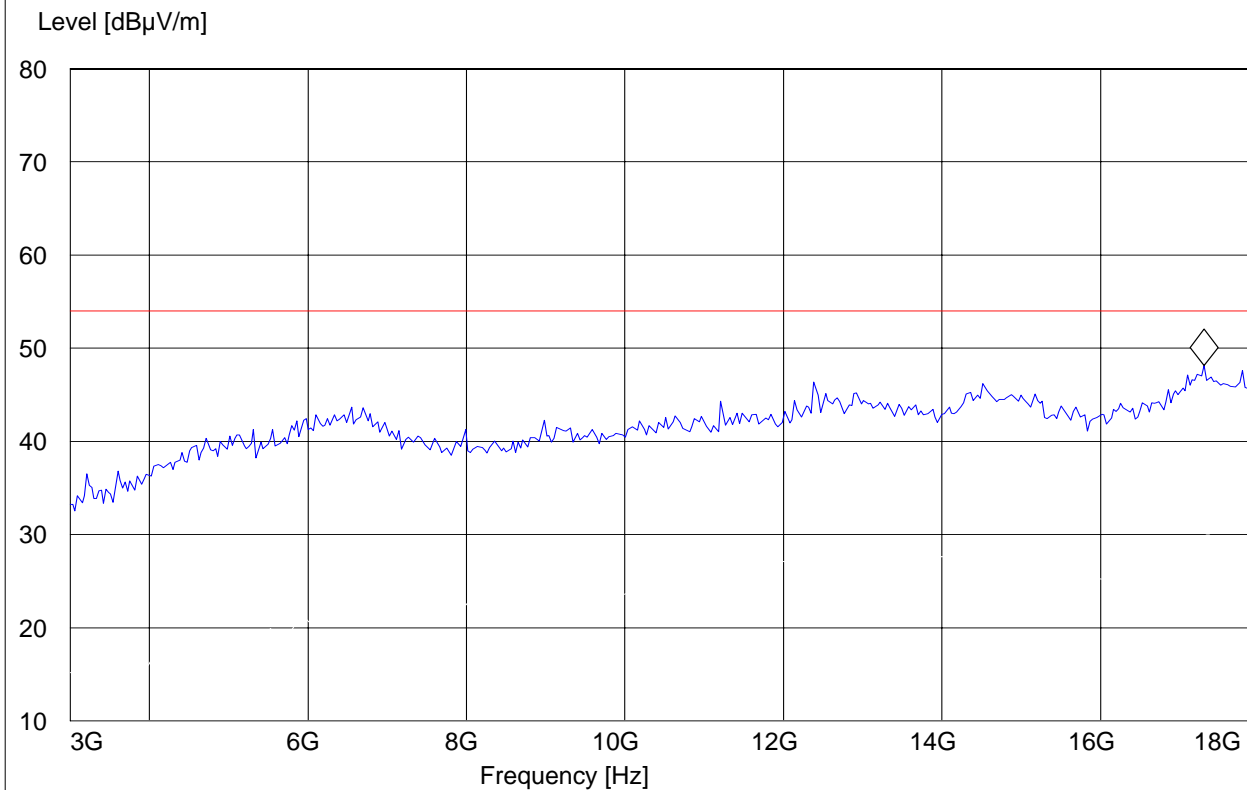



18-25GHz

Note: This plot is valid for low, mid, high channels (worst-case plot)

Note: Peak Reading vs. Average limit

EUT: A1303
 Customer:: Apple
 Test Mode: BT DQPSK
 ANT Orientation: H
 EUT Orientation: V
 Test Engineer: Chris
 Voltage: FCC AC Adapter
 Comments:

SWEEP TABLE: "FCC15.247_18-26.5G"

Start Frequency	Stop Frequency	Detector	Meas. Time	IF Bandw.	Transducer
18.0 GHz	26.5 GHz	MaxPeak	Coupled	100 kHz	Horn # 3116_18-40G
		MaxPeak			

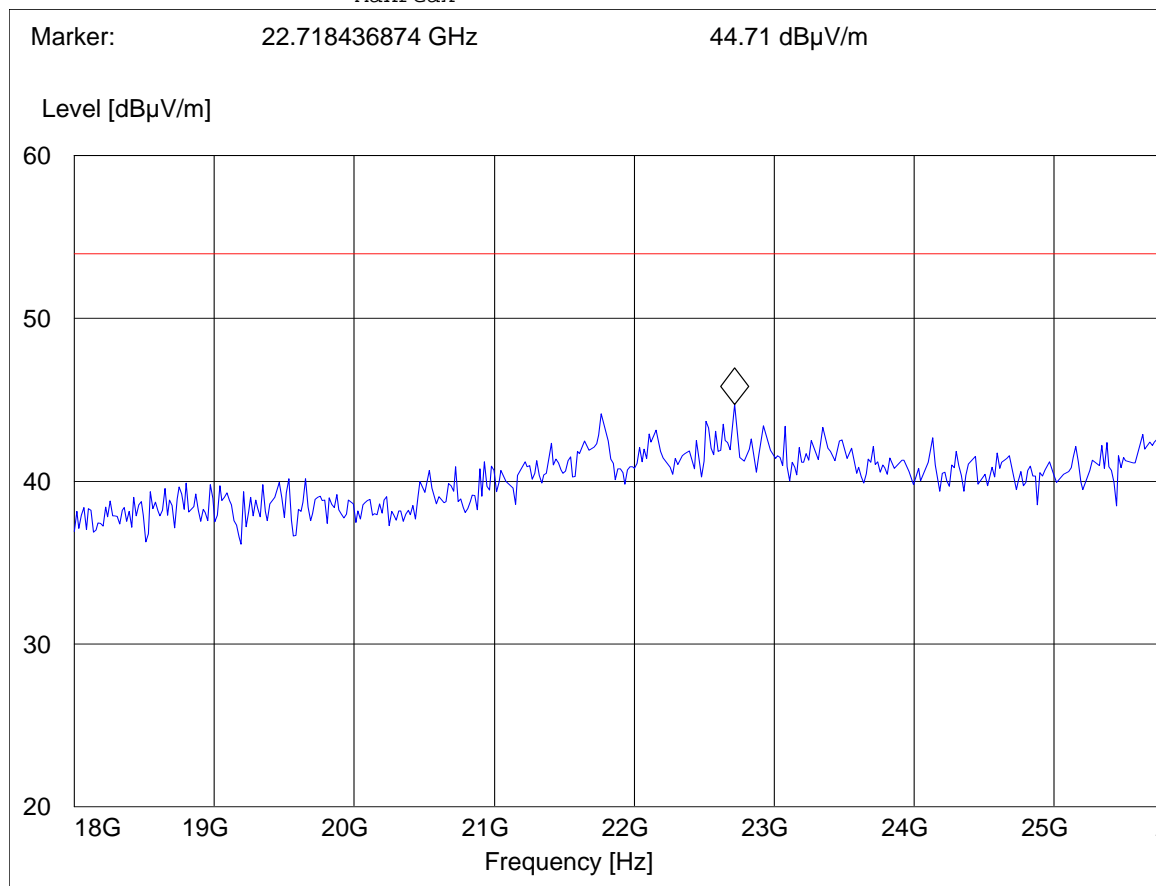



5.4 RECEIVER SPURIOUS RADIATION RSS-Gen(4.10)

5.4.1 LIMITS

Frequency (MHz)	Field strength ($\mu\text{V}/\text{m}$)	Measurement distance (m)
0.009 - 0.490	2400/F (kHz)	300
0.490 - 1.705	24000/F (kHz)	30
1.705 - 30.0	30	30
30 - 88	100	3
88 - 216	150	3
216 - 960	200	3
above 960	500	3

NOTE:

1. The radiated emissions were done with different settings, using the relevant pre-amplifiers for the relevant frequency ranges. This is the reason that the graphs show different noise levels. In the range between 3 and 25 GHz very short cable connections to the antenna was used to minimize the noise level.
2. All measurements are done in peak mode using an average limit, unless specified with the plots.



5.4.2 Results

30MHz – 1GHz Antenna: Vertical.

Note: This plot is valid for low, mid, high channels (worst-case plot)

EUT: A1303
 Customer:: Apple
 Test Mode: BT CH.39; GFSK
 ANT Orientation: V
 EUT Orientation: V
 Test Engineer: Chris
 Voltage: AC Adapter
 Comments:

SWEEP TABLE: "FCC15.247_30M-1G_Ver"

Start Frequency	Stop Frequency	Detector	Meas. Time	IF Bandw.	Transducer
30.0 MHz	1.0 GHz	MaxPeak	Coupled	100 kHz	3141-#1186_Vert

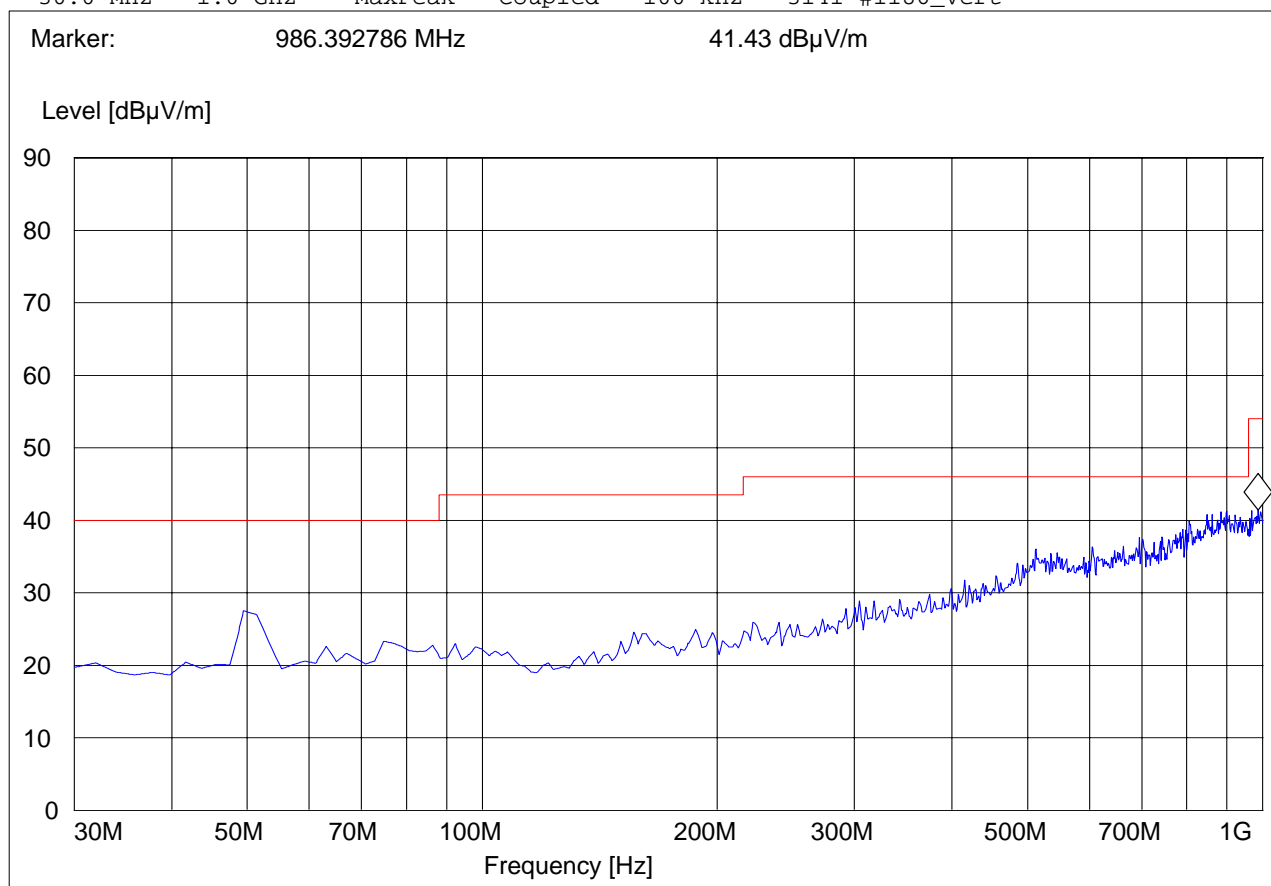



30MHz – 1GHz Antenna: horizontal.
 Note: This plot is valid for low, mid, high channels (worst-case plot)

EUT: A1303
 Customer:: Apple
 Test Mode: BT CH.39; GFSK
 ANT Orientation: H
 EUT Orientation: V
 Test Engineer: Chris
 Voltage: AC Adapter
 Comments:

SWEEP TABLE: "FCC15.247_30M-1G_Hor"

Start Frequency	Stop Frequency	Detector	Meas. Time	IF Bandw.	Transducer
30.0 MHz	1.0 GHz	MaxPeak	Coupled	100 kHz	3141-#1186_Horz

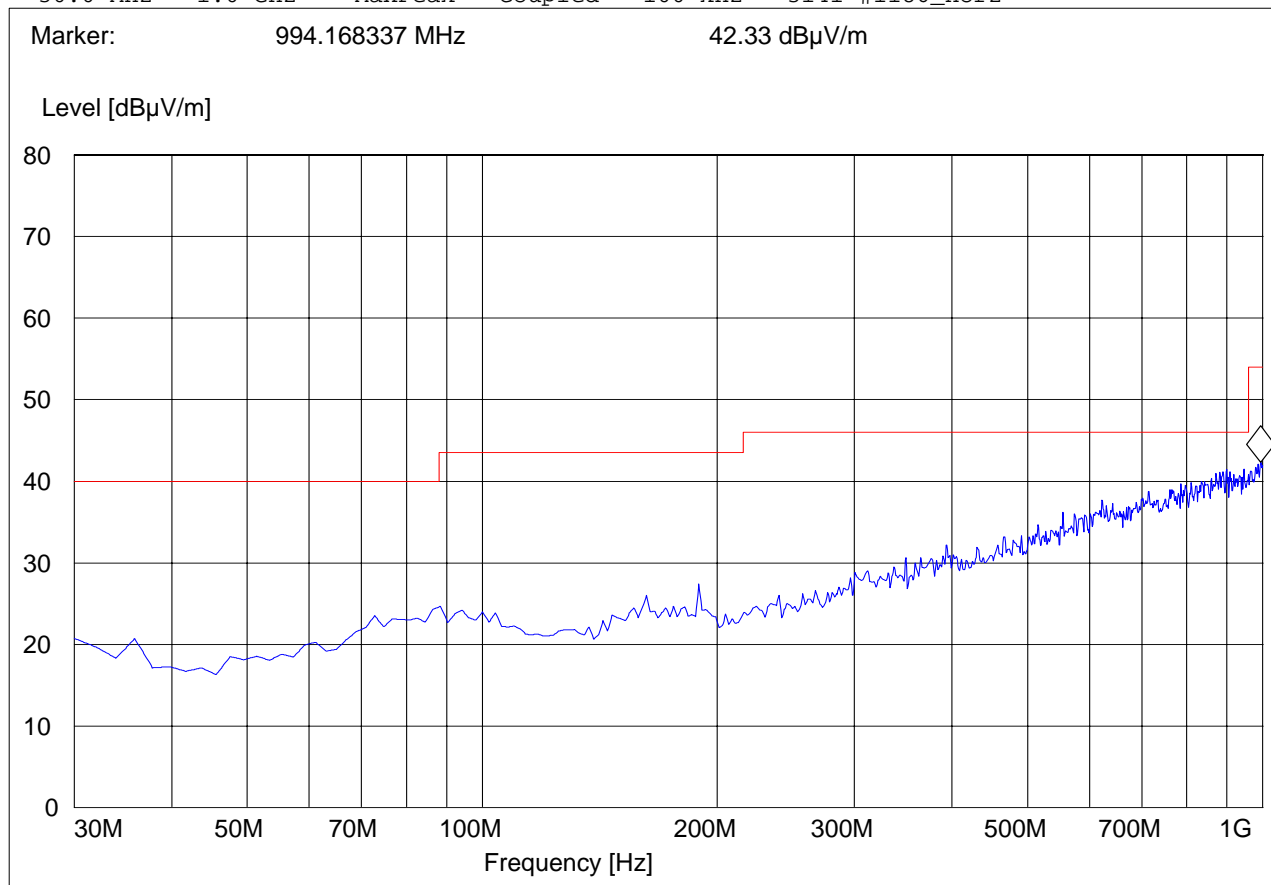



1-18GHz

CETECOM Inc.

411 Dixon Landing Road; Milpitas, CA 95035

EUT: A1303
Customer:: Apple
Operation Mode: BT CH.39; GFSK
ANT Orientation: : H
EUT Orientation:: V
Test Engineer: Chris
Voltage: AC Adapter
Comments::

SWEEP TABLE: "FCC15.247_1-18G"

Start Frequency	Stop Frequency	Detector	Meas. Time	IF Bandw.	Transducer
1.0 GHz	18.0 GHz	MaxPeak	Coupled	1 MHz	#326horn_AF_horz

Marker: 17.318637275 GHz 46.21 dB μ V/m

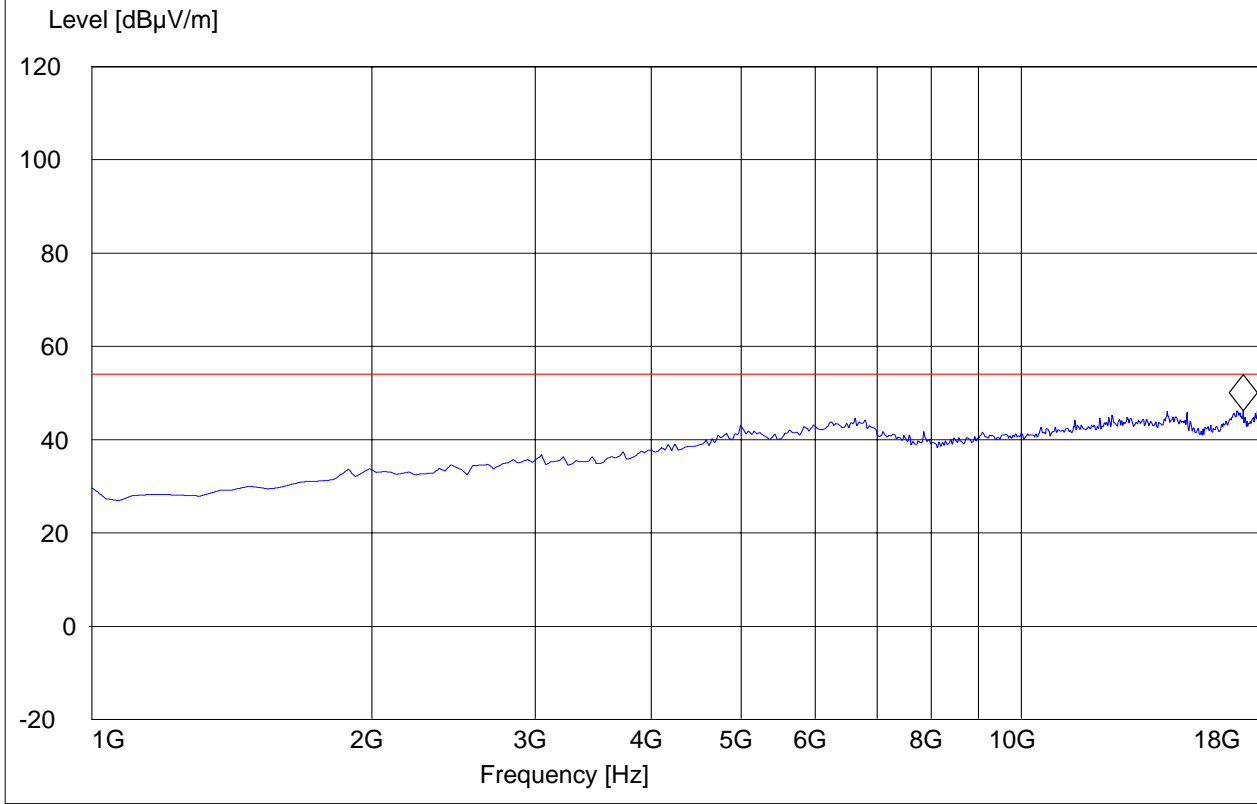



6 Measurements (CONDUCTED)

6.1 MAXIMUM PEAK OUTPUT POWER § 15.247 (CONDUCTED)

6.1.1 LIMIT SUB CLAUSE § 15.247 (b) (1)

Frequency range	RF power output
2400-2483.5 MHz	30dBm

*limit is based upon antenna gain of less than or equal to 6dBi.

6.1.2 RESULTS: GFSK

TEST CONDITIONS		MAXIMUM PEAK OUTPUT POWER (dBm)		
Frequency (MHz)		2402 MHz	2441 MHz	2480 MHz
T _{nom} (23)°C	V _{nom} VDC	7.9	8	8.1

6.1.3 RESULTS: $\pi / 4$ DQPSK

TEST CONDITIONS		MAXIMUM PEAK OUTPUT POWER (dBm)		
Frequency (MHz)		2402 MHz	2441 MHz	2480 MHz
T _{nom} (23)°C	V _{nom} VDC	9.2	9.8	9.8

6.1.4 RESULTS: 8DPSK

TEST CONDITIONS		MAXIMUM PEAK OUTPUT POWER (dBm)		
Frequency (MHz)		2402 MHz	2441 MHz	2480 MHz
T _{nom} (23)°C	V _{nom} VDC	9.4	10	10



(2402 MHz) GFSK

Bluetooth Power

dB Max. Level: Auto Hopp./Chan./Freq./Packet: RX/TX single / All / All / DH5
 +10.00 --- / Off 0: --- / Off 2: --- / Off

Current

	Current(0 ch)	Average	Minimum	Maximum
Power Nomin. [dBm]	+6.7	+6.7	+6.6	+6.7
Leak. [dBm]	-55.4	-55.2	-57.9	-52.4
Peak [dBm]	+7.2	+7.2	+7.1	+7.9
Packet Timing [µs]	+1.50	+1.63	+1.00	+2.00
Delta Level [dB]	---			

100

 Bursts
 Statistic Count

0.00 %

 Bursts out of Tol.(Pow.)

0.00 %

 Bursts out of Tol.(Tim.)

Testmode Type

Hopping Scheme

RX/TX Frequency

Pattern Type

Packet Type

Length of Test Sequ.

Connect. Control

RUN

Output Power

Appli- cation

Analyzer Level

Analyzer Settings

Slave Sig. 1

Slave Sig.2

Master Sig.

Display

Marker

Menus



(2441 MHz) GFSK

Bluetooth Power

Connect. Control

dB Max. Level: Auto
Hopp./Chan./Freq./Packet: RX/TX single / All / All / DH5

+10.00 --- / Off
0: --- / Off
2: --- / Off

Current

0
500
1,000
1,500
2,000
2,500
Bit

	Current (39 ch)	Average	Minimum	Maximum
Power Nomin. [dBm]	+7.1	+7.1	+7.1	+7.1
Leak. [dBm]	-56.0	-55.7	-58.2	-53.2
Peak [dBm]	+7.5	+7.5	+7.5	+8.0
Packet Timing [µs]	+1.50	+1.66	+1.00	+2.25
Delta Level [dB]	---			

100 Bursts

Statistic Count

0.00 %

Bursts out of Tol.(Pow.)

0.00 %

Bursts out of Tol.(Tim.)

Testmode Type

Hopping Scheme

RX/TX Frequency

Pattern Type

Packet Type

Length of Test Sequ.

Output Power

Application

Analyzer Level

Analyzer Settings

Slave Sig. 1

Slave Sig. 2

Master Sig.

Display Marker

Menus



(2480 MHz) GFSK

Bluetooth Power

dB Max. Level: Auto
 +10.0C --- / Off

Hopp./Chan./Freq./Packet: RX/TX single / All / All / DHS
 0: --- / Off 2: --- / Off

	Current(78 ch)	Average	Minimum	Maximum
Power Nomin. [dBm]	+6.9	+6.9	+6.7	+6.9
Leak. [dBm]	-54.1	-55.6	-57.7	-53.4
Peak [dBm]	+7.4	+7.4	+7.3	+8.1
Packet Timing [μs]	+1.50	+1.68	+1.25	+2.50
Delta Level [dB]	---			

100 Bursts
 Statistic Count

0.00 %
 Bursts out of Tol.(Pow.)

0.00 %
 Bursts out of Tol.(Tim.)

Testmode Type

Hopping Scheme

RX/TX Frequency

Pattern Type

Packet Type

Length of Test Sequ.

Connect. Control

Output Power

Application

Analyzer Level

Analyzer Settings

Slave Sig. 1

Slave Sig. 2

Master Sig.

Display Marker

Menus



(2402 MHz) $\pi / 4$ DQPSK

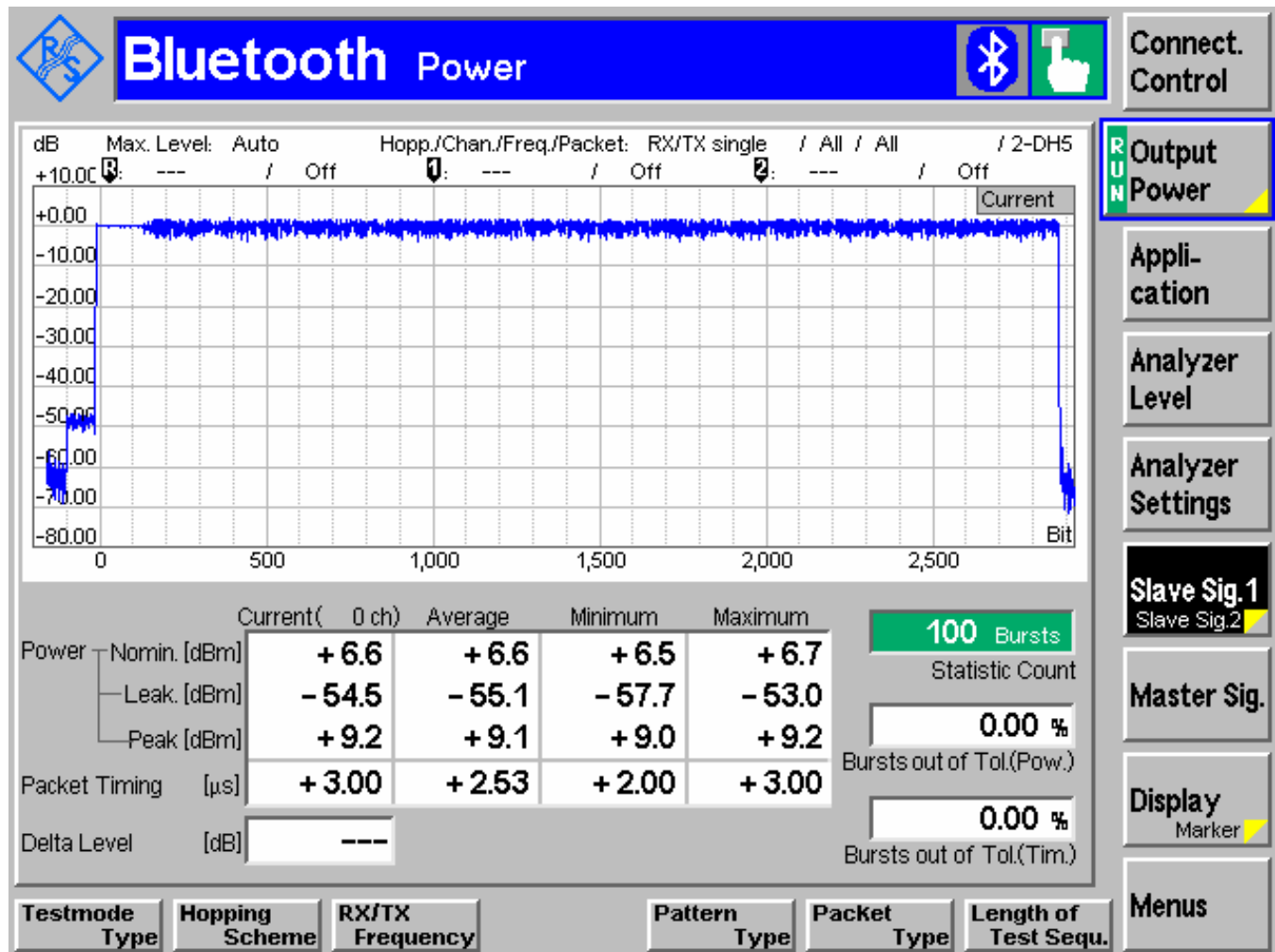



(2441 MHz) $\pi / 4$ DQPSK

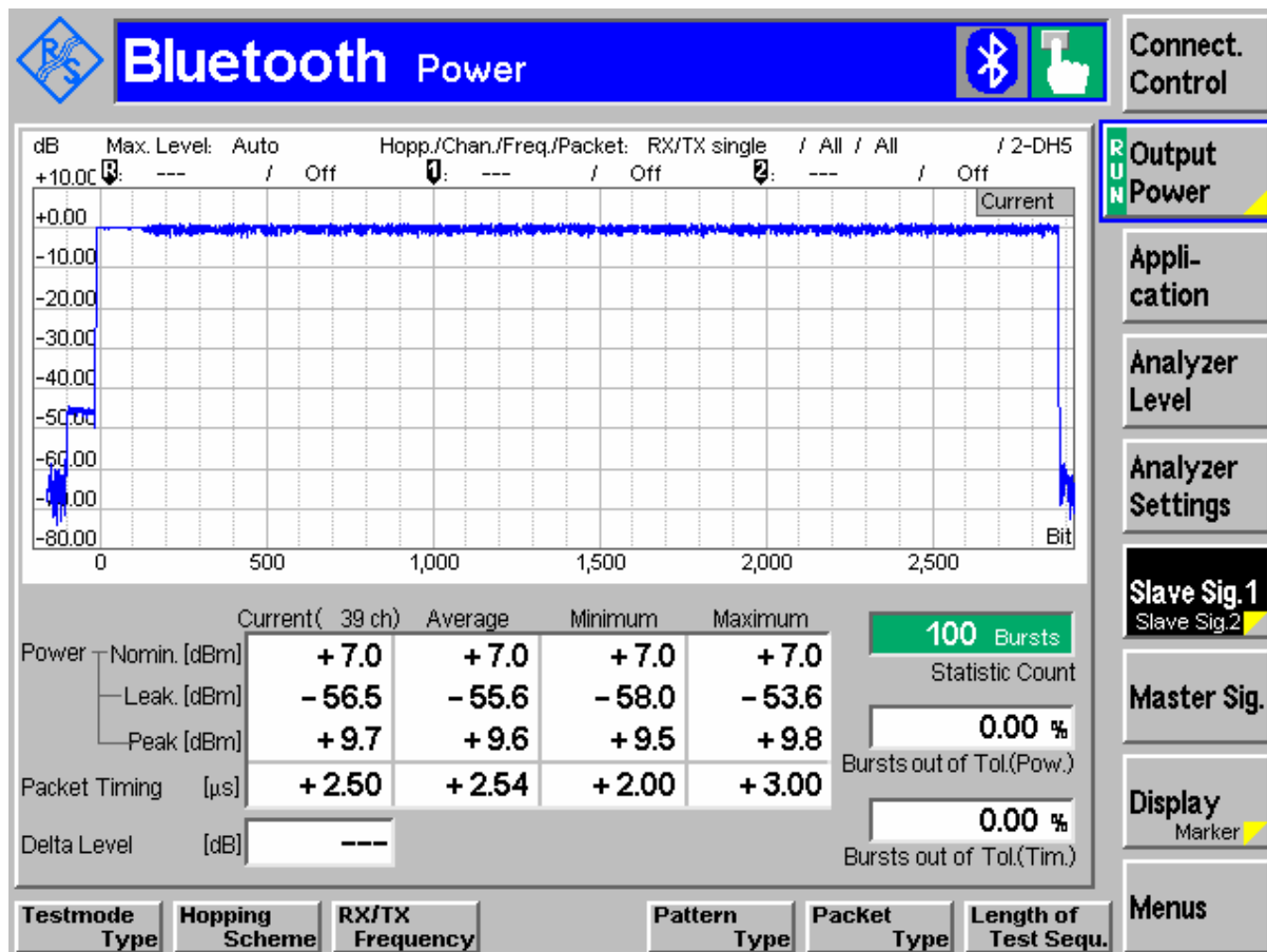



(2480 MHz) $\pi / 4$ DQPSK

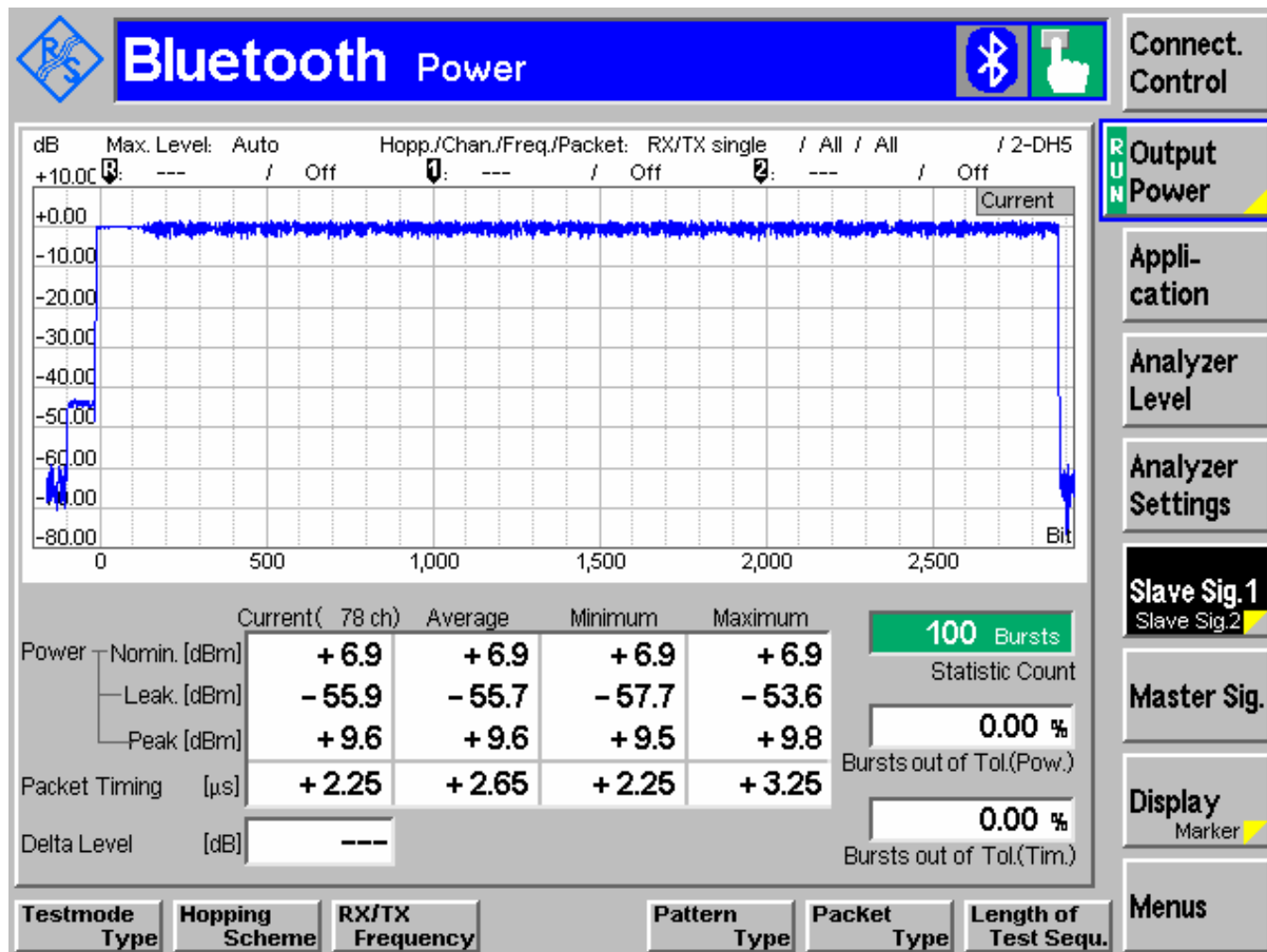



(2402 MHz) 8DPSK

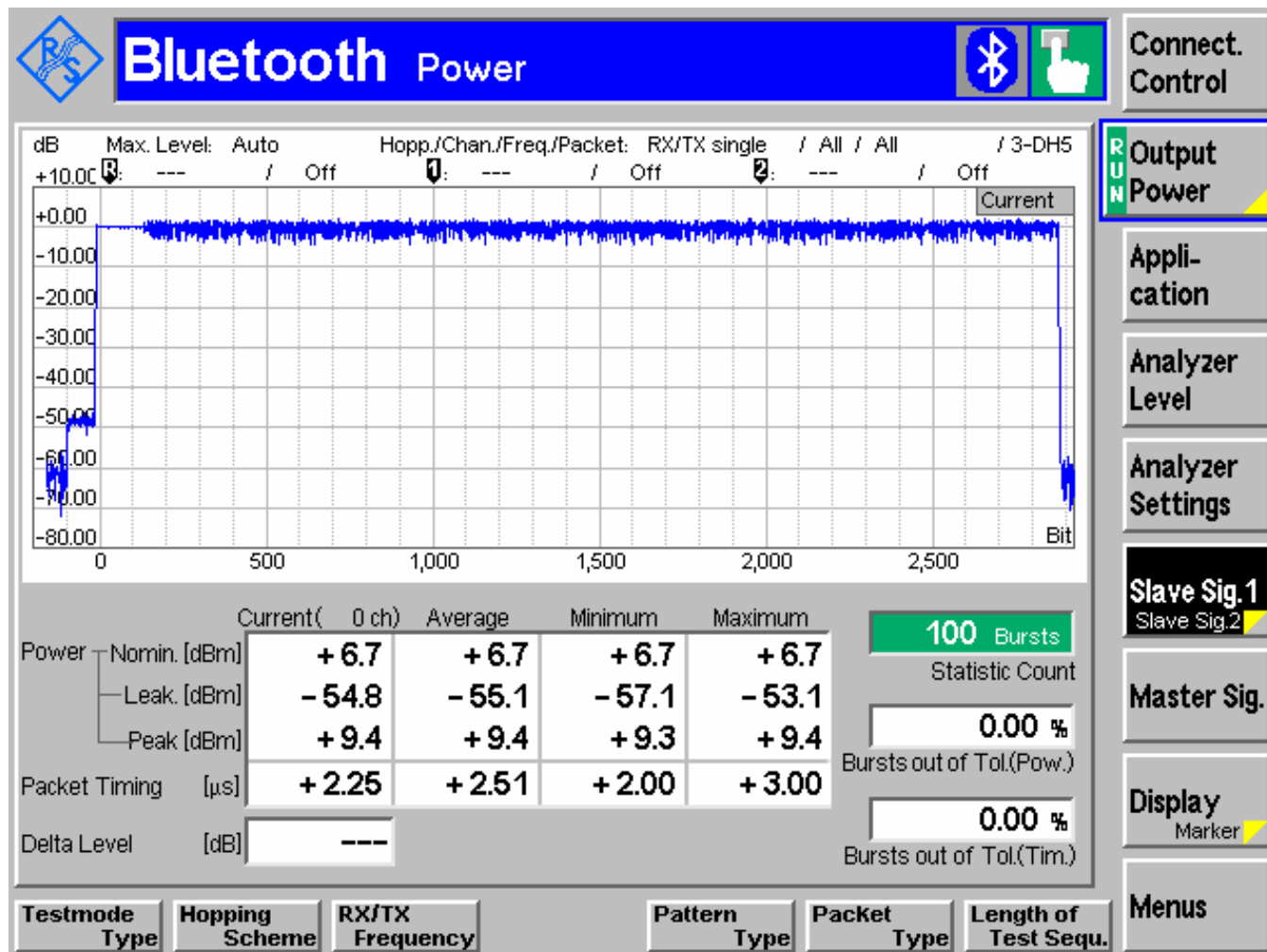



(2441 MHz) 8DPSK

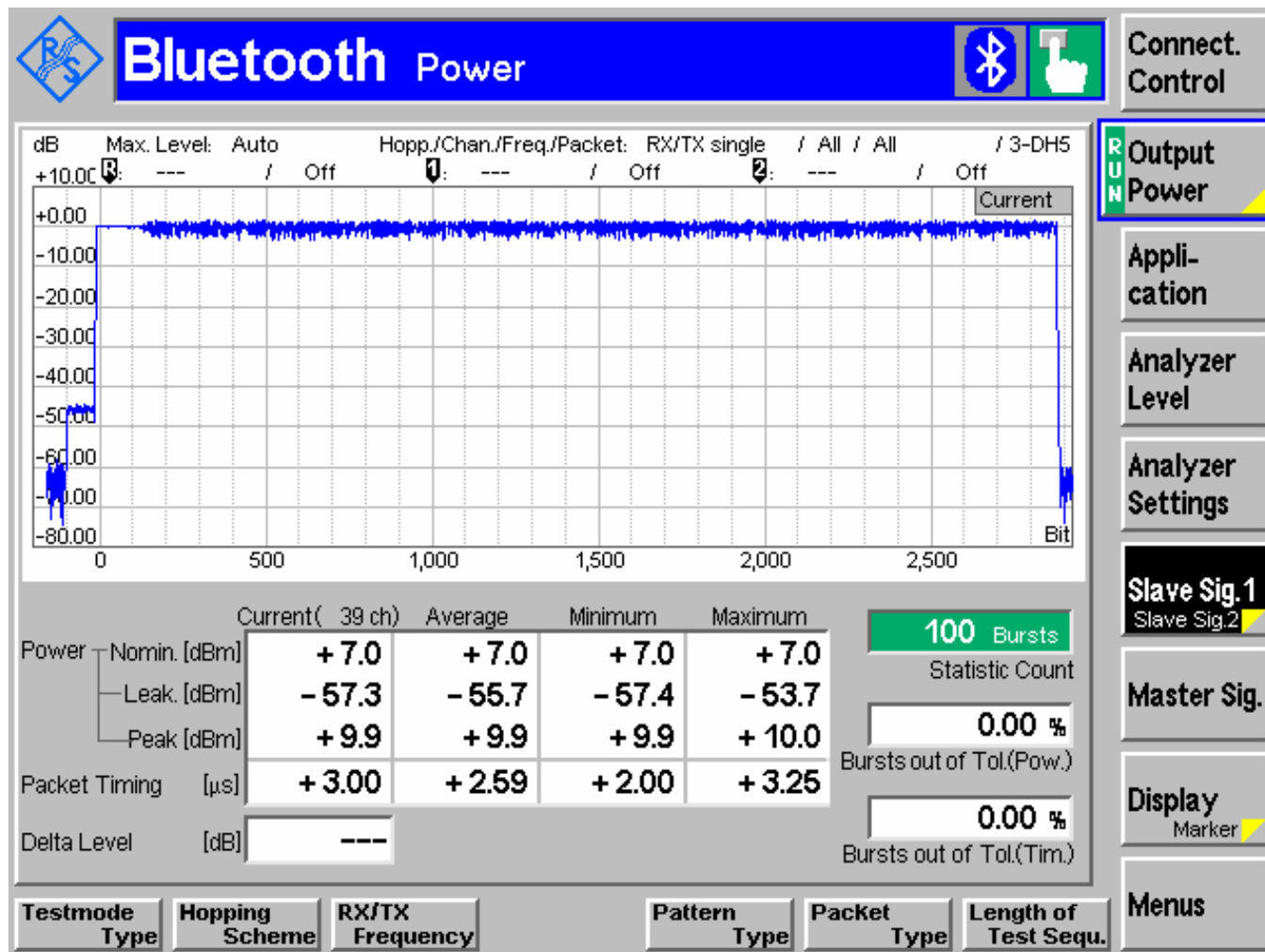



(2480 MHz) 8DPSK

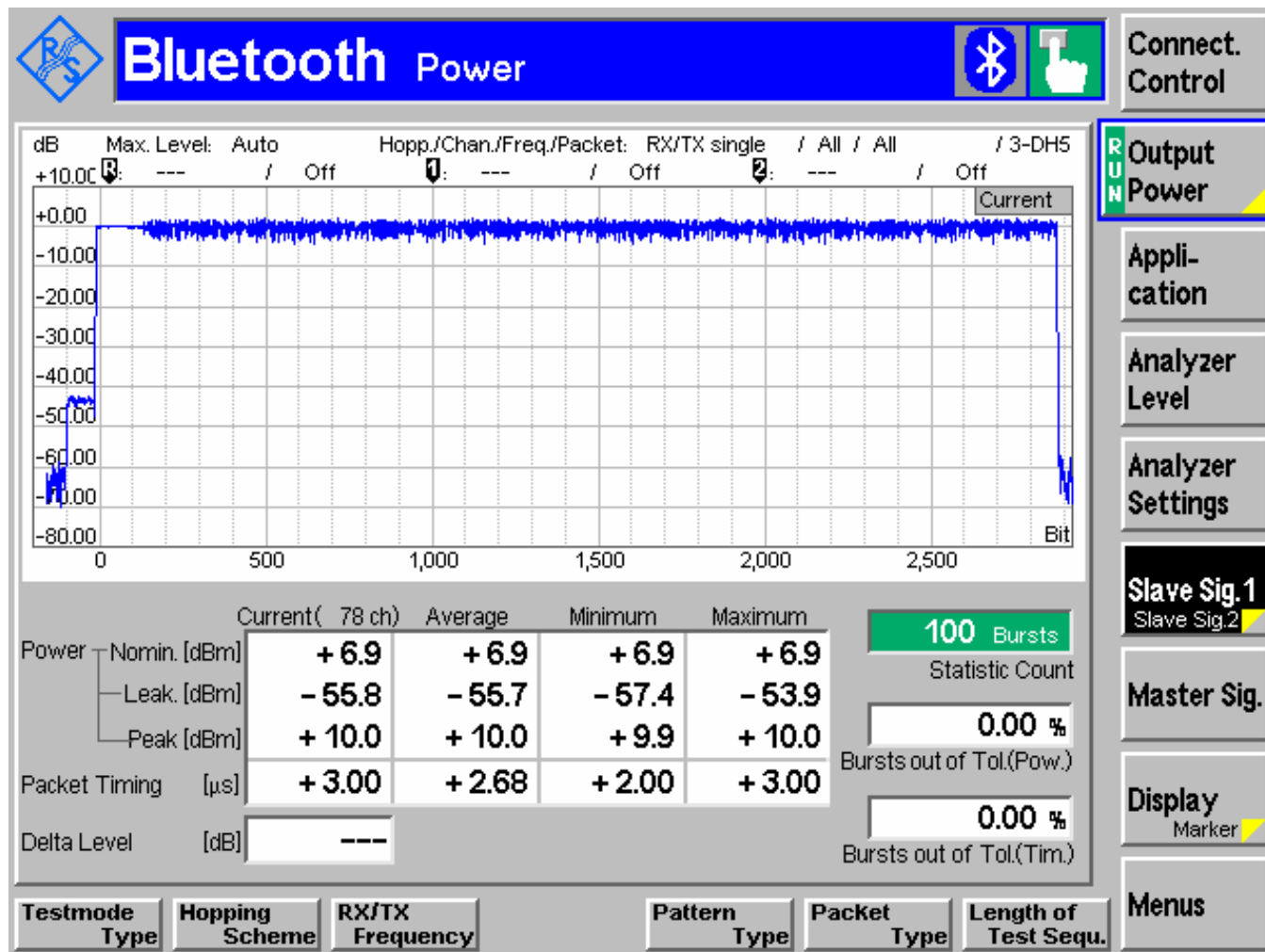



6.2 20dB BANDWIDTH

6.2.1 LIMIT SUB CLAUSE § 15.247 (a) (1) (i) (ii) (iii)

Alternatively, frequency hopping systems operating in the 2400–2483.5 MHz band may have hopping channel carrier frequencies that are separated by 25 kHz or two-thirds of the 20 dB bandwidth of the hopping channel, whichever is greater, provided the systems operate with an output power no greater than 125 mW.

6.2.2 RESULTS: GFSK

GFSK

Channel No.	Frequency (MHz)	20dB BW (kHz)	Result (Fail/Pass)
0	2402	0.919	PASS
39	2441	0.917	PASS
78	2480	0.918	PASS

Pi/4 DQPSK (If EDR supported)

Channel No.	Frequency (MHz)	20dB BW (kHz)	Result (Fail/Pass)
0	2402	1.310	PASS
39	2441	1.309	PASS
78	2480	1.308	PASS

8DPSK (If EDR supported)

Channel No.	Frequency (MHz)	20dB BW (kHz)	Result (Fail/Pass)
0	2402	1.263	PASS
39	2441	1.264	PASS
78	2480	1.264	PASS

(2402 MHz) GFSK

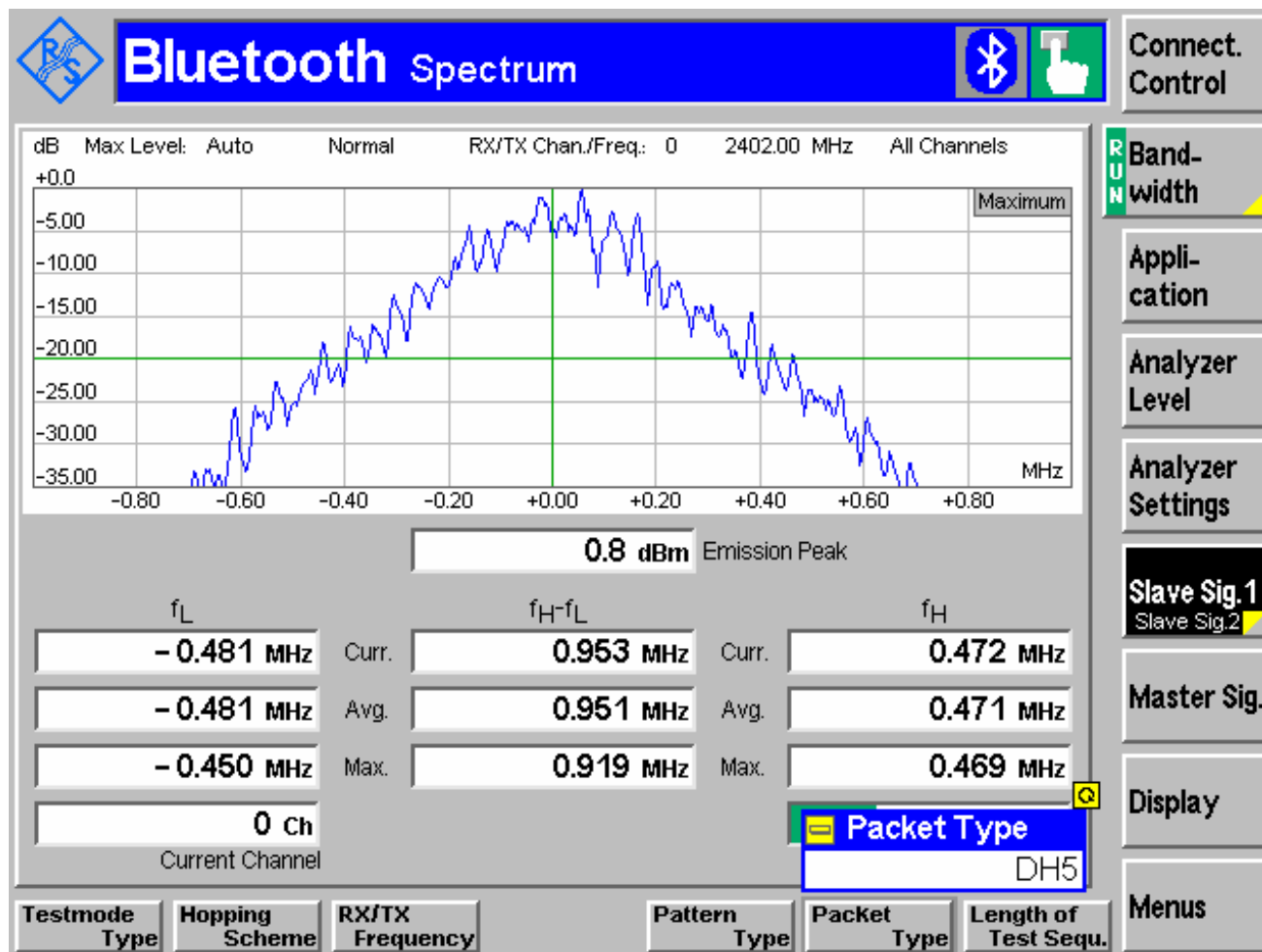



(2441 MHz) GFSK

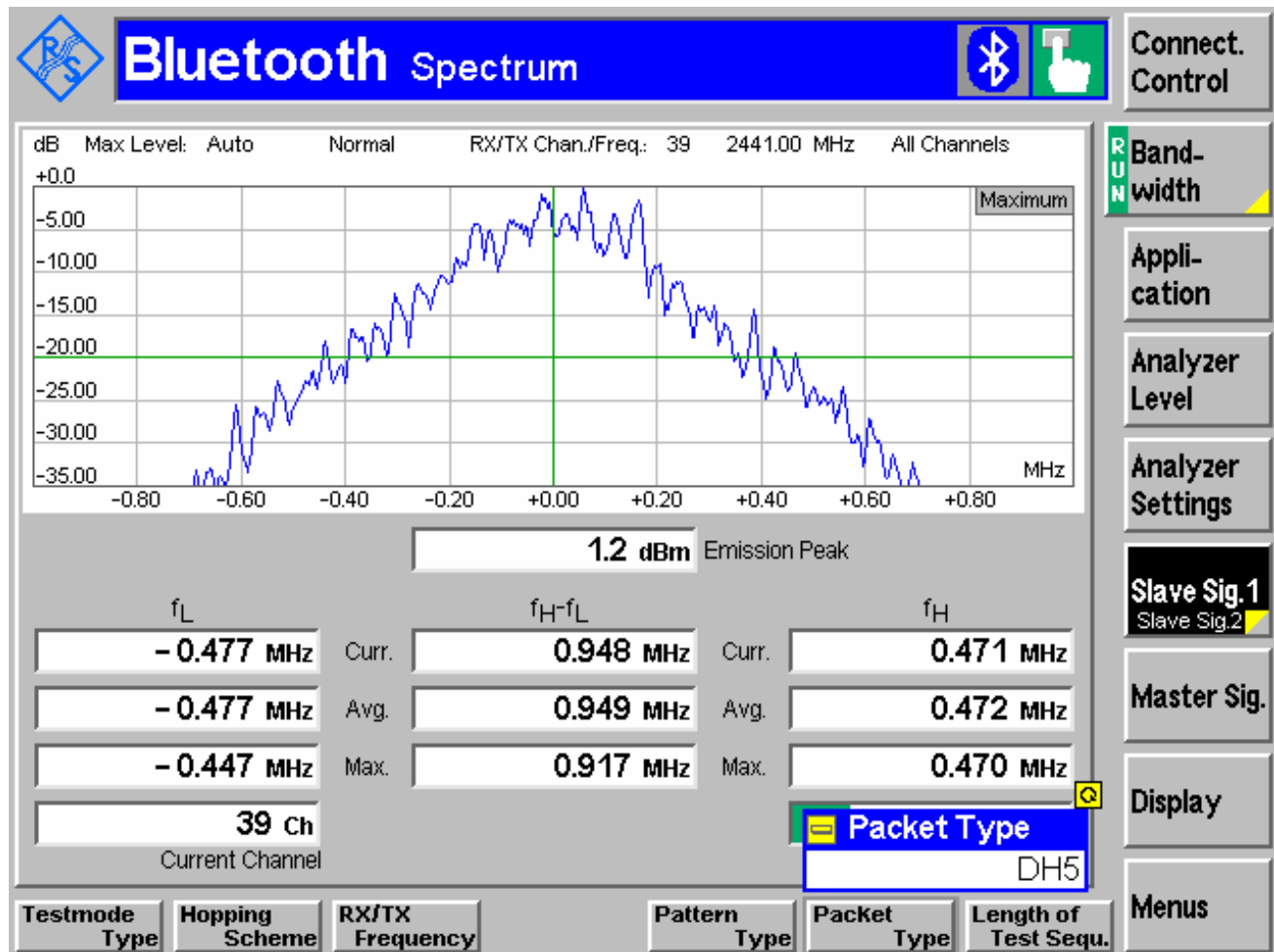



(2480 MHz) GFSK

Bluetooth Spectrum

Connect. Control

dB Max Level: Auto Normal RX/TX Chan./Freq: 78 2480.00 MHz All Channels

Maximum

1.0 dBm Emission Peak

f_L		$f_H - f_L$		f_H
-0.476 MHz	Curr.	0.949 MHz	Curr.	0.473 MHz
-0.476 MHz	Avg.	0.951 MHz	Avg.	0.474 MHz
-0.445 MHz	Max.	0.918 MHz	Max.	0.473 MHz

78 ch
Current Channel

Packet Type
DH5

Testmode Type

Hopping Scheme

RX/TX Frequency

Pattern Type

Packet Type

Length of Test Sequ.

RUN
 Bandwidth

Application

Analyzer Level

Analyzer Settings

Slave Sig. 1
Slave Sig. 2

Master Sig.

Display

Menus

(2402 MHz) $\pi / 4$ DQPSK

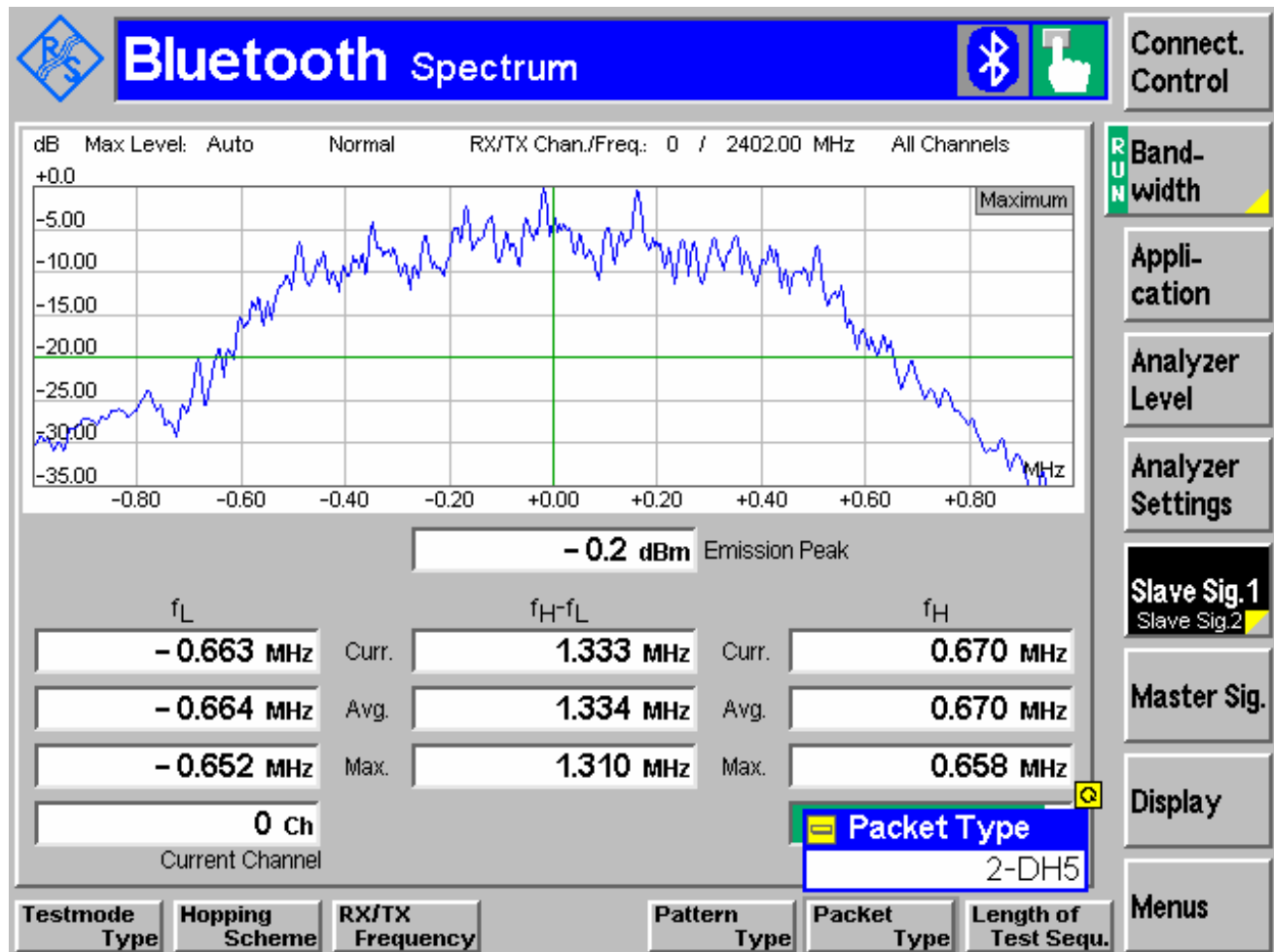

(2441 MHz) $\pi / 4$ DQPSK

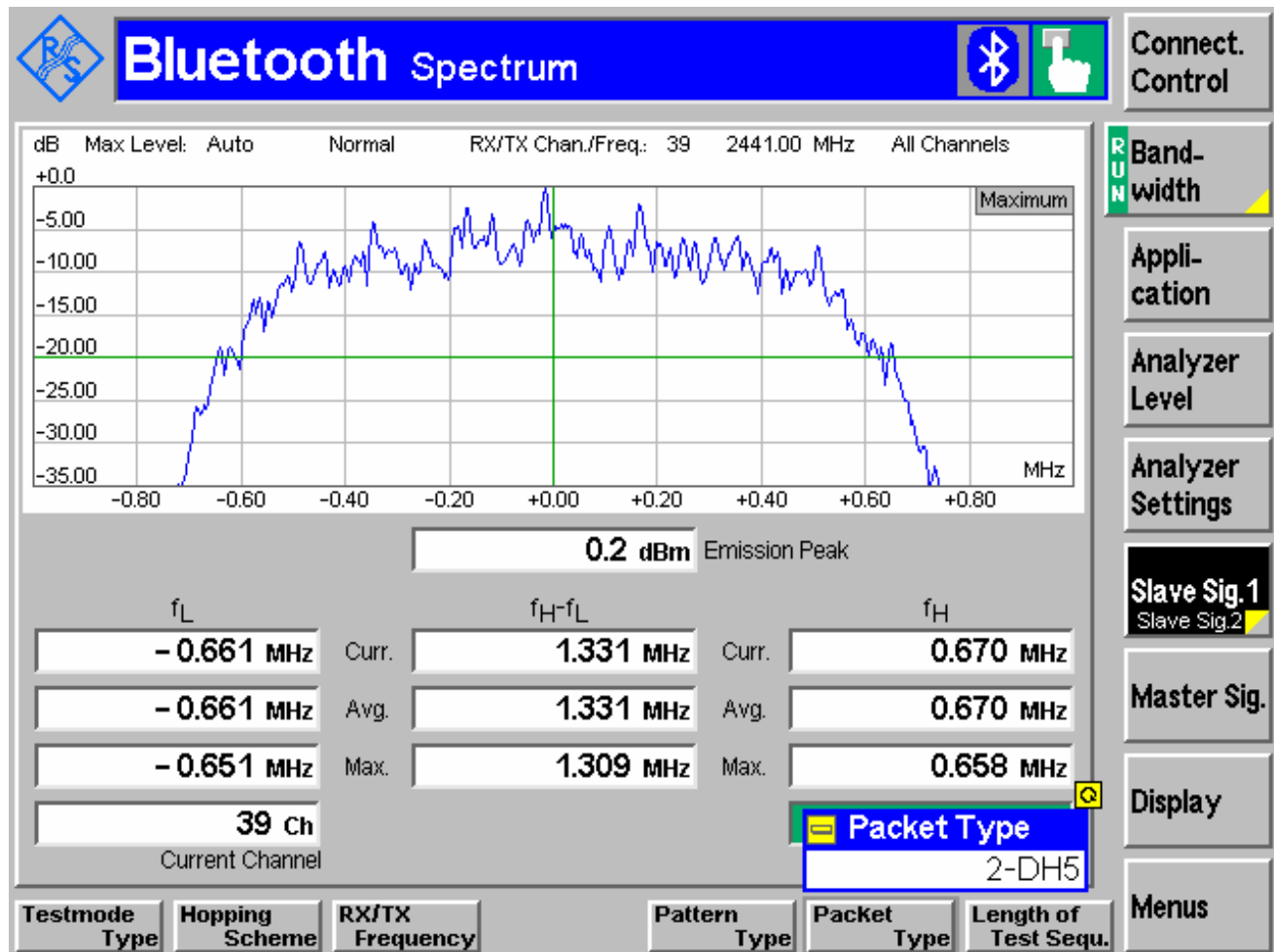



(2480 MHz) $\pi / 4$ DQPSK

Bluetooth Spectrum

Connect. Control

dB Max Level: Auto Normal RX/TX Chan./Freq: 78 2480.00 MHz All Channels

0.0 dBm Emission Peak

f_L		$f_H - f_L$		f_H
-0.659 MHz	Curr.	1.331 MHz	Curr.	0.672 MHz
-0.659 MHz	Avg.	1.331 MHz	Avg.	0.672 MHz
-0.648 MHz	Max.	1.308 MHz	Max.	0.660 MHz

78 ch
Current Channel

☰ Packet Type

2-DH5

Testmode Type

Hopping Scheme

RX/TX Frequency

Pattern Type

Packet Type

Length of Test Sequ.

Bandwidth

Application

Analyzer Level

Analyzer Settings

Slave Sig. 1
Slave Sig. 2

Master Sig.

Display

Menus



(2402 MHz) 8DPSK

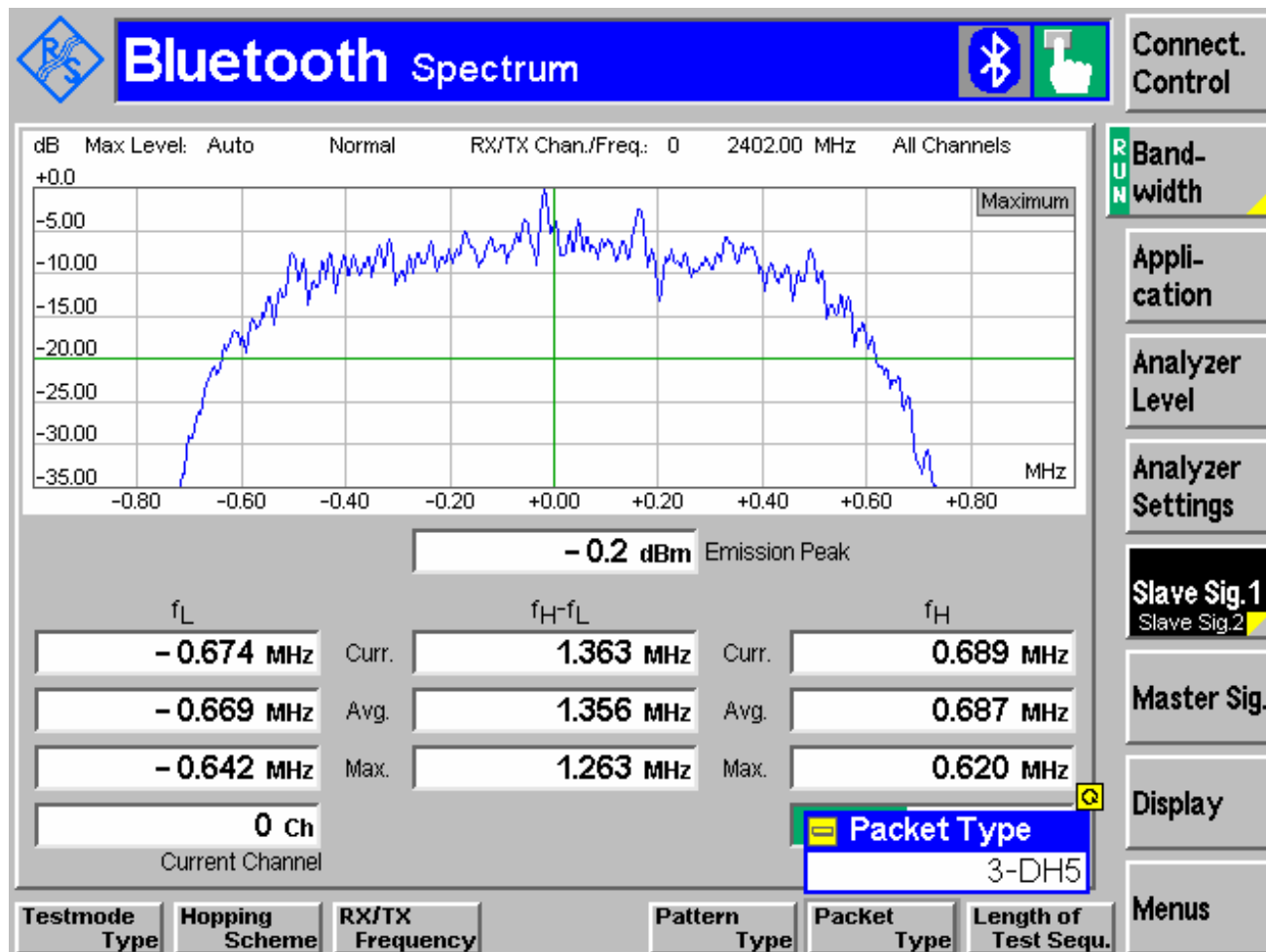



(2441 MHz) 8DPSK

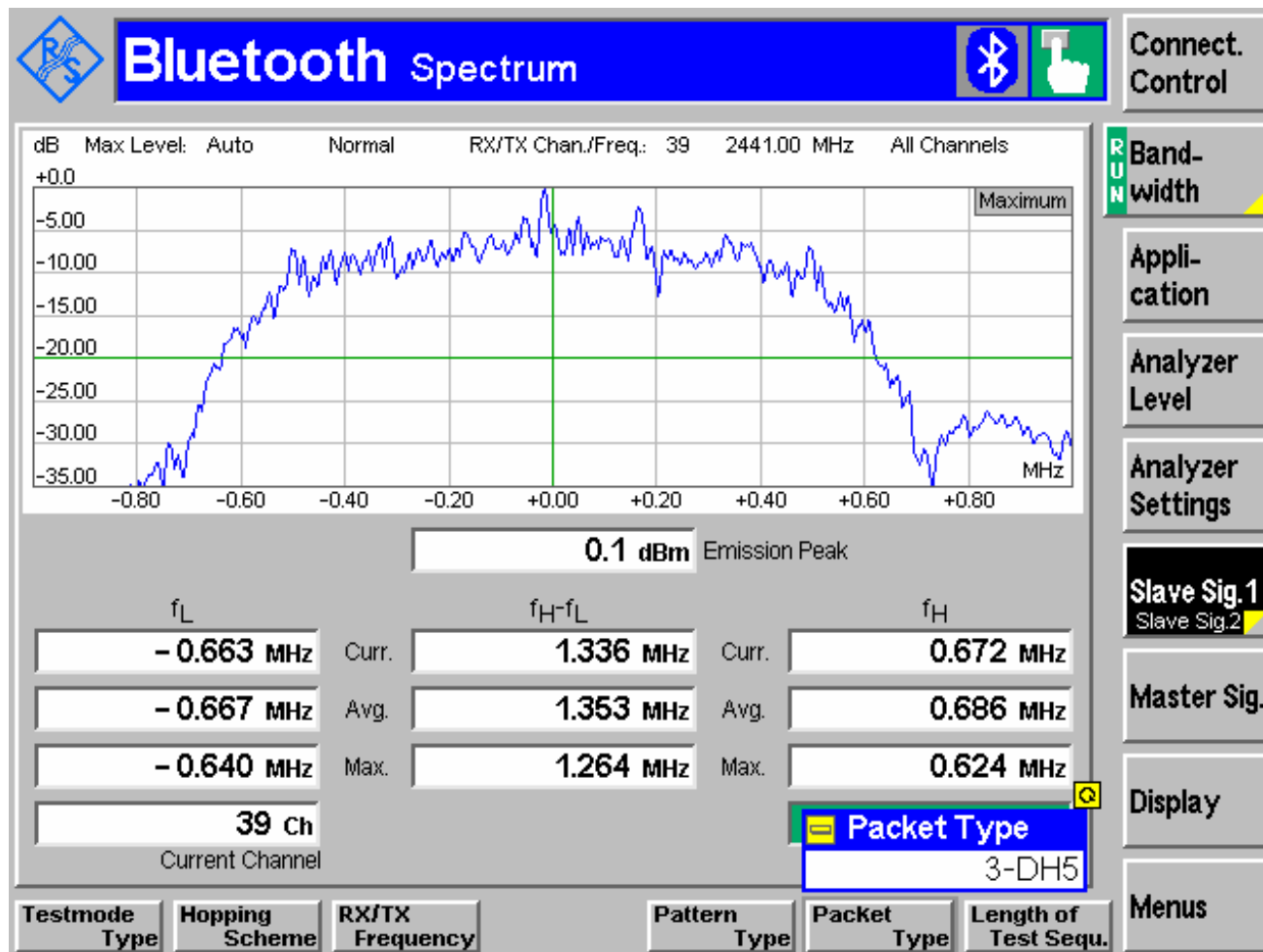

(2480 MHz) 8DPSK

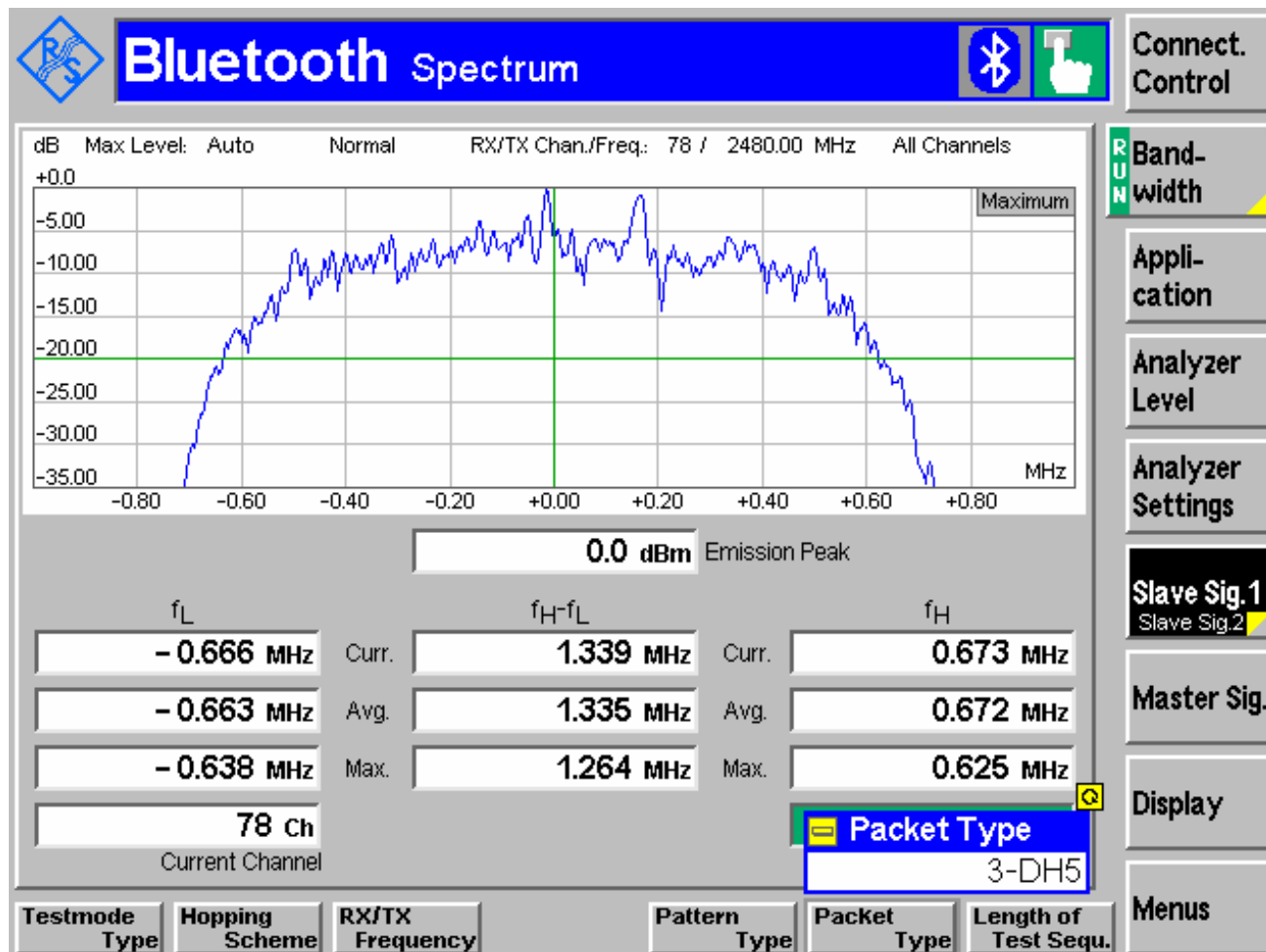



6.3 CARRIER FREQUENCY SEPARATION

6.3.1 LIMIT SUB CLAUSE § 15.247 (a) (1) (i) (ii) (iii)

SEPARATION
> 25 KHz or > 20 dB BANDWIDTH

6.3.2 RESULTS:

TEST CONDITIONS		SEPARATION(MHz)
T_{nom}(23)°C	V_{nom}VDC	1

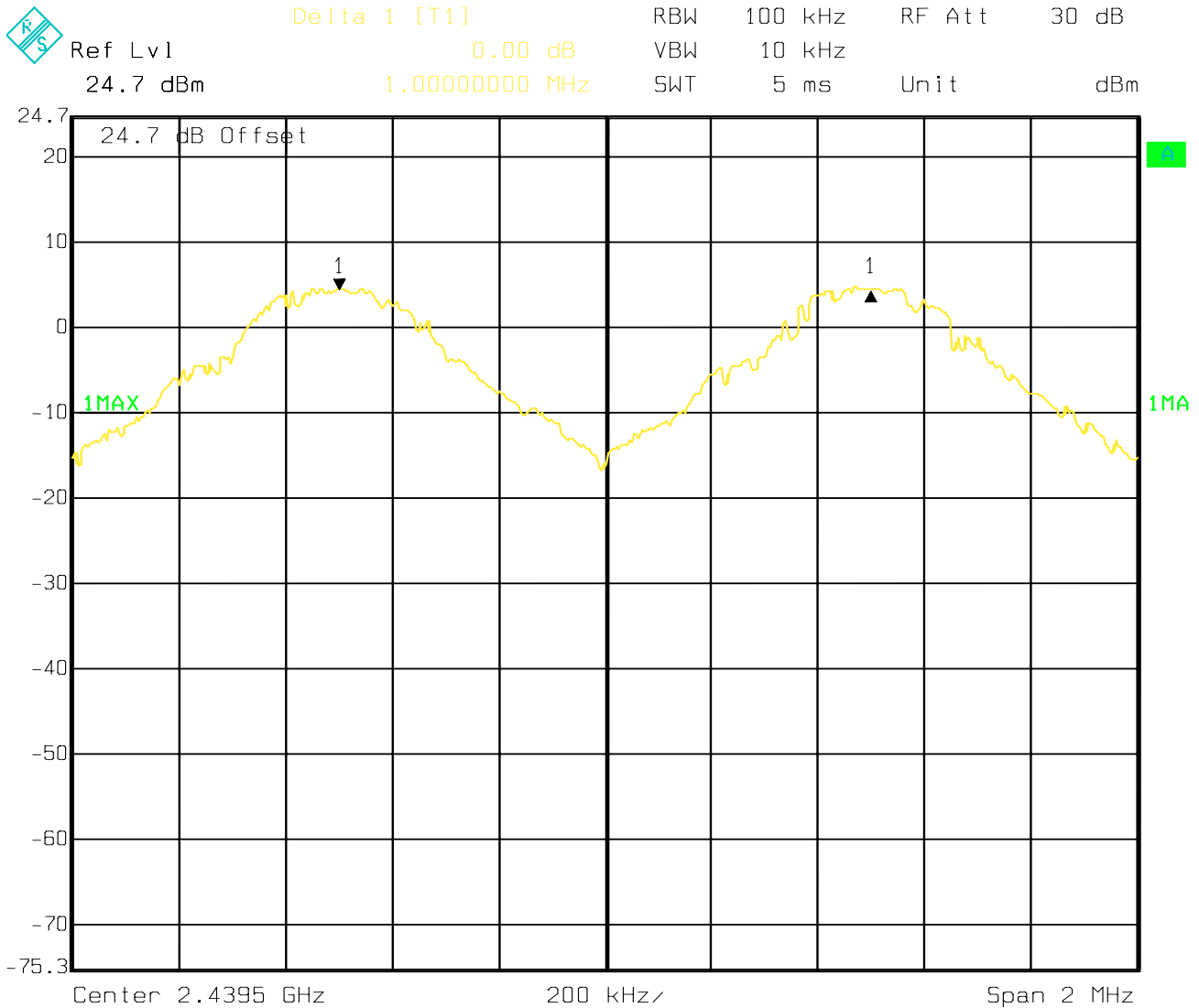



6.4 NUMBER OF HOPPING CHANNELS

6.4.1 LIMIT SUB CLAUSE § 15.247 (a) (1) (iii)

NUMBER OF CHANNELS
> 15

6.4.2 RESULTS:

TEST CONDITIONS		NUMBER OF CHANNELS
T_{nom}(23)°C	V_{nom}VDC	79



PLOT 1

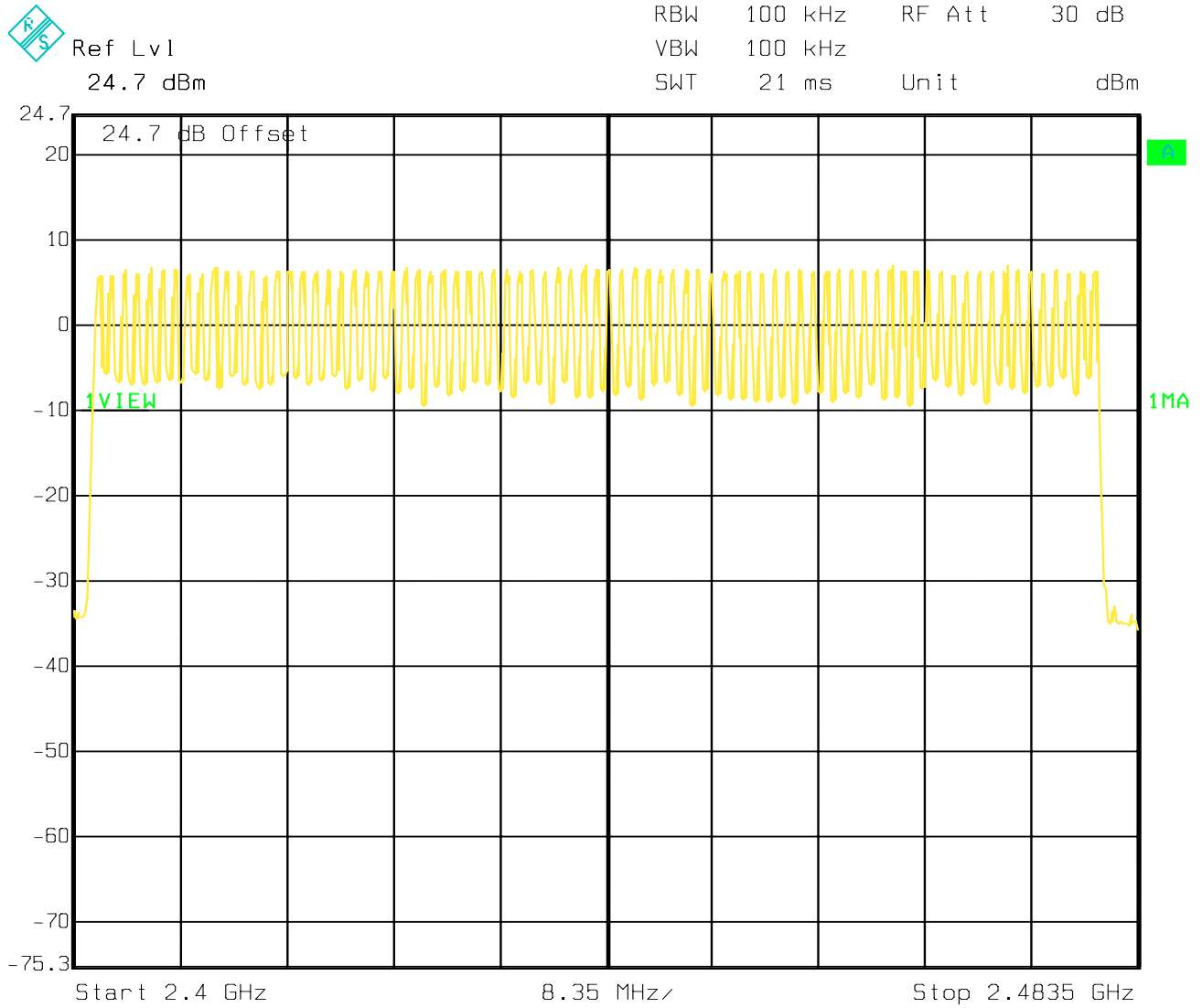

Date: 12.MAY 2009 08:52:12



6.5 TIME OF OCCUPANCY (DWELL TIME)

6.5.1 LIMIT SUB CLAUSE § 15.247 (a) (1) (i) (ii) (iii)

FREQUENCY RANGE	AVERAGE TIME OF OCCUPANCY PER 31.6 SECONDS (LIMIT)
2400-2483.5	< 0.4 Seconds

6.5.2 RESULTS:

$T_{nom}(23)^{\circ}C$	$V_{nom}VDC$
------------------------	--------------

For Bluetooth devices:

The dwell time of 0.4 s within a 31.6 second period in data mode is independent from the packet type (packet length). The calculation for a 31.6 second period is as follows:

Dwell time = time slot length * hop rate / number of hopping channels * 31.6 s

Example for a DH1 packet (with a maximum length of one time slot)

Dwell time = $625 \mu s * 1600 \text{ 1/s} / 79 * 31.6 \text{ s} = 0.4 \text{ s}$ (in a 31.6 s period)

For multi-slot packet the hopping is reduced according to the length of the packet.

Example for a DH5 packet (with a maximum length of five time slots)

Dwell time = $5 * 625 \mu s * 1600 * 1/5 * 1/s / 79 * 31.6 \text{ s} = 0.4 \text{ s}$ (in a 31.6 s period)

This is the same for all BT devices and therefore all BT devices satisfy FCC requirement on time of occupancy (dwell time).



6.6 CONDUCTED SPURIOUS EMISSION

6.6.1 LIMIT SUB CLAUSE § 15.247 (d)

FREQUENCY RANGE	limit
30M-25GHz	-20dBc

6.6.2 RESULTS: Tnom(23)°C VnomVDC

Plot shows worse case emission for all modulations on each channel.

(2402MHz)

 Marker 1 [T1] RBW 100 kHz RF Att 30 dB
 Ref Lvl -30.70 dBm VBW 300 kHz
 24.7 dBm 6.63529058 GHz SWT 6.4 s Unit dBm

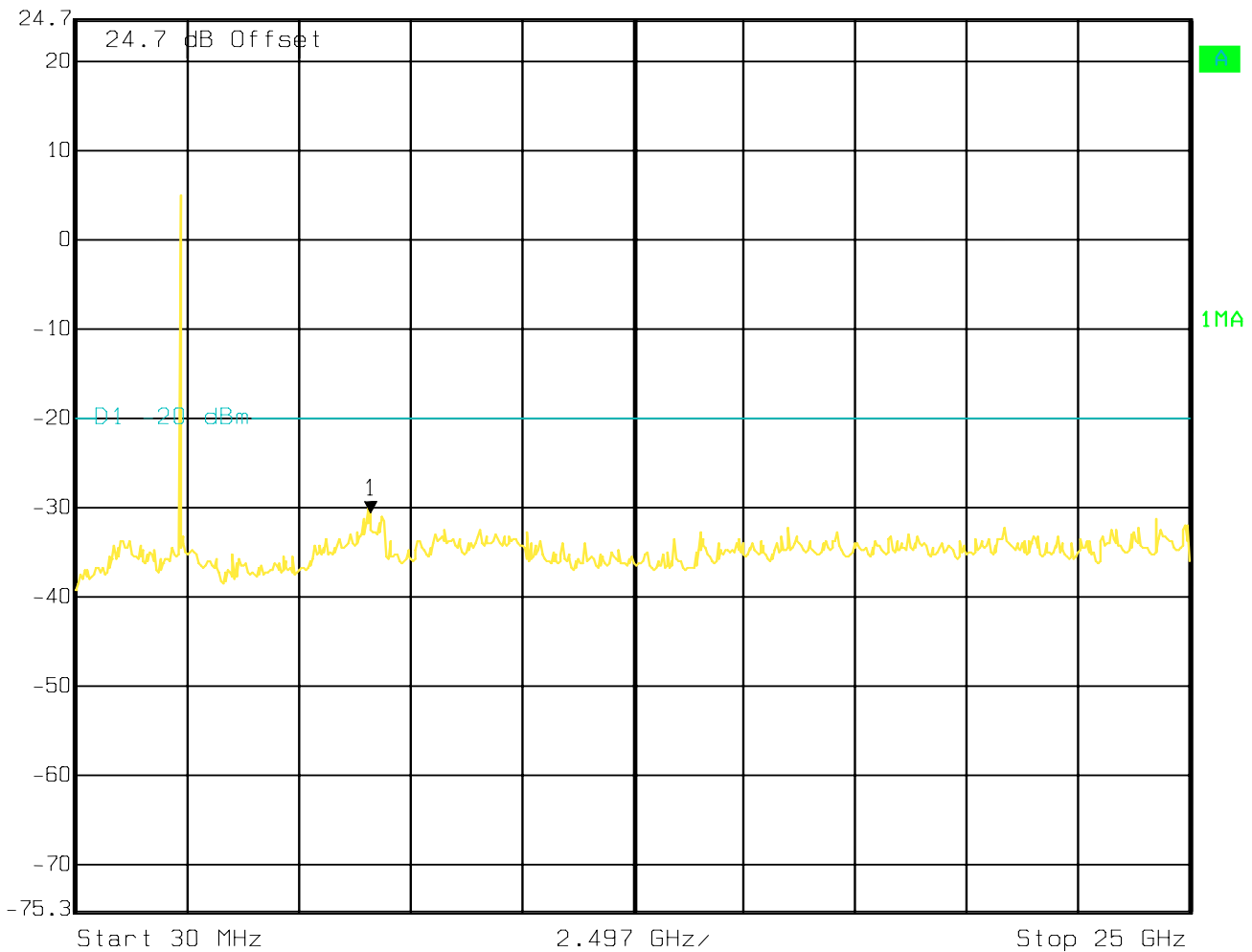

Date: 12.MAY 2009 09:03:17



(2441MHz)

RS
Marker 1 [T1]
RBW 100 kHz
RF Att 30 dB
Ref Lvl 24.7 dBm
-30.00 dBm
VBW 300 kHz
24.7 dBm
6.63529058 GHz
SWT 6.4 s
Unit dBm

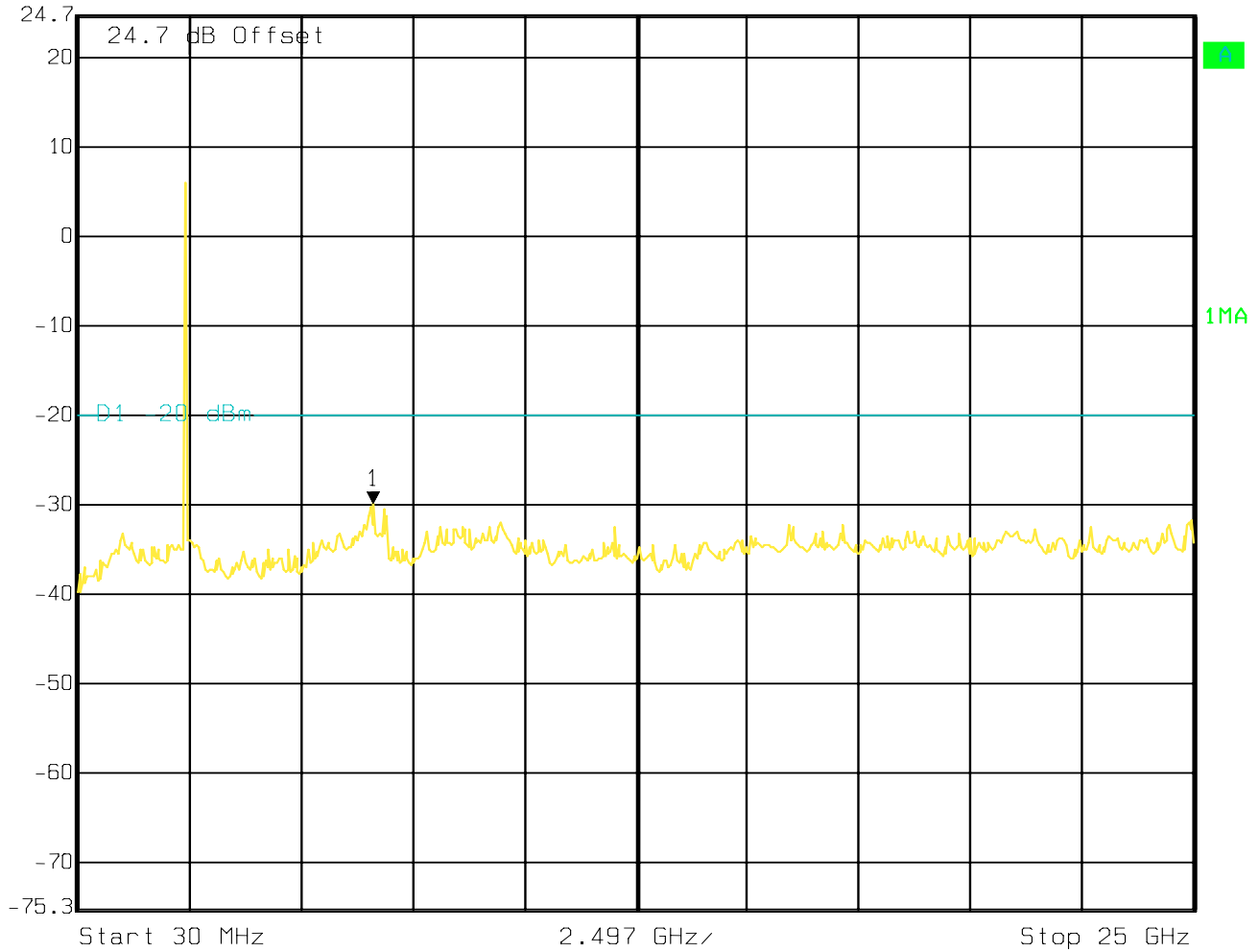

Date: 12.MAY 2009 09:02:41



(2480MHz)

 Marker 1 [T1] RBW 100 kHz RF Att 30 dB
Ref Lvl -31.29 dBm VBW 300 kHz
24.7 dBm 6.63529058 GHz SWT 6.4 s Unit dBm

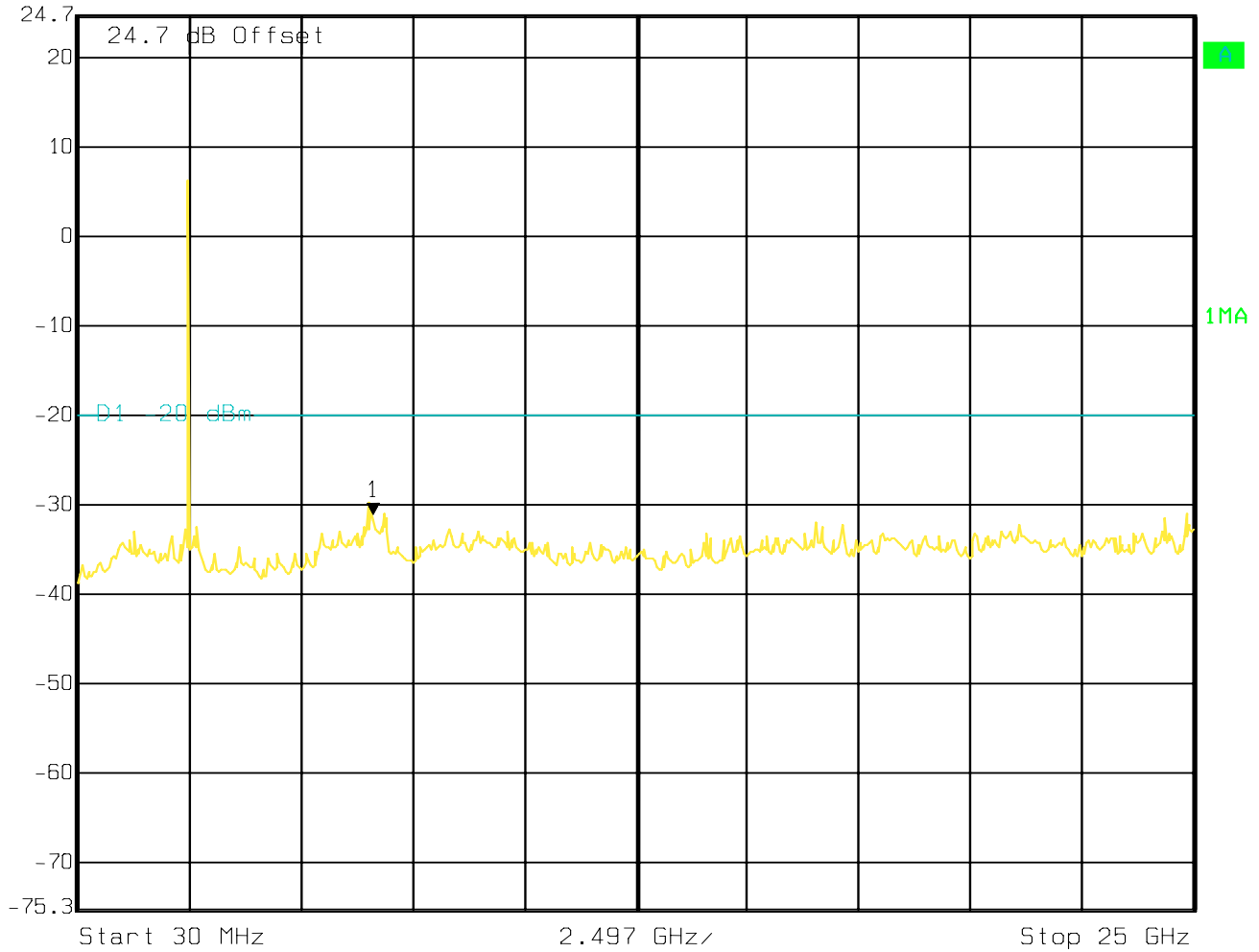

Date: 12.MAY 2009 09:02:03



7 TEST EQUIPMENT AND ANCILLARIES USED FOR TESTS

No	Instrument/Ancillary	Type	Manufacturer	Serial No.	Cal Due	Interval
01	Spectrum Analyzer	ESIB 40	Rohde & Schwarz	100107	May 2010	1 year
02	Spectrum Analyzer	FSEM 30	Rohde & Schwarz	100017	August 2010	1 year
03	Signal Generator	SMY02	Rohde & Schwarz	836878/011	May 2010	1 year
04	Power-Meter	NRVD	Rohde & Schwarz	0857.8008.02	May 2010	1 year
05	Biconilog Antenna	3141	EMCO	0005-1186	June 2010	1 year
06	Horn Antenna (1-18GHz)	SAS-200/571	AH Systems	325	June 2010	1 year
07	Horn Antenna (18-26.5GHz)	3160-09	EMCO	1240	June 2010	1 year
08	Power Splitter	11667B	Hewlett Packard	645348	n/a	n/a
09	Climatic Chamber	VT4004	Voltsch	G1115	May 2010	1 year
10	High Pass Filter	5HC2700	Trilithic Inc.	9926013	n/a	n/a
11	High Pass Filter	4HC1600	Trilithic Inc.	9922307	n/a	n/a
12	Pre-Amplifier	JS4-00102600	Miteq	00616	May 2010	1 year
13	Power Sensor	URV5-Z2	Rohde & Schwarz	DE30807	May 2010	1 year
14	Digital Radio Comm. Tester	CMD-55	Rohde & Schwarz	847958/008	May 2010	1 year
15	Universal Radio Comm. Tester	CMU 200	Rohde & Schwarz	832221/06	May 2010	1 year
16	LISN	ESH3-Z5	Rohde & Schwarz	836679/003	May 2010	1 year
17	Loop Antenna	6512	EMCO	00049838	July 2010	2 years

8 BLOCK DIAGRAMS

Conducted Testing

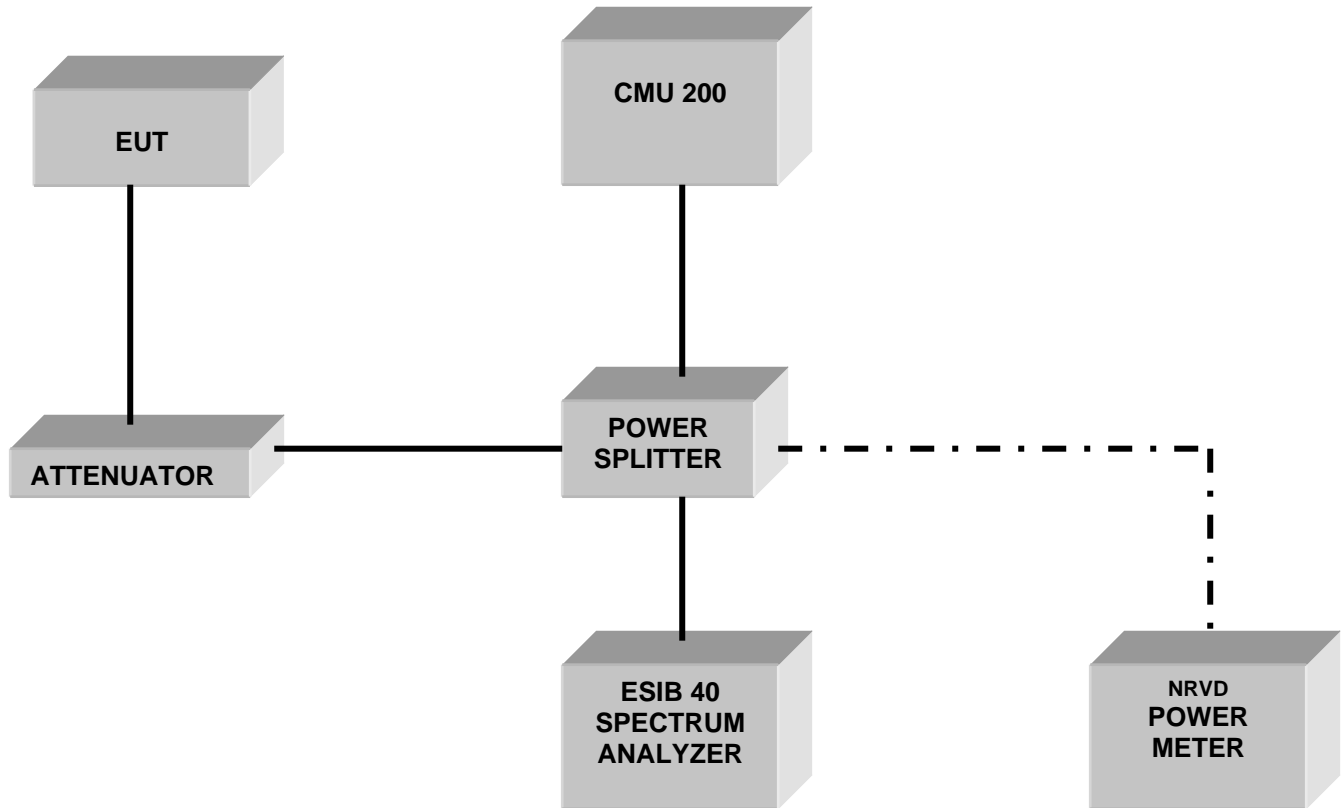

Radiated Testing

ANECHOIC CHAMBER

