



[Alt text: The Hello screen that appears when you first turn on your iPhone.]

Get started

Set up a few basic features before you start using your new iPhone.

[Setup basics](#)

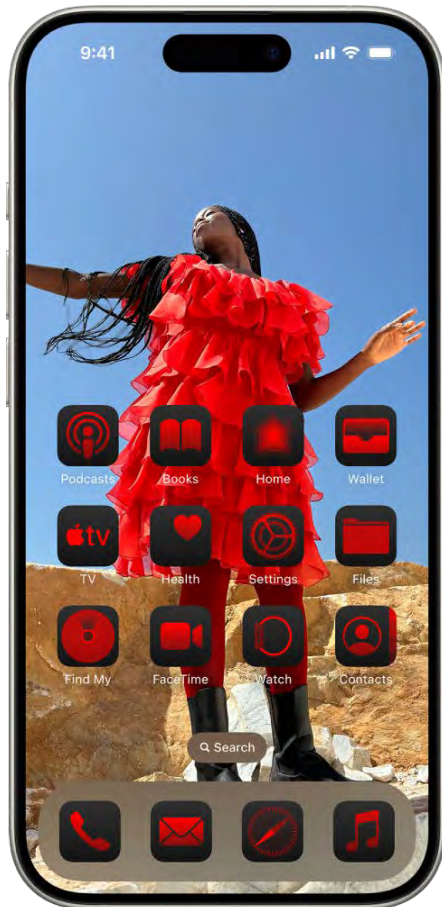

[Alt text: The iPhone Home Screen. Apps appear in the same color at the bottom of the screen, and compliment the color in the wallpaper photo.]

Add a personal touch

Your iPhone can reflect your personal style and preferences. Showcase your favorite photos on the Lock Screen, add widgets to the Home Screen, adjust text size, ringtones, and more.

[Make your iPhone your own](#)



[Alt text: The Camera screen in Photo mode, showing four people in the Camera frame.]

Take your best shot

Use your iPhone to capture the moment, wherever you are. Learn how to take photos and videos on the fly, and use other camera features on your iPhone.

[Take great photos and videos](#)



[Alt text: A FaceTime call.]

Stay connected

iPhone makes it easy to reach the people important to you. Add them to your contacts so you have their information everywhere you need it—then catch up with text messages, phone calls, or FaceTime.

[Keep in touch with friends and family](#)



[Alt text: The Family Sharing screen in Settings. Five family members are listed. Below their names are the Family Checklist and below that are the Subscriptions and Purchase Sharing options.]

All in the family

You and your family members can use Family Sharing to share eligible app purchases, your location, and even health data. You can also set up parental controls to manage how children spend time on their devices.

[Share features with your family](#)

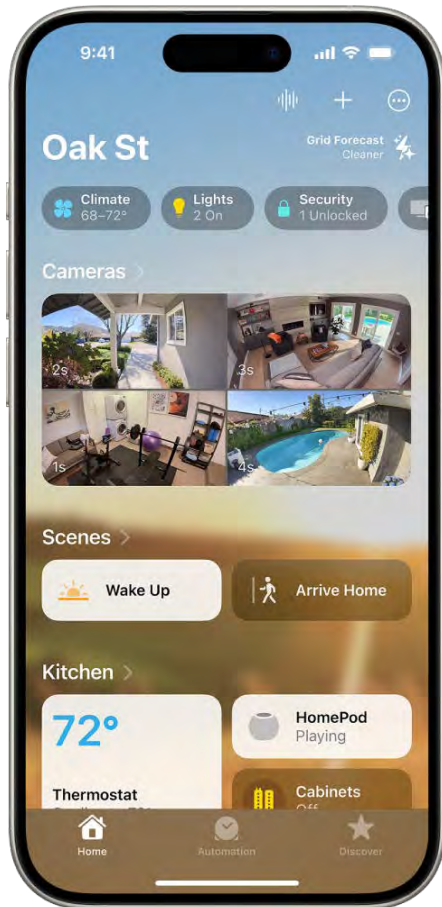

[Alt text: The My Home screen in the Home app.]

Simplify your day

Learn how to use the apps on your iPhone to direct you to the places you go most often, pay for your morning coffee, remind you of important tasks, and even lock your front door automatically when you leave home.

[Use iPhone for your daily routines](#)



[Alt text: An iPhone screen showing the battery charged 100%.]

Pro tips

Check out these tips from Apple Support advisors to keep your iPhone, and the information you keep on it, safe and secure.

[Expert advice from Apple Support](#)

To explore the iPhone User Guide, click Table of Contents at the top of the page, or enter a word or phrase in the search field.

Setup basics

Setup basics

iPhone has an easy setup process to help you get going when you first turn on your device. Whether you're just getting started or want to make sure you have the basics set up, you're in the right place.

Metadata

Summary: There are just a few quick things you should set up before you start using your iPhone.

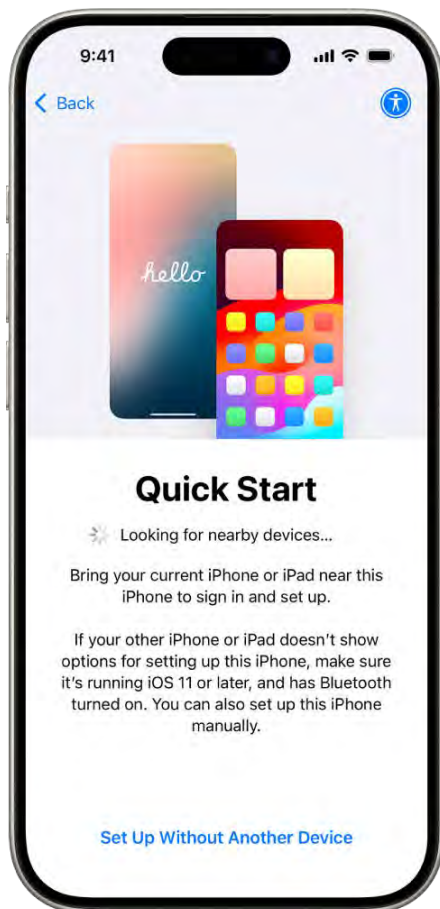

[Alt text: The setup screen, with options to transfer your apps and data from an iCloud backup, another iPhone, a Mac or PC, an Android device, or not to transfer anything.]

Transfer your apps and info onto your new iPhone

When you first turn on your iPhone and begin the setup process, you can wirelessly transfer many of your apps, settings, and content from your previous iPhone directly to your new iPhone—just bring the two devices close together, then follow the onscreen instructions.



[Alt text: The Wi-Fi options screen in Settings. Wi-Fi is turned on, and a network is selected.]

Set up cellular service and connect to Wi-Fi

Depending on your model, use an eSIM from your carrier or install a physical SIM card to connect to your cellular network. To check if your iPhone is connected to your cellular plan, go to Settings  [ALT N/A] > Cellular.



To connect your iPhone to your home Wi-Fi network, go to Settings  [ALT N/A] > Wi-Fi, turn on Wi-Fi, then choose your network. iPhone automatically connects to your Wi-Fi network whenever you're home.



[Alt text: The Apple Account sign-in screen.]

Sign in to your Apple Account

You use your Apple Account to access Apple services such as the App Store, the iTunes Store, Apple Books, Apple Music, FaceTime, iCloud, iMessage, and more.

To sign in to your Apple Account, go to Settings  [ALT N/A] > Sign in to your iPhone. If you have an iPad (with iPadOS 17 or later) or another iPhone (with iOS 17 or later), you can simply bring your iPhone near your other device. Otherwise, you can manually sign in. To verify that you're signed in, go to Settings  [ALT N/A] > [your name]; your Apple Account appears below your name.

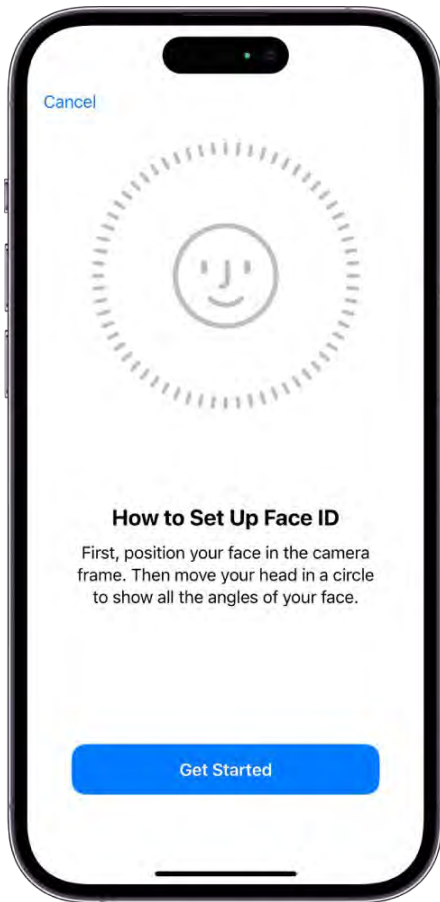



[Alt text: The Face ID recognition setup screen. A face is shown on the screen, enclosed in a circle. Text below the face instructs the user to move their head slowly to complete the circle.]

Set up Face ID or Touch ID

You can use Face ID (face recognition) or Touch ID (your fingerprint) to securely unlock your iPhone, sign in to many apps, and make purchases. For your security, Face ID and Touch ID data doesn't leave your device and isn't saved anywhere else.

Depending on your iPhone model, do one of the following:

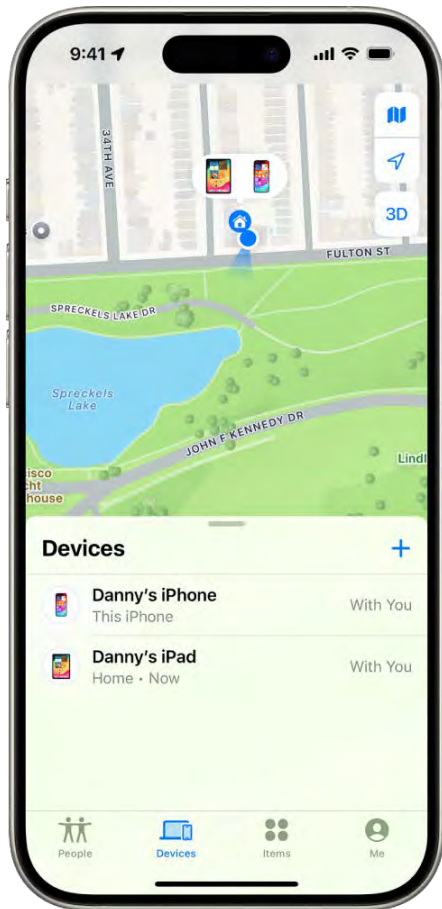

- *Set up Face ID:* Go to Settings  [ALT N/A] > Face ID & Passcode, tap Set up Face ID, then follow the onscreen instructions.
- *Set up Touch ID:* Go to Settings  [ALT N/A] > Touch ID & Passcode, tap Add a Fingerprint, then follow the onscreen instructions.



[Alt text: The Find My screen showing two devices at home.]

Turn on Find My iPhone

You can locate your iPhone if it's ever lost or stolen.

Go to Settings  [ALT N/A] > [your name] > Find My, tap Find My iPhone, then turn on Find My iPhone. You can see the location of your devices in the Find My app  [ALT N/A]. If you lose your iPhone and don't have access to the Find My app, you can locate your device using Find My on iCloud.com.



[Alt text: The iCloud settings screen showing the iCloud storage meter and a list of apps and features, including Photos, iCloud Drive, and iCloud Mail that can be used with iCloud.]

Store your data in iCloud

iCloud helps you keep your important info safe and in sync across your devices. If you replace or lose your iPhone, or it's damaged or stolen, your photos, videos, and more remain secure in iCloud.

To turn on or change the features you want to use with iCloud, go to Settings  [ALT N/A] > [your name] > iCloud.

Want to learn more?

- [Turn on and set up iPhone](#)
- [Set up cellular service](#)
- [Connect iPhone to the internet](#)
- [Set up Face ID on iPhone](#)
- [Locate a device in Find My](#)

- [Use iCloud on iPhone](#)

Not all features are available for all iPhone models.

Make your iPhone your own

Make your iPhone your own

You can tailor your iPhone to your own interests and preferences. Personalize your Lock Screen, customize the appearance of apps on your Home Screen, keep your favorite features like magnifier and remote handy, change the sounds and vibrations for calls and messages, and more.

Metadata

Summary: Tailor your iPhone to your interests and needs.



[Alt text: A customized Home Screen with icons tinted gold and arranged around the top and right side of the photo.]

Customize apps on your Home Screen

You can tint the apps on your Home Screen your favorite color or give them a sleek dark look. You can also change the size of apps and move them anywhere on the screen—along the bottom for quicker reach, or off to the side to frame a favorite wallpaper.

To change the color and the appearance of your apps, touch and hold the background on any Home Screen page until the apps jiggle. Tap Edit, tap Customize, then choose from the different appearance options.

To move apps, touch and hold the Home Screen background until the apps jiggle, then drag an app to a new location on the current page, a different page, or to a new page.



[Alt text: The iPhone Lock Screen showing controls to change the font and color of the time.]

Personalize your Lock Screen

You can showcase a favorite photo, add widgets, and change the font and style of the date and time. You can also swap out the controls at the bottom of the Lock Screen for other options—like a timer for when you're cooking or the Translate app for when you travel.

To get started, touch and hold the Lock Screen, then tap  [Alt text: the Add New button] at the bottom of the screen. Browse the gallery of Wallpaper options, then tap one to customize its appearance. When you've created a Lock Screen that you like, tap Add, then tap Set as Wallpaper Pair.



[Alt text: The iPhone Control Center.]

Set your favorite controls

Many iPhone features—like timer and flashlight—are just a swipe away in Control Center. To quickly open Control Center on an iPhone with Face ID, swipe down from the top-right edge; on an iPhone with a Home button, swipe up from the bottom of the screen.

To customize the controls, open Control Center, then touch and hold the background of the screen. Tap Add a Control at the bottom of the screen, then swipe up to view the controls gallery. When you see a control you want to add, tap it.



[Alt text: Weather, Reminders, and Home widgets on the iPhone Home Screen. The Reminders and Home widgets display interactive features.]

Add widgets to your Home Screen

Widgets let you easily see the information that's most important to you, like the current weather and upcoming calendar events. You can also complete tasks—for example, check off an item in your Reminders to-do list, or play a song in Music.

To add a widget, touch and hold the background on any Home Screen page until the apps jiggle, tap Edit, then tap Add Widget.

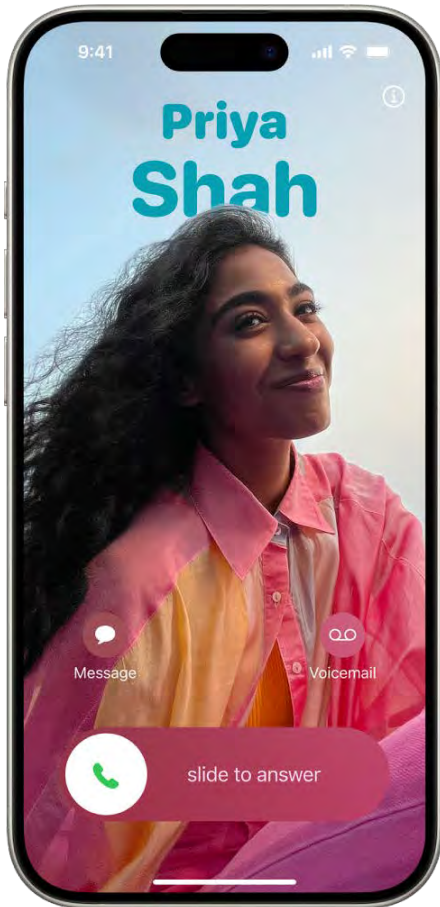

[Alt text: The iPhone call screen with a unique Contact Poster.

Customize your phone calls

Create your own unique call poster to personalize what people see when you call them. Choose your favorite photo or emoji, pair it with your preferred font, then add colors to make it pop. When you make a phone call, your call poster appears on the screen of the person you're calling.

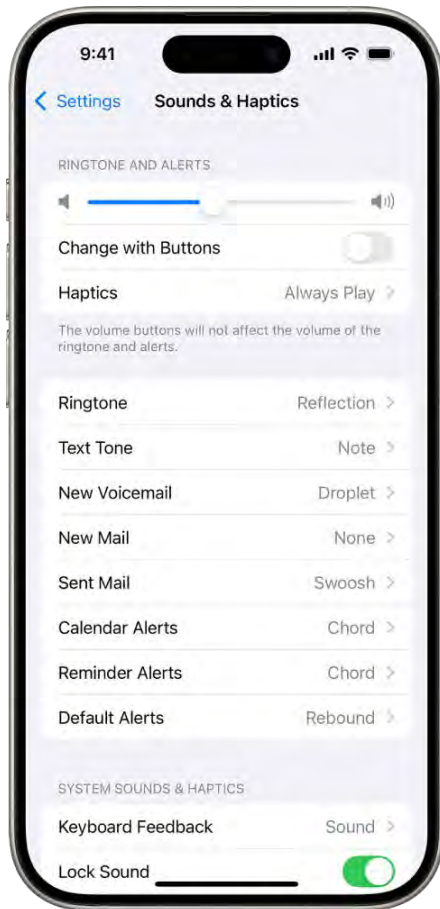

To get started, open the Contacts app  [ALT N/A] , tap your name, then tap Contact Photo & Poster.



[Alt text: The Sounds and Haptics screen in Settings. The onscreen options from top to bottom are Headphone Audio and Headphone Safety, Ringtone and Alert Volume with a slider to adjust the volume and the option to change the volume with buttons, and Sounds and Haptic Patterns including Ringtone and Text Tone.]

Choose sounds and vibrations

iPhone can play different sounds and vibrations for phone calls, text messages, calendar alerts, and other notifications.

Go to Settings  [ALT N/A] > Sounds & Haptics. You can also change the sounds iPhone plays for certain people; in the Contacts app  [ALT N/A], tap a person's name, tap Edit, then tap Ringtone or Text Tone.

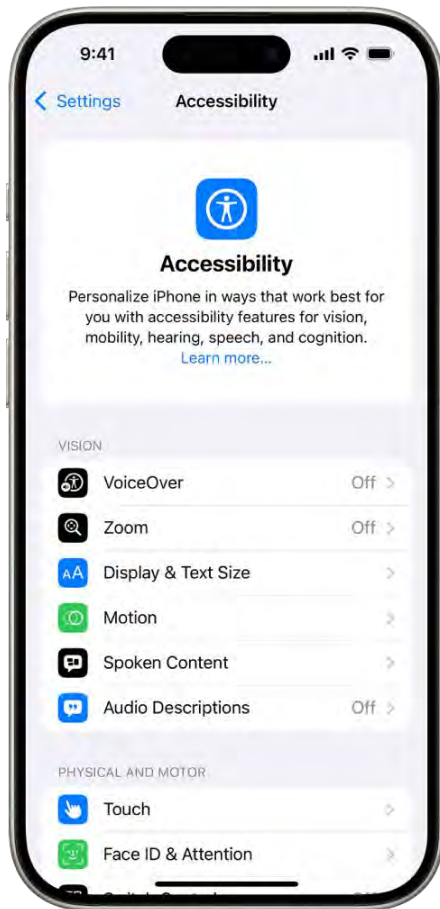

[Alt text: The Accessibility screen in Settings showing the following built-in features, from top to bottom: Vision features including VoiceOver, Zoom, Display and Text Size, Motion, Spoken Content, Audio Descriptions, and Physical and Motor features including Touch and Face ID and Attention.]

Use built-in accessibility features

iPhone provides many accessibility features to support your vision, mobility, hearing, speech, and cognitive needs. Change text size, make it easier to use the touchscreen, control your iPhone with just your voice, and more.

To customize these settings, go to Settings  [ALT N/A] > Accessibility.



[Alt text: The Privacy & Security screen in Settings.]

Check your privacy settings

iPhone is designed to protect your privacy and information. You can grant or deny apps permission to track your activity across other companies' apps and websites. To deny requests from apps to track your activity, go to Settings  [ALT N/A] > Privacy & Security, tap Tracking, then turn off Allow Apps to Request to Track.

Want to learn more?

- [Customize apps and widgets on the iPhone Home Screen](#)
- [Create a custom iPhone Lock Screen](#)
- [Use and customize Control Center on iPhone](#)
- [Add, edit, and remove widgets on iPhone](#)
- [Get started with accessibility features on iPhone](#)
- [Control what you share on iPhone](#)

Not all features are available for all iPhone models.

Keep in touch with friends and family

Keep in touch with friends and family

iPhone makes it easy to reach the people important to you—so you can catch up with phone or video calls and quickly text your group of friends.

Metadata

Summary: Use iPhone to keep in touch with friends and family.



[Alt text: A contact card in the Contacts app.]

A smarter address book

Enter phone numbers, email addresses, birthdays, and more in the Contacts app  [ALT N/A] once, and you have them everywhere you need them—from Messages to FaceTime to Mail. You can also add contact information from another account (like Google or Yahoo).

Go to Settings  [ALT N/A] > Apps > Contacts > Contacts Accounts, then tap Add Account.

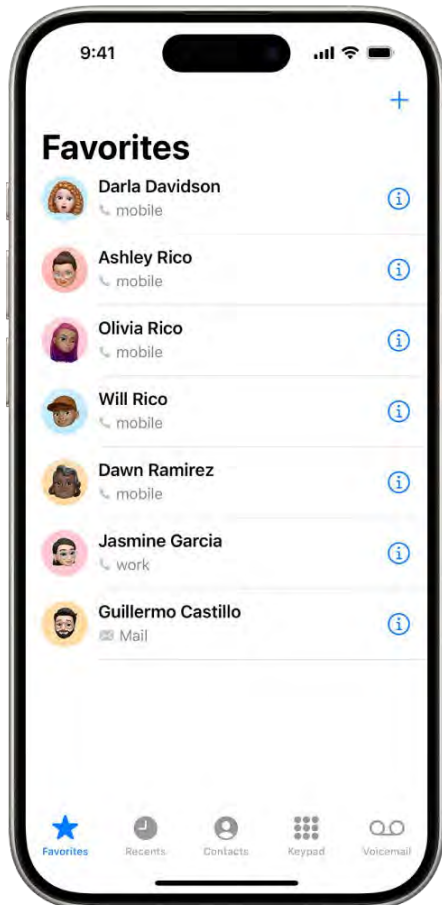

[Alt text: The Favorites screen in the Contacts app; six contacts are listed as favorites.]

Choose your favorites

Add the people you talk to frequently to your Favorites list in the Phone app  [ALT N/A] to make them easier to reach.

In the Phone app, tap Favorites, tap  [Alt text: the Add button], then choose a contact. To call a Favorite, just tap their name.

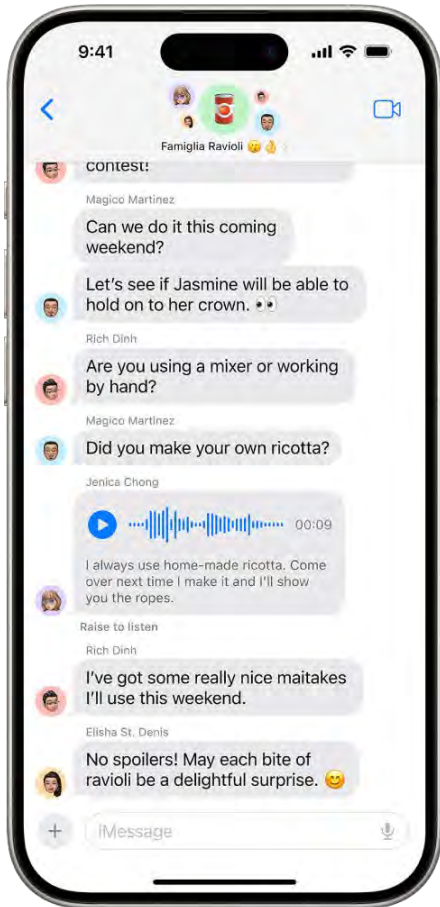

[Alt text: A group conversation in the Messages app.]

Start a group conversation

You can send messages to a group of people you want to talk to all at the same time, like members of your family.



In the Messages app  [ALT N/A], tap  [Alt text: the Compose button], type the names of the people you want to send a message to, then send the first message.



[Alt text: A FaceTime call.]

Make a video call

You can use FaceTime to make video calls with your friends and family.

In the FaceTime app  [ALT N/A] , tap New FaceTime near the top of the screen, type the name of the person you want to call, then tap  [Alt text: the FaceTime button] . During the call, you can tap the screen to show the FaceTime controls (in case you want to mute yourself, for example).



[Alt text: A Group FaceTime call with five participants; each participant appears in a separate tile.]

Add people to a FaceTime call

You can add more people to a FaceTime call—friends and family can join at any time. Tap the screen to show the controls, tap ⓘ [Alt text: the Info button], then tap Add People.

Want to learn more?

- [Add and use contact information on iPhone](#)
- [Use Contacts from the Phone app on iPhone](#)
- [Have a group conversation in Messages on iPhone](#)
- [Make FaceTime calls on iPhone](#)

- P9

[Make a Group FaceTime call on iPhone](#)

Not all features are available in all countries or regions.

Features for your family

Share features with your family

There are special features you and your family can use to share purchases, stay connected, and protect your data. If you have children, you can also set up parental controls to manage how your children use their Apple devices.

Metadata

Summary: Use iPhone to help you and your family can use to share purchases, stay connected, and protect your data.



[Alt text: The Family Sharing screen in Settings. Five family members are listed. Below their names are the Family Checklist and below that are the Subscriptions and Purchase Sharing options.]

Set up Family Sharing

With Family Sharing, you and your family members can share eligible purchases and subscriptions, your location, and more. Everyone uses their own device and Apple Account, but iCloud storage, subscriptions (to services like Apple Music and Apple Arcade), and other content is shared.

To get started, go to Settings  [ALT N/A] > [your name] > Family.



[Alt text: The Find My screen showing the People list and their locations on a map.]

Share your location with Find My

When you set up Family Sharing, you can share your location with members of your family and help them find lost devices with the Find My app  [ALT N/A] .

To share your location with family members, go to Settings  [ALT N/A] > [your name] > Family, then scroll down and tap Location. Tap the name of a family member you want to share your location with. After you share your location with members of your Family Sharing group, they can help locate a missing device.

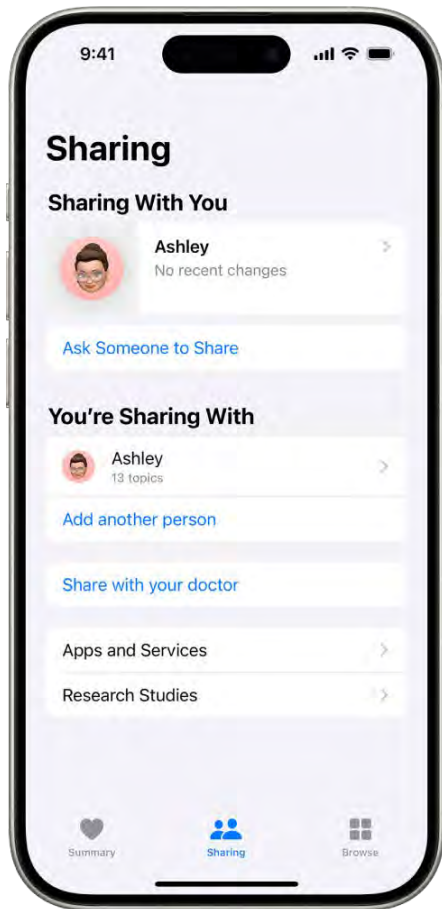

[Alt text: The Sharing screen in the Health app.]

Share your health data

You can use the Health app  [ALT N/A] to share your health data—such as your activity, mobility, and health trends—with family members.

In the Health app, tap Sharing at the bottom of the screen, then tap Share with Someone. You can choose what you want to share, and if you want the people you're sharing with to be notified about significant trends, like a steep decline in activity.



[Alt text: A photo is open in the Photos app. At the top-right of the screen, the Pop up button is selected and there's an option to move the photo into the shared library.]

Start a family photo library

You can use iCloud Shared Photo Library to share photos and videos with up to five other family members. Everyone can add, edit, and caption photos, and enjoy the shared photos in their memories, featured photos, and Photos widget.

To get started, go to Settings  [ALT N/A] > [your name] > iCloud > Photos, turn on Sync this iPhone, then tap Shared Library.

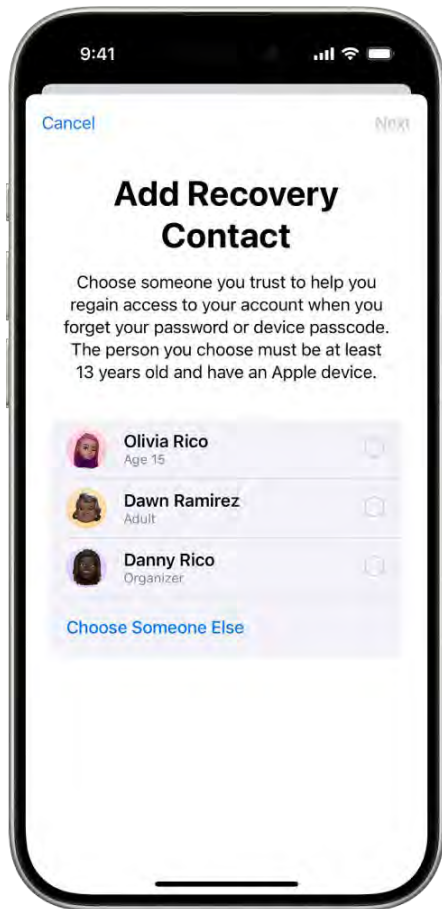

[Alt text: The Add Recovery Contact screen showing suggested contacts to select as a recovery contact, and the option to choose someone else.]

Just in case

You can add family members and other trusted people as Account Recovery Contacts to help you regain access to your account if you ever get locked out. The Digital Legacy program allows you to designate people as Legacy Contacts so they can access your account and personal information in the event of your death.

To add people, go to Settings  [ALT N/A] > [your name] > Sign-In & Security, then choose Account Recovery or Legacy Contact.

Want to learn more?

- [Set up Family Sharing on iPhone](#)
- [Share locations with family members and locate their lost devices on iPhone](#)
- [Share your data in Health on iPhone](#)
- [Set up or join an iCloud Shared Photo Library](#)
- [Keep your Apple Account secure on iPhone](#)

Not all features are available in all countries or regions.

Use iPhone for your daily routines

Use iPhone for your daily routines

While you're going about your day, you can use the apps on your iPhone to get directions, make purchases, and control accessories in your home. You can also silence notifications while you're driving or working, or allow only specific notifications related to what you're focused on.

Metadata

Summary: Use iPhone features to help you complete your daily routines.



[Alt text: iPhone turned horizontally. The left side of the screen display a clock and the right side of the screen displays the date.]

Start the day with the info you need

While iPhone is charging, you can put it in StandBy to view useful and timely information at a glance. With StandBy, you can use your iPhone as a bedside clock that displays the time, temperature, and other information you might want to see when you wake up in the morning, or before you go to bed.

To use StandBy, connect iPhone to a charger, stand it on its side (in landscape orientation), then tap the screen.

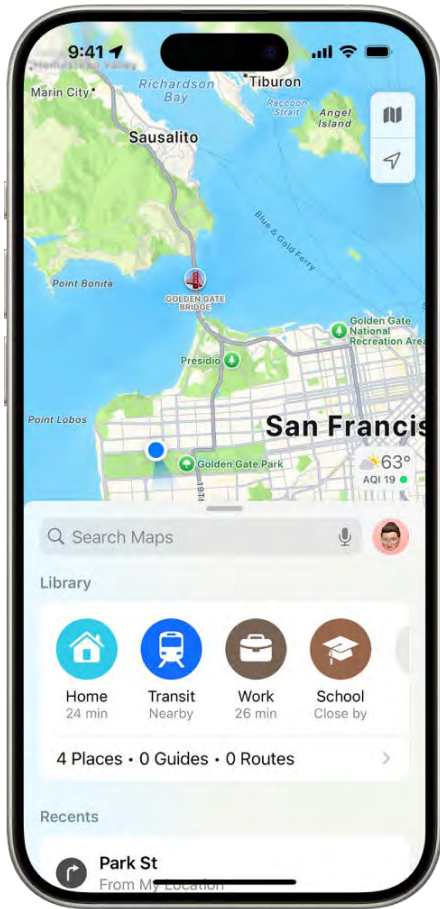

[Alt text: The Maps screen showing the search field in the lower half of the screen. Below the search field are the following locations saved as Favorites: Home, Work, Transit, and School.]

Get directions to your favorite places

Whether you're walking, driving, or biking, you can use the Maps app  [ALT N/A] to get directions to places you visit frequently, like your home or your favorite café, without entering the address every time.

In the Maps app, tap  [Alt text: the Add button] in the row of Favorites, then add a location.



[Alt text: The Wallet screen, showing multiple cards and passes.]

Set up a virtual wallet

Keep your credit cards, transit passes, vaccination cards, and more in the Wallet app  [ALT N/A] on your iPhone. When you add a credit or debit card to Wallet, you can use it to make secure payments in stores and online, and send and receive money from friends and family.

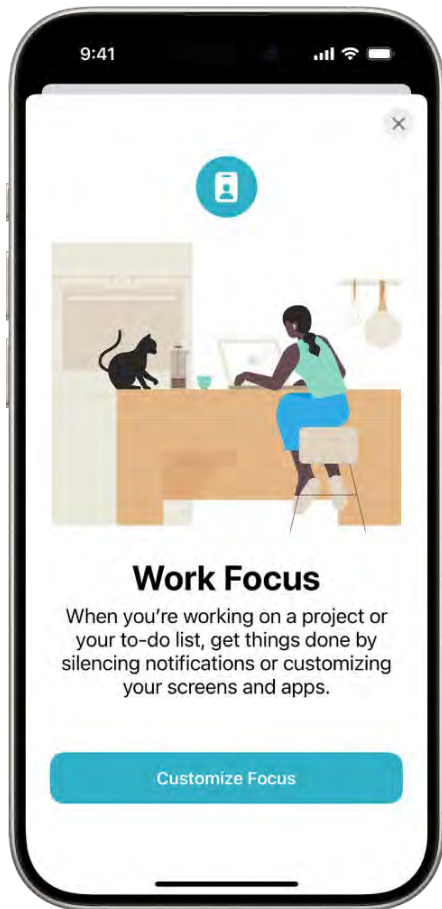

To add your first card, open the Wallet app, tap  [Alt text: the Add Card button] , then follow the onscreen instructions.



[Alt text: A screen showing four provided Focus options—Do Not Disturb, Personal, Sleep, and Work. The Share Across Devices button allows you to use the same Focus settings on all your Apple devices where you're signed in to the same Apple Account.]

Stay focused

Whether you're driving, working, or just need to step away from your iPhone, you can set up a Focus to temporarily silence notifications that don't match your task—and let other people know you're busy.

Go to Settings  [ALT N/A] > Focus, then choose the Focus you want to use, or tap  [Alt text: the Add button] to create your own.

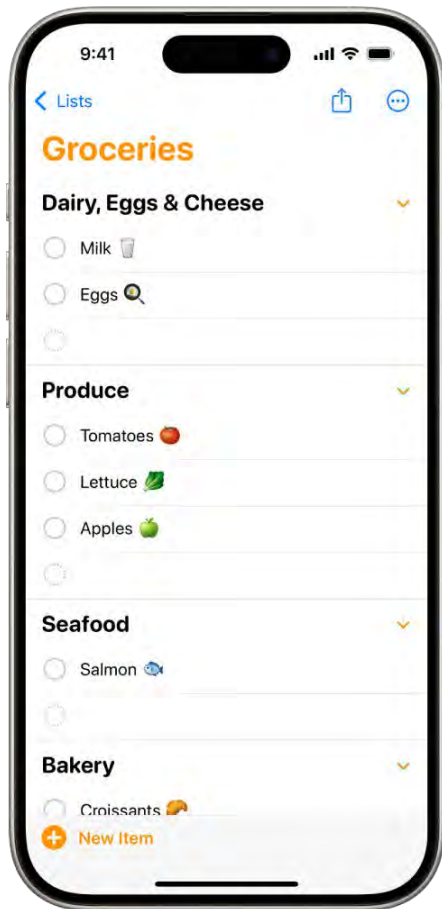

[Alt text: A grocery list in the Reminders app.]

Reminders when you need them

You can use the Reminders app  [ALT N/A] to make to-do lists for projects around the house and grocery lists that sort items into categories. You can also get a reminder about something when you arrive at a certain location.

To create your first reminder, open the Reminders app, then tap New Reminder.

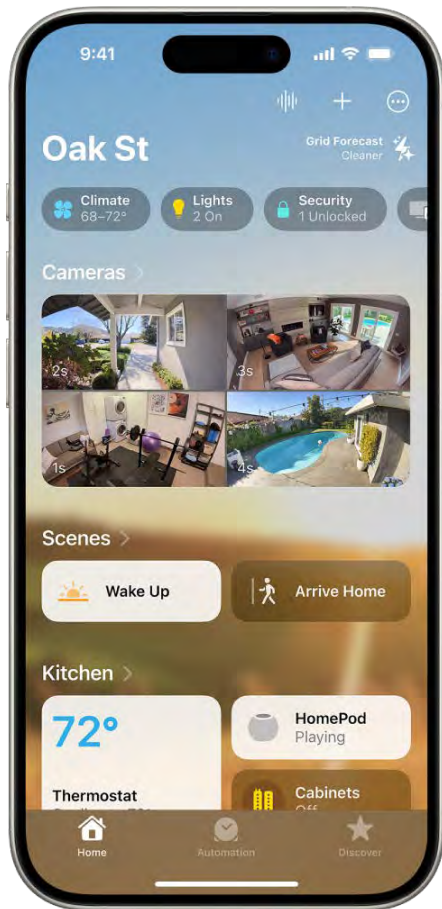

[Alt text: The My Home screen in the Home app.]

Forgot to turn off the lights?

With the Home app  [ALT N/A] on iPhone, you can securely control HomeKit-enabled accessories, such as lights, smart TVs, and thermostats from anywhere. You can also create automations that simplify your normal routines, like automatically turning on your entryway lights when you arrive home at night.

To add your first Works with HomeKit accessory, open the Home app, tap  [Alt text: the Add button], then tap Add or Scan Accessory.

Want to learn more?

- [Use StandBy to view information at a distance while iPhone is charging](#)
- [Add places and notes to your library on iPhone](#)
- [About Apple Wallet on iPhone](#)
- [Set up a Focus on iPhone](#)
- [Make a grocery list in Reminders on iPhone](#)

- [Intro to Home on iPhone](#)

Not all features are available for all iPhone models.

Take great photos and videos

Take great photos and videos

With your iPhone nearby, you'll never miss a chance to take a photo or video, snap a selfie, or capture scenes in low light. After you take photos, use the iPhone editing tools to crop, adjust the light and color, and much more.

Metadata

Summary: Use your iPhone camera to take great photos in any situation.



[Alt text: The iPhone screen showing the Lock Screen sliding to the left and the Camera open on the right side of the screen.]

Capture the moment

To quickly open Camera, just swipe left on the Lock Screen. Camera automatically focuses the shot and adjusts the exposure. Tap the Shutter button to take a photo.



[Alt text: The Camera screen in Photo mode. The subject fills the center of the screen, inside the camera frame. At the bottom of the screen, the Shutter button moves to the right, demonstrating the movement of starting a QuickTake video. The video timer is at the top of the screen.]



Quickly switch to video

You can record videos without switching out of Photo mode. Just touch and hold the Shutter button and Camera begins recording a QuickTake video. Release the button to stop recording.



[Alt text: The Camera screen in Photo mode, showing four people in the Camera frame.]



Take the perfect selfie

To take a selfie, open Camera, then tap  [Alt text: the Camera Chooser Back-Facing button] or  [Alt text: the Camera Chooser Back-Facing button] (depending on your model). Hold your iPhone in front of you, then tap the Shutter button or either volume button to take the shot.



[Alt text: The Camera screen in Photo mode. Buttons for flash and Night mode appear in the top-left corner of the screen and Night mode is on. The Camera Controls button is in top center, and the Live Photo button is in the top-right corner. At the bottom of the screen are, from left to right, the Photo and Video Viewer button, the Take Picture button, and the Camera Chooser Back-Facing button. Within the camera frame, is a night scene.]

Shoot photos in low light

On [supported models](#), Night mode automatically takes bright, detailed photos in low-light settings. When  [Alt text: the Night mode button] turns yellow, Night mode is on. Tap the Shutter button, then hold your iPhone still to capture the shot. To experiment with Night mode, tap  [Alt text: the Night mode button], then move the slider below the frame to adjust the exposure time.



[Alt text: The iPhone is turned horizontally. The Camera is open and in Video mode. Buttons for flash and Action mode appear in the bottom-left corner of the screen and Action mode is on. The Camera Controls button is in left center of the screen, and in the top-left corner are quick toggles to switch the video resolution and frame rate. At the right side are, from top to bottom, the Camera Chooser Back-Facing button, the Record button, and the Photo and Video Viewer button. Within the camera frame, is a person running.]

Stabilize video recordings with Action mode

On [supported models](#), Action mode helps you capture smooth hand-held videos even when you're moving around a lot—when jogging or hiking, for example. To turn on Action mode, open Camera, switch to Video mode, then tap  [Alt text: the Action Mode Off button] .

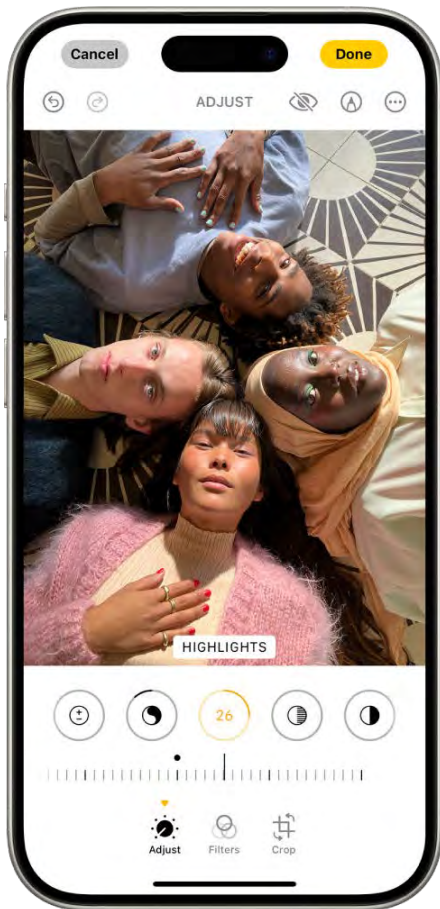

[Alt text: The edit screen in the Photos app. A photo is in the center of the screen. Below the photo are editing buttons; Highlights is selected. Below the editing buttons is a slider to adjust the Highlights levels. Below the slider, from left to right, are the Adjust, Filters, and Crop buttons. The Done button is in the top-right corner.]

Add the final touches

After you take a photo or video, use the editing tools in the Photos app to make it even better. Open a photo or video, tap  [Alt text: the Edit button], then tap the buttons at the bottom of the screen to adjust lighting, add a filter, crop, or rotate. As you make edits, tap the photo to compare your changes to the original.

Want to learn more? Check out the [Camera](#) and [Photos](#) chapters.

Not all features are available for all iPhone models.

Expert advice from Apple Support

Expert advice from Apple Support

Apple Support advisors help iPhone customers with all sorts of questions from forgotten passwords to lost photos. Below are a few pieces of advice that Apple Support advisors wish all iPhone owners knew. Follow these simple steps now to keep your iPhone, and the important information you keep on it, safe.

Metadata

Summary: iPhone advice from Apple Support.

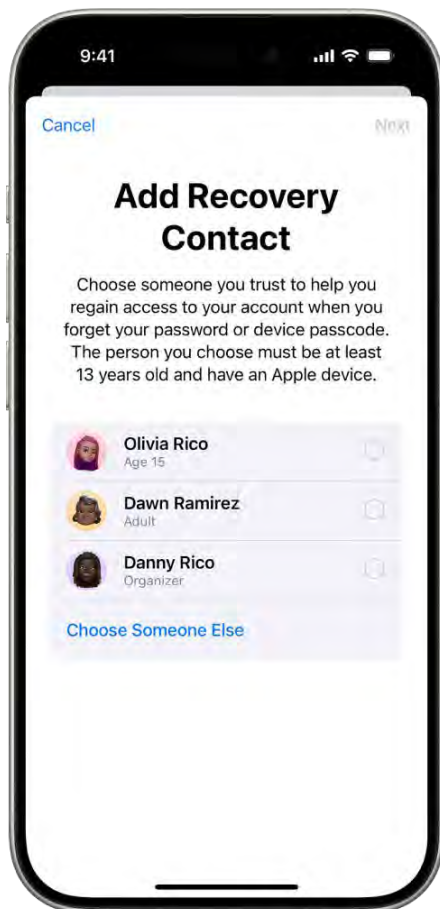

[Alt text: The Add Recovery Contact screen.]

Just in case you forget

After you set up your iPhone, there are two things you really don't want to forget—your iPhone passcode and your Apple Account. Your iPhone passcode is the four- or six-digit numerical code that you use to unlock your iPhone. You use your Apple Account to sign in to Apple services, make purchases in the App Store, and more. Your Apple Account is typically your primary email address or phone number and the unique password you create to use with it.

If you think you might forget these things, you can designate a trusted person as your account recovery contact. Your recovery contact doesn't have access to your iPhone or Apple account, but they can give you a code to reset your passcode or access your account if you get locked out. To set up a recovery contact, go to Settings [ALT N/A] > [your name] > Sign-In & Security > Account Recovery, tap Add Recovery Contact, then follow the onscreen instructions.

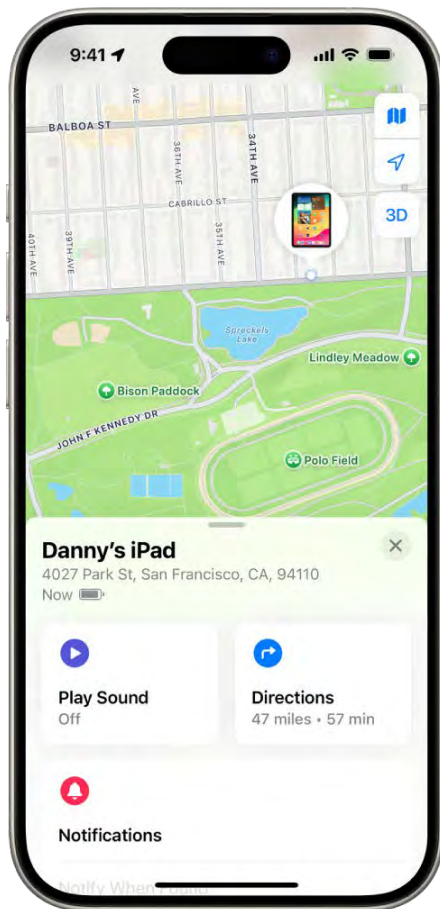

[Alt text: The Find My screen showing the location of an iPhone on a map at the top of the screen.]

How to find your iPhone if it's lost or stolen

It's easy to find your iPhone if it ever gets lost or stolen—as long as you turn on Find My iPhone before that happens. First, make sure you're signed in to your Apple Account, then go to Settings [ALT N/A] > [your name] > Find My > Find My iPhone, and turn on Find My iPhone.

After you turn on Find My iPhone, you can use the Find My app on another Apple device to see the location of your iPhone; you can even play a sound on your lost iPhone to help you find it. (Make sure you're signed in to the same Apple Account on the other Apple device.) If you don't have another Apple device, go to www.icloud.com/find on any web browser and sign in to the same Apple Account.



[Alt text: The Recently Deleted folder in the Photos app. Recently deleted photos appear in a grid on the screen.]

Recover deleted photos or videos

When you delete photos or videos from the Photos app, they're automatically saved in the Recently Deleted folder for 30 days. If you accidentally delete a photo or video, you can recover it and restore it to your Photos library.

To recover deleted items, open the Photos app, tap Albums, swipe up, then tap Recently Deleted (below Utilities). Unlock the folder using your iPhone passcode, Face ID, or Touch ID. Tap a photo or video, tap Recover, then tap Recover Photo or Video.





[Alt text: An iPhone screen showing the battery charged 100%.]

Maximize the life of your iPhone battery

There are a few easy steps you can take to preserve the life of your iPhone battery. First, make sure your iPhone is updated to the latest version of iOS. To check if a software update is available, go to Settings  [ALT N/A] > General > Software Update.

Next, always connect to Wi-Fi when it's available; a Wi-Fi connection uses less battery power than a cellular connection.

Last, turn down your screen brightness: Open Control Center and drag  [Alt text: Brightness] . To automatically dim your screen based on the surrounding light, go to Settings  [ALT N/A] > Accessibility > Display & Text Size, then turn on Auto-Brightness.

To learn more about your iPhone battery health, go to Settings  [ALT N/A] > Battery.

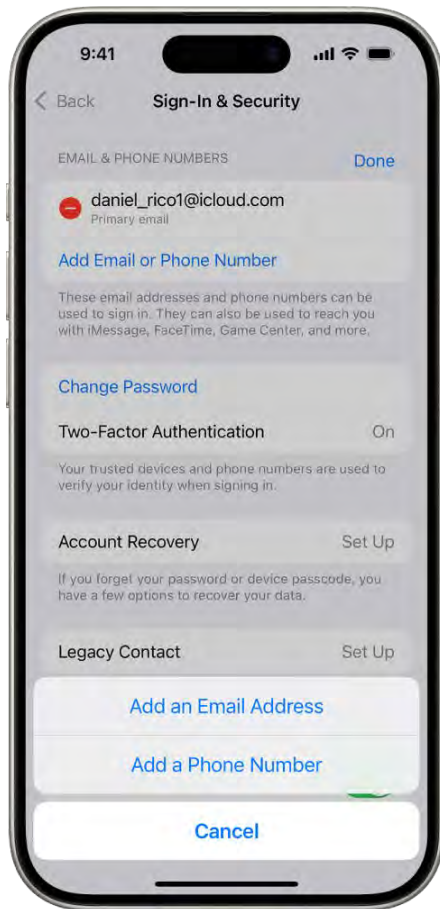

[Alt text: The Sign-In & Security screen in Settings.]

If you get a new phone number

The phone number associated with your Apple Account is often used to verify your identity and authenticate that your iPhone is really yours—it's known as your trusted phone number. If you get a new phone number, make sure you update your trusted phone number so you don't lose access to your account if you forget your Apple Account password, or move to a new iPhone.

To update your trusted phone number, go to Settings  [ALT N/A] > [your name] > Sign-In & Security, then tap Edit next to Email & Phone Numbers. Tap Add Email or Phone Number, then tap Add a Phone Number. Enter your new phone number and follow the onscreen instructions to verify your new number.



[Alt text: An iPhone screen showing an illustration of the globe. At the top of the globe is a radio signal and an airplane flies around the globe.]

All about eSIM

An eSIM is a digital version of the physical SIM card inside your iPhone that connects to your cellular carrier. With eSIM, you don't have to swap out your SIM card when you get a new iPhone, and you can easily connect to new cellular carriers at home or while traveling. If you purchased an iPhone 14 model or later in the United States, your iPhone automatically connects to your cellular carrier using eSIM.

If you erase your iPhone, or restore it from a backup and accidentally delete your eSIM, your iPhone may lose its cellular connection; to restore it, you'll need to contact your cellular provider.

Want to learn more?

- [Keep your Apple Account secure on iPhone](#)
- [Locate a device in Find My on iPhone](#)
- [Delete or hide photos and videos on iPhone](#)

- [Check the iPhone battery health and usage](#)

- P9

[Set up an eSIM](#)

Not all features are available for all iPhone models.

iPhone models

iPhone models compatible with iOS 18

Metadata

Summary: Find out which iPhone models support iOS 18.

This guide helps you get started using iPhone and discover all the amazing things it can do with iOS 18, which is compatible with the following models:

(table aria-label=iPhone models)



[Alt text: Three iPhone models with Face ID.]

[iPhone XR](#)

[iPhone XS](#)

[iPhone XS Max](#)

[iPhone 11](#)

[iPhone 11 Pro](#)

[iPhone 11 Pro Max](#)

[iPhone 12 mini](#)

[iPhone 12](#)

[iPhone 12 Pro](#)



[Alt text: An iPhone model with a Home button.]

[iPhone SE \(2nd generation\)](#)

[iPhone SE \(3rd generation\)](#)

[iPhone 12 Pro Max](#)

[iPhone 13 mini](#)

[iPhone 13](#)

[iPhone 13 Pro](#)

[iPhone 13 Pro Max](#)

[iPhone 14](#)

[iPhone 14 Plus](#)

[iPhone 14 Pro](#)

[iPhone 14 Pro Max](#)

[iPhone 15](#)

[iPhone 15 Plus](#)

[iPhone 15 Pro](#)

[iPhone 15 Pro Max](#)

Your features and apps may vary depending on your iPhone model, region, language, and carrier. To find out which features are supported in your region, see the [iOS and iPadOS Feature Availability website](#).

Note: Apps and services that send or receive data over a cellular network, or that answer incoming calls, may incur additional fees. Contact your carrier for information about your service plan and fees.

Identify your iPhone model and iOS version

Go to Settings  [ALT N/A] > General > About. See [Get information about your iPhone](#).

To determine your iPhone model from the physical details, see the Apple Support article [Identify your iPhone model](#).

Get iOS updates

To update your iPhone to the latest iOS software compatible with your model, go to Settings  [ALT N/A] > General > Software Update. See [Update iOS on iPhone](#).

iPhone XR

Metadata

Summary: Learn the location of the cameras, buttons, and other essential hardware features on iPhone XR.

Learn the location of the cameras, buttons, and other essential hardware features on iPhone XR.

(table aria-label=iPhone XR features)

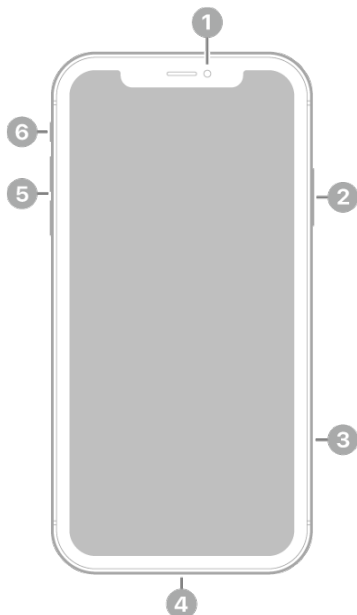

- 1 [Alt text: 1 Front camera
- 2 [Alt text: 2 Side button
- 3 [Alt text: 3 SIM tray
- 4 [Alt text: 4 Lightning connector
- 5 [Alt text: 5 Volume buttons
- 6 [Alt text: 6 Ring/Silent switch

[Alt text: The front view of iPhone XR. The front camera is at the top center. On the right side, from top to bottom, are the side button and the SIM tray. The Lightning connector is on the bottom. On the left side, from bottom to top, are the volume buttons and the Ring/Silent switch.]

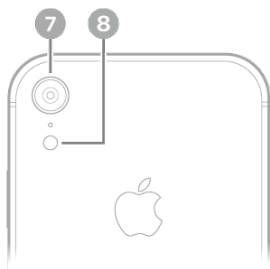

- 7 [Alt text: 7 Rear camera
- 8 [Alt text: 8 Flash

[Alt text: The back view of iPhone XR. The rear camera and flash are at the top left.]

Get started with iPhone XR

- [Turn on and set up iPhone](#)
- [Learn gestures for iPhone models with Face ID](#)

- [iPhone camera basics](#)
- [Qi-certified wireless chargers for iPhone](#)
- [What's new in iOS 18](#)

iPhone XS

Metadata

Summary: Learn the location of the cameras, buttons, and other essential hardware features on iPhone XS.

Learn the location of the cameras, buttons, and other essential hardware features on iPhone XS.

(table aria-label=iPhone XS features)

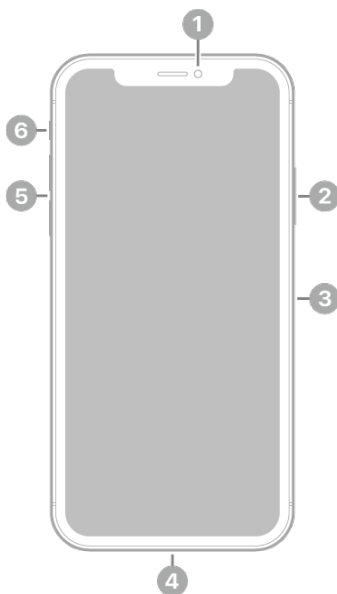

- 1 [Alt text: 1] Front camera
- 2 [Alt text: 2] Side button
- 3 [Alt text: 3] SIM tray
- 4 [Alt text: 4] Lightning connector
- 5 [Alt text: 5] Volume buttons
- 6 [Alt text: 6] Ring/Silent switch

[Alt text: The front view of iPhone XS. The front camera is at the top center. On the right side, from top to bottom, are the side button and the SIM tray. The Lightning connector is on the bottom. On the left side, from bottom to top, are the volume buttons and the Ring/Silent switch.]

- 7 [Alt text: 7] Rear cameras



8 [Alt text: 8 Flash

[Alt text: The back view of iPhone XS. The rear cameras and flash are at the top left.]

Get started with iPhone XS

- [Turn on and set up iPhone](#)
- [Learn gestures for iPhone models with Face ID](#)
- [iPhone camera basics](#)
- [Qi-certified wireless chargers for iPhone](#)
- [What's new in iOS 18](#)

iPhone XS Max

Metadata

Summary: Learn the location of the cameras, buttons, and other essential hardware features on iPhone XS Max.

Learn the location of the cameras, buttons, and other essential hardware features on iPhone XS Max.

(table aria-label=iPhone XS Max features)

-
- 1 [Alt text: 1 Front camera
 - 2 [Alt text: 2 Side button
 - 3 [Alt text: 3 SIM tray
 - 4 [Alt text: 4 Lightning connector
 - 5 [Alt text: 5 Volume buttons
 - 6 [Alt text: 6 Ring/Silent switch

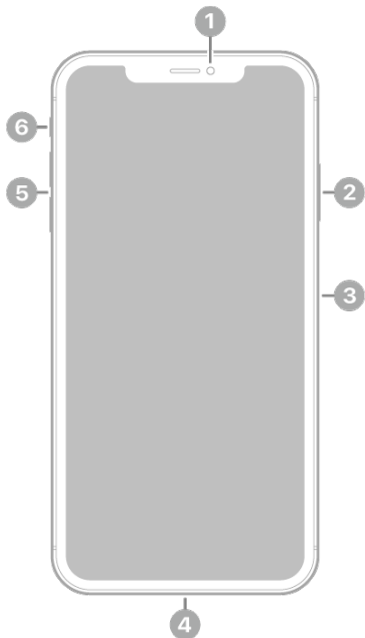

[Alt text: The front view of iPhone XS Max. The front camera is at the top center. On the right side, from top to bottom, are the side button and the SIM tray. The Lightning connector is on the bottom. On the left side, from bottom to top, are the volume buttons and the Ring/Silent switch.]

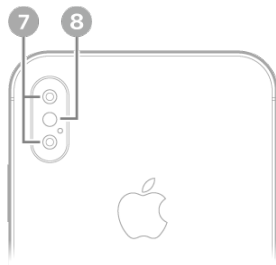

7 [Alt text: 7 Rear cameras

8 [Alt text: 8 Flash

[Alt text: The back view of iPhone XS Max. The rear cameras and flash are at the top left.]

Get started with iPhone XS Max

- [Turn on and set up iPhone](#)
- [Learn gestures for iPhone models with Face ID](#)
- [iPhone camera basics](#)
- [Qi-certified wireless chargers for iPhone](#)
- [What's new in iOS 18](#)

iPhone 11

Metadata

Summary: Learn the location of the cameras, buttons, and other essential hardware features on iPhone 11.

Learn the location of the cameras, buttons, and other essential hardware features on iPhone 11.

(table aria-label=iPhone 11 features)

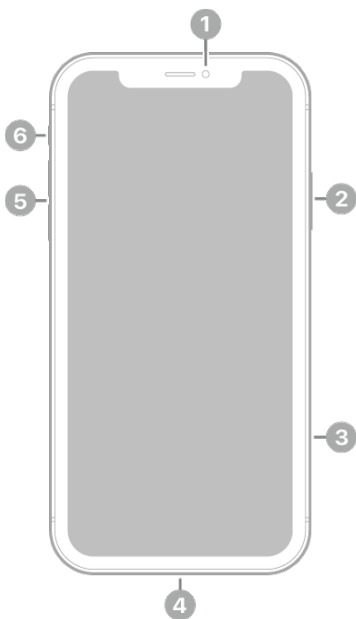

- 1 [Alt text: 1 Front camera
- 2 [Alt text: 2 Side button
- 3 [Alt text: 3 SIM tray
- 4 [Alt text: 4 Lightning connector
- 5 [Alt text: 5 Volume buttons
- 6 [Alt text: 6 Ring/Silent switch

[Alt text: The front view of iPhone 11. The front camera is at the top center. On the right side, from top to bottom, are the side button and the SIM tray. The Lightning connector is on the bottom. On the left side, from bottom to top, are the volume buttons and the Ring/Silent switch.]

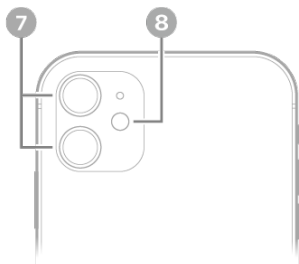

- 7 [Alt text: 7 Rear cameras
- 8 [Alt text: 8 Flash

[Alt text: The back view of iPhone 11. The rear cameras and flash are at the top left.]

Get started with iPhone 11

- [Turn on and set up iPhone](#)
- [Learn gestures for iPhone models with Face ID](#)
- [iPhone camera basics](#)
- [Qi-certified wireless chargers for iPhone](#)
- [What's new in iOS 18](#)

iPhone 11 Pro

Metadata

Summary: Learn the location of the cameras, buttons, and other essential hardware features on iPhone 11 Pro.

Learn the location of the cameras, buttons, and other essential hardware features on iPhone 11 Pro.

(table aria-label=iPhone 11 Pro features)

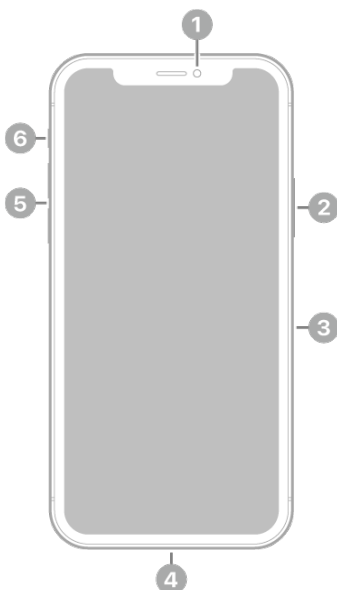

- 1 [Alt text: 1 Front camera
- 2 [Alt text: 2 Side button
- 3 [Alt text: 3 SIM tray
- 4 [Alt text: 4 Lightning connector
- 5 [Alt text: 5 Volume buttons
- 6 [Alt text: 6 Ring/Silent switch

[Alt text: The front view of iPhone 11 Pro. The front

camera is at the top center. On the right side, from top to bottom, are the side button and the SIM tray. The Lightning connector is on the bottom. On the left side, from bottom to top, are the volume buttons and the Ring/Silent switch.

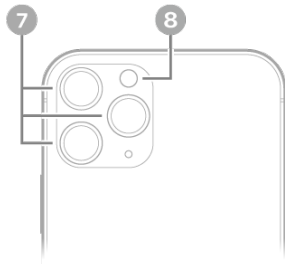

- 7 [Alt text: 7] Rear cameras
- 8 [Alt text: 8] Flash

[Alt text: The back view of iPhone 11 Pro. The rear cameras and flash are at the top left.]

Get started with iPhone 11 Pro

- [Turn on and set up iPhone](#)
- [Learn gestures for iPhone models with Face ID](#)
- [iPhone camera basics](#)
- [Qi-certified wireless chargers for iPhone](#)
- [What's new in iOS 18](#)

iPhone 11 Pro Max

Metadata

Summary: Learn the location of the cameras, buttons, and other essential hardware features on iPhone 11 Pro Max.

Learn the location of the cameras, buttons, and other essential hardware features on iPhone 11 Pro Max.

(table aria-label=iPhone 11 Pro Max features)

- 1 [Alt text: 1] Front camera
- 2 [Alt text: 2] Side button
- 3 [Alt text: 3] SIM tray

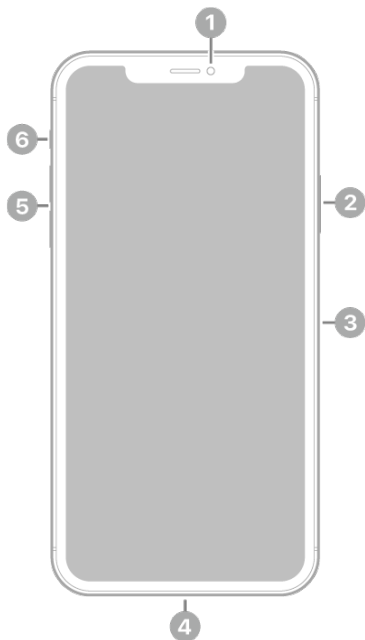

- ④ [Alt text: 4 Lightning connector
- ⑤ [Alt text: 5 Volume buttons
- ⑥ [Alt text: 6 Ring/Silent switch

[Alt text: The front view of iPhone 11 Pro Max. The front camera is at the top center. On the right side, from top to bottom, are the side button and the SIM tray. The Lightning connector is on the bottom. On the left side, from bottom to top, are the volume buttons and the Ring/Silent switch.]

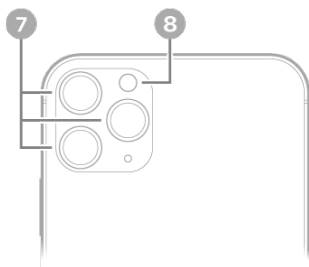

- ⑦ [Alt text: 7 Rear cameras
- ⑧ [Alt text: 8 Flash

[Alt text: The back view of iPhone 11 Pro Max. The rear cameras and flash are at the top left.]

Get started with iPhone 11 Pro Max

- [Turn on and set up iPhone](#)
- [Learn gestures for iPhone models with Face ID](#)

- [iPhone camera basics](#)
- [Qi-certified wireless chargers for iPhone](#)
- [What's new in iOS 18](#)

iPhone SE (2nd generation)

Metadata

Summary: Learn the location of the cameras, buttons, and other essential hardware features on iPhone SE (2nd generation).

Learn the location of the cameras, buttons, and other essential hardware features on iPhone SE (2nd generation).

(table aria-label=iPhone SE (2nd generation) features)

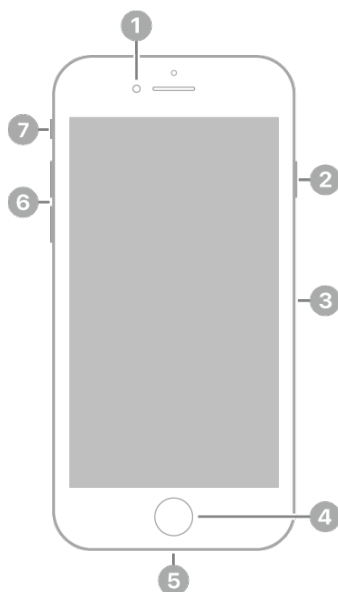

- 1 [Alt text: 1 Front camera
- 2 [Alt text: 2 Side button
- 3 [Alt text: 3 SIM tray
- 4 [Alt text: 4 Home button/Touch ID
- 5 [Alt text: 5 Lightning connector
- 6 [Alt text: 6 Volume buttons
- 7 [Alt text: 7 Ring/Silent switch

[Alt text: The front view of iPhone SE (2nd generation).

The front camera is at the top, to the left of the speaker. On the right side, from top to bottom, are the side button and the SIM tray. The Home button is at the bottom center. The Lightning connector is on the bottom edge. On the left side, from bottom to top, are the volume buttons and the Ring/Silent switch.

- 8 [Alt text: 8 Rear camera

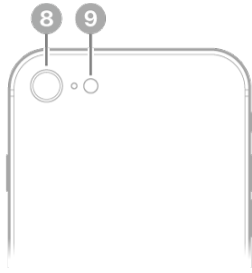

9 [Alt text: 9 Flash

[Alt text: The back view of iPhone SE (2nd generation). The rear camera and flash are at the top left.]

Get started with iPhone SE

- [Turn on and set up iPhone](#)
- [Learn basic gestures to interact with iPhone](#)
- [iPhone camera basics](#)
- [Qi-certified wireless chargers for iPhone](#)
- [What's new in iOS 18](#)

iPhone 12 mini

Metadata

Summary: Learn the location of the cameras, buttons, and other essential hardware features on iPhone 12 mini.

Learn the location of the cameras, buttons, and other essential hardware features on iPhone 12 mini.

(table aria-label=iPhone 12 mini features)

-
- 1 [Alt text: 1 Front camera
 - 2 [Alt text: 2 Side button
 - 3 [Alt text: 3 Lightning connector
 - 4 [Alt text: 4 SIM tray
 - 5 [Alt text: 5 Volume buttons
 - 6 [Alt text: 6 Ring/Silent switch

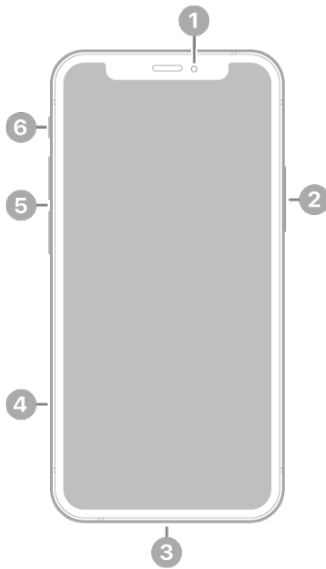

[Alt text: The front view of iPhone 12 mini. The front camera is at the top center. The side button is on the right side. The Lightning connector is on the bottom. On the left side, from bottom to top, are the SIM tray, the volume buttons, and the Ring/Silent switch.]

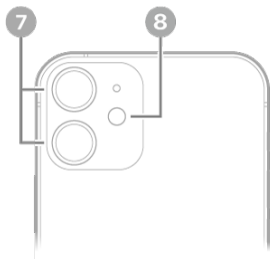

- 7 [Alt text: 7 Rear cameras
- 8 [Alt text: 8 Flash

[Alt text: The back view of iPhone 12 mini. The rear cameras and flash are at the top left.]

Get started with iPhone 12 mini

- [Turn on and set up iPhone](#)
- [Learn gestures for iPhone models with Face ID](#)
- [iPhone camera basics](#)
- [MagSafe chargers and battery packs for iPhone](#)
- [What's new in iOS 18](#)

iPhone 12

Metadata

Summary: Learn the location of the cameras, buttons, and other essential hardware features on iPhone 12.

Learn the location of the cameras, buttons, and other essential hardware features on iPhone 12.

(table aria-label=iPhone 12 features)

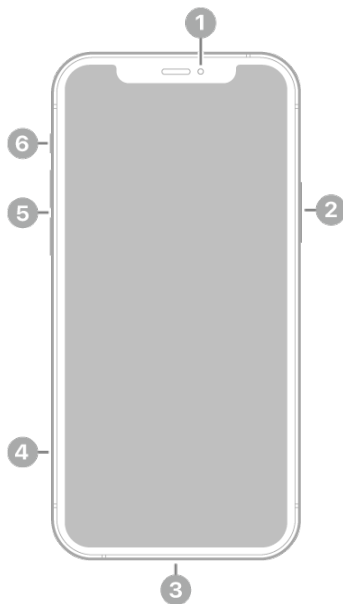

- 1 [Alt text: 1 Front camera
- 2 [Alt text: 2 Side button
- 3 [Alt text: 3 Lightning connector
- 4 [Alt text: 4 SIM tray
- 5 [Alt text: 5 Volume buttons
- 6 [Alt text: 6 Ring/Silent switch

[Alt text: The front view of iPhone 12. The front camera is at the top center. The side button is on the right side. The Lightning connector is on the bottom. On the left side, from bottom to top, are the SIM tray, the volume buttons, and the Ring/Silent switch.

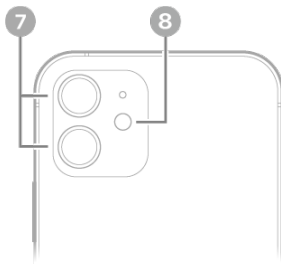

- 7 [Alt text: 7 Rear cameras
- 8 [Alt text: 8 Flash

[Alt text: The back view of iPhone 12. The rear cameras and flash are at the top left.]

Get started with iPhone 12

- [Turn on and set up iPhone](#)
- [Learn gestures for iPhone models with Face ID](#)
- [iPhone camera basics](#)
- [MagSafe chargers and battery packs for iPhone](#)
- [What's new in iOS 18](#)

iPhone 12 Pro

Metadata

Summary: Learn the location of the cameras, buttons, and other essential hardware features on iPhone 12 Pro.

Learn the location of the cameras, buttons, and other essential hardware features on iPhone 12 Pro.

(table aria-label=iPhone 12 Pro features)

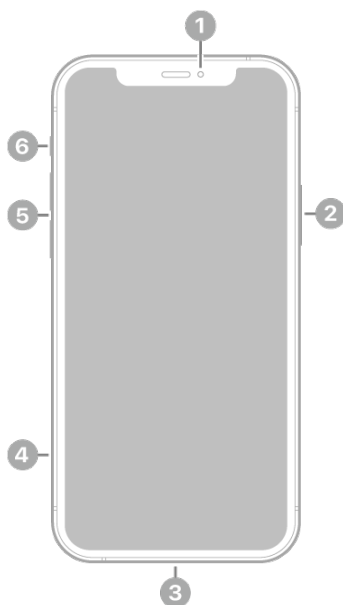

- 1 [Alt text: 1] Front camera
- 2 [Alt text: 2] Side button
- 3 [Alt text: 3] Lightning connector
- 4 [Alt text: 4] SIM tray
- 5 [Alt text: 5] Volume buttons
- 6 [Alt text: 6] Ring/Silent switch

[Alt text: The front view of iPhone 12 Pro. The front camera is at the top center. The side button is on the right side. The Lightning connector is on the bottom. On the left side, from bottom to top, are the SIM tray,

the volume buttons, and the Ring/Silent switch.]

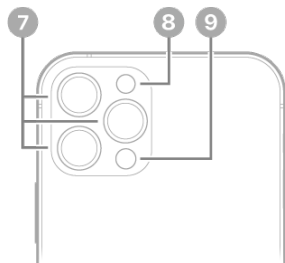

- 7 [Alt text: 7 Rear cameras
- 8 [Alt text: 8 Flash
- 9 [Alt text: 9 LiDAR Scanner

[Alt text: The back view of iPhone 12 Pro. The rear cameras, flash, and LiDAR Scanner are at the top left.]

Get started with iPhone 12 Pro

- [Turn on and set up iPhone](#)
- [Learn gestures for iPhone models with Face ID](#)
- [iPhone camera basics](#)
- [MagSafe chargers and battery packs for iPhone](#)
- [What's new in iOS 18](#)

iPhone 12 Pro Max

Metadata

Summary: Learn the location of the cameras, buttons, and other essential hardware features on iPhone 12 Pro Max.

Learn the location of the cameras, buttons, and other essential hardware features on iPhone 12 Pro Max.

(table aria-label=iPhone 12 Pro Max features)

- 1 [Alt text: 1 Front camera
- 2 [Alt text: 2 Side button
- 3 [Alt text: 3 Lightning connector
- 4 [Alt text: 4 SIM tray
- 5 [Alt text: 5 Volume buttons
- 6 [Alt text: 6 Ring/Silent switch

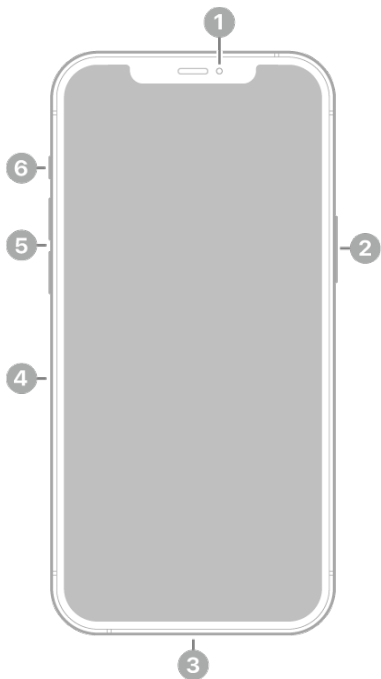

[Alt text: The front view of iPhone 12 Pro Max. The front camera is at the top center. The side button is on the right side. The Lightning connector is on the bottom. On the left side, from bottom to top, are the SIM tray, the volume buttons, and the Ring/Silent switch.]

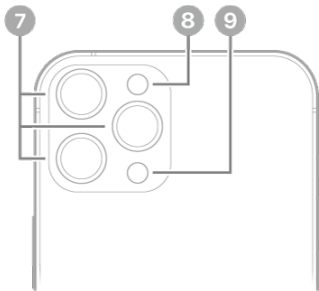

- 7 [Alt text: 7 Rear cameras
- 8 [Alt text: 8 Flash
- 9 [Alt text: 9 LiDAR Scanner

[Alt text: The back view of iPhone 12 Pro Max. The rear cameras, flash, and LiDAR Scanner are at the top left.]

Get started with iPhone 12 Pro Max

- [Turn on and set up iPhone](#)
- [Learn gestures for iPhone models with Face ID](#)
- [iPhone camera basics](#)
- [MagSafe chargers and battery packs for iPhone](#)

- [What's new in iOS 18](#)

iPhone 13 mini

Metadata

Summary: Learn the location of the cameras, buttons, and other essential hardware features on iPhone 13 mini.

Learn the location of the cameras, buttons, and other essential hardware features on iPhone 13 mini.

(table aria-label=iPhone 13 mini features)

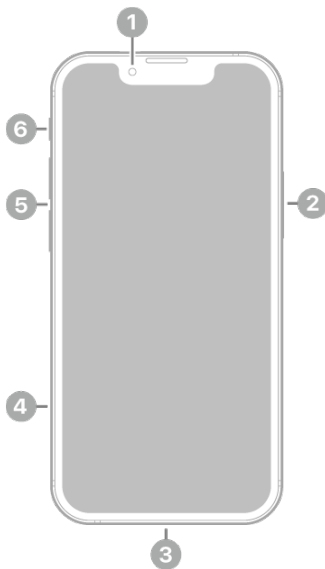

- 1 [Alt text: 1] Front camera
- 2 [Alt text: 2] Side button
- 3 [Alt text: 3] Lightning connector
- 4 [Alt text: 4] SIM tray
- 5 [Alt text: 5] Volume buttons
- 6 [Alt text: 6] Ring/Silent switch

[Alt text: The front view of iPhone 13 mini. The front camera is at the top center. The side button is on the right side. The Lightning connector is on the bottom. On the left side, from bottom to top, are the SIM tray, the volume buttons, and the Ring/Silent switch.]

- 7 [Alt text: 7] Rear cameras
- 8 [Alt text: 8] Flash

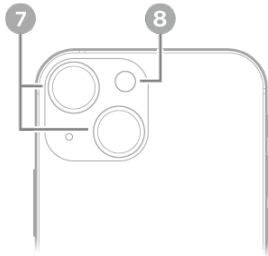

[Alt text: The back view of iPhone 13 mini. The rear cameras and flash are at the top left.]

Get started with iPhone 13 mini

- [Turn on and set up iPhone](#)
- [Learn gestures for iPhone models with Face ID](#)
- [iPhone camera basics](#)
- [MagSafe chargers and battery packs for iPhone](#)
- [What's new in iOS 18](#)

iPhone 13

Metadata

Summary: Learn the location of the cameras, buttons, and other essential hardware features on iPhone 13.

Learn the location of the cameras, buttons, and other essential hardware features on iPhone 13.

(table aria-label=iPhone 13 features)

-
- 1 [Alt text: 1] Front camera
 - 2 [Alt text: 2] Side button
 - 3 [Alt text: 3] Lightning connector
 - 4 [Alt text: 4] SIM tray
 - 5 [Alt text: 5] Volume buttons
 - 6 [Alt text: 6] Ring/Silent switch

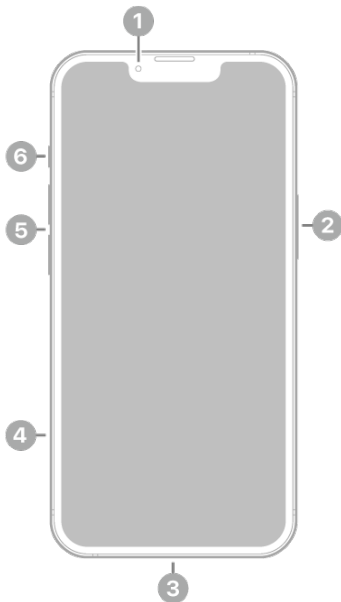

[Alt text: The front view of iPhone 13. The front camera is at the top center. The side button is on the right side. The Lightning connector is on the bottom. On the left side, from bottom to top, are the SIM tray, the volume buttons, and the Ring/Silent switch.]

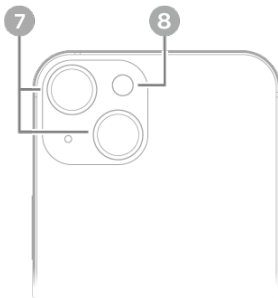

7 [Alt text: 7 Rear cameras

8 [Alt text: 8 Flash

[Alt text: The back view of iPhone 13. The rear cameras and flash are at the top left.]

Get started with iPhone 13

- [Turn on and set up iPhone](#)
- [Learn gestures for iPhone models with Face ID](#)
- [iPhone camera basics](#)
- [MagSafe chargers and battery packs for iPhone](#)
- [What's new in iOS 18](#)

iPhone 13 Pro

Metadata

Summary: Learn the location of the cameras, buttons, and other essential hardware features on iPhone 13 Pro.

Learn the location of the cameras, buttons, and other essential hardware features on iPhone 13 Pro.

(table aria-label=iPhone 13 Pro features)

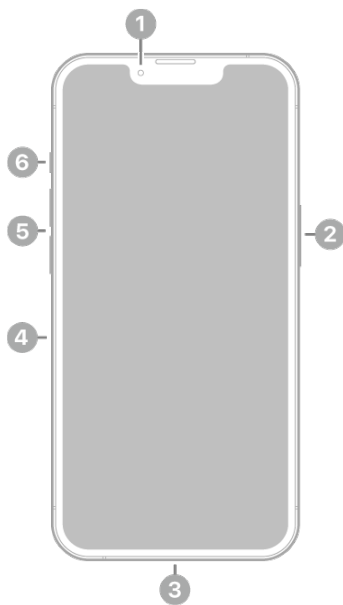

- 1 [Alt text: 1 Front camera
- 2 [Alt text: 2 Side button
- 3 [Alt text: 3 Lightning connector
- 4 [Alt text: 4 SIM tray
- 5 [Alt text: 5 Volume buttons
- 6 [Alt text: 6 Ring/Silent switch

[Alt text: The front view of iPhone 13 Pro. The front camera is at the top center. The side button is on the right side. The Lightning connector is on the bottom. On the left side, from bottom to top, are the SIM tray, the volume buttons, and the Ring/Silent switch.]

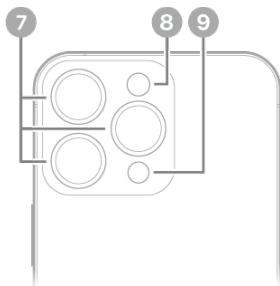

- 7 [Alt text: 7 Rear cameras
- 8 [Alt text: 8 Flash
- 9 [Alt text: 9 LiDAR Scanner

[Alt text: The back view of iPhone 13 Pro. The rear

cameras, flash, and LiDAR Scanner are at the top left.

Get started with iPhone 13 Pro

- [Turn on and set up iPhone](#)
- [Learn gestures for iPhone models with Face ID](#)
- [iPhone camera basics](#)
- [MagSafe chargers and battery packs for iPhone](#)
- [What's new in iOS 18](#)

iPhone 13 Pro Max

Metadata

Summary: Learn the location of the cameras, buttons, and other essential hardware features on iPhone 13 Pro Max.

Learn the location of the cameras, buttons, and other essential hardware features on iPhone 13 Pro Max.

(table aria-label=iPhone 13 Pro Max features)

- 1 [Alt text: 1 Front camera
- 2 [Alt text: 2 Side button
- 3 [Alt text: 3 Lightning connector
- 4 [Alt text: 4 SIM tray
- 5 [Alt text: 5 Volume buttons
- 6 [Alt text: 6 Ring/Silent switch

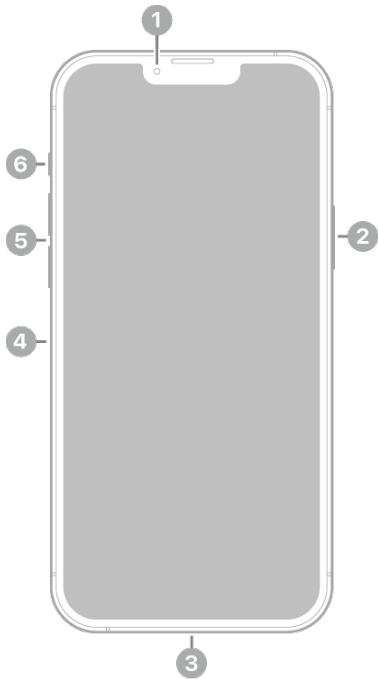

[Alt text: The front view of iPhone 13 Pro Max. The front camera is at the top center. The side button is on the right side. The Lightning connector is on the bottom. On the left side, from bottom to top, are the SIM tray, the volume buttons, and the Ring/Silent switch.]

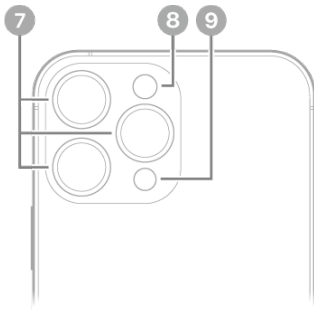

- 7 [Alt text: 7 Rear cameras
- 8 [Alt text: 8 Flash
- 9 [Alt text: 9 LiDAR Scanner

[Alt text: The back view of iPhone 13 Pro Max. The rear cameras, flash, and LiDAR Scanner are at the top left.]

Get started with iPhone 13 Pro Max

- [Turn on and set up iPhone](#)
- [Learn gestures for iPhone models with Face ID](#)
- [iPhone camera basics](#)
- [MagSafe chargers and battery packs for iPhone](#)

- [What's new in iOS 18](#)

iPhone SE (3rd generation)

Metadata

Summary: Learn the location of the cameras, buttons, and other essential hardware features on iPhone SE (3rd generation).

Learn the location of the cameras, buttons, and other essential hardware features on iPhone SE (3rd generation).

(table aria-label=iPhone SE (3rd generation) features)

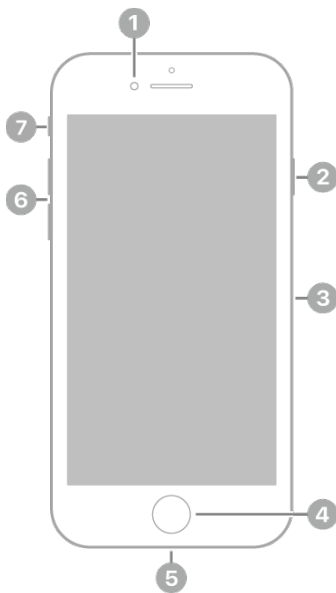

- 1 [Alt text: 1] Front camera
- 2 [Alt text: 2] Side button
- 3 [Alt text: 3] SIM tray
- 4 [Alt text: 4] Home button/Touch ID
- 5 [Alt text: 5] Lightning connector
- 6 [Alt text: 6] Volume buttons
- 7 [Alt text: 7] Ring/Silent switch

[Alt text: The front view of iPhone SE (3rd generation). The front camera is at the top, to the left of the speaker. On the right side, from top to bottom, are the side button and the SIM tray. The Home button is at the bottom center. The Lightning connector is on the bottom edge. On the left side, from bottom to top, are the volume buttons and the Ring/Silent switch.

- 8 [Alt text: 8] Rear camera
- 9 [Alt text: 9] Flash

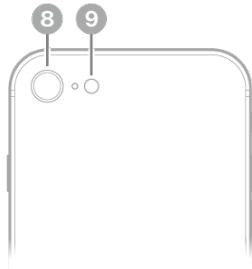

[Alt text: The back view of iPhone SE (3rd generation). The rear camera and flash are at the top left.]

Get started with iPhone SE

- [Turn on and set up iPhone](#)
- [Learn basic gestures to interact with iPhone](#)
- [iPhone camera basics](#)
- [Qi-certified wireless chargers for iPhone](#)
- [What's new in iOS 18](#)

iPhone 14

Metadata

Summary: Learn the location of the cameras, buttons, and other essential hardware features on iPhone 14.

Learn the location of the cameras, buttons, and other essential hardware features on iPhone 14.

(table aria-label=iPhone 14 features)

- 1 [Alt text: 1 Front camera
- 2 [Alt text: 2 Side button
- 3 [Alt text: 3 Lightning connector
- 4 [Alt text: 4 SIM tray (available on models purchased outside the U.S.)
- 5 [Alt text: 5 Volume buttons
- 6 [Alt text: 6 Ring/Silent switch

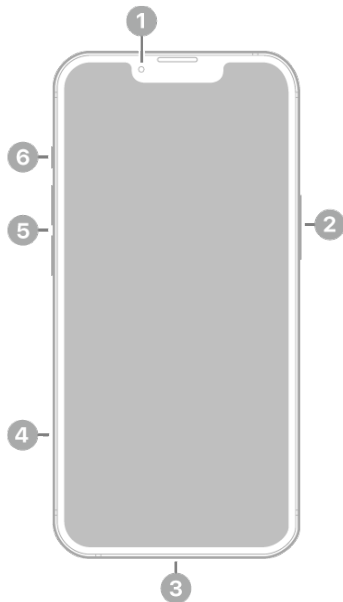

[Alt text: The front view of iPhone 14. The front camera is at the top center. The side button is on the right side. The Lightning connector is on the bottom. On the left side, from bottom to top, are the SIM tray, the volume buttons, and the Ring/Silent switch.]

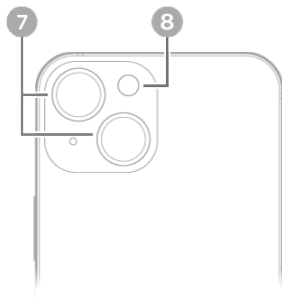

7 [Alt text: 7 Rear cameras

8 [Alt text: 8 Flash

[Alt text: The back view of iPhone 14. The rear cameras and flash are at the top left.]

Get started with iPhone 14

- [Turn on and set up iPhone](#)
- [Learn gestures for iPhone models with Face ID](#)
- [iPhone camera basics](#)
- [MagSafe chargers and battery packs for iPhone](#)
- [What's new in iOS 18](#)

iPhone 14 Plus

Metadata

Summary: Learn the location of the cameras, buttons, and other essential hardware features on iPhone 14 Plus.

Learn the location of the cameras, buttons, and other essential hardware features on iPhone 14 Plus.

(table aria-label=iPhone 14 Plus features)

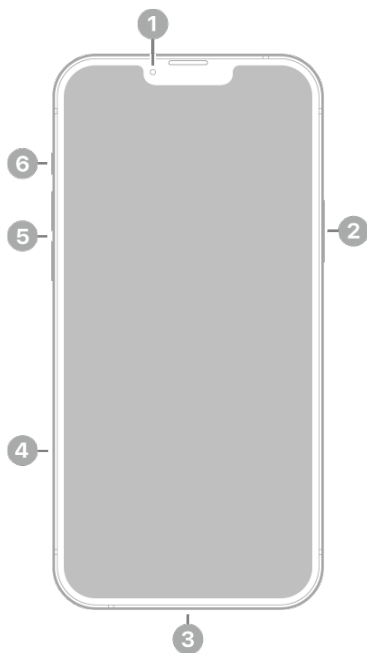

- 1 [Alt text: 1 Front camera
- 2 [Alt text: 2 Side button
- 3 [Alt text: 3 Lightning connector
- 4 [Alt text: 4 SIM tray (available on models purchased outside the U.S.)
- 5 [Alt text: 5 Volume buttons
- 6 [Alt text: 6 Ring/Silent switch

[Alt text: The front view of iPhone 14 Plus. The front camera is at the top center. The side button is on the right side. The Lightning connector is on the bottom. On the left side, from bottom to top, are the SIM tray, the volume buttons, and the Ring/Silent switch.]

- 7 [Alt text: 7 Rear cameras
- 8 [Alt text: 8 Flash

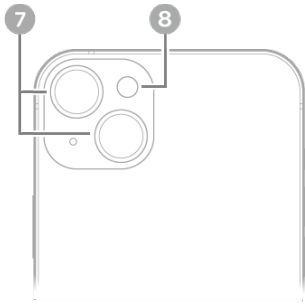

[Alt text: The back view of iPhone 14 Plus. The rear cameras and flash are at the top left.]

Get started with iPhone 14 Plus

- [Turn on and set up iPhone](#)
- [Learn gestures for iPhone models with Face ID](#)
- [iPhone camera basics](#)
- [MagSafe chargers and battery packs for iPhone](#)
- [What's new in iOS 18](#)

iPhone 14 Pro

Metadata

Summary: Learn the location of the cameras, buttons, and other essential hardware features on iPhone 14 Pro.

Learn the location of the cameras, buttons, and other essential hardware features on iPhone 14 Pro.

(table aria-label=iPhone 14 Pro features)

-
- 1 [Alt text: 1 Front camera
 - 2 [Alt text: 2 Side button
 - 3 [Alt text: 3 Lightning connector
 - 4 [Alt text: 4 SIM tray (available on models purchased outside the U.S.)
 - 5 [Alt text: 5 Volume buttons
 - 6 [Alt text: 6 Ring/Silent switch

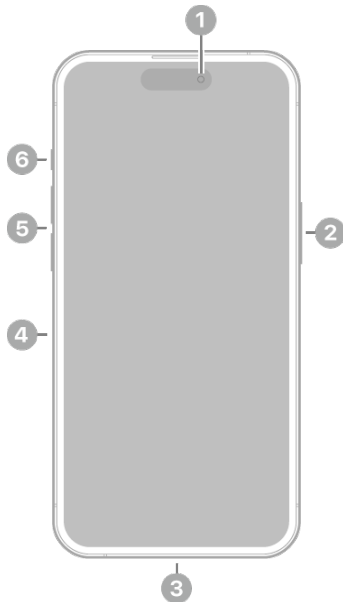

[Alt text: The front view of iPhone 14 Pro. The front camera is at the top center. The side button is on the right side. The Lightning connector is on the bottom. On the left side, from bottom to top, are the SIM tray, the volume buttons, and the Ring/Silent switch.]

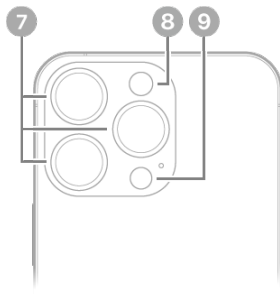

- 7 [Alt text: 7 Rear cameras
- 8 [Alt text: 8 Flash
- 9 [Alt text: 9 LiDAR Scanner

[Alt text: The back view of iPhone 14 Pro. The rear cameras, flash, and LiDAR Scanner are at the top left.]

Get started with iPhone 14 Pro

- [Turn on and set up iPhone](#)
- [Learn gestures for iPhone models with Face ID](#)
- [iPhone camera basics](#)
- [MagSafe chargers and battery packs for iPhone](#)
- [What's new in iOS 18](#)

iPhone 14 Pro Max

Metadata

Summary: Learn the location of the cameras, buttons, and other essential hardware features on iPhone 14 Pro Max.

Learn the location of the cameras, buttons, and other essential hardware features on iPhone 14 Pro Max.

(table aria-label=iPhone 14 Pro Max features)

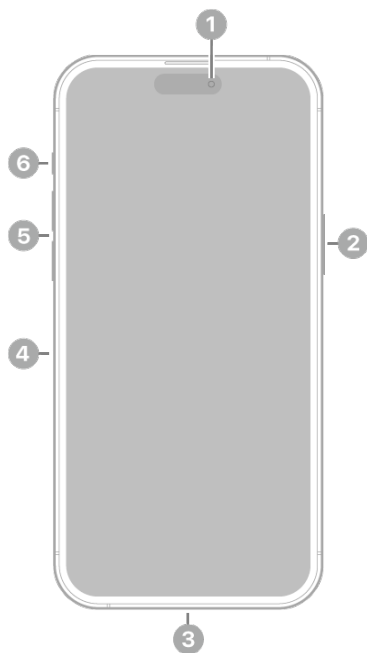

- 1 [Alt text: 1 Front camera
- 2 [Alt text: 2 Side button
- 3 [Alt text: 3 Lightning connector
- 4 [Alt text: 4 SIM tray (available on models purchased outside the U.S.)
- 5 [Alt text: 5 Volume buttons
- 6 [Alt text: 6 Ring/Silent switch

[Alt text: The front view of iPhone 14 Pro Max. The front camera is at the top center. The side button is on the right side. The Lightning connector is on the bottom. On the left side, from bottom to top, are the SIM tray, the volume buttons, and the Ring/Silent switch.]

- 7 [Alt text: 7 Rear cameras
- 8 [Alt text: 8 Flash
- 9 [Alt text: 9 LiDAR Scanner

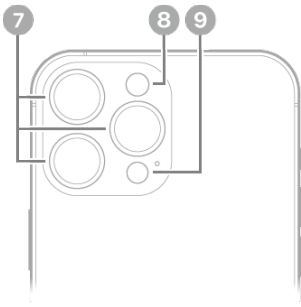

[Alt text: The back view of iPhone 14 Pro Max. The rear cameras, flash, and LiDAR Scanner are at the top left.]

Get started with iPhone 14 Pro Max

- [Turn on and set up iPhone](#)
- [Learn gestures for iPhone models with Face ID](#)
- [iPhone camera basics](#)
- [MagSafe chargers and battery packs for iPhone](#)
- [What's new in iOS 18](#)

iPhone 15

Metadata

Summary: Learn the location of the cameras, buttons, and other essential hardware features on iPhone 15.

Learn the location of the cameras, buttons, and other essential hardware features on iPhone 15.

(table aria-label=iPhone 15 features)

-
- 1 [Alt text: 1] Front camera
 - 2 [Alt text: 2] Side button
 - 3 [Alt text: 3] USB-C connector
 - 4 [Alt text: 4] SIM tray (available on models purchased outside the U.S.)
 - 5 [Alt text: 5] Volume buttons
 - 6 [Alt text: 6] Ring/Silent switch

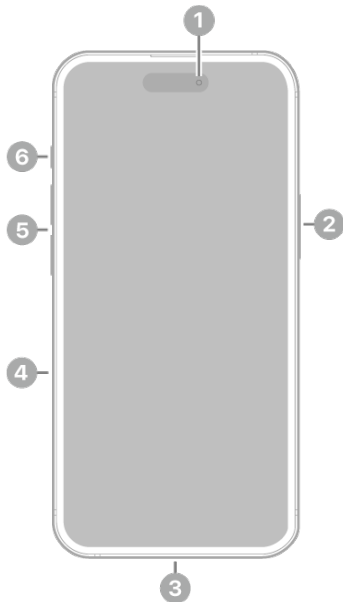

[Alt text: The front view of iPhone 15. The front camera is at the top center. The side button is on the right side. The Lightning connector is on the bottom. On the left side, from bottom to top, are the SIM tray, the volume buttons, and the Ring/Silent switch.]

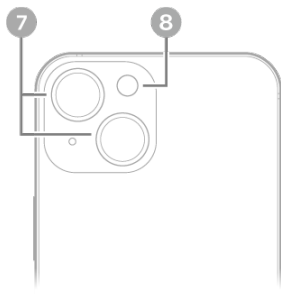

7 [Alt text: 7 Rear cameras

8 [Alt text: 8 Flash

[Alt text: The back view of iPhone 15. The rear cameras and flash are at the top left.]

Get started with iPhone 15

- [Turn on and set up iPhone](#)
- [Learn gestures for iPhone models with Face ID](#)
- [iPhone camera basics](#)
- [MagSafe chargers and battery packs for iPhone](#)
- [What's new in iOS 18](#)

iPhone 15 Plus

Metadata

Summary: Learn the location of the cameras, buttons, and other essential hardware features on iPhone 15 Plus.

Learn the location of the cameras, buttons, and other essential hardware features on iPhone 15 Plus.

(table aria-label=iPhone 15 Plus features)

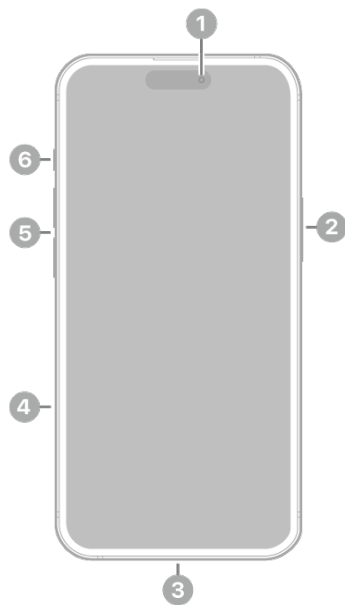

- 1 [Alt text: 1 Front camera
- 2 [Alt text: 2 Side button
- 3 [Alt text: 3 USB-C connector
- 4 [Alt text: 4 SIM tray (available on models purchased outside the U.S.)
- 5 [Alt text: 5 Volume buttons
- 6 [Alt text: 6 Ring/Silent switch

[Alt text: The front view of iPhone 15 Plus. The front camera is at the top center. The side button is on the right side. The Lightning connector is on the bottom. On the left side, from bottom to top, are the SIM tray, the volume buttons, and the Ring/Silent switch.]

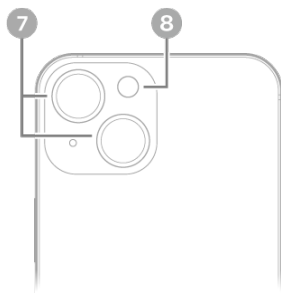

- 7 [Alt text: 7 Rear cameras
- 8 [Alt text: 8 Flash

[Alt text: The back view of iPhone 15 Plus. The rear

cameras and flash are at the top left.¹

Get started with iPhone 15 Plus

- [Turn on and set up iPhone](#)
- [Learn gestures for iPhone models with Face ID](#)
- [iPhone camera basics](#)
- [MagSafe chargers and battery packs for iPhone](#)
- [What's new in iOS 18](#)

iPhone 15 Pro

Metadata

Summary: Learn the location of the cameras, buttons, and other essential hardware features on iPhone 15 Pro.

Learn the location of the cameras, buttons, and other essential hardware features on iPhone 15 Pro.

(table aria-label=iPhone 15 Pro features)

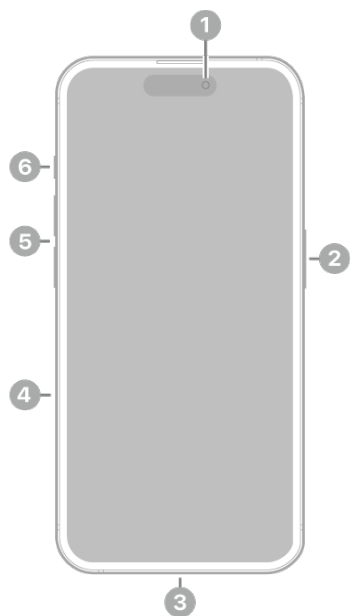

- 1 [Alt text: 1 Front camera
- 2 [Alt text: 2 Side button
- 3 [Alt text: 3 USB-C connector
- 4 [Alt text: 4 SIM tray (available on models purchased outside the U.S.)
- 5 [Alt text: 5 Volume buttons
- 6 [Alt text: 6 Action button

[Alt text: The front view of iPhone 15 Pro. The front

camera is at the top center. The side button is on the right side. The Lightning connector is on the bottom. On the left side, from bottom to top, are the SIM tray, the volume buttons, and the Action button.

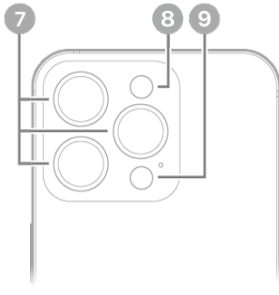

- 7 [Alt text: 7 Rear cameras
- 8 [Alt text: 8 Flash
- 9 [Alt text: 9 LiDAR Scanner

[Alt text: The back view of iPhone 15 Pro. The rear cameras, flash, and LiDAR Scanner are at the top left.]

Get started with iPhone 15 Pro

- [Turn on and set up iPhone](#)
- [Learn gestures for iPhone models with Face ID](#)
- [Use and customize the Action button on iPhone](#)
- [iPhone camera basics](#)
- [MagSafe chargers and battery packs for iPhone](#)
- [What's new in iOS 18](#)

iPhone 15 Pro Max

Metadata

Summary: Learn the location of the cameras, buttons, and other essential hardware features on iPhone 15 Pro Max.

Learn the location of the cameras, buttons, and other essential hardware features on iPhone 15 Pro Max.

(table aria-label=iPhone 15 Pro Max features)

- 1 [Alt text: 1 Front camera
- 2 [Alt text: 2 Side button

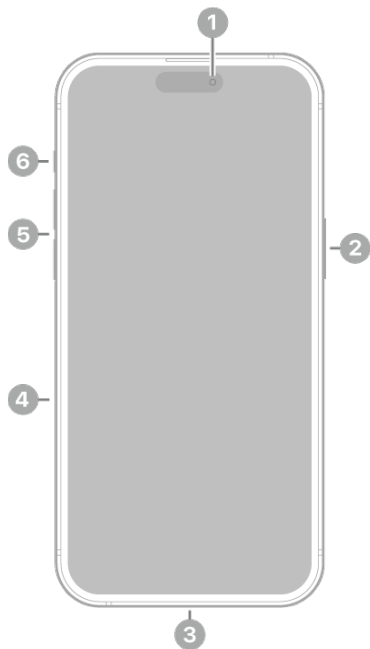

- ③ [Alt text: 3 USB-C connector
- ④ [Alt text: 4 SIM tray (available on models purchased outside the U.S.)
- ⑤ [Alt text: 5 Volume buttons
- ⑥ [Alt text: 6 Action button

[Alt text: The front view of iPhone 15 Pro Max. The front camera is at the top center. The side button is on the right side. The Lightning connector is on the bottom. On the left side, from bottom to top, are the SIM tray, the volume buttons, and the Action button.]

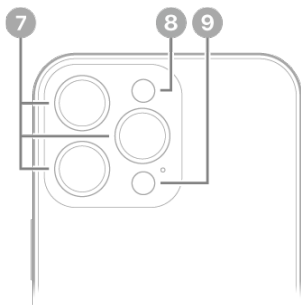

- ⑦ [Alt text: 7 Rear cameras
- ⑧ [Alt text: 8 Flash
- ⑨ [Alt text: 9 LiDAR Scanner

[Alt text: The back view of iPhone 15 Pro Max. The rear cameras, flash, and LiDAR Scanner are at the top left.]

Get started with iPhone 15 Pro Max

- [Turn on and set up iPhone](#)
- [Learn gestures for iPhone models with Face ID](#)
- [Use and customize the Action button on iPhone](#)
- [iPhone camera basics](#)
- [MagSafe chargers and battery packs for iPhone](#)

- [What's new in iOS 18](#)

What's new

What's new in iOS 18

Metadata

Summary: iOS is now faster and more responsive on all supported devices. Learn about the new features in iOS 18.

Personalize your Home Screen. Arrange apps and widgets on your Home Screen and change their size. Tint apps your favorite color, or have iPhone suggest a color that complements your wallpaper. See [Customize apps and widgets on the iPhone Home Screen](#).

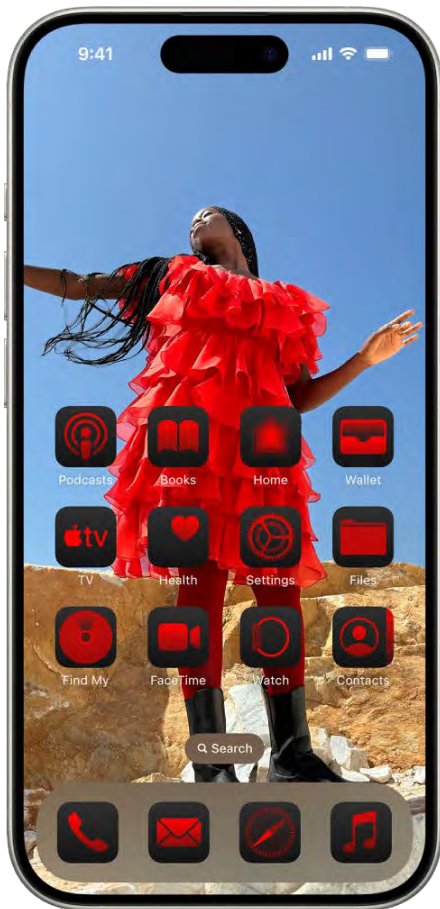

[Alt text: The iPhone Home Screen. Apps appear in the same color at the bottom of the screen, and compliment the color in the wallpaper photo.]

Lock and hide apps. Protect sensitive apps and the information inside them by locking or hiding them. When you lock an app on your Home Screen, Face ID, Touch ID, or your passcode is required to open it. Hide an app from your Home Screen in a hidden apps folder that's locked. Information stored in locked or hidden apps won't appear in other places on your iPhone, such as notifications and search. See [Lock or hide an app on iPhone](#).

Change Lock Screen controls. Swap out the controls at the bottom of the Lock Screen for other options—like opening the Notes app when an idea strikes or quickly adding an item to your To do list in Reminders. See [Change the controls at the bottom of the Lock Screen](#).



[Alt text: The iPhone Lock Screen. The controls at the bottom-left and bottom-right corner of the screen are customized.]

Control Center. The redesigned Control Center features new groups of controls so you can quickly take actions on more features. The controls gallery displays all your options in one place, including controls from your favorite apps. See [Use and customize Control Center on iPhone.](#)

- COMMENT - #ba #music



[Alt text: The iPhone Control Center.]

Photos. The redesigned Photos app puts your photo library at your fingertips, so you spend less time searching and more time enjoying your memories. Your photos are organized by topic such as Recent Days, Trips, People & Pets, and more. Use Pinned Collections to quickly access the collections or albums most important to you. And you can customize the app to make Photos even more personal and useful. See [Get started with Photos on iPhone](#).

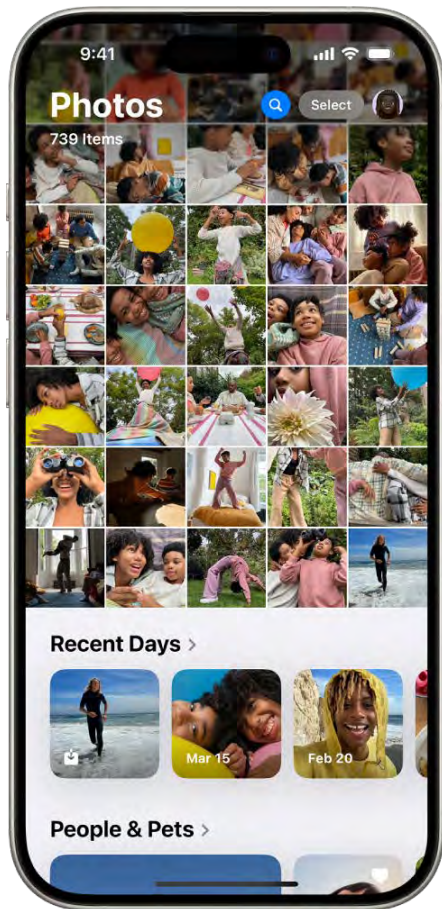

[Alt text: The Photos app showing the Library photo grid. At the bottom of the screen are the the Recent Days and People & Pets sections.]

Messages. Add text effects such as bold, italics, underline, and strikethrough to emphasize your messages, or apply animated effects to any letter, word, phrase, or emoji—many of which are automatically suggested as you type. React to messages in new ways by using any emoji or sticker as a Tapback reaction. Schedule a message to send at a specified time and use satellite capabilities to stay connected when you're without Wi-Fi or cellular coverage. See [Style and animate messages on iPhone](#), [React with Tapbacks in Messages on iPhone](#), [Schedule a message on iPhone to send later](#), and [Send a text message via satellite on iPhone](#).



[Alt text: A conversation in the Messages app. A message is selected and shows Tapback options that include emoji.]

Safari. Safari automatically detects relevant information on a page and highlights it as you browse. Highlights display helpful information like maps, translations, and links to learn more about what you're viewing. A redesigned reader view includes a table of contents and high-level summary to get the gist of an article before reading on. See [See a webpage's highlights in Safari on iPhone](#) and [Hide distractions when reading articles in Safari on iPhone](#).

- COMMENT - #ba #websites

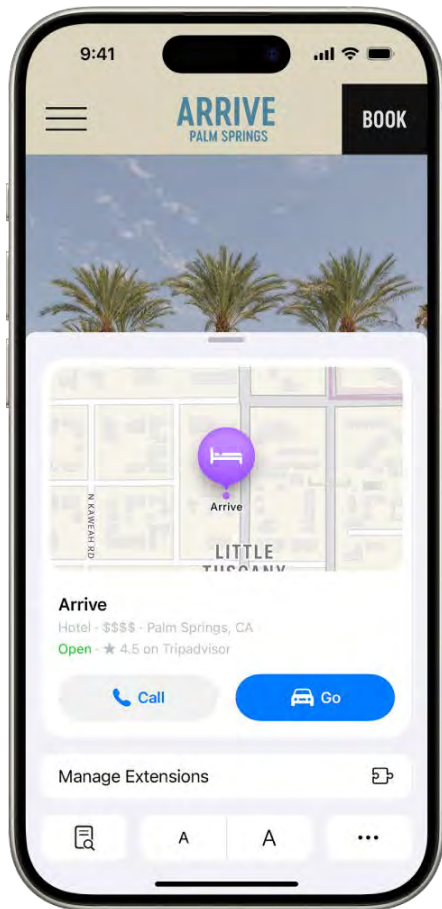

[Alt text: A hotel webpage is open in Safari. At the bottom of the screen is a map, a button to call the hotel, and a button for driving directions.]

Passwords. A new app that safely stores all of your passwords, account credentials, and verification codes in one place. If you use AutoFill, the passwords you generate are automatically added to the Passwords app. See [Find your password for a website or app on iPhone](#) and [View your passwords and related information on iPhone](#).

- COMMENT - #ba #apps

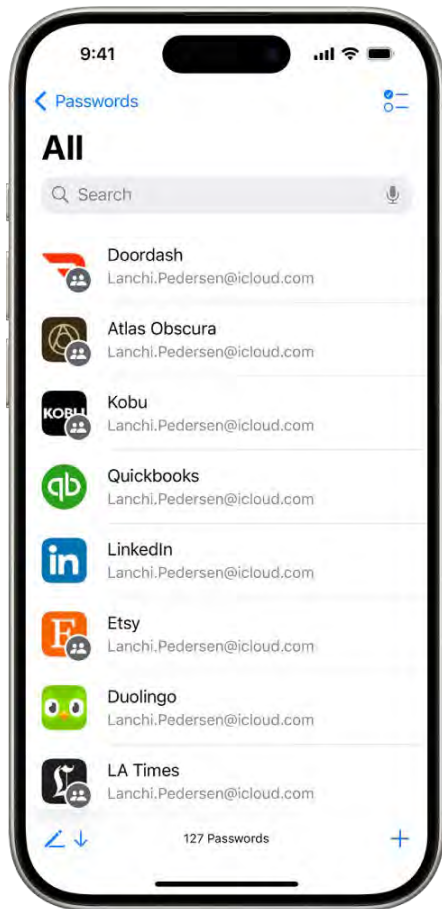

[Alt text: A list of apps in the Passwords app.]

Maps. View topographic maps with detailed trail networks and hikes, including all 63 U.S. national parks. Save hiking maps to your iPhone to access them offline with turn-by-turn voice guidance. You can create custom walking and hiking routes with different route options, such as one way, out and back, or loop. See [Get walking directions in Maps on iPhone](#) and [Save walks or hikes in Maps on iPhone](#).

- COMMENT - #ba #locations

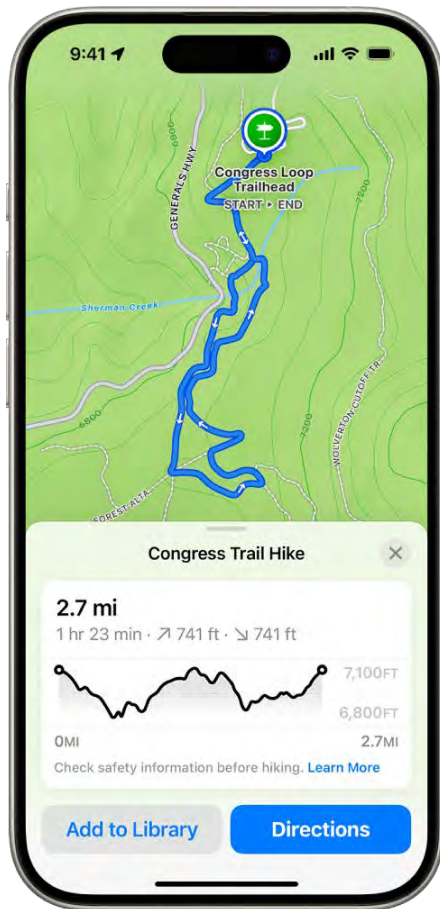

[Alt text: A topographic map in the Maps app showing a hiking trail. At the bottom of the screen are an elevation chart, the Add to Library button, and the Directions button.]

FaceTime. Help friends and family with their devices by tapping and drawing on your screen to point out what they should do on theirs. Or ask for permission to control their device remotely. See [Share your screen in a FaceTime call on iPhone](#) and [Request or give remote control in a FaceTime call on iPhone](#).

P9 **Wallet.** Use Tap to Cash to send and receive Apple Cash by holding your iPhone or Apple Watch near the other person's iPhone or Apple Watch, without having to share phone numbers. Event tickets include an event guide about the venue with recommendations from Apple apps. View your rewards or points balances in Wallet and use Apple Pay to pay with rewards or installments. See [Send Apple Cash with Tap to Cash](#), [Use passes in Wallet on iPhone](#), and [Use Apple Pay in apps and on the web on iPhone](#).



[Alt text: The Tap to Cash screen in Wallet, showing \$20 being transferred and Decline and Accept buttons at the bottom of the screen.]

Notes. You can record live audio in a note and have the speech transcribed to text. Make text stand out with color, use collapsible headers in text-heavy sections, and solve mathematical equations instantly with Math Notes. See [Record and transcribe audio in Notes on iPhone](#), [Create and format notes on iPhone](#), and [Enter formulas and equations in Notes on iPhone](#).

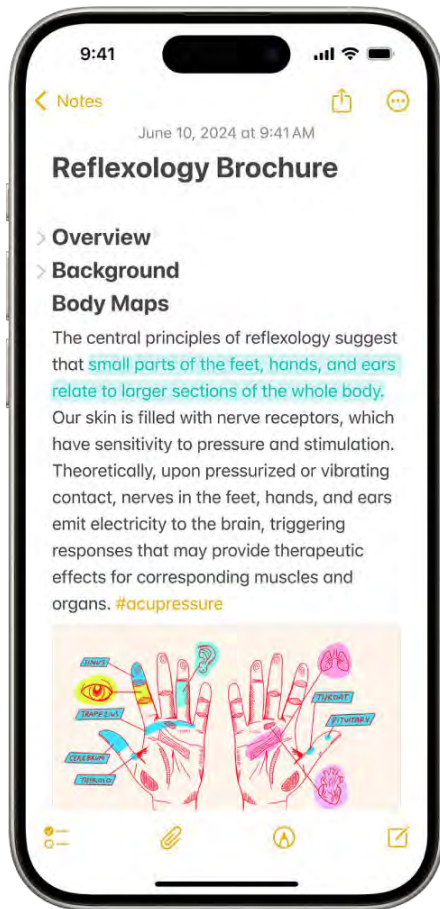

[Alt text: A note in the Notes app with collapsible headers at the top of the screen.]

Journal. Log your state of mind in the Journal app and automatically add the time you spend journaling as mindful minutes in the Health app. Search in Journal to find and sort past entries, and view your writing streaks and other stats to help you reach your journaling goals. See [Journal for your wellbeing on iPhone](#), [View and search your journal entries on iPhone](#), and [Change your Journal settings on iPhone](#).

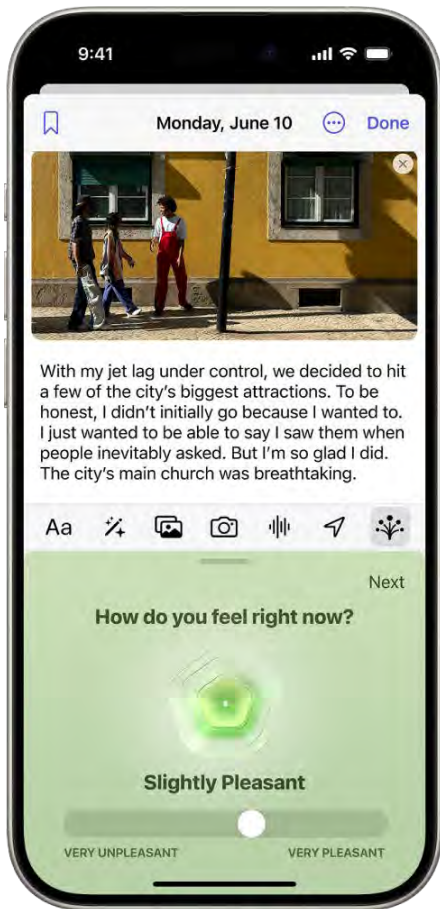

[Alt text: The Journal app showing a journal entry at the top of the screen. At the bottom of the screen is a slider to log your state of mind.]

Apple TV. Use InSight to learn more about the actors and music as a show or movie is playing and Enhance Dialogue to help hear what's being said onscreen. See [Go to Info, InSight, and Up Next](#), and [Change audio options during playback](#).

- COMMENT - #ba #tv

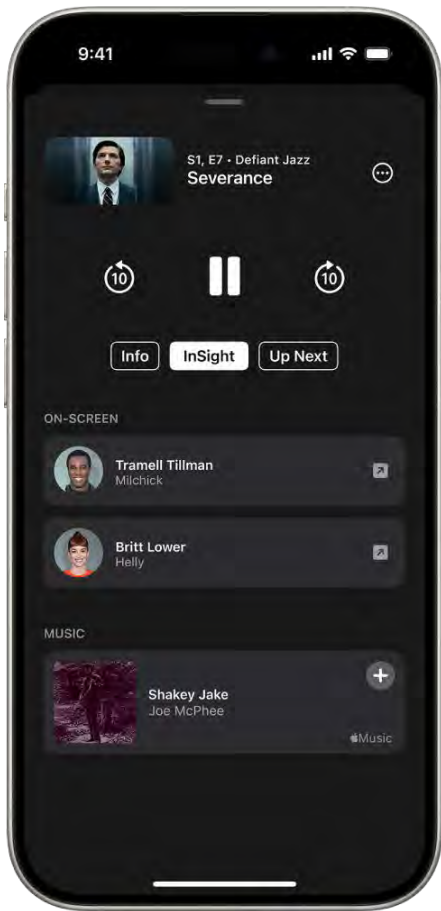

[Alt text: The InSight screen in the Apple TV app that shows the actors and music playing in the show above.]

Home. Give guests scheduled access to specific controls in your home such as garage openers, alarm systems, and door locks. See [Invite guests to control accessories.](#)

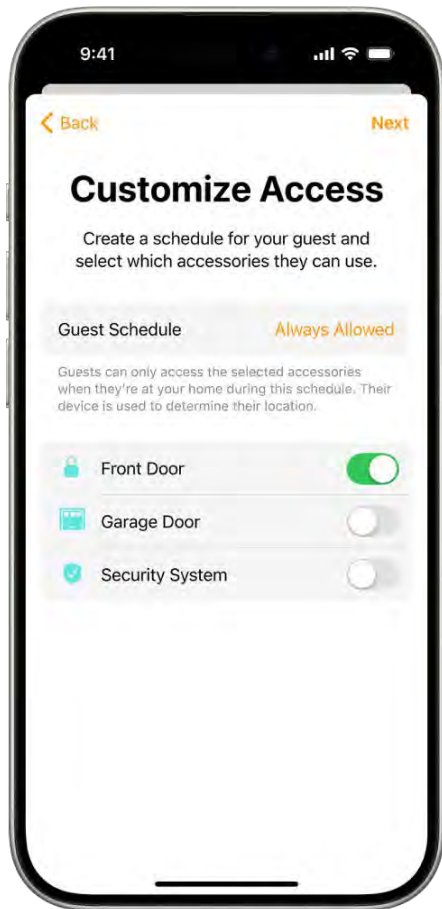

[Alt text: The Customize Access screen in the Home app. At the top of the screen is the Guest Schedule and below that are accessories the guest may or may not access.]

Privacy and Security. Redesigned Privacy and Security settings help you manage how much information you share with apps, and you can decide specific contacts you want to share with an app instead of your entire contact list. See [Control access to information in apps on iPhone](#) and [Control access to your contacts on iPhone](#).



[Alt text: The Privacy & Security screen in Settings.]

Accessibility. Eye Tracking makes it possible for people to control iPhone with just their eyes. Music Haptics syncs the iPhone Taptic Engine with the rhythm of songs and Vocal Shortcuts helps people with severe atypical speech record sounds that trigger specific actions on iPhone. See [Control iPhone with the movement of your eyes](#), [Play music on iPhone as taps, textures, and more](#), and [Use Vocal Shortcuts on iPhone](#).

Emergency SOS Live Video. Share streaming video and recorded media during emergency calls, making it easier and faster to get the help you need. See [Send photos or video to emergency services](#).

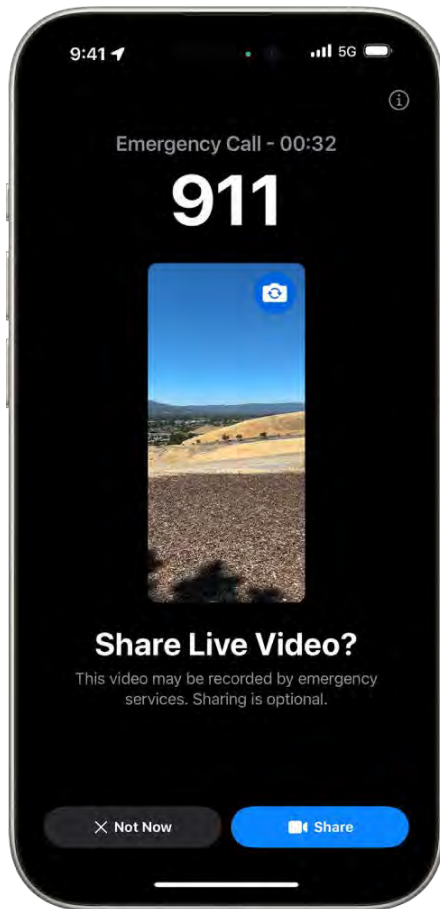

[Alt text: An Emergency SOS Live Video screen showing a 911 phone emergency call with a video preview in the middle. At the bottom are buttons for Not Now and Share Video.]

Freeform. Scenes let you organize and present your board section by section. Send a copy of your board to anyone with just a link. An improved diagramming mode makes it easier to form connections on your canvas. See [Navigate and present scenes in your Freeform boards on iPhone](#), [Send a copy or PDF of a Freeform board on iPhone](#), and [Add diagrams to a Freeform board on iPhone](#).

Calculator. Use new tools like history and unit conversions. Type or write out math with Math Notes to evaluate expressions, assign variables, plot graphs, and more. See [See previous calculations in Calculator on iPhone](#), [Convert units or currency in Calculator on iPhone](#), and [Solve math with Math Notes in Calculator on iPhone](#).

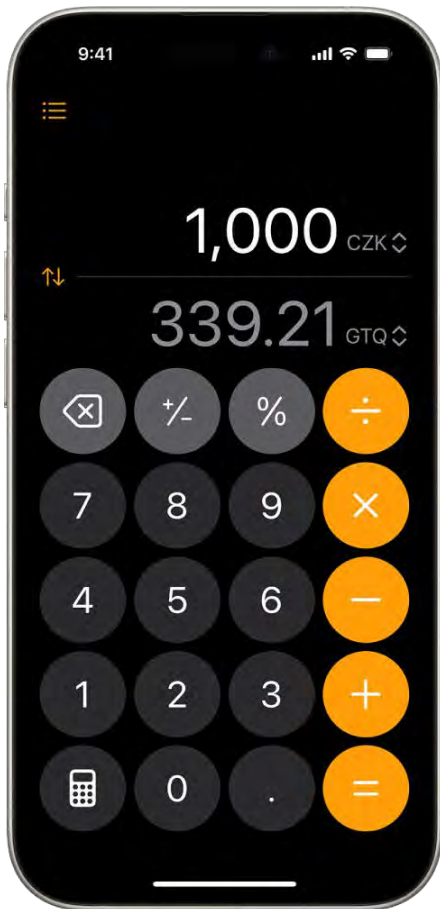

[Alt text: The basic calculator with a currency conversion.]

Calendar. A redesigned month view makes it easier to get an overview of your month ahead. And you can create, view, edit, and complete reminders from the Reminders app right in Calendar. See [Change how you view events in Calendar on iPhone](#) and [Use reminders in Calendar on iPhone](#).



[Alt text: The month view in the Calendar app.]

Learn tricks for iOS 18. The Tips app adds new suggestions regularly, so you can get the most from your iPhone. See [Get tips](#).

Note: New features and apps may vary depending on your iPhone model, region, language, and carrier.

Set up and get started

Turn on and set up iPhone

Metadata

Summary: Turn on and set up iPhone with an internet connection. If you have another iPhone,

iPad, or Android device, you can transfer your data to your new iPhone.

You can turn on and set up your new iPhone with an internet connection. You can also set up iPhone by connecting it to your computer. If you have another iPhone, an iPad, or an Android device, you can transfer your data to your new iPhone.

Note: If your iPhone is deployed or managed by a company or other organization, see an administrator for setup instructions. For general information, see the [Apple at Work website](#).

Prepare for setup

To make setup as smooth as possible, have the following items available:

- An internet connection through a Wi-Fi network (you may need the name and password of the network) or cellular data service through a carrier (not required for iPhone 14 and later models)
- Your [Apple Account](#) and password; if you don't have an Apple Account, you can create one during setup
- Your credit or debit card account information, if you want to add a card to Apple Pay during setup
- Your previous iPhone or a [backup of your device](#), if you're transferring your data to your new device

Tip: If you don't have sufficient storage space to back up your device, iCloud will provide enough storage to complete a temporary backup, free of charge, for up to three weeks from the purchase of your iPhone. On your previous device, go to Settings > General > Transfer or Reset [*device*]. Tap Get Started, then follow the onscreen instructions.

- Your Android device, if you're transferring your Android content

Turn on and set up your iPhone

1. Press and hold the side button until the Apple logo appears.

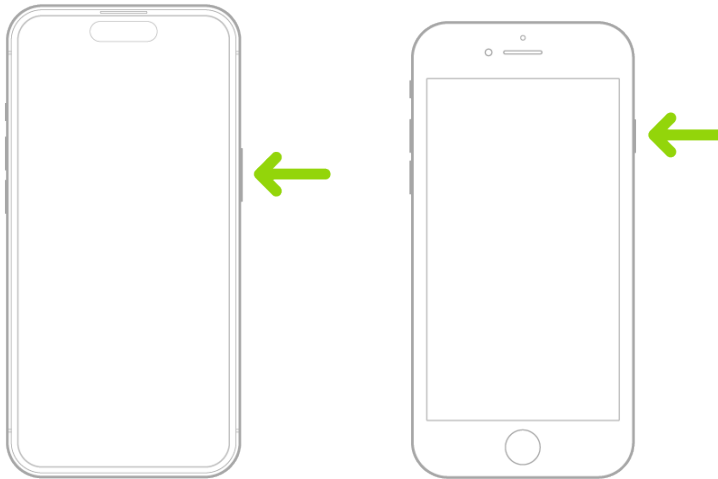

[Alt text: A green arrow pointing to the button on the right side of iPhone.]

If iPhone doesn't turn on, you might need to [charge the battery](#). For more help, see the Apple Support article [If your iPhone won't turn on or is frozen](#).

Tip: If you're blind or have low vision, you can triple-click the side button (on an iPhone with Face ID) or triple-click the Home button (on other iPhone models) to turn on VoiceOver, the screen reader. You can also double-tap the screen with three fingers to turn on Zoom. See [Get started with accessibility features](#).

2. Do one of the following:

- *Use Quick Start:* If you have another iPhone or iPad with iOS 11, iPadOS 13, or later, you can use Quick Start to automatically set up your new device. Bring the two devices close together, then follow the onscreen instructions to securely copy many of your settings, preferences, and iCloud Keychain. You can then restore the rest of your data and content to your new device from your iCloud backup.

Or, if both devices have iOS 12.4, iPadOS 13, or later, you can transfer all your data wirelessly from your previous device to your new one. Keep your devices near each other and plugged into power until the migration process is complete.

- *Set Up Manually:* If you don't have another device, tap Set Up Without Another Device, then follow the onscreen setup instructions.

Move from an Android device to iPhone

If you have an Android device, you can transfer your data with the Move to iOS app when you first set up your new iPhone.

Note: If you already completed setup and want to use Move to iOS, you must erase your iPhone and start over, or move your data manually. See the Apple Support article [Move content manually from your Android device to your iPhone or iPad](#).

1. On your device with Android version 4.0 or later, see the Apple Support article [Move from Android to iPhone or iPad](#) and download the Move to iOS app.

2. On your iPhone, do the following:
 - Follow the setup assistant.
 - On the Transfer Your Apps & Data screen, tap From Android.
3. On the Android device, do the following:
 - Turn on Wi-Fi.
 - Open the Move to iOS app.
 - Follow the onscreen instructions.

WARNING: To avoid injury, read [Important safety information](#) before using iPhone.

Related

[Wake, unlock, and lock iPhone](#)

[Connect iPhone and your computer with a cable](#)

[Apple Support article: How to remove Activation Lock](#)

[Apple Support article: Help your child set up an iPhone or iPad](#)

NAV TITLE: [Wake, unlock, and lock](#)

Wake, unlock, and lock iPhone

Metadata

Summary: To save power, iPhone locks and goes to sleep when you're not using it. Learn how to wake and unlock iPhone when you want to use it again.

iPhone turns off the display to save power, locks for security, and goes to sleep when you're not using it. You can quickly wake and unlock iPhone when you want to use it again.

Wake iPhone

To wake iPhone, do one of the following:

- Press the side button.

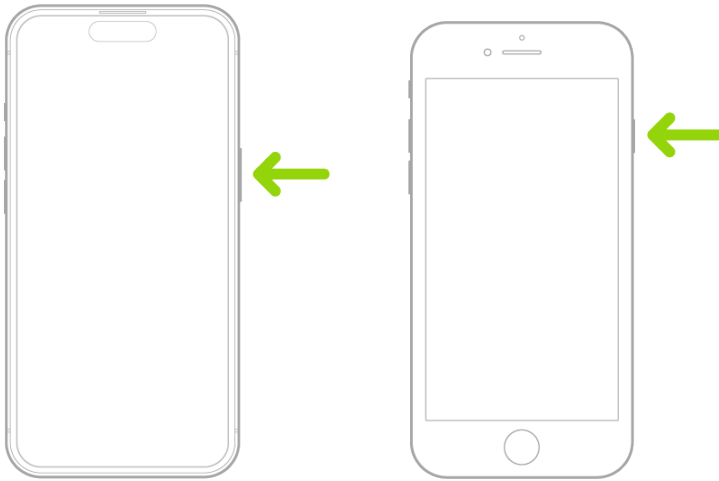

[Alt text: A green arrow pointing to the button on the right side of iPhone.]

- Raise iPhone.

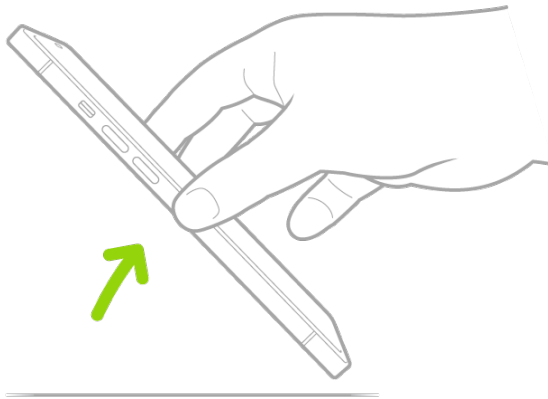

[Alt text: A hand lifting iPhone from a flat surface.]

Note: To turn off Raise to Wake, go to Settings  [ALT N/A] > Display & Brightness.

- Tap the screen (not available on iPhone SE).



[Alt text: A finger tapping the screen to wake iPhone.]

Unlock iPhone with Face ID

If you have an [iPhone with Face ID](#), but you didn't turn on Face ID during setup, see [Set up Face ID](#). Then follow these steps:

1. Tap the screen or raise iPhone to wake it, then glance at your iPhone.

The lock icon animates from closed to open to indicate that iPhone is unlocked.

2. Swipe up from the bottom of the screen.

Note: To lock iPhone again, press the side button. iPhone locks automatically if you don't touch the screen for a minute or so. However, if Attention Aware Features is turned on in Settings  [ALT N/A] > Face ID & Passcode, iPhone won't dim or lock as long as it detects attention.

Unlock iPhone with Touch ID

If you have an iPhone with a Home button, but you didn't turn on Touch ID during setup, see [Set up Touch ID](#). Then follow these steps:

1. To unlock iPhone, press the Home button using the finger you registered with Touch ID.
2. To lock iPhone again, press the side button.

Note: iPhone locks automatically if you don't touch the screen for a minute or so.



[Alt text: The Home button (Touch ID) at the bottom of iPhone.]

Unlock iPhone with a passcode

If you didn't create a passcode when you set up iPhone, see [Set a passcode](#). Then follow these steps:

1. Swipe up from the bottom of the Lock Screen (on an iPhone with Face ID) or press the Home button (on other iPhone models).
2. Enter your passcode.

Manually lock iPhone

To quickly lock iPhone, press the side button.

Related

[Unlock iPhone with Apple Watch](#)

[Find settings on iPhone](#)

[Set up cellular service on iPhone](#)

NAV TITLE: [Set up cellular service](#)

Set up cellular service on iPhone

Metadata

Summary: The cellular connection on your iPhone requires an eSIM or a physical SIM from a cellular provider.

P9 Your iPhone needs a physical SIM or an eSIM to connect to a cellular network. (Not all options are available on all models or in all countries and regions. On iPhone 14 and later models purchased in the U.S., you can only use eSIM.) Contact your carrier to get a SIM and set up cellular service.

P10 Your iPhone needs a physical SIM to connect to a cellular network. Contact your carrier to get a SIM and set up cellular service. - COMMENT - #zhcn

Set up an eSIM

Supported iPhone models can digitally store an eSIM provided by your carrier. If your carrier supports either eSIM Carrier Activation or eSIM Quick Transfer, you can turn on your iPhone and follow the instructions to activate your eSIM during setup.

If you already completed setup, you can do any of the following:

- *eSIM Carrier Activation:* Some carriers can assign a new eSIM directly to your iPhone; contact your carrier to initiate this process. When you receive the “Finish Setting Up Cellular” notification, tap it. Or go to Settings  [ALT N/A] > Cellular, then tap Set Up Cellular or Add eSIM.
- *eSIM Quick Transfer:* Some carriers support transferring a phone number from your previous iPhone to your new iPhone without needing to contact them (requires iOS 16 or later on both devices).

On your new iPhone, go to Settings > Cellular, tap Set Up Cellular or Add eSIM, then tap Transfer From Nearby iPhone or choose a phone number. On your previous iPhone, follow the instructions to confirm the transfer.

Note: After your phone number is transferred to your new iPhone, it stops working on your previous iPhone.

- *Scan a QR Code provided by your carrier:* Go to Settings > Cellular, tap Set Up Cellular or Add eSIM, then tap Use QR Code. (You may need to tap Other Options first.) Position iPhone so the QR code appears in the frame, or enter the details manually. You may be asked to enter a confirmation code provided by your carrier.
- *Transfer from a different smartphone:* If your previous phone isn’t an Apple iPhone, contact your carrier to transfer the phone number.
- *Activate service through a participating carrier’s app:* Go to the App Store, download the carrier’s app, then use the app to activate cellular service.

Note: If prompted, connect your iPhone to an available Wi-Fi or cellular network. eSIM setup requires an internet connection.

Install a physical SIM

You can get a nano-SIM card from a carrier or move it from your previous iPhone.

Note: Physical SIM isn’t compatible with iPhone 14 and later models purchased in the U.S.

1. Insert a paper clip or SIM eject tool into the small hole of the SIM tray, then push in toward iPhone to eject the tray.

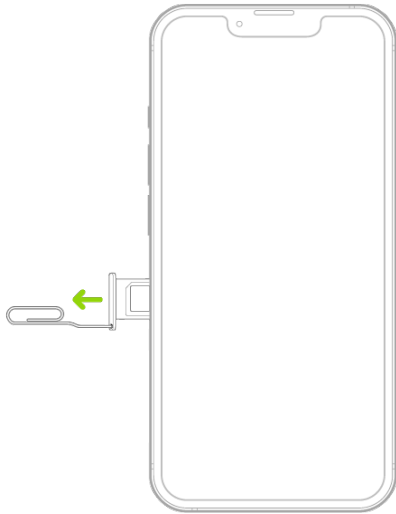

[Alt text: A paper clip or SIM eject tool is inserted into the small hole of the tray on the left side of iPhone to eject and remove the tray.]

Note: The shape and orientation of the SIM tray depend on the iPhone model and your country or region.

2. Remove the tray from iPhone.
3. Place the SIM in the tray. The angled corner determines the correct orientation.

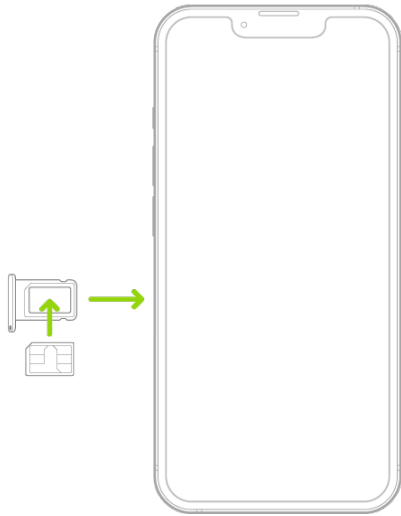

[Alt text: A SIM being inserted into the tray on iPhone; the angled corner is in the upper left.]

4. Insert the tray back into iPhone.
5. If you previously set up a PIN on the SIM, carefully enter the PIN when prompted.

WARNING: Never try to guess a SIM PIN. An incorrect guess can permanently lock your SIM, and you won't be able to make phone calls or use cellular data through your carrier until you get a new SIM. See the Apple Support article [Use a SIM PIN for your iPhone or iPad](#).

P10 [See also Install two physical SIMs.](#)

P9

Convert a physical SIM to an eSIM

If your carrier supports it, you can convert a physical SIM to an eSIM on a [supported iPhone model](#).

1. Go to Settings  [ALT N/A] > Cellular, tap Set Up Cellular or Add eSIM, then choose the phone number with a physical SIM.
2. Tap Convert to eSIM, then follow the onscreen instructions.

Important: The availability of cellular capabilities depends on the wireless network, your iPhone model, and your location.

Consider applicable data, voice, and roaming charges when managing your cellular plans, especially when you travel with iPhone. See [View or change cellular data settings](#).

Some carriers let you unlock iPhone for use with another carrier (additional fees may apply). Contact your carrier for authorization and setup information. See the Apple Support article [How to unlock your iPhone for use with a different carrier](#).

Related

[Connect to a cellular network if Wi-Fi isn't available](#)

[Use Dual SIM on iPhone](#)

[Apple Support article: About eSIM on iPhone](#)

[Apple Support article: Use eSIM while traveling internationally with your iPhone](#)

NAV TITLE: [Use Dual SIM](#)

Use Dual SIM on iPhone

Metadata

Summary: You can use Dual SIM on certain iPhone models.

Here are some of the many ways you can use Dual SIM:

- Use one number for business and another number for personal calls.
- Add a local data plan when you travel to another country or region.
- Have separate voice and data plans.

Note: To use two different carriers, your iPhone must be unlocked. See the Apple Support article [How to unlock your iPhone for use with a different carrier](#).

P9 You can set up Dual SIM with the following:

- P9
- One physical SIM and one eSIM; available on iPhone XR, iPhone XS, iPhone 11, iPhone 12, iPhone 13, iPhone SE (2nd generation), and iPhone 14 and later (purchased outside the U.S.)
- Two eSIMs; iPhone 13, iPhone SE (3rd generation), and later

P9 **Note:** eSIM isn't available in certain countries or regions.

P10 You can set up Dual SIM with the following: - COMMENT - #zhcn

- P10
- Two physical SIMs; available in China mainland, Hong Kong, and Macao on supported iPhone models
- One physical SIM and one eSIM; available in Hong Kong and Macao on iPhone XS, iPhone 12 mini, iPhone 13 mini, and iPhone SE (2nd and 3rd generation)

P10

Install two physical SIMs

- COMMENT - #zhcn

On a supported iPhone model, you can use Dual SIM with two nano-SIM cards.

1. Insert a paper clip or SIM eject tool into the small hole of the SIM tray, then push in toward iPhone to eject the tray.
2. Remove the tray from iPhone.
3. Place a SIM in the back position of the tray, then place the other SIM in the front position. The angled corner determines the correct orientation of each SIM.

Important: If your SIMs are protected with a personal identification number (PIN), note the position—front or back—of each SIM in the tray.

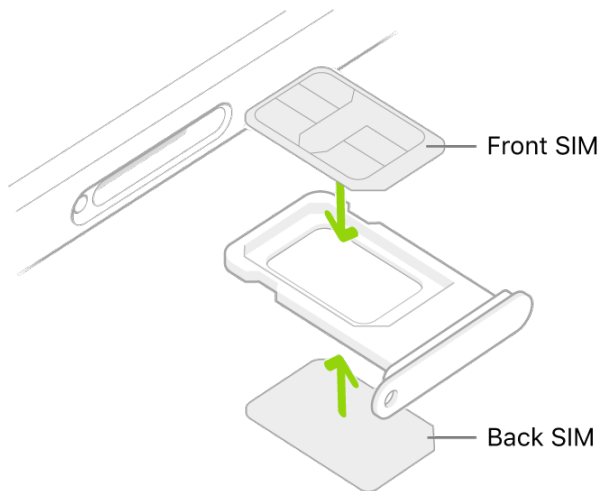

[Alt text: A tray that can hold a SIM on the front side and a second SIM on the back side.]

Note: The shape and orientation of the SIM tray depend on the iPhone model and your country or region.

4. Insert the tray back into iPhone.
5. If prompted, carefully enter the PINs for the front SIM and back SIM.

WARNING: Never try to guess a SIM PIN. An incorrect guess can permanently lock your SIM, and you won't be able to make phone calls or use cellular data through your SIM until you get a new SIM. See the Apple Support article [Use a SIM PIN for your iPhone or iPad](#).

For more help, see the Apple Support article [If Dual SIM with two nano-SIM cards isn't working on your iPhone](#).

Set up Dual SIM

1. Go to Settings  [ALT N/A] > Cellular, then make sure you have at least two lines (below SIMs). To add a line, see [Set up cellular service](#).
2. Turn on two lines—tap a line, then tap Turn On this Line.

You can also change settings such as Cellular Plan Label, Wi-Fi Calling (if available from your carrier), Calls on Other Devices, or SIM PIN. The label appears in Phone, Messages, and Contacts.
3. Choose the default line for cellular data—tap Cellular Data, then tap a line. To use either line depending on coverage and availability, turn on Allow Cellular Data Switching.

You may incur roaming charges if Data Roaming is on and you're outside the country or region covered by the carrier's network.
4. Choose the default line for voice calls—tap Default Voice Line, then tap a line.

When using Dual SIM, note the following:

- Wi-Fi Calling must be turned on for a line to enable that line to receive calls while the other line is in use for a call. If you receive a call on one line while the other is in use for a call, and no Wi-Fi connection is available, iPhone uses the cellular data of the line that is in use for the call to receive the other line's call. Charges may apply. The line that is in use for the call must be permitted for data use in your Cellular Data settings (either as the default line, or as the non-default line with Allow Cellular Data Switching turned on) to receive the other line's call.
- If you don't turn on Wi-Fi Calling for a line, any incoming phone calls on that line (including calls from emergency services) go directly to voicemail (if available from your carrier) when the other line is in use; you won't receive missed call notifications.

If you set up conditional call forwarding (if available from your carrier) from one line to another when a line is busy or not in service, the calls don't go to voicemail; contact your carrier for setup information.

- If you make a phone call from another device, such as your Mac, by relaying it through your iPhone with Dual SIM, the call is made using your default voice line.
- If you start an SMS/MMS Messages conversation using one line, you can't switch the conversation to your other line; you need to delete the conversation and start a new conversation using the other line. Also, you may incur additional charges if you send SMS/MMS attachments on the line that's not selected for cellular data.
- Instant Hotspot and Personal Hotspot use the line selected for cellular data.

Related

[Connect to a cellular network if Wi-Fi isn't available](#)
[View or change cellular data settings on iPhone](#)

NAV TITLE: [Connect to the internet](#)

Connect iPhone to the internet

Metadata

Summary: Connect iPhone to the internet by using an available Wi-Fi or cellular network. Change your data connection in Settings.

Connect your iPhone to the internet by using an available Wi-Fi or cellular network.

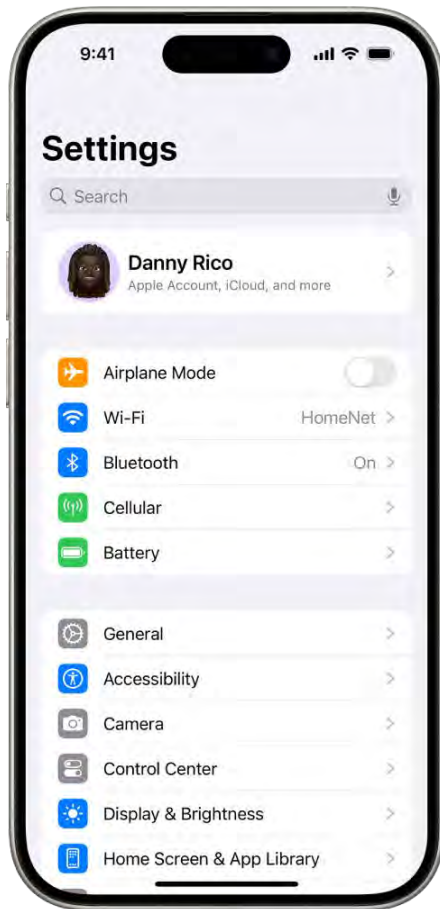

[Alt text: The Settings screen showing that iPhone is connected to a Wi-Fi network called HomeNet.]

View available networks and connect to Wi-Fi

1. Go to Settings  [ALT N/A] > Wi-Fi, then turn on Wi-Fi.

iPhone automatically joins known networks.

2. To join a new network, do one of the following:

- *Join an available network:* Tap the name of the network. If asked, enter the password.
- *Join a hidden network:* Tap Other, then enter the name of the network, security type, and password.



When iPhone is connected to Wi-Fi, a blue checkmark appears next to the network name, and  [Alt text: the Wi-Fi icon appears at the top of the screen.]

Join a Personal Hotspot

If an iPhone or iPad with cellular service is [sharing a Personal Hotspot](#), you can use its cellular connection.

1. Go to Settings  [ALT N/A] > Wi-Fi, then choose the name of the device sharing the Personal Hotspot.
2. If asked, enter the password. (On the device sharing the Personal Hotspot, the password is shown in Settings > Cellular > Personal Hotspot.)

Manage settings for Wi-Fi and hotspots

1. Go to Settings  [ALT N/A] > Wi-Fi.
2. Do any of the following:
 - *Change the settings for a Wi-Fi network:* Tap  (Alt text: the Info button) .
 - *Join a new Wi-Fi network:* Tap Ask to Join Networks, then choose Off, Notify, or Ask.
 - *Join a personal hotspot when Wi-Fi isn't available:* Tap Auto-Join Hotspot, then choose Never, Ask to Join, or Automatic.

Connect to a cellular network if Wi-Fi isn't available

Your iPhone automatically connects to your carrier's cellular data network if a Wi-Fi network isn't available. If iPhone doesn't connect, check the following:

1. Verify that your SIM is activated and unlocked. See [Set up cellular service](#).
2. Go to Settings  [ALT N/A] > Cellular.
3. Verify that Cellular Data is turned on. If you're [using Dual SIM](#), tap Cellular Data, then verify the selected line. (You can choose only one line for cellular data.)

How iPhone connects to the internet

iPhone does the following, in order, until a connection is made:

- Tries to connect to the most recently used available Wi-Fi network
- Shows a list of Wi-Fi networks in range and connects to the one you choose
- Connects to your carrier's cellular data network

On an [iPhone that supports 5G](#), iPhone may use your 5G cellular data instead of Wi-Fi. If so, you see Using 5G Cellular For Internet below the Wi-Fi network's name. To switch back to Wi-Fi, tap  (Alt text: the Info button) next to the network name, then tap Use Wi-Fi for Internet. See the Apple Support article [Use 5G with your iPhone](#).

Note: If a Wi-Fi connection to the internet isn't available, apps and services may transfer data over your carrier's cellular network, which may result in additional fees. Contact your carrier for information about your cellular data rates. To manage cellular data usage, see [View or change cellular data settings](#).

Related

[Protect your web browsing with iCloud Private Relay on iPhone](#)

[Learn the meaning of the iPhone status icons](#)

Apple Account and iCloud

NAV TITLE: [Sign in and manage your Apple Account](#)

Sign in and manage your Apple Account on iPhone

Metadata

Summary: On iPhone, sign in to your Apple Account to access Apple services such as the App Store, FaceTime, iCloud, iMessage, and more. Add or edit payment methods for Apple media purchases and services.

Your Apple Account gives you access to Apple services such as the App Store, the iTunes Store, Apple Books, Apple Music, FaceTime, iCloud, iMessage, and more.

P10 [When you create a new Apple Account in China, you can use your mobile phone number to sign in. If you have an iPhone with Dual SIM, you can choose either phone number for your Apple Account. See the Apple Support article \[Use your mobile phone number as your Apple Account\]\(#\). - COMMENT - #zhcn](#)

Sign in to your Apple Account

If you didn't sign in during setup, do the following:

1. Go to Settings  [ALT N/A] .
2. Tap Apple Account.
3. Tap one of the following:
 - *Use Another Apple Device:* Bring your other iPhone or iPad (with iOS or iPadOS 17 or later) nearby, then follow the onscreen instructions.
 - *Sign in Manually:* Enter your email address or phone number and password. If you don't have an Apple Account, you can create one.
4. If you protect your account with two-factor authentication, enter the six-digit verification code.

If you forgot your Apple Account password, see the [Reset your password website](#).

Change your Apple Account settings

1. Go to Settings  [ALT N/A] > [your name].

2. Do any of the following:

- Update your contact information.
- Change your password.
- [Add or remove Account Recovery Contacts.](#)
- [Use iCloud.](#)
- View and manage your subscriptions.
- Update your payment methods or billing address.
- [Manage Family Sharing.](#)

Add or edit your payment information

The payment method associated with your Apple Account is used for Apple media purchases and services.

1. Go to Settings  [ALT N/A] > [your name].
2. Tap Payment & Shipping. You may need to authenticate with Face ID or Touch ID.
3. Tap Add Payment Method or tap an existing payment method.

See the Apple Support article [If you need to change or update your Apple Account payment method.](#)

Related

[Keep your Apple Account secure on iPhone](#)

[Apple Support article: Manage and use your Apple Account](#)

[Apple Account website](#)

NAV TITLE: [Use iCloud](#)

Use iCloud on iPhone

Metadata

Summary: On iPhone, you can use iCloud to securely store photos, files, and more on your device and access them on any device you choose.

iCloud securely stores your photos, videos, documents, backups, and more—and keeps them updated across all your devices—automatically. With iCloud, you can also share photos, calendars, notes, folders, and files with friends and family. iCloud provides you with an email account and 5 GB of free storage for your data. For more storage and additional features, you can [subscribe to iCloud+](#).

Note: Some iCloud features have [minimum system requirements](#). The availability of iCloud and its features varies by country or region.

P10 In China, iCloud is operated by GCBD. - COMMENT - #zhcn

Set up iCloud

1. Go to Settings  [ALT N/A] > [your name].

If you don't see your name, tap "Sign in to your [device]," then sign in to your Apple Account.

2. Tap iCloud, tap See All, then turn on the apps and features you want to sync with iCloud.

For example, turn on iCloud Drive to make your files in iCloud Drive available to your other devices.



[Alt text: The iCloud settings screen showing the iCloud storage meter and a list of features—including Photos, iCloud Drive, and iCloud Backup—that can be used with iCloud.]

For information on how to customize iCloud features on your other devices, see [Set up iCloud and change settings on all your devices](#) in the iCloud User Guide.

Ways to use iCloud on iPhone

iCloud can keep your iPhone backed up automatically. See [Back up iPhone](#).

You can also keep the following information stored in iCloud and kept up to date across your iPhone and other Apple devices:

- Photos and videos; see [Back up and sync your photos with iCloud](#)
- Files and documents; see [Set up iCloud Drive](#)
- iCloud Mail
- Contacts, Calendars, Notes, and Reminders
- Data from compatible third-party apps and games
- Messages; see [Set up Messages](#)
- Passwords; see [Use Passwords](#)
- Safari bookmarks and open tabs; see [Bookmark a website](#) and [Organize your tabs with Tab Groups](#)
- News, Stocks, and Weather settings
- Home and Health data
- Voice memos
- Map favorites

You can also do the following:

- Share your photos and videos. See [Create shared albums](#) and [Set up or join an iCloud Shared Photo Library](#).
- Use iCloud Drive to [share folders and documents](#).
- Use Find My to [locate a missing device](#) and [share locations with friends and family](#).

For additional storage and access to iCloud Private Relay, Hide My Email, and HomeKit Secure Video support, you can [subscribe to iCloud+](#).

You can also access your iCloud data on iPad, Apple Watch, Mac, Apple Vision Pro, Apple TV, Windows devices, and [iCloud.com](#). To learn more about the available features and how they work across all your devices, see the [iCloud User Guide](#).

Related

[Set up mail, contacts, and calendar accounts on iPhone](#)

NAV TITLE: [Subscribe to iCloud+](#)

Subscribe to iCloud+ on iPhone

Metadata

Summary: Subscribe to iCloud+ on iPhone to get more iCloud storage and additional features.

iCloud+ gives you [everything iCloud offers](#) plus premium features including iCloud Private Relay, Hide My Email, HomeKit Secure Video support, and all the storage you need for your photos, files, and more.

You can subscribe to iCloud+ or to Apple One, which includes iCloud+ and other Apple services. See the Apple Support article [Bundle Apple subscriptions with Apple One](#).

Note: Some iCloud+ features have [minimum system requirements](#). The availability of iCloud+ and its features varies by country or region.

What's included with iCloud+

When you subscribe to iCloud+, you can do the following on iPhone:

- Get 50 GB, 200 GB, 2 TB, 6 TB, or 12 TB (depending on your plan) of storage for photos, files, backups, and more.
- Create unique, random email addresses that forward to your personal inbox with Hide My Email. See [Use Hide My Email in Safari](#) and [Use Hide My Email in Mail](#).
- Browse the web in an even more secure and private way with iCloud Private Relay. See [Protect your web browsing](#).
- Set up home security cameras with HomeKit Secure Video so you can view your footage from anywhere while keeping it private and secure. See [Set up security cameras](#).
- Use a custom email domain to personalize iCloud Mail. See [Set up a custom email domain](#).

To learn more about iCloud+ features and how they work across all your devices, see the [iCloud User Guide](#).

Upgrade, change, or cancel your iCloud+ subscription

1. Go to Settings  [ALT N/A] > [your name] > iCloud.
2. Tap Manage Account Storage, tap Change Storage Plan, select an option, then follow the onscreen instructions.

Note: If you cancel your iCloud+ subscription, you lose access to the additional iCloud storage and iCloud+ features.

Share iCloud+

You can use [Family Sharing](#) to share iCloud+ with up to five other family members. When your family members accept your invitation to share iCloud+, they have instant access to the additional storage and features.

Note: To stop sharing iCloud+ with a family group, you can cancel the subscription, leave the family group, or leave or turn off Family Sharing. See [Add a member to a Family Sharing group](#). For information about combining your Apple subscriptions, see the Apple Support article [Bundle Apple subscriptions with Apple One](#).

Related

[Find settings on iPhone](#)

NAV TITLE: [Find settings](#)

Find settings on iPhone

Metadata

Summary: In Settings on the iPhone Home Screen, find and change settings, such as your passcode, notification sounds, and more.

In the Settings app  [ALT N/A], you can search for iPhone settings you want to change, such as your passcode, notification sounds, and more.

1. Tap Settings on the Home Screen (or in the [App Library](#)).

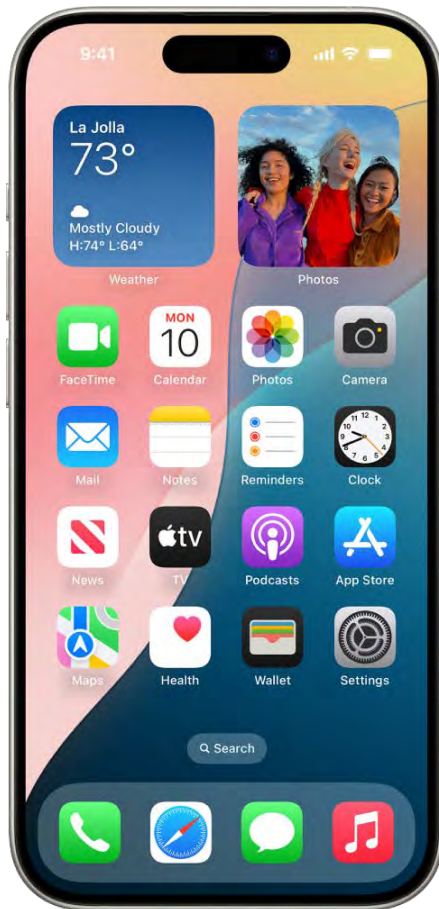

[Alt text: The Home Screen with several app icons, including the Settings app icon, which you can tap to change your iPhone sound volume, screen brightness, and more.]

2. Swipe down to reveal the search field, tap the search field, enter a term—“volume,” for example—then tap a setting.

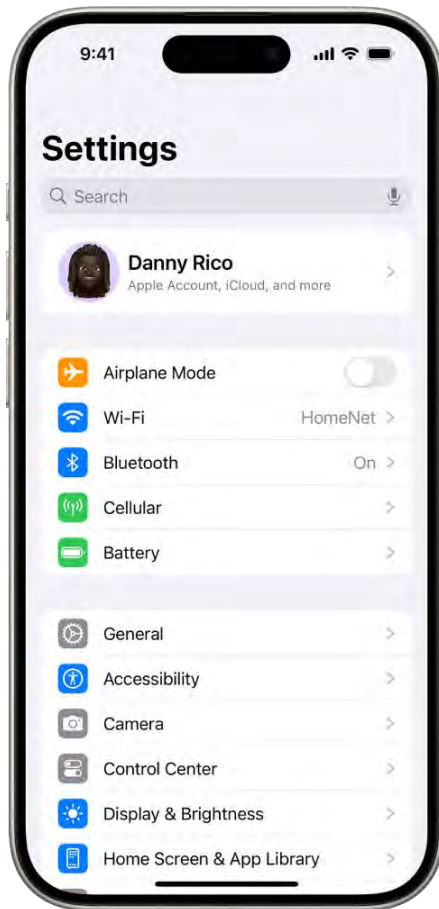

[Alt text: The Settings screen with the search field at the top and several settings below—such as Wi-Fi, Notifications, and Sounds & Haptics.]

Tip: You can also [search for settings](#) from the Home Screen or Lock Screen.

Related

[Change iPhone sounds and vibrations](#)

[Change the wallpaper on iPhone](#)

[Create a custom iPhone Lock Screen](#)

[Search with Spotlight on iPhone](#)

NAV TITLE: [Set up mail, contacts, and calendar accounts](#)

Set up mail, contacts, and calendar accounts on iPhone

Metadata

Summary: On iPhone, set up accounts for Microsoft Exchange and internet-based mail,

contacts, and calendar services.

In addition to the apps that come with iPhone and that you use with [iCloud](#), iPhone works with Microsoft Exchange and many of the most popular internet-based mail, contacts, and calendar services. You can set up accounts for these services.

Set up a mail account

1. Go to Settings  [ALT N/A] > Apps > Mail.
2. Tap Accounts > Add Account.
3. Do one of the following:
 - Tap a service—for example, iCloud or Microsoft Exchange—then enter your account information.
 - Tap Other, tap Add Mail Account, then enter your account information.

See [Add and remove email accounts](#).

Set up a contacts account

1. Go to Settings  [ALT N/A] > Apps > Contacts.
2. Tap Accounts > Add Account.
3. Do one of the following:
 - Tap a service—for example, iCloud or Microsoft Exchange—then enter your account information.
 - Tap Other, tap Add LDAP Account or Add CardDAV Account (if your organization supports it), then enter the server and account information.

See [Add or remove accounts in Contacts](#).

Set up a calendar account

1. Go to Settings  [ALT N/A] > Apps > Calendar.
2. Tap Accounts > Add Account.
3. Do one of the following:
 - *Choose a service:* Tap a service—for example, iCloud or Microsoft Exchange—then enter your account information.
 - *Add a calendar account:* Tap Other, tap Add CalDAV Account, then enter your server and account information.

- *Subscribe to iCal (.ics) calendars:* Tap Other, tap Add Subscribed Calendar, then enter the URL of the .ics file to subscribe to; or import an .ics file from Mail.

See [Set up multiple calendars](#).

For information about setting up a Microsoft Exchange account in a corporate environment, see the Apple Support article [Set up Exchange ActiveSync on your iPhone or iPad](#).

If you turn on iCloud Keychain on your iPhone, your accounts stay up to date on all your devices that have iCloud Keychain turned on. See [Use to iCloud Keychain to keep passwords, accounts, and more up to date with iCloud](#) in the iCloud User Guide.

Related

[Use iCloud on iPhone](#)

NAV TITLE: [Learn the meaning of the status icons](#)

Learn the meaning of the iPhone status icons



Metadata

Summary: Learn the meanings of the iPhone status icons in the status bar at the top of the screen.

The icons in the status bar at the top of the screen provide information about iPhone. On an iPhone with Face ID, there are additional status icons at the top of [Control Center](#).

Note: If you [turn on a Focus](#), its icon appears in the status bar.

(table aria-label=Status icons and their meanings)

Status icon	What it means
 [Alt text: The Wi-Fi status icon.]	Wi-Fi. iPhone is connected to the internet over a Wi-Fi network. See View available networks and connect to Wi-Fi .
 [Alt text: The cellular signal strength status icon (four bars).]	Cell signal. The number of bars indicates the signal strength of your cellular service. If there's no signal, "No Service" appears.
 [Alt text: The signal strength status]	

icon (four bars) for two cellular networks.]

Dual cell signals. On [models with Dual SIM](#), the upper row of bars indicates the signal strength of the line you use for cellular data. The lower row of bars indicates the signal strength of your other line. If there's no signal, "No Service" appears. To see the status icons with their corresponding cellular plan labels and carrier names, [open Control Center](#).



[Alt text: The airplane mode status icon.]

Airplane mode. Airplane mode is on—you can't make phone calls, and other wireless functions may be disabled. See [Choose settings for travel](#).

5G

[Alt text: The 5G status icon.]

5G. Your carrier's 5G network is available, and [supported models](#) can connect to the internet over that network (not available in all countries or regions). See the Apple Support article [Use 5G with your iPhone](#).

5G^U

[Alt text: The 5G status icon.]

5G UC. Your carrier's 5G UC network is available, which can include your carrier's higher frequency version of 5G. [Supported models](#) can connect to the internet over that network (not available in all countries or regions). See the Apple Support article [Use 5G with your iPhone](#).

5G+

[Alt text: The 5G+ status icon.]

5G+. Your carrier's 5G+ network is available, which can include your carrier's higher frequency version of 5G. [Supported models](#) can connect to the internet over that network (not available in all countries or regions). See the Apple Support article [Use 5G with your iPhone](#).

5G^U_w

[Alt text: The 5G UW status icon.]

5G UW. Your carrier's 5G UW network is available, which can include your carrier's higher frequency version of 5G. [Supported models](#) can connect to the internet over that network (not available in all countries or regions). See the Apple Support article [Use 5G with your iPhone](#).

5G E

[Alt text: The 5G E status icon.]

5G E. Your carrier's 5G E network is available, and iPhone can connect to the internet over that network (not available in all countries or regions). See [View or change cellular data settings](#).

LTE

[Alt text: The LTE status icon.]

LTE. Your carrier's LTE network is available, and iPhone can connect to the internet over that network (not available in all countries or regions). See [View or change cellular data settings](#).

4G

[Alt text: The 4G status icon.]

UMTS. Your carrier's 4G UMTS (GSM) or LTE network (depending on the carrier) is available, and iPhone can connect to the internet over that network (not available in all countries or regions). See [View or change cellular data settings](#).

3G

[Alt text: The 3G status icon.]

UMTS/EV-DO. Your carrier's 3G UMTS (GSM) or EV-DO (CDMA) network is available, and iPhone can connect to the internet over that network. See [View or change cellular data settings](#).

E

[Alt text: The EDGE status icon (an "E").]

EDGE. Your carrier's EDGE (GSM) network is available, and iPhone can connect to the internet over that network. See [View or change cellular data settings](#).

G

[Alt text: The GPRS status icon (a "G").]

GPRS/1xRTT. Your carrier's GPRS (GSM) or 1xRTT (CDMA) network is available, and iPhone can connect to the internet over that network. See [View or change cellular data settings](#).



[Alt text: The SOS status icon.]

SOS only. Full service from your cellular provider isn't available, but emergency calls may be possible through other carrier networks (not available in all countries or regions). See [Use SOS to contact emergency services](#).



[Alt text: The SOS status icon.]

Emergency SOS via satellite. iPhone isn't connected to a cellular or Wi-Fi network, but you can contact emergency services via satellite. See [Use Emergency SOS via satellite](#).

P9

Wi-Fi

[Alt text: [The Wi-Fi call status icon.](#)]

Wi-Fi calling. iPhone is set up for Wi-Fi calling. iPhone also displays a carrier name next to the icon. See [Make calls using Wi-Fi](#).



[Alt text: The Personal Hotspot status icon.]

Personal Hotspot connection. iPhone is connected to the internet through the Personal Hotspot of another device. See [Join a Personal Hotspot](#).



[Alt text: The VPN status icon.]

VPN. iPhone is connected to a network using VPN.



[Alt text: The Navigation Indicator icon.]

Navigation. iPhone is providing turn-by-turn directions. See [Get driving directions](#).



[Alt text: The Personal Hotspot Indicator icon.]

Personal Hotspot. iPhone is providing a Personal Hotspot. See [Share your internet connection with Personal Hotspot](#).



[Alt text: The Call Indicator icon.]

Phone call. iPhone is on a phone call. See [Make phone calls](#).



[Alt text: The FaceTime Indicator icon.]

FaceTime. iPhone is on a FaceTime call. See [Make FaceTime calls](#).



[Alt text: The Recording Indicator icon.]

Screen recording. iPhone is recording your screen. See [Take a screen recording](#).



[Alt text: The Camera In Use icon.]

Camera in use. An app is using your camera. See [Control which apps have access to the camera and microphone on your iPhone](#).



[Alt text: The Microphone In Use icon.]

Microphone in use. An app is using your microphone. See [Control which apps have access to the camera and microphone on your iPhone](#).



[Alt text: The Syncing status icon.]

Syncing. iPhone is syncing with your computer. See [Sync supported content](#).



[Alt text: The Network Activity status icon.]

Network activity. Shows that there's network activity. Some third-party apps may also use it to show an active process. See [Connect to the internet](#).



[Alt text: The call forwarding status icon.]

Call forwarding. Call forwarding is set up. See [Set up call forwarding](#).



[Alt text: The Lock status icon.]

Lock. iPhone is locked. See [Wake and unlock iPhone](#).



[Alt text: The Do Not Disturb status icon.]

Do Not Disturb. Do Not Disturb is turned on. See [Turn on or schedule a Focus](#).



[Alt text: The Portrait Orientation Lock status icon.]

Portrait orientation lock. The iPhone screen is locked in portrait orientation. See [Change or lock the screen orientation](#).



[Alt text: The Location Services status icon.]

Location services. An app is using Location Services. See [Control which apps can use the location of your iPhone](#).



[Alt text: The Alarm status icon.]

Alarm. An alarm is set. See [Set an alarm](#).



[Alt text: The Headphones connected status icon.]

Headphones connected. iPhone is paired with Bluetooth® headphones that are turned on and within Bluetooth range. See [Set up and listen to Bluetooth headphones](#).



[Alt text: The Battery status icon.]

Battery. Shows the iPhone battery level. When the icon is yellow, Low Power Mode is on. See [Show the iPhone battery percentage](#).



[Alt text: The Battery Charging icon.]

Battery charging. The iPhone battery is charging. See [Charge the battery](#).



[Alt text: The Bluetooth battery status icon.]

Bluetooth battery. Shows the battery level of a paired Bluetooth device. See [Connect to Bluetooth accessories](#).



[Alt text: The AirPlay status icon.]

AirPlay. AirPlay is on. See [Stream videos and photos.](#)



[Alt text: The Voice Control icon.]

Voice Control. Voice Control is turned on in Settings > Accessibility, and you can [use your voice to interact with iPhone.](#)



[Alt text: The TTY status icon.]

TTY. Software RTT / TTY or Hardware TTY is turned on. See [Set up and use RTT and TTY.](#)



[Alt text: The CarPlay icon.]

CarPlay. iPhone is connected to CarPlay. See [Connect to CarPlay.](#)



[Alt text: The Siri Eyes Free icon.]

Siri Eyes Free. You can ask a question or make a request to Siri in your car. See [Use Siri in your car.](#)

Related

[Connect iPhone to the internet](#)

[Show the iPhone battery percentage](#)

[Get information about your iPhone](#)

[Use the Dynamic Island on iPhone](#)

Charge and monitor the battery

NAV TITLE: [Charge the battery](#)

Charge the iPhone battery

Metadata

Summary: Learn how to charge your iPhone battery so you can get the most out of it.

iPhone has an internal, lithium-ion rechargeable battery, which currently provides the best performance for your device. Compared with traditional battery technology, lithium-ion batteries are lighter, charge faster, last longer, and have a higher power density for more battery life.

To understand how your battery works so you can get the most out of it, see the [Apple Lithium-ion Batteries website](#).

About charging the battery



[Alt text: Battery icon with a lightning bolt indicates that the battery is charging.]

The battery icon in the top-right corner shows the battery level or charging status. When you're syncing or using iPhone, it may take longer to charge the battery.

If iPhone is very low on power, it may display an image of a nearly depleted battery, indicating that it needs to charge for up to 10 minutes before you can use it. If iPhone is extremely low on power when you begin to charge it, the display may be blank for up to 2 minutes before the low-battery image appears. See the Apple Support article [If your iPhone won't charge](#).

Charge the battery

To charge iPhone, do any of the following:

- Connect iPhone to a power outlet using the charging cable (included) and an Apple USB power adapter or other compatible power adapter (sold separately). See [Power adapters](#).

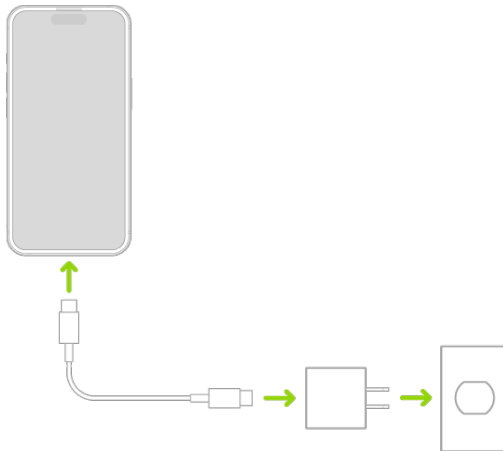

[Alt text: iPhone connected to the power adapter plugged into a power outlet.]

- Place iPhone face up on MagSafe Charger or MagSafe Duo Charger (connected to Apple 20W USB-C power adapter or other compatible power adapter) or on a Qi-certified charger. (MagSafe Charger, MagSafe Duo Charger, power adapters, and Qi-certified chargers are sold separately.) See [MagSafe chargers and battery packs](#) and [Qi-certified wireless chargers](#).

Note: You can also use third-party power adapters and Qi-certified chargers that are compliant with applicable country regulations and international and regional safety standards. See “Charging” in [Important safety information for iPhone](#).

- Connect iPhone and your computer with a cable.

Make sure your computer is turned on—if iPhone is connected to a computer that’s turned off, the battery may drain instead of charge. Look for ⚡ [Alt text: the Charging icon] on the battery icon to make sure your iPhone is charging.

Note: Don’t try to charge your iPhone by connecting it to your keyboard, unless your keyboard has a high-power USB port.

Connecting iPhone to a power outlet or placing it on a wireless charger can start an iCloud backup or wireless computer syncing. See [Back up iPhone](#) and [Sync supported content](#).

WARNING: If you suspect there may be liquid in the charging port of iPhone, don’t plug the charging cable into it. For information about exposure to liquid, and other important safety information about the battery and charging iPhone, see [Important safety information for iPhone](#).

Optimize iPhone battery charging

iPhone has a setting that helps slow the rate of your battery’s aging by reducing the time it spends fully charged. This setting uses machine learning to understand your daily charging routine, then waits to finish charging past 80% until you need it.

1. Go to Settings  [ALT N/A] > Battery > Battery Health & Charging.
2. Do one of the following:
 - *On iPhone 14 and earlier models:* Turn on Optimized Battery Charging.
 - *On iPhone 15 models:* Tap Charging Optimization, then choose Optimized Battery Charging.

If optimized charging doesn’t start when expected, see the Apple Support article [About Optimized Battery Charging on your iPhone](#).

Battery life and charge cycles vary with use and settings. To learn how to maximize your battery’s performance and lifespan, see the Apple Support article [iPhone Battery and Performance](#).

The iPhone battery should be serviced or recycled by Apple or an Apple Authorized Service Provider. See the [Battery Service and Recycling website](#).

Related

- [Show the iPhone battery percentage](#)
- [Check the iPhone battery health and usage](#)
- [Charge iPhone with cleaner energy sources \(U.S. only\)](#)
- [Use Low Power Mode to reduce power usage on iPhone](#)

NAV TITLE: [Charge with cleaner energy sources](#)

Charge iPhone with cleaner energy sources (U.S. only)

Metadata

Summary: iPhone can use a forecast of the carbon emissions in your local energy grid to charge during times of cleaner energy production.

With Clean Energy Charging, iPhone uses a forecast of the carbon emissions in your local energy grid to charge during times of cleaner energy production. iPhone learns from your daily charging routine so it can reach full charge before you need to use it.

Turn on Clean Energy Charging

1. Go to Settings  [ALT N/A] > Battery.
2. Tap Battery Health & Charging, then turn on Clean Energy Charging

Related

- [Charge the iPhone battery](#)
- [Apple and the environment](#)

NAV TITLE: [Show the battery percentage](#)

Show the iPhone battery percentage

Metadata

Summary: Learn how to display the iPhone battery percentage and see how much charge is remaining.

You can view how much charge remains in your iPhone battery in the status bar. You can also add a widget to the Home Screen to monitor the battery levels of your iPhone and connected accessories (including AirPods and other devices).

See the iPhone battery percentage in the status bar

Go to Settings  [ALT N/A] > Battery, then turn on Battery Percentage.

On an iPhone with Face ID, the battery percentage appears inside the battery symbol on the status bar.

Tip: On [iPhone models with Face ID](#), you can also swipe down from the top-right corner to quickly view the battery percentage in Control Center.

Add a Batteries widget to your Lock Screen or Home Screen

See [Add a widget to your Home Screen](#) and [Create a custom Lock Screen](#).

Related

[Charge the iPhone battery](#)

[Check the iPhone battery health and usage](#)

[Use Low Power Mode to reduce power usage on iPhone](#)

[Apple Support article: iPhone Battery and Performance](#)

NAV TITLE: [Check battery health and usage](#)

Check the iPhone battery health and usage

Metadata

Summary: Learn how to check the health and usage of your iPhone battery so you can get the most out of it.

You can view information about your iPhone battery health and learn how your iPhone usage affects the battery level.

Review your iPhone battery health

Go to Settings  [ALT N/A] > Battery, then tap Battery Health & Charging.

iPhone displays information about your battery's capacity, peak performance, and whether your battery needs to be serviced.

View your battery usage information

Go to Settings  [ALT N/A] > Battery.

Information about your battery usage and activity appears for the last 24 hours and up to the last 10 days.

- *Insights and suggestions:* You might see insights about conditions or usage patterns that cause iPhone to consume energy. You might also see suggestions for lowering energy consumption. If a suggestion appears, you can tap it to go to the corresponding setting.
- *Last Charged:* Indicates how fully the battery was last charged and the time it was disconnected.
- *Battery Level graph (in Last 24 Hours):* Shows the battery level, charging intervals, and periods when iPhone was in Low Power Mode or the battery was critically low.
- *Battery Usage graph (in Last 10 Days):* Shows the percentage of battery used each day.
- *Activity graph:* Shows activity over time, split by whether the screen was on or off.
- *Screen On and Screen Off:* Shows total activity for the selected time interval, for when the screen was on and when it was off. The Last 10 Days view shows the average per day.
- *Battery Usage by App:* Shows the proportion of the battery used by each app in the selected time interval.
- *Activity by App:* Shows the amount of time each app was used in the selected time interval.

Note: To see battery information for a specific hour or day, tap that time interval in the graph. To deselect it, tap outside the graph.

Battery life and charge cycles vary with use and settings. To learn how to maximize your battery's performance and lifespan, see the Apple Support article [iPhone Battery and Performance](#).

The iPhone battery should be serviced or recycled by Apple or an Apple Authorized Service Provider. See the [Battery Service and Recycling website](#).

Related

[Optimize iPhone battery charging](#)

[Use Low Power Mode to reduce power usage on iPhone](#)

NAV TITLE: [Use Low Power Mode](#)

Use Low Power Mode to reduce power usage on iPhone

Metadata

Summary: Low Power Mode reduces the amount of power that your iPhone uses when the battery gets low. It optimizes performance for essential tasks like making and receiving calls, sending and receiving email and messages, and accessing the internet.

Low Power Mode reduces the amount of power that your iPhone uses when the battery gets low. It optimizes performance for essential tasks like making and receiving calls, sending and receiving email and messages, accessing the internet, and more. On [iPhone models with ProMotion display technology](#), Low Power Mode limits the display refresh rate to 60 frames per second.





Note: iPhone might perform some tasks more slowly when in Low Power Mode.

If iPhone switches to Low Power Mode automatically, it turns off Low Power Mode after charging to 80%.

Turn Low Power Mode on or off

Low Power Mode automatically turns on when the battery level is low and automatically turns off when the battery is charged to a certain level.

To manually turn Low Power Mode on or off, use any of the following methods:

- *In Settings:* Go to Settings  [ALT N/A] > Battery.
- *In Control Center:* [Open Control Center](#), then tap  [Alt text: the Low Power Mode button].
(If you don't see  [Alt text: the Low Power Mode button], add it to Control Center—go to Settings  [ALT N/A] > Control Center, then tap  [Alt text: the Insert button] next to Low Power Mode.)

Related

[Charge the iPhone battery](#)

[Apple Support article: Use Low Power Mode to save battery life on your iPhone or iPad](#)

NAV TITLE: [Read and bookmark the user guide](#)

Read and bookmark the iPhone User Guide



Metadata

Summary: View the iPhone User Guide in Safari, change the language, add a bookmark, and save it as a shortcut. You can also view the guide in Tips.

When you view the iPhone User Guide in the Safari app, you can change the language and country or region, add a bookmark, or save it as a shortcut on the Home Screen. You can also view the guide in the Tips app.

View and bookmark the iPhone User Guide in Safari

1. Go to the Safari app  [ALT N/A] on your iPhone.

2. Go to <https://support.apple.com/guide/iphone>.
3. To view the user guide in a different language, scroll down to the bottom of the page, tap the country or region link (United States, for example), then choose a country or region.
4. For quick access, tap  [Alt text: the Share button], then choose any of the following:
 - *Add to Home Screen:* The shortcut appears as a new icon on the Home Screen.
 - *Add Bookmark:* The bookmark appears when you tap  [Alt text: the Bookmarks button] in Safari.

View the iPhone User Guide in Tips

1. Go to the Tips app  [ALT N/A] on your iPhone.
2. Scroll down to User Guides, then tap iPhone.

Related

[Save webpages to read later in Safari on iPhone](#)

[Move apps and widgets on the iPhone Home Screen](#)

[Use the Tips app on iPhone](#)

Basics

Learn gestures for iPhone

NAV TITLE: [Learn basic gestures](#)





Learn basic gestures to interact with iPhone

Metadata

Summary: On your iPhone, learn the gestures you need to scroll lists, magnify text and images, move and open items, turn pages, and more.

Control iPhone and its apps using a few simple gestures—tap, touch and hold, swipe, scroll, and zoom.

(table aria-label=Basic gestures)

Symbol	Gesture
 <p>[Alt text: An icon symbolizing the tap gesture.]</p>	<p>Tap. Briefly touch an item on the screen with one finger. For example, to open an app, tap its icon on the Home Screen.</p>
 <p>[Alt text: An icon symbolizing the touch and hold gesture.]</p>	<p>Touch and hold. Press an item on the screen until something happens. For example, if you touch and hold the wallpaper of the Home Screen, the app icons begin to jiggle.</p>
 <p>[Alt text: An icon symbolizing the swipe gesture.]</p>	<p>Swipe. Move one finger across the screen quickly. For example, swipe left on the Home Screen to see more apps.</p>
 <p>[Alt text: An icon symbolizing the scroll gesture.]</p>	<p>Scroll. Move one finger across the screen without lifting. For example, in Photos, you can drag a list up or down to see more. Swipe to scroll quickly; touch the screen to stop scrolling.</p>
 <p>[Alt text: An icon symbolizing the zoom gesture.]</p>	<p>Zoom. Place two fingers on the screen near each other. Spread them apart to zoom in, or move them toward each other to zoom out.</p> <p>You can also double-tap a photo or webpage to zoom in, and double-tap again to zoom out.</p> <p>In Maps, double-tap and hold, then drag up to zoom in or drag down to zoom out.</p>

Related

[Learn gestures for iPhone models with Face ID](#)

NAV TITLE: [Learn gestures for iPhone models with Face ID](#)





Learn gestures for iPhone models with Face ID

Metadata

Summary: On an iPhone with Face ID, learn the gestures you need to switch between recent apps, access controls, go to the Home Screen, and more.

Here's a handy reference to the gestures you use for interacting with an iPhone that has Face ID.

(table aria-label=Intuitive gestures)

Gesture	Description
 <p data-bbox="264 558 605 653">[Alt text: An illustration of iPhone with an arrow that indicates swiping up from the bottom.]</p>	<p data-bbox="626 365 1352 422">Go Home. Swipe up from the bottom edge of the screen to return to the Home Screen at any time. See Open apps on iPhone.</p>
 <p data-bbox="264 898 605 1020">[Alt text: An illustration of iPhone with an arrow that indicates swiping down from the top-right corner.]</p>	<p data-bbox="626 705 1352 825">Quickly access controls. Swipe down from the top-right corner to open Control Center; touch and hold a control to reveal more options. To add or remove controls, go to Settings  [ALT N/A] > Control Center. See Use and customize Control Center on iPhone.</p>
 <p data-bbox="264 1266 605 1388">[Alt text: An illustration of iPhone. A line ending with a dot indicates a drag up from the bottom of the screen, then a pause.]</p>	<p data-bbox="626 1073 1352 1192">Open the App Switcher. Swipe up from the bottom edge, pause in the center of the screen, then lift your finger. To browse the open apps, swipe right, then tap the app you want to use. See Switch between open apps on iPhone.</p>
 <p data-bbox="264 1640 605 1770">[Alt text: An illustration of iPhone. A two-headed arrow indicates swiping left or right across the bottom edge of the screen.]</p>	<p data-bbox="626 1440 1352 1539">Switch between open apps. Swipe right or left along the bottom edge of the screen to quickly switch between open apps. See Switch between open apps on iPhone.</p>

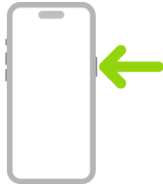

[Alt text: An illustration of iPhone with an arrow pointing to the side button on the upper right.]

Use Siri. Just say “Siri” or “Hey Siri.” Or hold down the side button while you ask a question or make a request, then release the button. See [Use Siri on iPhone.](#)

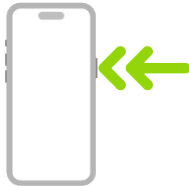

[Alt text: An illustration of iPhone with two arrows indicating double-clicking the side button on the upper right.]

Use Apple Pay. Double-click the side button to display your default credit card, then glance at iPhone to authenticate with Face ID. See [Use Apple Pay for contactless payments on iPhone.](#)



[Alt text: An illustration of iPhone with three arrows indicating triple-clicking the side button on the upper right.]

Use Accessibility Shortcut. Triple-click the side button. See [Quickly turn accessibility features on or off on iPhone.](#)

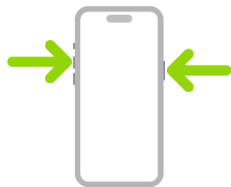

[Alt text: An illustration of iPhone with arrows pointing to the side button on the upper right and the volume up button on the upper left.]

Take a screenshot. Simultaneously press and quickly release the side button and volume up button. See [Take a screenshot with an iPhone that has Face ID.](#)

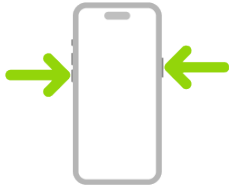

[Alt text: An illustration of iPhone with arrows pointing to the side button on the upper right and a volume button on the upper left.]

Use Emergency SOS (all countries or regions except India).

Simultaneously press and hold the side button and either volume button until the sliders appear and the countdown on Emergency SOS ends, then release the buttons. See

[Quickly call emergency services \(all countries or regions except India\).](#)

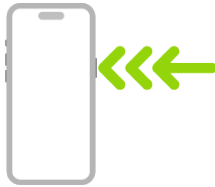

[Alt text: An illustration of iPhone with an arrow that indicates triple-clicking the side button on the upper right.]

Use Emergency SOS (in India). Quickly press the side button 3 times until the sliders appear and the countdown on Emergency SOS ends.

If you've turned on Accessibility Shortcut, simultaneously press and hold the side button and either volume button until the sliders appear and the countdown on Emergency SOS ends, then release the buttons.

See [Quickly call emergency services \(India\)](#).

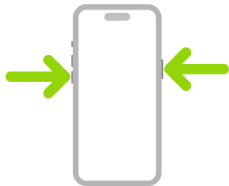

[Alt text: An illustration of iPhone with arrows pointing to the side button on the upper right and a volume button on the upper left.]

Turn off. Simultaneously press and hold the side button and either volume button until the sliders appear, then drag the top slider to power off. Or go to Settings > General > Shut Down. See [Turn off iPhone](#).

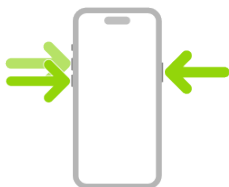

[Alt text: An illustration of iPhone with arrows pointing to the side button on the upper right and the volume up and volume down buttons on the upper left.]

Force restart. Press and release the volume up button, press and release the volume down button, then press and hold the side button until the Apple logo appears. See [Force restart iPhone](#).

In the U.S., Apple Pay is a service provided by Apple Payments Services LLC, a subsidiary of Apple Inc. In other countries and regions, Apple Pay is a service provided by certain Apple affiliates, as designated by the [Apple Pay privacy notice](#).

Neither Apple Inc. nor Apple Payments Services LLC nor Apple affiliates are a bank. Any card used in Apple Pay is offered by

the card issuer.

Related

[Learn basic gestures to interact with iPhone](#)

NAV TITLE: [Adjust the volume](#)

Adjust the volume on iPhone

Metadata

Summary: On iPhone, adjust the volume of media, alerts, and sound effects using the side buttons, Siri, or Control Center.

Adjust the volume of media, alerts, and sound effects using the volume buttons, Siri, or Control Center.

Use the volume buttons or Siri to adjust volume

When you're on a call or listening to songs, movies, or other media on iPhone, you can use the buttons on the side of your device to adjust the audio volume. Otherwise, the buttons control the volume for the ringer, alerts, and other sound effects.

You can also use Siri to turn the volume up or down.

Siri: Say something like: "Turn up the volume" or "Turn down the volume." [Learn how to use Siri.](#)

WARNING: For information about avoiding hearing loss, see [Important safety information for iPhone.](#)



[Alt text: The upper portion of the front of iPhone with the volume up and volume down buttons on the upper left.]

Lock the ringer and alert volumes in Settings

1. Go to Settings  [ALT N/A] , then tap Sounds & Haptics.
2. Turn off Change with Buttons.

Adjust the volume in Control Center

When iPhone is locked or when you're using an app, you can adjust the volume in Control Center.

[Open Control Center](#), then drag  [Alt text: the volume slider] .

Reduce loud headphone sounds

1. Go to Settings  [ALT N/A] > Sounds & Haptics > Headphone Safety.
2. Turn on Reduce Loud Audio, then drag the slider to specify the maximum volume.

Note: If you [set up Screen Time for a family member](#), you can prevent them from changing the Reduce Loud Sounds level. Go to Settings > Screen Time > Content & Privacy Restrictions > Reduce Loud Sounds, turn on Content & Privacy Restrictions, tap Reduce Loud Sounds, then select Don't Allow.

Related

[Change iPhone sounds and vibrations](#)

Silence iPhone

Metadata

Summary: With the push of a button or flip of a switch, you can quickly silence your iPhone.

With the push of a button or flip of a switch, you can quickly silence your iPhone.

Turn Silent mode on or off

When Silent mode is on, iPhone doesn't ring or play alerts or other sound effects (but iPhone may still vibrate). When Silent mode is off, iPhone plays all sounds.

- On [models with an Action button](#): Go to Settings  [ALT N/A] > Sounds & Haptics, then turn Silent mode on or off.

You can also configure the Action button to turn Silent mode on or off, in addition to other functions. See [Use and customize the Action button on iPhone](#).

- On other models: Flip the Ring/Silent switch toward the back of your iPhone to turn Silent mode on. Flip it toward the front to turn Silent mode off.

Important: Clock alarms, audio apps such as Music, and many games play sounds through the built-in speaker, even when Silent mode is on. In some countries or regions, the sound effects for Camera, Voice Memos, and Emergency Alerts are played, even when the Ring/Silent switch is set to silent.

Turn on Do Not Disturb

You can temporarily silence calls, alerts, and notifications by turning on Do Not Disturb.

1. [Open Control Center](#).
2. Tap Focus, then tap Do Not Disturb.

See [Turn on or schedule a Focus](#).

Use your apps

NAV TITLE: [Open apps](#)

Open apps on iPhone

Metadata

Summary: Get to know the Home Screen and App Library on iPhone. Learn how to scroll to another Home Screen page and open apps.

You can quickly open apps from your Home Screen pages or your [App Library](#).

1. To go to the Home Screen, swipe up from the bottom edge of the screen (on an iPhone with Face ID) or press the Home button (on an iPhone with a Home button).



[Alt text: An illustration showing swiping up from the bottom edge of the screen to go to the Home Screen.]

2. Swipe left to browse apps on other Home Screen pages.

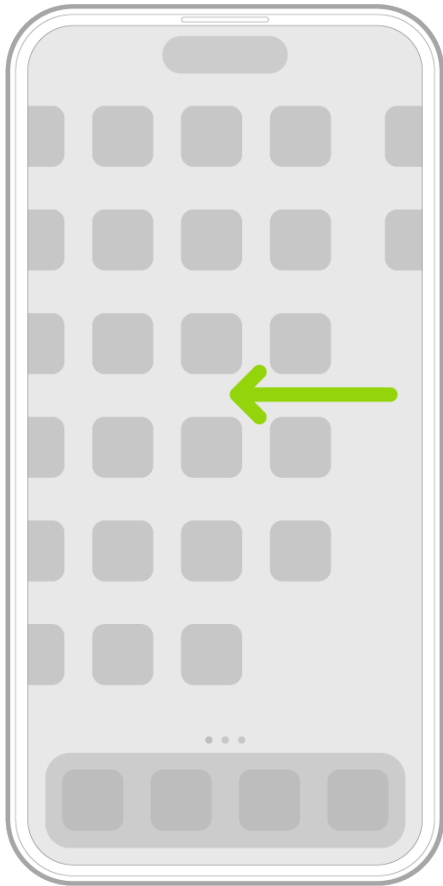

[Alt text: An illustration showing swiping left to browse apps on other Home Screen pages.]

3. Swipe left past all your Home Screen pages to see App Library, where your apps are organized by category.
4. To open an app, tap its icon.
5. To return to App Library, swipe up from the bottom edge of the screen (on an iPhone with Face ID) or press the Home button (on an iPhone with a Home button).

Related

[Find your apps in App Library](#)

[Quit and reopen an app](#)

[Move and organize apps on your Home Screen](#)

[Remove or delete apps from iPhone](#)

NAV TITLE: [Find and use your apps in App Library](#)

Find and use your apps in App Library on iPhone

Metadata

Summary: In App Library on iPhone, easily find your apps organized into categories—Social, Travel, Entertainment, and so on—and open them.

App Library shows your apps organized into categories, such as Social, Entertainment, and Productivity & Finance. The apps you use most are near the top of the screen and at the top level of their categories, so you can easily locate and open them.



[Alt text: App Library on iPhone showing the apps organized by category (Utilities, Social, Entertainment, and so on).]

Note: The apps in App Library are organized in categories intelligently, based on how you use your apps. You can add apps in App Library to the Home Screen, but you can't move them to another category in App Library.

Find and open an app in App Library

1. [Go to the Home Screen](#), then swipe left past all your Home Screen pages to get to App Library.

2. Tap the search field at the top of the screen, then enter the name of the app you're looking for. Or scroll up and down to browse the alphabetical list.
3. To open an app, tap it.

If a category has a few small app icons, you can tap them to expand the category and see all the apps in it.

Hide and show Home Screen pages

Because you can find all of your apps in App Library, you might not need as many Home Screen pages for apps. You can hide some Home Screen pages, which brings App Library closer to your first Home Screen page. (When you want to see the hidden pages again, you can show them.)

1. [Go to the Home Screen](#), then touch and hold the Home Screen wallpaper until the app icons begin to jiggle.
2. Tap the dots at the bottom of the screen.
Thumbnail images of your Home Screen pages appear with checkmarks below them.
3. To hide pages, tap to remove the checkmarks.
To show hidden pages, tap to add the checkmarks.
4. Tap Done (on an iPhone with Face ID) or press the Home button (on other iPhone models).

With the extra Home Screen pages hidden, you can go from the first page of the Home Screen to App Library (and back) with only one or two swipes.

Note: When Home Screen pages are hidden, new apps you download from the App Store may be added to App Library instead of the Home Screen.

Reorder Home Screen pages

If you have multiple Home Screen pages, you change their order. For example, you can gather together your favorite apps on one Home Screen page, and then make that your first Home Screen page.

1. [Go to the Home Screen](#), then touch and hold the Home Screen wallpaper until the app icons begin to jiggle.
2. Tap the dots at the bottom of the screen.
Thumbnail images of your Home Screen pages appear with checkmarks below them.
3. To move each Home Screen page, touch and hold it, then drag it to a new position.
4. Tap Done twice (on an iPhone with Face ID) or press the Home button twice (on other iPhone models).

Change where new apps get downloaded

When you download new apps from the App Store, you can add them to the Home Screen and App Library, or to App Library only.

1. Go to Settings  [ALT N/A] > Home Screen & App Library.
2. Choose Add to Home Screen or App Library Only.

Note: To allow app notification badges to appear on apps in App Library, turn on Show in App Library.

Move an app from App Library to the Home Screen

If you [moved an app from the Home Screen](#) to App Library, you can easily move it back to the Home Screen.

1. [Go to the App Library](#).
2. Touch and hold the app until the app icons begin to jiggle and the app moves to the Home Screen, then lift your finger.

Related

[Open apps on iPhone](#)

NAV TITLE: [Switch between open apps](#)

Switch between open apps on iPhone

Metadata

Summary: On iPhone, use the App Switcher to quickly switch from one app to another. When you switch back, you can pick up right where you left off.

You can quickly switch from one open app to another on your iPhone. When you switch back, you can pick up right where you left off.

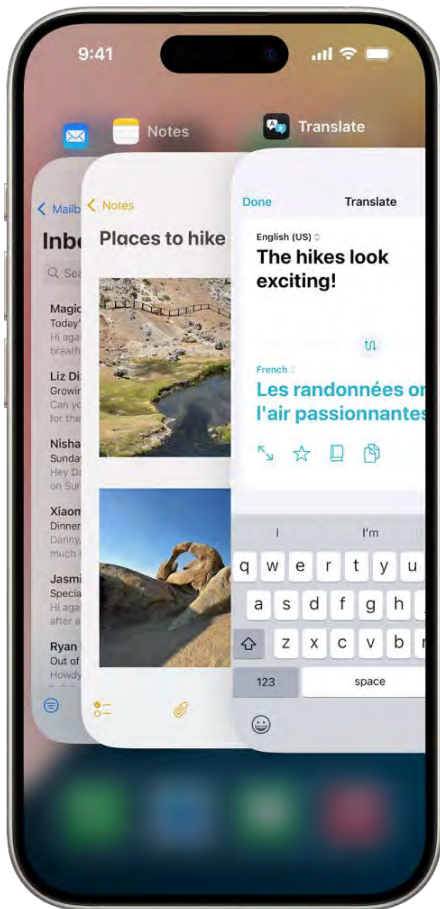

[Alt text: The App Switcher. Icons for the open apps appear at the top, and the current screen for each open app appears below its icon.]

Use the App Switcher

1. To see all your open apps, do one of the following:
 - *On an iPhone with Face ID:* Swipe up from the bottom of the screen, pause in the center of the screen, then lift your finger.
 - *On an iPhone with a Home button:* Double-click the Home button.
2. To browse the open apps, swipe right, then tap the app you want to use.

Switch between open apps

To quickly switch between open apps on an iPhone with Face ID, swipe right along the bottom edge of the screen.

Related

[Open apps on iPhone](#)

NAV TITLE: [Quit and reopen an app](#)

Quit and reopen an app on iPhone

Metadata

Summary: On iPhone, try quitting and reopening an app if it isn't responding.

If an app isn't responding, you can quit it and then reopen it to try and resolve the issue. (Typically, there's no reason to quit an app; quitting it doesn't save battery power, for example.)

1. To quit the app, [open the App Switcher](#), swipe right to find the app, then swipe up on the app.
2. To reopen the app, [go to the Home Screen](#) (or [App Library](#)), then tap the app.

If quitting and reopening the app doesn't resolve the issue, try restarting iPhone.

Related

[Turn iPhone on or off](#)

NAV TITLE: [Multitask with Picture in Picture](#)

Multitask with Picture in Picture on iPhone

Metadata

Summary: On iPhone, watch a video or use FaceTime while you use other apps.

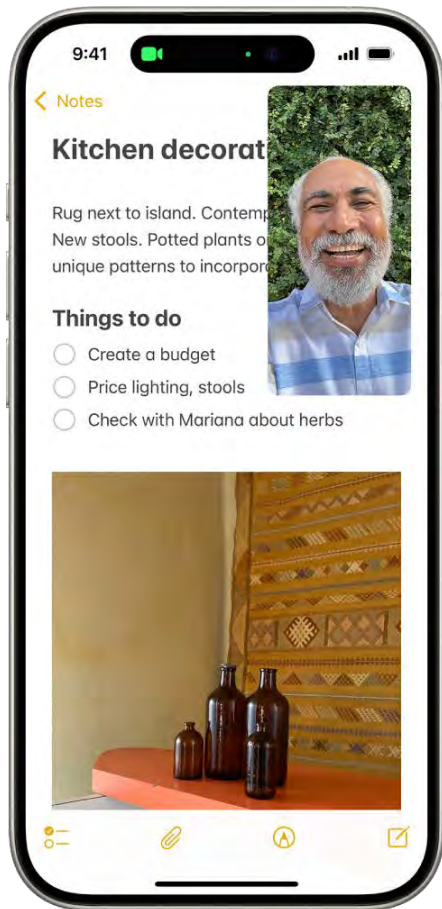

With Picture in Picture, you can watch a video or use FaceTime while you use other apps.



[Alt text: A FaceTime conversation taking place, while a note about kitchen decorating fills the rest of the screen.]

While watching a video, tap  [Alt text: the Minimize Video button] in the video window.

The video window scales down to a corner of your screen so you can see the Home Screen and open other apps. With the video window showing, you can do any of the following:

- *Resize the video window:* To make the small video window larger, pinch open. To shrink it again, pinch closed.
- *Show and hide controls:* Tap the video window.
- *Move the video window:* Drag it to a different corner of the screen.
- *Hide the video window:* Drag it off the left or right edge of the screen.
- *Close the video window:* Tap  [Alt text: the Close button] .
- *Return to a full video screen:* Tap  [Alt text: the Restore Full Screen button] in the small video window.

Related

[Use other apps during a FaceTime call](#)

NAV TITLE: [Access features from the Lock Screen](#)

Access features from the iPhone Lock Screen

Metadata

Summary: From the iPhone Lock Screen, open Camera and Control Center, see notifications, get information from your favorite apps at a glance, and more.

The Lock Screen appears when you turn on or wake iPhone. From the Lock Screen, you can see notifications, open Camera and Control Center, get information from your favorite apps at a glance, control media playback, and more.

You can personalize your Lock Screen by choosing a wallpaper, showcasing a favorite photo, changing the font of the time, adding widgets, and more. See [Create a custom iPhone Lock Screen](#).



[Alt text: The iPhone Lock Screen showing the time and date near the top and icons for the Flashlight and Camera near the bottom.]

Access features and information from the Lock Screen

You can quickly access useful features and information from the Lock Screen, even while iPhone is locked.

Go to the Lock Screen, then do any of the following:

- *Open Camera:* Swipe left. On [supported models](#), you can touch and hold  [Alt text: the Camera button], then lift your finger. (See [iPhone camera basics](#).)
- *Open Control Center:* Swipe down from the top-right corner (on an iPhone with Face ID) or swipe up from the bottom edge of the screen (on other iPhone models). (See [Use and customize Control Center on iPhone](#).)
- *See earlier notifications:* Swipe up from the center. (See [View and respond to notifications on iPhone](#).)

- *View more widgets:* Swipe right. (See [Add, edit, and remove widgets on iPhone.](#)) You can interact with widgets on the Lock Screen and the Home Screen to perform tasks—for example, tap an item in the Reminders widget to check it off, or tap the Play button in the Podcasts widget to play an episode.
- *Control media playback:* Use the playback controls (Now Playing) on the Lock Screen to play, pause, rewind, or fast-forward media playing on your iPhone. (See [View and control Live Activities on the Lock Screen.](#))

To choose what you can access from the Lock Screen, see [Turn on Lock Screen features on iPhone.](#)

Show notification previews on the Lock Screen

1. Go to Settings  [ALT N/A] > Notifications.
2. Tap Show Previews, then tap Always.
3. Choose how you want notifications displayed on the Lock Screen:
 - *View just the number of notifications:* Tap Count.
 - *View the notifications grouped into stacks by app:* Tap Stack.
 - *View the notifications in a list:* Tap List.

You can pinch the notifications on the Lock Screen to change the layout.

Notification previews can include text from Messages, lines from Mail messages, and details about Calendar invitations. See [View and respond to notifications on iPhone.](#)

View and control Live Activities on the Lock Screen

You can view Live Activities on your Lock Screen—including live sports updates, order updates, and media playing—so you can follow along right on your Lock Screen, even when you can't watch the entire event.

When you play music, a movie, or other media on your iPhone, you can use the playback controls (Now Playing) on your Lock Screen to play, pause, rewind, and fast-forward.

You can also control media playback on a remote device (such as your Apple TV or HomePod) from your iPhone Lock Screen.



[Alt text: The Lock Screen showing an album cover and below it the controls for music playing on a remote device.]

Related

[Turn on Lock Screen features on iPhone](#)

NAV TITLE: [Use the Dynamic Island](#)

Use the Dynamic Island on iPhone

Metadata

Summary: On iPhone 14 Pro and later, view alerts and activities in the Dynamic Island.

On iPhone 14 Pro and later, you can check alerts and current activity in progress—such as a Voice Memo recording in progress, an AirDrop connection, and directions from Maps—in the Dynamic Island at the top of the Home Screen or at the top of the active app. The Dynamic Island appears at the top of the screen whenever your iPhone is unlocked.



[Alt text: The iPhone 14 Pro Home Screen, showing a live Voice Memo recording in the Dynamic Island at the top of the screen.]

You can do any of the following in the Dynamic Island:

- *Expand the activity to see more detail:* Touch and hold the activity or swipe from the center to the right or left side.
- *Collapse the activity to make the Dynamic Island smaller:* Swipe from the right or left side toward the center.
- *Switch between two activities:* Swipe from one side or the other.

Related

[View and control Live Activities on the Lock Screen](#)

NAV TITLE: [Perform quick actions](#)

Perform quick actions on iPhone

Metadata

Summary: On iPhone, see previews, open quick actions menus, and more.

On the Home Screen, in App Library, in Control Center, and in apps, you can use quick actions menus, see previews, and more.

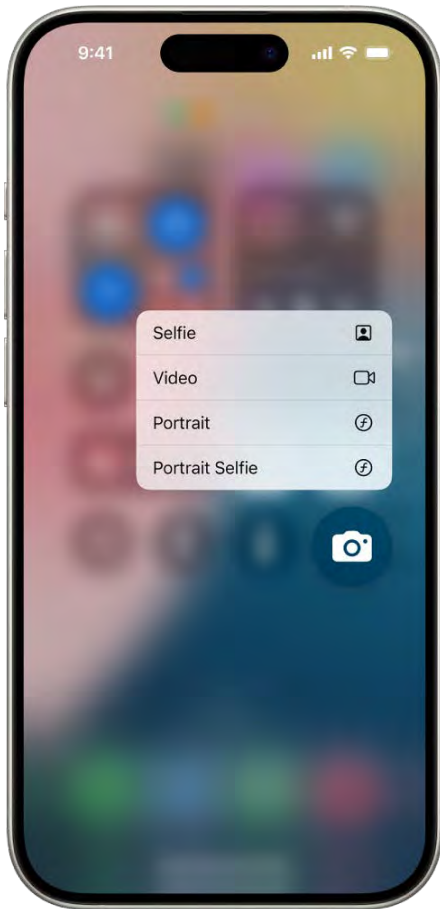

Perform quick actions from Control Center, the Home Screen and the App Library

On the Home Screen and in App Library, touch and hold apps to open quick actions menus.



[Alt text: A blurred Home Screen, with the Camera quick actions menu showing below the Camera app icon.]

For example:

- Touch and hold Camera  [ALT N/A] , then choose Selfie.
- Touch and hold Maps  [ALT N/A] , then choose Send My Location.
- Touch and hold Notes  [ALT N/A] , then choose New Note.

Note: If you touch and hold an app for too long before choosing a quick action, all of the apps begin to jiggle. Tap Done (on an iPhone with Face ID) or press the Home button (on other iPhone models), then try again.

See previews and other quick actions menus

- In Photos, touch and hold an image to preview it and see a list of options.
- In Mail, touch and hold a message in a mailbox to preview the message contents and see a list of options.
- [Open Control Center](#), then touch and hold an item like Camera  [Alt text: the Camera button] or the brightness control to see options.
- On the Lock Screen, touch and hold a notification to respond to it.
- When typing, touch and hold the Space bar with one finger to [turn the onscreen keyboard into a trackpad](#).

Related

[Use and customize Control Center on iPhone](#)

NAV TITLE: [Search on iPhone](#)

Search with Spotlight on iPhone

Metadata

Summary: When you search on iPhone, you get results from the internet, media, other content on your iPhone, and from your apps.

On iPhone, you can search for apps and contacts, content in apps like Mail and Messages, and even text in your photos using Live Text. You can check stock and currency information, and find and open webpages, apps, and images in your photo library, across your system, and on the web.



When you search for an app, app shortcuts for your most likely next action appear within the Top Hit. (For example, a shortcut to the Favorites album appears when you search for Photos.)

In Settings > Search, you can choose which apps you want to include in search results. Search offers suggestions based on your app usage, and updates results as you type.

Choose which apps to include in Search

1. Go to Settings  [ALT N/A] > Search.
2. Scroll down, tap an app, then turn Show App in Search on or off.

Search with iPhone

1. Tap  [Alt text: the Search button] at the bottom of the Home Screen (on [models with Face ID](#)) or swipe down on the Home Screen or the Lock Screen.
2. Enter what you're looking for in the search field.
3. Do any of the following:
 - *Initiate your search:* Tap Search or Go.
 - *Open a suggested app:* Tap the app.
 - *Take quick action:* Start a timer, turn on a Focus, find the name of a song with Shazam, run any shortcut, and more. Search for an app's name to see shortcuts available for the app, or create your own using the Shortcuts app.
 - *Check a suggested website:* Tap it.
 - *Get more information about a search suggestion:* Tap it, then tap one of the results to open it.
 - *Start a new search:* Tap  [Alt text: the Clear Text button] in the search field.

Turn off Location-Based Suggestions

1. Go to Settings  [ALT N/A] > Privacy & Security > Location Services.
2. Tap System Services, then turn off Suggestions & Search.

Search in apps

Many apps include a search field or a search button so you can find something within the app. For example, in the Maps app, you can search for a specific location.

1. In an app, tap the search field or  [Alt text: the Search button] .
If you don't see a search field or button, swipe down from the top.
2. Type your search, then tap Search.

Add a dictionary

On iPhone, you can add dictionaries, which can be used in searches.

1. Go to Settings  [ALT N/A] > General > Dictionary.
2. Select a dictionary.

Related

[Search for places in Maps on iPhone](#)

NAV TITLE: [Get information about your iPhone](#)

Get information about your iPhone

Metadata

Summary: On iPhone, find storage information, battery usage, iOS version number, model number, serial number, warranty information, and more.

View overall storage availability and storage used per app

Go to Settings  [ALT N/A] > General > iPhone Storage.

See the Apple Support articles [How to check the storage on your iPhone and iPad](#) and [Manage your iCloud storage](#).

See battery usage

Go to Settings  [ALT N/A] > Battery to see the elapsed time since iPhone was charged as well as battery usage by app.

You can also display battery level as a percentage, turn Low Power Mode on or off, and check your battery's health.

See [Monitor the iPhone battery level](#).

View call time and cellular usage

Go to Settings  [ALT N/A] > Cellular. See [View or change cellular data settings on iPhone](#).

Find your IMEI

You can view the IMEI (International Mobile Equipment Identity) for your iPhone in Settings.

1. Go to Settings  [ALT N/A] > General > About.
2. Scroll down and find your IMEI.

See the name, model, iOS version, serial number, and more

Go to Settings  [ALT N/A] > General > About. The items you can view include:

- Name

- iOS software version
- Model name
- Part and model numbers. To the right of Model, the part number appears. To see the model number, tap the part number.
- Serial number
- Number of songs, videos, photos, and apps
- Capacity and available storage space
- Wi-Fi and Bluetooth® addresses
- Cellular network
- Carrier settings. To the right of Carrier, the carrier settings version number appears. To see additional carrier-specific information, tap the version number. Contact your carrier for more details.
- ICCID (Integrated Circuit Card Identifier, or Smart Card) for GSM networks
- MEID (Mobile Equipment Identifier) for CDMA networks
- Modem firmware

To copy the serial number and other identifiers, touch and hold the identifier until Copy appears.

To see Legal & Regulatory information (including legal notices and license, warranty, and RF exposure information) and regulatory marks, go to Settings > General > Legal & Regulatory.

On [supported models](#), you can also find the IMEI on the SIM card tray and the model number in the SIM tray opening.

View or turn off diagnostic information

Go to Settings  [ALT N/A] > Privacy & Security > Analytics & Improvements.

To help Apple improve products and services, iPhone sends diagnostic and usage data. This data doesn't personally identify you, but may include location information.

Related

[Turn on and set up iPhone](#)

NAV TITLE: [View or change cellular data settings](#)

View or change cellular data settings on iPhone

Metadata

Summary: On iPhone, turn cellular data and roaming on or off, set which apps and services use cellular data, and set other cellular options.

You can turn cellular data and roaming on or off, set which apps and services use cellular data, see cellular data usage, and set other cellular data options.

Note: For help with cellular network services, voicemail, and billing, contact your wireless service provider.

About cellular networks

If your iPhone is connected to the internet using a cellular data network, an icon identifying the cellular network appears in the [status bar](#).

5G, LTE, 4G, and 3G service on GSM cellular networks support simultaneous voice and data communications. For all other cellular connections, you can't use internet services while you're talking on the phone unless your iPhone also has a Wi-Fi connection to the internet. Depending on your network connection, you may not be able to receive calls while your iPhone transfers data over the cellular network—when downloading a webpage, for example.

- **GSM networks:** On an EDGE or GPRS connection, incoming calls may go directly to voicemail during data transfers. For incoming calls that you answer, data transfers are paused.
- **CDMA networks:** On EV-DO connections, data transfers are paused when you answer incoming calls. On 1xRTT connections, incoming calls may go directly to voicemail during data transfers. For incoming calls that you answer, data transfers are paused.

Data transfer resumes when you end the call.

If Cellular Data is off, all data services—including email, web browsing, and push notifications—use Wi-Fi only. If Cellular Data is on, carrier charges may apply. For example, using certain features and services that transfer data, such as Siri and Messages, could result in charges to your data plan.

To make calls using Wi-Fi, see [Make calls using Wi-Fi](#).

Manage roaming options and choose other cellular data options

To turn Cellular Data on or off, go to Settings  [ALT N/A] > Cellular, then tap Cellular Data.

To set options when Cellular Data is on, go to Settings > Cellular > Cellular Data Options, then do any of the following:

- **Turn Data Roaming on or off:** Data Roaming permits internet access over a cellular data network when you're in a region not covered by your carrier's network. When you're traveling, you can turn off Data Roaming to avoid roaming charges.
- **Reduce cellular usage:** Tap Data Mode, then choose Low Data Mode. This mode pauses automatic updates and background tasks when iPhone isn't connected to Wi-Fi.

Depending on your iPhone model, carrier, and region, the following options may be available:

- *Turn Voice Roaming on or off: (CDMA)* Turn Voice Roaming off to avoid charges from using other carrier's networks. When your carrier's network isn't available, iPhone won't have cellular (data or voice) service.
- *Enable or disable 4G/LTE:* Using 4G or LTE loads internet data faster in some cases but may decrease battery performance. There may be options for turning off 4G/LTE or for selecting Voice & Data (VoLTE) or Data Only.

On iPhone 12 models and later with a 5G data plan, you can do the following:

- *Enable Smart Data mode to optimize battery life:* Tap Voice & Data, then choose 5G Auto. In this mode, your iPhone automatically switches to LTE when 5G speeds don't provide noticeably better performance.
- *Use higher-quality video and FaceTime HD on 5G networks:* Tap Data Mode, then choose Allow More Data on 5G.
- *Turn off 5G:* Tap Voice & Data, then choose LTE.

To set up a Personal Hotspot to share your internet connection, see [Share your internet connection from your iPhone with Personal Hotspot](#).

View how much data you're using

To see how much cellular data you've used, go to Settings  [ALT N/A] > Cellular, then do any of the following:

- *See cellular data usage for individual apps:* Scroll down to your list of apps, then tap Show All. The amount of cellular data used appears below each app. If you don't want an app to use cellular data, you can turn it off for that app. When cellular data is off, apps use only Wi-Fi for data.
- *See cellular data usage for individual system services:* System Services appears above the list of apps in the cellular section. Cellular data can't be turned on or off for individual system services.

You can view the data-usage statistics for an app from a current period, or view data statistics for apps that used data when you were roaming. To reset these statistics, go to Settings > Cellular, scroll to the bottom, then tap Reset Statistics.

If you're using an iPhone with Dual SIM, you can see how much cellular data you've used with your selected cellular data number.

Note: To get the most accurate cellular data usage from a current period, contact your carrier.

Set cellular data usage for apps and services

Go to Settings  [ALT N/A] > Cellular, then turn Cellular Data on or off for any app (such as Maps) or service (such as Wi-Fi Assist) that can use cellular data.

If a setting is off, iPhone uses only Wi-Fi for that service.

Note: Wi-Fi Assist is on by default. If Wi-Fi connectivity is poor, Wi-Fi Assist automatically switches to cellular data to boost the signal. Because you stay connected to the internet over cellular when you have a poor Wi-Fi connection, you might use more cellular data, which may incur additional charges depending on your data plan. See the Apple Support article [About Wi-Fi Assist](#).

Lock your SIM card

If your device uses a SIM card for phone calls or cellular data, you can lock the card with a personal identification number (PIN) to prevent others from using the card. Then, every time you restart your device or remove the SIM card, your card locks automatically, and you're required to enter your PIN. See [Use a SIM PIN for your iPhone or iPad](#).

To add an eSIM, see [Set up cellular service](#).

Related

[Set up cellular service on iPhone](#)

NAV TITLE: [Travel with iPhone](#)

Choose iPhone settings for travel

Metadata

Summary: When you travel with iPhone, choose settings that comply with airline requirements.

When you travel with iPhone, choose settings that comply with airline requirements. Some airlines let you keep your iPhone turned on if you switch to airplane mode. By default, Wi-Fi and Bluetooth® are disabled in airplane mode—you can't make calls, but you can listen to music, play games, watch videos, and use other apps that don't require network or phone connections.



To choose settings that minimize cellular charges when you travel, see [View or change cellular data settings on iPhone](#).

Turn on airplane mode

[Open Control Center](#), then tap  [Alt text: the Airplane Mode Switch button] .





[Alt text: The Control Center screen showing that tapping the top-left button turns on airplane mode.]

You can also turn airplane mode on or off in Settings  [ALT N/A] . When airplane mode is on, the Airplane Mode icon  [ALT N/A] appears in the status bar.

Turn on Wi-Fi or Bluetooth while in airplane mode

If your airline allows it, you can use Wi-Fi or Bluetooth while in airplane mode.

1. [Open Control Center](#), then turn on airplane mode.
2. Tap  [Alt text: the Wi-Fi Switch button] to turn on Wi-Fi or  [Alt text: the Bluetooth Switch button] to turn on Bluetooth.



[Alt text: Control Center with airplane mode on, showing that Wi-Fi and Bluetooth are off. The buttons for turning on Wi-Fi and Bluetooth are near the upper-left corner of Control Center.]

If you turn on Wi-Fi or Bluetooth while in airplane mode, it may be on the next time you return to airplane mode. You can turn it off again in Control Center.



Tap to turn off Bluetooth in airplane mode.

Tap to turn off Wi-Fi in airplane mode.

[Alt text: The iPhone Control Center. In the top-left group of controls are the Airplane mode button (top left), Wi-Fi button (bottom left), and the Bluetooth button (bottom-right). Airplane mode, Wi-Fi, and Bluetooth are all turned on. Tap the Bluetooth button to turn off Bluetooth in Airplane Mode. Tap the Wi-Fi button to turn off Wi-Fi in airplane mode.]

Related

[Use and customize Control Center on iPhone](#)

Personalize your iPhone

NAV TITLE: [Change sounds and vibrations](#)

Change iPhone sounds and vibrations

Metadata

Summary: In Settings, change the sounds and vibrations iPhone plays when you get a call, text message, email, reminder, or other type of notification.

You can change the sounds iPhone plays when you get a call, text, voicemail, email, reminder, or other type of notification.

Haptic feedback is the vibration you feel on [supported models](#) when you perform some actions, such as when you touch and hold any icon on the Home Screen.

Set sound and vibration options

1. Go to Settings  [ALT N/A] > Sounds & Haptics.
2. To set the volume for all sounds, drag the slider below Ringtone and Alerts.
3. Tap Haptics, then choose the haptics behavior for ringtones and alerts—Always Play, Play in Silent Mode, Don't Play in Silent Mode, or Never Play.

4. Tap Ringtone or Text Tone.

5. At the top of the Ringtone or Text Tone screen, tap Haptics, then do any of the following:

- Choose a tone (scroll to see them all).

Ringtones play for incoming calls, clock alarms, and the clock timer; text tones are used for text messages, new voicemail, and other alerts.

- Choose a vibration pattern or tap Create New Vibration to create your own.

You can also change the sounds iPhone plays for certain people. Go to Contacts  [ALT N/A], tap a person's name, tap Edit, then choose a ringtone and text tone.

Turn haptic feedback off or on

1. On [supported models](#), go to Settings  [ALT N/A] > Sounds & Haptics.
2. Turn System Haptics off or on.

When System Haptics is off, you won't hear or feel vibrations for incoming calls and alerts.

Have iPhone play a sound effect when it's turned on and off

On iPhone 14 or later, you can have iPhone play a sound when it's turned on and off.

1. Go to Settings  [ALT N/A] > Accessibility > Audio & Visual.
2. Turn on Power On & Off Sounds.

Tip: If you're not receiving incoming calls and alerts when you expect them, [open Control Center](#), then check whether Do Not Disturb is on. If the Do Not Disturb button  [ALT N/A] is highlighted, tap it to turn off Do Not Disturb. (When Do Not Disturb is on, its icon also appears in the status bar.)

Related

[Adjust the volume on iPhone](#)

NAV TITLE: [Use and customize the Action button](#)

Use and customize the Action button on iPhone

Metadata

Summary: On supported iPhone models, select a function for the Action button, including Silent mode, Camera, Focus, and more.

On [supported models](#), iPhone has an Action button in place of the Ring/Silent switch. You can choose which function you want the Action button to perform when you press it. Because the button is so accessible, it's useful for actions you perform often. (The location of the Action button is shown below.) It's easy to change the Action button to perform a different function.



[Alt text: A screen showing that the Action button is located on the left edge of the iPhone 15 Pro. You can customize the function of the button in Settings > Action Button.]

Customize the Action button

1. On [supported models](#), go to Settings  [ALT N/A] > Action Button.

An image of the side of the iPhone appears with icons representing actions you can assign to the Action button.



[Alt text: The screen for customizing the Action button. The Camera is the selected action. Other features appear to the right and left of the camera, including Do Not Disturb and Flashlight. Below the actions are dots you can tap to switch to another action. Below the selected action, Camera, is a menu of Camera options you can tap to assign to the Action button.]

2. To choose an action, swipe to the action you want to use—its name appears below the dots.

Tip: To customize the Action button to put iPhone in Silent mode, swipe to  [Alt text: the Silent Mode button]. To choose another action, swipe to it.

3. If there are additional options for the selected action,  [Alt text: the Menu button] appears below the action; tap it to see the list of options.

For the Controls, Shortcut, and Accessibility actions, you need to tap the button below the action and select a specific option—otherwise the Action button does nothing.

(table aria-label=Action button actions)

Icon	Action
	<i>Silent Mode:</i> Switch between Silent and Ring for calls and alerts.

[Alt text: the Silent Mode button]



[Alt text: the Focus button]

Focus: Turn on a Focus to silence notifications and filter out distractions.



[Alt text: the Camera button]

Camera: Open the Camera app to capture a moment.



[Alt text: the Flashlight button]

Flashlight: Turn on extra light when you need it.



[Alt text: the Voice Memo button]

Voice Memo: Record personal notes, musical ideas, and more.



[Alt text: the Recognize Music button]

Recognize Music: Find out what song is playing nearby or on your iPhone with Shazam.



[Alt text: the Translate button]

Translate: Translate phrases or have a conversation with someone in another language.



[Alt text: the Magnifier button]

Magnifier: Turn your iPhone into a magnifying glass to zoom in on and detect objects near you.



[Alt text: the Controls button]

Controls: Quickly access your favorite control.



[Alt text: the Shortcut button]

Shortcut: Open an app or run your favorite shortcut.

Accessibility: Quickly use an accessibility feature.



[Alt text: the Accessibility button]

No Action

Do nothing.

Use the Action button

To perform the action assigned to the Action button, press and hold the Action button.

For many functions, the Action button can be used to turn a setting on or off. For example, if the selected action is Silent Mode, you can press and hold the Action button to put iPhone in Silent mode  [ALT N/A] . If you press and hold the Action button again, it turns off Silent mode.

Add a control to the Action button

You can assign a Control Center control to the Action button, and then turn the control on or off just by using the Action button.

1. Go to Settings  [ALT N/A] > Action Button.
2. Swipe to the Controls action, then tap Choose a Control.
3. Scroll through the controls or search for the control you want by entering it in the search field above the controls.
4. Tap the control you want to add.

For example, you can assign Dark Mode to the Action button by tapping  [Alt text: the Dark Mode control] . Then you can turn Dark Mode on or off by pressing and holding the Action button.

Related

[Silence iPhone](#)

[Adjust the screen brightness and color on iPhone](#)

NAV TITLE: [Create a custom Lock Screen](#)

Create a custom iPhone Lock Screen

Metadata

Summary: Make your iPhone Lock Screen more personal and helpful by adding a picture, widgets, and colors, changing the clock style, and more.

You can personalize your Lock Screen by choosing a wallpaper, showcasing a favorite photo, changing the font of the time, adding widgets, and more.

You can create more than one Lock Screen, [switch between Lock Screens](#), and even link a Lock Screen to a Focus. So, for example, you could set a specific Lock Screen for when you're working.

Personalize a new Lock Screen

1. Press the side button on your iPhone twice to go to the Lock Screen.
2. Touch and hold the Lock Screen until the Customize and  [Alt text: the Add New button] buttons appear at the bottom of the screen.

If they don't appear, touch and hold the Lock Screen again, then enter your passcode.
3. Tap  [Alt text: the Add New button] to create a new Lock Screen, or to make changes to a Lock Screen, swipe to the screen you want to change, tap Customize, then tap Lock Screen.

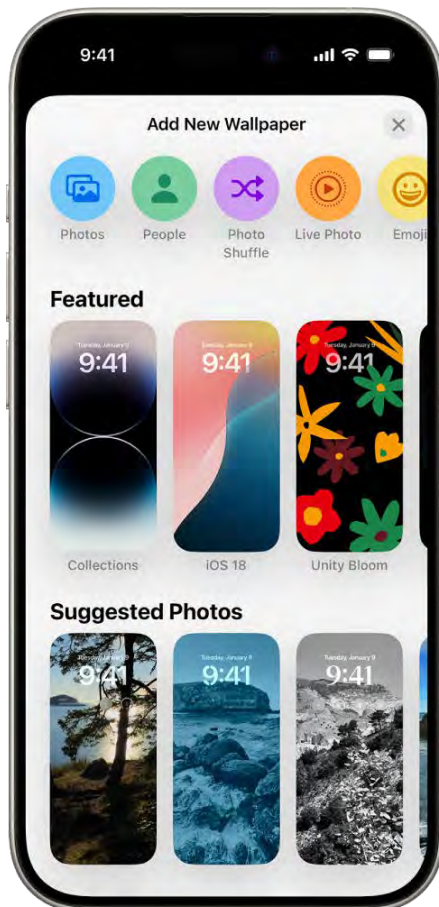

[Alt text: The Add New Wallpaper screen showing a gallery of wallpaper choices for customizing the iPhone Lock Screen, in categories such as Featured and Suggested Photos. At the top are buttons for adding photos, people, a photo shuffle, emoji, and a weather screen background to the Lock Screen.]

4. If you're creating a new Lock Screen, tap one of the wallpaper options to select it as your Lock Screen.

If you choose Photos or Photo Shuffle, see [Customize your Lock Screen photo](#).

5. Tap the time to change the font, color, and style. (See [Change the clock style on the Lock Screen](#))
6. To add widgets that include information such as today's headlines, the weather, and calendar events, tap Add Widgets, the date, or the field below the time. (See [Add, edit, and remove widgets](#).)

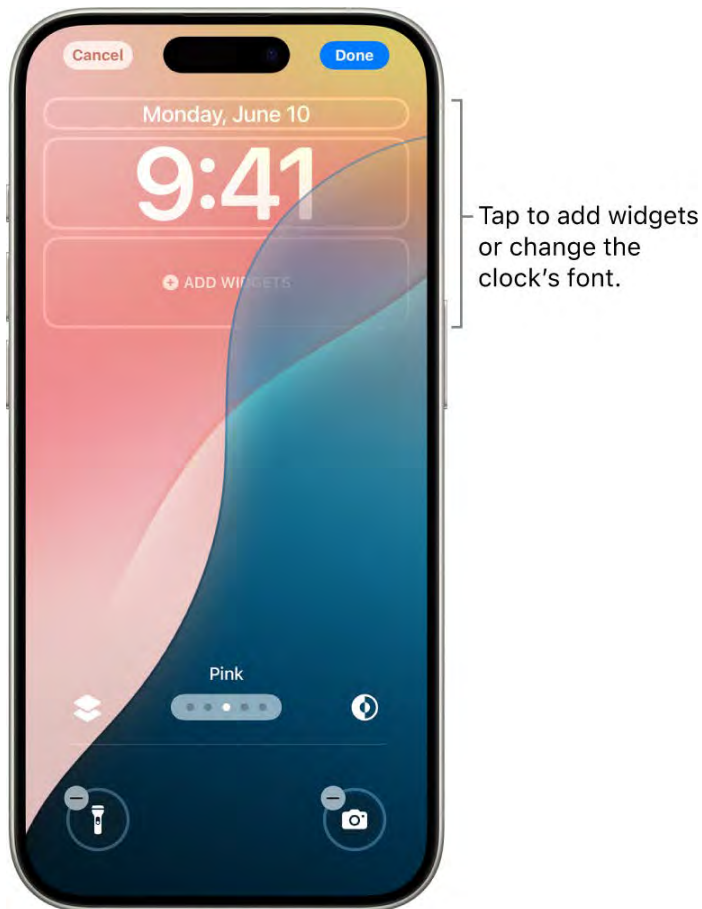

[Alt text: A custom Lock Screen in the process of being edited. Elements available for customization are selected—the date, the time, and a button for adding widgets.]

7. Tap Add or Done, then do one of the following:
 - *Choose whether to use the wallpaper on both the Lock Screen and the Home Screen:* Tap Set as Wallpaper Pair.

- *Make further changes to the Home Screen:* Tap Customize Home Screen. Tap a color to change the wallpaper color, tap  [Alt text: the Photo On Rectangle button] to use a custom photo, or select Blur to blur the wallpaper so the apps stand out.

Change the clock style on the Lock Screen

You can change the font and color of the clock on your Lock Screen.

1. Press the side button on your iPhone twice to go to the Lock Screen.
2. Touch and hold the Lock Screen until the Customize and  [Alt text: the Add New button] buttons appear at the bottom of the screen.

If they don't appear, touch and hold the Lock Screen again, then enter your passcode.
3. Swipe to go to the Lock Screen you want to change, tap Customize, then tap the Lock Screen image.
4. Tap the time, then choose a font and color.

Drag the slider to make the font heavier or lighter (available for solid fonts).



[Alt text: A screen for editing the style of the clock on the Lock Screen, showing the time selected, and the

popup for choosing a font style, line weight, and font color for the clock.]

To change the date and time setting, see [Change the date and time on iPhone](#).

Change the controls at the bottom of the Lock Screen

You can swap out the controls at the bottom of the Lock Screen for other options, like the Calculator when you're shopping or the Translate app when you're traveling. You can also remove these controls entirely or have different controls on different Lock Screens.

Tip: You can customize the controls at the bottom of a Lock Screen, then [link a specific Focus to that Lock Screen](#) that makes use of those controls.

1. Press the side button on your iPhone twice to go to the Lock Screen.
2. Touch and hold the Lock Screen until the Customize and  (Alt text: the Add New button) buttons appear at the bottom of the screen.



If they don't appear, touch and hold the Lock Screen again, then enter your passcode.

3. Tap Customize, then tap Lock Screen.



[Alt text: The screen for customizing the iPhone Lock Screen. The editable items are selected (date, time,

and Add Widget field), along with the buttons at the bottom of the screen. The bottom buttons have a Remove Widget button at the top left for removing the control before adding a new one from Control Center.

4. Tap  [Alt text: the Remove button] on one of the controls at the bottom of the screen, then tap  [Alt text: the Add Quick Action button] .

The controls gallery opens.



[Alt text: The controls gallery, showing all the optional controls that can be added to Control Center groups and the bottom of the Lock Screen.]

5. Tap a control in the controls gallery to replace the selected one on your Lock Screen.
6. When you finish customizing the controls at the bottom of the Lock Screen, tap Done at the top of the screen, then tap the Lock Screen.



Customize your Lock Screen photo



If you choose a photo for your Lock Screen, you can reposition the photo, change the photo style, and more.

Do any of the following:

- *Reposition your photo:* To reposition your selected image, pinch open to zoom in on it, drag the image with two fingers to move it, then pinch closed to zoom out.
- *Change the photo style:* Swipe left or right to try different photo styles with complementary color filters and fonts.
- *Create a multilayered effect:* If you have a photo that supports layering—like an image with people, pets, or the sky—tap  [Alt text: the More button] at the bottom right, then choose Depth Effect.

Note: The multilayered effect is available on [supported models](#). Layering may not be available if the subject is too high or too low, or if it obscures too much of the clock.

- *Create a motion effect with a Live Photo:* If you select a Live Photo that can be translated into slow motion, tap  [Alt text: the Play button] at the bottom left to play the Live Photo when the device wakes up.
- *Set the shuffle frequency:* If you choose Photo Shuffle, you can preview the photos by tapping  [Alt text: the Browse button], and you can set the shuffle frequency by tapping  [Alt text: the More button] and then selecting an option below Shuffle Frequency.

Tip: Alternatively, you can add a photo directly from your photo library to your Home Screen and Lock Screen. In the Photos app  [ALT N/A], tap Library, select a photo, then tap  [Alt text: the Share button]. Scroll down and select Use as Wallpaper, tap Add, then choose whether to show it on both your Home Screen and Lock Screen.

Link a Focus to your Lock Screen

Focus helps you concentrate on a task by minimizing distractions. You can set up a Focus to temporarily silence all notifications, or to allow only specific notifications (ones that apply to your task, for example). By linking a Focus to your Lock Screen, your Focus settings apply whenever you use that particular Lock Screen.

1. Press the side button on your iPhone twice to go to the Lock Screen.
2. Touch and hold the Lock Screen until the Customize button appears at the bottom of the screen.
3. Tap Focus near the bottom of the wallpaper to see the Focus options—for example, Do Not Disturb, Personal, Sleep, and Work.

Note: If you don't see Focus near the bottom of the wallpaper, go to Settings  [ALT N/A] > Focus and [set up a Focus](#).

4. Select a Focus, then tap  [Alt text: the Close button].

Edit or change your Lock Screen

After you create a custom Lock Screen, you can make changes to it.

1. Press the side button on your iPhone twice to go to the Lock Screen.
 2. Touch and hold the Lock Screen until the Customize button appears at the bottom of the screen.
- If it doesn't appear, touch and hold the Lock Screen again, then enter your passcode.
3. Swipe to the screen you want to change, tap Customize, then tap Lock Screen.
 4. Do any of the following:

- *Change the font, color, and style of the clock:* Tap the time.
- *Add widgets that include today's headlines, the weather, and calendar events:* Tap Add Widgets, the date, or the field below the time. (See [Add, edit, and remove widgets.](#))
- *Change the wallpaper:* Tap Done, tap  [Alt text: the Add New button], choose a wallpaper, tap Add, then tap Set as Wallpaper Pair or Customize Home Screen.

Switch between Lock Screens

You can create multiple custom Lock Screens and switch between them throughout the day.

1. Press the side button on your iPhone twice to go to the Lock Screen.
2. Touch and hold the Lock Screen until the Customize button appears at the bottom of the screen.
3. Swipe to the Lock Screen you want to use, then tap it.

Note: If a Lock Screen links to a specific Focus, switching from that Lock Screen to another also switches your Focus. See [Link a Focus to your Lock Screen.](#)

Delete a Lock Screen

You can delete Lock Screens you no longer need.

1. Press the side button on your iPhone twice to go to the Lock Screen.
2. Touch and hold the Lock Screen until the Customize button appears at the bottom of the screen.
3. Swipe to go to the Lock Screen you want to delete, swipe up on the screen, tap  [Alt text: the Trash button], then tap Delete This Wallpaper.

Related

[Keep the iPhone display on longer](#)

[Change the wallpaper on iPhone](#)

NAV TITLE: [Change the wallpaper](#)

Change the wallpaper on iPhone

Metadata

Summary: On iPhone, choose an image or photo as wallpaper for the Lock Screen or Home Screen.

On iPhone, you can change the wallpaper on the Lock Screen and the Home Screen. You can set your wallpaper in Settings or through the wallpaper gallery from your Lock Screen. See [Create a custom iPhone Lock Screen](#).

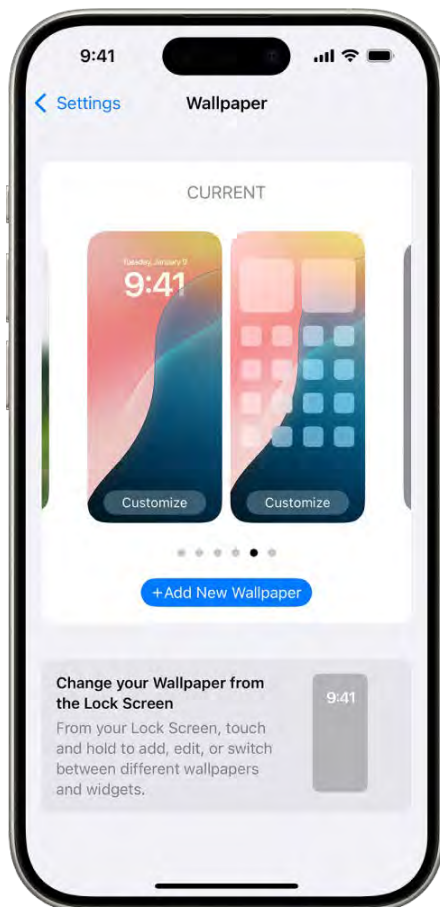

[Alt text: The Wallpaper Settings screen, with buttons for customizing the current wallpaper on the Home Screen and Lock Screen, and the Add New Wallpaper button for changing the wallpaper.]

1. Go to Settings  [ALT N/A] > Wallpaper, then tap Add New Wallpaper.

The wallpaper gallery appears.

2. Do any of the following:

- Tap a button at the top of the wallpaper gallery—for example, Photos, Photo Shuffle, Live Photo, and so on—to design your wallpaper with a photo, an emoji pattern, a picture of your local weather, and more.
 - Choose wallpaper from one of the featured sets (Collections, Astronomy, Weather, and so on).
3. If you're adding a Photo or Photo Shuffle to your wallpaper and want to customize one or more photos for it, see [Customize your Lock Screen photo](#).
 4. Tap Add, then do one of the following:
 - *Choose whether to use the wallpaper on both the Lock Screen and Home Screen:* Tap Set as Wallpaper Pair.
 - *Make further changes to the Home Screen:* Tap Customize Home Screen. Tap a color to change the wallpaper color, tap  [Alt text: the Photo On Rectangle button] to use a custom photo, or select Blur to blur the wallpaper so the apps stand out.

Related

[Create a custom iPhone Lock Screen](#)

NAV TITLE: [Adjust the screen brightness and color balance](#)

Adjust the screen brightness and color on iPhone

Metadata

Summary: On iPhone, dim the screen to extend battery life; use Night Shift, True Tone, and Dark Mode to adjust the screen for your lighting conditions.

On iPhone, you can make your screen dimmer or brighter (dimming the screen extends battery life). You can also adjust the screen brightness and color manually or automatically with Dark Mode, True Tone, and Night Shift.

Adjust the screen brightness manually

To make your iPhone screen dimmer or brighter, do one of the following:

- [Open Control Center](#), then drag  [Alt text: the Brightness button] up or down.
- Go to Settings  [ALT N/A] > Display & Brightness, then drag the slider.

Adjust the screen brightness automatically



iPhone adjusts the screen brightness for current light conditions using the built-in ambient light sensor.

1. Go to Settings  [ALT N/A] > Accessibility.
2. Tap Display & Text Size, then turn on Auto-Brightness.

Turn Dark Mode on or off

Dark Mode gives the entire iPhone experience a dark color scheme that's perfect for low-light environments. With Dark Mode on, you can use your iPhone while, for example, reading in bed, without disturbing the person next to you.

Do any of the following:

- [Open Control Center](#), touch and hold  [Alt text: the Brightness button], then tap  [Alt text: the Appearance button] to turn Dark Mode on or off.
- Go to Settings  [ALT N/A] > Display & Brightness, then select Dark to turn on Dark Mode, or select Light to turn it off.



[Alt text: The iPhone Home Screen with Dark Mode on.]

Schedule Dark Mode to turn on and off automatically

You can set Dark Mode to turn on automatically at night (or on a custom schedule).

1. Go to Settings  [ALT N/A] > Display & Brightness.
2. Turn on Automatic, then tap Options.
3. Select either Sunset to Sunrise or Custom Schedule.

If you choose Custom Schedule, tap the options to schedule the times you want Dark Mode to turn on and off.

If you select Sunset to Sunrise, iPhone uses the data from your clock and geolocation to determine when it's nighttime for you.

Turn Night Shift on or off

You can turn on Night Shift manually, which is helpful when you're in a darkened room during the day.

[Open Control Center](#), touch and hold  [Alt text: the Brightness button], then tap  [Alt text: the Night Shift button].

Schedule Night Shift to turn on and off automatically

Schedule Night Shift to shift the colors in your display to the warmer end of the spectrum at night and make viewing the screen easier on your eyes.

1. Go to Settings  [ALT N/A] > Display & Brightness > Night Shift.
2. Turn on Scheduled.
3. To adjust the color balance for Night Shift, drag the slider below Color Temperature toward the warmer or cooler end of the spectrum.
4. Tap From, then select either Sunset to Sunrise or Custom Schedule.

If you choose Custom Schedule, tap the options to schedule the times you want Night Shift to turn on and off.

If you select Sunset to Sunrise, iPhone uses the data from your clock and geolocation to determine when it's nighttime for you.

Note: The Sunset to Sunrise option isn't available if you turned off Location Services in Settings  [ALT N/A] > Privacy & Security, or if you turned off Setting Time Zone in Settings > Privacy & Security > Location Services > System Services.

Turn True Tone on or off

On [supported models](#), True Tone automatically adapts the color and intensity of the display to match the light in your environment.

Do any of the following:

- [Open Control Center](#), touch and hold  [Alt text: the Brightness button], then tap  [Alt text: the True Tone button] to turn True Tone on or off.

- Go to Settings  [ALT N/A] > Display & Brightness, then turn True Tone on or off.

Related

[Use and customize Control Center on iPhone](#)

Keep the iPhone display on longer

Metadata

Summary: On iPhone, you can set the display to stay on longer.

The iPhone display stays on while you're looking at it, but it dims and eventually locks (for your security) when you look away for a while. If you need the display to stay on longer (for example, when you're navigating with Maps), you can change how long it takes iPhone to automatically dim and lock.

Change when iPhone automatically locks

You can set how long it takes iPhone to automatically lock.

Go to Settings  [ALT N/A] > Display & Brightness > Auto-Lock, then choose a length of time.

Keep your Lock Screen visible with Always-On display

On [supported models](#), the Always-On display setting allows a dimmed version of your Lock Screen to stay visible, even when your iPhone is locked. By glancing at the dimmed screen, you can check essential information, like notifications, the date and time, and information in your widgets.

The display automatically turns off when iPhone is either face down or obstructed from view, not near a paired Apple Watch, when a CarPlay session begins, while Continuity Camera is in use, while [Low Power Mode](#) is on, while [Sleep Focus](#) is on, or at your usual bedtime.

The Always-On display setting is on by default. To turn it off, go to Settings  [ALT N/A] > Display & Brightness, then turn off Always On Display.

Tip: When Always-On display is turned on, you can choose whether to show your wallpaper or notifications on your Lock Screen. In Settings > Display & Brightness > Always On Display, turn Show Wallpaper or Show Notifications on or off.

Related

[Use StandBy to view information at a distance while iPhone is charging](#)

[Create a custom iPhone Lock Screen](#)

[Set a passcode on iPhone](#)

NAV TITLE: [Use StandBy](#)

Use StandBy to view information at a distance while iPhone is charging

Metadata

Summary: Display your favorite photos, clock, Live Activities, and more while your iPhone is charging.

You can use StandBy to turn your iPhone into a bedside clock, a photo frame, a display for viewing widgets or Live Activities in full screen, and more.



[Alt text: An iPhone in StandBy, charging and standing on its side, with a digital clock showing on the screen.]

Start StandBy

1. Go to Settings  [ALT N/A] > StandBy and make sure StandBy is turned on.
2. Connect iPhone to a charger and set it down on its side, keeping it stationary.
3. Press the side button.
4. Swipe left or right to switch between widgets, photos, and clocks. Swipe up or down to scroll between options for each of these views.

When Night Mode is turned on for StandBy, the screen adapts to low ambient light at night and displays items with a red tint so that it's not intrusive while you're sleeping.



[Alt text: iPhone in Standby mode in low ambient light, displaying Clock and Calendar widgets with a red tint.]

With the Always-On display (on [supported models](#)), StandBy stays on to show useful information. For all other iPhone models, it's easy to activate StandBy any time by either tapping the screen, gently nudging the table your iPhone is on, or using Siri.

In each location where you charge iPhone with MagSafe, StandBy remembers your preferred view, whether that's a clock, photos, or widgets. For example, you can have it set up for family photos in the kitchen or an alarm clock at your bedside.

Set display preferences for when StandBy is on

You can choose how long to have your iPhone display stay on when StandBy is on.

1. Go to Settings  [ALT N/A] > StandBy > Display.
2. Choose one of the following:
 - *Automatically*: The display turns off when iPhone isn't in use and the room is dark.
 - *After 20 Seconds*: The display turns off after 20 seconds.
 - *Never*: The display stays on as long as StandBy is on.

Related

[Keep your Lock Screen visible with Always-On display](#)
[Add, edit, and remove widgets on iPhone](#)

NAV TITLE: [Customize the text size and zoom setting](#)

Customize the text size and zoom setting on iPhone

Metadata

Summary: On iPhone, customize the text size and zoom setting to magnify the screen.

You can increase the size of the text on your iPhone display, make the text bold, and magnify the screen with Display Zoom.

Increase the text size on iPhone

1. Go to Settings  [ALT N/A] > Display & Brightness.
2. Tap Text Size.
3. Drag the slider left or right to change the text size.

Make the text bold on iPhone

1. Go to Settings  [ALT N/A] > Display & Brightness.
2. Turn on Bold Text.

Magnify the entire iPhone screen

On [supported models](#), you can magnify the iPhone screen with Display Zoom.

1. Go to Settings  [ALT N/A] > Display & Brightness.
2. Tap Display Zoom, then tap Larger Text.
3. Tap Done, then tap Use Zoomed.

Related

[Zoom in on the iPhone screen](#)



[Make text easier to read on iPhone](#)

Change the name of your iPhone

Metadata

Summary: You can change the name of your iPhone, which is used by iCloud, AirDrop, Bluetooth, and your computer.

You can change the name of your iPhone, which is used by iCloud, AirDrop, Bluetooth®, your Personal Hotspot, and your computer.

1. Go to Settings  [ALT N/A] > General > About > Name.
2. Tap  [Alt text: the Clear Text button], enter a new name, then tap Done.

Related

[Use AirDrop on iPhone to send items to nearby Apple devices](#)

NAV TITLE: [Change the date and time](#)

Change the date and time on iPhone

Metadata

Summary: The date and time, visible on the iPhone Lock Screen, are set automatically based on your location, but you can change it manually.

The time zone on your iPhone is set automatically, but if you don't have Location Services turned on or you don't have service, you might want to change it manually.

1. Go to Settings  [ALT N/A] .
2. Tap General, then tap Date & Time.
3. Turn off Set Automatically, then change the time zone.

To change the default date and time, turn off Set Automatically, then change the date and time displayed.

Tip: To change the font color and style of the clock on the Lock Screen, see [Change the clock style on the Lock Screen](#).

Related

[Change the language and region on iPhone](#)

NAV TITLE: [Change the language and region](#)

Change the language and region on iPhone

Metadata

Summary: You can change the language and region of your iPhone when you travel or move.

You choose the language and region of your iPhone during setup. If you travel or move, you can change the language or region.

1. Go to Settings  [ALT N/A] > General > Language & Region.

2. Set the following:

- The language for iPhone
- Your preferred form of address. (Choose feminine, masculine, or neutral. Turn on Share with All Apps so all apps personalize how they address you. Available for some primary languages—for example, Spanish.)
- The region
- The calendar format
- The temperature unit (Celsius or Fahrenheit)
- The measurement system (metric, US, or UK)
- The first day of the week
- Live Text (text you can select in images to copy or take action on)

3. To add another language and keyboard to your iPhone, tap Add Language, then select a language.

Related

[Add or change keyboards on iPhone](#)

Customize your Home Screen

NAV TITLE: [Add, edit, and remove widgets](#)

Add, edit, and remove widgets on iPhone

Metadata

Summary: Add widgets to the iPhone Home Screen to see today's headlines, weather, calendar events, and more at a glance.



[Alt text: Weather, Reminders, and Home widgets on the iPhone Home Screen. The Reminders and Home widgets display interactive features.]

What are widgets?

Widgets give you an easy way to view current information at a glance—today’s headlines, weather, reminders, battery levels, and more. You can view widgets in Today View and add them to your Home Screen or Lock Screen to keep this information at your fingertips.

You can interact with widgets on the Home Screen or Lock Screen without opening the app—you can take action on the widgets for Music, Podcasts, Safari, Home, Contacts, and more. For example, tap  [Alt text: the Play button] on the Music or Podcasts widget to play a selection.

Tip: A Smart Stack (with dots next to it) is a combined set of widgets that uses information such as the time, your location, and activity to automatically display the most relevant widget at the appropriate time in your day. You can add a Smart Stack from the widget gallery to the Home Screen, then swipe up and down through it to see the widgets it contains.

Add a widget to your Home Screen

1. [Go to the Home Screen.](#)

2. Find the Home Screen page where you want to add the widget, then touch and hold the Home Screen background until the apps begin to jiggle.
3. Tap Edit at the top of the screen, then tap Add Widget to open the widget gallery.
4. Scroll or search to find a widget, tap it, then swipe through the size options.
The different sizes display different information.
5. When you see the size you want, tap Add Widget.
6. While the apps are still jiggling, move the widget where you want it on the screen, then tap Done.

To learn how to add a widget to your Lock Screen, see [Personalize a new Lock Screen](#).

Interact with widgets

You can perform tasks by tapping widgets on your Home Screen, Lock Screen, or [StandBy](#). Tap an item in the Reminders widget to check it off, tap the Play button in the Podcasts widget to play an episode, or tap the Home widget to turn on your living room lights—all without opening an app.

Edit a widget on your Home Screen

You can customize most widgets right from your Home Screen so they display the information you want to see. For example, for a Mail widget, you can tap the mailbox shown in the widget, then choose a different mailbox so the messages in that mailbox are displayed in the widget. Or you can customize a Smart Stack to rotate through its widgets based on your activity, your location, the time of day, and so on.

1. [Go to the Home Screen](#).
2. Touch and hold a widget to open the [quick actions menu](#).
3. Tap Edit Widget (or Edit Stack, if it's a Smart Stack), then choose options.

For a Smart Stack, you can turn Smart Rotate or Widget Suggestions (below the widget) off or on, reorder widgets by dragging them within the stack, drag a widget from the Smart Stack to the Home Screen, or remove a widget by tapping  [Alt text: the Remove Widget button] in its upper-left corner.

When you turn on Widget Suggestions, widgets for apps you already use automatically appear in your Smart Stack at the right time based on your past activity. An option lets you add the widget to your stack so it's always there when you need it.



[Alt text: A screen showing editing a Smart Stack. It shows a widget with a Remove Widget button on the upper-left corner for removing the widget from the stack, a Smart Rotate button, and a Widget Suggestions button for adding widgets to the stack.]

4. Tap Done.

Remove a widget from the Home Screen

1. [Go to the Home Screen.](#)
2. Touch and hold the widget to open the [quick actions menu](#).
3. Do one of the following:
 - *Remove a widget:* Tap Remove Widget.
 - *Remove a Smart Stack:* Tap Remove Stack.

View widgets in Today View

To view widgets in Today View, swipe right from the left edge of the Home Screen, then scroll up and down.

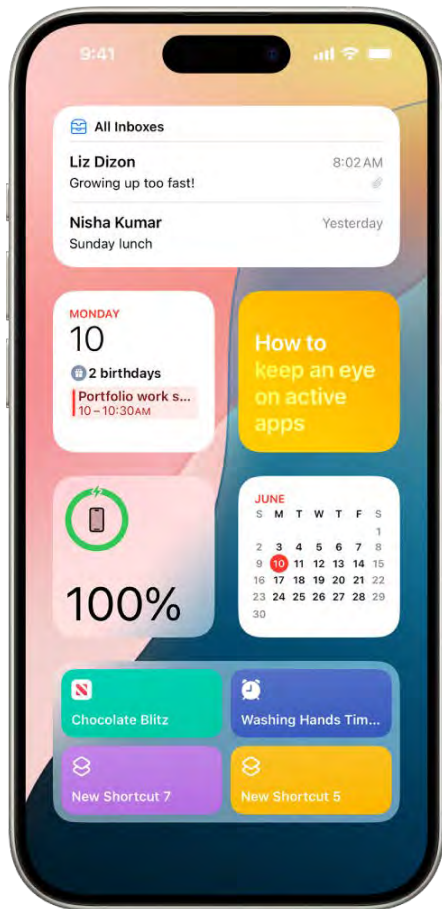

[Alt text: Widgets appearing in Today View, including the Reminders, Photos, Battery, Calendar, and Tips widgets and more.]

Note: If the widgets don't appear when you swipe right on the Home Screen, see the next task, [View widgets in Today View and Search when iPhone is locked](#).

View widgets in Today View and Search when iPhone is locked

1. Go to Settings  [ALT N/A] > Face ID & Passcode (on an iPhone with Face ID) or Touch ID & Passcode (on other iPhone models).
2. Enter your passcode.
3. Turn on Today View and Search (below Allow Access When Locked).

Related

[Create a custom iPhone Lock Screen](#)

[Move apps and widgets on the iPhone Home Screen](#)

NAV TITLE: [Move apps and widgets on the Home Screen](#)

Move apps and widgets on the iPhone Home Screen

Metadata

Summary: On iPhone, rearrange apps and widgets on the Home Screen, move them to other Home Screen pages, reset the original layout, and more.

You can move apps and widgets anywhere on the Home Screen to create the ideal layout—frame your wallpaper photo, align apps and widgets along the side or bottom, or drag them to other Home Screen pages. If you have multiple Home Screen pages, each one can have a unique layout. You can also temporarily hide Home Screen pages, change where new apps get downloaded, and more.

Tip: You can put all your apps and widgets related to a particular [Focus](#) (your Work Focus, for example) onto one Home Screen page, and make that page accessible during that Focus.

Move apps and widgets on your Home Screen

1. [Go to the Home Screen.](#)
2. Touch and hold the Home Screen background until the items begin to jiggle.
3. Drag the app or widget to one of the following locations:
 - Another location on the same page—including the top, bottom, or side of the screen
 - Another Home Screen page

Drag the app or widget to the right edge of the screen. You might need to wait a moment for the new page to appear. The dots above the Dock show how many pages you have and which one you're viewing.

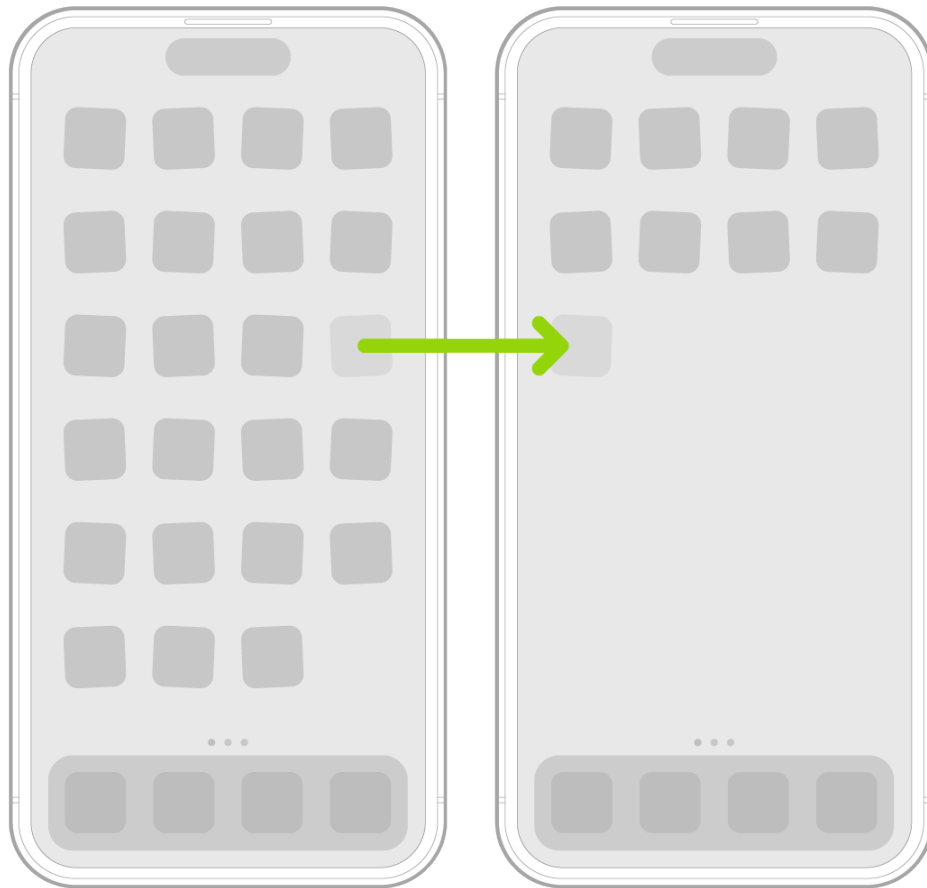

[Alt text] Jiggling apps on the Home Screen with an arrow showing one app being dragged to the next page.

4. When you're finished, press the Home button (on an iPhone with a Home button) or tap the Home Screen background (on other iPhone models).

To remove a widget, see [Remove a widget from the Home Screen](#).

Reset the Home Screen and apps to their original layout

1. Go to Settings  [ALT N/A] > General > Transfer or Reset iPhone.
2. Tap Reset, tap Reset Home Screen Layout, then tap Reset Home Screen.

Any folders you created are removed, and apps you downloaded are arranged alphabetically after apps that came with your iPhone.

Related

[Find and use your apps in App Library on iPhone](#)

[Organize your apps in folders on iPhone](#)

[Remove or delete apps from iPhone](#)

NAV TITLE: [Customize apps and widgets on the Home Screen](#)

Customize apps and widgets on the iPhone Home Screen

Metadata

Summary: On iPhone, change the color and size of the apps and widgets on your Home Screen.

You can customize app icons and widgets on the Home Screen by changing their color, adding a tint, making them larger or smaller, and removing the app name.



[Alt text: A customized Home Screen with icons tinted gold and arranged around the top and right side of the photo to frame the photo.]

1. [Go to the Home Screen.](#)
2. Touch and hold the Home Screen background until the icons begin to jiggle.
3. Tap Edit at the top of the screen, then choose Customize.

4. Do any of the following:

- *Make the icons and widgets bigger:* Tap Large. (In large size, the names of the apps and widgets disappear.)
- *Choose a dark or light appearance for icons and widgets:* Tap Dark or Light. To show icons and widgets with a dark appearance at night and a light appearance during the day, tap Automatic.
- *Add a color tint to your icons and widgets:* Tap Tinted. Use the sliders to choose the color and saturation. You can also use the eyedropper to select a color on your wallpaper for your icons.



Add a color tint to the icons.

[Alt text: A customized Home Screen with icons tinted blue and arranged to frame the photo, and controls at the bottom of the screen for customizing icons. Options include Automatic, Dark, Light, and Tinted buttons, sliders for choosing color and saturation, and Small and Large buttons for setting the icons' size.]

Related

[Add, edit, and remove widgets on iPhone](#)

Lock or hide an app on iPhone

Metadata

Summary: Lock or hide or an app on iPhone so that others can't see it or view the information in it.

Sometimes you may want to show someone something on your iPhone, but you want peace of mind that they can't get into certain apps. To prevent that, you can lock or hide an app. Locking an app requires Face ID, Touch ID, or your passcode to open it, and information inside a locked app won't appear in other locations on your device—for example, in notification previews, search, Siri suggestions, or your call history.

When you lock or hide an app on your device, it's only locked or hidden on that device. This status doesn't sync with iCloud.

Children under 13 in a Family Sharing group can't lock or hide apps. Anyone aged 13 to 17 in a Family Sharing group can lock or hide an app, but a parent/guardian in the family group can see that the app was downloaded and how much time it's used, and [restrict access to it](#) using Screen Time.

Note: These ages vary by country or region.

Lock an app

Locking an app requires Face ID, Touch ID, or your passcode to open the app.

Note: Some of the apps that came with your iPhone can't be locked—including Calculator, Camera, Clock, Contacts, Find My, Maps, Shortcuts, and Settings.

1. [Go to the Home Screen.](#)
2. Locate the app you want to lock.
3. Touch and hold the app icon until the [quick actions menu](#) opens.
4. Tap Require Face ID (or Touch ID or Passcode).
5. Tap Require Face ID (or Touch ID or Passcode) again, then authenticate using FaceID (or Touch ID or passcode).

Open an app that's locked

You can open and use an app that you locked.

1. [Go to the Home Screen.](#)
2. Locate the app you want to open.
3. Tap the app, then authenticate using your Face ID (or Touch ID or a passcode).

Unlock an app

You can unlock an app so you no longer need to use Face ID, Touch ID, or a passcode to open it.

1. [Go to the Home Screen.](#)
2. Locate the app you want to unlock.
3. Touch and hold the app icon until the [quick actions menu](#) opens.
4. Tap Don't Require Face ID (or Touch ID or Passcode), then authenticate using FaceID (or Touch ID or a passcode).

Hide an app

Hiding an app prevents others from seeing or opening it (unless they have a way to authenticate your iPhone using Face ID, Touch ID, or a passcode).

When you hide an app, its name is still visible in some places, such as Screen Time, Battery Health (in Settings), and your App Store purchase history.

Note: You can't hide any of the apps that come with iPhone—you can hide only third-party apps.

1. [Go to the Home Screen.](#)
2. Locate the app you want to hide.
3. Touch and hold the app icon until the [quick actions menu](#) opens.
4. Tap Require Face ID (or Touch ID or Passcode).
5. Tap Hide and Require Face ID (or Touch ID or Passcode), enter your Face ID (or Touch ID or passcode), then tap Hide App.

The app disappears from your Home Screen and moves to the Hidden folder at the bottom of App Library.

Tip: To view a list of all your hidden apps, go to Settings  [ALT N/A] > Apps > Hidden Apps, then authenticate using your Face ID (or Touch ID or passcode).

Open a hidden app

You can open and use an app that you've hidden.

1. [Go to the Home Screen.](#)
2. Swipe left past all your Home Screen pages to go to App Library.
3. Tap the Hidden folder at the bottom of App Library, then authenticate using Face ID (or Touch ID or passcode).

The app appears in the Hidden folder.

4. Tap the app, then authenticate using Face ID (or Touch ID or passcode).

Unhide an app

You can stop hiding an app so that you can see and use it.

1. [Go to the Home Screen.](#)
2. Swipe left past all your Home Screen pages to go to App Library.
3. Tap the Hidden folder at the bottom of App Library, then authenticate using Face ID (or Touch ID or Passcode).
4. To move the app out of the Hidden folder, touch and hold the app, tap Don't Require Face ID (or Touch ID or Passcode), then authenticate using Face ID (or Touch ID or passcode).

The app appears near the top of App Library.

Related

[Turn on Lock Screen features on iPhone](#)

NAV TITLE: [Organize your apps in folders](#)

Organize your apps in folders on iPhone

Metadata

Summary: On iPhone, create folders and organize your apps into folders to make them easier to find on your Home Screen.

You can organize your apps into folders to make them easier to find on your Home Screen pages.

Create a folder

1. [Go to the Home Screen.](#)
2. Touch and hold the Home Screen background until the apps begin to jiggle.
3. To create a folder, drag an app onto another app, then drag other apps into the folder.

A folder can contain multiple pages of apps.

4. To rename the folder, touch and hold it, tap Rename, then enter a new name.

If the apps begin to jiggle, tap the Home Screen background and try again.

5. When you're finished, tap Done, then tap the Home Screen background twice.

Note: Organizing your apps on the Home Screen doesn't affect the organization of apps in [App Library](#).

Delete a folder from your Home Screen

1. [Go to the Home Screen.](#)
2. Tap the folder to open it, then drag all the apps out of it onto the Home Screen background.

When it's empty, the folder is automatically deleted.

Move an app from a folder to the Home Screen

You can move an app from a folder to the Home Screen to make it easier to locate and open.

1. [Go to the Home Screen.](#)
2. Locate the folder that contains the app, then tap the folder to open it.
3. Touch and hold the app until the apps begin to jiggle.
4. Drag the app from the folder to the Home Screen.

Related

[Move apps and widgets on the iPhone Home Screen](#)

[Find your apps in App Library](#)

[Remove or delete apps from iPhone](#)

[Reset the Home Screen and apps to their original layout](#)

NAV TITLE: [Remove or delete apps](#)

Remove or delete apps from iPhone

Metadata

Summary: Remove or delete apps from your iPhone. If you change your mind, you can download the apps again later.

You can easily remove or delete apps from your iPhone. If you change your mind, you can download the apps again later (if they're still available in the App Store).

Do any of the following:

- *Remove an app from the Home Screen:* Touch and hold the app on the Home Screen, tap Remove App, then tap Remove from Home Screen to keep it in App Library, or tap Delete App to delete it from iPhone.
- *Delete an app from App Library and the Home Screen:* Touch and hold the app in App Library, tap Delete App, then tap Delete. (See [Find your apps in App Library.](#))

If you change your mind, you can [redownload apps](#) you remove.

In addition to removing third-party apps from the Home Screen, you can remove the following built-in Apple apps that came with your iPhone:

- P9 [Books](#)
P10 [Books](#)
- [Calculator](#)
- [Calendar](#)
- [Clock](#)
- [Compass](#)
- [Contacts](#) (Contact information remains available through Phone, Messages, Mail, FaceTime, and other apps. To remove a contact, you must restore Contacts.)
- [FaceTime](#) (If you remove the FaceTime app from your iPhone, you won't be able to make or receive FaceTime calls or use SharePlay on your iPhone unless you [redownload the app](#). See [Make FaceTime calls](#).)
- [Files](#)
- [Find My](#) (Removing this app doesn't turn off location sharing or Find My for your device or items—it just removes the ability to view locations in the Find My app on that device.)
- [Fitness](#)
- [Freeform](#)
- [Health](#)
- [Home](#)
- [iTunes Store](#)
- [Magnifier](#)
- [Mail](#)
- [Maps](#)
- [Measure](#)
- [Music](#)
- P9
[News](#)
- [Notes](#)
- [Podcasts](#)
- [Reminders](#)

- [Shortcuts](#)
- [Stocks](#)
- [Tips](#)
- [Translate](#)
- [P9 TV](#) [P10 Apple Video](#)
- [Voice Memos](#)
- [Wallet](#) (Removing this app doesn't delete cards and passes you stored in iCloud.)
- [Watch](#)
- [Weather](#)

Note: When you remove a built-in app from your Home Screen, you also remove any related user data and configuration files. Removing built-in apps from your Home Screen can also affect other system functionality.

NAV TITLE: [Use and customize Control Center](#)

Use and customize Control Center on iPhone

Metadata

Summary: Open the iPhone Control Center to access useful controls. You can customize Control Center by adding controls.

Control Center on iPhone gives you instant access to useful controls—including airplane mode, Do Not Disturb, flashlight, volume, screen brightness, and more.

Open Control Center

To open Control Center, do one of the following:

- *On an iPhone with Face ID:* Swipe down from the top-right corner of the screen.

You can jump to specific groups of controls by swiping down through the icons on the right edge of the screen. Swipe up through the icons to go back to the first group.